

DECORATED CORELATIONS

BRENDAN FONG

ABSTRACT. Let \mathcal{C} be a category with finite colimits, and let $(\mathcal{E}, \mathcal{M})$ be a factorisation system on \mathcal{C} with \mathcal{M} stable under pushouts. Writing $\mathcal{C}; \mathcal{M}^{\text{op}}$ for the symmetric monoidal category with morphisms cospans of the form $\xrightarrow{c} \overset{m}{\curvearrowright}$, where $c \in \mathcal{C}$ and $m \in \mathcal{M}$, we give method for constructing a category from a symmetric lax monoidal functor $F: (\mathcal{C}; \mathcal{M}^{\text{op}}, +) \rightarrow (\text{Set}, \times)$. A morphism in this category, termed a *decorated corelation*, comprises (i) a cospan $X \rightarrow N \leftarrow Y$ in \mathcal{C} such that the canonical copairing $X + Y \rightarrow N$ lies in \mathcal{E} , together with (ii) an element of FN . Functors between decorated corelation categories can be constructed from natural transformations between the decorating functors F . This provides a general method for constructing hypergraph categories—symmetric monoidal categories in which each object is a special commutative Frobenius monoid in a coherent way—and their functors. Such categories are useful for modelling network languages, for example circuit diagrams, and such functors their semantics.

1. Introduction

Consider a circuit diagram.

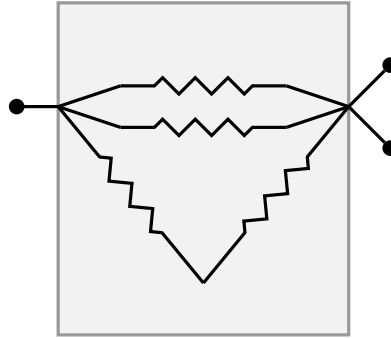

We often view such diagrams atomically, representing the complete physical system built as specified. Yet the very process of building such a system involves assembling it from its parts, each of which we might diagram in the same way. The goal of this paper is to develop formal category-theoretic tools for describing and interpreting this process of assembly.

I thank John Baez, Sam Staton, and Aleks Kissinger for useful conversations. I also gratefully acknowledge the support of the Queen Elizabeth Scholarships, Oxford, and the Basic Research Office of the ASDR&E through ONR N00014-16-1-2010.

2010 Mathematics Subject Classification: 18C10, 18D10.

Key words and phrases: decorated cospan, corelation, Frobenius monoid, hypergraph category, well-supported compact closed category.

© Brendan Fong, 2017. Permission to copy for private use granted.

As we wish to compose circuits, we model them as morphisms in a category. One method for realising the above circuit as a morphism is to use decorated cospans [Fon15]. To do so, consider the part inside the shaded area as a graph with three vertices and the four resistors as edges. Writing n for a set of n elements, we have functions $1 \rightarrow 3$ and $2 \rightarrow 3$ describing how the terminals \bullet on the left and the right respectively are attached to the vertex set 3 of this graph. Thus the above circuit can be modelled as a *cospan* of functions $1 \rightarrow 3 \leftarrow 2$, *decorated* by the aforementioned graph on the apex 3 of this cospan.

While often useful for syntactic purposes, a significant limitation of using cospans alone is that composition of cospans indiscriminately accumulates information. For example, here is a depiction of the composite of five circuits using decorated cospans:

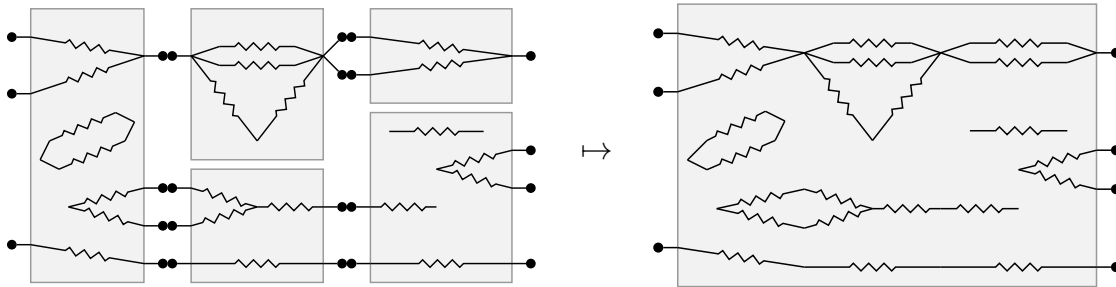

Note in particular that the composite of these circuits contains a unique resistor for every resistor in the factors. If we are interested in describing the syntax of a diagrammatic language, then this is useful: composition builds given expressions into a larger one. If we are only interested in the semantics—given, say by the electrical behaviour at the terminals—this is often unnecessary and thus often wildly inefficient.

Indeed, suppose our semantics for open circuits is given by the information that can be gleaned by connecting other open circuits, such as measurement devices, to the terminals. In these semantics we consider two open circuits equivalent if, should they be encased, but for their terminals, in a black box



we would be unable to distinguish them through our electrical investigations. In this case,

at the very least, the previous circuit is equivalent to the circuit

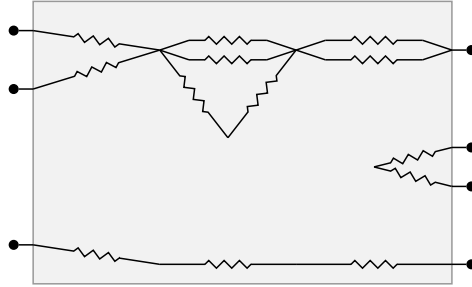

where we have removed circuitry not connected to the terminals. Moreover, this second circuit is a more efficient representation, as it does not model inaccessible, internal structure. If we wish to construct a category modelling the semantics of open circuits then, we require circuit representations and a composition rule that only retain the information relevant to the black boxed circuit. In this paper we introduce the notion of corelation to play this role.

Indeed, corelations allow us to pursue a notion of composition that discards extraneous information as we compose our systems. Consider, for example, the category $\text{Cospan}(\text{FinSet})$ of cospans in the category of finite sets and functions. Given a pair of cospans $X \rightarrow N \leftarrow Y$, $Y \rightarrow M \leftarrow Z$, their composite has apex the pushout $N +_Y M$. This, roughly speaking, is the union of N and M with two points identified if they are both images of the same element of Y . For example, the following pair of cospans:

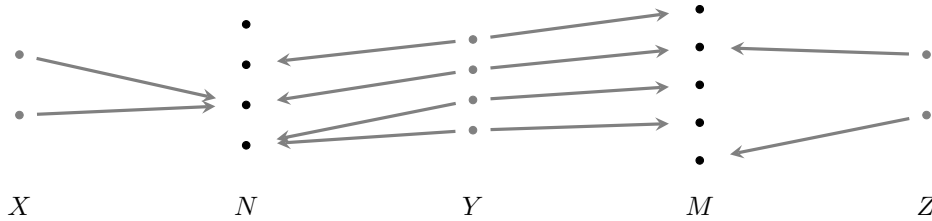

becomes

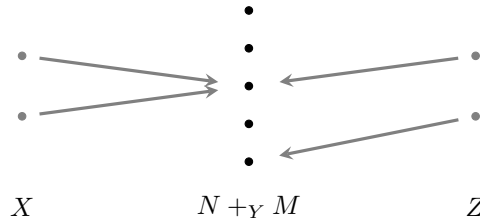

Here we see essentially the same phenomenon as we described for circuits above: the apex of the cospan is much larger than the image of the maps from the feet.

Corelations address this with what is known as a $(\mathcal{E}, \mathcal{M})$ -factorisation system. A factorisation system comprises subcategories \mathcal{E} and \mathcal{M} of \mathcal{C} such that every morphism in \mathcal{C} factors, in a coherent way, as the composite of a morphism in \mathcal{E} followed by a morphism

in \mathcal{M} . An example, known as the epi-mono factorisation system on Set , is yielded by the observation that every function can be written as a surjection followed by an injection.

Corelations, or more precisely $(\mathcal{E}, \mathcal{M})$ -corelations, are cospans $X \rightarrow N \leftarrow Y$ such that the copairing $X + Y \rightarrow N$ of the two maps is an element of the first factor \mathcal{E} of the factorisation system. Composition of corelations proceeds first as composition of cospans, but then takes only the so-called \mathcal{E} -part of the composite cospan, to ensure the composite is again a corelation. If we take the \mathcal{E} -part of a cospan $X \rightarrow N \leftarrow Y$, we write the new apex \overline{N} , and so the resulting corelation $X \rightarrow \overline{N} \leftarrow Y$.

Mapping the above two cospans to epi-mono corelations in FinSet they become

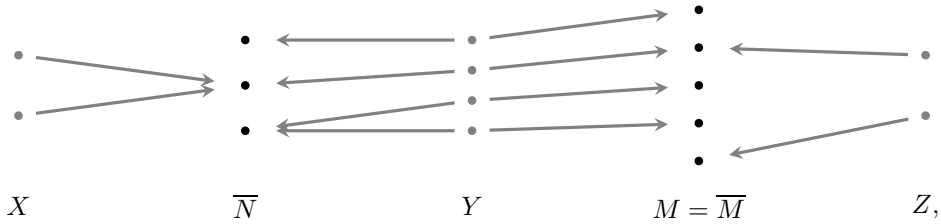

with composite

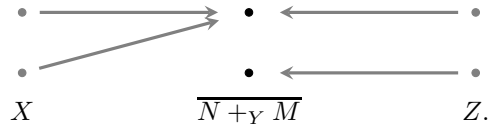

Note that the apex of the composite corelation is the subset of the apex of the composite cospan comprising exactly those elements in the image of the maps from the feet. The intuition, again, is that composition of corelations discards irrelevant information—of course, exactly what information it discards depends on our choice of factorisation system.

Recall that a hypergraph category is a symmetric monoidal category in which every object is equipped with the structure of a special commutative Frobenius monoid in a coherent way. Due to the readily available Frobenius structure, hypergraph categories are well suited to modelling network-style composition. For example, in the circuits example above, the Frobenius structure allows description of many-to-many interconnections, as well as the ability to turn inputs into outputs, and vice versa.

Our first contribution is to show that, under a mild condition on the factorisation system, we can use corelations to construct hypergraph categories and their functors.

1.1. THEOREM. *Let \mathcal{C} be a category with finite colimits and a factorisation system $(\mathcal{E}, \mathcal{M})$. If \mathcal{M} is stable under pushout, then corelations in \mathcal{C} form the morphisms of a hypergraph category.*

Moreover, let A be a colimit-preserving functor between categories $\mathcal{C}, \mathcal{C}'$, where \mathcal{C} and \mathcal{C}' are respectively equipped with factorisation systems $(\mathcal{E}, \mathcal{M}), (\mathcal{E}', \mathcal{M}')$ such that \mathcal{M} and \mathcal{M}' are stable under pushout. If the image under A of \mathcal{M} lies in \mathcal{M}' , then A induces a hypergraph functor between their corelation categories.

The object of this paper is to construct hypergraph categories of *decorated* corelations. How do decorations enter the picture? An instructive example comes from matrices. Suppose we have devices built from channels that take the signal at some input, amplify it, and deliver it to some output. For simplicity let these signals be real numbers, and amplification be linear: we just multiply by some fixed scalar. We depict an example device like so:

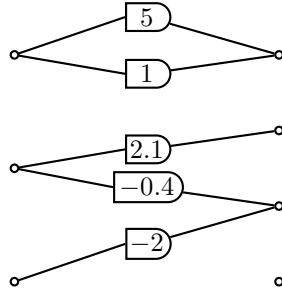

Here there are three inputs, four outputs, and five paths. Formally, we might model these devices as finite sets of inputs X , outputs Y , and paths N , together with functions $i: N \rightarrow X$ and $o: N \rightarrow Y$ describing the start and end of each path, and a function $s: N \rightarrow \mathbb{R}$ describing the amplification along it. In other words, these are cospans $X \rightarrow N \leftarrow Y$ in $\text{FinSet}^{\text{op}}$ decorated by ‘scalar assignment’ functions $N \rightarrow \mathbb{R}$. This suggests a decorated cospans construction.

For a decorated cospan category we begin with a lax symmetric monoidal functor on a category with finite colimits, such as the functor that takes a finite set N to the set of circuits with vertex set N . Here we begin with the lax symmetric monoidal functor $\mathbb{R}^{(-)}: \text{FinSet}^{\text{op}} \rightarrow \text{Set}$ that takes a finite set N to the set \mathbb{R}^N of functions $s: N \rightarrow \mathbb{R}$, and takes an opposite function $f^{\text{op}}: N \rightarrow M$ to the map sending $s: N \rightarrow \mathbb{R}$ to $s \circ f: M \rightarrow \mathbb{R}$. Note that the coproduct in $\text{FinSet}^{\text{op}}$ is the cartesian product of sets. The coherence maps of the functor, which are critical for composing the decorations, are given by $\varphi_{N,M}: \mathbb{R}^N \times \mathbb{R}^M \rightarrow \mathbb{R}^{N \times M}$, taking $(s, t) \in \mathbb{R}^N \times \mathbb{R}^M$ to the function $s \cdot t: N \times M \rightarrow \mathbb{R}$ defined by pointwise multiplication in \mathbb{R} .

Composition in this decorated cospan category is thus given by the multiplication in \mathbb{R} . In detail, given decorated cospans $(X \xrightarrow{i_X^{\text{op}}} N \xleftarrow{o_Y^{\text{op}}} Y, N \xrightarrow{s} \mathbb{R})$ and $(Y \xrightarrow{i_Y^{\text{op}}} M \xleftarrow{o_Z^{\text{op}}} Z, M \xrightarrow{t} \mathbb{R})$, the composite has a path from $x \in X$ to $z \in Z$ for every triple (y, n, m) where $y \in Y$, $n \in N$, and $m \in M$, such that n is a path from x to y and m is a path from y to z . The scalar assigned to this path is the product of those assigned to n and m . For

example, we have the following composite

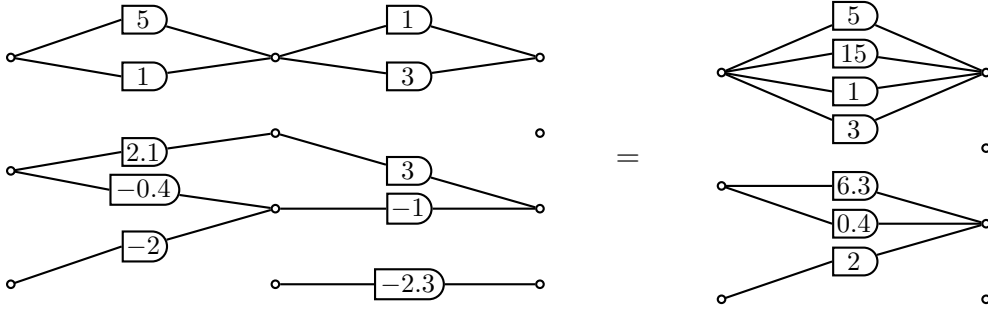

There are four paths between the top-most element x_1 of the domain and the top-most element z_1 of the codomain: we may first take the path that amplifies by $5\times$ and then the path that amplifies by $1\times$ for a total amplification of $5\times$, or $5\times$ and $3\times$ for $15\times$, and so on. This means we end up with four elements relating x_1 and z_1 in the composite. The apex of the composite is in fact given by the pullback $N \times_Y M$ of the cospan $N \xrightarrow{oy} Y \xleftarrow{iy} M$ in \mathbf{FinSet} .

Here we again see the problem of decorated cospans: the composite of the above puts decorations on $N \times_Y M$, which can be of much larger cardinality than N and M . We wish to avoid the size of our decorated cospan from growing so fast. Moreover, from our open systems perspective, we care not about the path but by the total amplification of the signal from some chosen input to some chosen output. The intuition is that if we black box the system, then we cannot tell what paths the signal took through the system, only the total amplification from input to output.

We thus want to restrict our apex to contain at most one point for each input–output pair (x, y) . We do this by pushing the decoration along the surjection e in the epi-mono factorisation of the function $N \times_Y M \xrightarrow{e} \overline{N \times_Y M} \xrightarrow{m} X \times Z$. Put another way, we want the category of decorated corelations, not decorated cospans.

Represented as decorated corelations, the above composite becomes

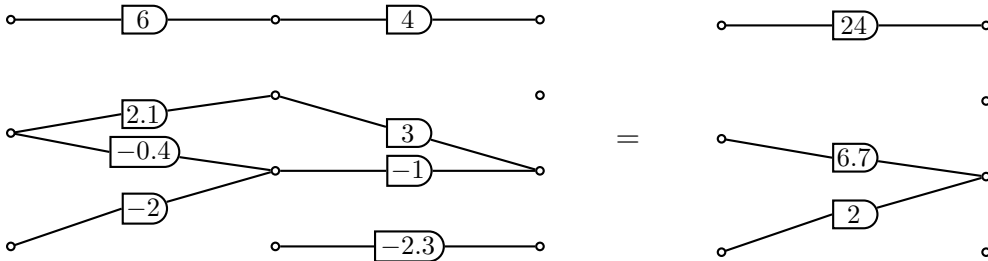

Note that composite is not simply the composite as decorated cospans, but the composite decorated cospan reduced to a decorated corelation. We will show that this decorated corelations category is equivalent to the category of real vector spaces and linear maps, with monoidal product the tensor product.

It is not a trivial fact that the above composition rule for decorated corelations defines a category. Indeed, the reason that it is possible to push the decoration along the

surjection e is that the lax symmetric monoidal functor $\mathbb{R}^{(-)}: \text{FinSet}^{\text{op}} \rightarrow \text{Set}$ extends to a lax symmetric monoidal functor $(\text{FinSet}^{\text{op}}; \text{Sur}^{\text{op}}) \rightarrow \text{Set}$. Here $\text{FinSet}^{\text{op}}; \text{Sur}^{\text{op}}$ is the subcategory of $\text{Cospan}(\text{FinSet}^{\text{op}})$ comprising cospans of the form $\xrightarrow{f^{\text{op}}} \xleftarrow{e^{\text{op}}}$, where f is any function but e must be a surjection.

More generally, given a category \mathcal{C} with finite colimits and a subcategory \mathcal{M} stable under pushouts, we may construct a symmetric monoidal category $\mathcal{C}; \mathcal{M}^{\text{op}}$ with isomorphism classes of cospans of the form $\xrightarrow{f} \xleftarrow{m}$, where $f \in \mathcal{C}$, $m \in \mathcal{M}$, as morphisms. The monoidal product is again derived from the coproduct in \mathcal{C} .

The main theorem is that these decorated corelations form a hypergraph category.

1.2. THEOREM. *Given a category \mathcal{C} with finite colimits, factorisation system $(\mathcal{E}, \mathcal{M})$ such that \mathcal{M} is stable under pushouts, and a symmetric lax monoidal functor*

$$F: \mathcal{C}; \mathcal{M}^{\text{op}} \longrightarrow \text{Set},$$

define a decorated corelation to be an $(\mathcal{E}, \mathcal{M})$ -corelation $X \rightarrow N \leftarrow Y$ in \mathcal{C} together with an element of FN . Then there is a hypergraph category $F\text{Corel}$ with the objects of \mathcal{C} as objects and isomorphism classes of decorated corelations as morphisms.

As for decorated cospans, hypergraph functors between these so-named decorated corelations categories can further be defined from natural transformations between the decorating functors. This is especially useful for problems of constructing compositional semantics, such as the circuit setting outlined above.

OUTLINE. The structure of this paper is straightforward. After a brief review of background material, we discuss in turn corelation categories (§3), functors between corelation categories (§4), decorated corelation categories (§5), and functors between decorated corelation categories (§6). We then conclude with detailed discussions of two examples: matrices and linear relations.

2. Background

This section provides a brief review of hypergraph categories, cospans, decorated cospans, and corelations. For details, see [Fon15, Fon16].

HYPERGRAPH CATEGORIES

We recall special commutative Frobenius monoids, writing our axioms using the string calculus for monoidal categories introduced by Joyal and Street [JS91]. Diagrams will be read left to right, and we shall suppress the labels as we deal with a unique generating object and a unique generator of each type.

2.1. DEFINITION. A **special commutative Frobenius monoid** $(X, \mu, \eta, \delta, \epsilon)$ in a monoidal category (\mathcal{C}, \otimes) is an object X of \mathcal{C} together with maps

$$\begin{array}{cccc} \begin{array}{c} \text{---} \\ \text{---} \\ \text{---} \end{array} & \begin{array}{c} \bullet \\ \text{---} \end{array} & \begin{array}{c} \text{---} \\ \text{---} \\ \text{---} \end{array} & \begin{array}{c} \text{---} \\ \bullet \end{array} \\ \mu: X \otimes X \rightarrow X & \eta: I \rightarrow X & \delta: X \rightarrow X \otimes X & \epsilon: X \rightarrow I \end{array}$$

obeying the commutative monoid axioms

$$\begin{array}{ccc} \begin{array}{c} \text{---} \\ \text{---} \\ \text{---} \end{array} = \begin{array}{c} \text{---} \\ \text{---} \\ \text{---} \end{array} & \begin{array}{c} \bullet \\ \text{---} \end{array} = \text{---} & \begin{array}{c} \text{---} \\ \text{---} \end{array} = \begin{array}{c} \text{---} \\ \text{---} \end{array} \\ \text{(associativity)} & \text{(unitality)} & \text{(commutativity)} \end{array}$$

the cocommutative comonoid axioms

$$\begin{array}{ccc} \begin{array}{c} \text{---} \\ \text{---} \\ \text{---} \end{array} = \begin{array}{c} \text{---} \\ \text{---} \\ \text{---} \end{array} & \begin{array}{c} \bullet \\ \text{---} \end{array} = \text{---} & \begin{array}{c} \text{---} \\ \text{---} \end{array} = \begin{array}{c} \text{---} \\ \text{---} \end{array} \\ \text{(coassociativity)} & \text{(counitality)} & \text{(cocommutativity)} \end{array}$$

and the Frobenius and special axioms

$$\begin{array}{ccc} \begin{array}{c} \text{---} \\ \text{---} \\ \text{---} \end{array} = \begin{array}{c} \text{---} \\ \text{---} \\ \text{---} \end{array} = \begin{array}{c} \text{---} \\ \text{---} \\ \text{---} \end{array} & \begin{array}{c} \text{---} \\ \text{---} \end{array} = \text{---} \\ \text{(Frobenius)} & \text{(special)} \end{array}$$

where \times is the braiding on $X \otimes X$.

2.2. DEFINITION. A **hypergraph category** is a symmetric monoidal category in which each object X is equipped with a special commutative Frobenius structure $(X, \mu_X, \delta_X, \eta_X, \epsilon_X)$ such that

$$\begin{aligned} \mu_{X \otimes Y} &= (\mu_X \otimes \mu_Y) \circ (1_X \otimes \sigma_{YX} \otimes 1_Y) & \eta_{X \otimes Y} &= \eta_X \otimes \eta_Y \\ \delta_{X \otimes Y} &= (1_X \otimes \sigma_{XY} \otimes 1_Y) \circ (\delta_X \otimes \delta_Y) & \epsilon_{X \otimes Y} &= \epsilon_X \otimes \epsilon_Y. \end{aligned}$$

A functor (F, φ) of hypergraph categories, or **hypergraph functor**, is a strong symmetric monoidal functor (F, φ) that preserves the hypergraph structure. More precisely, the latter condition means that given an object X , the special commutative Frobenius structure on FX must be

$$(FX, F\mu_X \circ \varphi_{X,X}, \varphi^{-1} \circ F\delta_X, F\eta_X \circ \varphi_1, \varphi_1 \circ \epsilon_X).$$

Hypergraph categories were first defined by Carboni and Walters, under the name well-supported compact closed categories [Car91].

COSPANS

We give a fundamental example of hypergraph categories.

Let \mathcal{C} be a category with finite colimits. Recall that a **cospan** $X \xrightarrow{i} N \xleftarrow{o} Y$ from X to Y in \mathcal{C} is a pair of morphisms with common codomain. We refer to X and Y as the **feet**, and N as the **apex**. Given two cospans $X \xrightarrow{i} N \xleftarrow{o} Y$ and $X \xrightarrow{i'} N' \xleftarrow{o'} Y$ with the same feet, a **map of cospans** is a morphism $n: N \rightarrow N'$ in \mathcal{C} between the apices such that

$$\begin{array}{ccc}
 & N & \\
 i \nearrow & & \nwarrow o \\
 X & & Y \\
 i' \searrow & & \swarrow o' \\
 & N' &
 \end{array}$$

commutes.

Cospans may be composed, up to isomorphism, using the pushout from the common foot: given cospans $X \xrightarrow{i_X} N \xleftarrow{o_Y} Y$ and $Y \xrightarrow{i_Y} M \xleftarrow{o_Z} Z$, their composite cospan is $X \xrightarrow{j_N \circ i_X} N +_Y M \xleftarrow{j_M \circ i_Z} Z$, where

$$\begin{array}{ccccc}
 & & N +_Y M & & \\
 & & \nearrow j_N & & \nwarrow j_M \\
 & X & & N & & M & \\
 & \nearrow i_X & & \nwarrow o_Y & & \nearrow i_Y & \\
 & & Y & & & & Z \\
 & & \nwarrow o_Z & & & &
 \end{array}$$

is a pushout square.

Write $+$ for the coproduct in \mathcal{C} . We may consider \mathcal{C} as a symmetric monoidal category $(\mathcal{C}, +)$ with monoidal product given by the coproduct. Also, given maps $f: A \rightarrow C$, $g: B \rightarrow C$ with common codomain, the universal property of the coproduct gives a unique map $[f, g]: A + B \rightarrow C$; we call this the **copairing** of f and g . We write $!: \emptyset \rightarrow X$ for the unique map from the initial object.

2.3. PROPOSITION. [RSW08, §2.2] *Given a category \mathcal{C} with finite colimits, we may define a hypergraph category $\text{Cospan}(\mathcal{C})$ as follows:*

<i>The hypergraph category $(\text{Cospan}(\mathcal{C}), +)$</i>	
objects	<i>the objects of \mathcal{C}</i>
morphisms	<i>isomorphism classes of cospans in \mathcal{C}</i>
composition	<i>given by pushout</i>
monoidal product	<i>the coproduct in \mathcal{C}</i>
coherence maps	<i>inherited from $(\mathcal{C}, +)$</i>
hypergraph maps	$\mu = [1, 1], \eta = !, \delta = [1, 1]^{\text{op}}, \epsilon = !^{\text{op}}$.

Note that, as we do above, we shall frequently use representative cospans to refer to their isomorphism class. Furthermore, given $f: X \rightarrow Y$ in \mathcal{C} , we also abuse notation by writing $f \in \text{Cospan}(\mathcal{C})$ for the cospan $X \xrightarrow{f} Y \xleftarrow{1_Y} Y$, and f^{op} for the cospan $Y \xrightarrow{1_Y} Y \xleftarrow{f} X$.

DECORATED COSPANS

Write (Set, \times) for the symmetric monoidal category of finite sets and functions, where the monoidal product is the categorical product.

2.4. DEFINITION. Let \mathcal{C} be a category with finite colimits, and

$$(F, \varphi) : (\mathcal{C}, +) \longrightarrow (\text{Set}, \times)$$

be a symmetric lax monoidal functor. We define a **decorated cospan**, or more precisely an F -decorated cospan, to be a pair

$$\left(\begin{array}{ccc} & N & \\ i \nearrow & & \nwarrow o \\ X & & Y \end{array}, \quad \begin{array}{c} FN \\ \uparrow s \\ 1 \end{array} \right)$$

comprising a cospan $X \xrightarrow{i} N \xleftarrow{o} Y$ in \mathcal{C} together with an element $1 \xrightarrow{s} FN$ of the F -image FN of the apex of the cospan. The element $1 \xrightarrow{s} FN$ is known as the **decoration** of the decorated cospan. A morphism of decorated cospans

$$n : (X \xrightarrow{i_X} N \xleftarrow{o_Y} Y, 1 \xrightarrow{s} FN) \longrightarrow (X \xrightarrow{i'_X} N' \xleftarrow{o'_Y} Y, 1 \xrightarrow{s'} FN')$$

is a morphism $n : N \rightarrow N'$ of cospans such that $Fn \circ s = s'$.

On representatives of the isomorphism classes, composition of decorated cospans is given by the usual composite cospan decorated with the composite

$$1 \xrightarrow{\lambda^{-1}} 1 \otimes 1 \xrightarrow{s \otimes t} FN \otimes FM \xrightarrow{\varphi_{N,M}} F(N + M) \xrightarrow{F[j_N, j_M]} F(N +_Y M)$$

of the tensor product of the decorations with the F -image of the copairing of the pushout maps.

Each cospan may be given the empty decoration. The **empty decoration** is the decoration $1 \xrightarrow{\varphi_1} F\emptyset \xrightarrow{F!} FN$.

2.5. PROPOSITION. [Fon15, Theorem 3.4] Let \mathcal{C} be a category with finite colimits and $(F, \varphi) : (\mathcal{C}, +) \rightarrow (\text{Set}, \times)$ a symmetric lax monoidal functor. We define:

<i>The hypergraph category $(FCospan, +)$</i>	
objects	<i>the objects of \mathcal{C}</i>
morphisms	<i>isomorphism classes of F-decorated cospans in \mathcal{C}</i>
composition	<i>given by pushout, as described above</i>
monoidal product	<i>the coproduct in \mathcal{C}</i>
coherence maps	<i>maps from $Cospan(\mathcal{C})$ with empty decoration</i>
hypergraph maps	<i>maps from $Cospan(\mathcal{C})$ with empty decoration</i>

2.6. REMARK. In previous expositions of decorated cospans we have let decorations lie in any braided monoidal category. Sam Staton pointed out that it is general enough to let decorations lie in the symmetric monoidal category (Set, \times) . See Appendix A for details.

We will also need the following lemma, showing that empty decorations act trivially.

2.7. LEMMA. [Fon15, Proposition A.4] *Let $(X \xrightarrow{i_X} N \xleftarrow{o_Y} Y, I \xrightarrow{s} FN)$ be a decorated cospan, and suppose we have an empty-decorated cospan $(Y \xrightarrow{i_Y} M \xleftarrow{o_Z} Z, I \xrightarrow{\varphi \circ F^!} FM)$. Then the composite of these decorated cospans is*

$$(X \xrightarrow{j_N \circ i_X} N +_Y M \xleftarrow{j_M \circ o_Z} Z, I \xrightarrow{F j_N \circ s} F(N +_Y M)).$$

In particular, the decoration on the composite is the decoration s pushed forward along the F -image of the map $j_N: N \rightarrow N +_Y M$ to become an F -decoration on $N +_Y M$. The analogous statement also holds for composition with an empty-decorated cospan on the left.

CORELATIONS

Given sets X, Y , a relation $X \rightarrow Y$ is a subset of the product $X \times Y$. Note that by the universal property of the product, spans $X \leftarrow N \rightarrow Y$ are in one-to-one correspondence with functions $N \rightarrow X \times Y$. When this map is monic, we say that the span is *jointly monic*. More abstractly then, we might say a relation is an isomorphism class of jointly monic spans in the category of sets. Here we generalise the dual concept: these are our so-called corelations.

The category theoretic study of relations is extensive; for a survey, see [Mil00]. In our general setting, the key insight is the use of a factorisation system. A factorisation system allows any morphism in a category to be factored into the composite of two morphisms in a coherent way.

2.8. DEFINITION. A **factorisation system** $(\mathcal{E}, \mathcal{M})$ in a category \mathcal{C} comprises subcategories \mathcal{E}, \mathcal{M} of \mathcal{C} such that

(i) \mathcal{E} and \mathcal{M} contain all isomorphisms of \mathcal{C} .

(ii) every morphism $f \in \mathcal{C}$ admits a factorisation $f = m \circ e$, $e \in \mathcal{E}$, $m \in \mathcal{M}$.

(iii) given morphisms f, f' , with factorisations $f = m \circ e$, $f' = m' \circ e'$ of the above sort, for every u, v such that $v \circ f = f' \circ u$, there exists a unique morphism s such that

$$\begin{array}{ccc}
 & \xrightarrow{e} & \xrightarrow{m} \\
 u \downarrow & & \downarrow \exists! s \\
 & \xrightarrow{e'} & \xrightarrow{m'} \\
 & & v \downarrow
 \end{array}$$

commutes.

Observe that relations are just spans $X \leftarrow N \rightarrow Y$ in Set such that $N \rightarrow X \times Y$ is an element of Inj , the right factor in the factorisation system (Sur, Inj) . Relations may thus be generalised as spans such that the span maps jointly belong to some class \mathcal{M} of an $(\mathcal{E}, \mathcal{M})$ -factorisation system. We define corelations in the dual manner.

2.9. DEFINITION. Let \mathcal{C} be a category with finite colimits, and let $(\mathcal{E}, \mathcal{M})$ be a factorisation system on \mathcal{C} . An $(\mathcal{E}, \mathcal{M})$ -**corelation** $X \rightarrow Y$ is a cospan $X \xrightarrow{i} N \xleftarrow{o} Y$ in \mathcal{C} such that the copairing $[i, o]: X + Y \rightarrow N$ lies in \mathcal{E} .

When the factorisation system is clear from context, we simply call $(\mathcal{E}, \mathcal{M})$ -corelations ‘corelations’.

We also say that a cospan $X \xrightarrow{i} N \xleftarrow{o} Y$ with the property that the copairing $[i, o]: X + Y \rightarrow N$ lies in \mathcal{E} is **jointly \mathcal{E} -like**. Note that if a cospan is jointly \mathcal{E} -like then so are all isomorphic cospans. Thus the property of being a corelation is closed under isomorphism of cospans, and we again are often lazy with our language, referring to both jointly \mathcal{E} -like cospans and their isomorphism classes as corelations.

If $f: A \rightarrow N$ is a morphism with factorisation $f = m \circ e$, write \overline{N} for the object such that $e: A \rightarrow \overline{N}$ and $m: \overline{N} \rightarrow N$. Now, given a cospan $X \xrightarrow{i_X} N \xleftarrow{o_Y} Y$, we may use the factorisation system to write the copairing $[i_X, o_Y]: X + Y \rightarrow N$ as

$$X + Y \xrightarrow{e} \overline{N} \xrightarrow{m} N.$$

From the universal property of the coproduct, we also have maps $\iota_X: X \rightarrow X + Y$ and $\iota_Y: Y \rightarrow X + Y$. We then call the corelation

$$X \xrightarrow{e \circ \iota_X} \overline{N} \xleftarrow{e \circ \iota_Y} Y$$

the **\mathcal{E} -part** of the above cospan. On occasion we will also write $e: X + Y \rightarrow \overline{N}$ for the same corelation.

We compose corelations by taking the \mathcal{E} -part of their composite cospan. That is, given corelations $X \xrightarrow{i_X} N \xleftarrow{o_Y} Y$ and $Y \xrightarrow{i_Y} M \xleftarrow{o_Z} Z$, their composite is given by the cospan

$X \xrightarrow{e \circ i_X} \overline{N +_Y M} \xleftarrow{e \circ o_Z} Z$ in the commutative diagram

$$\begin{array}{ccccc}
 & & N +_Y M & & \\
 & & \uparrow m & & \\
 & & \overline{N +_Y M} & & \\
 & & \uparrow e & & \\
 & & X + Z & & \\
 & & \uparrow i_X \quad \uparrow o_Y & & \\
 X & \xrightarrow{i_X} & N & \xrightarrow{j_N} & N +_Y M \\
 & \searrow \iota_X & & \nearrow j_M & \\
 & & X + Z & & \\
 & & \uparrow i_Y \quad \uparrow \iota_Z & & \\
 & & Y & \xrightarrow{o_Z} & M \\
 & & & \nearrow \iota_Z & \\
 & & & & Z
 \end{array}$$

where $m \circ e$ is the $(\mathcal{E}, \mathcal{M})$ -factorisation of $[j_N \circ i_X, j_M \circ o_Z]: X + Z \rightarrow N +_Y M$. It is not difficult to show, that this composite is unique up to isomorphism.

For nice categorical properties, like associativity under composition, it is important that our factorisation system be costable.

2.10. DEFINITION. *Given a category \mathcal{C} , we say that a subcategory \mathcal{M} is **stable under pushout** if for every pushout square*

$$\begin{array}{ccc}
 & \xrightarrow{j} & \\
 \uparrow & & \uparrow \\
 & \xrightarrow{m} & \\
 \downarrow & & \downarrow
 \end{array}$$

*such that $m \in \mathcal{M}$, we also have that $j \in \mathcal{M}$. We say that a factorisation system $(\mathcal{E}, \mathcal{M})$ is **costable** if \mathcal{M} is stable under pushout.*

2.11. PROPOSITION. *Let \mathcal{C} be a category with finite colimits and a costable factorisation system $(\mathcal{E}, \mathcal{M})$. Then there exists a category $\text{Corel}_{(\mathcal{E}, \mathcal{M})}(\mathcal{C})$ with the objects of \mathcal{C} as objects, $(\mathcal{E}, \mathcal{M})$ -corelations as morphisms, and composition given as above. Moreover, the map taking a cospan to its \mathcal{E} -part defines a functor $\square: \text{Cospan}(\mathcal{C}) \rightarrow \text{Corel}(\mathcal{C})$.*

We will drop explicit reference to the factorisation system when context allows, simply writing $\text{Corel}(\mathcal{C})$.

This is a standard result. For instance, a bicategorical version of the dual theorem, for relations, can be found in [JW00]. For more intuition regarding corelations and their relationship to special commutative Frobenius monoids, see [CF17].

2.12. EXAMPLES. Write $\mathcal{I}_{\mathcal{C}}$ for the wide subcategory of \mathcal{C} containing exactly the isomorphisms of \mathcal{C} . Two seemingly trivial, but important, examples of costable factorisation

systems are $(\mathcal{I}_C, \mathcal{C})$ and $(\mathcal{C}, \mathcal{I}_C)$. The category $\text{Corel}_{(\mathcal{I}_C, \mathcal{C})}(\mathcal{C})$ is equivalent to the terminal category, while $\text{Corel}_{(\mathcal{C}, \mathcal{I}_C)}(\mathcal{C})$ is isomorphic to $\text{Cospan}(\mathcal{C})$.

Another example of costable factorisation system is the epi-mono factorisation system (Sur, Inj) in Set , whence corelations $X \rightarrow Y$ are equivalence relations on $X + Y$.

This generalises to any topos. Indeed, Lack and Sobociński showed that monomorphisms are stable under pushout in any adhesive category [LS04]. Since any topos is both a regular category and an adhesive category [LS06, Lac11], the regular epimorphism-monomorphism factorisation system in any topos is costable.

Another class of examples comes from coregular categories. A coregular category is by definition a category that has finite colimits and a costable epimorphism-regular monomorphism factorisation system. Examples of these include the category of topological spaces and continuous maps, as well as Set^{op} , any cotopos, and so on.

3. Corelations form hypergraph categories

The focus of this paper is not just the construction of categories, but *hypergraph* categories. In fact, all corelation categories come equipped with this extra structure. In this section we explain the relevant data, and tackle some of the monoidal considerations. We shall complete the proof that we have a hypergraph category simultaneously with our consideration of functors in the next section.

The hypergraph structure on $\text{Corel}(\mathcal{C})$ is that which makes the canonical functor

$$\square: \text{Cospan}(\mathcal{C}) \longrightarrow \text{Corel}(\mathcal{C})$$

a hypergraph functor. Indeed, we define the coherence and Frobenius maps of $\text{Corel}(\mathcal{C})$ to be their image under this map. For the monoidal product we again use the coproduct in \mathcal{C} ; the monoidal product of two corelations is their monoidal product as cospans.

3.1. THEOREM. *Let \mathcal{C} be a category with finite colimits, and let $(\mathcal{E}, \mathcal{M})$ be a costable factorisation system. Then there exists a hypergraph category $\text{Corel}(\mathcal{C})$ with*

<i>The hypergraph category $(\text{Corel}_{(\mathcal{E}, \mathcal{M})}(\mathcal{C}), +)$</i>	
<i>objects</i>	<i>the objects of \mathcal{C}</i>
<i>morphisms</i>	<i>isomorphism classes of $(\mathcal{E}, \mathcal{M})$-corelations in \mathcal{C}</i>
<i>composition</i>	<i>given by the \mathcal{E}-part of pushout</i>
<i>monoidal product</i>	<i>the coproduct in \mathcal{C}</i>
<i>coherence maps</i>	<i>inherited from $\text{Cospan}(\mathcal{C})$</i>
<i>hypergraph maps</i>	<i>inherited from $\text{Cospan}(\mathcal{C})$</i>

PROOF STRATEGY: We will prove this theorem in two stages. The first stage, which will be the rest of this section, is focussed on monoidal considerations. We prove two lemmas, which respectively show that \mathcal{E} and \mathcal{M} are closed under $+$. In particular, that \mathcal{E} is closed (Lemma 3.2) implies that the proposed monoidal product on $\text{Corel}(\mathcal{C})$ is independent of choice of representative corelation, and hence well defined as a function. For the second stage, it remains to check a number of axioms: functoriality of the monoidal product, naturality of the coherence maps, the coherence axioms for symmetric monoidal categories, the Frobenius laws. We do this in the next section.

Our strategy for the axiom checking of Stage 2 will be to show that the surjective function from cospans to corelations defined by taking a cospan to its jointly \mathcal{E} -part preserves both composition and the monoidal product. This then implies that to evaluate an expression in the monoidal category of corelations, we may simply evaluate it in the monoidal category of cospans, and then take the \mathcal{E} -part. Thus if an equation is true for cospans, it is true for corelations.

Instead of proving just this, however, we will prove a generalisation regarding an analogous map between any two corelation categories. Such a map exists whenever we have two corelation categories $\text{Corel}_{(\mathcal{E}, \mathcal{M})}(\mathcal{C})$ and $\text{Corel}_{(\mathcal{E}', \mathcal{M}')}(\mathcal{C}')$ and a colimit preserving functor $A: \mathcal{C} \rightarrow \mathcal{C}'$ such that the image of \mathcal{M} lies in \mathcal{M}' . As $(\mathcal{C}, \mathcal{I}_{\mathcal{C}})$ -corelations are just cospans, this reduces to the desired special case by taking the domain to be the category of $(\mathcal{C}, \mathcal{I}_{\mathcal{C}})$ -corelations, \mathcal{C}' to be equal to \mathcal{C} , and A to be the identity functor. But the generality is not spurious: it has the advantage of proving the existence of a class of hypergraph functors between corelation categories in the same fell swoop. Although a touch convoluted, this strategy is worth the pause for thought. We will use it once again for *decorated* corelations, to great economy.

First though, back to Stage 1: monoidal considerations. As we are concerned with building monoidal categories of corelations, it will be important that our factorisation systems are so-named monoidal factorisation systems. These are factorisation systems $(\mathcal{E}, \mathcal{M})$ such that (\mathcal{E}, \otimes) is a monoidal category. Luckily, when the monoidal product is the coproduct, *all* factorisation systems are monoidal factorisation systems.

3.2. LEMMA. *Let \mathcal{C} be a category with finite coproducts, and let $(\mathcal{E}, \mathcal{M})$ be a factorisation system on \mathcal{C} . Then $(\mathcal{E}, +)$ is a symmetric monoidal category.*

PROOF. The only thing to check is that \mathcal{E} is closed under $+$. That is, given $f: A \rightarrow B$ and $g: C \rightarrow D$ in \mathcal{E} , we wish to show that $f + g: A + C \rightarrow B + D$, defined in \mathcal{C} , is also a morphism in \mathcal{E} .

Let $f + g$ have factorisation $A + C \xrightarrow{e} \overline{B + D} \xrightarrow{m} B + D$, where $e \in \mathcal{E}$ and $m \in \mathcal{M}$. We will prove that m is an isomorphism. To construct an inverse, recall that by definition, as f and g lie in \mathcal{E} , there exist morphisms $x: B \rightarrow \overline{B + D}$ and $y: D \rightarrow \overline{B + D}$ such that

$$\begin{array}{ccc}
 \begin{array}{ccc}
 A & \xrightarrow{f} & B \xlongequal{\quad} B \\
 \downarrow & & \vdots \downarrow x \\
 A + C & \xrightarrow{e} & \overline{B + D} \xrightarrow{m} B + D
 \end{array} & \text{and} &
 \begin{array}{ccc}
 C & \xrightarrow{g} & D \xlongequal{\quad} D \\
 \downarrow & & \vdots \downarrow y \\
 A + C & \xrightarrow{e} & \overline{B + D} \xrightarrow{m} B + D
 \end{array}
 \end{array} \tag{1}$$

The copairing $[x, y]$ is an inverse to m .

Indeed, taking the coproduct of the top rows of the two diagrams above and the copairings of the vertical maps gives the commutative diagram

$$\begin{array}{ccccc} A + C & \xrightarrow{f+g} & B + D & \xlongequal{\quad} & B + D \\ \parallel & & \downarrow [x,y] & & \parallel \\ A + C & \xrightarrow{e} & \overline{B + D} & \xrightarrow{m} & B + D \end{array}$$

Reading the right-hand square immediately gives $m \circ [x, y] = 1$.

Conversely, to see that $[x, y] \circ m = 1$, remember that by definition $f + g = m \circ e$. So the left-hand square above implies that

$$\begin{array}{ccc} A + C & \xrightarrow{e} & \overline{B + D} \\ \parallel & & \downarrow [x,y] \circ m \\ A + C & \xrightarrow{e} & \overline{B + D} \end{array}$$

commutes. But by the universal property of factorisation systems, there is a unique map $\overline{B + D} \rightarrow \overline{B + D}$ such that this diagram commutes, and clearly the identity map also suffices. Thus $[x, y] \circ m = 1$. ■

The analogous fact for \mathcal{M} is also important. It follows from stability under pushout.

3.3. LEMMA. *Let \mathcal{C} be a category with finite colimits, and let \mathcal{M} be a subcategory of \mathcal{C} stable under pushouts and containing all isomorphisms. Then $(\mathcal{M}, +)$ is a symmetric monoidal category.*

PROOF. It is enough to show that for all morphisms $m, m' \in \mathcal{M}$ we have $m + m' \in \mathcal{M}$. Since \mathcal{M} contains all isomorphisms, the coherence maps are inherited from \mathcal{C} . The required axioms—the functoriality of the tensor product, the naturality of the coherence maps, and the coherence laws—are also inherited as they hold in \mathcal{C} .

To see $m + m'$ is in \mathcal{M} , simply observe that we have the pushout square

$$\begin{array}{ccc} A + C & \xrightarrow{m+1} & B + C \\ \uparrow \iota & & \uparrow \iota \\ A & \xrightarrow{m} & B \end{array}$$

in \mathcal{C} . As \mathcal{M} is stable under pushout, $m + 1 \in \mathcal{M}$. Similarly, $1 + m' \in \mathcal{M}$. Thus their composite $m + m'$ lies in \mathcal{M} , as required. ■

3.4. REMARK. An analogous argument shows that pushouts of maps $m +_{\gamma} m'$ also lie in \mathcal{M} . Using this fact it is not difficult to show the associativity of composition of correlations—the key point is that factorisation commutes with pushouts.

4. Functors between corelation categories

To construct a functor between cospan categories one may start with a colimit-preserving functor between the underlying categories. Corelations are cospans where we forget the \mathcal{M} -part of each cospan. Hence for functors between corelation categories, we require not just a colimit-preserving functor but, loosely speaking, also that we don't forget more in the domain category than in the codomain category.

We devote the next few pages to proving the following proposition. Along the way we prove, as promised, that corelation categories are well-defined hypergraph categories.

4.1. PROPOSITION. *Let \mathcal{C} , \mathcal{C}' have finite colimits and respective costable factorisation systems $(\mathcal{E}, \mathcal{M})$, $(\mathcal{E}', \mathcal{M}')$. Further let $A: \mathcal{C} \rightarrow \mathcal{C}'$ be a functor that preserves finite colimits and such that the image of \mathcal{M} lies in \mathcal{M}' .*

Then we may define a hypergraph functor $\square: \text{Corel}(\mathcal{C}) \rightarrow \text{Corel}(\mathcal{C}')$ sending each object X in $\text{Corel}(\mathcal{C})$ to AX in $\text{Corel}(\mathcal{C}')$ and each corelation

$$X \xrightarrow{i_X} N \xleftarrow{o_Y} Y$$

to the \mathcal{E}' -part

$$AX \xrightarrow{e' \circ i_{AX}} \overline{AN} \xleftarrow{e' \circ o_{AY}} AY.$$

of the image cospan. The coherence maps are the \mathcal{E}' -part $\overline{\kappa_{X,Y}}$ of the isomorphisms $\kappa_{X,Y}: AX + AY \rightarrow A(X + Y)$ given as A preserves colimits.

As discussed, we still have to prove that $\text{Corel}(\mathcal{C})$ is a hypergraph category. We address this first with two lemmas regarding these proposed functors.

4.2. LEMMA. *The above function $\square: \text{Corel}(\mathcal{C}) \rightarrow \text{Corel}(\mathcal{C}')$ preserves composition.*

PROOF. Let $f = (X \rightarrow N \leftarrow Y)$ and $g = (Y \rightarrow M \leftarrow Z)$ be corelations in \mathcal{C} . By definition, the corelations $\square(g) \circ \square(f)$ and $\square(g \circ f)$ are given by the first arrows in the top and bottom row respectively of the diagram:

$$\begin{array}{ccccccc}
 AX+AZ & \xrightarrow{\mathcal{E}'} & \overline{\overline{AN+AY} \overline{AM}} & \xrightarrow{\mathcal{M}'} & \overline{AN+AY} \overline{AM} & \xrightarrow{m'_{AN+AY} m'_{AM}} & AN+AY \overline{AM} \\
 \parallel & & \uparrow n & & & & \uparrow \sim \\
 AX+AZ & \xrightarrow{\mathcal{E}'} & \overline{A(N+YM)} & \xrightarrow{\mathcal{M}'} & A(N+YM) & \xrightarrow{Am_{N+YM}} & A(N+YM)
 \end{array} \quad (*)$$

The morphisms labelled \mathcal{E}' lie in \mathcal{E}' , and similarly for \mathcal{M}' ; these are given by the factorisation system on \mathcal{C}' . The maps Am_{N+YM} and $m'_{AN+AY} m'_{AM}$ lie in \mathcal{M}' too: Am_{N+YM} as it is in the image of \mathcal{M} , and $m'_{AN+AY} m'_{AM}$ as \mathcal{M}' is stable under pushout.

Moreover, the diagram commutes as both maps $AX + AZ \rightarrow AN + AY \overline{AM}$ compose to that given by the pushout of the images of f and g over AY . Thus the diagram represents two $(\mathcal{E}', \mathcal{M}')$ factorisations of the same morphism, and there exists an isomorphism n between the corelations $\square(g) \circ \square(f)$ and $\square(g \circ f)$. This proves that \square preserves composition. \blacksquare

4.3. REMARK. While we have already assumed that $\text{Corel}(\mathcal{C})$ is a category, this first lemma allows us to verify the associativity and unit laws for $\text{Corel}(\mathcal{C})$. Consider the case of Proposition 4.1 with $\mathcal{C} = \mathcal{C}'$, $(\mathcal{E}, \mathcal{M}) = (\mathcal{C}, \mathcal{I}_{\mathcal{C}})$, and $A = 1_{\mathcal{C}}$. Then the domain of \square is $\text{Cospan}(\mathcal{C})$ by definition. (Indeed, \square is the functor of Proposition 2.11 mapping a cospan to its \mathcal{E} -part.) In this case, the function $\square: \text{Cospan}(\mathcal{C}) \rightarrow \text{Corel}(\mathcal{C})$ is bijective-on-objects and surjective-on-morphisms. Thus to compute the composite of any two corelations, we may consider them as cospans, compute their composite *as cospans*, and then take the \mathcal{E} -part of the result. Since composition of cospans is associative and unital, so is composition of corelations, with the identity corelation just the image of the identity cospan.

This first lemma is useful in proving an second important lemma: the naturality of $\overline{\kappa}$.

4.4. LEMMA. *The maps $\overline{\kappa}_{X,Y}$, as defined in Proposition 4.1, are natural.*

PROOF. Let $f = (X \rightarrow N \leftarrow Y)$, $g = (Z \rightarrow M \leftarrow W)$ be corelations in \mathcal{C} . We wish to show that

$$\begin{array}{ccc} AX + AY & \xrightarrow{\square(f)+\square(g)} & AZ + AW \\ \overline{\kappa}_{X,Y} \downarrow & & \downarrow \overline{\kappa}_{Z,W} \\ A(X + Y) & \xrightarrow{\square(f+g)} & A(Z + W) \end{array}$$

commutes in $\text{Corel}(\mathcal{C}')$.

Consider the following commutative diagram in \mathcal{C}' , with the outside square equivalent to the naturality square for the coherence maps of the monoidal functor $\text{Cospan}(\mathcal{C}) \rightarrow \text{Cospan}(\mathcal{C}')$:

$$\begin{array}{ccccc} (AX + AY) + (AZ + AW) & \xrightarrow{\mathcal{E}' + \mathcal{E}'} & \overline{AN} + \overline{AM} & \xrightarrow{\mathcal{M}' + \mathcal{M}'} & AN + AM \\ \downarrow \kappa_{X,Y} + \kappa_{Z,W} & & \downarrow p & & \downarrow \kappa_{N,M} \\ A(X + Y) + A(Z + W) & \xrightarrow{\mathcal{E}'} & \overline{A(N + M)} & \xrightarrow{\mathcal{M}'} & A(N + M) \end{array} \quad (\#)$$

We have factored the top edge as the coproduct of the respective factorisations of f and g , and the bottom edge simply as the factorisation of the coproduct $f + g$.

Note that by Lemma 3.2 the coproduct of two maps in \mathcal{E}' is again in \mathcal{E}' , while Lemma 3.3 implies the same for \mathcal{M}' . Thus the top edge is an $(\mathcal{E}', \mathcal{M}')$ -factorisation, and the uniqueness of factorisations gives the isomorphism n . Given that the map reducing cospans to corelations is functorial, the commutative square

$$\begin{array}{ccc} (AX + AY) + A(Z + W) & \xrightarrow{1 + \kappa_{Z,W}^{-1}} & (AX + AY) + (AZ + AW) \xrightarrow{\mathcal{E}' + \mathcal{E}'} \overline{AN} + \overline{AM} \\ \parallel & & \downarrow n \\ (AX + AY) + A(Z + W) & \xrightarrow{\kappa_{X,Y} + 1} & A(X + Y) + A(Z + W) \xrightarrow{\mathcal{E}'} \overline{A(N + M)} \end{array}$$

then implies the naturality of the maps $\overline{\kappa}$. ■

These lemmas now imply that $\text{Corel}(\mathcal{C})$ is a well-defined hypergraph category.

PROOF OF THEOREM 3.1. To complete the proof, consider again the case of Proposition 4.1 with $\mathcal{C} = \mathcal{C}'$, $(\mathcal{E}, \mathcal{M}) = (\mathcal{C}, \mathcal{I}_{\mathcal{C}})$, and $A = 1_{\mathcal{C}}$. Note that by definition this function maps the coherence and hypergraph maps of $\text{Cospan}(\mathcal{C})$ onto the corresponding maps of $\text{Corel}(\mathcal{C})$. Then since $\text{Cospan}(\mathcal{C})$ is a hypergraph category, and since \square preserves composition and respects the monoidal and hypergraph structure, $\text{Corel}(\mathcal{C})$ is also a hypergraph category.

For instance, suppose we want to check the functoriality of the monoidal product $+$. We then wish to show $(g \circ f) + (k \circ h) = (g + k) \circ (f + h)$ for corelations of the appropriate types. But \square preserves composition, and the naturality of κ , here the identity map, implies that for any two cospans the \mathcal{E} -part of their coproduct is equal to the coproduct of their \mathcal{E} -parts. Thus we may compute these two expressions by viewing f, g, h , and k as cospans, evaluating them in the category of cospans, and then taking their \mathcal{E} -parts. Since the equality holds in the category of cospans, it holds in the category of corelations. ■

4.5. **COROLLARY.** *The functor*

$$\square: \text{Cospan}(\mathcal{C}) \longrightarrow \text{Corel}(\mathcal{C}),$$

that takes each object of $\text{Cospan}(\mathcal{C})$ to itself as an object of $\text{Corel}(\mathcal{C})$ and each cospan to its \mathcal{E} -part is a strict hypergraph functor.

Finally, we complete the proof that $\square: \text{Corel}(\mathcal{C}) \rightarrow \text{Corel}(\mathcal{C}')$ is in general a hypergraph functor.

PROOF OF PROPOSITION 4.1. We show \square is a functor, a symmetric monoidal functor, and then finally a hypergraph functor.

Functoriality. First, recall that \square preserves composition (Lemma 4.2). Thus to prove \square is a functor it remains to show identities are mapped to identities. The general idea for this and for similar axioms is to recall that the special maps are given by reduced versions of particular colimits, and that $(\mathcal{E}', \mathcal{M}')$ reduces maps more than $(\mathcal{E}, \mathcal{M})$.

In this case, recall the identity corelation is given by the \mathcal{E} -part $X + X \rightarrow \overline{X}$ of $[1, 1]: X + X \rightarrow X$. Thus the image of the identity on X and the identity on AX are given by the top and bottom rows of the commuting square

$$\begin{array}{ccccccc} A(X + X) & \xrightarrow{\mathcal{E}'} & \overline{A\overline{X}} & \xrightarrow{\mathcal{M}'} & A\overline{X} & \xrightarrow{A\mathcal{M}} & AX \\ \sim \downarrow \kappa^{-1} & & \vdots \downarrow n & & & & \parallel \\ AX + AX & \xrightarrow{\mathcal{E}'} & \overline{AX} & \xrightarrow{\mathcal{M}'} & AX & & AX \end{array}$$

The outside square commutes as we know A maps the identity cospan of \mathcal{C} to the identity cospan of \mathcal{C}' . The top row is the image under A of the identity cospan in \mathcal{C} , factored first in \mathcal{C} , and then in \mathcal{C}' . The bottom row is just the factored identity cospan on AX in \mathcal{C}' . As A maps \mathcal{M} into \mathcal{M}' , the map marked $A\mathcal{M}$ lies in \mathcal{M}' . Thus both rows are $(\mathcal{E}', \mathcal{M}')$ -factorisations, and so we have the isomorphism n . Thus \square preserves identities.

Strong monoidality. We proved in Lemma 4.4 that our proposed coherence maps are natural. The rest of the properties follow from the composition preserving map $\text{Cospan}(\mathcal{C}') \rightarrow \text{Corel}(\mathcal{C}')$. Since the κ obey all the required axioms as cospans, they obey them as corelations too.

Hypergraph structure. The proof of preservation of the hypergraph structure follows the same pattern as the identity maps. ■

4.6. REMARK. On any category \mathcal{C} with finite colimits, reverse inclusions of the right factor \mathcal{M} defines a partial order on the set of costable factorisation systems. That is, we write $(\mathcal{E}, \mathcal{M}) \geq (\mathcal{E}', \mathcal{M}')$ whenever $\mathcal{M} \subseteq \mathcal{M}'$. The trivial factorisation systems $(\mathcal{C}, \mathcal{I}_{\mathcal{C}})$ and $(\mathcal{I}_{\mathcal{C}}, \mathcal{C})$ are the top and bottom elements of this poset respectively.

Corelation categories realise this poset as a subcategory of the category of hypergraph categories. One way to understand this is that corelations are cospans with the \mathcal{M} -part ‘forgotten’. Using the morphism-isomorphism factorisation system nothing is forgotten, so these corelations are just cospans. Using the isomorphism-morphism factorisation system everything is forgotten, so there is a unique corelation between any two objects.

We can construct a hypergraph functor between two corelation categories precisely when the codomain forgets more than the domain: i.e. if the codomain is less than the domain in the poset. In particular, this implies there is always a hypergraph functor from the cospan category $\text{Corel}_{(\mathcal{C}, \mathcal{I}_{\mathcal{C}})}(\mathcal{C}) = \text{Cospan}(\mathcal{C})$ to any other corelation category $\text{Corel}_{(\mathcal{E}, \mathcal{M})}(\mathcal{C})$, and from $\text{Corel}_{(\mathcal{E}, \mathcal{M})}(\mathcal{C})$ any corelation category to the indiscrete category $\text{Corel}_{(\mathcal{I}_{\mathcal{C}}, \mathcal{C})}(\mathcal{C})$ on the objects of \mathcal{C} .

5. Decorated corelations

In this section we define the category of decorated corelations.

Recall that decorating cospans requires more than just choosing a set of decorations for each apex: for composition, we need to describe how these decorations transfer along the copairing of pushout maps $[j_N, j_M]: N+M \rightarrow N+_Y M$. Thus to construct a decorated cospan category we need not merely a function from the objects of \mathcal{C} to Set , but a lax symmetric monoidal functor $(\mathcal{C}, +) \rightarrow (\text{Set}, \times)$.

Similarly, decorating $(\mathcal{E}, \mathcal{M})$ -corelations requires still more information: we now further need to know how to transfer decorations backwards along the morphisms $N+_Y M \xleftarrow{m} N+_Y \overline{M}$. We thus introduce the symmetric monoidal category $\mathcal{C}; \mathcal{M}^{\text{op}}$ with morphisms isomorphism classes of cospans of the form $\xrightarrow{f} \xleftarrow{m}$, where $f \in \mathcal{C}$ and $m \in \mathcal{M}$. For constructing categories of decorated $(\mathcal{E}, \mathcal{M})$ -corelations, we then require a lax symmetric monoidal functor F from $\mathcal{C}; \mathcal{M}^{\text{op}}$ to Set .

To prove that we have indeed defined a hypergraph category of decorated corelations, we will proceed as we did for corelations, using structure-preserving functions from a category already known to be hypergraph. This will hence again be completed in our discussion of functors in the next section.

ADJOINING RIGHT ADJOINTS

Suppose we have a cospan $X + Y \rightarrow N$ with a decoration on N . Reducing this to a corelation requires us to factor this to $X + Y \xrightarrow{e} \overline{N} \xrightarrow{m} N$. To define a category of decorated corelations, then, we must specify how to take decoration on N and ‘pull it back’ along m to a decoration on \overline{N} .

For decorated cospans, it is enough to have a functor F from a category \mathcal{C} with finite colimits; the image Ff of morphisms f in \mathcal{C} describes how to move decorations forward along f . We now want to expand \mathcal{C} to include a morphism m^{op} for each m in \mathcal{M} , so that the image Fm^{op} describes how to move decorations backwards along m . This is allowed by the stability of \mathcal{M} under pushouts.

5.1. PROPOSITION. *Let \mathcal{C} be a category with finite colimits, and let \mathcal{M} be a subcategory of \mathcal{C} stable under pushouts. Then we define the category $\mathcal{C}; \mathcal{M}^{\text{op}}$ as follows*

<i>The symmetric monoidal category $(\mathcal{C}; \mathcal{M}^{\text{op}}, +)$</i>	
<i>objects</i>	<i>the objects of \mathcal{C}</i>
<i>morphisms</i>	<i>isomorphism classes of cospans of the form $\xrightarrow{c} \xleftarrow{m}$, where c lies in \mathcal{C} and m in \mathcal{M}</i>
<i>composition</i>	<i>given by pushout</i>
<i>monoidal product</i>	<i>the coproduct in \mathcal{C}</i>
<i>coherence maps</i>	<i>the coherence maps in \mathcal{C}</i>

PROOF. Our data is well defined: composition because \mathcal{M} is stable under pushouts, and monoidal composition by Lemma 3.3. The coherence laws follow as this is a symmetric monoidal subcategory of $\text{Cospan}(\mathcal{C})$. ■

5.2. REMARK. As we state in the proof, the category $\mathcal{C}; \mathcal{M}^{\text{op}}$ is a subcategory of $\text{Cospan}(\mathcal{C})$. We can in fact view it as a sub-bicategory of the bicategory of cospans in \mathcal{C} , where the 2-morphisms given by maps of cospans. In this bicategory every morphism of \mathcal{M} has a right adjoint.

5.3. EXAMPLES. Note that $\mathcal{C}; \mathcal{C}^{\text{op}}$ is by definition equal to $\text{Cospan}(\mathcal{C})$, $\mathcal{C}; \mathcal{I}_{\mathcal{C}}^{\text{op}}$ is isomorphic to \mathcal{C} , and $\text{Set}; \text{Inj}^{\text{op}}$ is the category with sets as objects and partial functions as morphisms.

The following lemma details how to construct functors between this type of category.

5.4. LEMMA. *Let $\mathcal{C}, \mathcal{C}'$ be categories with finite colimits, and let $\mathcal{M}, \mathcal{M}'$ be subcategories of $\mathcal{C}, \mathcal{C}'$ respectively each stable under pushouts. Let $A: \mathcal{C} \rightarrow \mathcal{C}'$ be functor that preserves colimits and such that the image of \mathcal{M} lies in \mathcal{M}' . Then A extends to a symmetric strong monoidal functor*

$$A: \mathcal{C}; \mathcal{M}^{\text{op}} \longrightarrow \mathcal{C}'; \mathcal{M}'^{\text{op}}.$$

mapping X to AX and $\xrightarrow{c} \xleftarrow{m}$ to $\xrightarrow{Ac} \xleftarrow{Am}$.

PROOF. Note $A(\mathcal{M}) \subseteq \mathcal{M}'$, so $\xrightarrow{Ac} \xleftarrow{Am}$ is indeed a morphism in $\mathcal{C}'; \mathcal{M}'^{\text{op}}$. This is then a restriction and corestriction of the usual functor $\text{Cospan}(\mathcal{C}) \rightarrow \text{Cospan}(\mathcal{C}')$ to the above domain and codomain. ■

Note that a similar construction giving subcategories of cospan categories could be defined more generally using any two isomorphism-containing wide subcategories stable under pushout. The above, however, suffices for decorated corelations.

DECORATED CORELATIONS

As we have said, decorated corelations are constructed from a lax symmetric monoidal functor from $\mathcal{C}; \mathcal{M}^{\text{op}}$ to Set . We now define decorated corelations and give a composition rule for them, showing that this composition rule is well defined up to isomorphism.

5.5. DEFINITION. Let \mathcal{C} be a category with finite colimits, $(\mathcal{E}, \mathcal{M})$ be a costable factorisation system, and

$$F : (\mathcal{C}; \mathcal{M}^{\text{op}}, +) \longrightarrow (\text{Set}, \times)$$

be a lax symmetric monoidal functor. We define an **F -decorated corelation** to a pair

$$\left(\begin{array}{ccc} & N & \\ i \nearrow & & \nwarrow o \\ X & & Y \end{array}, \begin{array}{c} FN \\ \uparrow s \\ 1 \end{array} \right)$$

where the cospan is jointly \mathcal{E} -like. A morphism of decorated corelations is a morphism of decorated cospans between two decorated corelations.

Suppose we have decorated corelations

$$\left(\begin{array}{ccc} & N & \\ i_X \nearrow & & \nwarrow o_Y \\ X & & Y \end{array}, \begin{array}{c} FN \\ \uparrow s \\ 1 \end{array} \right) \quad \text{and} \quad \left(\begin{array}{ccc} & M & \\ i_Y \nearrow & & \nwarrow o_Z \\ Y & & Z \end{array}, \begin{array}{c} FM \\ \uparrow t \\ 1 \end{array} \right).$$

Then, recalling the notation introduced in §2, their composite is given by the composite corelation

$$\begin{array}{ccc} & \overline{N +_Y M} & \\ e \circ i_X \nearrow & & \nwarrow e \circ i_Z \\ X & & Z \end{array}$$

paired with the decoration

$$1 \xrightarrow{\varphi_{N,M} \circ \langle s, t \rangle} F(N + M) \xrightarrow{F[j_N, j_M]} F(N +_Y M) \xrightarrow{F(m^{\text{op}})} F(\overline{N +_Y M}).$$

As composition of corelations and decorated cospans are both well defined up to isomorphism, it is straightforward to show that this too is well defined up to isomorphism.

5.6. PROPOSITION. *The above is a well-defined composition rule on isomorphism classes of decorated corelations.*

PROOF. Let

$$(X \xrightarrow{i_X} N \xleftarrow{o_Y} Y, 1 \xrightarrow{s} FN) \xrightarrow{\sim} (X \xrightarrow{i'_X} N' \xleftarrow{o'_Y} Y, 1 \xrightarrow{s'} FN')$$

and

$$(Y \xrightarrow{i_Y} M \xleftarrow{o_Z} Z, 1 \xrightarrow{t} FM) \xrightarrow{\sim} (Y \xrightarrow{i'_Y} M' \xleftarrow{o'_Z} Z, 1 \xrightarrow{t'} FM')$$

be isomorphisms of decorated corelations. We wish to show that the composite of the decorated corelations on the left is isomorphic to the composite of the decorated corelations on the right.

By definition, the composites of the underlying corelations are isomorphic, via an isomorphism s which exists by the factorisation system. We need to show this s is an isomorphism of decorations. This is a matter of showing the diagram

$$\begin{array}{ccccc} & & F(N +_Y M) & \xrightarrow{Fm^{op}} & F(\overline{N +_Y M}) \\ & \nearrow^{F[j_N, j_M] \circ \varphi_{N, M} \circ \langle s, t \rangle} & \downarrow \sim \scriptstyle{Fp} & & \downarrow \sim \scriptstyle{Fs} \\ 1 & & & & \\ & \searrow_{F[j_{N'}, j_{M'}] \circ \varphi_{N', M'} \circ \langle s', t' \rangle} & F(N' +_Y M') & \xrightarrow{Fm'^{op}} & F(\overline{N' +_Y M'}) \end{array}$$

The triangle commutes as composition of decorated cospans is well defined, while the square commutes as composition of corelations is well defined. \blacksquare

5.7. REMARK. We could give a more general definition of decorated corelation for lax braided monoidal functors

$$(\mathcal{C}; \mathcal{M}^{op}, +) \longrightarrow (\mathcal{D}, \otimes).$$

A similar argument to that in Appendix A shows, however, that we gain no extra generality. On the other hand, keeping track of this possibly varying category \mathcal{D} in the following distracts from the main insights. We thus merely remark that it is possible to make the more general definition, and leave it at that.

CATEGORIES OF DECORATED CORELATIONS

We now define the hypergraph category $FCorel$ of decorated corelations. Having defined decorated corelations and their composition in the previous subsection, the key question to address is the provenance of the monoidal and hypergraph structure.

Recall, from §3, that to define the monoidal and hypergraph structure on categories of corelations, we used functors $\text{Cospan}(\mathcal{C}) \rightarrow \text{Corel}(\mathcal{C})$, leveraging the monoidal and hypergraph structure on cospan categories. In analogy, here we leverage the same fact for decorated cospans, this time using a structure preserving map

$$\square: FCospan \longrightarrow FCorel.$$

Here $FCospan$ denotes the decorated cospan category constructed from the restriction of the functor $F: \mathcal{C}; \mathcal{M}^{op} \rightarrow \text{Set}$ to the domain \mathcal{C} .

The monoidal product of two decorated corelations is their monoidal product as decorated cospans. To define the coherence maps for this monoidal product, as well as the coherence maps, we introduce the notion of a restricted decoration.

Given a cospan $X \rightarrow N \leftarrow Y$, write $m: \overline{N} \rightarrow N$ for the \mathcal{M} factor of the copairing $X + Y \rightarrow N$. The map \square takes a decorated cospan

$$(X \xrightarrow{i} N \xleftarrow{o} Y, 1 \xrightarrow{s} FN)$$

to the decorated corelation

$$(X \xrightarrow{\bar{i}} \overline{N} \xleftarrow{\bar{o}} Y, 1 \xrightarrow{Fm^{op} \circ s} F\overline{N}),$$

where the corelation is given by the jointly \mathcal{E} -part of the cospan, and the decoration is given by composing s with the F -image $Fm^{op}: FN \rightarrow F\overline{N}$ of the map $N \xrightarrow{1_N} N \xleftarrow{m} \overline{N}$ in $\mathcal{C}; \mathcal{M}^{op}$. This is well-defined up to isomorphism of decorated corelations. We call $Fm^{op} \circ s$ the **restricted decoration** of the decoration on the cospan $(X \rightarrow N \leftarrow Y, 1 \xrightarrow{s} FN)$.

We then make the following definition.

5.8. **THEOREM.** *Let \mathcal{C} be a category with finite colimits and a costable factorisation system $(\mathcal{E}, \mathcal{M})$, and let*

$$F: (\mathcal{C}; \mathcal{M}^{op}, +) \longrightarrow (\text{Set}, \times)$$

be a lax symmetric monoidal functor. Then we may define

<i>The hypergraph category $(FCorel, +)$</i>	
<i>objects</i>	<i>the objects of \mathcal{C}</i>
<i>morphisms</i>	<i>isomorphism classes of F-decorated corelations in \mathcal{C}</i>
<i>composition</i>	<i>given by \mathcal{E}-part of pushout with restricted decoration</i>
<i>monoidal product</i>	<i>the coproduct in \mathcal{C}</i>
<i>coherence maps</i>	<i>maps from $\text{Cospan}(\mathcal{C})$ with restricted empty decoration</i>
<i>hypergraph maps</i>	<i>maps from $\text{Cospan}(\mathcal{C})$ with restricted empty decoration</i>

Similar to Theorem 3.1 defining the hypergraph category $\text{Corel}(\mathcal{C})$, we have now specified well-defined data and just need to check a collection of coherence axioms. As before, we prove this in the next section, alongside a theorem regarding functors between decorated corelation categories.

5.9. **REMARK.** Decorated corelations generalise both decorated cospans, and corelations. Decorated cospans are simply decorated corelations with respect to the trivial factorisation system $(\mathcal{C}, \mathcal{I}_{\mathcal{C}})$. ‘Undecorated’ corelations are corelations decorated by the constant symmetric monoidal functor $\{*\}: \mathcal{C}; \mathcal{M}^{op} \rightarrow \text{Set}$ on some terminal object $\{*\}$ of Set .

5.10. **REMARK.** Note that decorated corelations are strictly more general than decorated cospans. For example, the category of epi-mono corelations in Set is not a decorated cospan category.

To see this, we count so-named scalars: morphisms from the monoidal unit \emptyset to itself. In a decorated cospan category, the set of morphisms from X to Y always comprises all decorated cospans $(X \rightarrow N \leftarrow Y, 1 \rightarrow FN)$. Now for any object N in the underlying category \mathcal{C} , there is a unique morphism $\emptyset \rightarrow N$. This means that the morphisms $\emptyset \rightarrow \emptyset$ are indexed by (isomorphism classes of) elements of FN , ranging over N .

Suppose we have a decorated cospan category with a unique morphism $\emptyset \rightarrow \emptyset$. By the previous paragraph, and replacing \mathcal{C} with an equivalent skeletal category, this implies there is only one object N such that FN is nonempty. But FN must always contain at least one element, the empty decoration $1 \xrightarrow{\varphi_I} F\emptyset \xrightarrow{F!} FN$. This implies there is only one object N in \mathcal{C} : the object \emptyset . Thus \mathcal{C} must be the one object discrete category, and $F: \mathcal{C} \rightarrow \text{Set}$ is the functor that sends the object of \mathcal{C} to the one element set 1 .

Hence any decorated cospan category with a unique morphism $\emptyset \rightarrow \emptyset$ is the one object discrete category. But the category of epi-mono corelations in Set is a nontrivial category with a unique morphism $\emptyset \rightarrow \emptyset$. Thus it cannot be constructed as a decorated cospan category.

On the other hand, as far as hypergraph categories are concerned, we need not get more general than decorated corelations: every hypergraph category is equivalent to a decorated corelation category [Fon16].

6. Functors between decorated corelation categories

In this section we show how to construct hypergraph functors between decorated corelation categories. The construction of these functors holds no surprises: their requirements combine the requirements of corelations and decorated cospans. In the process of proving that our construction gives well-defined hypergraph functors, we also complete the necessary prerequisite proof that decorated corelation categories are well-defined hypergraph categories.

Recall that Lemma 5.4 says that, when the image of \mathcal{M} lies in \mathcal{M}' , we can extend a colimit-preserving functor $\mathcal{C} \rightarrow \mathcal{C}'$ to a symmetric monoidal functor $\mathcal{C}; \mathcal{M}^{\text{op}} \rightarrow \mathcal{C}'; \mathcal{M}'^{\text{op}}$.

6.1. **PROPOSITION.** *Let $\mathcal{C}, \mathcal{C}'$ have finite colimits and respective costable factorisation systems $(\mathcal{E}, \mathcal{M}), (\mathcal{E}', \mathcal{M}')$, and suppose that we have lax symmetric monoidal functors*

$$F : (\mathcal{C}; \mathcal{M}^{\text{op}}, +) \longrightarrow (\text{Set}, \times)$$

and

$$G : (\mathcal{C}'; \mathcal{M}'^{\text{op}}, +) \longrightarrow (\text{Set}, \times).$$

Further let $A: \mathcal{C} \rightarrow \mathcal{C}'$ be a functor that preserves finite colimits and such that the image of \mathcal{M} lies in \mathcal{M}' . This functor A extends to a symmetric monoidal functor $\mathcal{C}; \mathcal{M}^{\text{op}} \rightarrow \mathcal{C}'; \mathcal{M}'^{\text{op}}$.

Suppose we have a monoidal natural transformation θ :

$$\begin{array}{ccc} \mathcal{C}; \mathcal{M}^{\text{op}} & & \\ \downarrow A & \begin{array}{c} \nearrow F \\ \Downarrow \theta \\ \searrow G \end{array} & \text{Set} \\ \mathcal{C}'; \mathcal{M}'^{\text{op}} & & \end{array}$$

Then we may define a hypergraph functor $T: FC\text{Corel} \rightarrow GC\text{Corel}$ sending each object $X \in FC\text{Corel}$ to $AX \in GC\text{Corel}$ and each decorated corelation

$$\left(\begin{array}{ccc} & N & \\ i \nearrow & & \nwarrow o \\ X & & Y \end{array}, \quad \begin{array}{c} FN \\ \uparrow s \\ 1 \end{array} \right)$$

to

$$\left(\begin{array}{ccc} & \overline{AN} & \\ e' \circ \iota_{AX} \nearrow & & \nwarrow e' \circ \iota_{AY} \\ AX & & AY \end{array}, \quad \begin{array}{c} \overline{GAN} \\ \uparrow Gm_{AN}^{\text{op}} \\ GAN \\ \uparrow \theta_N \\ FN \\ \uparrow s \\ 1 \end{array} \right)$$

The coherence maps $\overline{\kappa}_{X,Y}$ are given by the coherence maps of A with the restricted empty decoration.

PROOF OF THEOREM 5.8 AND PROPOSITION 6.1. In the proof of Theorem 3.1 and Proposition 4.1 we proved that the map

$$\square: \text{Corel}(\mathcal{C}) \longrightarrow \text{Corel}(\mathcal{C}')$$

preserved composition and had natural coherence maps. Specialising to the case when $\text{Corel}(\mathcal{C}) = \text{Cospan}(\mathcal{C}')$, we saw that this bijective-on-objects, surjective-on-morphisms, composition and monoidal product preserving map proved $\text{Corel}(\mathcal{C}')$ is a hypergraph category, and it immediately followed that \square is a hypergraph functor.

The analogous argument holds here: we simply need to prove

$$\square: FC\text{Corel} \longrightarrow GC\text{Corel}$$

preserves composition and has natural coherence maps. Theorem 5.8 then follows from examining the map $FC\text{Cospan} \rightarrow FC\text{Corel}$ obtained by choosing $\mathcal{C} = \mathcal{C}'$, $(\mathcal{E}, \mathcal{M}) = (\mathcal{C}', \mathcal{I}_{\mathcal{C}'})$, F the restriction of G to \mathcal{C}' , A the identity functor on \mathcal{C}' , and θ the identity natural transformation. Subsequently Proposition 6.1 follows from noting that all the axioms hold for the corresponding maps in $GC\text{Cospan}$.

\square **preserves composition.** Suppose we have decorated corelations

$$f = (X \xrightarrow{i_X} N \xleftarrow{o_Y} Y, 1 \xrightarrow{s} FN) \quad \text{and} \quad g = (Y \xrightarrow{i_Y} M \xleftarrow{o_Y} Z, 1 \xrightarrow{t} FM)$$

We know the functor \square preserves composition on the cospan part; this is precisely the content of Proposition 4.1. It remains to check that $\square(g \circ f)$ and $\square g \circ \square f$ have isomorphic decorations. This is expressed by the commutativity of the following diagram:

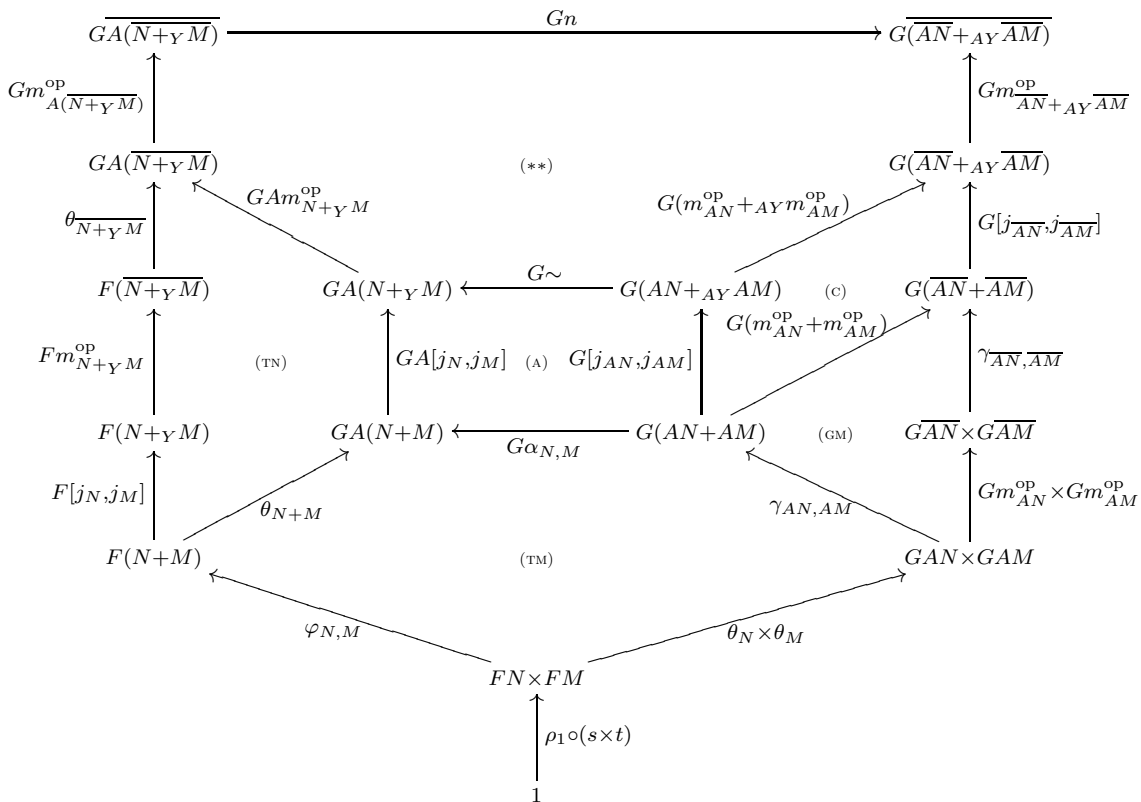

This diagram does indeed commute. To check this, first observe that (TM) commutes by the monoidality of θ , (GM) commutes by the monoidality of G , and (TN) commutes by the naturality of θ . The remaining three diagrams commute as they are G -images of diagrams that commute in \mathcal{C}' ; \mathcal{M}'^{op} . Indeed, (A) commutes since A preserves colimits and G is functorial, (C) commutes as it is the G -image of a pushout square in \mathcal{C}' , so

$$\overleftarrow{m_{AN+m_{AM}}} \xrightarrow{[j_{AN}, j_{AM}]} \quad \text{and} \quad [j_{AN}, j_{AM}] \xrightarrow{m_{AN+AYm_{AM}}}$$

are equal as morphisms of \mathcal{C}' ; \mathcal{M}'^{op} , and (**) commutes as it is the G -image of the right-hand subdiagram of (*) used to define n in the proof of Lemma 4.2.

Coherence maps are natural. Let $f = (X \rightarrow N \leftarrow Y, 1 \rightarrow FN)$, $g = (Z \rightarrow M \leftarrow W, 1 \rightarrow FM)$ be F -decorated corelations in \mathcal{C} . We wish to show that

$$\begin{array}{ccc} AX + AY & \xrightarrow{\square f + \square g} & AZ + AW \\ \overline{\kappa_{X,Y}} \downarrow & & \downarrow \overline{\kappa_{Z,W}} \\ A(X + Y) & \xrightarrow{\square(f+g)} & A(Z + W) \end{array}$$

commutes in $G\text{Corel}$, where the coherence maps are given by

$$\overline{\kappa_{X,Y}} = \left(\begin{array}{ccc} & \overline{A(X + Y)} & \\ & \swarrow \quad \searrow & \\ AX + AY & & A(X + Y) \end{array} , \begin{array}{c} G(\overline{A(X + Y)}) \\ \uparrow Gm_{AX+AY}^{\text{op}} \\ GA(X + Y) \\ \uparrow G! \\ G\emptyset \\ \uparrow \gamma_1 \\ 1 \end{array} \right).$$

Lemma 4.4 shows that the composites of corelations agree. It remains to check that the decorations also agree.

Here Lemma 2.7 is helpful. Since \square is composition preserving, we can replace the $\overline{\kappa}$ with the empty decorated coherence maps κ of $G\text{Cospan}$, and compute these composites in $G\text{Cospan}$, before restricting to the \mathcal{E}' -parts. Lemma 2.7 then implies that the restricted empty decorations on the isomorphisms $\overline{\kappa}$ play no role in determining the composite decorations. It is thus enough to prove that the decorations of $\square f + \square g$ and $\square(f + g)$ are the same up to the isomorphism $p: G(\overline{AN} + \overline{AM}) \rightarrow GA(N + M)$ between their apices, as defined in the diagram (#) in the proof of Lemma 4.4.

This comes down to proving the following diagram commutes:

$$\begin{array}{ccccc} & & GAN \times GAM & \xrightarrow{Gm \times Gm} & G\overline{AN} \times G\overline{AM} & \xrightarrow{\gamma} & G(\overline{AN} + \overline{AM}) \\ & \nearrow \theta & & \searrow \gamma & \text{(G)} & \nearrow G(m+m) & \downarrow \sim Gp \\ 1 \xrightarrow{\langle s,t \rangle} & FN \times FM & & & G(AN + AM) & & \\ & \searrow \varphi & & \downarrow G\kappa & \text{(\#\#)} & & \\ & & F(N + M) & \xrightarrow{\theta} & GA(N + M) & \xrightarrow{Gm} & G\overline{AN} + G\overline{AM} \end{array}$$

This is straightforward to check: (T) commutes by the monoidality of θ , (G) by the monoidality of G , and (\#\#) as it is the G -image of the rightmost square in (#). ■

In particular, we get a hypergraph functor from the category of F -decorated cospans to the category of F -decorated corelations. In applications, this is often the key aspect of constructing ‘black box’ or semantic functors.

6.2. COROLLARY. Let \mathcal{C} be a category with finite colimits, and let $(\mathcal{E}, \mathcal{M})$ be a factorisation system on \mathcal{C} . Suppose that we also have a lax monoidal functor

$$F : (\mathcal{C}; \mathcal{M}^{\text{op}}, +) \longrightarrow (\text{Set}, \times).$$

Then we may define a category $F\text{Corel}$ with objects the objects of \mathcal{C} and morphisms isomorphism classes of F -decorated corelations.

Write also F for the restriction of F to the wide subcategory \mathcal{C} of $\mathcal{C}; \mathcal{M}^{\text{op}}$. We can thus also obtain the category $F\text{Cospan}$ of F -decorated cospans. We moreover have a functor

$$F\text{Cospan} \rightarrow F\text{Corel}$$

which takes each object of $F\text{Cospan}$ to itself as an object of $F\text{Corel}$, and each decorated cospan

$$\left(\begin{array}{ccc} & N & \\ i \nearrow & & \nwarrow o \\ X & & Y \end{array}, \quad \begin{array}{c} FN \\ \uparrow s \\ 1 \end{array} \right)$$

to its jointly \mathcal{E} -part

$$\begin{array}{ccc} & \overline{N} & \\ e\circ\iota_X \nearrow & & \nwarrow e\circ\iota_Y \\ X & & Y \end{array}$$

decorated by the composite

$$1 \xrightarrow{s} FN \xrightarrow{Fm_N^{\text{op}}} F\overline{N}.$$

7. Examples

We give two extended examples. Our first example revisits the matrix example from the introduction, having now developed the material necessary to formalise it. Our second example is to give two constructions for the category of linear relations: first as a corelation category, then as a decorated corelation category.

7.1. MATRICES

Let R be a commutative rig.¹ In this subsection we will construct matrices over R as decorated corelations over $\text{FinSet}^{\text{op}}$.

In $\text{FinSet}^{\text{op}}$ the coproduct is the cartesian product \times of sets, the initial object is the one element set 1 , and cospans are spans in FinSet . The notation will thus be less confusing if we talk of decorated spans on (FinSet, \times) given by the contravariant lax monoidal functor

$$\begin{aligned} R^{(-)} : (\text{FinSet}, \times) &\longrightarrow (\text{Set}, \times); \\ N &\longmapsto R^N \\ (f : N \rightarrow M) &\longmapsto (R^f : R^M \rightarrow R^N; v \mapsto v \circ f). \end{aligned}$$

¹Also known as a semiring, a rig is a ring without negatives.

The coherence maps $\varphi_{N,M}: R^N \times R^M \rightarrow R^{N \times M}$ take a pair (s, t) of maps $s: N \rightarrow R$, $t: M \rightarrow R$ to the pointwise product $s \cdot t: N \times M \rightarrow R$; $(n, m) \mapsto s(n) \cdot t(m)$. The unit coherence map $\varphi_1: 1 \rightarrow R^1$ sends almost tautological: it takes the unique element of the one element set 1 to the function $1 \rightarrow R$ that maps the unique element of the one element set to the multiplicative identity 1_R of the rig R . As described in the introduction, $R^{(-)}\text{Cospan}$ can be considered as the category of ‘multivalued matrices’ over R , and $R^{(-)}\text{Corel}$ the category of matrices over R .

Just as the coherence map φ_1 gives the unit for the multiplication, it is the coherence maps $\varphi_{N,M}$ that enact multiplication of scalars: the composite of decorated spans $(X \xleftarrow{i_X} N \xrightarrow{o_Y} Y, N \xrightarrow{s} R)$ and $(Y \xleftarrow{i_Y} M \xrightarrow{o_Z} Z, M \xrightarrow{t} R)$ is the span $X \leftarrow N \times_Y M \rightarrow Z$ decorated by the map

$$N \times_Y M \hookrightarrow N \times M \xrightarrow{\varphi_{N,M}(s,t)=s \cdot t} R,$$

where the inclusion from $N \times_Y M$ into $N \times M$ is that given by the categorical product. The intuition for this composition rule, in terms of channels between elements of X and those of Z , was discussed in the introduction.

As φ_1 selects the multiplicative unit 1_R of R , the empty decoration on any set N is the function that sends every element of N to 1_R . This implies the identity decorated span on $X = \{x_1, \dots, x_n\}$ is that represented by the diagram

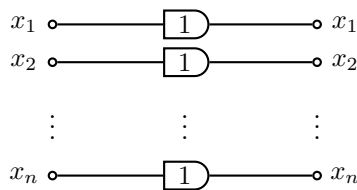

while the Frobenius multiplication and unit are

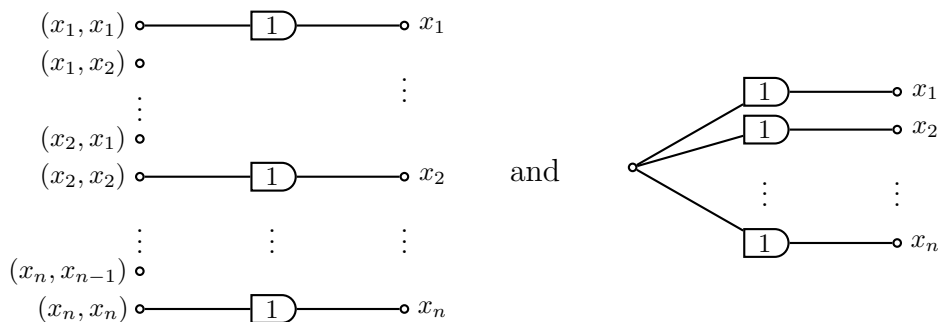

respectively, with the comultiplication and counit the mirror images.

These morphisms are multivalued matrices in the following sense: the cardinalities of the domain X and the codomain Y give the dimensions of the matrix, and the apex N indexes its entries. If $n \in N$ maps to $x \in X$ and $y \in Y$, we say there is an entry of value $s(n) \in \mathbb{R}$ in the x th row and y th column of the matrix. It is multivalued in the sense that there may be multiple entries in any position (x, y) of the matrix.

To construct matrices proper, and not just multivalued matrices, as decorated relations, we extend $R^{(-)}$ to the contravariant functor

$$R^{(-)} : (\text{Span}(\text{FinSet}), \times) \longrightarrow (\text{Set}, \times)$$

mapping now a span $N \xleftarrow{f} A \xrightarrow{g} M$ to the function

$$\begin{aligned} R^{f \circ p; g} : R^M &\longrightarrow R^N; \\ v &\longmapsto \left(n \mapsto \sum_{a \in f^{-1}(n)} v \circ g(a) \right). \end{aligned}$$

It is simply a matter of computation to check this is functorial.

Decorated corelations in this category then comprise trivial spans $X \xleftarrow{\pi_X} X \times Y \xrightarrow{\pi_Y} Y$, where π is the projection given by the categorical product, together with a decoration $X \times Y \rightarrow R$. Such morphisms give a value of R for each pair $(x, y) \in X \times Y$, and thus are trivially in one-to-one correspondence with $|X| \times |Y|$ -matrices.

The map $R^{(-)}\text{Cospan} \rightarrow R^{(-)}\text{Corel}$ transports the decoration $N \times_Y M \rightarrow R$ along the function $N \times_Y M \rightarrow N \times M$ that identifies elements over the same pair (x, y) . In terms of the multivalued matrices, this sums over (the potentially empty) set of entries over (x, y) to create a single entry. It is thus easily observed that composition in this category is matrix multiplication. Moreover, it is not difficult to check that the monoidal product is the Kroenecker product of matrices, and thus that $R^{(-)}\text{Corel}$ is monoidally equivalent to the monoidal category of $(\text{FinVect}, \otimes)$ of finite dimensional vector spaces, linear maps, and the tensor product.

Note that R^X is always an R -module, and R^f a homomorphism of R -modules. Thus we could take decorations here in the category $R\text{Mod}$ of R -modules, rather than the category Set . While Proposition A.1 shows that the resulting decorated cospan and corelation categories would be isomorphic, this hints at an enriched version of the theory.

7.2. TWO CONSTRUCTIONS FOR LINEAR RELATIONS

We give two constructions for the category of linear relations: first as a category of epi-mono corelations in the category of linear maps, and second as isomorphism-morphism corelations in the category sets decorated by linear subspaces.

Recall that a linear relation $L: U \rightsquigarrow V$ is a subspace $L \subseteq U \oplus V$, where U, V are vector spaces. We compose linear relations as we do relations, and vector spaces and linear relations form a category LinRel . It is straightforward to show that this category can be constructed as the category of relations in the category Vect of vector spaces and linear maps with respect to epi-mono factorisations: monos in Vect are simply injective linear maps, and hence subspace inclusions. We show that they may also be constructed as corelations in Vect with respect to epi-mono factorisations.

If we restrict to the full subcategory FinVect of finite dimensional vector spaces duality makes this easy to see: after picking a basis for each vector space the transpose yields an equivalence of FinVect with its opposite category, so the category of $(\mathcal{E}, \mathcal{M})$ -corelations

(jointly epic cospans) is isomorphic to the category of $(\mathcal{E}, \mathcal{M})$ -relations (jointly monic spans) in FinVect . This fact has been fundamental in work on finite dimensional linear systems and signal flow diagrams [BE15, BSZ14, BSZ16].

We prove the general case in detail. To begin, note Vect has an epi-mono factorisation system with monos stable under pushouts. This factorisation system is inherited from Set : the epimorphisms in Vect are precisely the surjective linear maps, the monomorphisms are the injective linear maps, and the image of a linear map is always a subspace of the codomain, and so itself a vector space. Monos are stable under pushout as the pushout of a diagram $V \xleftarrow{f} U \xrightarrow{m} W$ is $V \oplus W/\text{Im}[f - m]$. The map $m': V \rightarrow V \oplus W/\text{Im}[f - m]$ into the pushout has kernel $f(\ker m)$. Thus when m is a monomorphism, m' is too.

Thus we have a category of corelations $\text{Corel}(\text{Vect})$. We show that the map $\text{Corel}(\text{Vect}) \rightarrow \text{LinRel}$ sending each vector space to itself and each corelation

$$U \xrightarrow{f} A \xleftarrow{g} V$$

to the linear subspace $\ker[f - g]$ is a full, faithful, and bijective-on-objects functor.

Indeed, corelations $U \xrightarrow{f} A \xleftarrow{g} V$ are in one-to-one correspondence with surjective linear maps $U \oplus V \rightarrow A$, which are in turn, by the isomorphism theorem, in one-to-one correspondence with subspaces of $U \oplus V$. These correspondences are described by the kernel construction above. Thus our map is evidently full, faithful, and bijective-on-objects. It also maps identities to identities. It remains to check that it preserves composition.

Suppose we have corelations $U \xrightarrow{f} A \xleftarrow{g} V$ and $V \xrightarrow{h} B \xleftarrow{\ell} W$. Then their pushout is given by $P = A \oplus B/\text{Im}[g - h]$, and we may draw the pushout diagram

$$\begin{array}{ccccc}
 U & & V & & W \\
 \searrow f & & \swarrow g & & \swarrow h \\
 & A & & B & \\
 & \swarrow \iota_A & \hat{\wedge} & \swarrow \iota_B & \\
 & & P & &
 \end{array}$$

We wish to show the equality of relations

$$\ker[f - g]; \ker[h - \ell] = \ker[\iota_A f - \iota_B \ell].$$

Now $(\mathbf{u}, \mathbf{w}) \in U \oplus W$ lies in the composite relation $\ker[f - g]; \ker[h - \ell]$ if and only if there exists $\mathbf{v} \in V$ such that $f\mathbf{u} = g\mathbf{v}$ and $h\mathbf{v} = \ell\mathbf{w}$. But as P is the pushout, this is true if and only if

$$\iota_A f\mathbf{u} = \iota_A g\mathbf{v} = \iota_B h\mathbf{v} = \iota_B \ell\mathbf{w}.$$

This in turn is true if and only if $(\mathbf{u}, \mathbf{w}) \in \ker[\iota_A f - \iota_B \ell]$, as required.

This correlational perspective is important as it fits the relational picture into our philosophy of black boxing. Work by Baez and Erbele, and Bonchi, Sobociński and

Zanasi shows that LinRel models controllable linear time-invariant dynamical systems [BE15, BSZ14, BSZ16]. In [FRS16], however, it is shown that it is the construction of LinRel as corelations, rather than relations, that correctly generalises to the case of non-controllable systems.

Finally, we give a decorated corelations construction for LinRel . For simplicity, we consider just the finite dimensional case. That is, let LinRel be the category with finite dimensional k -vector spaces as objects, and linear relations as morphisms. We have just seen that this category is a hypergraph category. Since $\text{Cospan}(\text{FinSet})$ is the theory of special commutative Frobenius monoids [Lac04], there exists a hypergraph functor $\text{Cospan}(\text{FinSet}) \rightarrow \text{LinRel}$ sending the finite set 1 to the 1-dimensional vector space k . Also, it is straightforward to check that the covariant hom functor on the monoidal unit of a symmetric monoidal category is a lax symmetric monoidal functor; we thus get a functor $\text{LinRel}(0, -) : \text{LinRel} \rightarrow \text{Set}$.

Composing these, we have a lax symmetric monoidal functor

$$\text{Lin} : (\text{Cospan}(\text{FinSet}), +) \longrightarrow (\text{Set}, \times).$$

This functor takes a finite set N to the set $\text{Lin}(N)$ of linear subspaces of the vector space k^N . Moreover, the image $\text{Lin}(f)$ of a function $f : N \rightarrow M$ maps a subspace $L \subseteq k^N$ to $\{v \mid v \circ f \in L\} \subseteq k^M$, while the image $\text{Lin}(f^{\text{op}})$ of an opposite function $g^{\text{op}} : N \rightarrow M$ maps a subspace $L \subseteq k^N$ to $\{v = u \circ g \mid u \in L\} \subseteq k^M$.

We thus get a decorated cospan category LinCospan , and a decorated corelation category LinCorel . The former, LinCospan , has as morphisms cospans $X \rightarrow N \leftarrow Y$ of finite sets decorated by a subspace of k^N . For the latter, note that we take corelations with respect to the isomorphism-morphism factorisation system $(\mathcal{I}_{\text{FinSet}}, \text{FinSet})$. This means that there is a unique corelation between any two objects; a representative is simply the cospan $X \rightarrow X + Y \leftarrow Y$ given by the coproduct inclusions. Thus morphisms from X to Y in LinCorel are simply subspaces of $k^{X+Y} \cong k^X \oplus k^Y$ —that is, linear relations $k^X \rightsquigarrow k^Y$. It is straightforward to check that composition in LinCorel is simply relational composition. Thus we have given a decorated corelation construction for LinRel .

In fact, this method of arriving at a decorated corelation construction applies to any hypergraph category. The existence of a decorated corelation construction is useful for the construction of hypergraph functors to and from the category: it allows such functors to be constructed as decorated corelation functors, and hence by exhibiting certain natural transformations.

In this particular case, the decorated corelation construction for linear relations is useful for solving the problem alluded to in the introduction: constructing semantic functors for electric circuits. Recall that open circuits themselves have a readily available decorated cospan construction using the functor $\text{Circ} : \text{FinSet} \rightarrow \text{Set}$ that maps a finite set N to the set of circuit diagrams on N . Constructing a hypergraph functor from the resulting decorated cospan category of circuit diagrams to LinRel is then simply a matter of finding a monoidal natural transformation from Circ to $\text{Lin} \circ \gamma$, where $\gamma : \text{FinSet} \rightarrow \text{Cospan}(\text{FinSet})$ is the standard inclusion. This is explored in depth in [BF, Fon16].

A. Appendix

Decorations in Set are general. The following observation is due to Sam Staton.

A.1. PROPOSITION. *Let $F: (\mathcal{C}, +) \rightarrow (\mathcal{D}, \otimes)$ be a braided lax monoidal functor. Write $\mathcal{D}(I, -): (\mathcal{D}, \otimes) \rightarrow (\text{Set}, \times)$ for the hom functor taking each object $X \in \mathcal{D}$ to the homset $\mathcal{D}(I, X)$. Then $FCospan$ and $\mathcal{D}(I, F-)$ Cospan are isomorphic as hypergraph categories.*

PROOF. Note that the hom functor from the monoidal unit is always lax braided monoidal. We have the commutative-by-definition triangle of braided lax monoidal functors

$$\begin{array}{ccc}
 & & (\mathcal{D}, \otimes) \\
 & \nearrow F & \downarrow \mathcal{D}(I, -) \\
 (\mathcal{C}, +) & & (\text{Set}, \times) \\
 & \searrow \mathcal{D}(I, F-) &
 \end{array}$$

By Theorem 4.1 of [Fon15], this gives rise to a strict hypergraph functor $FCospan \rightarrow \mathcal{D}(I, F-)$ Cospan. It is easily checked that this functor is bijective-on-objects, full, and faithful. ■

References

- [BE15] J. C. Baez and J. Erbele. Categories in control. *Theory and Applications of Categories*, 30(24):836–881, 2015. Available at <http://www.tac.mta.ca/tac/volumes/30/24/30-24abs.html>. (Referred to on page 32, 33.)
- [BF] J. C. Baez and B. Fong. A compositional framework for passive linear networks. Preprint. [arXiv:1504.05625](https://arxiv.org/abs/1504.05625). (Referred to on page 33.)
- [BSZ14] F. Bonchi, P. Sobociński, and F. Zanasi. A categorical semantics of signal flow graphs. In P. Baldan and D. Gorla, eds., *CONCUR 2014: Concurrency Theory*, Lecture Notes in Computer Science, 8704:435–450, 2014. (Referred to on page 32, 33.)
- [BSZ16] F. Bonchi, P. Sobociński, and F. Zanasi. Interacting Hopf algebras. *Journal of Pure and Applied Algebra*, 2016. doi:10.1016/j.jpaa.2016.06.002 (Referred to on page 32, 33.)
- [Car91] A. Carboni. Matrices, relations and group representations. *Journal of Algebra*, 138(2):497–529, 1991. (Referred to on page 8.)
- [CF17] B. Coxa and B. Fong. Corelations are the prop for extraspecial commutative Frobenius monoids. *Theory and Applications of Categories*, 32(11):380–395, 2017. Available at <http://www.tac.mta.ca/tac/volumes/32/11/32-11abs.html>. (Referred to on page 13.)

- [Fon15] B. Fong. Decorated Cospans. *Theory and Applications of Categories*, 30(33):25–50, 2015. Available at <http://www.tac.mta.ca/tac/volumes/30/33/30-33abs.html>. (Referred to on page 2, 7, 10, 11, 34.)
- [Fon16] B. Fong *The Algebra of Open and Interconnected Systems*. DPhil thesis, University of Oxford, 2016. (Referred to on page 7, 25, 33.)
- [FRS16] B. Fong, P. Rapisarda and P. Sobocinski. A categorical approach to open and interconnected dynamical systems. In *Proceedings of the 31st Annual ACM/IEEE Symposium on Logic in Computer Science (LICS '16)*, ACM, New York, NY, USA, 495–504, 2016. doi:10.1145/2933575.2934556 (Referred to on page 33.)
- [JW00] R. Jayawardene and O. Wyler. Categories of relations and functional relations. *Applied Categorical Structures* 8(1):279–305, 2000. (Referred to on page 13.)
- [JS91] A. Joyal and R. Street. The geometry of tensor calculus I. *Advances in Mathematics* 88(1):55–112, 1991. doi:10.1016/0001-8708(91)90003-P. (Referred to on page 7.)
- [Lac11] S. Lack. An embedding theorem for adhesive categories. *Theory and Applications of Categories*, 25(7)180–188, 2011. Available at <http://www.tac.mta.ca/tac/volumes/25/7/25-07abs.html>. (Referred to on page 14.)
- [Lac04] S. Lack. Composing PROPs. *Theory and Applications of Categories*, 13(9):147–163, 2004. Available at <http://www.tac.mta.ca/tac/volumes/13/9/13-09abs.html> (Referred to on page 33.)
- [LS04] S. Lack and P. Sobociński. Adhesive categories. In *Foundations of Software Science and Computation Structures*, LNCS 2987:273–288, Springer, Berlin, 2004. (Referred to on page 14.)
- [LS06] S. Lack and P. Sobociński. Toposes are adhesive. In *Graph Transformations*, LNCS 4178:184–198, Springer, Berlin, 2006. (Referred to on page 14.)
- [Mil00] S. Milius. *Relations in Categories*. MA thesis, York University, Ontario, 2000. (Referred to on page 11.)
- [RSW08] R. Rosebrugh, N. Sabadini, and R. F. C. Walters. Calculating colimits compositionally. In P. Degano *et al.*, *Montanari Festschrift*, LNCS, 5065:581–592. Springer–Verlag, Berlin Heidelberg, 2008. (Referred to on page 9.)

*Department of Electrical and Systems Engineering
University of Pennsylvania
United States of America*

Email: fo@seas.upenn.edu