

Noise cross-correlation and Cooper pair splitting efficiency in multi-terminal superconductor junctions.

J.A. Celis Gil^{a,b}, S. Gomez P.^{b,c}, William J. Herrera^b

^a*Kavli Institute of Nanoscience, Delft University of Technology, Delft, The Netherlands*

^b*Departamento de Física, Universidad Nacional de Colombia, Bogotá, Colombia*

^c*Departamento de Física, Universidad El Bosque, Bogotá, Colombia*

Abstract

We analyze the non-local shot noise in a multi-terminal junction formed by two Normal metal leads connected to one superconductor. Using the cross Fano factor and the shot noise, we calculate the efficiency of the Cooper pair splitting. The method is applied to d -wave and iron based superconductors. We determine that the contributions to the noise cross-correlation are due to crossed Andreev reflections (CAR), elastic cotunneling, quasiparticles transmission and local Andreev reflections. In the tunneling limit, the CAR contribute positively to the noise cross-correlation whereas the other processes contribute negatively. Depending on the pair potential symmetry, the CAR are the dominant processes, giving as a result a high efficiency for Cooper pair split. We propose the use of the Fano factor to test the efficiency of a Cooper pair splitter device.

Keywords: Superconductivity, Pairing symmetries, Iron Pnictides, Andreev reflection, SN junctions, Nanostructures, Nanocontacts.

1. Introduction

Entanglement states between photons have been very well developed [1]. However, entanglement between electrons in solid system is difficult to create because the electrons are immersed in a macroscopic ground state, which prevents the straightforward generation of entangled pairs of electrons.

The use of a superconductor to produce entangled electrons has been proposed [2–8] because its ground state is composed of Cooper pairs. A Cooper pair in the superconductor can be break up into two nonlocal entangled electrons that enter into different normal metal leads via the Cooper pair splitting (CPS) [9–13]. The CPS has been studied theoretically and experimentally [14–18], opening a door to test Bell inequalities in the solid state [19, 20].

The Cooper pair splitting process is analog to CAR, where an incoming electron from one of the leads is reflected as a hole in the other one, inducing

a Cooper pair in the superconductor. Typically, to analyze the CAR, the electrical current has been used to test the Bell inequalities; it is important to analyze not only the currents through every lead, but also the correlations between them, which can be determined through the noise.

According to its origin, the noise is classified into two types: one due to thermal fluctuations, which is known as Nyquist-Johnson noise [21], and the other due to the discrete behavior of the electric charge, known as shot noise [22]. It is possible to obtain with shot noise measurements information not commonly obtained with conductance measurements. In high T_C superconductors, the shot noise has been studied for plain junctions where shot noise is affected by the pair potential symmetry [23, 24].

The nonlocal shot noise or noise cross-correlation between two electrodes connected to a superconductor reveals a change of the sign in the correlation between currents [25–27]. For example, for two electrodes connected to a normal metal, the nonlocal shot noise shows a negative crossed correlation, which indicates that when the electrical current in one lead increases, the current in the other lead

Email address: jherreraw@unal.edu.co (William J. Herrera)

decreases [28–30]. However the nonlocal shot noise for two leads connected to a superconductor can exhibit positive values [31, 32] that is, the electrical current in the two leads could increase or decrease at the same time.

The noise cross-correlation has been studied for two quantum point leads connected to a superconductor [33–38]; nevertheless, the nonlocal shot noise has not been studied for two electrodes connected to d -wave or iron based superconductors, where the pair potential symmetry can affect the transport properties of the system. In the present paper we show an analytic approach that allows us to find the current-current correlation and separate the contributions due to the different processes. In particular we analyze the Cooper pair split contribution. For this, we use the Hamiltonian approach and the non-equilibrium Green functions in Keldysh formalism. We consider typical pair potential symmetries for cuprates and iron based superconductors which means d , s_{++} and s_{+-} symmetries [39–46]. In addition, we consider a s -wave compound added to the d -wave superconductors, thus we study how the magnitude and phase of the pair potential affect the noise cross-correlation. We analyze the symmetric case when the two leads are connected to the same voltage ($V_a = V_b = V$) and the non-symmetric case when the two leads are connected to a voltage difference V ($V_a = 0, V_b = V$). We find that the positive noise cross-correlation is favored by symmetric applied voltages.

2. Shot noise cross-correlation

The system considered is formed by two one-dimensional normal metal leads connected to a semi-infinite superconducting region Fig. (1). The lead $a(b)$ is connected to voltage $V_{a(b)}$, while the superconductor is grounded. It has been demonstrated that there are two processes that contribute to the cross conductance; the CAR and the elastic cotunneling (EC) [47], see Fig. 2. When the $V_a = 0$ and $V_b = V$ the nonlocal differential conductance is given by

$$\sigma_{ab} = \frac{dI_a}{dV_b} = \frac{2e^2}{h} (T_{CAR} - T_{EC}), \quad (1)$$

where T_{CAR} and T_{EC} are the transmission coefficients of the CAR and EC respectively and that can be written in terms of the Green function as

$$T_{CAR} = 4t^4 |\check{G}_{ab,eh}^r(E)|^2, \quad (2)$$

$$T_{EC} = 4t^4 |\check{G}_{ab,ee}^r(E)|^2, \quad (3)$$

where t is the hopping parameter coupling the leads and the superconductor, $\check{G}_{ab}^r(E)$ is the nonlocal green function in the superconducting region between a and b , the subindex $ee(h)$ denotes the electron-electron (hole) component. The contributions of T_{CAR} and T_{EC} processes decrease when the distance between the leads increases and depend on the symmetry of the pair potential [47].

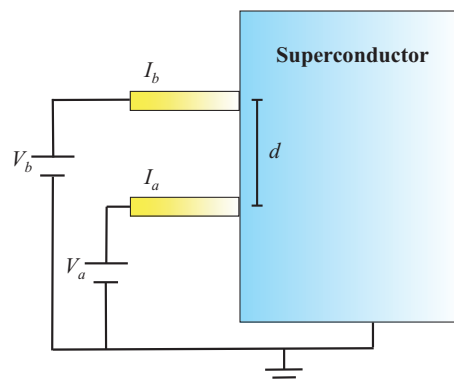

Fig. 1. Diagram of two electrodes $a(b)$ separated by a distance d and connected to a superconductor. The superconductor is grounded and the leads are at voltages V_a and V_b respectively.

Our aim is to obtain the noise cross-correlations and the Fano factor. For s -wave superconductors, the nonlocal shot noise has been calculated [32], showing that, whereas the CAR contribute positively to the crossed correlation between the currents in the two leads [48–50], the EC contributes negatively [51]. Local processes like the Andreev reflections (AR) and quasiparticles transmission (Q) contribute negatively to the nonlocal shot noise (see Fig. 2). Whereas the AR are equivalent to Cooper pair tunneling in one lead, the CAR are equivalent to CPS [52, 53]; hence, we are interested in analyzing the positive contributions to the nonlocal shot noise (see Fig. 3).

We use the Hamiltonian approach to study this system and the Green functions, and Keldysh formalism [54] in order to find the nonlocal shot noise between the leads β and β' at frequency ω (for details see appendix A),

$$S_{\beta\beta'}(\omega) = \frac{2e^2 t^4}{h} \int dE [K_{\beta\beta'}(E, \varepsilon)] \quad (4)$$

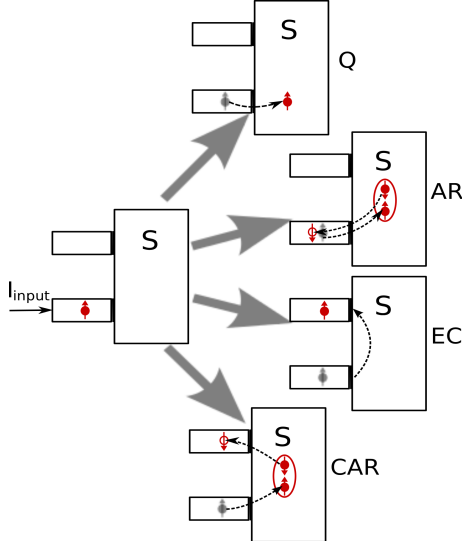

Fig. 2. Diagram of the different processes considered. An incoming electron from a lead could be: transmitted as a quasiparticle (Q); reflected as a hole in the same lead inducing a Cooper pair in the superconductor (AR); reflected as an electron in the other lead (EC); or reflected as a hole in the other lead inducing a Cooper pair in the superconductor (CAR).

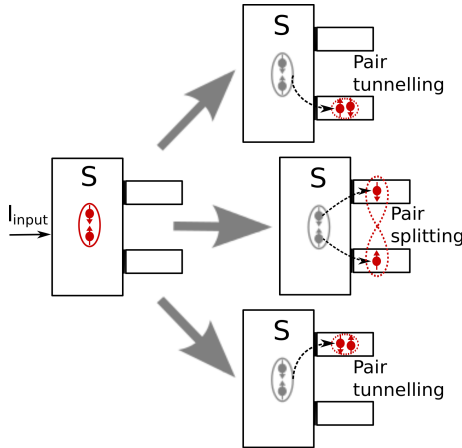

Fig. 3. Basic transport processes in a Cooper pair splitter: the electrons of a Cooper pair either leave the superconductor into the same arm (pair tunnelling) or split up into different arms (pair splitting).

$$+K_{\beta'\beta}(\varepsilon, E)],$$

where

$$\varepsilon = E + \hbar\omega.$$

The kernel $K_{\beta\beta'}(E, \varepsilon)$ can be rewritten as

$$K_{\beta\beta'}(E, \varepsilon) = K_{\beta\beta'}^1(E, \varepsilon) + K_{\beta\beta'}^2(E, \varepsilon) + K_{\beta\beta'}^3(E, \varepsilon) + K_{\beta\beta'}^4(E, \varepsilon), \quad (5)$$

where

$$K_{\beta\beta'}^1(E, \varepsilon) = 4\pi^2(1 - f(\varepsilon))\text{Tr} [\check{N}_\beta \check{A}_L(E) \check{f}_L(E) \check{\rho}_L(E) \check{q}_{\beta'}^1(E, \varepsilon) \check{\rho}_R(\varepsilon) \check{A}_R^\dagger(\varepsilon)],$$

$$K_{\beta\beta'}^2(E, \varepsilon) = 4\pi^2 f(E)(1 - f(\varepsilon))\text{Tr} [\check{N}_\beta \check{G}_{LL}^r(E) \check{\rho}_R(E) \check{q}_{\beta'}^2(E, \varepsilon) \check{\rho}_R(\varepsilon) \check{A}_R^\dagger(\varepsilon)],$$

$$K_{\beta\beta'}^3(E, \varepsilon) = 4\pi^2 \text{Tr} [\check{N}_\beta \check{A}_L(E) \check{f}_L(E) \check{\rho}_L(E) \check{q}_{\beta'}^3(E, \varepsilon) (1 - \check{f}_L(\varepsilon)) \check{\rho}_L(E) \check{p} \check{G}_{RR}^a(\varepsilon)], \quad (6)$$

$$K_{\beta\beta'}^4(E, \varepsilon) = 4\pi^2 f(E) \text{Tr} [\check{N}_\beta \check{G}_{LL}^r(E) \check{\rho}_R(E) \check{q}_{\beta'}^4(E, \varepsilon) (1 - \check{f}_L(\varepsilon)) \check{\rho}_L(E) \check{p} \check{G}_{RR}^a(\varepsilon)],$$

with

$$\check{q}_{\beta'}^1(E, \varepsilon) = \check{A}_L^\dagger(E) \check{N}_{\beta'} \check{A}_R(\varepsilon) - \check{p} \check{G}_{RR}^a(E) \check{N}_{\beta'} \check{G}_{LL}^r(\varepsilon) \check{p}, \quad (7)$$

$$\check{q}_{\beta'}^2(E, \varepsilon) = \check{p} \check{G}_{LL}^a(E) \check{N}_{\beta'} \check{A}_R(\varepsilon) - \check{A}_R^\dagger(E) \check{N}_{\beta'} \check{G}_{LL}^r(\varepsilon) \check{p}, \quad (8)$$

$$\check{q}_{\beta'}^3(E, \varepsilon) = \check{A}_L^\dagger(E) \check{N}_{\beta'} \check{G}_{RR}^r(\varepsilon) \check{p} - \check{p} \check{G}_{RR}^a(E) \check{N}_{\beta'} \check{A}_L(\varepsilon), \quad (9)$$

$$\check{q}_{\beta'}^4(E, \varepsilon) = \check{p} \check{G}_{LL}^a(E) \check{N}_{\beta'} \check{G}_{RR}^r(E) \check{p} - \check{A}_R^\dagger(E) \check{N}_{\beta'} \check{A}_L(\varepsilon), \quad (10)$$

$$\check{A}_L(E) = \check{I} + \check{G}_{LR}^r(E) \check{p}, \quad (11)$$

$$\check{A}_R(E) = \check{I} + \check{G}_{RL}^r(E) \check{p}. \quad (12)$$

In this equations, \check{G}_{ij}^r is the retarded Green function between the region i and j in Nambu \otimes electrodes space, the subindex L denotes the "left" region of leads and the subindex R the right superconducting region, $\check{\rho}_i$ is the local density of states,

$\check{\rho}_i = -\text{Im}(\check{g}_{ii}^r)/\pi$, with \check{g}_{ii} the unperturbed Green function, $\check{p} = t * \check{\sigma}_z$ is the hopping matrix, and

$$\begin{aligned}\check{N}_a &= \begin{pmatrix} \hat{I} & \hat{0} \\ \hat{0} & \hat{0} \end{pmatrix}, \check{N}_b = \begin{pmatrix} \hat{0} & \hat{0} \\ \hat{0} & \hat{I} \end{pmatrix}, \\ \check{\sigma}_z &= \begin{pmatrix} \hat{\sigma}_z & \hat{0} \\ \hat{0} & \hat{\sigma}_z \end{pmatrix}, \\ \check{f}_L &= \begin{pmatrix} \hat{f}_{La} & \hat{0} \\ \hat{0} & \hat{f}_{Lb} \end{pmatrix}, \\ \hat{f}_{L\beta} &= \begin{pmatrix} f_{e\beta} & \hat{0} \\ \hat{0} & f_{h\beta} \end{pmatrix},\end{aligned}\quad (13)$$

with $f_{e\beta} = f(E - eV_\beta)$, $f_{h\beta} = f(E + eV_\beta)$ the Fermi distributions for electron and hole like quasiparticles at the lead β . Each kernel $K_{\beta\beta'}^\alpha$ describes a process that contributes to the electrical current fluctuations and can be classified according to its origin (6). The kernel $K_{\beta\beta'}^1(E, \varepsilon)$ can be interpreted as the dispersion of particles injected from the β lead to the superconductor, where the product $(1 - f(\varepsilon))\check{f}_L(E)$ relates the electron transmission from the left side to the superconductor. Similarly in $K_{\beta\beta'}^4(E, \varepsilon)$ the product $f(E)(1 - \check{f}_L(\varepsilon))$ can be interpreted as the dispersion of particles from the superconductor to the β lead. The $K_{\beta\beta'}^2(E, \varepsilon)$ term corresponds to the quasiparticles dispersion and the product $f(E)(1 - f(\varepsilon))$ is related with thermal fluctuations; and finally in $K_{\beta\beta'}^3(E, \varepsilon)$ the product $\check{f}_L(E)\check{\rho}_L(E)\check{q}_{\beta'}^3(E, \varepsilon)(1 - \check{f}_L(\varepsilon))\check{\rho}_L(E)$ corresponds to hole-hole, electron-hole and electron-electron reflections (further details can be found in Appendix A).

At zero temperature and zero frequency all the products $f(E)(1 - f(E))$ vanish [55, 56], therefore the thermal fluctuations become zero and we obtain the shot noise. For $\beta = \beta'$ we obtain the local shot noise at the same lead, while for $\beta \neq \beta'$ we obtain the nonlocal shot noise, which we analyze in two cases with respect to the applied voltage: the non-symmetric (n-sy) case, where the lead a is grounded and the lead b is at voltage V ; and the symmetric case (sy), where the two leads are at the same voltage V .

For non-symmetric voltages and in the tunneling limit, the noise cross-correlation expression becomes to

$$S_{ba}^{n-sy}(V) = S_{CAR}(V) + S_{EC}(V), \quad (14)$$

$$S_{CAR}(V) = \frac{4e^2}{h} \int_0^{eV} dE [T_{CAR}(E)], \quad (15)$$

$$S_{EC}(V) = -\frac{4e^2}{h} \int_0^{eV} dE [T_{EC}(E)], \quad (16)$$

in this case T_{CAR} and T_{EC} are calculated from the unperturbed Green function of the superconducting region $\check{G}_{RR}^r(E) = \hat{g}^r(E)$

$$T_{CAR}(E) = 4t^4 |\check{g}_{ab,eh}^r(E)|^2, \quad (17)$$

$$T_{EC}(E) = 4t^4 |\check{g}_{ab,ee}^r(E)|^2. \quad (18)$$

The noises S_{CAR} and S_{EC} correspond to noise due to crossed electron-hole and electron-electron reflection probabilities respectively. While CAR contributes positively to the shot noise cross correlations, EC contributes negatively. The differential nonlocal shot noise is defined as

$$\frac{dS_{ba}^{n-sy}(V)}{dV} = \frac{4e^3}{h} (T_{CAR}(eV) - T_{EC}(eV)), \quad (19)$$

and is proportional to σ_{ab} , Eq. 1, $dS_{ba}^{n-sy}/dV = 2e\sigma_{ab}$. Therefore for low transparencies and non-symmetric voltages, we get only CAR and EC contributions to the differential crossed shot noise. However, for symmetric voltages in the tunneling limit, the contributions due to EC for voltages lower than $|\Delta(\mathbf{k})|$ are zero, then the shot noise can be written as

$$S_{ba}^{sy}(V) = \frac{8e^2}{h} \int_0^{eV} dE [T_{CAR}(E)], \quad (20)$$

and therefore the differential nonlocal shot noise is written as

$$\frac{dS_{ba}^{sy}(V)}{dV} = 8e^3 T_{CAR}(eV). \quad (21)$$

For higher transparencies, other processes contribute to the noise cross-correlations [57]. Then, for the symmetric case with voltages smaller than $|\Delta(\mathbf{k})|$, the main contribution to the shot noise is due to CAR. For higher voltages, there are other processes like quasiparticles transmission and Andreev reflections which can contribute positively or negatively to shot noise. EC contributes negatively and appear by means of intermediate propagators. For any voltage the nonlocal shot noise in tunnelling limit can be written as

$$S_{ba}^{sy}(V) = \frac{4e^2}{h} \int_0^{eV} dE [2T_{CAR}(E) - 2T_{EC}(E) + \delta T_{EC}(E)], \quad (22)$$

with

$$\delta T_{EC}(E) = 4t^4 (\hat{g}_{ba,ee}^r(E) \hat{g}_{ab,ee}^r(E) + \hat{g}_{ab,ee}^a(E) \hat{g}_{ba,ee}^a(E)). \quad (23)$$

From equation (22) we can see that for voltages lower than $|\Delta(\mathbf{k})|$, EC contribution cancels itself out because the nonlocal Green functions are always real, $\delta T_{EC} = 2T_{EC}$ recovering the equation (20).

2.1. The Fano factor and the efficiency

The Fano factor (F) is defined as the ratio between the shot noise and the $2e$ multiplied by the electrical current [25]

$$F = \frac{S}{2eI}. \quad (24)$$

In the tunneling limit the Fano factor provides information about the effective electric charge. We analyze the cross correlations using the Fano factor in terms of the noise cross-correlation and cross current considering the equation used by Samuelsson et. al [34]

$$F_{\beta\beta'} = \frac{S_{\beta\beta'}}{2e\sqrt{I_\beta I_{\beta'}}}, \quad (25)$$

where I_β is the current at the lead β . According to equation 14, in the tunneling limit, with non-symmetric voltages, shot noise and current contributions are due to CAR and EC

$$F_{ab}^{n-sy} = \frac{S_{CAR} + S_{EC}}{2e\sqrt{I_a I_b}}, \quad (26)$$

and in the case of symmetric voltages and the shot noise contributions get reduced to only CAR, for $V < |\Delta(\mathbf{k})|$, therefore the cross Fano is

$$F_{ab}^{sy} = \frac{S_{CAR}}{2e\sqrt{I_a I_b}}. \quad (27)$$

It is expected that the nonlocal Fano factor takes values between -1 and 1 . The explanation arises from the effective electric charge. If we examine the electrical current in every normal metal lead,

we find that the electrical current in every lead is due to electron or hole transmission; thus the maximum and the minimum values that the effective electric charge can have are e and $-e$ respectively. This Fano factor sign also gives information about sign of the noise cross-correlation. A Fano factor bigger than zero means positive cross correlations dominance, whereas a Fano factor smaller than zero means negative cross correlations dominance.

Considering all the processes that contribute to the nonlocal shot noise in the tunneling limit, we define the efficiency of the device (η) as the ratio between the differential nonlocal shot noise due to CAR and the sum of the absolute values of the contributions due to CAR and EC (21).

$$\eta = \frac{S_{CAR}}{|S_{CAR}| + |S_{EC}|}. \quad (28)$$

For the symmetric case, in the tunneling limit and voltages lower than $|\Delta(\mathbf{k})|$ the contributions to the nonlocal shot noise are only due to CAR; then the efficiency and the Fano factor are equal to one. If we set higher voltages, the other processes contribute to the noise cross-correlation, which indicates that the efficiency and the Fano factor decrease. This result implies that the Fano factor provides information concerning the efficiency of the device. In the next section, we show the efficiency and the Fano factor using different pair potential symmetries and voltages at the leads.

3. Results

We calculate the nonlocal shot noise as a function of the distance between the leads and the transmission coefficient which is related to the hopping parameter t by

$$T_N = \frac{4t^2}{(1+t^2)^2}. \quad (29)$$

We analyze the shot noise and the Fano factor using typical symmetries for HTc superconductors (HTcS), with d , $d + is$ and s_{++} and s_{+-} symmetries. In this work we have fixed $\Delta_0 = 20 \text{ meV}$ and the ratio $\Delta_0/E_F \simeq 10^{-1}$, which are typical values for a HTcS. We consider non-isotropic symmetries for the superconductor pair potential which depends on the wave vector. For d -wave superconductors the pair potential is $\Delta(\theta) = \Delta_0 \cos 2(\theta - \alpha)$, with α the angle between the crystallographic axes of the superconductor and the normal direction to

the surface. We consider two symmetries: the first one is $d_{x^2-y^2}$ where $\alpha = 0$ and the other one is d_{xy} where $\alpha = \pi/4$.

We consider mixed symmetries, including a small isotropic component to the d -waves, such that the magnitude and phase of the pair potential are affected [39–41].

Finally, to describe the shot noise in iron based superconductors, we consider two multiband models the s_{++} and the s_{+-} . In the first one the phase difference between the two gaps is 0, whereas in the second one it is π so that $\Delta_1/\Delta_2 = \pm|\Delta_1|/|\Delta_2|$. $\Delta_{1(2)}$ is the pair potential in the band 1(2) [58–60].

3.1. s -wave superconductors

If we consider an isotropic symmetry for the superconductor pair potential $\Delta(\mathbf{k}) = \Delta_0$. For non-symmetric case and in the tunneling limit, the differential nonlocal shot noise exhibits oscillations as a function dependent on the distance between the two leads. At this limit the contribution to the noise cross-correlations due to Q and AR is much smaller than CAR and EC, it meaning that CAR and EC compete between them. For higher values of the transmission T_N , the noise cross-correlation becomes negative due to the increase in processes that contribute negatively to the cross-correlations such as quasiparticles transmission (see Fig. 4). Finally for high transparencies $T_N \rightarrow 1$, the differential nonlocal shot noise is completely positive because for a transparent lead the CAR have additional contributions of intermediate propagators in the superconducting region [32]. In addition, the noise cross-correlation exhibits an exponential decay with respect to the distance between the leads (see Fig. 5 a)). These results are in agreement with those obtained by R. Melin et al. [32].

When $V_a = V_b$ at the tunneling limit, the cross correlation between the currents is positive because EC contribution is zero and no local shot noise is due only to CAR. Similarly to the non-symmetric case, when T_N increases the shot noise takes negative values. This behavior occurs because of the higher AR and Q contributions, see Fig. 4. Finally, for high transparencies, the shot noise becomes positive due to contributions from various processes with intermediate propagators between the two leads, see Fig. 5 b).

For symmetric voltages smaller than $|\Delta(\mathbf{k})|$ and at the tunneling limit, due to the cancellation of the EC and the negligible contributions from AR and Q, CAR become the dominant processes giving

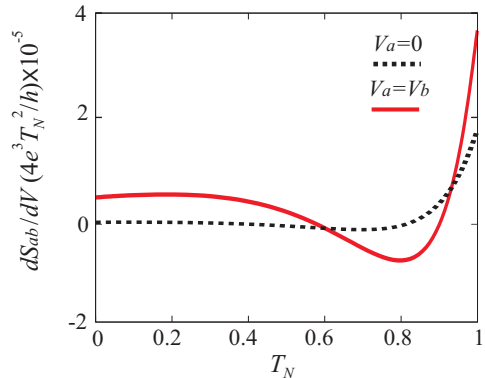

Fig. 4. The spatial-averaged differential shot noise cross-correlation as a function of the transmission coefficient for a s wave superconductor, at $1\xi_0$ and $eV = 0$, for non-symmetric voltages $V_a=0$ and symmetric voltages $V_a = V_b$.

as a result an efficiency equal to one. For higher voltages, Q and AR contributions increase causing a decrease in the efficiency and the Fano factor (Fig. 6).

3.2. d -wave superconductors

Unlike s -wave superconductors, for $d_{x^2-y^2}$ symmetry, when $V_a = 0$ and $V_b = V$, the differential shot noise is positive for every transmission value, indicating that this symmetry favors positive cross correlations, in particular for low transparencies.

When we set $V_a = V_b$, the contribution to the shot noise due to CAR is twice the obtained for non-symmetric voltages whereas the EC contribution cancel. This is reflected in the increase of the differential cross correlation shot noise in the tunneling limit. Similarly to s -wave superconductors, the shot noise is positive for low transparencies; however, as T_N increases the differential shot noise becomes negative due to AR and Q. For high transparencies, the differential shot noise becomes positive.

For this pair potential symmetry, the cross correlation oscillations do not disappear for high transparencies. This is due to the relative phase of the pair potential, which allows constructive and destructive interferences in the leads. We appreciate an algebraic decay of the shot noise with respect to the distance between the leads, proportional to $1/d^2$ (Fig. 7 a) and b)), in contrast to the exponential decay of the s wave superconductors.

We add an isotropic component to the $d_{x^2-y^2}$ pair potential $\Delta_{\pm} = \Delta_0 \cos(2(\theta \mp \alpha)) + i\Delta_s$ to get the $d_{x^2-y^2} + is$ symmetry, with $\Delta_s = 0.05\Delta_0$.

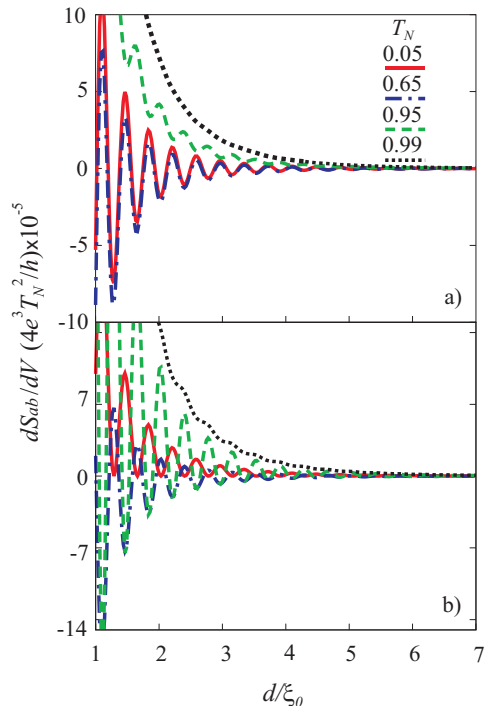

Fig. 5. Differential shot noise cross-correlation as a function of the distance between the two leads for different transparencies, for a s wave superconductor, for a) non-symmetric voltages and b) symmetric voltages. With ξ_0 the BCS coherence length.

For non-symmetric voltages, in the tunneling limit, we get positive differential shot noise similarly to those observed with the $d_{x^2-y^2}$ symmetry, see Fig. 7 c). For intermediate transparencies, the EC, Q and AR contributions can be more relevant than CAR, producing an oscillating behavior around zero. For symmetric voltages, the CAR domains over Q and AR for small transparencies and similarly to the non-symmetric voltages, see Fig. 7 d), we appreciate that the differential noise cross-correlation has been displayed for positive values.

Due to the Δ_s component an exponential decay is added to the algebraic decay that we observed with the $d_{x^2-y^2}$ wave superconductors, such that the behavior is proportional to $e^{-d/\pi\xi_0}/d^2$.

When we consider a d_{xy} symmetry the AR are suppressed by the diffraction in the interphase between the lead and superconductor [61]; thus, the processes that contribute to the shot noise are CAR, EC and Q. In NIS (N: normal-metal, I: Insulator, S: Superconductor) plane junctions, when the symmetry of the pair potential is d_{xy} , a zero bias conductance peak (ZBCP) appears in the differential

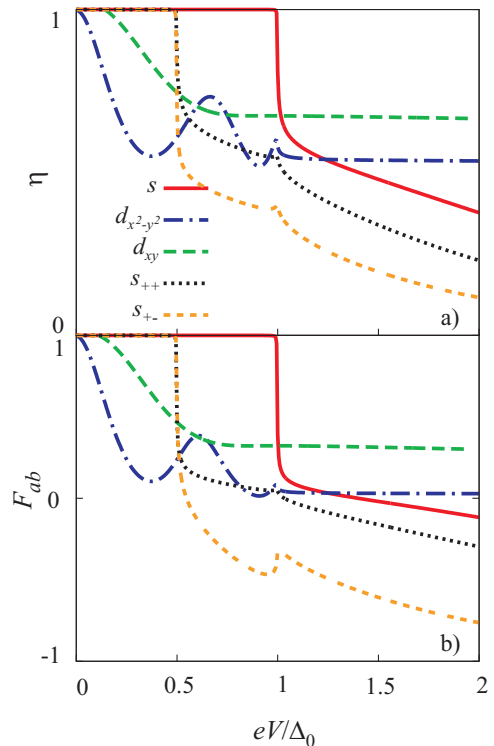

Fig. 6. a) Cross Andreev reflections efficiency and b) Cross Fano factor as a function of the energy, for every symmetry considered using $V_a = V_b$ and $T_N = 0.05$. For the symmetries s_{+-} and s_{++} $\alpha = 0.5$.

conductance due to the induction of states at the interface. The Andreev reflection coefficient is 1 and rapidly decays as V increases. In the differential shot noise the peak is split and at zero bias the shot noise is equal to zero [23, 24, 62, 63]. These two results lead to a Fano factor equal to zero at zero bias for this kind of symmetry. However, in NIS quantum point contact ZBCP does not appear because the Andreev reflections are zero. The wave functions in the channel are a superposition of two plane waves with wave numbers $ky = \pm p/W$. Each wave experiences a pair potential phase 0 and π , respectively, and therefore the Andreev reflection coefficient for each wave is out of phase by π , such that the waves of the reflected holes interfere destructively and the Andreev reflections vanish.

When the leads are connected to non-symmetric voltages and at the tunneling limit, the EC dominates over CAR, so that the noise cross-correlation displays negative values. When T_N increases, the Q contributions increase also, causing that the differential noise cross-correlation becomes more negative. Unlike the $d_{x^2-y^2}$ symmetry, for d_{xy} symme-

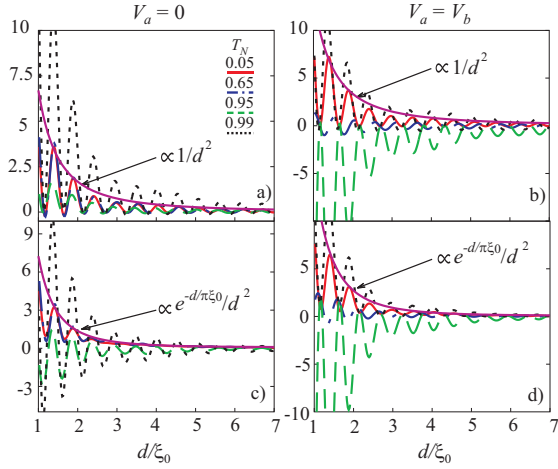

Fig. 7. Differential shot noise as a function of the distance between the two leads for different transmission coefficient values T_N . a) and b) for a d_{xy} wave superconductor and c) and d) for a $d_{x^2-y^2} + is$ wave superconductor, with non-symmetric voltages and symmetric voltages in the first and second column respectively. The isotropic component for the mixed symmetry is $0.05 * \Delta_0$.

try, we always have domain of negative cross correlations, see Fig. 8.

Considering symmetric voltages, we obtain positive values for the shot noise cross correlations. As the EC contributions to the cross correlations cancel and the AR are suppressed due to the pair potential symmetry, we only have the CAR and Q contributions. For low transparencies we appreciate a dominance of CAR that decreases as T_N increases.

Whereas for d_{xy} and non-symmetric voltages the dominance is due to EC, with an isotropic component the AR occur and contributions due to CAR increase. This phenomenon can be appreciated in the negative values obtained in the differential shot noise with an isotropic component, see Fig. 8 a).

For the d_{xy} symmetry we obtain an algebraic decay with respect to the distance of the leads proportional to $1/d^4$ (Fig. 8 a) and b)), whereas for the $d_{xy} + is$ symmetry, the decay is proportional to $e^{-d/\pi\xi_s}/d^4$ (Fig. 8 c) and d)).

3.3. Multiband superconductors, s_{++} and s_{+-} symmetries

The main feature of iron based superconductors is their multiple band structure near to the Fermi level. In a simplified scheme, the structure is reduced to two band models, where the symmetry of the pair potential in each band could be different,

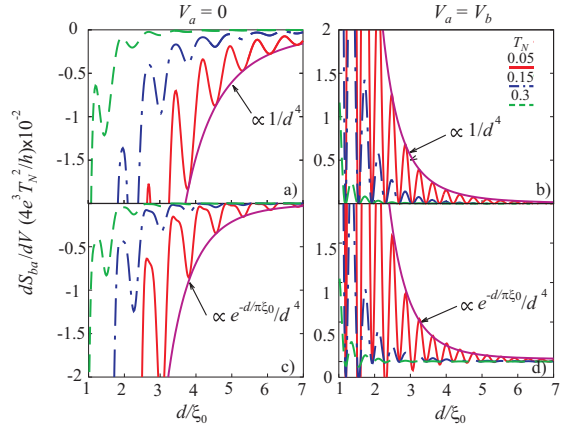

Fig. 8. Differential shot noise as a function of the distance between the two leads for different transmission coefficient values T_N . a) and b) for a d_{xy} wave superconductor and c) and d) for a $d_{xy} + is$ wave superconductor, with non-symmetric voltages and symmetric voltages in the first and second column respectively. The isotropic component for the mixed symmetry is $0.05 * \Delta_0$.

and experimental evidence has been favorable to the s_{++} and s_{+-} symmetries [58–60].

In order to calculate the transport properties for this kind of symmetries, we find the equilibrium Green functions for two s -wave superconductors with different pair potentials, $\Delta_1 = 0.5\Delta_0$ and $\Delta_2 = \Delta_0$. We use two phase differences between the two gaps, which for the s_{++} is 0 and for the s_{+-} is π . Then by means of a weight factor (α), defined as the ratio of the probability amplitudes for an incoming electron from one of the two leads to tunnel into the first or second band, we write the total green function of the system as [64]

$$\hat{g}_{RR}^r(E) = \sum_{k_y} |t(k_y)|^2 [\hat{g}_{\Delta_1}^r(E, k_y) + \alpha \hat{g}_{\Delta_2}^r(E, k_y)]. \quad (30)$$

For the s_{+-} symmetry and non-symmetric voltages, we appreciate destructive effects over AR due to the phase difference in the pair potential (Fig. 9 a) and b)). However, the contributions due to AR do not disappear completely because the magnitude of the two gaps are not equal. At the tunneling limit, the cross-correlations are negative due to the larger EC contribution. For high transparencies the positive contributions to the noise cross correlation increase because of non-local processes of higher order.

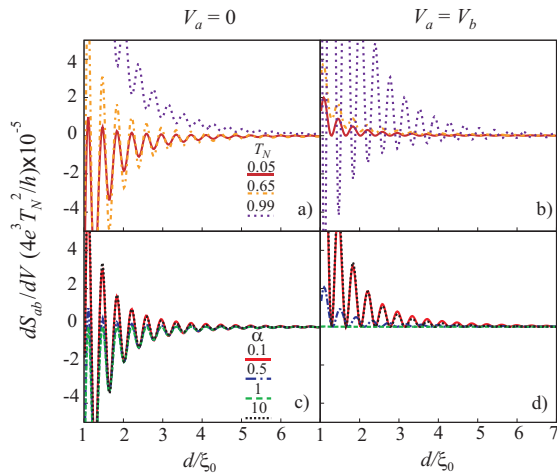

Fig. 9. Differential shot noise as a function of the distance between the two leads for a s_{+-} wave superconductor. a) and b) for different transmission coefficient values T_N and $\alpha = 0.5$, c) and d) for different weight factors α and $T_N = 0.05$. With non-symmetric voltages and symmetric voltages in the first and second column respectively.

When we set symmetric voltages, the EC contributions cancel and the AR are reduced, the CAR contributes positively to the cross-correlation; thus, the shot noise is positive.

The results for the s_{++} symmetry in Fig. 10 are quite similar to those obtained for the s symmetry. We also appreciate that the nonlocal shot noise for symmetric voltages becomes negative for intermediate values of the transparency according to the behavior observed in the Fig. 4. This behavior occurs because for this pair potential there is no phase difference; thus, the contributions of the two bands to the nonlocal shot noise are added, yielding similar magnitudes and signs as those for s symmetry.

4. Conclusions

We have determined analytical equations for shot noise cross correlation in multi-terminal superconductors from the Green's functions and the Keldysh formalism. We have considered two leads (a and b) and the cases where the applied voltages are $V_a = 0$ and $V_b = V$ (non-symmetric case), and $V_a = V_b = V$ (symmetric case). We have considered pair potential symmetries, s , d , $d + is$ and multiband s_{+-} and s_{++} . We found that when we apply symmetric voltages lower than $|\Delta(\mathbf{k})|$ in the tunneling limit, positive cross correlations are favored. This result is obtained due to the fact that the EC, which are the main source of negative cross

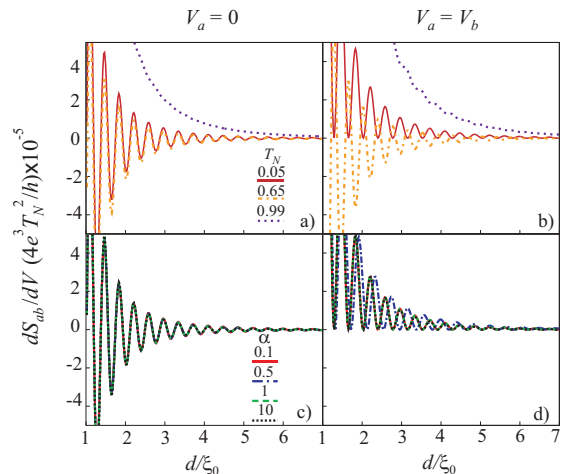

Fig. 10. Differential shot noise as a function of the distance between the two leads for a s_{++} wave superconductor. a) and b) for different transmission coefficient values T_N and $\alpha = 0.5$, c) and d) for different weight factors α and $T_N = 0.05$. With non-symmetric voltages and symmetric voltages in the first and second column respectively.

correlations, is canceled allowing the CAR to be the dominant processes.

We calculate the crossed Fano factor of the system for symmetric voltages. The sign of the Fano factor reveals the sign of the cross correlation dominance and we find that this factor in the tunneling limit is analogous to the CPS efficiency of the device.

In particular, we observe that when symmetric voltages are applied to a d_{xy} -wave superconductor, and in the tunneling limit, the CAR become the dominant processes making the device to exhibit good efficiency even for voltages higher than Δ_0 . By on the other side, for non symmetric voltages EC dominates over CAR. For $d_{x^2-y^2} + is$ and $d_{xy} + is$ symmetries, the isotropic component causes negative contributions reflected in negative values for the cross correlation.

In general the shot noise cross correlation between two leads for d -wave superconductors exhibits algebraic decay with the increase of the distance between the leads, in contrast to the exponential behavior typically observed for isotropic superconductors. These properties would allow the development of devices that are capable of detecting positive cross correlation at distances several times larger than the characteristic coherence length with good efficiency.

To prove the entanglement, it is still needed to show Bells inequality by means of the coherence

and spin correlation that could be accomplished by means of ferromagnetic leads.

The authors have received support from the COLCIENCIAS, project No. 110165843163.

Appendix A. Modeling the system

From the superconductor surface Green functions in momentum representation ($\hat{g}_S^r(E, k_y)$), we calculate the local $\hat{g}_{S,aa(bb)}(E)$ and the non-local $\hat{g}_{S,ab(ba)}(E)$ equilibrium Green functions [47]

$$\begin{aligned}\hat{g}_{S,bb(aa)}^r(E) &= \sum_{k_y} |f(k_y)|^2 \hat{g}_S^r(E, k_y), \\ \hat{g}_{S,ba(ab)}^r(E) &= \sum_{k_y} |f(k_y)|^2 \hat{g}_S^r(E, k_y) \\ &e^{-(+)ik_y d/\xi},\end{aligned}\quad (\text{A.1})$$

where $f(k_y)$ is the weighting factor and is proportional to the perpendicular wave vector k_{xF} [61], ξ is the superconductor coherence longitude defined as $\xi(E, \theta) = \xi_0/Re[\sqrt{1 - E^2/\Delta(\theta)}]$ and $\xi_0 = \hbar v_F/(\pi \Delta_0)$ the BCS coherence longitude.

We write the retarded Green function of the uncoupled superconductor $\check{g}_{RR}^r(E)$ as

$$\check{g}_S^r(E) = \begin{pmatrix} \hat{g}_{S,aa}^r(E) & \hat{g}_{S,ab}^r(E) \\ \hat{g}_{S,ba}^r(E) & \hat{g}_{S,bb}^r(E) \end{pmatrix}, \quad (\text{A.2})$$

where the symbol $\hat{}$ denotes a 2×2 matrix in Nambu space, whereas the symbol $\check{}$ denotes a 4×4 matrix in the Nambu electrodes space.

We obtain the non-equilibrium Green functions of the coupled system $\check{G}_{ij,\beta\beta'}^{+-(-+)}(E)$ and the perturbed Green Function $\check{G}_{ij,\beta\beta'}^{r(a)}(E)$ solving the Dyson equation for two leads, where β and β' denote the a or b lead respectively, and i and j denote the L or R region respectively.

$$\check{G}^{+-(-+)}(E) = [\check{I} + \check{G}^r(E)\check{p}]\check{g}^{+-(-+)}(E) \quad (\text{A.3})$$

$$[\check{I} + \check{p}\check{G}^a(E)],$$

$$\check{G}^{r(a)}(E) = \check{g}^{r(a)}(E) + \check{g}^{r(a)}(E)\check{p} \quad (\text{A.4})$$

$$\check{G}^{r(a)}(E),$$

here t is the hopping parameter related to the transmission of particles from the left side to the right side [61], $+(-)$ are the two branches of the Keldysh space. $\check{g}^{+-(-+)}$ is the non-equilibrium Green function (leads or superconductor) in Keldysh space without coupling [47].

The electrical current in the β lead is

$$I_\beta = \frac{et^2}{h} \int_{-\infty}^{\infty} dE \text{Tr} \{ \check{N}_\beta (\check{g}_{LL}^{+-}(E) \check{\sigma}_z \quad (\text{A.5})$$

$$\check{G}_{RR}^{-(+)}(E) - \check{g}_{LL}^{-(+)}(E) \check{\sigma}_z \check{G}_{RR}^{+-}(E) \},$$

with, $\check{N}_a, \check{N}_b, \check{\sigma}_z$ given by the Eq. 13. To calculate the noise cross-correlation we define the spectral density of the electrical current fluctuations between the electrodes β and β' as

$$S_{\beta\beta'}(\omega) = \hbar \int d(\tau') e^{i\omega(\tau')} \quad (\text{A.6})$$

$$\left[\left\langle \delta \hat{I}_\beta(\tau') \delta \hat{I}_{\beta'}(\tau) \right\rangle + \left\langle \delta \hat{I}_{\beta'}(\tau') \delta \hat{I}_\beta(\tau) \right\rangle \right],$$

where $\delta \hat{I}_\beta(\tau)$ is the deviation of the electrical current regarding to its mean value, $\delta \hat{I}_\beta(\tau) = \hat{I}_\beta(\tau) - \langle \hat{I}_\beta(\tau) \rangle$.

$$\left\langle \delta \hat{I}_\beta(\tau') \delta \hat{I}_{\beta'}(\tau) \right\rangle = 2 \left(\frac{e}{h} \right)^2 \text{Tr} [\check{N}_\beta \check{\sigma}_z \check{p} \quad (\text{A.7})$$

$$\check{G}_{LL}^{+-}(\tau, \tau') \sigma_z \check{p} \\ \check{G}_{LL}^{-(+)}(\tau', \tau) - \check{N}_\beta \check{\sigma}_z \check{p} \\ \check{G}_{LR}^{+-}(\tau, \tau') \sigma_z \check{p} \\ \check{G}_{LR}^{-(+)}(\tau', \tau)],$$

with $\check{p} = t * \check{\sigma}_z$. We write the noise cross-correlation as

$$S_{\beta\beta'}(\omega) = \frac{2e^2 t^4}{h} \int dE [K_{\beta\beta'}(E, \varepsilon) \quad (\text{A.8})$$

$$+ K_{\beta'\beta}(\varepsilon, E)],$$

$$\varepsilon = E + \hbar\omega,$$

where the kernel $K_{\beta\beta'}(E, \varepsilon)$ is given by

$$K_{\beta\beta'}(E, \varepsilon) = \text{Tr} [\check{N}_\beta \check{G}_{LL}^{+-}(E) \check{N}_{\beta'} \quad (\text{A.9})$$

$$\check{G}_{RR}^{-(+)}(\varepsilon) - \check{N}_\beta \check{G}_{LR}^{+-}(E) \\ \check{N}_{\beta'} \check{G}_{LR}^{-(+)}(\varepsilon)].$$

From the non-equilibrium Green function obtained by solving the Dyson equation Eq. (A.4) we calculate the kernels $K_{\beta\beta'}$ Eq. (A.9) and the noise cross-correlations, Eq. (A.8).

References

- [1] C. L. Salter, R. M. Stevenson, I. Farrer, C. A. Nicoll, D. A. Ritchie, and A. J. Shields. An entangled-light-emitting diode. *Nature*, 465(7298):594–597, 06 2010.
- [2] A. Rycerz. Entanglement and transport through correlated quantum dot. *Eur. Phys. J. B*, 52(3):291–296, 2006.
- [3] Nikolai M. Chtchelkatchev, Gianni Blatter, Gordey B. Lesovik, and Thierry Martin. Bell inequalities and entanglement in solid-state devices. *Phys. Rev. B*, 66:161320, Oct 2002.
- [4] L. G. Herrmann, F. Portier, P. Roche, A. Levy Yeyati, T. Kontos, and C. Strunk. Carbon nanotubes as cooper-pair beam splitters. *Phys. Rev. Lett.*, 104:026801, 2010.
- [5] Andrew M Martin, Thomas Gramspacher, and Markus Buttiker. Charge fluctuations in the edge states of normal-superconducting hybrid nano-structures. *Journal of Physics: Condensed Matter*, 11(50):L563, 1999.
- [6] Peng Zhang and Yu xian Li. Andreev reflection and shot noise in a quantum dot with phonon modes. *Journal of Physics: Condensed Matter*, 21(9):095602, 2009.
- [7] G.B. Lesovik, T. Martin, and G. Blatter. Electronic entanglement in the vicinity of a superconductor. *The European Physical Journal B - Condensed Matter and Complex Systems*, 24(3):287–290, 2001.
- [8] Patrik Recher, Eugene V. Sukhorukov, and Daniel Loss. Andreev tunneling, coulomb blockade, and resonant transport of nonlocal spin-entangled electrons. *Phys. Rev. B*, 63:165314, Apr 2001.
- [9] Jeff M. Byers and Michael E. Flatté. Probing spatial correlations with nanoscale two-contact tunneling. *Phys. Rev. Lett.*, 74:306–309, Jan 1995.
- [10] Guy Deutscher and Denis Feinberg. Coupling superconducting-ferromagnetic point contacts by andreev reflections. *Applied Physics Letters*, 76(4):487–489, 2000.
- [11] Pablo Buset, Bo Lu, Hiromi Ebisu, Yasuhiro Asano, and Yukio Tanaka. All-electrical generation and control of odd-frequency s -wave cooper pairs in double quantum dots. *Phys. Rev. B*, 93:201402, May 2016.
- [12] Gong Wei-Jiang, Wang Xiao-Qi, Zhu Yu-Lian, Gao Zhen, and Wu Hai-Na. Out-of-phase andreev transports in a double-quantum-dot cooper-pair splitter. *J. Appl. Phys.*, 119:214305, 2016.
- [13] Zheng-Wei Zuo, L. Sheng, and D.Y. Xing. Crossed andreev reflections in superconductor and fractional quantum hall liquids hybrid system. *Solid State Communications*, 184:17 – 20, 2014.
- [14] L. Hofstetter, S. Csonka, J. Nygard, and C. Schonenberger. Cooper pair splitter realized in a two-quantum-dot y -junction. *Nature*, 461:960, 2009.
- [15] Jian Wei and V. Chandrasekhar. Positive noise cross-correlation in hybrid superconducting and normal-metal three-terminal devices. *Nature Physics*, 6:494, 2010.
- [16] Bernd Braunecker, Pablo Buset, and Alfredo Levy Yeyati. Entanglement detection from conductance measurements in carbon nanotube cooper pair splitters. *Phys. Rev. Lett.*, 111:136806, Sep 2013.
- [17] H. Soller, L. Hofstetter, and D. Reeb. Entanglement witnessing in superconducting beamsplitters. *EPL (Europhysics Letters)*, 102(5):50009, 2013.
- [18] P. Buset, W. J. Herrera, and A. Levy Yeyati. Microscopic theory of cooper pair beam splitters based on carbon nanotubes. *Phys. Rev. B*, 84:115448, Sep 2011.
- [19] Shiro Kawabata. Test of bells inequality using the spin filter effect in ferromagnetic semiconductor microstructures. *J. Phys. Soc. Jpn.*, 70:1210, 2001.
- [20] Jean-Charles Forgues, Christian Lupien, and Bertrand Reulet. Experimental violation of bell-like inequalities by electronic shot noise. *Phys. Rev. Lett.*, 114:130403, Apr 2015.
- [21] Ya.M. Blanter and M. Buttiker. Shot-noise current-current correlations in multiterminal diffusive conductors. *Phys. Rev. B*, 56:2127, 1997.
- [22] C. Beenakker and C. Schnenberger. Shot-noise current-current correlations in multiterminal diffusive conductors. *Physics Today*, 37:56, 2003.
- [23] Jian-Xin Zhu and C. S. Ting. Shot noise in a normal-metal d -wave superconductor junction with a 110-oriented interface. *Phys. Rev. B*, 59:R14165–R14168, Jun 1999.
- [24] Y. Tanaka, T. Asai, N. Yoshida, J. Inoue, and S. Kashiyawa. Interface effects on the shot noise in normal-metal d -wave superconductor junctions. *Phys. Rev. B*, 61:R11902–R11905, May 2000.
- [25] C. Texier and M. Buttiker. Effect of incoherent scattering on shot noise correlations in the quantum hall regime. *Phys. Rev. B*, 62:7454, 2000.
- [26] D. Chevallier, J. Rech, T. Jonckheere, and T. Martin. Current and noise correlations in a double dot cooper pair beam splitter. *Phys. Rev. B*, 83:125421, 2011.
- [27] Lara Faoro and Fabio Taddei. Entanglement detection for electrons via witness operators. *Phys. Rev. B*, 75:165327, 2007.
- [28] E. G. Mishchenko. Shot noise in a f - n - f spin valve. *Phys. Rev. B*, 68:100409, 2003.
- [29] G. KieBlich, A. Wacker, and E. Schoell. Shot noise of coupled semiconductor quantum dots. *Phys. Rev. B*, 68:125320, 2003.
- [30] Ling Qin and Yong Guo. Tunable shot noise in parallel-coupled double quantum dots’ system. *Journal of Physics: Condensed Matter*, 20(36):365206, 2008.
- [31] Nicolas Agrait, Alfredo Levy Yeyati, and Jan M. van Ruitenbeek. Quantum properties of atomic-sized conductors. *Physics Reports*, 377:81, 2003.
- [32] R. Melin, C. Benjamin, and T. Martin. Positive noise cross-correlations in superconducting hybrids. role of interfaces and interactions. *Phys. Rev. B*, 77:094512, 2008.
- [33] R. Mélin and S. Peysson. Crossed andreev reflection at ferromagnetic domain walls. *Phys. Rev. B*, 68:174515, Nov 2003.
- [34] P. Samuelsson, E. V. Sukhorukov, and M. Buttiker. Electrical current noise of a beam splitter as a test of spin-entanglement. *Phys. Rev. B*, 70:115330, 2004.
- [35] P. Samuelsson and M. Buttiker. Quantum state tomography with quantum shot noise. *Phys. Rev. B*, 73:041305(R), 2006.
- [36] B H Wu, C R Wang, X S Chen, and G J Xu. Current noise in three-terminal hybrid quantum point contacts. *Journal of Physics: Condensed Matter*, 26(2):025301, 2014.
- [37] Wei Chen, D. N. Shi, and D. Y. Xing. Long-range cooper pair splitter with high entanglement production rate. *Scientific Reports*, 5:7607 EP –, 01 2015.
- [38] Alessandro Braggio, Michele Governale, Marco G. Pala, and Jrgen Knig. Superconducting proximity effect in

- interacting quantum dots revealed by shot noise. *Solid State Communications*, 151(2):155 – 158, 2011.
- [39] J.R. Kirtley, C.C. Tsuei, J.Z. Sun, C.C. Chi, L.S. Yu-Jahnes, M. Rupp A. Gupta, and M.B. Ketchen. Symmetry of the order parameter in the high- T_c superconductor $\text{YBa}_2\text{Cu}_3\text{O}_{7-d}$. *Nature*, 373:225, 1995.
- [40] Y. Wang and H. MacDonald. Mixed-state quasiparticle spectrum for d -wave superconductors. *Phys. Rev. B*, 52:876, 1995.
- [41] Amlan Biswas, P. Fournier, M. M. Qazilbash, V. N. Smolyaninova, Hamza Balci, and R. L. Greene. Evidence of a d - to s -wave pairing symmetry transition in the electron-doped cuprate superconductor $\text{Pr}_{2-x}\text{Ce}_x\text{CuO}_4$. *Phys. Rev. Lett.*, 88:207004, May 2002.
- [42] Hamidreza Emami-pour. Spin-polarized current in zeeman-split d -wave superconductor/quantum wire junctions. *Solid State Communications*, 236:17 – 22, 2016.
- [43] Shuanwen Jia, Baolin Ma, Ke-Wei Wei, Yanling Yang, and Chunxu Bai. Andreev bound state in a superconducting double barrier junction: The role of anisotropic $d_{x^2-y^2}$ -wave pairing potential. *Solid State Communications*, 152(24):2133 – 2137, 2012.
- [44] Jianwen Wei. Quantum point contact conductance in normal metal/insulator/ metal/ mixed wave superconductor junctions. *Solid State Communications*, 150(1516):777 – 781, 2010.
- [45] B. Pradhan, S.K. Goi, Srikanta Behera, P.K. Parida, and R.N. Mishra. Model study of coexistence of jahn-teller distortion, antiferromagnetism and superconductivity in iron pnictide superconductors. *Solid State Communications*, 248:53 – 59, 2016.
- [46] Zhongxian Zhao, Xiaoli Dong, and Liling Sun. A few points on iron-based superconductors. *Solid State Communications*, 152(8):660 – 665, 2012. Special Issue on Iron-based Superconductors.
- [47] W.J. Herrera, A.L. Yeyati, and A. Martín-Rodero. Long range crossed andreev reflections in high T_c superconductors. *Phys. Rev. B*, 79:5020, 2009.
- [48] S. Russo, M. Kroug, T. M. Klapwijk, and A. F. Morpurgo. Experimental observation of bias-dependent nonlocal andreev reflection. *Phys. Rev. Lett.*, 95:027002, Jul 2005.
- [49] D. Beckmann, H. B. Weber, and H. v. Löhneysen. Evidence for crossed andreev reflection in superconductor-ferromagnet hybrid structures. *Phys. Rev. Lett.*, 93:197003, Nov 2004.
- [50] Anindya Das, Yuval Ronen, Moty Heiblum, Diana Mahalu, Andrey V Kretinin, and Hadas Shtrikman. High-efficiency cooper pair splitting demonstrated by two-particle conductance resonance and positive noise cross-correlation. *Nat Commun*, 3:1165, 11 2012.
- [51] P. Cadden-Zimansky and V. Chandrasekhar. Nonlocal correlations in normal-metal superconducting systems. *Phys. Rev. Lett.*, 97:237003, Dec 2006.
- [52] J. Schindele, A. Baumgartner, and C. Schönenberger. Near-unity cooper pair splitting efficiency. *Phys. Rev. Lett.*, 109:157002, 2012.
- [53] L. Hofstetter, S. Csonka, A. Baumgartner, G. Fülöp, S. d’Hollosy, J. Nygård, and C. Schönenberger. Finite-bias cooper pair splitting. *Phys. Rev. Lett.*, 107:136801, Sep 2011.
- [54] J. C. Cuevas, A. Martín-Rodero, and A. Levy Yeyati. Hamiltonian approach to the transport properties of superconducting quantum point contacts. *Phys. Rev. B*, 54:7366–7379, Sep 1996.
- [55] Kimio Tsuchikawa, Nobukatsu Yoshida, Yukio Tanaka, Satoshi Kashiwaya, Jun ichiro Inoue, and Yukihiko Takagaki. Theory of tunneling conductance in quantum wire/ d -wave superconductor junctions. *Physica C: Superconductivity*, 362(14):224 – 227, 2001.
- [56] Y. Takagaki and K. H. Ploog. Quantum point contact spectroscopy of d -wave superconductors. *Phys. Rev. B*, 60:9750–9754, Oct 1999.
- [57] Dmitri S. Golubev and Andrei D. Zaikin. Quantum tunneling of the order parameter in superconducting nanowires. *Phys. Rev. B*, 64:014504, Jun 2001.
- [58] Yoichi Kamihara, Takumi Watanabe, Masahiro Hirano, and Hideo Hosono. Iron-based layered superconductor $\text{La}[\text{o}1\text{-xfx}]\text{FeAs}$ ($x = 0.050.12$) with $T_c = 26$ K. *Journal of the American Chemical Society*, 130(11):3296–3297, 2008.
- [59] A. A. Golubov, A. Brinkman, Yukio Tanaka, I. I. Mazin, and O. V. Dolgov. Andreev spectra and subgap bound states in multiband superconductors. *Phys. Rev. Lett.*, 103:077003, Aug 2009.
- [60] Yan-Yang Zhang, Chen Fang, Xiaoting Zhou, Kangjun Seo, Wei-Feng Tsai, B. Andrei Bernevig, and Jiangping Hu. Quasiparticle scattering interference in superconducting iron pnictides. *Phys. Rev. B*, 80:094528, Sep 2009.
- [61] William J. Herrera, J. Virgilio Niño, and J. Jairo Giraldo. Quantum point contact conductance in normal-metal/insulator/metal/superconductor junctions. *Phys. Rev. B*, 71:094515, Mar 2005.
- [62] Yukio Tanaka and Satoshi Kashiwaya. Theory of tunneling spectroscopy of d -wave superconductors. *Phys. Rev. Lett.*, 74:3451–3454, Apr 1995.
- [63] Satoshi Kashiwaya and Yukio Tanaka. Tunneling effects on surface bound states in unconventional superconductors. *Reports on Progress in Physics*, 63(10):1641, 2000.
- [64] J. A. Celis G. and William J. Herrera. Shot noise in {HTc} superconductor quantum point contact system. *Physica B: Condensed Matter*, 407(16):3081 – 3084, 2012. Frontiers of Condensed Matter V (FCM 2010).