

Tensor categories for vertex operator superalgebra extensions

Thomas Creutzig ^{*} Shashank Kanade [†] Robert McRae

Abstract

Let V be a vertex operator algebra with a category \mathcal{C} of (generalized) modules that has vertex tensor category structure, and thus braided tensor category structure, and let A be a vertex operator (super)algebra extension of V . We employ tensor categories to study untwisted (also called local) A -modules in \mathcal{C} , using results of Huang-Kirillov-Lepowsky that show that A is a (super)algebra object in \mathcal{C} and that generalized A -modules in \mathcal{C} correspond exactly to local modules for the corresponding (super)algebra object. Both categories, of local modules for a \mathcal{C} -algebra and (under suitable conditions) of generalized A -modules, have natural braided monoidal category structure, given in the first case by Pareigis and Kirillov-Ostrik and in the second case by Huang-Lepowsky-Zhang.

Our main result is that the Huang-Kirillov-Lepowsky isomorphism of categories between local (super)algebra modules and extended vertex operator (super)algebra modules is also an isomorphism of braided monoidal (super)categories. Using this result, we show that induction from a suitable subcategory of V -modules to A -modules is a vertex tensor functor. Two applications are given:

First, we derive Verlinde formulae for regular vertex operator superalgebras and regular $\frac{1}{2}\mathbb{Z}$ -graded vertex operator algebras by realizing them as (super)algebra objects in the vertex tensor categories of their even and \mathbb{Z} -graded components, respectively.

Second, we analyze parafermionic cosets $C = \text{Com}(V_L, V)$ where L is a positive definite even lattice and V is regular. If the vertex tensor category of either V -modules or C -modules is understood, then our results classify all inequivalent simple modules for the other algebra and determine their fusion rules and modular character transformations. We illustrate both directions with several examples.

MSC 2020: Primary 17B69, 18M15, 18M20, 81R10, 81T40

^{*}T. C. is supported by the Natural Sciences and Engineering Research Council of Canada (RES0020460).

[†]S. K. gratefully acknowledges the support provided by post-doctoral fellowship awarded by the Pacific Institute for the Mathematical Sciences and Endeavour Research Fellowship (6127_2017) awarded by the Department of Education and Training, Australian Government. S. K. is presently supported by the Collaboration Grant for Mathematicians #636937, awarded by the Simons Foundation.

Contents

1	Introduction	2
1.1	Vertex tensor categories	3
1.2	Motivation	5
1.3	Results on vertex operator (super)algebra extensions and their modules	7
1.4	Tensor categories of regular vertex operator superalgebras	9
1.5	Verlinde formulae for regular $\frac{1}{2}\mathbb{Z}$ -graded vertex operator superalgebras	10
1.6	Outline	14
2	Tensor categories and supercategories	14
2.1	Commutative associative algebras in braided tensor categories	15
2.2	Superalgebras in braided tensor categories	18
2.3	Tensor products and unit isomorphisms in $\text{Rep } A$	25
2.4	Categorical intertwining operators and a universal property of tensor products in $\text{Rep } A$	33
2.5	Associativity of categorical $\text{Rep } A$ -intertwining operators and the tensor product in $\text{Rep } A$	34
2.6	The braided tensor category $\text{Rep}^0 A$	39
2.7	Induction and restriction functors	43
2.8	More properties of $\text{Rep } A$ and the induction functor	49
3	Vertex tensor categories	56
3.1	Modules and intertwining operators	57
3.2	Multivalued functions, intertwining maps, and compositions of intertwining operators	60
3.3	An exposition of vertex tensor category constructions	64
3.4	Complex analytic formulation of categorical $\text{Rep } A$ -intertwining operators	72
3.5	Vertex tensor category structure on $\text{Rep}^0 A$	76
3.6	Induction as a vertex tensor functor	85
3.7	Some analytic lemmas	88
4	Applications	94
4.1	Examples of vertex operator superalgebra extensions	94
4.2	Verlinde formulae	101
4.3	Cosets by lattice vertex operator algebras: General results	113
4.4	Coset theories: Examples	119

1 Introduction

Vertex operator algebras can be viewed as an attempt to mathematically formalize the symmetry algebra of a two-dimensional conformal quantum field theory. In addition to physics, vertex operator algebras have by now intimate connections to many areas of mathematics, including affine Lie algebras, modular tensor categories, geometry, and modular forms. In this paper, we use tensor categories to deepen our understanding of the representation theory of vertex operator algebras, and more generally, vertex operator superalgebras.

The tensor category approach to conformal quantum field theory began in the late 1980s with Verlinde's observation that fusion rules of rational conformal field theory are connected to modular properties of characters [Ve]. This was soon followed by the work of Moore and Seiberg [MS], who realized that the representation theory of conformal field theory has certain features that Turaev [Tu1] was then able to formalize through introducing the concept of modular tensor category. Two important questions were then when a category of vertex operator algebra modules is a modular tensor category, and whether the modular S -matrix defined by the transformation properties of torus one-point functions for the vertex operator algebra agrees (up to normalization) with the categorical S -matrix of a modular tensor category given by Hopf links. Both questions were resolved by Huang [Hu6, Hu7]: in particular, the module category of a so-called regular vertex operator algebra is a modular tensor category, and the modular and categorical S -matrices indeed agree up to normalization. Huang's work depends not merely on the braided tensor category structure of vertex operator algebra module categories, but also on the deeper *vertex tensor category* structure formulated and developed in [HL1, HL2, HL3, HL4, Hu2, HL5]. Recently, Huang, Lepowsky, and Zhang have developed a vertex tensor category theory for more general vertex

operator algebras: the tensor categories constructed in [HLZ1]-[HLZ8] are no longer necessarily semisimple or finite, but they are braided and have a twist. It is not known generally under what conditions they are rigid.

Our setting is thus a vertex operator algebra V with a vertex tensor category \mathcal{C} of modules that is braided and has a twist. Let $A \supseteq V$ be a V -module that itself carries the structure of a vertex operator (super)algebra. The aim is then to use the tensor category structure on \mathcal{C} to understand its relation with the representation theory of A (see [Hö] for an early realization that tensor categories can be used to study vertex operator algebra extensions). Our starting point is the work of Pareigis [Pa] and Kirillov-Ostrik [KO] on commutative algebra objects inside abstract modular tensor categories, in particular their construction of a braided tensor category $\text{Rep}^0 A$ of “local modules” (called “dyslectic modules” in [Pa]) for an algebra A in \mathcal{C} . A fundamental theorem of Huang, Kirillov, and Lepowsky [HKL] states that vertex operator algebra extensions of V in \mathcal{C} are precisely commutative algebras A in \mathcal{C} with injective unit and trivial twist (the generalization to superalgebra extensions was obtained in [CKL]). It is also shown in [HKL] that the module category for the extension algebra A agrees with $\text{Rep}^0 A$ as categories (see [CKL] for the superalgebra case). Our main theoretical contribution is to show that in fact $\text{Rep}^0 A$ agrees with the category of A -modules in \mathcal{C} as braided tensor categories, where the category of A -modules is given the braided tensor category structure of [HLZ1]-[HLZ8]. This means that all abstract tensor-categorical constructions in [KO] apply naturally in the vertex algebraic setting.

The main tensor-categorical tool from [KO] that we use in applications to specific vertex operator (super)algebra extensions is the induction functor. For any object W in the category \mathcal{C} of V -modules, the tensor product $A \boxtimes W$ in \mathcal{C} naturally has the structure of a possibly non-local A -module. By restricting to the subcategory \mathcal{C}^0 consisting of objects W such that $A \boxtimes W$ is local, we get an induction tensor functor from \mathcal{C}^0 to $\text{Rep}^0 A$. Induced modules have been constructed previously in the context of vertex operator algebra extensions $V^G \subseteq V$ where V^G is the fixed-point subalgebra of a finite group G of automorphisms of V [DLi, Ya2, CaM], but so far, there has not been systematic use of induction for general vertex operator (super)algebra extensions. In this work, we shall show that in a suitable sense, induction is a vertex tensor functor, which allows one to relate tensor-categorical data for V -modules to tensor-categorical data for A -modules.

In the following subsections, we discuss in more detail the vertex tensor category theory needed for applying [KO] to vertex operator algebras, the types of vertex operator superalgebra extensions we would like to consider, and the results we obtain in this paper.

1.1 Vertex tensor categories

Module categories for vertex operator (super)algebras that are vertex tensor categories have a rich complex analytic structure that can be specialized to braided tensor category structure. However, the full analytic structure is crucial for our investigation, as we explain here and later. For excellent background on vertex tensor categories, see the survey article [HL6], and for more details, see [HL1].

We recall the main features in the definition of a vertex operator algebra. A vertex operator algebra is a (typically infinite-dimensional) graded vector space V with two distinguished vectors: the vacuum $\mathbf{1}$ and the conformal vector ω , and equipped with a “multiplication” map, the vertex operator $Y(\cdot, x) \cdot : V \otimes V \rightarrow V((x))$, where x is a formal variable and $V((x))$ is the space of Laurent series with coefficients in V . The grading on V is typically given by the semisimple action of the operator $L(0) = \text{Coeff}_{x^{-2}} Y(\omega, x)$. One may specialize the variable x in $Y(\cdot, x) \cdot$ to a non-zero complex number z thereby yielding an element of the algebraic completion \overline{V} of V (\overline{V} is the direct product, as opposed to direct sum, of the graded homogeneous subspaces of V , or equivalently is the full dual of the graded dual of V). The deepest axiom that $Y(\cdot, x) \cdot$ satisfies is the so-called Jacobi identity, which can be equivalently formulated (in the presence of the other axioms) in terms of complex variables as follows: the three series

$$\langle v', Y(v_1, z_1)Y(v_2, z_2)v_3 \rangle \quad |z_1| > |z_2| > 0, \quad (1.1)$$

$$\langle v', Y(Y(v_1, z_1 - z_2)v_2, z_2)v_3 \rangle \quad |z_2| > |z_1 - z_2| > 0, \quad (1.2)$$

$$\langle v', Y(v_2, z_2)Y(v_1, z_1)v_3 \rangle \quad |z_2| > |z_1| > 0, \quad (1.3)$$

where $v_i \in V$ and $v' \in V'$, where V' is the graded dual of V , converge absolutely in the indicated domains to a common rational function in z_1, z_2 . The equality of the first and second functions above is a complex-analytic version of associativity for Y , while the equality of the first and third corresponds to commutativity of left multiplication operators. The vertex operator Y also satisfies a more direct analog of commutativity, called skew-symmetry:

$$e^{xL(-1)}Y(v_2, -x)v_1 = Y(v_1, x)v_2 \quad (1.4)$$

for $v_1, v_2 \in V$. The domains of (1.1), (1.2), and (1.3) and the corresponding equalities of rational functions are governed by certain sewing constraints for Riemann spheres with positively and negatively oriented punctures, thereby making a vertex operator algebra an algebra over the (partial) operad given by the moduli space of such spheres [Hu1]. In this sense, vertex operator algebras are a “complexification” of the notion of commutative associative algebra.

Given modules W_i for a vertex operator algebra V , an intertwining operator $\mathcal{Y} : W_1 \otimes W_2 \rightarrow W_3\{x\}$ (here braces denote arbitrary complex powers of x) is again defined using a Jacobi identity [FHL]. For vertex operator algebras in logarithmic conformal field theory, it becomes necessary to consider logarithmic intertwining operators [Mil1, Mil2], whose target space is $W_3[\log x]\{x\}$. One can choose a branch of logarithm and specialize complex powers of x and integer powers of $\log x$ in a logarithmic intertwining operator to corresponding powers of a specific complex number $z \in \mathbb{C}^\times$ and its logarithm to obtain $P(z)$ -intertwining maps [HLZ3]. This, however, is not a definition of intertwining maps, which are instead defined via a Jacobi identity involving z . Intertwining operators and maps are central to the definition of tensor product of vertex operator algebra modules.

The equalities of the analytic functions in (1.1), (1.2), and (1.3) when the vertex operators Y in each series are replaced with general (and possibly different) intertwining operators between appropriate modules is now very subtle. In this generality, the series no longer converge to rational functions; in fact, they should converge to multivalued analytic functions due to the presence of non-integral powers of z (and perhaps logarithms as well). The associativity relation for general intertwining operators is called the operator product expansion in physics and is not known to exist for general categories of modules for arbitrary vertex operator algebras. Importantly, the operator product expansion is required in many scenarios, the earliest instance being the proof of Frenkel, Lepowsky, and Meurman that the moonshine module V^\natural is a vertex operator algebra [FLM]. In vertex tensor category theory, the existence of the operator product expansion is equivalent to the existence of associativity isomorphisms between triple tensor products of modules (see [Hu2, Theorem 14.11] and [HLZ6, Theorems 10.3 and 10.6]).

As with the vertex operator of a vertex operator algebra, the required commutativity and associativity properties for multivalued analytic functions defined by compositions of intertwining operators are governed by sewing constraints for Riemann spheres with punctures. The notion of vertex tensor category is then designed precisely to reflect these constraints. Given modules W_1 and W_2 for a vertex operator algebra, one should have tensor products $W_1 \boxtimes_{P(z)} W_2$ parametrized by elements $P(z)$ of the moduli space of Riemann spheres with punctures at ∞ , $z \neq 0$, and 0 , and with specified local coordinates at the punctures. The $P(z)$ -tensor product, if it exists, is a module $W_1 \boxtimes_{P(z)} W_2$ equipped with a $P(z)$ -intertwining map $\boxtimes_{P(z)} : W_1 \otimes W_2 \rightarrow \overline{W_1 \boxtimes_{P(z)} W_2}$ that satisfies the following universal property: Given any test module W and $P(z)$ -intertwining map $I : W_1 \otimes W_2 \rightarrow \overline{W}$, there exists a unique morphism $\eta : W_1 \boxtimes_{P(z)} W_2 \rightarrow W$ such that the following diagram commutes:

$$\begin{array}{ccc} W_1 \otimes W_2 & \xrightarrow{I} & \overline{W} \\ \downarrow \boxtimes_{P(z)} & \nearrow \eta & \\ \overline{W_1 \boxtimes_{P(z)} W_2} & & \end{array}$$

where $\overline{\eta}$ is the natural extension of η to algebraic completions. The vertex operator algebra is a unit with respect to each $P(z)$ -tensor product. Associativity of tensor products follows from existence of operator product expansions for compositions of $P(z)$ -tensor product intertwining maps, and braiding comes from skew-symmetry for intertwining operators. The module homomorphism $e^{2\pi i L(0)}$ yields a twist on a vertex tensor category. For a quick yet detailed review of these concepts, see Section 3.3. When the varying $z \in \mathbb{C}^\times$ are carefully specialized to a single fixed complex number (typically, $z = 1$) one obtains a braided monoidal category with a twist. However, this procedure necessarily loses information, analogous to forgetting the complex structure on a Riemann surface and remembering only the topological structure. The specialization procedure is necessarily subtle: since pairs (z_1, z_2) with $z_1 = z_2$ do not belong to any of the domains in (1.1), (1.2), (1.3), the multivalued analytic functions arising from compositions of tensor product intertwining maps typically have singularities at these points.

As mentioned above, the notion of vertex tensor category incorporating the considerations above was first formulated by Huang and Lepowsky in [HL1]. In [HL2, HL3, HL4, Hu2] they showed how to endow the module categories of “rational” vertex operator algebras with such structure. Their results embrace many well-known examples, for example vertex operator algebras based on affine Lie algebras at positive integral levels [HL5], Virasoro minimal models [Hu3], lattice vertex operator algebras, and the moonshine module V^\natural . Using vertex tensor category structure, Huang solved the two major important problems we have mentioned above: determination of the modularity of these categories and the Verlinde conjecture.

Going beyond rationality, vertex tensor categories for vertex operator algebras in logarithmic conformal field theory have been constructed in [HLZ1]-[HLZ8], subject to certain conditions, in particular existence of the logarithmic operator product expansion. In this case, the action of $L(0)$ on modules need not be semisimple, and correspondingly, intertwining operators may have logarithmic terms. Huang has shown in [Hu8] that the full category of (grading-restricted, generalized) modules for a C_2 -cofinite vertex operator algebra satisfies the conditions of [HLZ1]-[HLZ8] for the existence of vertex tensor category structure (actually, the conditions on the vertex operator algebra needed in [Hu8] are somewhat more relaxed than C_2 -cofiniteness, but this is sufficient). However, there are many interesting vertex operator algebras for which it is unknown whether natural representation categories can be given vertex tensor structure. Examples include the C_1 -cofinite module categories for singlet vertex operator algebras (see Section 6 of [CMR]) and module categories for affine Lie algebras at admissible levels. (Since the first version of this paper was written, there has been progress on these two examples. For singlet algebras, rigid vertex tensor structure is now known on the subcategory of so-called “atypical” modules [CMY1], though not yet on the full C_1 -cofinite module category. For affine Lie algebras at admissible levels, vertex tensor structure is now known on the C_1 -cofinite module category [CHY], and this category is rigid at least for simply-laced types [Cr2]. There are also results for some affine vertex tensor categories at non-admissible levels [CY]. However, it is still an open problem to construct vertex tensor categories that include non- C_1 -cofinite modules for affine Lie algebras, such as relaxed highest-weight modules and their images under spectral flow.)

The concept of vertex tensor category applies equally well to vertex operator superalgebras. Vertex tensor categories for superalgebras include minimal models for the $N = 1$ superconformal algebra and unitary minimal models for the $N = 2$ superconformal algebra [HM1, HM2], as well as a non-semisimple example coming from the affine vertex operator superalgebra of $\mathfrak{gl}(1|1)$ [CMY2].

1.2 Motivation

The first motivation for our study of vertex operator algebra extensions concerns the invariant theory of vertex operator algebras, in which two types of extensions appear. First, if V is a vertex operator algebra and G is a group of automorphisms of V , then we have an extension $V^G \subseteq V$, where V^G is the vertex operator subalgebra of G -fixed points. Secondly, if B is a vertex operator subalgebra of V (with generally different conformal vector), then the vertex operator subalgebra of V that commutes with B , $C = \text{Com}(B, V)$, is called the B -coset vertex operator algebra of V , and V is an extension of $B \otimes C$.

In many applications, we understand V and B fairly well, but we would like to understand the representation theory of either the orbifold V^G or the coset C . These are called the orbifold and coset problems, respectively. Conversely, the inverse orbifold (respectively, inverse coset) problem occurs when we understand V^G (respectively, $B \otimes C$) reasonably well, but we would like to understand the representation theory of V . The theory of our work exactly applies to the inverse orbifold and coset problems because our starting assumption is an extension $V \subseteq A$ where the smaller algebra V already has a braided tensor category of modules. Interestingly, we can also handle the coset problem efficiently, and we illustrate this in Section 4.3 for parafermionic cosets, where the vertex operator subalgebra B is a lattice vertex operator algebra. In this setting, when V is in particular an affine vertex operator algebra at positive integral level, the coset problem has been analyzed previously in [ADJR, ALY, DLY, DLWY, DR, DW1, DW2, DW3]. A better understanding of the orbifold problem requires the study of G -crossed tensor categories [Tu2, Ga, Mü1, Mü2, Ki1, Ki2] in the context of vertex operator algebras; we plan to contribute to this problem in the near future (since the first version of this paper was written, one of us has completed an extensive study of the orbifold problem in [McR], using the theory developed in this work).

The examples of inverse coset problems that we have in mind and which can be understood better with the aid of our results are certain affine Lie superalgebra vertex operator superalgebras at integer and also non-integer admissible levels. Very little is known about the representation theory of affine vertex operator superalgebras, although there are character formulae for certain atypical modules in terms of mock Jacobi forms [KW3, KW4, KW5] and there is a fairly good understanding of $V_k(\mathfrak{gl}(1|1))$ [CRi2]. Let us announce here that various affine vertex operator superalgebras are extensions of known vertex operator algebras. Unlike for parafermionic cosets, these superalgebra extensions are not of simple current type. Nonetheless, in examples like the affine vertex operator superalgebra of $\mathfrak{osp}(1|2)$, the representation category can be completely described in terms of the underlying vertex operator subalgebra [CFK]. That work is a nice interplay between the use of tensor categories (including our results) and Jacobi form computations. The key steps are: first, a decomposition of characters that determines the decomposition of $L_k(\mathfrak{osp}(1|2))$ into $L_k(\mathfrak{sl}_2) \otimes \text{Vir}$ -modules, where Vir is the simple Virasoro vertex operator algebra of

appropriate central charge. This determines the superalgebra object in the modular tensor category of $L_k(\mathfrak{sl}_2) \otimes \text{Vir}$ -modules corresponding to $L_k(\mathfrak{osp}(1|2))$. The second step is to use the induction functor to find as many simple local modules as possible, and the last step is to use the modular S -matrix together with the Frobenius-Perron theorem of [DMNO] to conclude that one has found all inequivalent simple modules. The induction tensor functor then also determines the fusion rules of both local and twisted $L_k(\mathfrak{osp}(1|2))$ -modules. A few additional subtleties arise because $L_k(\mathfrak{osp}(1|2))$ is a vertex operator superalgebra; to our knowledge, this is the first description of a series of \mathbb{Z} -graded rational vertex operator superalgebras. We are optimistic that some affine vertex operator superalgebras of type $\mathfrak{sl}(n|1)$ and $D(2, 1; \alpha)$ can also be studied using our methods, and this is under investigation. The latter vertex operator superalgebra plays a crucial role in the quantum geometric Langlands correspondence of \mathfrak{sl}_2 as well as in four-dimensional supersymmetric quantum field theories [CGai].

The second motivation for our work here is the Verlinde formula [Ve], which is central to vertex operator algebra theory since it relates analytic data in the form of modular properties of torus one-point functions to categorical data in the form of representations of the fusion ring. This formula has been proven for module categories of regular vertex operator algebras by Huang [Hu6] and it is important to extend these results beyond rationality, for example to C_2 -cofinite but non-rational vertex operator algebras (see [CGan] for the state of the art) or even beyond finite tensor categories; see [AC, CrM, CRi3, CRi1, CRi4] for examples. A nice application of our main results are Verlinde formulae for regular vertex operator superalgebras and $\frac{1}{2}\mathbb{Z}$ -graded regular vertex operator algebras; see Sections 1.5 and 4.2. Understanding the Verlinde formula amounts to relating the complex analytic properties of intertwining operators and their correlation functions to categorical and topological field theory data. Correlation functions are solutions to sewing constraints, and such solutions are uniquely specified by a simple special symmetric Frobenius algebra in the representation category of the chiral algebra of the conformal field theory. A related motivation or future goal is thus to connect the vertex operator algebra approach to conformal field theory and its correlation functions (see [HK1, HK2, HK3, Ko] for important developments) with the topological field theory approach of Fuchs, Fjelstad, Runkel and Schweigert ([FRS1, FRS2, FFRS1, FFRS2]; see [FuS] for a review).

Conformal nets are another approach to conformal field theory using tensor categories. There has been progress in relating this area to the vertex operator algebra point of view [Kawah, CKLW, BLKR]. Each approach has its advantages and vertex operator algebra theory together with tensor categories might succeed in proving important statements that are known from the conformal net standpoint. A nice example is the fairly recent solution to the mirror extension problem for coset vertex operator algebras [OS, Lin, CKM]. Another useful tool in the conformal net approach is α -induction [LR, Xu1, B E1, B E2, BEK, Os], a braided functor from a modular tensor category \mathcal{C} to the category of module endofunctors of a certain module category over \mathcal{C} . This functor is used to construct modular invariants for conformal field theory and is in general important in understanding the categorical part of bulk and boundary conformal field theory (see for example [FRS3, Section 3]). We now have a good induction functor for vertex operator algebras, and it is surely a valuable continuation of our work to connect vertex operator algebras to α -induction.

Beyond vertex operator algebras and conformal nets, it is well known that quantum groups are rich sources of braided tensor categories. Since the results we prove in Section 2 below hold for (super)algebras in essentially any braided tensor category, they also apply to quantum groups. For example, after the first version of this paper appeared, and inspired by our work, the following problem was solved. It was conjectured in [FGST1] that the representation categories of triplet vertex operator algebras and of restricted quantum groups of \mathfrak{sl}_2 at corresponding roots of unity are braided tensor equivalent. However, it turns out that the latter categories are not braidable [KS], so the next question is whether the quantum group category can be modified to a braided tensor category. Indeed, in [CGR], a quasi Hopf algebra was constructed that is isomorphic to the quantum group as an algebra but has modified comultiplication and associator; its representation category is braidable and now conjecturally equivalent to that of the triplet vertex operator algebra. This quasi Hopf algebra was constructed through careful study of the category of local modules for a certain algebra object in the category of weight modules for the corresponding unrolled restricted quantum group of \mathfrak{sl}_2 . This procedure, using (super)algebras in braided tensor categories, has now become a powerful method for constructing non-degenerate finite braided tensor categories and supercategories [GLO, Ne, CRu].

1.3 Results on vertex operator (super)algebra extensions and their modules

With the above motivation in mind we recall the known results on vertex operator algebra extensions and present our main theorem. We always work in the following setting:

Assumption 1.1. V is a vertex operator algebra and \mathcal{C} is a category of V -modules with a natural vertex tensor category structure.

If V is regular, its representation category \mathcal{C} is modular. There are however interesting vertex operator algebras, such as the triplet algebras $\mathcal{W}(p)$ [TW1], whose representations form braided tensor categories, but not all modules are completely reducible. The foundation of our work is the following key result of [HKL, Theorems 3.2 and 3.4] (see also [CKL, Theorems 3.13 and 3.14] for the natural superalgebra generalization):

Theorem 1.2. *A vertex operator algebra extension $V \subseteq A$ in \mathcal{C} is equivalent to a commutative associative algebra in the braided tensor category \mathcal{C} with trivial twist and injective unit. Moreover, the category of local \mathcal{C} -algebra modules $\text{Rep}^0 A$ is isomorphic to the category of modules in \mathcal{C} for the extended vertex operator algebra A .*

This powerful result allows one to study vertex operator algebra extensions using abstract tensor category theory. For example, Lin has used it to solve the mirror extension problem in coset vertex operator algebras [Lin] (see also [CKM]). In order to study representations of the extended vertex operator algebra, one needs the monoidal structure on the category of local \mathcal{C} -algebra modules $\text{Rep}^0 A$. Kirillov and Ostrik have given $\text{Rep}^0 A$ a braided tensor category structure [KO], but several problems need resolution before this can be applied in the vertex operator algebra context. First, we need to work in a more general setting than [KO]: we do not assume \mathcal{C} is rigid, semisimple, or strict (in fact, vertex tensor categories are highly non-strict due to the subtlety of the associativity isomorphisms). Secondly, we would like to consider superalgebra extensions of vertex operator algebras, and therefore we need superalgebra analogues of all relevant constructions and results in [KO].

To handle superalgebra extensions of V , we first introduce an auxiliary supercategory \mathcal{SC} which amounts to the category \mathcal{C} of V -modules but with V viewed as a vertex operator superalgebra having zero odd component. In other words, V -modules in \mathcal{SC} have parity decompositions which may or may not be trivial. As categories, \mathcal{C} and \mathcal{SC} are equivalent, but \mathcal{SC} has additional supercategory structure, that is, morphisms can be even or odd according as they preserve or reverse parity decompositions. We define a superalgebra A in \mathcal{C} to be a commutative associative algebra with even structure morphisms in the braided tensor supercategory \mathcal{SC} , and we define the categories $\text{Rep} A$ and $\text{Rep}^0 A$ of A -modules and local A -modules in \mathcal{C} to be those A -modules in \mathcal{SC} having even structure morphisms. Assuming only that \mathcal{C} is abelian and that the tensor product on \mathcal{C} is right exact, we then fix a superalgebra A in \mathcal{C} and prove:

- $\text{Rep}^0 A$ is an additive braided monoidal supercategory (Theorem 2.55, corresponding to [KO, Theorem 1.10]).
- The induction functor from \mathcal{C} (or \mathcal{SC}) to the category $\text{Rep} A$ of not necessarily local A -modules is a tensor functor (Theorem 2.59, corresponding to [KO, Theorem 1.6]).

More importantly, before applying the constructions and results of [KO] to vertex operator (super)algebras, we need to make sure that the braided monoidal (super)category structure on $\text{Rep}^0 A$ is the correct structure in the vertex-algebraic sense, that is, we need to make sure that it agrees with the vertex tensor category constructions of [HLZ1]-[HLZ8]. We accomplish this in Section 3, culminating in our main result, Theorem 3.65:

Theorem 1.3. *Suppose A is a (super)algebra extension of V in \mathcal{C} such that V is contained in the even part of A . Then the isomorphism of categories given in [HKL, Theorem 3.4] between $\text{Rep}^0 A$ and the category of vertex-algebraic A -modules in \mathcal{C} is an isomorphism of braided monoidal (super)categories.*

This theorem is a considerable strengthening of [HKL, Theorem 3.4] and has numerous useful consequences. Perhaps the first is that if A is a vertex operator (super)algebra extension of \mathcal{C} , then the category of A -modules in \mathcal{C} actually has vertex tensor category structure given by the constructions of [HLZ1]-[HLZ8] (with the corresponding braided monoidal (super)category structure as in [KO]). Secondly, combining this theorem with Theorems 2.59 and 2.67, we prove in Theorem 3.68:

Theorem 1.4. *Induction is a vertex tensor functor on the (not necessarily abelian) full subcategory of V -modules inducing to A -modules, with respect to the vertex tensor category structures on these categories constructed in [HLZ8].*

This theorem means that induction respects all vertex tensor category structure, in particular $P(z)$ -tensor products for each $z \in \mathbb{C}^\times$, unit, associativity, and braiding isomorphisms. Thus induction can be applied in a vertex-algebraic setting: some applications are given in Section 4. In particular, we find Verlinde formulae for vertex operator superalgebras and $\frac{1}{2}\mathbb{Z}$ -graded vertex operator algebras, and we study cosets of rational vertex operator algebras by lattice vertex operator algebras in generality. The proof of Theorem 3.65 occupies much of this paper, and we now briefly sketch the main steps:

1. First, after discussing the notion of a commutative associative algebra A in \mathcal{C} and its representation category $\text{Rep } A$, as defined in [KO, Pa], we formulate superalgebras in \mathcal{C} as algebras (with even structure morphisms) in the auxiliary supercategory \mathcal{SC} (see for example [BrE] for the formulation of supercategory and tensor supercategory that we use). The objects of \mathcal{SC} are essentially direct sums of two objects (even and odd) in \mathcal{C} , and the morphisms of \mathcal{SC} correspondingly have superspace decompositions into parity-preserving even morphisms and parity-reversing odd morphisms. Sign factors necessary for the supercommutativity of A are built into the braiding in \mathcal{SC} .
2. Next, we prove, under minimal assumptions on \mathcal{C} (namely, \mathcal{C} is abelian with right exact tensor functor) that $\text{Rep } A$ with its tensor product \boxtimes_A is an additive monoidal (super)category; in the superalgebra setting, $\text{Rep } A$ might not be abelian since non-homogeneous morphisms might not have kernels and cokernels. We provide details of this proof in Section 2. Actually, the assumption that \mathcal{C} is abelian is not strictly necessary: we only need certain morphisms to have cokernels.
3. In proving the associativity of \boxtimes_A , we introduce *categorical Rep A -intertwining operators* among a triple of objects in $\text{Rep } A$ that intertwine the action of A on each of these three objects. We then show that \boxtimes_A satisfies a universal property in terms of categorical intertwining operators in Section 2.4, in analogy with $P(z)$ -tensor products in vertex tensor categories. We further prove an associativity result for categorical intertwining operators in Section 2.5, which easily leads to the associativity of \boxtimes_A .
4. Once the proof that $\text{Rep } A$ is a monoidal (super)category is complete, we prove that the subcategory $\text{Rep}^0 A$ of local A -modules is braided.
5. In Section 3, we begin to “complexify” these results when \mathcal{C} is a module category for a vertex operator algebra V with vertex tensor category structure. From the definition of $P(1)$ -tensor products, every categorical $\text{Rep } A$ -intertwining operator $\eta : W_1 \boxtimes W_2 \rightarrow W_3$, where the W_i are objects of $\text{Rep } A$, corresponds to an intertwining operator of V -modules, say \mathcal{Y}_η , of type $\binom{W_3}{W_1, W_2}$ such that $\overline{\eta}(w_1 \boxtimes_{P(1)} w_2) = \mathcal{Y}_\eta(w_1, e^{\log 1} w_2)$.¹ In particular, the multiplication maps $\mu_W : A \boxtimes W \rightarrow W$ for W in $\text{Rep } A$ correspond to intertwining operators denoted Y_W .
6. In Section 3.4 we show that η is a categorical $\text{Rep } A$ -intertwining operator if and only if \mathcal{Y}_η satisfies a certain complex analytic associativity condition (analogue of the equality of (1.1) and (1.2)) and a skew-associativity condition (analogue of the equality of (1.2) and (1.3)) with the module maps Y_{W_i} . This is one of the technical sections of the paper, where some careful use of complex analysis is required (some results we collect in Section 3.7), similar to [HKL] and [HLZ8].
7. In Theorems 3.53 and 3.54 we show that for modules in $\text{Rep}^0 A$, the associativity and skew-associativity of a $\text{Rep } A$ -intertwining operator is equivalent to the Jacobi identity for vertex-algebraic intertwining operators among A -modules. Then the universal properties of \boxtimes_A and the vertex-algebraic tensor product $\boxtimes_{P(1)}$ for A -modules quickly imply that these two tensor products are equivalent.
8. Finally, in Section 3.5 we show that, with the identification of \boxtimes_A with $\boxtimes_{P(1)}$, the braided monoidal (super)category structure on $\text{Rep}^0 A$ (in particular, unit, associativity, and braiding isomorphisms) agrees with the (vertex-algebraic) braided tensor category constructions for A -modules in [HLZ8]. This completes the proof of Theorem 3.65. We in fact show that $\text{Rep}^0 A$ has a vertex tensor category structure. The category $\text{Rep } A$ has some (not all!) features of a vertex tensor category.

In Section 2 we also prove properties of the induction functor $\mathcal{F} : \mathcal{SC} \rightarrow \text{Rep } A$ that will be needed for applications. In Section 2.7, we prove that \mathcal{F} is a tensor functor and left adjoint to the restriction functor $\mathcal{G} : \text{Rep } A \rightarrow \mathcal{SC}$. Then in Section 2.8, we show that induction respects additional structures on \mathcal{SC} , $\text{Rep } A$, and $\text{Rep}^0 A$, including duals and, under suitable conditions, twists. We also give a necessary and sufficient condition for an object of \mathcal{SC} to induce to $\text{Rep}^0 A$, and show that on the full subcategory

¹The perhaps strange notation $x \mapsto e^{l_p(z)}$ indicates the substitutions $x^h \mapsto e^{h l_p(z)}$ and $(\log x)^n \mapsto (l_p(z))^n$ for $h \in \mathbb{C}$ and $n \in \mathbb{N}$, where l_p for $p \in \mathbb{Z}$ denotes the p th branch of logarithm, that is, $2\pi i p \leq \text{Im } l_p(z) < 2\pi i(p+1)$. The principal branch corresponding to $p=0$ we simply denote by $\log z$.

\mathcal{SC}^0 of objects that induce to $\text{Rep}^0 A$, \mathcal{F} is a braided tensor functor. Section 2.8 culminates in the proof that, if \mathcal{C} (or \mathcal{SC}) is a ribbon category and A has trivial twist, then \mathcal{F} respects categorical S -matrices (traces of monodromy isomorphisms) of objects that induce to $\text{Rep}^0 A$. We use this result to deduce S -matrices for parafermions in Section 4. We show that induction respects all vertex tensor category structure on \mathcal{SC}^0 and $\text{Rep}^0 A$, that is, induction is a vertex tensor functor, in Section 3.6.

1.4 Tensor categories of regular vertex operator superalgebras

It was shown in [Hu7] that if V is a (\mathbb{Z} -graded) simple, CFT type, self-contragredient, rational, C_2 -cofinite vertex operator algebra, then the vertex tensor category of V -modules is a modular tensor category. CFT type means that V has no negative conformal weight spaces and $V_0 = \mathbb{C}\mathbf{1}$, and rational means that \mathbb{N} -gradable weak V -modules (also called admissible V -modules) are completely reducible. By [ABD], in the presence of the other assumptions, rationality and C_2 -cofiniteness can be replaced by the assumption that V is regular in the sense of [DLM2]. Thus for simplicity we shall use the term regular to refer to any vertex operator algebra satisfying the assumptions of [Hu7].

There are three natural ways to generalize the notion of vertex operator algebra, and hence also of regular vertex operator algebra:

1. $V = \bigoplus_{n \in \mathbb{Z}} V_n$ is a \mathbb{Z} -graded vertex operator superalgebra,
2. $V = \bigoplus_{n \in \frac{1}{2}\mathbb{Z}} V_n$ is a $\frac{1}{2}\mathbb{Z}$ -graded vertex operator algebra, and
3. $V = \bigoplus_{n \in \frac{1}{2}\mathbb{Z}} V_n$ is a $\frac{1}{2}\mathbb{Z}$ -graded vertex operator superalgebra.

The axioms defining $\frac{1}{2}\mathbb{Z}$ -graded vertex operator algebras are the same as those briefly discussed in Section 1.1, except that the eigenvalues of the semisimple action of $L(0)$ are allowed to be half integers. The notions of \mathbb{Z} - and $\frac{1}{2}\mathbb{Z}$ -graded vertex operator superalgebras are obtained by introducing a parity decomposition and an appropriate sign factor in (1.3) (and also (1.4)). Concrete examples of all three types of (super)algebra are discussed in Section 4: \mathbb{Z} -graded vertex operator superalgebras include affine vertex superalgebras, while superconformal algebras are $\frac{1}{2}\mathbb{Z}$ -graded superalgebras. The $\beta\gamma$ -vertex algebra and the Bershadsky-Polyakov algebra [Be, Po] are perhaps the best-known $\frac{1}{2}\mathbb{Z}$ -graded vertex operator algebras. All three generalizations of vertex operator algebra arise as \mathcal{W} -superalgebras, that is, quantum Hamiltonian reductions of affine vertex superalgebras, which are important in connections to physics and geometry (see for example [GR, CL3]).

The boson-fermion statistics of particle physics says that a boson has integral spin and a fermion has half-integral spin. We thus call the first two generalizations above a vertex operator algebra, respectively a vertex operator superalgebra, of incorrect or wrong statistics, while the third we call a vertex operator superalgebra of correct statistics if its even part is $V^0 = \bigoplus_{n \in \mathbb{Z}} V_n$ and its odd part is $V^1 = \bigoplus_{n \in \frac{1}{2}\mathbb{Z}} V_n$. If V falls into one of the three cases above, then $\text{Aut}(V)$ contains a copy of $\mathbb{Z}/2\mathbb{Z}$, generated by the parity involution $P_V = 1_{V^0} \oplus (-1_{V^1})$ in the superalgebra cases and generated by the twist $\theta_V = e^{2\pi i L(0)}$ in the $\frac{1}{2}\mathbb{Z}$ -graded cases (these two automorphisms coincide for a vertex operator superalgebra of correct statistics). Either way, we have a decomposition into ± 1 -eigenspaces for the action of $\mathbb{Z}/2\mathbb{Z}$ on V :

$$V = V_+ \oplus V_-.$$

If the orbifold (\mathbb{Z} -graded) vertex operator subalgebra V_+ is regular, then a small generalization of [CaM, Theorem 4.2] (see [CKLR, Appendix A]) shows that V_- is a self-dual simple current for the orbifold vertex operator algebra V_+ . In particular, the fusion product of V_- with itself is

$$V_- \boxtimes_{V_+} V_- \cong V_+.$$

The statistics of V is reflected in the categorical dimension of V_- . One gets a vertex operator (super)algebra of correct boson-fermion statistics if $\text{qdim}(V_-) = 1$ and of incorrect type if $\text{qdim}(V_-) = -1$.

In each of the three cases the representation category of the vertex operator (super)algebra V is the category of local modules of a corresponding (super)algebra object in the category \mathcal{C} of V_+ -modules [CKL]. This has a few nice direct consequences. First, it tells us something about the monoidal category of local V -modules: since the twist in a vertex tensor category is $e^{2\pi i L(0)}$ with $L(0)$ the Virasoro zero-mode giving the conformal weight grading, the twist is not a V -module homomorphism when V is a $\frac{1}{2}\mathbb{Z}$ -graded vertex operator (super)algebra. On the other hand, $e^{2\pi i L(0)}$ still defines a twist on the category of local V -modules in case 1. In any case, braiding induces nicely and so local modules in case 2

form a braided tensor category, while for cases 1 and 3 one needs a superbraiding, a braiding with parity. This superbraiding is defined using the braiding on objects in \mathcal{C} , and it satisfies the hexagon axioms and an appropriate “supernaturality” so that it defines the structure of a braided monoidal supercategory on local V -modules. See Section 2.2 for more details on braided monoidal supercategories.

In superconformal field theory both Neveu-Schwarz and Ramond modules are of interest. The first correspond to local objects in the category of superalgebra modules and the second to certain non-local modules which we will call twisted (in fact, they are twisted modules for the parity automorphism of V). We will see in the discussion of Verlinde’s formula that it is indeed necessary to also consider twisted superalgebra modules.

As mentioned above, we will give a few examples in Section 4, in particular a fairly detailed discussion of rational $N = 2$ superconformal algebras in Section 4.4.2 and then short discussions of a Bershadsky-Polyakov algebra in Section 4.4.3 and a rational W -superalgebra associated to $\widehat{\mathfrak{sl}}(3|1)$ in Section 4.4.4. For the detailed example of regular affine vertex operator superalgebras associated to $\widehat{\mathfrak{osp}}(1|2)$, see [CFK].

1.5 Verlinde formulae for regular $\frac{1}{2}\mathbb{Z}$ -graded vertex operator superalgebras

One nice application of our general results is a Verlinde formula for the three cases of (super)algebra extensions discussed in the previous subsection. The Verlinde formula, conjectured in [Ve] and proven in the regular vertex operator algebra setting by Huang [Hu6], is a true highlight of vertex operator algebra theory: it says that fusion rules are given by a concrete expression in terms of the entries of the modular S -matrix of characters, thus, for example, providing an efficient way of computing fusion rules. Since the representation category for each case of regular vertex operator (super)algebra discussed above is the category of local modules for a corresponding (super)algebra object in the modular tensor category of V_+ , we can use induction to deduce interesting consequences for V -modules (as for example Verlinde’s formula) from corresponding properties for V_+ -modules. We do so in Section 4.2, and since this is quite technical, we here redescribe the results purely in terms of modular and asymptotic properties of characters and supercharacters of V .

1.5.1 \mathbb{Z} -graded vertex operator superalgebras

Suppose V is a regular \mathbb{Z} -graded vertex operator superalgebra. Then we view V as an order-2 simple current extension of its even vertex operator subalgebra, which means the representation category of V is the representation category of the superalgebra extension $V^{\bar{0}} \subseteq V$. Every simple $V^{\bar{0}}$ -module induces to either a local or twisted module in $\text{Rep } V$. By [HKL, Theorem 3.4] and our Theorem 3.65, $\text{Rep}^0 V$ is the braided monoidal supercategory of untwisted V -modules. The subcategories of local and twisted modules we denote by $\text{Rep}^0 V$ and $\text{Rep}^{\text{tw}} V$, respectively. We call an object in $\text{Rep } V$ homogeneous if it is either local or twisted. There are only finitely many inequivalent simple objects in $\text{Rep } V$, and we denote by $[\text{Rep } V]$ the set of equivalence classes for the relation

$$X \sim Y \quad \text{if and only if } X \cong Y \text{ as modules for } V^{\bar{0}}.$$

That is, we consider objects that only differ by parity to be equivalent. Let $\mathbb{C}[\text{Rep } V]$ be the complex vector space with basis labeled by the elements of $[\text{Rep } V]$. Let $L(0)$ be the Virasoro zero-mode of V and c the central charge; then the character and supercharacter of objects are defined respectively as the graded trace and supertrace:

$$\text{ch}^+[X](\tau, v) := \text{tr}_X \left(q^{L(0) - \frac{c}{24}} o(v) \right) \quad \text{and} \quad \text{ch}^- [X](\tau, v) := \text{str}_X \left(q^{L(0) - \frac{c}{24}} o(v) \right), \quad q = e^{2\pi i \tau}.$$

Here $v \in V^{\bar{0}}$ is even and $o(v)$ the zero-mode of the corresponding vertex operator. This is needed to ensure linear independence of characters of inequivalent modules. Characters of equivalent modules coincide and supercharacters coincide up to a possible sign. The \mathbb{C} -linear span of characters as well as supercharacters is thus isomorphic to the vector space $\mathbb{C}[\text{Rep } V]$ whose basis elements are labeled by the elements of $[\text{Rep } V]$. We fix one representative of each equivalence class and thus fix a choice of parity for each class. By abuse of notation, we denote this set of representatives by $[\text{Rep } V]$ as well and its untwisted and twisted subsets by $[\text{Rep}^0 V]$ and $[\text{Rep}^{\text{tw}} V]$, respectively. Then Möbius transformations on the linear span of these characters and supercharacters define an action of $\text{SL}(2, \mathbb{Z})$. If $v \in V^{\bar{0}}$ has conformal weight $\text{wt}[v]$ with respect to Zhu’s modified vertex operator algebra structure on $V^{\bar{0}}$ [Zh], the

modular S -transformation has the form

$$\begin{aligned}\mathrm{ch}^+[X]\left(-\frac{1}{\tau}, v\right) &= \tau^{\mathrm{wt}[v]} \sum_{Y \in [\mathrm{Rep}^{\mathrm{tw}} V]} S_{X,Y} \mathrm{ch}^-[Y](\tau, v) \\ \mathrm{ch}^-[X]\left(-\frac{1}{\tau}, v\right) &= \tau^{\mathrm{wt}[v]} \sum_{Y \in [\mathrm{Rep}^0 V]} S_{X,Y} \mathrm{ch}^-[Y](\tau, v)\end{aligned}\tag{1.5}$$

if X is local and

$$\begin{aligned}\mathrm{ch}^+[X]\left(-\frac{1}{\tau}, v\right) &= \tau^{\mathrm{wt}[v]} \sum_{Y \in [\mathrm{Rep}^{\mathrm{tw}} V]} S_{X,Y} \mathrm{ch}^+[Y](\tau, v) \\ \mathrm{ch}^-[X]\left(-\frac{1}{\tau}, v\right) &= \tau^{\mathrm{wt}[v]} \sum_{Y \in [\mathrm{Rep}^0 V]} S_{X,Y} \mathrm{ch}^+[Y](\tau, v)\end{aligned}\tag{1.6}$$

if X is twisted. The modular T -transformation acts diagonally on characters and supercharacters of simple local modules and maps characters of twisted modules to the corresponding supercharacters and vice versa. Especially, we see that the linear span of local supercharacters already forms a vector-valued modular form for the modular group.

Let Z be a simple module; we call an intertwining operator of type $\begin{pmatrix} Z \\ X Y \end{pmatrix}$ for X, Y in $[\mathrm{Rep} V]$ even if Z has the same parity as its representative in $[\mathrm{Rep} V]$ and it is called odd if it has reversed parity. Obviously this choice of parity depends on our choice of representatives $[\mathrm{Rep} V]$. We define the fusion rules as dimensions and superdimensions of spaces of intertwining operators. Verlinde's formula for \mathbb{Z} -graded vertex operator superalgebras is then

$$\begin{aligned}N^+_{X,Y}{}^W &= \delta_{t(X)+t(Y), t(W)} \sum_{Z \in [\mathrm{Rep}^{\mathrm{tw}} V]} \frac{S_{X,Z} \cdot S_{Y,Z} \cdot (S^{-1})_{Z,W}}{S_{V,Z}} \\ N^-_{X,Y}{}^W &= \delta_{t(X)+t(Y), t(W)} \sum_{Z \in [\mathrm{Rep}^0 V]} \frac{S_{X,Z} \cdot S_{Y,Z} \cdot (S^{-1})_{Z,W}}{S_{V,Z}}\end{aligned}\tag{1.7}$$

with

$$t : [\mathrm{Rep} V] \rightarrow \mathbb{Z}/2\mathbb{Z}, \quad X \mapsto \begin{cases} \bar{0} & \text{if } X \in [\mathrm{Rep}^0 V] \\ \bar{1} & \text{if } X \in [\mathrm{Rep}^{\mathrm{tw}} V] \end{cases}.$$

The fusion product is then

$$X \boxtimes_V Y \cong \bigoplus_{W \in [\mathrm{Rep} V]} \left(N^{\bar{0}}_{X,Y}{}^W W \oplus N^{\bar{1}}_{X,Y}{}^W \Pi(W) \right), \quad N^{\pm}_{X,Y}{}^W = N^{\bar{0}}_{X,Y}{}^W \pm N^{\bar{1}}_{X,Y}{}^W,$$

where Π is the parity reversal functor.

Under certain conditions one can get information on the fusion rules from asymptotic dimensions. Suppose there is a unique simple untwisted module $Z_{(+)}$ with lowest conformal dimension among all untwisted simple modules, and suppose there is also a unique simple twisted module $Z_{(-)}$ of lowest conformal dimension among all simple twisted modules. Assume that $\mathrm{ch}^-[Z_{(+)}]$ does not vanish and that the lowest conformal weight spaces of $Z_{(\pm)}$ are purely even. For a simple V -module X , we define the asymptotic (super)dimension by

$$\mathrm{adim}^{\pm}[X] = \lim_{iy \rightarrow i\infty} \frac{\mathrm{ch}^{\pm}[X](-1/iy)}{\mathrm{ch}^{\pm}[V](-1/iy)} = \frac{S_{X,Z_{(\mp)}}}{S_{V,Z_{(\mp)}}}\tag{1.8}$$

We find that for $X, Y \in [\mathrm{Rep} V]$, the product of asymptotic dimensions respects the fusion product in the sense that

$$\mathrm{adim}^{\pm}[X] \mathrm{adim}^{\pm}[Y] = \sum_{W \in [\mathrm{Rep} V]} N^{\pm}_{X,Y}{}^W \mathrm{adim}^{\pm}[W].\tag{1.9}$$

Some recent works such as [DJX, DW3] have used the asymptotic dimensions of certain ordinary rational vertex operator algebras to derive results on the representation categories of these vertex operator algebras. Note that what we call asymptotic dimension, these papers call quantum dimension; we prefer to avoid this terminology as it might lead to confusion with categorical dimension of objects.

An example illustrating the statements of this subsection is given in Section 4.4.4. Such Verlinde formulae were also conjectured in a non-rational setting, for the affine vertex operator superalgebra of $\mathfrak{gl}(1|1)$ [CRi2, CQS]; these conjectures have recently been confirmed by the fusion rule computations in [CMY2].

1.5.2 $\frac{1}{2}\mathbb{Z}$ -graded vertex operator algebras

Let V be a regular $\frac{1}{2}\mathbb{Z}$ -graded vertex operator algebra; examples include Bershadsky-Polyakov algebras at specific levels [Be, Po, Ar2]. Then V is an extension of its \mathbb{Z} -graded subalgebra V_+ , that is,

$$V = \bigoplus_{n \in \frac{1}{2}\mathbb{Z}} V_n = V_+ \oplus V_-, \quad V_+ = \bigoplus_{n \in \mathbb{Z}} V_n \quad \text{and} \quad V_- = \bigoplus_{n \in \mathbb{Z} + \frac{1}{2}} V_n.$$

The vertex operator algebra automorphism ± 1 on V_{\pm} generates an action of $\mathbb{Z}/2\mathbb{Z}$ on V with V_+ the corresponding orbifold vertex operator subalgebra. By [CaM] (see also the appendix of [CKLR]), V_- is then a self-dual simple current of V_+ . The representation category of V is as before the category of local modules for V viewed as an algebra in the category of V_+ -modules, and every simple V_+ -module induces to either a simple local V -module or a simple twisted V -module. Both are naturally $\mathbb{Z}/2\mathbb{Z}$ -graded,

$$X = X_+ \oplus X_-.$$

We denote by $[\text{Rep}^0 V]$ and $[\text{Rep}^{\text{tw}} V]$ sets of representatives of inequivalent simple local and twisted modules as explained in the last subsection. We define characters as before as well:

$$\text{ch}^{\pm}[X](\tau, v) := \text{tr}_{X_+} \left(q^{L(0) - \frac{c}{24}} o(v) \right) \pm \text{tr}_{X_-} \left(q^{L(0) - \frac{c}{24}} o(v) \right), \quad q = e^{2\pi i \tau},$$

where $o(v)$ is the zero-mode of the vertex operator for $v \in V_+$. It turns out that the form of the modular S -transformation and Verlinde's formula are essentially decided by the categorical dimension of V_- as a V_+ -module, which is -1 as in the case of \mathbb{Z} -graded vertex operator superalgebras. Thus these formulae are the same as before, that is, the modular S -transformation has the form

$$\begin{aligned} \text{ch}^+[X] \left(-\frac{1}{\tau}, v \right) &= \tau^{\text{wt}[v]} \sum_{Y \in [\text{Rep}^{\text{tw}} V]} S_{X,Y} \text{ch}^- [Y](\tau, v) \\ \text{ch}^- [X] \left(-\frac{1}{\tau}, v \right) &= \tau^{\text{wt}[v]} \sum_{Y \in [\text{Rep}^0 V]} S_{X,Y} \text{ch}^- [Y](\tau, v) \end{aligned} \quad (1.10)$$

if X is local and

$$\begin{aligned} \text{ch}^+[X] \left(-\frac{1}{\tau}, v \right) &= \tau^{\text{wt}[v]} \sum_{Y \in [\text{Rep}^{\text{tw}} V]} S_{X,Y} \text{ch}^+ [Y](\tau, v) \\ \text{ch}^- [X] \left(-\frac{1}{\tau}, v \right) &= \tau^{\text{wt}[v]} \sum_{Y \in [\text{Rep}^0 V]} S_{X,Y} \text{ch}^+ [Y](\tau, v) \end{aligned} \quad (1.11)$$

if X is twisted. The modular T -transformation acts diagonally on characters and supercharacters of simple twisted modules and maps characters of local modules to the corresponding supercharacters and vice versa. We observe that the linear span of twisted characters already forms a vector-valued modular form for the modular group. Verlinde's formula for $\frac{1}{2}\mathbb{Z}$ -graded vertex operator algebras is then

$$\begin{aligned} N_{X,Y}^{+W} &= \delta_{t(X)+t(Y),t(W)} \sum_{Z \in [\text{Rep}^{\text{tw}} V]} \frac{S_{X,Z} \cdot S_{Y,Z} \cdot (S^{-1})_{Z,W}}{S_{V,Z}} \\ N_{X,Y}^{-W} &= \delta_{t(X)+t(Y),t(W)} \sum_{Z \in [\text{Rep}^0 V]} \frac{S_{X,Z} \cdot S_{Y,Z} \cdot (S^{-1})_{Z,W}}{S_{V,Z}} \end{aligned} \quad (1.12)$$

with

$$t : [\text{Rep} V] \rightarrow \mathbb{Z}/2\mathbb{Z}, \quad X \mapsto \begin{cases} \bar{0} & \text{if } X \in [\text{Rep}^0 V] \\ \bar{1} & \text{if } X \in [\text{Rep}^{\text{tw}} V] \end{cases}.$$

The fusion product is then

$$X \boxtimes_V Y \cong \bigoplus_{W \in [\text{Rep} V]} \left(N_{X,Y}^{\bar{0}W} W \oplus N_{X,Y}^{\bar{1}W} W' \right), \quad N_{X,Y}^{\pm W} = N_{X,Y}^{\bar{0}W} \pm N_{X,Y}^{\bar{1}W},$$

where W' is in the same class as W but has reversed $\mathbb{Z}/2\mathbb{Z}$ -grading. The properties (1.8) and (1.9) of asymptotic dimensions also hold, provided there are unique modules $Z_{(\pm)}$ of local and twisted type with minimal conformal weight, $\text{ch}^- [Z_{(-)}] \neq 0$, and with lowest conformal weight spaces purely even.

1.5.3 $\frac{1}{2}\mathbb{Z}$ -graded vertex operator superalgebras

The case of $\frac{1}{2}\mathbb{Z}$ -graded vertex operator superalgebras V is more subtle than the two previous cases due to the possible existence of fixed points. As before, V is an order-2 simple current extension of its even vertex operator subalgebra, $V = V^{\bar{0}} \oplus V^{\bar{1}}$, and we choose a set of representatives of equivalence classes of local modules $[\text{Rep}^0 V]$ as before. However, for the twisted modules there are two possibilities. Let X be a simple twisted module; as a $V^{\bar{0}}$ -module,

$$X \cong X^{\bar{0}} \oplus X^{\bar{1}}$$

where $X^{\bar{0}}$ and $X^{\bar{1}}$ are two simple $V^{\bar{0}}$ -modules. Then either $X^{\bar{0}} \cong X^{\bar{1}}$ or not. In the first case we say X is a fixed point. Representatives of equivalence classes of simple fixed-point modules are denoted by $[\text{Rep}^{\text{fix}} V]$, while the set of representatives of ordinary non-fixed-point twisted modules we call $[\text{Rep}^{\text{ordtw}} V]$, so that $[\text{Rep}^{\text{tw}} V]$ is the disjoint union of these two sets of representatives of equivalence classes of simple twisted objects. A simple local module is never a fixed point. We define characters and supercharacters as before:

$$\text{ch}^+[X](\tau, v) := \text{tr}_X \left(q^{L(0) - \frac{c}{24}} o(v) \right) \quad \text{and} \quad \text{ch}^- [X](\tau, v) := \text{str}_X \left(q^{L(0) - \frac{c}{24}} o(v) \right), \quad q = e^{2\pi i \tau}.$$

Note that

$$\text{ch}^- [X](\tau, v) = 0 \quad \text{for } X \in [\text{Rep}^{\text{fix}} V].$$

The modular S -transformation has the form

$$\begin{aligned} \text{ch}^+[X] \left(-\frac{1}{\tau}, v \right) &= \tau^{\text{wt}[v]} \sum_{Y \in [\text{Rep}^0 V]} S_{X,Y} \text{ch}^+[Y](\tau, v) \\ \text{ch}^- [X] \left(-\frac{1}{\tau}, v \right) &= \tau^{\text{wt}[v]} \sum_{Y \in [\text{Rep}^{\text{tw}} V]} S_{X,Y} \text{ch}^+[Y](\tau, v) \end{aligned} \quad (1.13)$$

if X is local and

$$\begin{aligned} \text{ch}^+[X] \left(-\frac{1}{\tau}, v \right) &= \tau^{\text{wt}[v]} \sum_{Y \in [\text{Rep}^0 V]} S_{X,Y} \text{ch}^- [Y](\tau, v) \\ \text{ch}^- [X] \left(-\frac{1}{\tau}, v \right) &= \tau^{\text{wt}[v]} \sum_{Y \in [\text{Rep}^{\text{ordtw}} V]} S_{X,Y} \text{ch}^- [Y](\tau, v) \end{aligned} \quad (1.14)$$

if X is twisted (and in addition ordinary in the case of the S -transformation for $\text{ch}^- [X]$). We set $S_{X,Y} = 0$ if both X and Y are twisted and in addition at least one of the two is in $[\text{Rep}^{\text{fix}} V]$. The modular T -transformation acts diagonally on characters and supercharacters of simple twisted modules and maps characters of simple local modules to the corresponding supercharacters and vice versa. In this case, we see that the linear span of twisted ordinary supercharacters already forms a vector-valued modular form for the modular group. For known results on modularity of vertex operator superalgebras see [DZ]. This modularity observation has a nice application in the context of Mathieu moonshine: it is needed in order to identify self-dual regular vertex operator superalgebras together with their unique twisted module with potential bulk superconformal field theories; see [CDR].

Going back to Verlinde's formula for $\frac{1}{2}\mathbb{Z}$ -graded vertex operator superalgebras, we have:

$$\begin{aligned} N_{X,Y}^+ W &= n_W \delta_{t(X)+t(Y), t(W)} \sum_{Z \in [\text{Rep}^0 V]} \frac{S_{X,Z} \cdot S_{Y,Z} \cdot (S^{-1})_{Z,W}}{S_{V,Z}} \\ N_{X,Y}^- W &= \delta_{t(X)+t(Y), t(W)} \sum_{Z \in [\text{Rep}^{\text{tw}} V]} \frac{S_{X,Z} \cdot S_{Y,Z} \cdot (S^{-1})_{Z,W}}{S_{V,Z}} \end{aligned} \quad (1.15)$$

with

$$t : [\text{Rep} V] \rightarrow \mathbb{Z}/2\mathbb{Z}, \quad X \mapsto \begin{cases} \bar{0} & \text{if } X \in [\text{Rep}^0 V] \\ \bar{1} & \text{if } X \in [\text{Rep}^{\text{tw}} V] \end{cases} \quad \text{and} \quad n_W = \begin{cases} 2 & \text{if } W \in [\text{Rep}^{\text{fix}} V] \\ 1 & \text{else} \end{cases}.$$

Thus the Verlinde formula is slightly more complicated for the fusion rules of a local with a twisted module. The fusion product is

$$X \boxtimes_V Y \cong \bigoplus_{W \in \mathcal{S}} \left(N_{X,Y}^{\bar{0}W} W \oplus N_{X,Y}^{\bar{1}W} \Pi(W) \right), \quad N_{X,Y}^{\pm W} = N_{X,Y}^{\bar{0}W} \pm N_{X,Y}^{\bar{1}W},$$

where Π is the parity-reversing endofunctor.

We assume the existence of unique simple local and twisted modules $Z_{(\pm)}$ as before, we assume that $\text{ch}^- [Z_{(+)}]$ does not vanish, and that the lowest conformal weight spaces of $Z_{(\pm)}$ are purely even. For a simple V -module X , the asymptotic (super)dimension is defined as before by

$$\text{adim}^\pm [X] = \lim_{iy \rightarrow i\infty} \frac{\text{ch}^\pm [X](-1/iy)}{\text{ch}^\pm [V](-1/iy)} = \frac{S_{X, Z_{(\mp)}}}{S_{V, Z_{(\mp)}}}. \quad (1.16)$$

We find that for $X, Y \in [\text{Rep } V]$, the product of asymptotic superdimensions respects the fusion product in the sense that

$$\text{adim}^- [X] \text{adim}^- [Y] = \sum_{W \in [\text{Rep } V]} N_{X, Y}^{-W} \text{adim}^- [W]. \quad (1.17)$$

There is also a formula for the product of asymptotic dimensions, but it requires knowledge of fixed points. However, if X and Y are both local or both twisted, then we also get

$$\text{adim}^+ [X] \text{adim}^+ [Y] = \sum_{W \in [\text{Rep } V]} N_{X, Y}^{+W} \text{adim}^+ [W]. \quad (1.18)$$

1.6 Outline

Here we summarize the structure of this paper. In Section 2, we work in an abstract tensor-categorical setting to study representations of (super)algebra objects in braided tensor categories. We prove that, for a (super)algebra A in a braided tensor category \mathcal{C} , the category $\text{Rep } A$ of A -modules with its tensor product \boxtimes_A forms an additive monoidal (super)category, under minimal assumptions on \mathcal{C} . To prove the associativity in $\text{Rep } A$, we introduce and study what we call categorical $\text{Rep } A$ -intertwining operators. Moreover, we prove that the category $\text{Rep}^0 A$ of local A -modules is braided monoidal. We provide detailed proofs, often in terms of graphical calculus. Though many results proved here are known, at least in more restrictive settings (see for example [Pa, KO, EGNO]), readers new to the theory of tensor categories may find our exposition helpful. In Section 2.7 we introduce the induction functor $\mathcal{F} : \mathcal{C} \rightarrow \text{Rep } A$ and prove that it is a tensor functor. In Section 2.8, we collect several useful properties of the induction functor, culminating in the relationship between S -matrices in \mathcal{C} and $\text{Rep}^0 A$, provided both are ribbon categories.

In Section 3, we begin with a quick yet fairly detailed exposition of vertex tensor category constructions. Readers new to vertex operator algebras or vertex tensor categories may find this introductory material useful. Then, we proceed to prove our main theorem, deriving complex-analytic properties of categorical $\text{Rep } A$ -intertwining operators. In Sections 3.4 and 3.5, we use these complex-analytic properties to match the braided monoidal category structure on $\text{Rep}^0 A$ from Section 2 with vertex tensor categorical structure on the category of A -modules in \mathcal{C} . Some analytic lemmas needed in these proofs as well as in Section 4 are collected in Section 3.7.

In Section 4 we apply our results. We first give several examples of vertex operator (super)algebra extensions. After recalling several results on simple current extensions, we show how to use screening charges to construct extensions of several copies of (non-rational but C_2 -cofinite) triplet algebras $\mathcal{W}(p)$. The next examples are extensions of products of rational Virasoro vertex operator algebras. Interestingly, Corollary 4.13 gives type E extensions. Our next application is Verlinde formulae for regular vertex operator superalgebras as well as $\frac{1}{2}\mathbb{Z}$ -graded vertex operator algebras (see Section 1.5 above for a summary of results). Finally, we take V to be a rational vertex operator (super)algebra containing as vertex operator subalgebra a lattice vertex operator algebra V_L of a positive-definite integral lattice L . The coset $C = \text{Com}(V_L, V)$ is often called the parafermion coset of V . Building on [CKLR], we describe these cosets in generality: we classify simple inequivalent C -modules in terms of those for V , we express the fusion rules for coset modules in terms of those for V , and we express characters of C -modules and their modular transformations in terms of those for V -modules. These results are applied to several examples, in which V is a rational affine vertex operator algebra, a rational $N = 2$ superconformal algebra, and a rational Bershadsky-Polyakov algebra.

2 Tensor categories and supercategories

This section largely follows [KO, Section 1], where a tensor category $\text{Rep } A$ of representations of a commutative associative algebra A in a braided tensor category \mathcal{C} was constructed, as well as an induction

tensor functor from \mathcal{C} to $\text{Rep } A$. See also [Pa] for the first construction of the braided tensor subcategory $\text{Rep}^0 A$ of $\text{Rep } A$. However, we work in a more general setting than [KO] in two important respects: first, we do not assume that \mathcal{C} is rigid or semisimple, and second, we work with *superalgebras* in \mathcal{C} . We need these generalizations to study braided tensor categories associated to potentially non-regular vertex operator algebras (whose module categories are typically non-semisimple and are typically not known to be rigid) and vertex operator superalgebras. Also, our approach to the associativity isomorphisms in $\text{Rep } A$, making use of what we call “categorical $\text{Rep } A$ -intertwining operators,” is inspired by vertex operator algebra theory and is necessary for relating the tensor-categorical structure of $\text{Rep } A$ to the vertex-tensor-categorical constructions of [HLZ1]-[HLZ8], which we accomplish in Section 3. For these reasons, and for the reader’s convenience, we include proofs of the main results in this section, although most are straightforward generalizations of results in [Pa, KO]. For brevity and clarity, many tensor-categorical calculations are summarized only, using graphical calculus; for fuller details, the reader may consult the first arXiv version of this paper: <https://arxiv.org/abs/1705.05017v1>.

2.1 Commutative associative algebras in braided tensor categories

Our motivation for this subsection is a vertex operator algebra extension $V \subseteq A$ where V has a vertex tensor category \mathcal{C} of modules, so \mathcal{C} is also an (abelian) braided tensor category, and where A is an object of \mathcal{C} . See [Hu8] for conditions on V under which the full category of grading-restricted generalized V -modules is a finite abelian category and has vertex tensor category structure; for example, these conditions hold if V is C_2 -cofinite but not necessarily rational.

For background on (braided) tensor categories, see for example [EGNO, Kas, BK]. As the term “tensor category” has several variant meanings in the literature, we first clarify our terminology. For us, a monoidal category is a category \mathcal{C} equipped with tensor product bifunctor \boxtimes , unit object $\mathbf{1}$, natural left and right unit isomorphisms l and r , and a natural associativity isomorphism \mathcal{A} , which satisfy the triangle and pentagon axioms. A tensor category is a monoidal category with additionally a compatible abelian category structure in the sense that the tensor product of morphisms is bilinear. A monoidal or tensor category is braided if it has a natural braiding isomorphism \mathcal{R} satisfying the hexagon axioms.

We fix a braided tensor category $(\mathcal{C}, \boxtimes, \mathbf{1}, l, r, \mathcal{A}, \mathcal{R})$. We also assume that morphism sets in \mathcal{C} are vector spaces over a field \mathbb{F} such that composition and tensor product of morphisms are both \mathbb{F} -bilinear, that is, \mathcal{C} is an \mathbb{F} -linear braided tensor category. For braided tensor categories coming from vertex operator algebras, $\mathbb{F} = \mathbb{C}$. The only additional assumption on \mathcal{C} that we will need for now, which is justified for braided tensor categories arising from vertex operator algebras thanks to Proposition 4.26 in [HLZ3], is the following:

Assumption 2.1. For any object W in \mathcal{C} , the functors $W \boxtimes \cdot$ and $\cdot \boxtimes W$ are right exact.

Definition 2.2. A *commutative associative algebra* in \mathcal{C} is an object A of \mathcal{C} equipped with morphisms $\mu : A \boxtimes A \rightarrow A$ and $\iota_A : \mathbf{1} \rightarrow A$ satisfying the following axioms:

1. Associativity: $\mu \circ (\mu \boxtimes 1_A) \circ \mathcal{A}_{A,A,A} = \mu \circ (1_A \boxtimes \mu)$ as morphisms $A \boxtimes (A \boxtimes A) \rightarrow A$.
2. Commutativity: $\mu \circ \mathcal{R}_{A,A} = \mu$ as morphisms $A \boxtimes A \rightarrow A$.
3. Unit: $\mu \circ (\iota_A \boxtimes 1_A) \circ l_A^{-1} = 1_A$ as morphisms $A \rightarrow A$.

Remark 2.3. The commutativity and unit axioms in the above definition together imply the right unit property $\mu \circ (1_A \boxtimes \iota_A) \circ r_A^{-1} = 1_A$.

Remark 2.4. If \mathcal{C} is a vertex tensor category of modules for a vertex operator algebra V , then a commutative associative algebra A in \mathcal{C} with trivial twist $\theta_A = e^{2\pi i L(0)}$ and with ι_A injective is a vertex operator algebra extension of V , by Theorem 3.2 and Remark 3.3 in [HKL]. (The assumption that ι_A is injective is implicit in the proof of [HKL, Theorem 3.2].)

Given a commutative associative algebra A in \mathcal{C} , we have the following category of “ A -modules”:

Definition 2.5. The category $\text{Rep } A$ has objects (W, μ_W) where W is an object of \mathcal{C} and $\mu_W : A \boxtimes W \rightarrow W$ satisfies:

1. Associativity: $\mu_W \circ (\mu \boxtimes 1_W) \circ \mathcal{A}_{A,A,W} = \mu_W \circ (1_A \boxtimes \mu_W)$ as morphisms $A \boxtimes (A \boxtimes W) \rightarrow W$.
2. Unit: $\mu_W \circ (\iota_A \boxtimes 1_W) \circ l_W^{-1} = 1_W$ as morphisms $W \rightarrow W$.

The morphisms between objects (W_1, μ_{W_1}) and (W_2, μ_{W_2}) of $\text{Rep } A$ are all \mathcal{C} -morphisms $f : W_1 \rightarrow W_2$ such that $f \circ \mu_{W_1} = \mu_{W_2} \circ (1_A \boxtimes f) : A \boxtimes W_1 \rightarrow W_2$.

Remark 2.6. Note that (A, μ) is an object of $\text{Rep } A$.

Remark 2.7. Here, we preview the relation of $\text{Rep } A$ -objects to vertex-algebraic intertwining operators. When \mathcal{C} is a braided tensor category of modules for a vertex operator algebra V and $V \subseteq A$ is a vertex operator algebra extension, we will show that an object of $\text{Rep } A$ is a V -module W equipped with a V -intertwining operator Y_W of type $\binom{W}{A \ W}$ such that $Y_W(\mathbf{1}, x) = 1_W$ and as multivalued functions,

$$\langle w', Y_W(a_1, z_1)Y_W(a_2, z_2)w \rangle = \langle w', Y_W(Y(a_1, z_1 - z_2)a_2, z_2)w \rangle$$

for $a_1, a_2 \in A$, $w \in W$, $w' \in W'$, and $z_1, z_2 \in \mathbb{C}^\times$ such that

$$|z_1| > |z_2| > |z_1 - z_2| > 0.$$

Here Y is the vertex operator for A . If W_1 and W_2 are two objects of $\text{Rep } A$, then a morphism $f : W_1 \rightarrow W_2$ in $\text{Rep } A$ will be a V -module homomorphism which satisfies

$$f(Y_{W_1}(a, x)w_1) = Y_{W_2}(a, x)f(w_1)$$

for $a \in A$ and $w_1 \in W_1$.

Remark 2.8. In the setting of the previous remark, objects of $\text{Rep } A$ are more general than ordinary A -modules, because we do not require the V -intertwining operator $Y_W(\cdot, x) \cdot$ for a module W in $\text{Rep } A$ to involve only integral powers of the formal variable x . For example, if V is the fixed-point subalgebra of a group of automorphisms G of A , then g -twisted A -modules for $g \in G$ are objects of $\text{Rep } A$. By [HKL, Theorem 3.4], ordinary A -modules are objects of the subcategory $\text{Rep}^0 A$ recalled in Section 2.6 below.

We will show that $\text{Rep } A$ has a natural tensor category structure. In particular:

1. There is a tensor product bifunctor $\boxtimes_A : \text{Rep } A \times \text{Rep } A \rightarrow \text{Rep } A$.
2. The object (A, μ) is a unit for \boxtimes_A , equipped with natural left and right unit isomorphisms l^A and r^A from $A \boxtimes_A \cdot$ and $\cdot \boxtimes_A A$, respectively, to the identity functor on $\text{Rep } A$.
3. $\text{Rep } A$ has a natural associativity isomorphism $\mathcal{A}^A : \boxtimes_A \circ (1_{\text{Rep } A} \times \boxtimes_A) \rightarrow \boxtimes_A \circ (\boxtimes_A \times 1_{\text{Rep } A})$.
4. The unit and associativity isomorphisms in $\text{Rep } A$ satisfy the pentagon and triangle axioms. (This will complete the proof that $\text{Rep } A$ is a monoidal category.)
5. $\text{Rep } A$ is an abelian category for which the tensor product of morphisms is bilinear.

We will show that $\text{Rep } A$ is abelian in this subsection. After introducing superalgebras in \mathcal{C} in the next subsection, we will construct \boxtimes_A and the unit isomorphisms. We will defer the construction of the associativity isomorphisms and the proof that $\text{Rep } A$ is a monoidal category to Section 2.5 after introducing categorical $\text{Rep } A$ -intertwining operators.

Theorem 2.9 (See also [KO, Lemma 1.4]). *Rep } A is an \mathbb{F} -linear abelian category.*

Proof. To show that $\text{Rep } A$ is an abelian category, we need to show the following:

1. $\text{Rep } A$ has a zero object.
2. Morphism sets in $\text{Rep } A$ are \mathbb{F} -vector spaces, with composition of morphisms bilinear.
3. Biproducts of finite sets of objects in $\text{Rep } A$ exist. Recall that a biproduct of a finite set of objects $\{W_i\}$ is an object $\bigoplus W_i$ equipped with morphisms $p_i : \bigoplus W_i \rightarrow W_i$ and $q_i : W_i \rightarrow \bigoplus W_i$ such that $p_i \circ q_i = 1_{W_i}$ for all i , $p_i \circ q_j = 0$ for $i \neq j$, and $\sum q_i \circ p_i = 1_{\bigoplus W_i}$. A biproduct of $\{W_i\}$ is both a product and a coproduct of $\{W_i\}$.
4. Every morphism in $\text{Rep } A$ has a kernel and a cokernel.
5. Every monomorphism in $\text{Rep } A$ is a kernel and every epimorphism is a cokernel.

The zero object of $\text{Rep } A$ is the zero object 0 of \mathcal{C} equipped with $\mu_0 : A \boxtimes 0 \rightarrow 0$ the unique morphism into 0 . Then since composition of morphisms in \mathcal{C} is \mathbb{F} -bilinear, $\text{Hom}_{\text{Rep } A}(W_1, W_2)$ is an \mathbb{F} -vector subspace of $\text{Hom}_{\mathcal{C}}(W_1, W_2)$ for any objects W_1, W_2 of $\text{Rep } A$.

Now for a finite set of objects $\{(W_i, \mu_{W_i})\}$ in $\text{Rep } A$ with biproduct $(\bigoplus W_i, \{p_i\}, \{q_i\})$ in \mathcal{C} , the object $\bigoplus W_i$ has the left A -action

$$\mu_{\bigoplus W_i} = \sum q_i \circ \mu_{W_i} \circ (1_A \boxtimes p_i) : A \boxtimes \bigoplus W_i \rightarrow \bigoplus W_i.$$

Using the unit and associativity properties for each μ_{W_i} , together with properties of the p_i and q_i , it is straightforward to show that $\mu_{\bigoplus W_i}$ also satisfies the unit and associativity properties. Moreover, it is easy

to see from the definition of $\mu_{\bigoplus W_i}$ that each p_i and q_i is a morphism in $\text{Rep } A$. Thus $(\bigoplus W_i, \{p_i\}, \{q_i\})$ is also a biproduct of $\{(W_i, \mu_{W_i})\}$ in $\text{Rep } A$.

Now suppose that $f : W_1 \rightarrow W_2$ is a morphism in $\text{Rep } A$; we need to show that f has a kernel and a cokernel in $\text{Rep } A$. Since \mathcal{C} is an abelian category, there is a kernel $k : K \rightarrow W_1$ of f in \mathcal{C} . We need to show that K has an A -module structure such that k is a morphism in $\text{Rep } A$, and that (K, k) satisfy the universal property of a kernel in $\text{Rep } A$. Consider the morphism

$$\mu_{W_1} \circ (1 \boxtimes k) : A \boxtimes K \rightarrow W_1.$$

Since f is a morphism in $\text{Rep } A$,

$$f \circ \mu_{W_1} \circ (1 \boxtimes k) = \mu_{W_2} \circ (1 \boxtimes f) \circ (1 \boxtimes k) = 0,$$

so the universal property of the kernel (K, k) induces a unique \mathcal{C} -morphism $\mu_K : A \boxtimes K \rightarrow K$ such that

$$k \circ \mu_K = \mu_{W_1} \circ (1 \boxtimes k). \quad (2.1)$$

We prove that (K, μ_K) is an object of $\text{Rep } A$. For the unit property for μ_K , observe that

$$K \xrightarrow{l_K^{-1}} \mathbf{1} \boxtimes K \xrightarrow{\iota_A \boxtimes 1_K} A \boxtimes K \xrightarrow{\mu_K} K \xrightarrow{k} W_1$$

equals the composition

$$K \xrightarrow{l_K^{-1}} \mathbf{1} \boxtimes K \xrightarrow{\iota_A \boxtimes 1_K} A \boxtimes K \xrightarrow{1 \boxtimes k} A \boxtimes W_1 \xrightarrow{\mu_{W_1}} W_1$$

by (2.1). By the naturality of the unit isomorphisms and the unit property for μ_{W_1} , this composition equals k . Since k is a kernel in \mathcal{C} and thus a monomorphism, it follows that $\mu_K \circ (\iota_A \boxtimes 1_K) \circ l_K^{-1} = 1_K$. To prove the associativity of μ_K , we use (2.1), the associativity of μ_{W_1} , and naturality of the associativity isomorphisms:

$$\begin{aligned} k \circ \mu_K \circ (1_A \boxtimes \mu_K) &= \mu_{W_1} \circ (1_A \boxtimes k) \circ (1_A \boxtimes \mu_K) = \mu_{W_1} \circ (1_A \boxtimes \mu_{W_1}) \circ (1_A \boxtimes (1_A \boxtimes k)) \\ &= \mu_{W_1} \circ (\mu \boxtimes 1_{W_1}) \circ \mathcal{A}_{A,A,W_1} \circ (1_A \boxtimes (1_A \boxtimes k)) = \mu_{W_1} \circ (1_A \boxtimes k) \circ (\mu \boxtimes 1_K) \circ \mathcal{A}_{A,A,K} \\ &= k \circ \mu_K \circ (\mu \boxtimes 1_K) \circ \mathcal{A}_{A,A,K}. \end{aligned}$$

Since k is a monomorphism, associativity for μ_K follows.

Now that (K, μ_K) is an object of $\text{Rep } A$, (2.1) says that k is a morphism in $\text{Rep } A$. To show that (K, μ_K) and k form a kernel of f in $\text{Rep } A$, let $(K', \mu_{K'})$ be an object of $\text{Rep } A$ and let $k' : K' \rightarrow W_1$ be a $\text{Rep } A$ -morphism such that $f \circ k' = 0$. As (K, k) is a kernel of f in \mathcal{C} , there is a unique \mathcal{C} -morphism $g : K' \rightarrow K$ such that $k \circ g = k'$. We just need to show that g is a morphism in $\text{Rep } A$. For this, we use the fact that k and k' are $\text{Rep } A$ -morphisms to calculate:

$$k \circ \mu_K \circ (1_A \boxtimes g) = \mu_{W_1} \circ (1_A \boxtimes k) \circ (1_A \boxtimes g) = \mu_{W_1} \circ (1_A \boxtimes k') = k' \circ \mu_{K'} = k \circ g \circ \mu_{K'}.$$

Since k is monic, it follows that $\mu_K \circ (1_A \boxtimes g) = g \circ \mu_{K'}$, as desired.

To prove that $f : W_1 \rightarrow W_2$ also has a cokernel in $\text{Rep } A$, take a cokernel (C, c) of f in \mathcal{C} ; we need to show that C is an object of $\text{Rep } A$. Since we assume that $A \boxtimes \cdot$ is right exact, $(A \boxtimes C, 1_A \boxtimes c)$ is a cokernel of $1_A \boxtimes f$ in \mathcal{C} . Then since f is a morphism in $\text{Rep } A$,

$$c \circ \mu_{W_2} \circ (1_A \boxtimes f) = c \circ f \circ \mu_{W_1} = 0,$$

so that the universal property of the cokernel $(A \boxtimes C, 1_A \boxtimes c)$ implies there is a unique \mathcal{C} -morphism $\mu_C : A \boxtimes C \rightarrow C$ such that

$$\mu_C \circ (1_A \boxtimes c) = c \circ \mu_{W_2}. \quad (2.2)$$

The proof that (C, μ_C) is an object of $\text{Rep } A$, that $c : W_2 \rightarrow C$ is a morphism in $\text{Rep } A$, and that C is a cokernel of f in $\text{Rep } A$ is then similar to the proof for kernels.

Next, we show that if $f : W_1 \rightarrow W_2$ is a monomorphism in $\text{Rep } A$, then f is a kernel. First, we show that f is a monomorphism in \mathcal{C} . Thus suppose $f \circ g = 0$ where $g : W'_1 \rightarrow W_1$ is any morphism in \mathcal{C} ; we need to show that $g = 0$. By the universal property of the kernel (K, k) of f , there is a unique \mathcal{C} -morphism $g' : W'_1 \rightarrow K$ such that $g = k \circ g'$. But we have already shown that k is a morphism in

Rep A ; thus because f is a monomorphism in Rep A and $f \circ k = 0$ by definition of the kernel of f , it follows that $k = 0$, and thus $g = 0$ as well.

Now that f is a monomorphism in \mathcal{C} , it is the kernel of a \mathcal{C} -morphism $g : W_2 \rightarrow W'_2$. As f is also a morphism in Rep A , it has a cokernel (C, c) in both \mathcal{C} and Rep A . We will show that (W_1, f) is also a kernel of c . Now, since $g \circ f = 0$, the universal property of the cokernel in \mathcal{C} implies there is a unique \mathcal{C} -morphism $g' : C \rightarrow W'_2$ such that $g = g' \circ c$. Then if $h : W \rightarrow W_2$ is any morphism in Rep A such that $c \circ h = 0$, we have

$$g \circ h = g' \circ c \circ h = 0$$

as well, so by the universal property of the kernel (W_1, f) of g , there is a unique \mathcal{C} -morphism $h' : W \rightarrow W_1$ such that $f \circ h' = h$. To show that h' is actually a morphism in Rep A , we observe that

$$f \circ h' \circ \mu_W = h \circ \mu_W = \mu_{W_2} \circ (1_A \boxtimes h) = \mu_{W_2} \circ (1_A \boxtimes f) \circ (1_A \boxtimes h') = f \circ \mu_{W_1} \circ (1_A \boxtimes h')$$

since f and h are morphisms in Rep A . Thus since f is a monomorphism, $h' \circ \mu_W = \mu_{W_1} \circ (1_A \boxtimes h')$.

Finally, we can show similarly that if $f : W_1 \rightarrow W_2$ is an epimorphism in Rep A , then it is the cokernel of its kernel in Rep A . \square

2.2 Superalgebras in braided tensor categories

In this subsection we formulate the notion of supercommutative associative superalgebra in our braided tensor category \mathcal{C} . The idea is to realize a superalgebra as an (ordinary) commutative associative algebra in a braided tensor *supercategory* associated to \mathcal{C} . Our motivation is to study vertex operator superalgebra extensions of vertex operator algebras using tensor category theory. Note, for example, that any vertex operator superalgebra V with parity decomposition $V^0 \oplus V^1$ is an extension of its even vertex operator subalgebra V^0 . If V^0 has a vertex tensor category \mathcal{C} of modules that includes V^1 , then V will be a superalgebra object in \mathcal{C} in the sense defined below.

First we clarify what we mean by supercategory: should objects or morphism spaces have natural $\mathbb{Z}/2\mathbb{Z}$ -gradings? We will follow the approach of [BrE] and give morphism spaces $\mathbb{Z}/2\mathbb{Z}$ -gradings; also see [BrE] for supercategory analogues of notions from tensor category theory. We denote the parity of a parity-homogeneous morphism f in a supercategory by $|f| \in \mathbb{Z}/2\mathbb{Z}$. Here, we highlight some differences that appear in the supercategory setting; the general philosophy is that sign factors should appear whenever the order of two morphisms with parity is reversed. First, composition of morphisms in a supercategory should be even as a linear map between superspaces, and superfunctors between supercategories should induce even linear maps on morphisms. If \mathcal{SC} is a supercategory, then $\mathcal{SC} \times \mathcal{SC}$ is naturally a supercategory with composition of morphisms given by

$$(f_1, f_2) \circ (g_1, g_2) = (-1)^{|f_2||g_1|} (f_1 \circ g_1, f_2 \circ g_2),$$

when f_2 and g_1 are parity-homogeneous morphisms in \mathcal{SC} (this is called the super interchange law in [BrE]). Moreover, $\mathcal{SC} \times \mathcal{SC}$ has a supersymmetry superfunctor σ given by $\sigma(W_1, W_2) = (W_2, W_1)$ for objects and $\sigma(f_1, f_2) = (-1)^{|f_1||f_2|} (f_2, f_1)$ for parity-homogeneous morphisms.

A monoidal supercategory \mathcal{SC} is equipped with a tensor product superfunctor $\boxtimes : \mathcal{SC} \times \mathcal{SC} \rightarrow \mathcal{SC}$. In particular, \boxtimes induces an even linear map on morphisms: $|f_1 \boxtimes f_2| = |f_1| + |f_2|$ for parity-homogeneous morphisms f_1 and f_2 , and the super interchange law holds:

$$(f_1 \boxtimes f_2) \circ (g_1 \boxtimes g_2) = (-1)^{|f_2||g_1|} (f_1 \circ g_1) \boxtimes (f_2 \circ g_2) \tag{2.3}$$

for appropriately composable morphisms f_1, f_2, g_1, g_2 with f_2 and g_1 parity-homogeneous. The natural unit and associativity isomorphisms are even, and in a braided monoidal supercategory, the natural braiding isomorphism $\mathcal{R} : \boxtimes \rightarrow \boxtimes \circ \sigma$ is also even. Naturality of \mathcal{R} means that for parity-homogeneous morphisms $f_1 : W_1 \rightarrow \widetilde{W}_1$ and $f_2 : W_2 \rightarrow \widetilde{W}_2$ in \mathcal{SC} ,

$$\mathcal{R}_{\widetilde{W}_1, \widetilde{W}_2} \circ (f_1 \boxtimes f_2) = (-1)^{|f_1||f_2|} (f_2 \boxtimes f_1) \circ \mathcal{R}_{W_1, W_2}. \tag{2.4}$$

A (braided) tensor supercategory is a (braided) monoidal supercategory with a compatible abelian category structure, that is, the tensor product of morphisms is bilinear.

We continue to fix an \mathbb{F} -linear braided tensor category \mathcal{C} in which tensoring is right exact. Since we will be working with parity automorphisms on $\mathbb{Z}/2\mathbb{Z}$ -graded objects in this and following subsections, we will now for convenience assume that the characteristic of \mathbb{F} is not 2. As \boxtimes is biadditive, tensor products in \mathcal{C} distribute over biproducts:

Proposition 2.10. *For any finite sets of objects $\{W_i\}$ and $\{X_j\}$ in \mathcal{C} , there is a unique isomorphism*

$$F : \left(\bigoplus W_i \right) \boxtimes \left(\bigoplus X_j \right) \rightarrow \bigoplus (W_i \boxtimes X_j)$$

such that $F \circ (q_{W_i} \boxtimes q_{X_j}) = q_{W_i \boxtimes X_j}$ and $p_{W_i \boxtimes X_j} \circ F = p_{W_i} \boxtimes p_{X_j}$ for all i, j .

We now introduce a supercategory \mathcal{SC} associated to \mathcal{C} that essentially consists of objects of \mathcal{C} having a parity decomposition. Alternatively, one can view \mathcal{SC} as the Deligne product of \mathcal{C} with the supercategory of finite-dimensional vector superspaces:

Definition 2.11. Let \mathcal{SC} be the category whose objects are ordered pairs $W = (W^{\bar{0}}, W^{\bar{1}})$ where $W^{\bar{0}}$ and $W^{\bar{1}}$ are objects of \mathcal{C} and

$$\text{Hom}_{\mathcal{SC}}(W_1, W_2) = \text{Hom}_{\mathcal{C}}(W_1^{\bar{0}} \oplus W_1^{\bar{1}}, W_2^{\bar{0}} \oplus W_2^{\bar{1}}).$$

For an object W in \mathcal{SC} , the *parity involution* of W is

$$P_W = 1_{W^{\bar{0}}} \oplus (-1_{W^{\bar{1}}}) = q_{W^{\bar{0}}} \circ p_{W^{\bar{0}}} - q_{W^{\bar{1}}} \circ p_{W^{\bar{1}}}.$$

We let Π denote the parity reversing endofunctor on \mathcal{SC} .

We say that a morphism $f \in \text{Hom}_{\mathcal{SC}}(W_1, W_2)$ has parity $|f| \in \mathbb{Z}/2\mathbb{Z}$ if $f \circ P_{W_1} = (-1)^{|f|} P_{W_2} \circ f$, and we say that f is *even* or *odd* according as $|f| = \bar{0}$ or $|f| = \bar{1}$. It is clear that even and odd morphisms form subspaces of $\text{Hom}_{\mathcal{SC}}(W_1, W_2)$ for any objects W_1, W_2 in \mathcal{SC} . In fact, $\text{Hom}_{\mathcal{SC}}(W_1, W_2)$ is a superspace with parity decomposition given by the even and odd morphism subspaces, that is, every morphism in \mathcal{SC} is uniquely the sum of an even morphism and an odd morphism. To see this, first note that for $f \in \text{Hom}_{\mathcal{SC}}(W_1, W_2)$, we can write $f = f^{\bar{0}} + f^{\bar{1}}$ where

$$f^{\bar{0}} = \frac{1 + P_{W_2}}{2} \circ f \circ \frac{1 + P_{W_1}}{2} + \frac{1 - P_{W_2}}{2} \circ f \circ \frac{1 - P_{W_1}}{2}$$

is even and

$$f^{\bar{1}} = \frac{1 + P_{W_2}}{2} \circ f \circ \frac{1 - P_{W_1}}{2} + \frac{1 - P_{W_2}}{2} \circ f \circ \frac{1 + P_{W_1}}{2}$$

is odd. To understand this decomposition, note that for W in \mathcal{SC} , $\frac{1 + P_W}{2} = q_{W^{\bar{0}}} \circ p_{W^{\bar{0}}}$ is projection of W onto $W^{\bar{0}}$, while $\frac{1 - P_W}{2} = q_{W^{\bar{1}}} \circ p_{W^{\bar{1}}}$ is projection of W onto $W^{\bar{1}}$. Thus $f^{\bar{0}}$ consists of the components of f mapping $W_1^{\bar{0}}$ onto $W_2^{\bar{0}}$ and $W_1^{\bar{1}}$ onto $W_2^{\bar{1}}$, while $f^{\bar{1}}$ consists of the components of f mapping $W_1^{\bar{0}}$ into $W_2^{\bar{1}}$ and $W_1^{\bar{1}}$ into $W_2^{\bar{0}}$. So every morphism in \mathcal{SC} is the sum of even and odd components.

We also need the decomposition of f into even and odd components to be unique. For this, we show that 0 is the only morphism that is both even and odd. In fact, suppose $f \circ P_{W_1} = P_{W_2} \circ f = -f \circ P_{W_1}$. Then $2(f \circ P_{W_1}) = 0$, or $f \circ P_{W_1} = f \circ (q_{W^{\bar{0}}} \circ p_{W^{\bar{0}}} - q_{W^{\bar{1}}} \circ p_{W^{\bar{1}}}) = 0$. Thus $f \circ q_{W^{\bar{0}}} \circ p_{W^{\bar{0}}} = f \circ q_{W^{\bar{1}}} \circ p_{W^{\bar{1}}}$. By composing both sides of this relation with q_{W^i} , $i = \bar{0}, \bar{1}$, on the right, we get $f \circ q_{W^i} = 0$ for $i = \bar{0}, \bar{1}$. But then

$$f = f \circ (q_{W^{\bar{0}}} \circ p_{W^{\bar{0}}} + q_{W^{\bar{1}}} \circ p_{W^{\bar{1}}}) = 0.$$

Thus morphism spaces in \mathcal{SC} are superspaces with parity decomposition given by even and odd morphisms. Moreover, it is clear that if $f_1 : W_2 \rightarrow W_3$ and $f_2 : W_1 \rightarrow W_2$ are parity-homogeneous morphisms in \mathcal{SC} , then $|f_1 \circ f_2| = |f_1| + |f_2|$. Thus composition is an even bilinear map, and so \mathcal{SC} is a supercategory.

Remark 2.12. Since our convention is that \mathcal{SC} contains both even and odd morphisms, morphisms do not generally preserve parity decompositions of objects. For instance, $W \cong \Pi(W)$ for any object W in \mathcal{SC} since the identity on $W^{\bar{0}} \oplus W^{\bar{1}} = W^{\bar{1}} \oplus W^{\bar{0}}$ is an (odd) isomorphism from W to $\Pi(W)$. If one instead wants to use the convention that morphisms preserve parity decompositions of objects, one should use the *underlying category* $\underline{\mathcal{SC}}$ whose objects are the objects of \mathcal{SC} and whose morphisms are the *even* morphisms of \mathcal{SC} . In general we can expect more isomorphism classes of objects in $\underline{\mathcal{SC}}$ since a given object in \mathcal{C} could have multiple distinct parity decompositions. Note also that the odd morphisms in $\text{Hom}_{\mathcal{SC}}(W_1, W_2)$ appear in $\underline{\mathcal{SC}}$ as morphisms from W_1 to $\Pi(W_2)$. Although we shall generally work with \mathcal{SC} we shall frequently remark on how our results apply to $\underline{\mathcal{SC}}$.

Definition 2.13. There is a natural inclusion functor $\mathcal{I} : \mathcal{C} \rightarrow \mathcal{SC}$ such that $\mathcal{I}(W) = (W, 0)$ and $\mathcal{I}(f) = f \oplus 0$. We also have a natural forgetful functor $\mathcal{J} : \mathcal{SC} \rightarrow \mathcal{C}$ with $\mathcal{J} : (W^{\bar{0}}, W^{\bar{1}}) \rightarrow W^{\bar{0}} \oplus W^{\bar{1}}$, $\mathcal{J}(f) = f$ (so \mathcal{J} forgets the superspace structure on morphisms). With these functors in mind, we shall sometimes abuse notation and denote an object $W = (W^{\bar{0}}, W^{\bar{1}})$ of \mathcal{SC} simply by $W = W^{\bar{0}} \oplus W^{\bar{1}}$.

The following proposition is easy to prove:

Proposition 2.14. *The supercategory \mathcal{SC} is an \mathbb{F} -linear abelian category:*

1. *The zero object of \mathcal{SC} is $\underline{0} = (0, 0)$.*
2. *The biproduct of a finite collection of objects $\{W_i\}$ in \mathcal{SC} is given by $\bigoplus W_i = \left(\bigoplus W_i^{\bar{0}}, \bigoplus W_i^{\bar{1}}\right)$ with $p_i = p_{W_i^{\bar{0}}} \oplus p_{W_i^{\bar{1}}}$ and $q_i = q_{W_i^{\bar{0}}} \oplus q_{W_i^{\bar{1}}}$.*
3. *If (K, k) is a kernel in \mathcal{C} of a morphism $f : W_1^{\bar{0}} \oplus W_1^{\bar{1}} \rightarrow W_2^{\bar{0}} \oplus W_2^{\bar{1}}$ in \mathcal{SC} , then $(K, 0)$ is a kernel of f in \mathcal{SC} , with kernel morphism*

$$K \oplus 0 \xrightarrow{p_K} K \xrightarrow{k} W_1^{\bar{0}} \oplus W_1^{\bar{1}}.$$

4. *If (C, c) is a cokernel in \mathcal{C} of a morphism $f : W_1^{\bar{0}} \oplus W_1^{\bar{1}} \rightarrow W_2^{\bar{0}} \oplus W_2^{\bar{1}}$ in \mathcal{SC} , then $(C, 0)$ is a cokernel of f in \mathcal{SC} , with cokernel morphism*

$$W_2^{\bar{0}} \oplus W_2^{\bar{1}} \xrightarrow{c} C \xrightarrow{q_C} C \oplus 0.$$

Note that the structure morphisms p_i and q_i for a biproduct in \mathcal{SC} can be taken to be even, but the same is not necessarily the case for kernel and cokernel morphisms. However, we do have:

Proposition 2.15. *If $f : W_1 \rightarrow W_2$ is a parity-homogeneous morphism in \mathcal{SC} , then its kernel and cokernel morphisms can be taken to be even. Moreover, every parity-homogeneous monomorphism in \mathcal{SC} is the kernel of an even morphism, and every parity-homogeneous epimorphism in \mathcal{SC} is the cokernel of an even morphism.*

Proof. Let (K, k) be a kernel of f in \mathcal{C} and consider the \mathcal{C} -morphism $P_{W_1} \circ k : K \rightarrow W_1$. Since f is parity-homogeneous, we have

$$f \circ P_{W_1} \circ k = (-1)^{|f|} P_{W_2} \circ f \circ k = 0,$$

so the universal property of the kernel implies there is a unique morphism $P_K : K \rightarrow K$ such that

$$k \circ P_K = P_{W_1} \circ k.$$

Then set $\tilde{K} = (K^{\bar{0}}, K^{\bar{1}})$ in \mathcal{SC} where $(K^{\bar{0}}, k^{\bar{0}})$ is a kernel of $\frac{1-P_K}{2}$ in \mathcal{C} and $(K^{\bar{1}}, k^{\bar{1}})$ is a kernel of $\frac{1+P_K}{2}$ in \mathcal{C} ; also define $\tilde{k} : \tilde{K} \rightarrow W_1$ by

$$\tilde{k} = k \circ (k^{\bar{0}} \circ p_{K^{\bar{0}}} + k^{\bar{1}} \circ p_{K^{\bar{1}}}).$$

We will show that (\tilde{K}, \tilde{k}) is a kernel of f in \mathcal{SC} and that \tilde{k} is even.

First let us show that \tilde{k} is even. We have

$$\begin{aligned} P_{W_1} \circ \tilde{k} &= P_{W_1} \circ k \circ (k^{\bar{0}} \circ p_{K^{\bar{0}}} + k^{\bar{1}} \circ p_{K^{\bar{1}}}) = k \circ P_K \circ (k^{\bar{0}} \circ p_{K^{\bar{0}}} + k^{\bar{1}} \circ p_{K^{\bar{1}}}) \\ &= k \circ (k^{\bar{0}} \circ p_{K^{\bar{0}}} - k^{\bar{1}} \circ p_{K^{\bar{1}}}) = k \circ (k^{\bar{0}} \circ p_{K^{\bar{0}}} + k^{\bar{1}} \circ p_{K^{\bar{1}}}) \circ (q_{K^{\bar{0}}} \circ p_{K^{\bar{0}}} - q_{K^{\bar{1}}} \circ p_{K^{\bar{1}}}) = \tilde{k} \circ P_{\tilde{K}}; \end{aligned}$$

in the third equality we have used the definition of $k^{\bar{0}}, k^{\bar{1}}$ as kernel morphisms. Thus \tilde{k} is even.

To show that (\tilde{K}, \tilde{k}) is a kernel of f , it is enough to show that $k^{\bar{0}} \circ p_{K^{\bar{0}}} + k^{\bar{1}} \circ p_{K^{\bar{1}}} : K^{\bar{0}} \oplus K^{\bar{1}} \rightarrow K$ is an isomorphism (in \mathcal{C}). To construct the inverse, note that since $\frac{1+P_K}{2} \circ \frac{1-P_K}{2} = \frac{1-P_K}{2} \circ \frac{1+P_K}{2} = 0$, the universal properties of the kernels k^i , $i = \bar{0}, \bar{1}$, imply that there are morphisms $f^i : K \rightarrow K^i$, $i = \bar{0}, \bar{1}$, such that

$$k^{\bar{0}} \circ f^{\bar{0}} = \frac{1+P_K}{2} \quad \text{and} \quad k^{\bar{1}} \circ f^{\bar{1}} = \frac{1-P_K}{2}.$$

We show that $q_{K^{\bar{0}}} \circ f^{\bar{0}} + q_{K^{\bar{1}}} \circ f^{\bar{1}}$ is the inverse of $k^{\bar{0}} \circ p_{K^{\bar{0}}} + k^{\bar{1}} \circ p_{K^{\bar{1}}}$. In fact,

$$(k^{\bar{0}} \circ p_{K^{\bar{0}}} + k^{\bar{1}} \circ p_{K^{\bar{1}}}) \circ (q_{K^{\bar{0}}} \circ f^{\bar{0}} + q_{K^{\bar{1}}} \circ f^{\bar{1}}) = k^{\bar{0}} \circ f^{\bar{0}} + k^{\bar{1}} \circ f^{\bar{1}} = \frac{1+P_K}{2} + \frac{1-P_K}{2} = 1_K.$$

For the reverse composition, note that

$$k^{\bar{0}} \circ f^{\bar{0}} \circ k^{\bar{0}} = \frac{1+P_K}{2} \circ k^{\bar{0}} = \left(1_K - \frac{1-P_K}{2}\right) \circ k^{\bar{0}} = k^{\bar{0}};$$

since $k^{\bar{0}}$ is a monomorphism, it follows that $f^{\bar{0}} \circ k^{\bar{0}} = 1_{K^{\bar{0}}}$. Also,

$$k^{\bar{0}} \circ f^{\bar{0}} \circ k^{\bar{1}} = \frac{1+P_K}{2} \circ k^{\bar{1}} = 0,$$

so that $f^{\bar{0}} \circ k^{\bar{1}} = 0$. Similarly, $f^{\bar{1}} \circ k^{\bar{0}} = 0$ and $f^{\bar{1}} \circ k^{\bar{1}} = 1_{K^{\bar{1}}}$. Thus

$$(q_{K^{\bar{0}}} \circ f^{\bar{0}} + q_{K^{\bar{1}}} \circ f^{\bar{1}}) \circ (k^{\bar{0}} \circ p_{K^{\bar{0}}} + k^{\bar{1}} \circ p_{K^{\bar{1}}}) = q_{K^{\bar{0}}} \circ p_{K^{\bar{0}}} + q_{K^{\bar{1}}} \circ p_{K^{\bar{1}}} = 1_{K^{\bar{0}} \oplus K^{\bar{1}}}.$$

This completes the proof that $(\widetilde{K}, \widetilde{k})$ is a kernel of f in \mathcal{SC} with \widetilde{k} even.

The proof that f has a cokernel $(\widetilde{C}, \widetilde{c})$ in \mathcal{SC} with \widetilde{c} even is entirely analogous. Now suppose that f is a parity-homogeneous monomorphism in \mathcal{SC} . The argument in the proof of Theorem 2.9 shows that f is the kernel of its cokernel, which can be taken to be even. Similarly, if f is a parity-homogeneous epimorphism in \mathcal{SC} , then f is the cokernel of its kernel, which can be taken to be even. \square

Remark 2.16. Propositions 2.14 and 2.15 combined imply that the underlying category $\underline{\mathcal{SC}}$ is abelian.

We now give \mathcal{SC} the structure of a braided tensor supercategory. On objects, the tensor product bifunctor \boxtimes is given by $W_1 \boxtimes W_2 = ((W_1 \boxtimes W_2)^{\bar{0}}, (W_1 \boxtimes W_2)^{\bar{1}})$, where

$$(W_1 \boxtimes W_2)^i = \bigoplus_{i_1+i_2=i} W_1^{i_1} \boxtimes W_2^{i_2}$$

for $i = \bar{0}, \bar{1}$. The tensor product of morphisms $f_1 : W_1 \rightarrow \widetilde{W}_1$, $f_2 : W_2 \rightarrow \widetilde{W}_2$ needs to be a \mathcal{C} -morphism:

$$f_1 \boxtimes f_2 : \bigoplus_{i_1, i_2 \in \mathbb{Z}/2\mathbb{Z}} W_1^{i_1} \boxtimes W_2^{i_2} \rightarrow \bigoplus_{i_1, i_2 \in \mathbb{Z}/2\mathbb{Z}} \widetilde{W}_1^{i_1} \boxtimes \widetilde{W}_2^{i_2}.$$

Since tensor products in \mathcal{C} distribute over biproducts (Proposition 2.10), we can identify $f_1 \boxtimes f_2$ as a morphism $(W_1^{\bar{0}} \oplus W_1^{\bar{1}}) \boxtimes (W_2^{\bar{0}} \oplus W_2^{\bar{1}}) \rightarrow (\widetilde{W}_1^{\bar{0}} \oplus \widetilde{W}_1^{\bar{1}}) \boxtimes (\widetilde{W}_2^{\bar{0}} \oplus \widetilde{W}_2^{\bar{1}})$. If f_2 is parity-homogeneous, we define this morphism to be $(f_1 \circ P_{W_1}^{|f_2|}) \boxtimes f_2$, where \boxtimes here is the tensor product of morphisms in \mathcal{C} . That is,

$$f_1 \boxtimes_{\mathcal{SC}} f_2 = F \circ \left((f_1 \circ P_{W_1}^{|f_2|}) \boxtimes_{\mathcal{C}} f_2 \right) \circ F^{-1}$$

with F as in Proposition 2.10. If f_2 is not necessarily homogeneous, we define

$$f_1 \boxtimes f_2 = f_1 \boxtimes f_2^{\bar{0}} + f_1 \boxtimes f_2^{\bar{1}}.$$

Then it is clear that the tensor product of morphisms in \mathcal{SC} is bilinear.

Note the factor of $P_{W_1}^{|f_2|}$ in the definition of tensor product of morphisms in \mathcal{SC} . This is needed to prove the super interchange law (2.3) in the following proposition:

Proposition 2.17. *The tensor product $\boxtimes : \mathcal{SC} \times \mathcal{SC} \rightarrow \mathcal{SC}$ is a superfunctor.*

Proof. We need to show that \boxtimes induces an even linear map on morphisms and that tensor products of morphisms satisfy the super interchange law (2.3).

To show that

$$\boxtimes : \text{Hom}_{\mathcal{SC}}(W_1, \widetilde{W}_1) \otimes \text{Hom}_{\mathcal{SC}}(W_2, \widetilde{W}_2) \rightarrow \text{Hom}_{\mathcal{SC}}(W_1 \boxtimes W_2, \widetilde{W}_1 \boxtimes \widetilde{W}_2)$$

is an even linear map between superspaces, we need to show that if $f_1 : W_1 \rightarrow \widetilde{W}_1$ and $f_2 : W_2 \rightarrow \widetilde{W}_2$ are parity-homogeneous morphisms in \mathcal{SC} , then $|f_1 \boxtimes f_2| = |f_1| + |f_2|$. Using the definitions and Proposition 2.10,

$$\begin{aligned} P_{\widetilde{W}_1 \boxtimes \widetilde{W}_2} \circ (f_1 \boxtimes_{\mathcal{SC}} f_2) &= \left(\sum_{i_1, i_2 \in \mathbb{Z}/2\mathbb{Z}} (-1)^{i_1+i_2} q_{\widetilde{W}_1^{i_1} \boxtimes \widetilde{W}_2^{i_2}} \circ p_{\widetilde{W}_1^{i_1} \boxtimes \widetilde{W}_2^{i_2}} \right) \circ F \circ \left((f_1 \circ P_{W_1}^{|f_2|}) \boxtimes_{\mathcal{C}} f_2 \right) \circ F^{-1} \\ &= \sum_{i_1, i_2 \in \mathbb{Z}/2\mathbb{Z}} (-1)^{i_1+i_2} q_{\widetilde{W}_1^{i_1} \boxtimes \widetilde{W}_2^{i_2}} \circ \left((p_{\widetilde{W}_1^{i_1}} \circ f_1 \circ P_{W_1}^{|f_2|}) \boxtimes_{\mathcal{C}} (p_{\widetilde{W}_2^{i_2}} \circ f_2) \right) \circ F^{-1} \\ &= F \circ \left(\sum_{i_1 \in \mathbb{Z}/2\mathbb{Z}} (-1)^{i_1} (q_{\widetilde{W}_1^{i_1}} \circ p_{\widetilde{W}_1^{i_1}} \circ f_1 \circ P_{W_1}^{|f_2|}) \boxtimes_{\mathcal{C}} \sum_{i_2 \in \mathbb{Z}/2\mathbb{Z}} (-1)^{i_2} (q_{\widetilde{W}_2^{i_2}} \circ p_{\widetilde{W}_2^{i_2}} \circ f_2) \right) \circ F^{-1} \\ &= F \circ \left((P_{\widetilde{W}_1} \circ f_1 \circ P_{W_1}^{|f_2|}) \boxtimes_{\mathcal{C}} (P_{\widetilde{W}_2} \circ f_2) \right) \circ F^{-1} \\ &= (-1)^{|f_1|+|f_2|} F \circ \left((f_1 \circ P_{W_1}^{|f_2|}) \boxtimes_{\mathcal{C}} f_2 \right) \circ (P_{W_1} \boxtimes_{\mathcal{C}} P_{W_2}) \circ F^{-1} \\ &= (-1)^{|f_1|+|f_2|} F \circ \left((f_1 \circ P_{W_1}^{|f_2|}) \boxtimes_{\mathcal{C}} f_2 \right) \circ F^{-1} \circ P_{W_1 \boxtimes W_2} \end{aligned}$$

$$= (-1)^{|f_1|+|f_2|} (f_1 \boxtimes_{\mathcal{SC}} f_2) \circ P_{W_1 \boxtimes W_2},$$

as desired.

Now suppose $f_1 : W_2 \rightarrow W_3$, $f_2 : W_1 \rightarrow W_2$, $g_1 : X_2 \rightarrow X_3$, and $g_2 : X_1 \rightarrow X_2$ are morphisms in \mathcal{SC} with g_1 and f_2 homogeneous. To verify the super interchange law, we may assume that g_2 is also homogeneous, and then

$$\begin{aligned} (f_1 \boxtimes_{\mathcal{SC}} g_1) \circ (f_2 \boxtimes_{\mathcal{SC}} g_2) &= F \circ ((f_1 \circ P_{W_2}^{|g_1|}) \boxtimes_{\mathcal{C}} g_1) \circ ((f_2 \circ P_{W_1}^{|g_2|}) \boxtimes_{\mathcal{C}} g_2) \circ F^{-1} \\ &= F \circ ((f_1 \circ P_{W_2}^{|g_1|} \circ f_2 \circ P_{W_1}^{|g_2|}) \boxtimes_{\mathcal{C}} (g_1 \circ g_2)) \circ F^{-1} \\ &= ((-1)^{|f_2|}|g_1| F \circ ((f_1 \circ f_2 \circ P_{W_1}^{|g_1|+|g_2|}) \boxtimes_{\mathcal{C}} (g_1 \circ g_2)) \circ F^{-1} \\ &= (-1)^{|g_1||f_2|} (f_1 \circ f_2) \boxtimes_{\mathcal{SC}} (g_1 \circ g_2) \end{aligned}$$

as desired. \square

Remark 2.18. Proposition 2.17 shows that the tensor product of even morphisms in \mathcal{SC} is even, so that \boxtimes defines a functor on $\underline{\mathcal{SC}}$ as well.

Now we can define the rest of the braided tensor supercategory structure on \mathcal{SC} :

1. The unit object in \mathcal{SC} is $\underline{\mathbf{1}} = (\mathbf{1}, 0)$, and for any object W in \mathcal{SC} , the left unit isomorphism is $\underline{l} = l_{W^0} \oplus l_{W^1}$ and the right unit isomorphism is $\underline{r} = r_{W^0} \oplus r_{W^1}$.
2. For objects W_1, W_2 , and W_3 in \mathcal{SC} , the associativity isomorphism is

$$\underline{\mathcal{A}}_{W_1, W_2, W_3} = \left(\bigoplus_{i_1+i_2+i_3=\bar{0}} \mathcal{A}_{W_1^{i_1}, W_2^{i_2}, W_3^{i_3}} \right) \oplus \left(\bigoplus_{i_1+i_2+i_3=\bar{1}} \mathcal{A}_{W_1^{i_1}, W_2^{i_2}, W_3^{i_3}} \right).$$

3. For objects W_1 and W_2 in \mathcal{SC} , the braiding isomorphism is

$$\underline{\mathcal{R}}_{W_1, W_2} = \left(\bigoplus_{i_1+i_2=\bar{0}} (-1)^{i_1 i_2} \mathcal{R}_{W_1^{i_1}, W_2^{i_2}} \right) \oplus \left(\bigoplus_{i_1+i_2=\bar{1}} (-1)^{i_1 i_2} \mathcal{R}_{W_1^{i_1}, W_2^{i_2}} \right)$$

Remark 2.19. It is straightforward to verify, using Proposition 2.10 and its notation, that, if we take $\mathbf{1} \oplus 0$ in \mathcal{C} to be $\mathbf{1}$ with $q_1 = p_1 = 1_{\mathbf{1}}$ and $q_0 = p_0 = 0$, then

$$\underline{l}_W = l_{W^0 \oplus W^1} \circ F^{-1}$$

and

$$\underline{r}_W = r_{W^0 \oplus W^1} \circ F^{-1}$$

for any object W in \mathcal{SC} . Moreover, for any objects W_1, W_2, W_3 in \mathcal{SC} ,

$$\underline{\mathcal{A}}_{W_1, W_2, W_3} = F \circ (F \boxtimes 1_{W_3}) \circ \mathcal{A}_{W_1^{\bar{0}} \oplus W_1^{\bar{1}}, W_2^{\bar{0}} \oplus W_2^{\bar{1}}, W_3^{\bar{0}} \oplus W_3^{\bar{1}}} \circ (1_{W_1} \boxtimes F^{-1}) \circ F^{-1},$$

and

$$\underline{\mathcal{R}}_{W_1, W_2} = F \circ Q_{W_2, W_1} \circ \mathcal{R}_{W_1^{\bar{0}} \oplus W_1^{\bar{1}}, W_2^{\bar{0}} \oplus W_2^{\bar{1}}} \circ F^{-1},$$

where

$$Q_{W_2, W_1} = \sum_{i_1, i_2 \in \mathbb{Z}/2\mathbb{Z}} (-1)^{i_1 i_2} (q_{W_2^{i_2}} \circ p_{W_2^{i_2}}) \boxtimes (q_{W_1^{i_1}} \circ p_{W_1^{i_1}}).$$

Note that Q_{W_2, W_1} would be the identity if it were not for the $(-1)^{i_1 i_2}$ factor.

Theorem 2.20. *The supercategory \mathcal{SC} together with \boxtimes , $\underline{\mathbf{1}}$, \underline{l} , \underline{r} , $\underline{\mathcal{A}}$, and $\underline{\mathcal{R}}$ is an \mathbb{F} -linear braided tensor supercategory.*

Proof. It is straightforward to use the definitions, Remark 2.19, and the fact that \mathcal{C} is a tensor category to verify that the unit and associativity isomorphisms in \mathcal{SC} are natural and satisfy the triangle and pentagon axioms. However, the braiding isomorphisms are complicated by the extra $(-1)^{i_1 i_2}$ factor.

We need to show that the braiding isomorphisms are natural in the sense of (2.4). In fact,

$$\begin{aligned} \underline{\mathcal{R}}_{\widetilde{W}_1, \widetilde{W}_2} \circ (f_1 \boxtimes_{\mathcal{SC}} f_2) &= F \circ Q_{\widetilde{W}_2, \widetilde{W}_1} \circ \mathcal{R}_{\widetilde{W}_1^{\bar{0}} \oplus \widetilde{W}_1^{\bar{1}}, \widetilde{W}_2^{\bar{0}} \oplus \widetilde{W}_2^{\bar{1}}} \circ F^{-1} \circ F \circ ((f_1 \circ P_{W_1}^{|f_2|}) \boxtimes_{\mathcal{C}} f_2) \circ F^{-1} \\ &= F \circ Q_{\widetilde{W}_2, \widetilde{W}_1} \circ (f_2 \boxtimes_{\mathcal{C}} (f_1 \circ P_{W_1}^{|f_2|})) \circ \mathcal{R}_{\widetilde{W}_1^{\bar{0}} \oplus \widetilde{W}_1^{\bar{1}}, \widetilde{W}_2^{\bar{0}} \oplus \widetilde{W}_2^{\bar{1}}} \circ F^{-1} \end{aligned} \quad (2.5)$$

by the naturality of the braiding isomorphisms in \mathcal{C} . Now, we can write

$$f_2 = \sum_{j_2+j'_2=|f_2|} q_{\widetilde{W}_2^{j'_2}} \circ f_{j'_2,j_2}^{(2)} \circ p_{W_2^{j_2}},$$

where $f_{j'_2,j_2}^{(2)} = p_{\widetilde{W}_2^{j'_2}} \circ f \circ q_{W_2^{j_2}}$ is a morphism in \mathcal{C} from $W_2^{j_2}$ to $\widetilde{W}_2^{j'_2}$. Similarly,

$$\begin{aligned} f_1 \circ P_{W_1}^{|f_2|} &= \left(\sum_{j_1+j'_1=|f_1|} q_{\widetilde{W}_1^{j'_1}} \circ f_{j'_1,j_1}^{(1)} \circ p_{W_1^{j_1}} \right) \circ \left(\sum_{k \in \mathbb{Z}/2\mathbb{Z}} (-1)^k |f_2| q_{W_1^k} \circ p_{W_1^k} \right) \\ &= \sum_{j_1+j'_1=|f_1|} (-1)^{j_1|f_2|} q_{\widetilde{W}_1^{j'_1}} \circ f_{j'_1,j_1}^{(1)} \circ p_{W_1^{j_1}}. \end{aligned}$$

Thus

$$\begin{aligned} &Q_{\widetilde{W}_2, \widetilde{W}_1} \circ \left(f_2 \boxtimes (f_1 \circ P_{W_1}^{|f_2|}) \right) \\ &= \sum_{\substack{i_1, i_2 \in \mathbb{Z}/2\mathbb{Z} \\ j_1+j'_1=|f_1|, j_2+j'_2=|f_2|}} (-1)^{i_1 i_2 + j_1 |f_2|} \\ &\quad \cdot \left(q_{\widetilde{W}_2^{i_2}} \circ p_{\widetilde{W}_2^{i_2}} \circ q_{\widetilde{W}_2^{j'_2}} \circ f_{j'_2,j_2}^{(2)} \circ p_{W_2^{j_2}} \right) \boxtimes \left(q_{\widetilde{W}_1^{i_1}} \circ p_{\widetilde{W}_1^{i_1}} \circ q_{\widetilde{W}_1^{j'_1}} \circ f_{j'_1,j_1}^{(1)} \circ p_{W_1^{j_1}} \right) \\ &= \sum_{\substack{i_1+j_1=|f_1| \\ i_2+j_2=|f_2|}} (-1)^{i_1 i_2 + j_1 |f_2|} \left(q_{\widetilde{W}_2^{i_2}} \circ f_{i_2,j_2}^{(2)} \circ p_{W_2^{j_2}} \right) \boxtimes \left(q_{\widetilde{W}_1^{i_1}} \circ f_{i_1,j_1}^{(1)} \circ p_{W_1^{j_1}} \right) \\ &= \sum_{\substack{i_1+j_1=|f_1| \\ i_2+j_2=|f_2|}} (-1)^{j_1 j_2 + i_2 |f_1|} \left(q_{\widetilde{W}_2^{i_2}} \circ f_{i_2,j_2}^{(2)} \circ p_{W_2^{j_2}} \right) \boxtimes \left(q_{\widetilde{W}_1^{i_1}} \circ f_{i_1,j_1}^{(1)} \circ p_{W_1^{j_1}} \right) \\ &= \sum_{\substack{i_1+i'_1=|f_1| \\ i_2+i'_2=|f_2|}} (-1)^{i_2 |f_1|} \left(q_{\widetilde{W}_2^{i_2}} \circ f_{i_2,i'_2}^{(2)} \circ p_{W_2^{i'_2}} \right) \boxtimes \left(q_{\widetilde{W}_1^{i_1}} \circ f_{i_1,i'_1}^{(1)} \circ p_{W_1^{i'_1}} \right) \circ \\ &\quad \circ \sum_{j_1, j_2 \in \mathbb{Z}/2\mathbb{Z}} (-1)^{j_1 j_2} (q_{W_2^{j_2}} \circ p_{W_2^{j_2}}) \boxtimes (q_{W_1^{j_1}} \circ p_{W_1^{j_1}}) \\ &= \sum_{i_2+i'_2=|f_2|} (-1)^{(i'_2+|f_2|)|f_1|} \left(\left(q_{\widetilde{W}_2^{i_2}} \circ f_{i_2,i'_2}^{(2)} \circ p_{W_2^{i'_2}} \right) \boxtimes f_1 \right) \circ Q_{W_2, W_1} \\ &= (-1)^{|f_1||f_2|} \left((f_2 \circ P_{W_2}^{|f_1|}) \boxtimes f_1 \right) \circ Q_{W_2, W_1}. \end{aligned}$$

Putting this into (2.5) and using the definitions quickly yields (2.4).

Now to check the hexagon diagram for $\underline{\mathcal{R}}$, take objects W_1, W_2 , and W_3 in \mathcal{SC} . For $i_1, i_2, i_3 \in \mathbb{Z}/2\mathbb{Z}$, we have the following commuting diagram thanks to the hexagon axiom for \mathcal{R} :

$$\begin{array}{ccccc} W_1^{i_1} \boxtimes (W_2^{i_2} \boxtimes W_3^{i_3}) & \xrightarrow{(-1)^{i_1(i_2+i_3)} \mathcal{R}} & (W_2^{i_2} \boxtimes W_3^{i_3}) \boxtimes W_1^{i_1} & \xrightarrow{\mathcal{A}^{-1}} & W_2^{i_2} \boxtimes (W_3^{i_3} \boxtimes W_1^{i_1}), \\ \downarrow \mathcal{A} & & & & \uparrow 1 \boxtimes (-1)^{i_1 i_3} \mathcal{R} \\ (W_1^{i_1} \boxtimes W_2^{i_2}) \boxtimes W_3^{i_3} & \xrightarrow{(-1)^{i_1 i_2} \mathcal{R} \boxtimes 1} & (W_2^{i_2} \boxtimes W_1^{i_1}) \boxtimes W_3^{i_3} & \xrightarrow{\mathcal{A}^{-1}} & W_2^{i_2} \boxtimes (W_1^{i_1} \boxtimes W_3^{i_3}) \end{array} \quad (2.6)$$

and a similar diagram involving \mathcal{R}^{-1} . These immediately yield the hexagon axioms for $\underline{\mathcal{R}}$. \square

Remark 2.21. Note the essential role of the parity factor in the definition of the tensor product of morphisms in \mathcal{SC} for proving the naturality of $\underline{\mathcal{R}}$. The naturality of $\underline{\mathcal{R}}$ says that the tensor product of morphisms in \mathcal{SC} supercommutes up to conjugation by braiding isomorphisms.

Remark 2.22. Since all the structure morphisms in \mathcal{SC} are even, the braided tensor supercategory structure on \mathcal{SC} reduces to a braided tensor category structure on $\underline{\mathcal{SC}}$. In particular, the supercategory naturality of $\underline{\mathcal{R}}$ reduces to ordinary naturality when both morphisms f_1 and f_2 are even.

We will need tensoring in \mathcal{SC} to be right exact, just as it is in \mathcal{C} :

Proposition 2.23. *For any object W in \mathcal{SC} , the functors $W \boxtimes \cdot$ and $\cdot \boxtimes W$ are right exact.*

Proof. First consider $\cdot \boxtimes W$. Suppose $W_1 \xrightarrow{f_1} W_2 \xrightarrow{f_2} W_3 \rightarrow 0$ is a right exact sequence in \mathcal{SC} , that is, (W_3, f_2) is a cokernel of f_1 . We need to verify that $(W_3 \boxtimes_{\mathcal{SC}} W, f_2 \boxtimes_{\mathcal{SC}} 1_W)$ is a cokernel of $f_1 \boxtimes_{\mathcal{SC}} 1_W$. Since $f_i \boxtimes_{\mathcal{SC}} 1_W = F \circ (f_i \boxtimes_{\mathcal{C}} 1_{W^{\bar{0}} \oplus W^{\bar{1}}}) \circ F^{-1}$ for $i = 1, 2$, using the notation of Proposition 2.10 (since 1_W is even), it is enough to show that $((W_2^{\bar{0}} \oplus W_2^{\bar{1}}) \boxtimes (W^{\bar{0}} \oplus W^{\bar{1}}), f_2 \boxtimes_{\mathcal{C}} 1_{W^{\bar{0}} \oplus W^{\bar{1}}})$ is a cokernel of $f_1 \boxtimes_{\mathcal{C}} 1_{W^{\bar{0}} \oplus W^{\bar{1}}}$ in \mathcal{C} . But this is immediate because the tensor functor on \mathcal{C} is right exact by assumption.

For $W \boxtimes \cdot$, right exactness follows from the right exactness of $\cdot \boxtimes W$ and the naturality of the braiding isomorphisms (which reduces to ordinary naturality in this case since 1_W is even). \square

Remark 2.24. It is not hard to show that the tensor product functor in $\underline{\mathcal{SC}}$ is also right exact.

Now that we have a braided tensor supercategory associated to \mathcal{C} with right exact tensor functor, we can introduce the notion of supercommutative associative superalgebra in \mathcal{C} :

Definition 2.25. A *supercommutative associative superalgebra* (or *superalgebra* for short) in \mathcal{C} is a commutative associative algebra in \mathcal{SC} whose structure morphisms are even. Explicitly, a superalgebra in \mathcal{C} is an object $A = (A^{\bar{0}}, A^{\bar{1}})$ of \mathcal{SC} equipped with even morphisms $\mu : A \boxtimes A \rightarrow A$ and $\iota_A : \underline{1} \rightarrow A$ in \mathcal{SC} satisfying the following axioms:

1. Associativity: $\mu \circ (\mu \boxtimes 1_A) \circ \underline{A}_{A,A,A} = \mu \circ (1_A \boxtimes \mu)$ as morphisms $A \boxtimes (A \boxtimes A) \rightarrow A$.
2. Supercommutativity: $\mu \circ \underline{R}_{A,A} = \mu$ as morphisms $A \boxtimes A \rightarrow A$.
3. Unit: $\mu \circ (\iota_A \boxtimes 1_A) \circ \underline{L}_A^{-1} = 1_A$ as morphisms $A \rightarrow A$.

Remark 2.26. The supercommutativity and unit axioms of the above definition (together with the naturality of \underline{R} with respect to even morphisms) imply the right unit property: $\mu \circ (1_A \boxtimes \iota_A) \circ \underline{L}_A^{-1} = 1_A$.

Remark 2.27. Since the structure morphisms of a superalgebra in \mathcal{C} are even, superalgebras in \mathcal{C} are precisely commutative associative algebras in the braided tensor category $\underline{\mathcal{SC}}$.

Remark 2.28. If \mathcal{C} is a braided tensor category of modules for a vertex operator algebra V and A is a superalgebra in \mathcal{C} , recall the twist \mathcal{C} -automorphism $\theta_A = e^{2\pi i L(0)}$ of A . It is shown in [CKL], slightly generalizing the results of [HKL, Hu9], that superalgebras A in \mathcal{C} which additionally satisfy:

4. ι_A is injective;
5. A is $\frac{1}{2}\mathbb{Z}$ -graded by conformal weights: $\theta_A^2 = 1_A$; and
6. μ has no monodromy: $\mu \circ (\theta_A \boxtimes \theta_A) = \theta_A \circ \mu$

are precisely vertex operator superalgebra extensions of V in \mathcal{C} such that $V \subseteq A^{\bar{0}}$.

Since a superalgebra A in \mathcal{C} is an algebra in \mathcal{SC} with even structure morphisms, we can define the category $\text{Rep } A$ of “ A -modules in \mathcal{C} ” to be the category of “ A -modules in \mathcal{SC} ” with even structure morphisms:

Definition 2.29. Given a superalgebra A in \mathcal{C} , $\text{Rep } A$ is the category with objects (W, μ_W) where W is an object of \mathcal{SC} , and $\mu_W : A \boxtimes W \rightarrow W$ is an even morphism satisfying:

1. Associativity: $\mu_W \circ (\mu \boxtimes 1_W) \circ \underline{A}_{A,A,W} = \mu_W \circ (1_A \boxtimes \mu_W)$ as morphisms $A \boxtimes (A \boxtimes W) \rightarrow W$.
2. Unit: $\mu_W \circ (\iota_A \boxtimes 1_W) \circ \underline{L}_W^{-1} = 1_W$ as morphisms $W \rightarrow W$.

The morphisms between objects (W_1, μ_{W_1}) and (W_2, μ_{W_2}) of $\text{Rep } A$ consist of all \mathcal{SC} -morphisms $f : W_1 \rightarrow W_2$ such that $f \circ \mu_{W_1} = \mu_{W_2} \circ (1_A \boxtimes f) : A \boxtimes W_1 \rightarrow W_2$.

Remark 2.30. If A is a superalgebra in \mathcal{C} , let $\underline{\text{Rep}} A$ denote the category of A -modules where A is considered as an algebra in $\underline{\mathcal{SC}}$, as defined in the previous subsection. Then $\underline{\text{Rep}} A$ contains exactly the same objects as $\text{Rep } A$, but $\underline{\text{Rep}} A$ contains more morphisms since $\underline{\text{Rep}} A$ has only even morphisms.

Remark 2.31. Since a superalgebra A in \mathcal{C} is an algebra in the braided tensor category $\underline{\mathcal{SC}}$, Theorem 2.9 shows that the category $\underline{\text{Rep}} A$ is abelian. However, we cannot guarantee that the larger category $\text{Rep } A$ is abelian since, although Theorem 2.9 shows that kernels and cokernels of not necessarily parity-homogeneous morphisms in $\text{Rep } A$ are equipped with A -actions that satisfy associativity and the unit property, we cannot guarantee that these A -actions are even.

However, we do have:

Proposition 2.32. *If A is a superalgebra in \mathcal{C} , then $\text{Rep } A$ is an \mathbb{F} -linear additive supercategory. Moreover, parity-homogeneous morphisms in $\text{Rep } A$ have kernels and cokernels, every parity-homogeneous monomorphism in $\text{Rep } A$ is a kernel in $\text{Rep } A$, and every parity-homogeneous epimorphism is a cokernel in $\text{Rep } A$.*

Proof. The \mathbb{F} -vector space structure on morphisms in $\text{Rep } A$ is inherited from \mathcal{SC} . To show that morphisms in $\text{Rep } A$ have superspace structure, we need to show that if $f : W_1 \rightarrow W_2$ is a morphism in $\text{Rep } A$, then its parity-homogeneous components $f^{\bar{0}}$ and $f^{\bar{1}}$ are also $\text{Rep } A$ -morphisms. Since f is a morphism in $\text{Rep } A$, we have $f \circ \mu_{W_1} = \mu_{W_2} \circ (1_A \boxtimes f)$. Then

$$f^{\bar{0}} \circ \mu_{W_1} + f^{\bar{1}} \circ \mu_{W_2} = \mu_{W_2} \circ (1_A \boxtimes f^{\bar{0}}) + \mu_{W_2} \circ (1_A \boxtimes f^{\bar{1}}).$$

Since μ_{W_1} and μ_{W_2} are both even, matching even and odd components of the above equation shows that $f^{\bar{0}}$ and $f^{\bar{1}}$ are $\text{Rep } A$ -morphisms. The evenness and bilinearity of composition of morphisms in $\text{Rep } A$ is then inherited from \mathcal{SC} , so $\text{Rep } A$ is an \mathbb{F} -linear supercategory.

The existence of a zero object in $\text{Rep } A$ is clear, and the existence of biproducts in $\text{Rep } A$ is the same as in the proof of Theorem 2.9, except that we need to additionally show that the A -action $\mu_{\bigoplus W_i}$ on a biproduct $\bigoplus W_i$ is even. Since $\mu_{\bigoplus W_i} = \sum q_i \circ \mu_{W_i} \circ (1_A \boxtimes p_i)$ is the composition of even morphisms, this is clear. Thus $\text{Rep } A$ is an \mathbb{F} -linear additive supercategory.

Now we need to show that if $f : W_1 \rightarrow W_2$ is a parity-homogeneous morphism in $\text{Rep } A$, then f has a cokernel and kernel in $\text{Rep } A$. We know from Theorem 2.9 that f has a kernel (K, k) and a cokernel (C, c) in \mathcal{SC} equipped with A -actions μ_K and μ_C satisfying the associativity and unit properties. It will follow that (K, μ_K, k) and (C, μ_C, c) are the kernel and cokernel of f in $\text{Rep } A$ if μ_K and μ_C are even. Since f is parity-homogeneous, Proposition 2.15 implies we may assume k and c are even. To show that μ_C is even, recall from Theorem 2.9 that $\mu_C \circ (1_A \boxtimes c) = c \circ \mu_{W_2}$, so that

$$P_C \circ \mu_C \circ (1_A \boxtimes c) = P_C \circ c \circ \mu_{W_2} = c \circ \mu_{W_2} \circ P_{A \boxtimes W_2} = \mu_C \circ (1_A \boxtimes c) \circ P_{A \boxtimes W_2} = \mu_C \circ P_{A \boxtimes C} \circ (1_A \boxtimes c).$$

Since c is an epimorphism and $A \boxtimes \cdot$ in \mathcal{SC} is right exact, $1_A \boxtimes c$ is an epimorphism and it follows that $P_C \circ \mu_C = \mu_C \circ P_{A \boxtimes C}$. Thus μ_C is even. Similarly, μ_K is even.

Finally, we need to verify that every parity-homogeneous monomorphism in $\text{Rep } A$ is a kernel and every parity-homogeneous epimorphism in $\text{Rep } A$ is a cokernel. In fact, the proof of Theorem 2.9 shows that a parity-homogeneous monomorphism in $\text{Rep } A$ is the kernel of its cokernel, and a parity-homogeneous epimorphism in $\text{Rep } A$ is the cokernel of its kernel. \square

Remark 2.33. In the following subsections where we construct a tensor product on $\text{Rep } A$, we shall only need the existence of cokernels of certain even morphisms in $\text{Rep } A$.

2.3 Tensor products and unit isomorphisms in $\text{Rep } A$

Here we fix a superalgebra A in our \mathbb{F} -linear braided tensor category \mathcal{C} and construct a tensor product $\boxtimes_A : \text{Rep } A \times \text{Rep } A \rightarrow \text{Rep } A$ as well as left and right unit isomorphisms. The construction of \boxtimes_A is based on [KO]; later, we shall show that this tensor product is characterized by a universal property analogous to the defining property of tensor products of vertex operator algebra modules. Although we work in the generality of superalgebras, all results and constructions apply as well to the category $\text{Rep } A$ of modules for an ordinary commutative associative algebra in \mathcal{C} ; the only difference is that for an ordinary algebra we do not have to worry about evenness of certain morphisms or certain sign factors (as in the super interchange law). In particular, the following results and constructions apply to algebras in $\underline{\mathcal{SC}}$ since $\underline{\mathcal{SC}}$ is a braided tensor category with right exact tensor functor.

Notation 2.34. In this and the following subsections, we will frequently give summaries of lengthy proofs in braided tensor (super)categories using graphical calculus. We shall denote the unit $\mathbf{1}$ (or $\underline{\mathbf{1}}$) by dashed lines, the (super)algebra A by thin strands, objects of \mathcal{C} or \mathcal{SC} by thick strands, and morphisms and multiplications μ_\bullet by coupons. We read diagrams from bottom to top: for instance, in the composition $f \circ g$, the morphism g appears at the bottom.

Definition 2.35. For objects (W_1, μ_{W_1}) and (W_2, μ_{W_2}) of $\text{Rep } A$, we define $\mu^{(1)}$ to be the composition

$$A \boxtimes (W_1 \boxtimes W_2) \xrightarrow{\underline{A}_{A, W_1, W_2}} (A \boxtimes W_1) \boxtimes W_2 \xrightarrow{\mu_{W_1} \boxtimes 1_{W_2}} W_1 \boxtimes W_2$$

and we define $\mu^{(2)}$ to be the composition

$$A \boxtimes (W_1 \boxtimes W_2) \xrightarrow{\underline{A}_{A, W_1, W_2}} (A \boxtimes W_1) \boxtimes W_2 \xrightarrow{\underline{\mathcal{R}}_{A, W_1} \boxtimes 1_{W_2}} (W_1 \boxtimes A) \boxtimes W_2$$

$$\xrightarrow{\underline{A}_{W_1, A, W_2}^{-1}} W_1 \boxtimes (A \boxtimes W_2) \xrightarrow{1_{W_1} \boxtimes \mu_{W_2}} W_1 \boxtimes W_2.$$

Remark 2.36. By the hexagon axiom for a braided tensor (super)category and naturality of the braiding for even morphisms, $\mu^{(2)}$ is also given by the composition

$$A \boxtimes (W_1 \boxtimes W_2) \xrightarrow{1_A \boxtimes \mathcal{R}_{W_2, W_1}^{-1}} A \boxtimes (W_2 \boxtimes W_1) \xrightarrow{\underline{A}_{A, W_2, W_1}} (A \boxtimes W_2) \boxtimes W_1 \xrightarrow{\mu_{W_2} \boxtimes 1_{W_1}} W_2 \boxtimes W_1 \xrightarrow{\mathcal{R}_{W_2, W_1}} W_1 \boxtimes W_2. \quad (2.7)$$

We shall frequently use this alternate formulation of $\mu^{(2)}$.

Lemma 2.37. For $i = 1, 2$, we have

$$\mu^{(i)} \circ (1_A \boxtimes \mu^{(i)}) = \mu^{(i)} \circ (\mu \boxtimes 1_{W_1 \boxtimes W_2}) \circ \underline{A}_{A, A, W_1 \boxtimes W_2}$$

as morphisms $A \boxtimes (A \boxtimes (W_1 \boxtimes W_2)) \rightarrow W_1 \boxtimes W_2$.

Proof. We indicate the proof for $\mu^{(2)}$ using graphical calculus; the proof for $\mu^{(1)}$ is similar but simpler. In the first diagram, we have used Remark 2.36 to rewrite $\mu^{(2)}$, and in the last step we exchange the order of μ and the braiding without a sign factor because they are even:

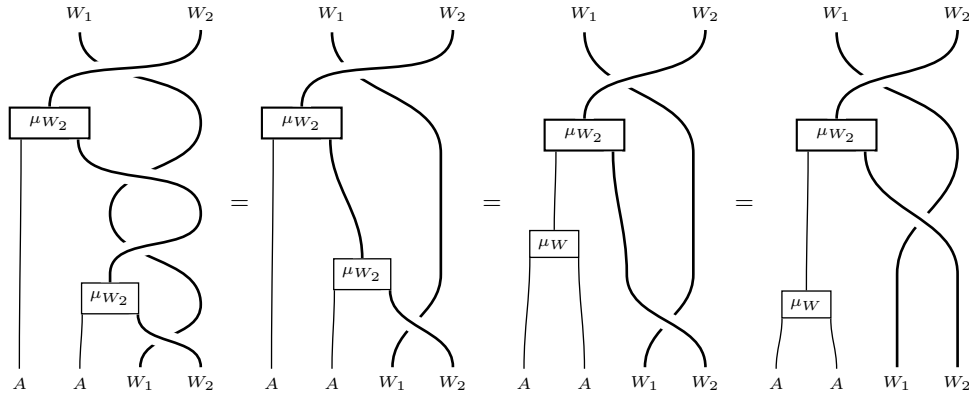

□

Since cokernels exist in SC , we can define the tensor product of W_1 and W_2 in $\text{Rep } A$ to be

$$W_1 \boxtimes_A W_2 = \text{Coker}(\mu^{(1)} - \mu^{(2)})$$

with cokernel \mathcal{C} -morphism

$$\eta_{W_1, W_2} : W_1 \boxtimes W_2 \rightarrow W_1 \boxtimes_A W_2.$$

Both $\mu^{(1)}$ and $\mu^{(2)}$ are compositions of even morphisms and are therefore even; thus by Proposition 2.15 we may and do take η_{W_1, W_2} even. Our definition of $W_1 \boxtimes_A W_2$ is equivalent to that in [KO],

$$W_1 \boxtimes_A W_2 = W_1 \boxtimes W_2 / \text{Im}(\mu^{(1)} - \mu^{(2)}),$$

with η_{W_1, W_2} now the quotient morphism.

The left action of A on $W_1 \boxtimes_A W_2$ is given by the following proposition:

Proposition 2.38. There is a unique SC -morphism

$$\mu_{W_1 \boxtimes_A W_2} : A \boxtimes (W_1 \boxtimes_A W_2) \rightarrow W_1 \boxtimes_A W_2$$

such that for both $i = 1, 2$, the following diagram commutes:

$$\begin{array}{ccc} A \boxtimes (W_1 \boxtimes W_2) & \xrightarrow{\mu^{(i)}} & W_1 \boxtimes W_2 \\ \downarrow 1_A \boxtimes \eta_{W_1, W_2} & & \downarrow \eta_{W_1, W_2} \\ A \boxtimes (W_1 \boxtimes_A W_2) & \xrightarrow{\mu_{W_1 \boxtimes_A W_2}} & W_1 \boxtimes_A W_2 \end{array} \quad (2.8)$$

Moreover, $\mu_{W_1 \boxtimes_A W_2}$ is even and $(W_1 \boxtimes_A W_2, \mu_{W_1 \boxtimes_A W_2})$ is an object of $\text{Rep } A$.

Proof. Since $A \boxtimes \cdot$ is right exact, $(A \boxtimes (W_1 \boxtimes_A W_2), 1_A \boxtimes \eta_{W_1, W_2})$ is a cokernel of the morphism

$$1_A \boxtimes (\mu^{(1)} - \mu^{(2)}) : A \boxtimes (A \boxtimes (W_1 \boxtimes W_2)) \rightarrow A \boxtimes (W_1 \boxtimes W_2).$$

Thus if we can show that

$$\eta_{W_1, W_2} \circ \mu^{(i)} \circ (1_A \boxtimes (\mu^{(1)} - \mu^{(2)})) = 0 \quad (2.9)$$

for $i = 1, 2$, the universal property of the cokernel will imply that there are unique morphisms

$$\mu_{W_1, W_2}^{(i)} : A \boxtimes (W_1 \boxtimes_A W_2) \rightarrow W_1 \boxtimes_A W_2$$

such that the diagram

$$\begin{array}{ccc} A \boxtimes (W_1 \boxtimes W_2) & \xrightarrow{\mu^{(i)}} & W_1 \boxtimes W_2 \\ 1_A \boxtimes \eta_{W_1, W_2} \downarrow & & \downarrow \eta_{W_1, W_2} \\ A \boxtimes (W_1 \boxtimes_A W_2) & \xrightarrow{\mu_{W_1, W_2}^{(i)}} & W_1 \boxtimes_A W_2 \end{array} \quad (2.10)$$

commutes for $i = 1, 2$. But then since $\eta_{W_1, W_2} \circ \mu^{(1)} = \eta_{W_1, W_2} \circ \mu^{(2)}$, the uniqueness will imply $\mu_{W_1, W_2}^{(1)} = \mu_{W_1, W_2}^{(2)}$, and we can call this common morphism $\mu_{W_1 \boxtimes_A W_2}$.

To show (2.9), we see from Lemma 2.37 that

$$\begin{aligned} \mu^{(1)} \circ (1_A \boxtimes (\mu^{(1)} - \mu^{(2)})) &= \mu^{(1)} \circ (\mu \boxtimes 1_{W_1 \boxtimes W_2}) \circ \underline{A}_{A, A, W_1 \boxtimes W_2} - \mu^{(1)} \circ (1_A \boxtimes \mu^{(2)}) \\ &= (\mu^{(1)} - \mu^{(2)}) \circ (\mu \boxtimes 1_{W_1 \boxtimes W_2}) \circ \underline{A}_{A, A, W_1 \boxtimes W_2} - (\mu^{(1)} - \mu^{(2)}) \circ (1_A \boxtimes \mu^{(2)}). \end{aligned}$$

Similarly,

$$\mu^{(2)} \circ (1_A \boxtimes (\mu^{(1)} - \mu^{(2)})) = (\mu^{(1)} - \mu^{(2)}) \circ ((\mu \boxtimes 1_{W_1 \boxtimes W_2}) \circ \underline{A}_{A, A, W_1 \boxtimes W_2} - 1_A \boxtimes \mu^{(1)}).$$

Thus (2.9) holds for $i = 1, 2$ because $\eta_{W_1, W_2} \circ (\mu^{(1)} - \mu^{(2)}) = 0$. This proves the existence and uniqueness of $\mu_{W_1 \boxtimes_A W_2}$. The evenness of $\mu_{W_1 \boxtimes_A W_2}$ follows easily from the evenness of $\mu^{(i)}$ and η_{W_1, W_2} and the surjectivity of the cokernel $1_A \boxtimes \eta_{W_1, W_2}$.

Now we show that $(W_1 \boxtimes_A W_2, \mu_{W_1 \boxtimes_A W_2})$ is an object of $\text{Rep } A$. For associativity of $\mu_{W_1 \boxtimes_A W_2}$, we first calculate

The first equality uses properties of associativity, the second follows from (2.8), the third is due to Lemma 2.37, and the last is a repeated application of (2.10). Now associativity of $\mu_{W_1 \boxtimes_A W_2}$ follows since η_{W_1, W_2} is surjective and $A \boxtimes \cdot$ is right exact.

For the unit property of $\mu_{W_1 \boxtimes_A W_2}$, we need to prove

$$\mu_{W_1 \boxtimes_A W_2} \circ (\iota_A \boxtimes 1_{W_1 \boxtimes_A W_2}) \circ \iota_{W_1 \boxtimes_A W_2}^{-1} = 1_{W_1 \boxtimes_A W_2}. \quad (2.11)$$

Using first naturality of the left unit isomorphism and the triangle axiom, then (2.8), and finally the unit property of μ_{W_1} , we get

This calculation indeed proves (2.11) since the cokernel morphism η_{W_1, W_2} is surjective. \square

For \boxtimes_A to define a functor $\text{Rep } A \times \text{Rep } A \rightarrow \text{Rep } A$, we also need tensor products of morphisms:

Proposition 2.39. *If $f_1 : W_1 \rightarrow \widetilde{W}_1$ and $f_2 : W_2 \rightarrow \widetilde{W}_2$ are morphisms in $\text{Rep } A$, then there is a unique $\text{Rep } A$ -morphism*

$$f_1 \boxtimes_A f_2 : W_1 \boxtimes_A W_2 \rightarrow \widetilde{W}_1 \boxtimes_A \widetilde{W}_2$$

such that the following diagram commutes.

$$\begin{array}{ccc}
 W_1 \boxtimes W_2 & \xrightarrow{f_1 \boxtimes f_2} & \widetilde{W}_1 \boxtimes \widetilde{W}_2 \\
 \eta_{W_1, W_2} \downarrow & & \downarrow \eta_{\widetilde{W}_1, \widetilde{W}_2} \\
 W_1 \boxtimes_A W_2 & \xrightarrow{f_1 \boxtimes_A f_2} & \widetilde{W}_1 \boxtimes_A \widetilde{W}_2
 \end{array} \tag{2.12}$$

Proof. For $i = 1, 2$, it is easy to show that

$$\mu^{(i)} \circ (1_A \boxtimes (f_1 \boxtimes f_2)) = (f_1 \boxtimes f_2) \circ \mu^{(i)} : A \boxtimes (W_1 \boxtimes W_2) \rightarrow \widetilde{W}_1 \boxtimes \widetilde{W}_2. \tag{2.13}$$

Indeed, for $i = 1$, this follows from the naturality of associativity, evenness of μ_{W_1} , and the fact that f_1 is a morphism in $\text{Rep } A$, while for $i = 2$, we use the same properties of μ_{W_2} and f_2 plus naturality of the braiding. Now, (2.13) implies that the composition

$$\eta_{\widetilde{W}_1, \widetilde{W}_2} \circ (f_1 \boxtimes f_2) \circ (\mu^{(1)} - \mu^{(2)}) : A \boxtimes (W_1 \boxtimes W_2) \rightarrow \widetilde{W}_1 \boxtimes_A \widetilde{W}_2$$

is 0. Thus the universal property of the cokernel $(W_1 \boxtimes_A W_2, \eta_{W_1, W_2})$ induces a unique \mathcal{SC} -morphism

$$f_1 \boxtimes_A f_2 : W_1 \boxtimes_A W_2 \rightarrow \widetilde{W}_1 \boxtimes_A \widetilde{W}_2$$

making the diagram (2.12) commute. To show that $f_1 \boxtimes_A f_2$ is a $\text{Rep } A$ -morphism:

We use (2.8) for the first and fourth equalities, (2.12) for the second and last, and (2.13) for the third. Recalling that $1_A \boxtimes \eta_{W_1, W_2}$ is surjective because $A \boxtimes \cdot$ is right exact, $f_1 \boxtimes_A f_2$ is a $\text{Rep } A$ -morphism. \square

The characterization of $f_1 \boxtimes_A f_2$ as the unique morphism making (2.12) commute implies that \boxtimes_A is a functor from $\text{Rep } A \times \text{Rep } A$ to $\text{Rep } A$. That is, the super interchange law

$$(f_1 \boxtimes_A f_2) \circ (g_1 \boxtimes_A g_2) = (-1)^{|f_2||g_1|} (f_1 \circ g_1) \boxtimes_A (f_2 \circ g_2)$$

holds for appropriately composable parity-homogeneous morphisms $f_1, f_2, g_1,$ and g_2 in $\text{Rep } A$, and $1_{W_1} \boxtimes_A 1_{W_2} = 1_{W_1 \boxtimes_A W_2}$ for objects W_1 and W_2 of $\text{Rep } A$. The characterization (2.12) also implies that the tensor product of morphisms in $\text{Rep } A$ is bilinear, since the tensor product of morphisms in the tensor supercategory \mathcal{SC} is bilinear.

Now we construct the left and right unit isomorphisms in $\text{Rep } A$.

Proposition 2.40. *If (W, μ_W) is an object of $\text{Rep } A$, there is a unique isomorphism $l_W^A : A \boxtimes_A W \rightarrow W$ in $\text{Rep } A$ such that*

$$l_W^A \circ \eta_{A,W} = \mu_W : A \boxtimes W \rightarrow W, \quad (2.14)$$

and l_W^A is even.

Proof. The existence and uniqueness of the \mathcal{C} -morphism l_W^A follows from the universal property of the cokernel $(A \boxtimes_A W, \eta_{A,W})$, provided $\mu_W \circ \mu^{(1)} = \mu_W \circ \mu^{(2)}$. In fact, this is immediate from

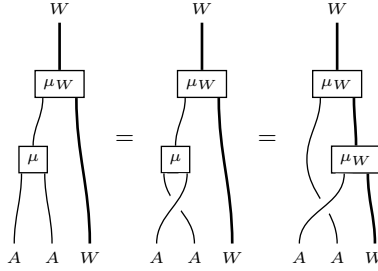

The evenness of l_W^A is clear from the evenness of μ_W and $\eta_{A,W}$ and the surjectivity of $\eta_{A,W}$.

Now we need to show that l_W^A is a morphism in $\text{Rep } A$, that is, that

$$l_W^A \circ \mu_{A \boxtimes_A W} = \mu_W \circ (1_A \boxtimes l_W^A) : A \boxtimes (A \boxtimes_A W) \rightarrow W.$$

By (2.8), (2.14), and the associativity of μ_W ,

$$\begin{aligned} l_W^A \circ \mu_{A \boxtimes_A W} \circ (1_A \boxtimes \eta_{A,W}) &= l_W^A \circ \eta_{A,W} \circ \mu^{(1)} = \mu_W \circ (\mu \boxtimes 1_A) \circ \underline{A}_{A,A,W} \\ &= \mu_W \circ (1_A \boxtimes \mu_W) = \mu_W \circ (1_A \boxtimes l_W^A) \circ (1_A \boxtimes \eta_{A,W}) \end{aligned}$$

as morphisms from $A \boxtimes (A \boxtimes_A W) \rightarrow W$. Because $1_A \boxtimes \eta_{A,W}$ is an epimorphism, l_W^A is a $\text{Rep } A$ -morphism.

To show that l_W^A is an isomorphism in $\text{Rep } A$, we construct its inverse. It is enough to show that l_W^A has an inverse in \mathcal{SC} , since an inverse in \mathcal{SC} will automatically commute with A -actions because l_W^A does. We will show that the composition

$$\tilde{l}_W^A : W \xrightarrow{l_W^{-1}} \underline{\mathbf{1}} \boxtimes W \xrightarrow{\iota_{A \boxtimes \mathbf{1} W}} A \boxtimes W \xrightarrow{\eta_{A,W}} A \boxtimes_A W$$

is the inverse to l_W^A . It is clear from (2.14) and the unit property for μ_W that $l_W^A \circ \tilde{l}_W^A = 1_W$. On the other hand, let us use λ to denote the composition

$$\lambda : A \boxtimes W \xrightarrow{\mu_W} W \xrightarrow{l_W^{-1}} \underline{\mathbf{1}} \boxtimes W \xrightarrow{\iota_{A \boxtimes \mathbf{1} W}} A \boxtimes W.$$

Since $\eta_{A,W} \circ \lambda = \tilde{l}_W^A \circ l_W^A \circ \eta_{A,W}$, the surjectivity of $\eta_{A,W}$ will imply $\tilde{l}_W^A \circ l_W^A = 1_{A \boxtimes_A W}$ provided that $\eta_{A,W} \circ \lambda = \eta_{A,W}$. We will show

$$1_{A \boxtimes W} \circ (1_A \boxtimes \underline{l}_W) = \mu^{(1)} \circ (1_A \boxtimes (\iota_A \boxtimes 1_W)), \quad (2.15)$$

$$\lambda \circ (1_A \boxtimes \underline{l}_W) = \mu^{(2)} \circ (1_A \boxtimes (\iota_A \boxtimes 1_W)) \quad (2.16)$$

as morphisms from $A \boxtimes (\underline{\mathbf{1}} \boxtimes W) \rightarrow A \boxtimes W$, and then

$$\eta_{A,W} \circ (1_{A \boxtimes W} - \lambda) = \eta_{A,W} \circ (1_{A \boxtimes W} - \lambda) \circ (1_A \boxtimes \underline{l}_W) \circ (1_A \boxtimes \underline{l}_W^{-1})$$

$$= \eta_{A,W} \circ (\mu^{(1)} - \mu^{(2)}) \circ (1_A \boxtimes (\iota_A \boxtimes 1_W)) \circ (1_A \boxtimes \underline{l}_W^{-1}) = 0,$$

as desired. Equation (2.15) follows from the right unit property for A (Remark 2.3) and the triangle axiom:

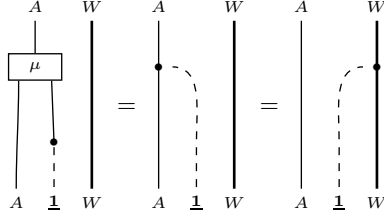

The proof of (2.16) is guided by the diagrams:

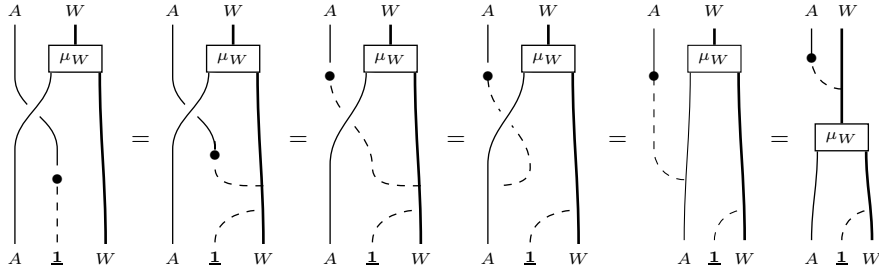

The detailed argument heavily uses properties of the unit isomorphisms, especially those in Proposition XIII.1.2 and Lemma XI.2.2 of [Kas]. This completes the proof that $\tilde{l}_W^A \circ l_W^A = 1_{A \boxtimes_A W}$. \square

Proposition 2.41. *The isomorphisms l_W^A for W in $\text{Rep } A$ define a natural isomorphism from $A \boxtimes_A \cdot$ to the identity functor on $\text{Rep } A$.*

Proof. We need to show that for any morphism $f : W_1 \rightarrow W_2$ in $\text{Rep } A$, we have

$$l_{W_2}^A \circ (1_A \boxtimes_A f) = f \circ l_{W_1}^A : A \boxtimes_A W_1 \rightarrow W_2. \quad (2.17)$$

Noting that η_{A,W_1} is surjective, this follows from the calculation

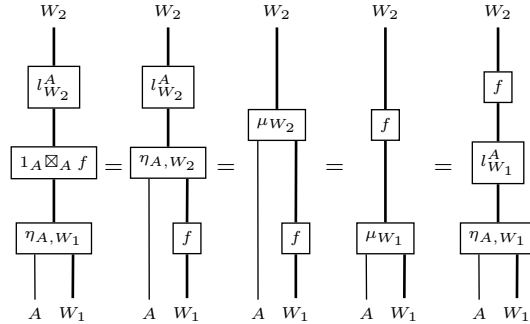

The first equality is due to (2.12), the second and last are due to (2.14), and the third follows because f is a morphism in $\text{Rep } A$. \square

Proposition 2.42. *If (W, μ_W) is an object of $\text{Rep } A$, then there is a unique $\text{Rep } A$ -isomorphism $r_W^A : W \boxtimes_A A \rightarrow W$ such that*

$$r_W^A \circ \eta_{W,A} = \mu_W \circ \underline{r}_{A,W}^{-1} : W \boxtimes_A A \rightarrow W, \quad (2.18)$$

and r_W^A is even.

Proof. The existence and uniqueness of the SC -morphism r_W^A satisfying (2.18) follows from the universal property of the cokernel $(W \boxtimes_A A, \eta_{W,A})$, provided that $\mu_W \circ \underline{\mathcal{R}}_{A,W}^{-1} \circ \mu^{(2)} = \mu_W \circ \underline{\mathcal{R}}_{A,W}^{-1} \circ \mu^{(1)}$. This is proved in the following diagrams:

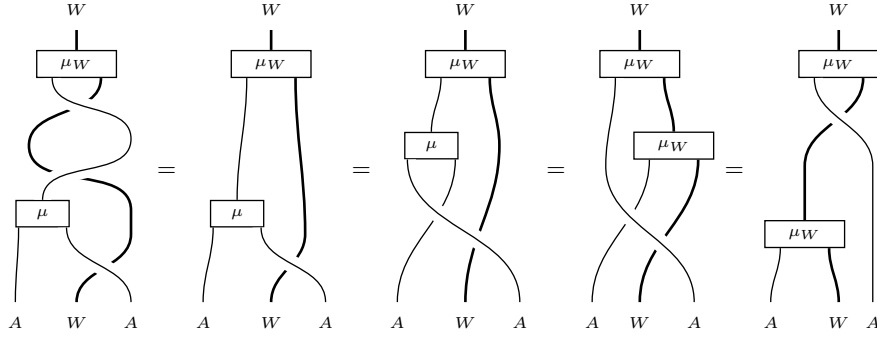

In the first figure, we have used Remark 2.36 to rewrite $\mu^{(2)}$. The second equality uses commutativity of μ , the third uses associativity of μ_W , and the last uses the hexagon identity and naturality of the braiding applied to the even morphism μ_W . This shows r_W^A exists, and r_W^A is even because $\eta_{W,A}$, μ_W , $\underline{\mathcal{R}}_{A,W}^{-1}$ are even, and because $\eta_{W,A}$ is surjective.

Next, we need to show that r_W^A is a morphism in $\text{Rep } A$, that is,

$$r_W^A \circ \mu_{W \boxtimes_A A} = \mu_W \circ (1_A \boxtimes r_W^A) : A \boxtimes (W \boxtimes_A A) \rightarrow W.$$

For this, we use the following diagrams together with the fact that $1_A \boxtimes \eta_{W,A}$ is an epimorphism:

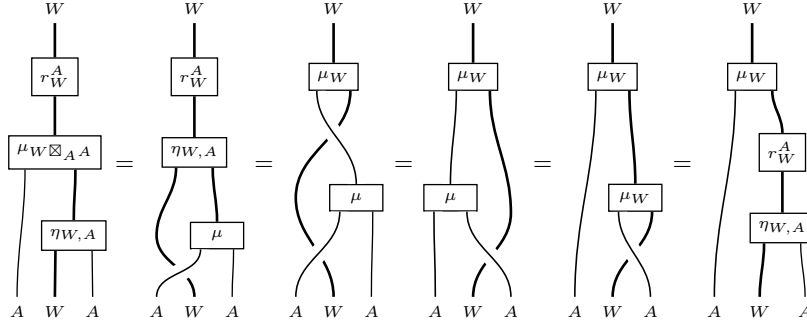

The first equality uses (2.8) with $i = 2$, while the second and last use (2.18). The third and fourth equalities use naturality of the braiding applied to μ , the hexagon axiom, and the associativity of μ_W .

Now we show that r_W^A has an inverse in SC (which will also be an inverse in $\text{Rep } A$). We define \tilde{r}_W^A to be the composition

$$W \xrightarrow{\underline{\mathcal{L}}_W^{-1}} W \boxtimes \mathbf{1} \xrightarrow{1_W \boxtimes \iota_A} W \boxtimes A \xrightarrow{\eta_{W,A}} W \boxtimes_A A.$$

To show that \tilde{r}_W^A is the inverse of r_W^A , note that by (2.18), $r_W^A \circ \tilde{r}_W^A$ equals the composition

$$W \xrightarrow{\underline{\mathcal{L}}_W^{-1}} W \boxtimes \mathbf{1} \xrightarrow{1_W \boxtimes \iota_A} W \boxtimes A \xrightarrow{\underline{\mathcal{R}}_{A,W}^{-1}} A \boxtimes W \xrightarrow{\mu_W} W.$$

Using naturality of the braiding with respect to even morphisms, this in turn equals

$$W \xrightarrow{\underline{\mathcal{L}}_W^{-1}} W \boxtimes \mathbf{1} \xrightarrow{\underline{\mathcal{R}}_{\mathbf{1},W}^{-1}} \mathbf{1} \boxtimes W \xrightarrow{\iota_A \boxtimes 1_W} A \boxtimes W \xrightarrow{\mu_W} W.$$

Now, $\underline{\mathcal{R}}_{\mathbf{1},W}^{-1} \circ \underline{\mathcal{L}}_W^{-1} = \underline{\mathcal{L}}_W^{-1}$ (see for instance Proposition XIII.1.2 in [Kas]), so the above composition equals 1_W by the unit property of μ_W . Consequently $r_W^A \circ \tilde{r}_W^A = 1_W$.

On the other hand, $\tilde{r}_W^A \circ r_W^A \circ \eta_{W,A} = \eta_{W,A} \circ \rho$, where ρ is the composition

$$W \boxtimes A \xrightarrow{\underline{\mathcal{R}}_{A,W}^{-1}} A \boxtimes W \xrightarrow{\mu_W} W \xrightarrow{\underline{\mathcal{L}}_W^{-1}} W \boxtimes \mathbf{1} \xrightarrow{1_W \boxtimes \iota_A} W \boxtimes A.$$

It is now enough to show that $\eta_{W,A} \circ (\rho - 1_{W \boxtimes A}) = 0$, and for this it is enough to show that

$$(\rho - 1_{W \boxtimes A}) \circ \underline{\mathcal{R}}_{A,W} \circ (1_A \boxtimes \underline{\mathcal{L}}_W) = (\mu^{(1)} - \mu^{(2)}) \circ (1_A \boxtimes (1_W \boxtimes \iota_A)) : A \boxtimes (W \boxtimes \underline{\mathbf{1}}) \rightarrow W \boxtimes A.$$

First, we prove $\mu^{(2)} \circ (1_A \boxtimes (1_W \boxtimes \iota_A)) = 1_{W \boxtimes A} \circ \underline{\mathcal{R}}_{A,W} \circ (1_A \boxtimes \underline{\mathcal{L}}_W)$ using the following diagrams:

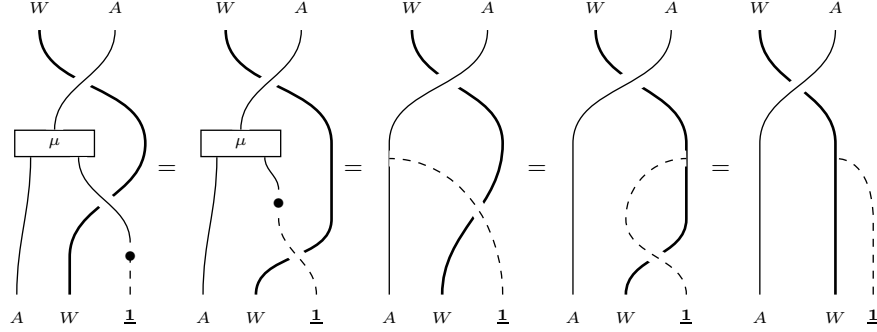

We complete the proof by establishing $\rho \circ \underline{\mathcal{R}}_{A,W} \circ (1_A \boxtimes \underline{\mathcal{L}}_W) = \mu^{(1)} \circ (1_A \boxtimes (1_W \boxtimes \iota_A))$:

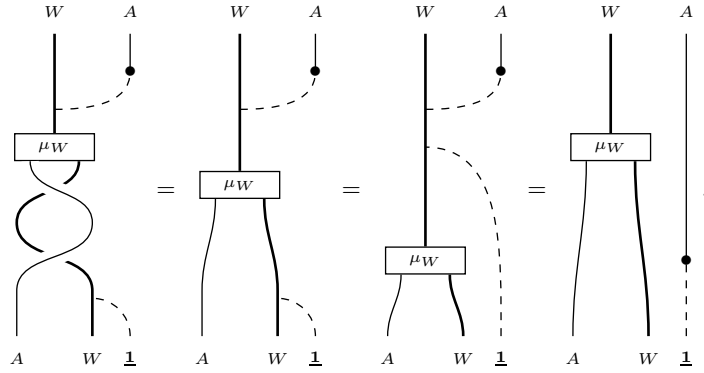

The second step uses $1_A \boxtimes \underline{\mathcal{L}}_W = \underline{\mathcal{L}}_{A \boxtimes W} \circ \underline{\mathcal{A}}_{A,W,\underline{\mathbf{1}}}$ (see Lemma XI.2.2 in [Kas]) and naturality of $\underline{\mathcal{L}}$. \square

Proposition 2.43. *The Rep A -isomorphisms r_W^A define a natural isomorphism from $\cdot \boxtimes_A A$ to the identity functor on Rep A .*

Proof. We just need to verify that for any morphism $f : W_1 \rightarrow W_2$ in Rep A , we have

$$r_{W_2}^A \circ (f \boxtimes_A 1_A) = f \circ r_{W_1}^A : W_1 \boxtimes_A A \rightarrow W_2. \quad (2.19)$$

Since $\eta_{W_1,A}$ is an epimorphism, (2.19) follows from:

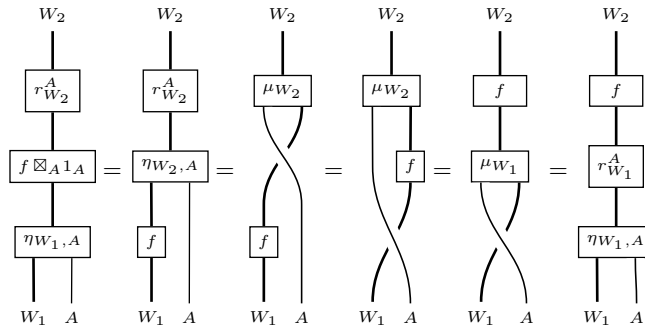

The first equality uses (2.12), the second and last use (2.18), and the third is due to naturality of braiding and evenness of 1_A . The fourth follows because f is a morphism in Rep A . \square

2.4 Categorical intertwining operators and a universal property of tensor products in Rep A

The goal of this subsection is to characterize the tensor product in Rep A by a universal property analogous to the defining property of tensor products of vertex operator (super)algebra modules in terms of intertwining operators. For this, we introduce “categorical Rep A -intertwining operators” that exhibit, in the abstract tensor-categorical setting, the commutativity and associativity properties of vertex-algebraic intertwining operators.

Definition 2.44. Given objects (W_1, μ_{W_1}) , (W_2, μ_{W_2}) , and (W_3, μ_{W_3}) of Rep A , a *categorical Rep A -intertwining operator of type $\binom{W_3}{W_1 W_2}$* is an \mathcal{SC} -morphism $\eta : W_1 \boxtimes W_2 \rightarrow W_3$ such that the three compositions

$$A \boxtimes (W_1 \boxtimes W_2) \xrightarrow{\underline{A}_{A, W_1, W_2}} (A \boxtimes W_1) \boxtimes W_2 \xrightarrow{\mu_{W_1} \boxtimes 1_{W_2}} W_1 \boxtimes W_2 \xrightarrow{\eta} W_3,$$

$$\begin{aligned} A \boxtimes (W_1 \boxtimes W_2) &\xrightarrow{\underline{A}_{A, W_1, W_2}} (A \boxtimes W_1) \boxtimes W_2 \xrightarrow{\underline{R}_{A, W_1} \boxtimes 1_{W_2}} (W_1 \boxtimes A) \boxtimes W_2 \\ &\xrightarrow{\underline{A}_{W_1, A, W_2}^{-1}} W_1 \boxtimes (A \boxtimes W_2) \xrightarrow{1_{W_1} \boxtimes \mu_{W_2}} W_1 \boxtimes W_2 \xrightarrow{\eta} W_3, \end{aligned}$$

and

$$A \boxtimes (W_1 \boxtimes W_2) \xrightarrow{1_A \boxtimes \eta} A \boxtimes W_3 \xrightarrow{\mu_{W_3}} W_3$$

are equal. Below, we shall often drop the qualifier “categorical” when it is clear.

Remark 2.45. The first two compositions in Definition 2.44 are $\eta \circ \mu^{(1)}$ and $\eta \circ \mu^{(2)}$, respectively, so a Rep A -intertwining operator η of type $\binom{W_3}{W_1 W_2}$ is defined by the equalities

$$\eta \circ \mu^{(1)} = \eta \circ \mu^{(2)} = \mu_{W_3} \circ (1_A \boxtimes \eta).$$

In other words, a Rep A -intertwining operator intertwines the action of A on W_3 with the left and right actions of A on $W_1 \boxtimes W_2$.

From the preceding remark and the definition of the action of A on $W_1 \boxtimes_A W_2$, we have:

Proposition 2.46. *If W_1 and W_2 are objects of Rep A , the cokernel morphism $\eta_{W_1, W_2} : W_1 \boxtimes W_2 \rightarrow W_1 \boxtimes_A W_2$ is a Rep A -intertwining operator of type $\binom{W_1 \boxtimes_A W_2}{W_1 W_2}$.*

The pair $(W_1 \boxtimes_A W_2, \eta_{W_1, W_2})$ satisfies the following universal property:

Proposition 2.47. *For any Rep A -intertwining operator η of type $\binom{W_3}{W_1 W_2}$, there is a unique Rep A -morphism*

$$f_\eta : W_1 \boxtimes_A W_2 \rightarrow W_3$$

such that $f_\eta \circ \eta_{W_1, W_2} = \eta$.

Proof. Since $\eta \circ \mu^{(1)} = \eta \circ \mu^{(2)}$, the universal property of the cokernel $(W_1 \boxtimes_A W_2, \eta_{W_1, W_2})$ induces a unique \mathcal{SC} -morphism $f_\eta : W_1 \boxtimes_A W_2 \rightarrow W_3$ such that $f_\eta \circ \eta_{W_1, W_2} = \eta$. To see that f_η is a morphism in Rep A , the definitions imply

$$\begin{aligned} \mu_{W_3} \circ (1_A \boxtimes f_\eta) \circ (1_A \boxtimes \eta_{W_1, W_2}) &= \mu_{W_3} \circ (1_A \boxtimes \eta) = \eta \circ \mu^{(i)} \\ &= f_\eta \circ \eta_{W_1, W_2} \circ \mu^{(i)} = f_\eta \circ \mu_{W_1 \boxtimes_A W_2} \circ (1_A \boxtimes \eta_{W_1, W_2}), \end{aligned}$$

where $i = 1$ or 2 . Since $1_A \boxtimes \eta_{W_1, W_2}$ is surjective, $\mu_{W_3} \circ (1_A \boxtimes f_\eta) = f_\eta \circ \mu_{W_1 \boxtimes_A W_2}$ as required. \square

As another example of Rep A -intertwining operators, we have:

Proposition 2.48. *For any object (W, μ_W) of Rep A , μ_W is a Rep A -intertwining operator of type $\binom{W}{A W}$.*

Proof. The associativity of μ_W implies

$$\mu_W \circ \mu^{(1)} = \mu_W \circ (\mu \boxtimes 1_W) \circ \underline{A}_{A, A, W} = \mu_W \circ (1_A \boxtimes \mu_W),$$

and we already showed at the beginning of the proof of Proposition 2.40 that $\mu_W \circ \mu^{(1)} = \mu_W \circ \mu^{(2)}$. \square

Composing an intertwining operator with a morphism in Rep A yields a new intertwining operator:

Proposition 2.49. *If η is a Rep A -intertwining operator of type $\binom{W_3}{W_1 W_2}$ and $f : W_3 \rightarrow \widetilde{W}_3$ is a morphism in Rep A , then $f \circ \eta$ is a Rep A -intertwining operator of type $\binom{W_3}{W_1 W_2}$.*

Proof. We have

$$(f \circ \eta) \circ \mu^{(1)} = (f \circ \eta) \circ \mu^{(2)} = f \circ \mu_{W_3} \circ (1_A \boxtimes \eta) = \mu_{\widetilde{W}_3} \circ (1_A \boxtimes f) \circ (1_A \boxtimes \eta) = \mu_{\widetilde{W}_3} \circ (1_A \boxtimes (f \circ \eta))$$

since η is a Rep A -intertwining operator and f is a Rep A -morphism. \square

From the bilinearity of composition and tensor products in \mathcal{SC} , categorical Rep A -intertwining operators of type $\binom{W_3}{W_1 W_2}$ form a subspace of $\text{Hom}_{\mathcal{SC}}(W_1 \boxtimes W_2, W_3)$. In fact, we can use the universal property of Rep A -tensor products to show that they form a sub-superspace:

Proposition 2.50. *The parity-homogeneous components of a Rep A -intertwining operator are Rep A -intertwining operators.*

Proof. Suppose η is a Rep A -intertwining operator of type $\binom{W_3}{W_1 W_2}$. Then

$$\eta = f_\eta \circ \eta_{W_1, W_2} = f_\eta^{\bar{0}} \circ \eta_{W_1, W_2} + f_\eta^{\bar{1}} \circ \eta_{W_1, W_2}.$$

Since η_{W_1, W_2} is even, $f_\eta^{\bar{0}} \circ \eta_{W_1, W_2}$ and $f_\eta^{\bar{1}} \circ \eta_{W_1, W_2}$ are the even and odd components, respectively, of η . Because Rep A is a supercategory by Proposition 2.32, the even and odd components of f_η are Rep A -morphisms, so the even and odd components of η are Rep A -intertwining operators by Proposition 2.49. \square

2.5 Associativity of categorical Rep A -intertwining operators and the tensor product in Rep A

In this subsection we prove an associativity theorem for categorical Rep A -intertwining operators that is motivated by the associativity of intertwining operators among modules for a vertex operator algebra proved in [Hu2, HLZ6]. As in the vertex operator algebra setting, associativity of Rep A -intertwining operators yields associativity isomorphisms in Rep A . Using these associativity isomorphisms, we prove that Rep A is a monoidal supercategory.

Theorem 2.51. *Suppose (W_i, μ_{W_i}) for $i = 1, 2, 3, 4$ and (M_i, μ_{M_i}) for $i = 1, 2$ are objects of Rep A .*

1. *If η_1 and η_2 are Rep A -intertwining operators of types $\binom{W_4}{W_1 M_1}$ and $\binom{M_1}{W_2 W_3}$, respectively, then there is a unique Rep A -intertwining operator η of type $\binom{W_4}{W_1 \boxtimes_A W_2 W_3}$ such that*

$$\eta_1 \circ (1_{W_1} \boxtimes \eta_2) = \eta \circ (\eta_{W_1, W_2} \boxtimes 1_{W_3}) \circ \underline{A}_{W_1, W_2, W_3} : W_1 \boxtimes (W_2 \boxtimes W_3) \rightarrow W_4. \quad (2.20)$$

2. *If η^1 and η^2 are Rep A -intertwining operators of types $\binom{W_4}{M_2 W_3}$ and $\binom{M_2}{W_1 W_2}$, respectively, then there is a unique Rep A -intertwining operator η of type $\binom{W_4}{W_1 W_2 \boxtimes_A W_3}$ such that*

$$\eta^1 \circ (\eta^2 \boxtimes 1_{W_3}) = \eta \circ (1_{W_1} \boxtimes \eta_{W_2, W_3}) \circ \underline{A}_{W_1, W_2, W_3}^{-1} : (W_1 \boxtimes W_2) \boxtimes W_3 \rightarrow W_4. \quad (2.21)$$

Proof. We present the proof of the first assertion only, since the second is similar. Since $\cdot \boxtimes W_3$ is right exact, the sequence

$$(A \boxtimes (W_1 \boxtimes W_2)) \boxtimes W_3 \xrightarrow{(\mu^{(1)} - \mu^{(2)}) \boxtimes 1_{W_3}} (W_1 \boxtimes W_2) \boxtimes W_3 \xrightarrow{\eta_{W_1, W_2} \boxtimes 1_{W_3}} (W_1 \boxtimes_A W_2) \boxtimes W_3 \rightarrow 0$$

is exact, that is, $((W_1 \boxtimes_A W_2) \boxtimes W_3, \eta_{W_1, W_2} \boxtimes 1_{W_3})$ is a cokernel of $(\mu^{(1)} - \mu^{(2)}) \boxtimes 1_{W_3}$. Thus the universal property of the cokernel will imply the existence of a unique \mathcal{SC} -morphism

$$\eta : (W_1 \boxtimes_A W_2) \boxtimes W_3 \rightarrow W_4$$

such that

$$\eta_1 \circ (1_{W_1} \boxtimes \eta_2) = \eta \circ (\eta_{W_1, W_2} \boxtimes 1_{W_3}) \circ \underline{A}_{W_1, W_2, W_3}$$

provided that

$$\eta_1 \circ (1_{W_1} \boxtimes \eta_2) \circ \underline{A}_{W_1, W_2, W_3}^{-1} \circ (\mu^{(2)} \boxtimes 1_{W_3}) = \eta \circ (1_{W_1} \boxtimes \eta_2) \circ \underline{A}_{W_1, W_2, W_3}^{-1} \circ (\mu^{(1)} \boxtimes 1_{W_3}).$$

This is proved as indicated in the diagrams:

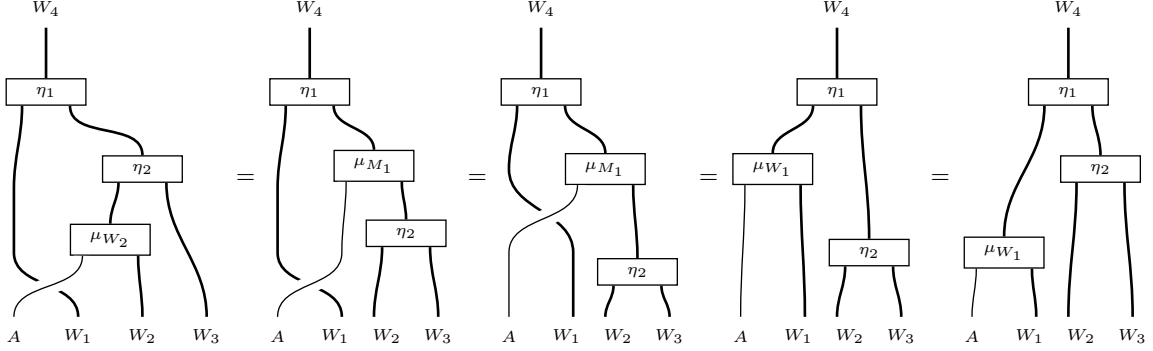

The first step uses $\eta_2 \circ \mu^{(1)} = \mu_{M_1} \circ (1_A \boxtimes \eta_2)$, while the third uses $\eta_1 \circ \mu^{(2)} = \eta_1 \circ \mu^{(1)}$. The second and last equalities use evenness of the braiding and μ_{W_1} , respectively, to exchange their orders with η_2 .

Now we need to show that η is a Rep A -intertwining operator, that is, we need to show

$$\mu_{W_4} \circ (1_A \boxtimes \eta) = \eta \circ \mu^{(1)} = \eta \circ \mu^{(2)}. \quad (2.22)$$

Since η_{W_1, W_2} is surjective and $\cdot \boxtimes W_3$ and $A \boxtimes \cdot$ are right exact, $1_A \boxtimes (\eta_{W_1, W_2} \boxtimes 1_{W_3})$ is a surjective morphism. Thus, to prove (2.22), it is enough to show

$$\begin{aligned} \mu_{W_4} \circ (1_A \boxtimes \eta) \circ (1_A \boxtimes (\eta_{W_1, W_2} \boxtimes 1_{W_3})) &= \eta \circ \mu^{(1)} \circ (1_A \boxtimes (\eta_{W_1, W_2} \boxtimes 1_{W_3})) \\ &= \eta \circ \mu^{(2)} \circ (1_A \boxtimes (\eta_{W_1, W_2} \boxtimes 1_{W_3})). \end{aligned} \quad (2.23)$$

To prove the first equality in (2.23), we proceed as follows, starting with $\eta \circ \mu^{(1)} \circ (1_A \boxtimes (\eta_{W_1, W_2} \boxtimes 1_{W_3}))$:

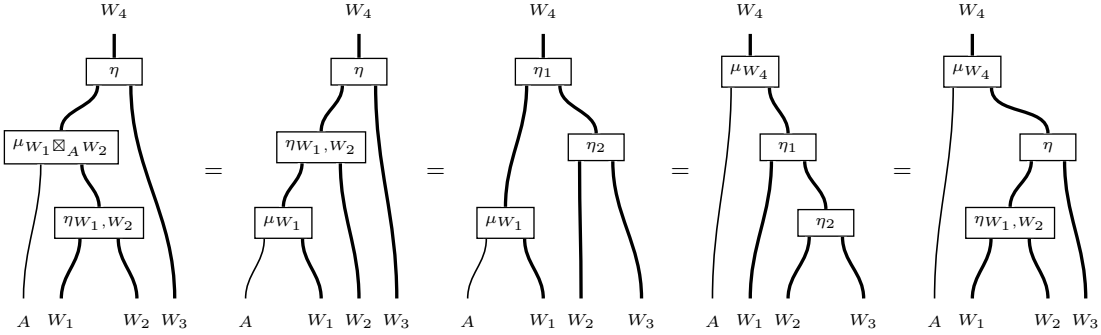

The first step uses the definition of $\mu_{W_1} \boxtimes_A W_2$ from (2.8), while the second and last steps use (2.20). For the third step, we first use evenness of μ_{W_1} to exchange the order of μ_{W_1} and η_1 , and then we use the fact that η_2 is an intertwining operator.

For the other equality in (2.23), we start with $\eta \circ \mu^{(2)} \circ (1_A \boxtimes (\eta_{W_1, W_2} \boxtimes 1_{W_3}))$:

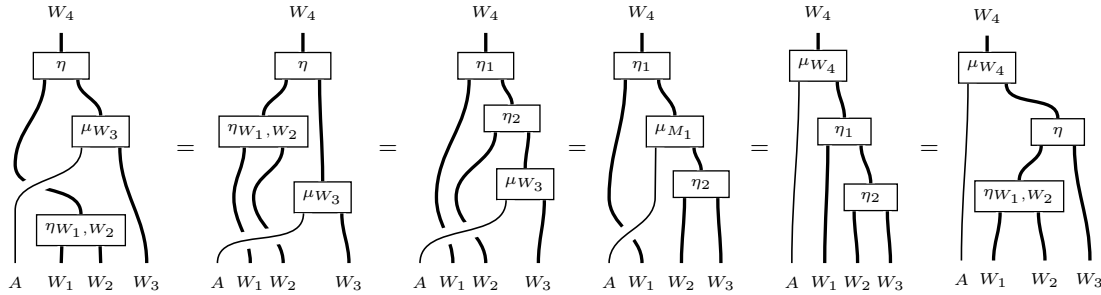

The first equality uses naturality of braiding applied to the even morphism η_{W_1, W_2} , and then the evenness of either η_{W_1, W_2} or μ_{W_3} to exchange their order. The second and the last equalities are due to (2.20).

The third equality uses the hexagon axiom and then $\eta_2 \circ \mu^{(2)} = \mu_{M_1} \circ (1_A \boxtimes \eta_2)$. In the fourth equality, we change the order of the braiding and η_1 using evenness of the braiding and then use $\eta_1 \circ \mu^{(2)} = \mu_{W_4} \circ (1_A \boxtimes \eta_1)$. \square

The associativity of Rep A -intertwining operators yields associativity isomorphisms in Rep A :

Theorem 2.52. *There is a unique natural isomorphism $\mathcal{A}^A : \boxtimes_A \circ (1_{\text{Rep } A} \times \boxtimes_A) \rightarrow \boxtimes_A \circ (\boxtimes_A \times 1_{\text{Rep } A})$ such that for any objects (W_1, μ_{W_1}) , (W_2, μ_{W_2}) , and (W_3, μ_{W_3}) in Rep A , the diagram*

$$\begin{array}{ccc}
W_1 \boxtimes (W_2 \boxtimes W_3) & \xrightarrow{\underline{A}_{W_1, W_2, W_3}} & (W_1 \boxtimes W_2) \boxtimes W_3 \\
\downarrow 1_{W_1} \boxtimes \eta_{W_2, W_3} & & \downarrow \eta_{W_1, W_2} \boxtimes 1_{W_3} \\
W_1 \boxtimes (W_2 \boxtimes_A W_3) & & (W_1 \boxtimes_A W_2) \boxtimes W_3 \\
\downarrow \eta_{W_1, W_2} \boxtimes_A W_3 & & \downarrow \eta_{W_1} \boxtimes_A W_2, W_3 \\
W_1 \boxtimes_A (W_2 \boxtimes_A W_3) & \xrightarrow{\mathcal{A}_{W_1, W_2, W_3}^A} & (W_1 \boxtimes_A W_2) \boxtimes_A W_3
\end{array} \tag{2.24}$$

commutes. Moreover, $\mathcal{A}_{W_1, W_2, W_3}^A$ is even.

Proof. Suppose (W_i, μ_{W_i}) for $i = 1, 2, 3$ are objects of Rep A . By the second assertion of Theorem 2.51, there is a unique Rep A -intertwining operator η of type $\binom{(W_1 \boxtimes_A W_2) \boxtimes_A W_3}{W_1 \boxtimes W_2 \boxtimes_A W_3}$ such that

$$\eta \circ (1_{W_1} \boxtimes \eta_{W_2, W_3}) = \eta_{W_1} \boxtimes_A W_2, W_3 \circ (\eta_{W_1, W_2} \boxtimes 1_{W_3}) \circ \underline{A}_{W_1, W_2, W_3}.$$

Then the universal property of the tensor product $W_1 \boxtimes_A (W_2 \boxtimes_A W_3)$ induces a unique Rep A -morphism

$$\mathcal{A}_{W_1, W_2, W_3}^A : W_1 \boxtimes_A (W_2 \boxtimes_A W_3) \rightarrow (W_1 \boxtimes_A W_2) \boxtimes_A W_3$$

such that $\eta = \mathcal{A}_{W_1, W_2, W_3}^A \circ \eta_{W_1, W_2} \boxtimes_A W_3$. Thus $\mathcal{A}_{W_1, W_2, W_3}^A$ is the unique Rep A -morphism such that (2.24) commutes. Similarly, by the first assertion of Theorem 2.51, there is a unique Rep A -morphism

$$\tilde{\mathcal{A}}_{W_1, W_2, W_3}^A : (W_1 \boxtimes_A W_2) \boxtimes_A W_3 \rightarrow W_1 \boxtimes_A (W_2 \boxtimes_A W_3)$$

such that the diagram

$$\begin{array}{ccc}
(W_1 \boxtimes W_2) \boxtimes W_3 & \xrightarrow{\underline{A}_{W_1, W_2, W_3}^{-1}} & W_1 \boxtimes (W_2 \boxtimes W_3) \\
\downarrow \eta_{W_1, W_2} \boxtimes 1_{W_3} & & \downarrow 1_{W_1} \boxtimes \eta_{W_2, W_3} \\
(W_1 \boxtimes_A W_2) \boxtimes W_3 & & W_1 \boxtimes (W_2 \boxtimes_A W_3) \\
\downarrow \eta_{W_1} \boxtimes_A W_2, W_3 & & \downarrow \eta_{W_1, W_2} \boxtimes_A W_3 \\
(W_1 \boxtimes_A W_2) \boxtimes_A W_3 & \xrightarrow{\tilde{\mathcal{A}}_{W_1, W_2, W_3}^A} & W_1 \boxtimes_A (W_2 \boxtimes_A W_3)
\end{array}$$

commutes.

To show that $\tilde{\mathcal{A}}_{W_1, W_2, W_3}^A$ is inverse to $\mathcal{A}_{W_1, W_2, W_3}^A$, so that $\mathcal{A}_{W_1, W_2, W_3}^A$ is an isomorphism, note that

$$\begin{array}{ccc}
W_1 \boxtimes (W_2 \boxtimes W_3) & \xrightarrow{1_{W_1} \boxtimes (W_2 \boxtimes W_3)} & W_1 \boxtimes (W_2 \boxtimes W_3) \\
\downarrow \eta_{W_1, W_2} \boxtimes_A W_3 \circ (1_{W_1} \boxtimes \eta_{W_2, W_3}) & & \downarrow \eta_{W_1, W_2} \boxtimes_A W_3 \circ (1_{W_1} \boxtimes \eta_{W_2, W_3}) \\
W_1 \boxtimes_A (W_2 \boxtimes_A W_3) & \xrightarrow{\tilde{\mathcal{A}}_{W_1, W_2, W_3}^A \circ \mathcal{A}_{W_1, W_2, W_3}^A} & W_1 \boxtimes_A (W_2 \boxtimes_A W_3)
\end{array}$$

commutes. Since $\eta_{W_1, W_2} \boxtimes_A W_3$ and $1_{W_1} \boxtimes \eta_{W_2, W_3}$ are both cokernels (by definition and since $W_1 \boxtimes \cdot$ is right exact), they are both epimorphisms, and we conclude that $\tilde{\mathcal{A}}_{W_1, W_2, W_3}^A \circ \mathcal{A}_{W_1, W_2, W_3}^A = 1_{W_1 \boxtimes_A (W_2 \boxtimes_A W_3)}$. Similarly, $\mathcal{A}_{W_1, W_2, W_3}^A \circ \tilde{\mathcal{A}}_{W_1, W_2, W_3}^A = 1_{(W_1 \boxtimes_A W_2) \boxtimes_A W_3}$.

The evenness of $\mathcal{A}_{W_1, W_2, W_3}^A$ follows from the evenness of $\underline{A}_{W_1, W_2, W_3}$, $\eta_{W_1, W_2} \boxtimes 1_{W_3}$, and $\eta_{W_1} \boxtimes_A W_2, W_3$, and the surjectivity and evenness of $1_{W_1} \boxtimes \eta_{W_2, W_3}$ and $\eta_{W_1, W_2} \boxtimes_A W_3$.

Now we have to show that the $\text{Rep } A$ -isomorphisms $\mathcal{A}_{\widetilde{W}_1, W_2, W_3}^A$ define a natural transformation, that is, we need to show that if $f_i : W_i \rightarrow \widetilde{W}_i$ for $i = 1, 2, 3$ are $\text{Rep } A$ -morphisms, then the diagram

$$\begin{array}{ccc} W_1 \boxtimes_A (W_2 \boxtimes_A W_3) & \xrightarrow{\mathcal{A}_{\widetilde{W}_1, W_2, W_3}^A} & (W_1 \boxtimes_A W_2) \boxtimes_A W_3 \\ \downarrow f_1 \boxtimes_A (f_2 \boxtimes_A f_3) & & \downarrow (f_1 \boxtimes_A f_2) \boxtimes_A f_3 \\ \widetilde{W}_1 \boxtimes_A (\widetilde{W}_2 \boxtimes_A \widetilde{W}_3) & \xrightarrow{\mathcal{A}_{\widetilde{W}_1, \widetilde{W}_2, \widetilde{W}_3}^A} & (\widetilde{W}_1 \boxtimes_A \widetilde{W}_2) \boxtimes_A \widetilde{W}_3 \end{array}$$

commutes. First, note that the diagrams

$$\begin{array}{ccccc} W_1 \boxtimes (W_2 \boxtimes W_3) & \xrightarrow{\mathcal{A}_{W_1, W_2, W_3}^A} & (W_1 \boxtimes W_2) \boxtimes W_3 & \xrightarrow{(f_1 \boxtimes f_2) \boxtimes f_3} & (\widetilde{W}_1 \boxtimes \widetilde{W}_2) \boxtimes \widetilde{W}_3 \\ \downarrow 1_{W_1} \boxtimes \eta_{W_2, W_3} & & \downarrow \eta_{W_1, W_2} \boxtimes 1_{W_3} & & \downarrow \eta_{\widetilde{W}_1, \widetilde{W}_2} \boxtimes 1_{\widetilde{W}_3} \\ W_1 \boxtimes (W_2 \boxtimes_A W_3) & & (W_1 \boxtimes_A W_2) \boxtimes W_3 & \xrightarrow{(f_1 \boxtimes_A f_2) \boxtimes f_3} & (\widetilde{W}_1 \boxtimes_A \widetilde{W}_2) \boxtimes \widetilde{W}_3 \\ \downarrow \eta_{W_1, W_2} \boxtimes_A W_3 & & \downarrow \eta_{W_1} \boxtimes_A W_2, W_3 & & \downarrow \eta_{\widetilde{W}_1} \boxtimes_A \widetilde{W}_2, \widetilde{W}_3 \\ W_1 \boxtimes_A (W_2 \boxtimes_A W_3) & \xrightarrow{\mathcal{A}_{\widetilde{W}_1, W_2, W_3}^A} & (W_1 \boxtimes_A W_2) \boxtimes_A W_3 & \xrightarrow{(f_1 \boxtimes_A f_2) \boxtimes_A f_3} & (\widetilde{W}_1 \boxtimes_A \widetilde{W}_2) \boxtimes_A \widetilde{W}_3 \end{array}$$

and

$$\begin{array}{ccccc} W_1 \boxtimes (W_2 \boxtimes W_3) & \xrightarrow{f_1 \boxtimes (f_2 \boxtimes f_3)} & \widetilde{W}_1 \boxtimes (\widetilde{W}_2 \boxtimes \widetilde{W}_3) & \xrightarrow{\mathcal{A}_{\widetilde{W}_1, \widetilde{W}_2, \widetilde{W}_3}^A} & (\widetilde{W}_1 \boxtimes \widetilde{W}_2) \boxtimes \widetilde{W}_3 \\ \downarrow 1_{W_1} \boxtimes \eta_{W_2, W_3} & & \downarrow 1_{\widetilde{W}_1} \boxtimes \eta_{\widetilde{W}_2, \widetilde{W}_3} & & \downarrow \eta_{\widetilde{W}_1, \widetilde{W}_2} \boxtimes 1_{\widetilde{W}_3} \\ W_1 \boxtimes (W_2 \boxtimes_A W_3) & \xrightarrow{f_1 \boxtimes (f_2 \boxtimes_A f_3)} & \widetilde{W}_1 \boxtimes (\widetilde{W}_2 \boxtimes_A \widetilde{W}_3) & & (\widetilde{W}_1 \boxtimes_A \widetilde{W}_2) \boxtimes \widetilde{W}_3 \\ \downarrow \eta_{W_1, W_2} \boxtimes_A W_3 & & \downarrow \eta_{\widetilde{W}_1, \widetilde{W}_2} \boxtimes_A \widetilde{W}_3 & & \downarrow \eta_{\widetilde{W}_1} \boxtimes_A \widetilde{W}_2, \widetilde{W}_3 \\ W_1 \boxtimes_A (W_2 \boxtimes_A W_3) & \xrightarrow{f_1 \boxtimes_A (f_2 \boxtimes_A f_3)} & \widetilde{W}_1 \boxtimes_A (\widetilde{W}_2 \boxtimes_A \widetilde{W}_3) & \xrightarrow{\mathcal{A}_{\widetilde{W}_1, \widetilde{W}_2, \widetilde{W}_3}^A} & (\widetilde{W}_1 \boxtimes_A \widetilde{W}_2) \boxtimes_A \widetilde{W}_3 \end{array}$$

commute by the definition of \mathcal{A}^A , the definition of tensor products of morphisms in $\text{Rep } A$, and the evenness of η_{W_1, W_2} and $\eta_{\widetilde{W}_2, \widetilde{W}_3}$. Since the associativity isomorphisms in \mathcal{SC} define a natural transformation, we therefore have

$$\begin{aligned} & ((f_1 \boxtimes_A f_2) \boxtimes_A f_3) \circ \mathcal{A}_{\widetilde{W}_1, W_2, W_3}^A \circ \eta_{W_1, W_2} \boxtimes_A W_3 \circ (1_{W_1} \boxtimes \eta_{W_2, W_3}) \\ &= \mathcal{A}_{\widetilde{W}_1, \widetilde{W}_2, \widetilde{W}_3}^A \circ (f_1 \boxtimes_A (f_2 \boxtimes_A f_3)) \circ \eta_{W_1, W_2} \boxtimes_A W_3 \circ (1_{W_1} \boxtimes \eta_{W_2, W_3}). \end{aligned}$$

Since $\eta_{W_1, W_2} \boxtimes_A W_3$ and $1_{W_1} \boxtimes \eta_{W_2, W_3}$ are both cokernels (by definition and since $W_1 \boxtimes \cdot$ is right exact), they are both epimorphisms, and so we conclude

$$((f_1 \boxtimes_A f_2) \boxtimes_A f_3) \circ \mathcal{A}_{\widetilde{W}_1, W_2, W_3}^A = \mathcal{A}_{\widetilde{W}_1, \widetilde{W}_2, \widetilde{W}_3}^A \circ (f_1 \boxtimes_A (f_2 \boxtimes_A f_3)),$$

as desired. \square

We have now shown that $\text{Rep } A$ is an \mathbb{F} -linear additive supercategory, and we have constructed bilinear tensor products, natural even unit isomorphisms, and now even natural associativity isomorphisms in $\text{Rep } A$. To show that $\text{Rep } A$ is a monoidal supercategory, we still need to check the pentagon and triangle axioms. We now prove these properties and conclude the following theorem:

Theorem 2.53. *The category $\text{Rep } A$ with tensor product bifunctor \boxtimes_A , unit object (A, μ) , left unit isomorphisms l^A , right unit isomorphisms r^A , and associativity isomorphisms \mathcal{A}^A , is an \mathbb{F} -linear additive monoidal supercategory.*

Proof. To prove the pentagon axiom, we need to show that for any objects W_1, W_2, W_3 , and W_4 of $\text{Rep } A$, the compositions

$$W_1 \boxtimes_A (W_2 \boxtimes_A (W_3 \boxtimes_A W_4)) \xrightarrow{1_{W_1} \boxtimes_A \mathcal{A}_{\widetilde{W}_2, W_3, W_4}^A} W_1 \boxtimes_A ((W_2 \boxtimes_A W_3) \boxtimes_A W_4)$$

$$\xrightarrow{\mathcal{A}_{W_1, W_2 \boxtimes_A W_3, W_4}^A} (W_1 \boxtimes_A (W_2 \boxtimes_A W_3)) \boxtimes_A W_4 \xrightarrow{\mathcal{A}_{W_1, W_2, W_3 \boxtimes_A W_4}^A} ((W_1 \boxtimes_A W_2) \boxtimes_A W_3) \boxtimes_A W_4 \quad (2.25)$$

and

$$\begin{aligned} W_1 \boxtimes_A (W_2 \boxtimes_A (W_3 \boxtimes_A W_4)) &\xrightarrow{\mathcal{A}_{W_1, W_2, W_3 \boxtimes_A W_4}^A} (W_1 \boxtimes_A W_2) \boxtimes_A (W_3 \boxtimes_A W_4) \\ &\xrightarrow{\mathcal{A}_{W_1 \boxtimes_A W_2, W_3, W_4}^A} ((W_1 \boxtimes_A W_2) \boxtimes_A W_3) \boxtimes_A W_4 \end{aligned} \quad (2.26)$$

are equal. Using the naturality of the associativity isomorphisms in \mathcal{SC} and the definition of the associativity isomorphisms in $\text{Rep } A$, we can prove that the diagram

$$\begin{array}{ccc} W_1 \boxtimes (W_2 \boxtimes (W_3 \boxtimes W_4)) & \longrightarrow & ((W_1 \boxtimes W_2) \boxtimes W_3) \boxtimes W_4 \\ \downarrow & & \downarrow \\ W_1 \boxtimes_A (W_2 \boxtimes_A (W_3 \boxtimes_A W_4)) & \longrightarrow & ((W_1 \boxtimes_A W_2) \boxtimes_A W_3) \boxtimes_A W_4 \end{array}$$

commutes, where the lower horizontal arrow is either (2.25) or (2.26), the top horizontal arrow is the corresponding composition of associativity isomorphisms in \mathcal{SC} , and the left and right vertical arrows are

$$\eta_{W_1, W_2 \boxtimes_A (W_3 \boxtimes_A W_4)} \circ (1_{W_1} \boxtimes \eta_{W_2, W_3 \boxtimes_A W_4}) \circ (1_{W_1} \boxtimes (1_{W_2} \boxtimes \eta_{W_3, W_4})) \quad (2.27)$$

and

$$\eta_{(W_1 \boxtimes_A W_2) \boxtimes_A W_3, W_4} \circ (\eta_{W_1 \boxtimes_A W_2, W_3} \boxtimes 1_{W_4}) \circ ((\eta_{W_1, W_2} \boxtimes 1_{W_3}) \boxtimes 1_{W_4}),$$

respectively. Since the pentagon axiom holds in \mathcal{SC} , it follows that

$$(\mathcal{A}_{W_1, W_2, W_3 \boxtimes_A W_4}^A \circ \mathcal{A}_{W_1, W_2 \boxtimes_A W_3, W_4}^A \circ (1_{W_1} \boxtimes_A \mathcal{A}_{W_2, W_3, W_4}^A)) \circ \eta = \mathcal{A}_{W_1 \boxtimes_A W_2, W_3, W_4}^A \circ \mathcal{A}_{W_1, W_2, W_3 \boxtimes_A W_4}^A \circ \eta,$$

where η is the composition (2.27). Since η is a composition of cokernel morphisms (since $W_1 \boxtimes \cdot$ and $W_2 \boxtimes \cdot$ are right exact), η is an epimorphism, and we conclude that (2.25) and (2.26) are the same.

To prove the triangle axiom, we need to show that the composition

$$W_1 \boxtimes_A W_2 \xrightarrow{1_{W_1} \boxtimes_A (l_{W_2}^A)^{-1}} W_1 \boxtimes_A (A \boxtimes_A W_2) \xrightarrow{\mathcal{A}_{W_1, A, W_2}^A} (W_1 \boxtimes_A A) \boxtimes_A W_2 \xrightarrow{r_{W_1}^A \boxtimes_A 1_{W_2}} W_1 \boxtimes_A W_2$$

equals $1_{W_1} \boxtimes_A W_2$. By the definitions of the unit and associativity isomorphisms in $\text{Rep } A$, the definition of tensor products of morphisms in $\text{Rep } A$, and the evenness of all morphisms involved, the diagram

$$\begin{array}{ccccc} W_1 \boxtimes W_2 & \xrightarrow{\eta_{W_1, W_2}} & W_1 \boxtimes_A W_2 & & \\ \downarrow 1_{W_1} \boxtimes ((l_A \boxtimes 1_{W_2}) \circ l_{W_2}^{-1}) & \searrow 1_{W_1} \boxtimes (l_{W_2}^A)^{-1} & \downarrow 1_{W_1} \boxtimes_A (l_{W_2}^A)^{-1} & & \\ W_1 \boxtimes (A \boxtimes W_2) & \xrightarrow{1_{W_1} \boxtimes \eta_{A, W_2}} & W_1 \boxtimes (A \boxtimes_A W_2) & \xrightarrow{\eta_{W_1, A \boxtimes_A W_2}} & W_1 \boxtimes_A (A \boxtimes_A W_2) \\ \downarrow \mathcal{A}_{W_1, A, W_2} & & \downarrow \mathcal{A}_{W_1, A, W_2}^A & & \downarrow \mathcal{A}_{W_1, A, W_2}^A \\ (W_1 \boxtimes A) \boxtimes W_2 & \xrightarrow{\eta_{W_1, A \boxtimes W_2}} & (W_1 \boxtimes_A A) \boxtimes W_2 & \xrightarrow{\eta_{W_1 \boxtimes_A A, W_2}} & (W_1 \boxtimes_A A) \boxtimes_A W_2 \\ \downarrow \mathcal{R}_{A, W_1}^{-1} \boxtimes 1_{W_2} & & \downarrow r_{W_1}^A \boxtimes 1_{W_2} & & \downarrow r_{W_1}^A \boxtimes_A 1_{W_2} \\ (A \boxtimes W_1) \boxtimes W_2 & \xrightarrow{\mu_{W_1} \boxtimes 1_{W_2}} & W_1 \boxtimes W_2 & \xrightarrow{\eta_{W_1, W_2}} & W_1 \boxtimes_A W_2 \end{array}$$

commutes. Since η_{W_1, W_2} is an epimorphism, it is enough to show that the top and right composition equals η_{W_1, W_2} . By commutativity of the diagram, it is then enough to show that the left and bottom

composition equals η_{W_1, W_2} . For this, we use:

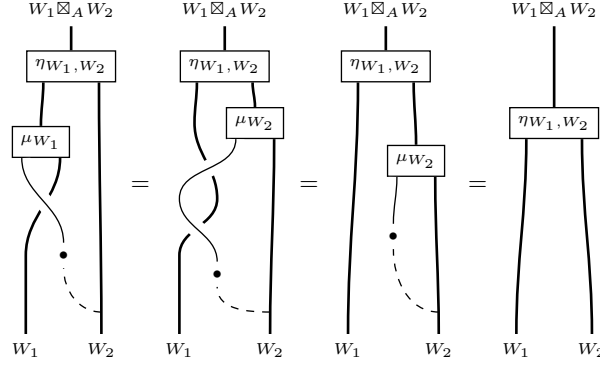

The first step uses $\eta_{W_1, W_2} \circ \mu^{(1)} = \eta_{W_1, W_2} \circ \mu^{(2)}$ and the third is the unit property of μ_{W_2} . \square

2.6 The braided tensor category $\text{Rep}^0 A$

We have shown that $\text{Rep} A$ is a monoidal category, but it is not braided. However, it was shown in [Pa] that $\text{Rep} A$ has a braided tensor subcategory $\text{Rep}^0 A$ consisting of ‘‘local modules.’’ In this subsection, we define $\text{Rep}^0 A$ and construct its braiding isomorphisms.

For any objects W_1, W_2 of \mathcal{SC} , we define the *monodromy isomorphism* to be

$$\mathcal{M}_{W_1, W_2} = \underline{\mathcal{R}}_{W_2, W_1} \circ \underline{\mathcal{R}}_{W_1, W_2} : W_1 \boxtimes W_2 \rightarrow W_1 \boxtimes W_2.$$

These isomorphisms thus define a natural isomorphism \mathcal{M} from \boxtimes to itself.

Definition 2.54. The category $\text{Rep}^0 A$ is the full subcategory of $\text{Rep} A$ consisting of objects (W, μ_W) which satisfy

$$\mu_W \circ \mathcal{M}_{A, W} = \mu_W : A \boxtimes W \rightarrow W.$$

Theorem 2.55. *The category $\text{Rep}^0 A$ is an \mathbb{F} -linear additive braided monoidal supercategory with tensor product \boxtimes_A , unit object (A, μ) , left unit isomorphisms l^A , right unit isomorphisms r^A , associativity isomorphisms A^A , and (even) braiding isomorphisms \mathcal{R}^A characterized by the commutativity of*

$$\begin{array}{ccc} W_1 \boxtimes W_2 & \xrightarrow{\underline{\mathcal{R}}_{W_1, W_2}} & W_2 \boxtimes W_1 \\ \eta_{W_1, W_2} \downarrow & & \downarrow \eta_{W_2, W_1} \\ W_1 \boxtimes_A W_2 & \xrightarrow{\mathcal{R}_{W_1, W_2}^A} & W_2 \boxtimes_A W_1 \end{array} \quad (2.28)$$

for objects W_1 and W_2 of $\text{Rep}^0 A$.

Proof. To show that $\text{Rep}^0 A$ is \mathbb{F} -linear additive, note first that the zero object of $\text{Rep} A$ is in $\text{Rep}^0 A$ since $\mu_0 \circ \mathcal{M}_{A, 0}$ and μ_0 are both the unique morphism $A \boxtimes 0 \rightarrow 0$. Second, since $\text{Rep}^0 A$ is a full subcategory of the \mathbb{F} -linear supercategory $\text{Rep} A$, morphism sets have \mathbb{F} -superspace structure for which composition (and tensor product) of morphisms is bilinear. Third, if $\{W_i\}$ is a finite set of objects in $\text{Rep}^0 A$, then the $\text{Rep} A$ -biproduct $(\bigoplus W_i, \{p_i\}, \{q_i\})$ is also in $\text{Rep}^0 A$ because

$$\begin{aligned} \mu_{\bigoplus W_i} \circ \mathcal{M}_{A, \bigoplus W_i} &= \sum q_i \circ \mu_{W_i} \circ (1_A \boxtimes p_i) \circ \mathcal{M}_{A, \bigoplus W_i} = \sum q_i \circ \mu_{W_i} \circ \mathcal{M}_{A, W_i} \circ (1_A \boxtimes p_i) \\ &= \sum q_i \circ \mu_{W_i} \circ (1_A \boxtimes p_i) = \mu_{\bigoplus W_i}. \end{aligned}$$

To show that $\text{Rep}^0 A$ is braided monoidal, note first that (A, μ) is an object of $\text{Rep}^0 A$ by the commutativity of μ . Then we need to show that \boxtimes_A is closed on $\text{Rep}^0 A$ and that (2.28) defines an even $\text{Rep}^0 A$ -isomorphism which satisfies the hexagon axiom and is natural in the sense of (2.4).

First we show that if (W_1, μ_{W_1}) and (W_2, μ_{W_2}) are objects of $\text{Rep}^0 A$, then so is $(W_1 \boxtimes_A W_2, \mu_{W_1 \boxtimes_A W_2})$. Consider the commutative diagram

$$\begin{array}{ccccc} A \boxtimes (W_1 \boxtimes W_2) & \xrightarrow{\mathcal{M}_{A, W_1 \boxtimes W_2}} & A \boxtimes (W_1 \boxtimes W_2) & \xrightarrow{\mu^{(1)} \text{ or } \mu^{(2)}} & W_1 \boxtimes W_2 \\ \downarrow 1_A \boxtimes \eta_{W_1, W_2} & & \downarrow 1_A \boxtimes \eta_{W_1, W_2} & & \downarrow \eta_{W_1, W_2} \\ A \boxtimes (W_1 \boxtimes_A W_2) & \xrightarrow{\mathcal{M}_{A, W_1 \boxtimes_A W_2}} & A \boxtimes (W_1 \boxtimes_A W_2) & \xrightarrow{\mu_{W_1 \boxtimes_A W_2}} & W_1 \boxtimes_A W_2 \end{array}$$

Since $1_A \boxtimes \eta_{W_1, W_2}$ is an epimorphism and since $\mu_{W_1 \boxtimes_A W_2} \circ (1_A \boxtimes \eta_{W_1, W_2}) = \eta_{W_1, W_2} \circ \mu^{(2)}$, to show that

$$\mu_{W_1 \boxtimes_A W_2} \circ \mathcal{M}_{A, W_1 \boxtimes_A W_2} = \mu_{W_1 \boxtimes_A W_2},$$

it is enough to show that

$$\eta_{W_1, W_2} \circ \mu^{(1)} \circ \mathcal{M}_{A, W_1 \boxtimes W_2} = \eta_{W_1, W_2} \circ \mu^{(2)}.$$

The proof is guided by the diagrams:

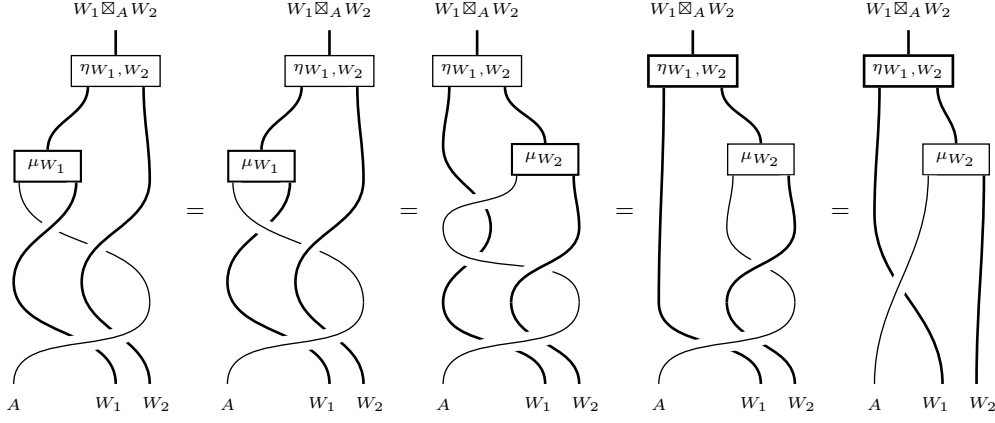

The first and last equalities use the hexagon axiom together with the assumption that W_1 and W_2 are objects of $\text{Rep}^0 A$, while the second uses $\eta_{W_1, W_2} \circ \mu^{(1)} = \eta_{W_1, W_2} \circ \mu^{(2)}$. This proves that $(W_1 \boxtimes_A W_2, \mu_{W_1 \boxtimes_A W_2})$ is an object of $\text{Rep}^0 A$, so \boxtimes_A is a bifunctor on $\text{Rep}^0 A$.

To get braiding isomorphisms in $\text{Rep}^0 A$, the universal property of the cokernel $(W_1 \boxtimes_A W_2, \eta_{W_1, W_2})$ induces a unique \mathcal{SC} -morphism $\mathcal{R}_{W_1, W_2}^A : W_1 \boxtimes_A W_2 \rightarrow W_2 \boxtimes_A W_1$ such that (2.28) commutes, provided

$$\eta_{W_2, W_1} \circ \underline{\mathcal{R}}_{W_1, W_2} \circ \mu^{(2)} = \eta_{W_2, W_1} \circ \underline{\mathcal{R}}_{W_1, W_2} \circ \mu^{(1)}.$$

We use the following diagrams to establish this:

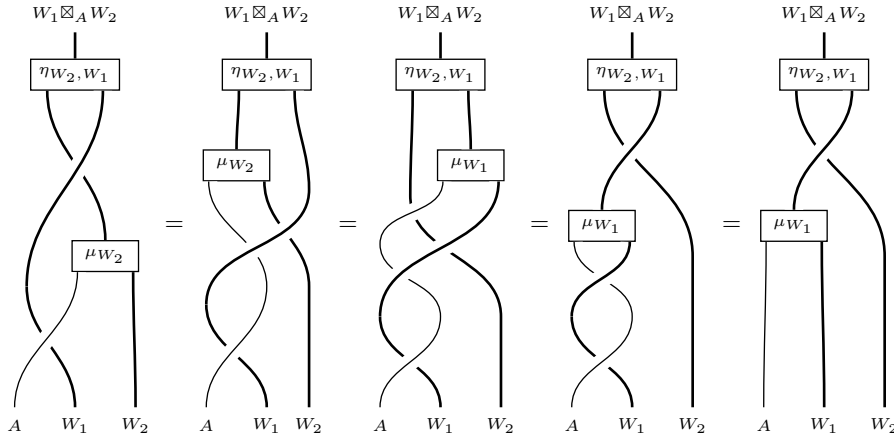

These steps use naturality of braiding applied to the even morphisms μ_{W_2} and μ_{W_1} , the hexagon axiom twice, the relation $\eta_{W_2, W_1} \circ \mu^{(1)} = \eta_{W_2, W_1} \circ \mu^{(2)}$, and finally the assumption that W_1 is an object of $\text{Rep}^0 A$. This shows \mathcal{R}_{W_1, W_2}^A exists, and \mathcal{R}_{W_1, W_2}^A is even because $\underline{\mathcal{R}}_{W_1, W_2}$, η_{W_2, W_1} are even and because η_{W_1, W_2} is even and surjective.

To show that \mathcal{R}_{W_1, W_2}^A is an isomorphism in \mathcal{SC} , we will use the universal property of the cokernel $(W_2 \boxtimes_A W_1, \eta_{W_2, W_1})$ to show that there is a unique \mathcal{SC} -morphism $(\mathcal{R}_{W_1, W_2}^A)^{-1} : W_2 \boxtimes_A W_1 \rightarrow W_1 \boxtimes_A W_2$ such that

$$\begin{array}{ccc} W_2 \boxtimes W_1 & \xrightarrow{\mathcal{R}_{W_1, W_2}^{-1}} & W_1 \boxtimes W_2 \\ \eta_{W_2, W_1} \downarrow & & \downarrow \eta_{W_1, W_2} \\ W_2 \boxtimes_A W_1 & \xrightarrow{(\mathcal{R}_{W_1, W_2}^A)^{-1}} & W_1 \boxtimes_A W_2 \end{array} \quad (2.29)$$

commutes. The commutativity of (2.28) and (2.29) together with the surjectivity of η_{W_1, W_2} and η_{W_2, W_1} will then imply that $\mathcal{R}_{\widetilde{W}_1, W_2}^A$ and $(\mathcal{R}_{\widetilde{W}_1, W_2}^A)^{-1}$ are indeed inverses of each other. To show that $(\mathcal{R}_{\widetilde{W}_1, W_2}^A)^{-1}$ exists, it suffices to show

$$\eta_{W_1, W_2} \circ \underline{\mathcal{R}}_{W_1, W_2}^{-1} \circ \mu^{(2)} = \eta_{W_1, W_2} \circ \underline{\mathcal{R}}_{W_1, W_2}^{-1} \circ \mu^{(1)}. \quad (2.30)$$

We use the following sequence of diagrams to prove this, first using (2.7) to rewrite $\mu^{(2)}$:

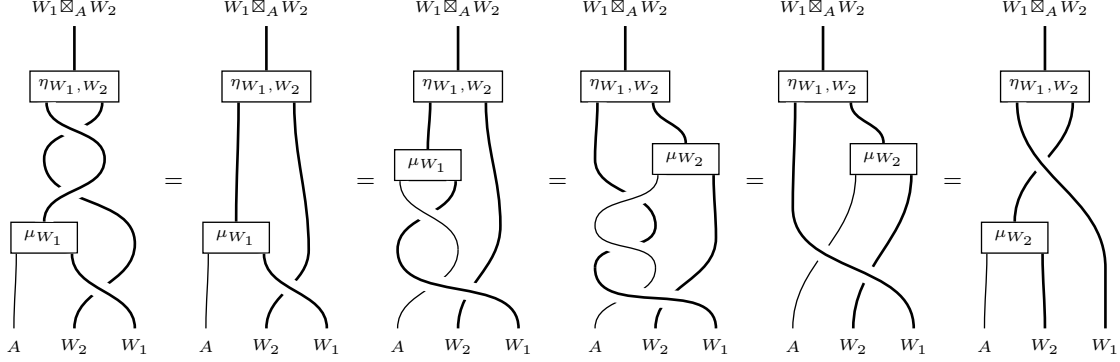

The second equality uses the assumption that W_1 is in $\text{Rep}^0 A$ along with the hexagon axiom, the third uses $\eta_{W_1, W_2} \circ \mu^{(1)} = \eta_{W_1, W_2} \circ \mu^{(2)}$, and finally we apply naturality of braiding to the even morphism μ_{W_2} .

Now to show that $\mathcal{R}_{\widetilde{W}_1, W_2}^A$ is an isomorphism in $\text{Rep} A$, and thus also in $\text{Rep}^0 A$, it remains to show that $\mathcal{R}_{\widetilde{W}_1, W_2}^A$ is a morphism in $\text{Rep} A$, that is,

$$\mu_{W_2 \otimes_A W_1} \circ (1_A \boxtimes \mathcal{R}_{\widetilde{W}_1, W_2}^A) = \mathcal{R}_{\widetilde{W}_1, W_2}^A \circ \mu_{W_1 \otimes_A W_2}. \quad (2.31)$$

This is a consequence of the surjectivity of $1_A \boxtimes \eta_{W_1, W_2}$ and the following diagrams:

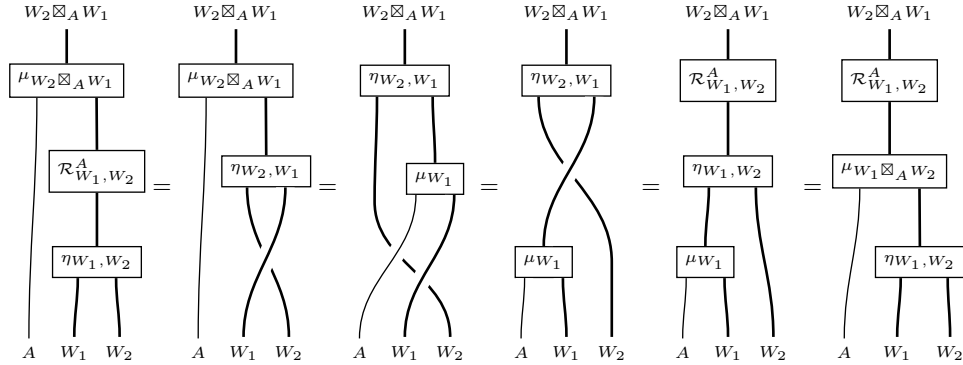

The first and fourth equalities use the definition of $\mathcal{R}_{\widetilde{W}_1, W_2}^A$ from (2.28). The second and last equalities use (2.8) with $i = 2$ and $i = 1$, respectively, and the third uses naturality of braiding applied to the even morphism μ_{W_1} .

Now we show that the braiding isomorphism \mathcal{R}^A is natural, that is,

$$\mathcal{R}_{\widetilde{W}_1, \widetilde{W}_2}^A \circ (f_1 \boxtimes_A f_2) = (-1)^{|f_1||f_2|} (f_2 \boxtimes_A f_1) \circ \mathcal{R}_{\widetilde{W}_1, W_2}^A$$

for parity-homogeneous morphisms $f_1 : W_1 \rightarrow \widetilde{W}_1$ and $f_2 : W_2 \rightarrow \widetilde{W}_2$ in $\text{Rep}^0 A$. This follows from the commutative diagrams

$$\begin{array}{ccccc} W_1 \boxtimes W_2 & \xrightarrow{f_1 \boxtimes f_2} & \widetilde{W}_1 \boxtimes \widetilde{W}_2 & \xrightarrow{\mathcal{R}_{\widetilde{W}_1, \widetilde{W}_2}^A} & \widetilde{W}_2 \boxtimes \widetilde{W}_1 \\ \eta_{W_1, W_2} \downarrow & & \eta_{\widetilde{W}_1, \widetilde{W}_2} \downarrow & & \eta_{\widetilde{W}_2, \widetilde{W}_1} \downarrow \\ W_1 \boxtimes_A W_2 & \xrightarrow{f_1 \boxtimes_A f_2} & \widetilde{W}_1 \boxtimes_A \widetilde{W}_2 & \xrightarrow{\mathcal{R}_{\widetilde{W}_1, \widetilde{W}_2}^A} & \widetilde{W}_2 \boxtimes_A \widetilde{W}_1 \end{array}$$

and

$$\begin{array}{ccccc}
W_1 \boxtimes W_2 & \xrightarrow{\mathcal{R}_{W_1, W_2}} & W_2 \boxtimes W_1 & \xrightarrow{f_2 \boxtimes f_1} & \widetilde{W}_2 \boxtimes \widetilde{W}_1 \\
\eta_{W_1, W_2} \downarrow & & \eta_{W_2, W_1} \downarrow & & \eta_{\widetilde{W}_2, \widetilde{W}_1} \downarrow \\
W_1 \boxtimes_A W_2 & \xrightarrow{\mathcal{R}_{\widetilde{W}_1, W_2}^A} & W_2 \boxtimes_A W_1 & \xrightarrow{f_2 \boxtimes_A f_1} & \widetilde{W}_2 \boxtimes_A \widetilde{W}_1
\end{array}$$

together with the surjectivity of η_{W_1, W_2} and the naturality (2.4) of the braiding isomorphisms in SC .

Finally, we prove the hexagon axiom for \mathcal{R}^A , that is, we show that

$$\begin{array}{ccccc}
W_1 \boxtimes_A (W_2 \boxtimes_A W_3) & \xrightarrow{1_{W_1} \boxtimes_A \mathcal{R}_{W_2, W_3}^A} & W_1 \boxtimes_A (W_3 \boxtimes_A W_2) & \xrightarrow{\mathcal{A}_{W_1, W_3, W_2}^A} & (W_1 \boxtimes_A W_3) \boxtimes_A W_2 \\
\mathcal{A}_{W_1, W_2, W_3}^A \downarrow & & \mathcal{R}_{W_1 \boxtimes_A W_2, W_3}^A \downarrow & & \mathcal{R}_{W_1, W_3 \boxtimes_A W_2}^A \downarrow \\
(W_1 \boxtimes_A W_2) \boxtimes_A W_3 & \xrightarrow{\mathcal{R}_{W_1 \boxtimes_A W_2, W_3}^A} & W_3 \boxtimes_A (W_1 \boxtimes_A W_2) & \xrightarrow{\mathcal{A}_{W_3, W_1, W_2}^A} & (W_3 \boxtimes_A W_1) \boxtimes_A W_2
\end{array} \quad (2.32)$$

commutes, as does the same diagram with \mathcal{R}^A replaced by $(\mathcal{R}^A)^{-1}$. The commutativity of (2.32) follows from the commutative diagrams

$$\begin{array}{ccccc}
W_1 \boxtimes (W_2 \boxtimes W_3) & \xrightarrow{1_{W_1} \boxtimes \eta_{W_2, W_3}} & W_1 \boxtimes (W_2 \boxtimes_A W_3) & \xrightarrow{\eta_{W_1, W_2} \boxtimes_A W_3} & W_1 \boxtimes_A (W_2 \boxtimes_A W_3) \\
1_{W_1} \boxtimes \mathcal{R}_{W_2, W_3} \downarrow & & \downarrow 1_{W_1} \boxtimes \mathcal{R}_{W_2, W_3}^A & & \downarrow 1_{W_1} \boxtimes_A \mathcal{R}_{W_2, W_3}^A \\
W_1 \boxtimes (W_3 \boxtimes W_2) & \xrightarrow{1_{W_1} \boxtimes \eta_{W_3, W_2}} & W_1 \boxtimes (W_3 \boxtimes_A W_2) & \xrightarrow{\eta_{W_1, W_3} \boxtimes_A W_2} & W_1 \boxtimes_A (W_3 \boxtimes_A W_2) \\
\mathcal{A}_{W_1, W_3, W_2} \downarrow & & \downarrow \mathcal{A}_{W_1, W_3, W_2} & & \downarrow \mathcal{A}_{W_1, W_3, W_2}^A \\
(W_1 \boxtimes W_3) \boxtimes W_2 & \xrightarrow{\eta_{W_1, W_3} \boxtimes 1_{W_2}} & (W_1 \boxtimes_A W_3) \boxtimes W_2 & \xrightarrow{\eta_{W_1} \boxtimes_A W_3, W_2} & (W_1 \boxtimes_A W_3) \boxtimes_A W_2 \\
\mathcal{R}_{W_1, W_3} \boxtimes 1_{W_2} \downarrow & & \downarrow \mathcal{R}_{W_1, W_3}^A \boxtimes 1_{W_2} & & \downarrow \mathcal{R}_{W_1, W_3}^A \boxtimes_A 1_{W_2} \\
(W_3 \boxtimes W_1) \boxtimes W_2 & \xrightarrow{\eta_{W_3, W_1} \boxtimes 1_{W_2}} & (W_3 \boxtimes_A W_1) \boxtimes W_2 & \xrightarrow{\eta_{W_3} \boxtimes_A W_1, W_2} & (W_3 \boxtimes_A W_1) \boxtimes_A W_2
\end{array}$$

and

$$\begin{array}{ccccc}
W_1 \boxtimes (W_2 \boxtimes W_3) & \xrightarrow{1_{W_1} \boxtimes \eta_{W_2, W_3}} & W_1 \boxtimes (W_2 \boxtimes_A W_3) & \xrightarrow{\eta_{W_1, W_2} \boxtimes_A W_3} & W_1 \boxtimes_A (W_2 \boxtimes_A W_3) \\
\mathcal{A}_{W_1, W_2, W_3} \downarrow & & \downarrow \mathcal{A}_{W_1, W_2, W_3} & & \downarrow \mathcal{A}_{W_1, W_2, W_3}^A \\
(W_1 \boxtimes W_2) \boxtimes W_3 & \xrightarrow{\eta_{W_1, W_2} \boxtimes 1_{W_3}} & (W_1 \boxtimes_A W_2) \boxtimes W_3 & \xrightarrow{\eta_{W_1} \boxtimes_A W_2, W_3} & (W_1 \boxtimes_A W_2) \boxtimes_A W_3 \\
\mathcal{R}_{W_1} \boxtimes W_2, W_3 \downarrow & & \downarrow \mathcal{R}_{W_1} \boxtimes_A W_2, W_3 & & \downarrow \mathcal{R}_{W_1}^A \boxtimes_A W_2, W_3 \\
W_3 \boxtimes (W_1 \boxtimes W_2) & \xrightarrow{1_{W_3} \boxtimes \eta_{W_1, W_2}} & W_3 \boxtimes (W_1 \boxtimes_A W_2) & \xrightarrow{\eta_{W_3, W_1} \boxtimes_A W_2} & W_3 \boxtimes_A (W_1 \boxtimes_A W_2) \\
\mathcal{A}_{W_3, W_1, W_2} \downarrow & & \downarrow \mathcal{A}_{W_3, W_1, W_2} & & \downarrow \mathcal{A}_{W_3, W_1, W_2}^A \\
(W_3 \boxtimes W_1) \boxtimes W_2 & \xrightarrow{\eta_{W_3, W_1} \boxtimes 1_{W_2}} & (W_3 \boxtimes_A W_1) \boxtimes W_2 & \xrightarrow{\eta_{W_3} \boxtimes_A W_1, W_2} & (W_3 \boxtimes_A W_1) \boxtimes_A W_2
\end{array}$$

the surjectivity of $\eta_{W_1, W_2} \boxtimes_A W_3 \circ (1_{W_1} \boxtimes \eta_{W_2, W_3})$, and the hexagon axiom in SC . The commutativity of (2.32) with \mathcal{R}^A replaced by $(\mathcal{R}^A)^{-1}$ follows similarly. \square

We cannot say that $\text{Rep}^0 A$ is a braided tensor supercategory because $\text{Rep}^0 A$ may not be abelian. However:

Proposition 2.56. *Every parity-homogeneous morphism in $\text{Rep}^0 A$ has a kernel and cokernel. Moreover, every parity-homogeneous monomorphism in $\text{Rep}^0 A$ is a kernel, and every parity-homogeneous epimorphism is a cokernel.*

Proof. We showed in Proposition 2.32 that every parity-homogeneous morphism $f : W_1 \rightarrow W_2$ in $\text{Rep}^0 A$ has a kernel (K, μ_K, k) and cokernel (C, μ_C, c) in $\text{Rep} A$. So we just need to show that K and C are objects of $\text{Rep}^0 A$. By the definition of μ_K , we have

$$k \circ \mu_K \circ \mathcal{M}_{A, K} = \mu_{W_1} \circ (1_A \boxtimes k) \circ \mathcal{M}_{A, K} = \mu_{W_1} \circ \mathcal{M}_{A, W_1} \circ (1_A \boxtimes k) = \mu_{W_1} \circ (1_A \boxtimes k) = k \circ \mu_K;$$

since k is a monomorphism, K is an object of $\text{Rep}^0 A$. We get $\mu_C \circ \mathcal{M}_{A,C} = \mu_C$ similarly, so C is an object of $\text{Rep}^0 A$ as well.

To show that every parity-homogeneous monomorphism in $\text{Rep}^0 A$ is a kernel and every parity-homogeneous epimorphism in $\text{Rep}^0 A$ is a cokernel, the same arguments as in the proof of Theorem 2.9, with \mathcal{C} replaced by $\text{Rep} A$ and with $\text{Rep} A$ replaced by $\text{Rep}^0 A$, show that a monomorphism in $\text{Rep}^0 A$ is also monic in $\text{Rep} A$ and an epimorphism in $\text{Rep}^0 A$ is also epic in $\text{Rep} A$. Then similar to Theorem 2.9, any monomorphism in $\text{Rep}^0 A$ is the kernel of its cokernel (which is an object of $\text{Rep}^0 A$), and any epimorphism in $\text{Rep}^0 A$ is the cokernel of its kernel (which is an object of $\text{Rep}^0 A$). \square

Remark 2.57. The preceding theorem and proposition show that the subcategory $\underline{\text{Rep}}^0 A$ of $\text{Rep}^0 A$ which has the same objects but only even morphisms is an \mathbb{F} -linear braided tensor category. In general, if A is a commutative associative algebra in a tensor category \mathcal{C} , $\text{Rep}^0 A$ is a braided tensor category.

2.7 Induction and restriction functors

The bulk of this subsection contains a construction (following [KO], but generalized to the superalgebra setting) of an induction functor $\mathcal{F} : \mathcal{SC} \rightarrow \text{Rep} A$. Since induction is critical for the applications later in this paper, we give a full proof (in diagram form) that it is a tensor functor. We also briefly discuss the corresponding right adjoint restriction functor from $\text{Rep} A$ to \mathcal{SC} .

Suppose W is an object of \mathcal{SC} ; we define $\mathcal{F}(W) = A \boxtimes W$ and

$$\mu_{\mathcal{F}(W)} : A \boxtimes (A \boxtimes W) \xrightarrow{\underline{A}_{A,A,W}} (A \boxtimes A) \boxtimes W \xrightarrow{\mu \boxtimes 1_W} A \boxtimes W.$$

Proposition 2.58. *The pair $(\mathcal{F}(W), \mu_{\mathcal{F}(W)})$ is an object of $\text{Rep} A$ and*

$$\mathcal{F} : W \mapsto (\mathcal{F}(W), \mu_{\mathcal{F}(W)}); f \mapsto 1_A \boxtimes f$$

defines a functor from \mathcal{SC} to $\text{Rep} A$.

Proof. First, $\mu_{\mathcal{F}(W)}$ is even because $\underline{A}_{A,A,W}$ and $\mu \boxtimes 1_W$ are even. The proof that $\mu_{\mathcal{F}(W)}$ is associative is shown in the following diagrams; note that the pentagon axiom and naturality of associativity isomorphisms are needed in the detailed proof:

The unit property of $\mu_{\mathcal{F}(W)}$ follows from properties of the associativity and unit isomorphisms in \mathcal{SC} along with the unit property of μ :

To show that \mathcal{F} defines a functor from \mathcal{SC} to $\text{Rep} A$, we need to show that if $f : W_1 \rightarrow W_2$ is a morphism in \mathcal{SC} , then

$$\mathcal{F}(f) = 1_A \boxtimes f : A \boxtimes W_1 \rightarrow A \boxtimes W_2$$

is a morphism in $\text{Rep } A$. This follows from

$$\begin{array}{c}
\mathcal{F}(W_2) \\
\downarrow \\
\boxed{\mu_{\mathcal{F}(W_2)}} \\
\swarrow \quad \searrow \\
A \quad \mathcal{F}(W_1) \\
\downarrow \quad \downarrow \\
\boxed{\mathcal{F}(f)} \\
\downarrow \\
A \quad \mathcal{F}(W_1)
\end{array}
=
\begin{array}{c}
A \quad W_2 \\
\downarrow \quad \downarrow \\
\boxed{\mu} \quad \downarrow \\
A \quad A \quad W_1 \\
\downarrow \quad \downarrow \\
\boxed{f} \\
\downarrow \\
A \quad A \quad W_1
\end{array}
=
\begin{array}{c}
A \quad W_2 \\
\downarrow \quad \downarrow \\
\boxed{\mu} \quad \downarrow \\
A \quad A \quad W_1 \\
\downarrow \quad \downarrow \\
\boxed{f} \\
\downarrow \\
A \quad A \quad W_1
\end{array}
=
\begin{array}{c}
\mathcal{F}(W_2) \\
\downarrow \\
\boxed{\mathcal{F}(f)} \\
\downarrow \\
\boxed{\mu_{\mathcal{F}(W_1)}} \\
\swarrow \quad \searrow \\
A \quad \mathcal{F}(W_1)
\end{array}$$

It is clear that with this definition of $\mathcal{F}(f)$, \mathcal{F} satisfies the axioms of a functor. \square

For applications later in this paper, it is crucial that the induction functor \mathcal{F} be compatible with the tensor structures on its source and target categories. The following theorem is essentially Theorem 1.6 in [KO], but we provide a detailed proof since we work in the generality of superalgebras and make no assumptions on \mathcal{SC} besides right exactness of the tensor functor.

Theorem 2.59 ([KO, Theorem 1.6]). *The induction functor \mathcal{F} is a tensor functor.*

Proof. To show that \mathcal{F} is a tensor functor, we need to show the following:

1. There is an even isomorphism $\varphi : \mathcal{F}(\mathbf{1}) \rightarrow A$.
2. There is an even natural isomorphism $f : \mathcal{F} \circ \boxtimes \rightarrow \boxtimes_A \circ (\mathcal{F} \times \mathcal{F})$.
3. The natural isomorphism f and the isomorphism φ are compatible with the unit isomorphisms in \mathcal{SC} and $\text{Rep } A$ in the sense that the diagrams

$$\begin{array}{ccc}
\mathcal{F}(\mathbf{1} \boxtimes W) & \xrightarrow{f_{\mathbf{1}, W}} & \mathcal{F}(\mathbf{1}) \boxtimes_A \mathcal{F}(W) \\
\downarrow \mathcal{F}(l_W) & & \downarrow \varphi \boxtimes_A 1_{\mathcal{F}(W)} \\
\mathcal{F}(W) & \xrightarrow{(l_{\mathcal{F}(W)}^A)^{-1}} & A \boxtimes_A \mathcal{F}(W)
\end{array}
\quad \text{and} \quad
\begin{array}{ccc}
\mathcal{F}(W \boxtimes \mathbf{1}) & \xrightarrow{f_{W, \mathbf{1}}} & \mathcal{F}(W) \boxtimes_A \mathcal{F}(\mathbf{1}) \\
\downarrow \mathcal{F}(r_W) & & \downarrow 1_{\mathcal{F}(W)} \boxtimes_A \varphi \\
\mathcal{F}(W) & \xrightarrow{(r_{\mathcal{F}(W)}^A)^{-1}} & \mathcal{F}(W) \boxtimes_A A
\end{array}
\tag{2.33}$$

commute for any object W in \mathcal{SC} .

4. The natural isomorphism f is compatible with the associativity isomorphisms in \mathcal{SC} and $\text{Rep } A$ in the sense that the diagram

$$\begin{array}{ccc}
\mathcal{F}(W_1 \boxtimes (W_2 \boxtimes W_3)) & \xrightarrow{\mathcal{F}(A_{W_1, W_2, W_3})} & \mathcal{F}((W_1 \boxtimes W_2) \boxtimes W_3) \\
\downarrow f_{W_1, W_2 \boxtimes W_3} & & \downarrow f_{W_1 \boxtimes W_2, W_3} \\
\mathcal{F}(W_1) \boxtimes_A \mathcal{F}(W_2 \boxtimes W_3) & & \mathcal{F}(W_1 \boxtimes W_2) \boxtimes_A \mathcal{F}(W_3) \\
\downarrow 1_{\mathcal{F}(W_1)} \boxtimes_A f_{W_2, W_3} & & \downarrow f_{W_1, W_2} \boxtimes_A 1_{\mathcal{F}(W_3)} \\
\mathcal{F}(W_1) \boxtimes_A (\mathcal{F}(W_2) \boxtimes_A \mathcal{F}(W_3)) & \xrightarrow{A_{\mathcal{F}(W_1), \mathcal{F}(W_2), \mathcal{F}(W_3)}} & (\mathcal{F}(W_1) \boxtimes_A \mathcal{F}(W_2)) \boxtimes_A \mathcal{F}(W_3)
\end{array}
\tag{2.34}$$

commutes for all objects W_1, W_2 , and W_3 in \mathcal{SC} .

Since $\mathcal{F}(\mathbf{1}) = A \boxtimes \mathbf{1}$, we can take the isomorphism $\varphi : \mathcal{F}(\mathbf{1}) \rightarrow A$ to be r_A , provided this is a morphism in $\text{Rep } A$. In fact, $r_A \circ \mu_{\mathcal{F}(\mathbf{1})}$ is the composition

$$A \boxtimes (A \boxtimes \mathbf{1}) \xrightarrow{A_{A, A, \mathbf{1}}} (A \boxtimes A) \boxtimes \mathbf{1} \xrightarrow{\mu \boxtimes \mathbf{1}} A \boxtimes \mathbf{1} \xrightarrow{r_A} A.$$

By the naturality of the right unit, this composition equals

$$A \boxtimes (A \boxtimes \mathbf{1}) \xrightarrow{A_{A, A, \mathbf{1}}} (A \boxtimes A) \boxtimes \mathbf{1} \xrightarrow{r_A \boxtimes A} A \boxtimes A \xrightarrow{\mu} A.$$

Then since $r_{A \boxtimes A} \circ A_{A, A, \mathbf{1}} = 1_A \boxtimes r_A$, this composition equals $\mu \circ (1_A \boxtimes r_A)$, as required.

Next, for objects W_1 and W_2 in \mathcal{SC} , we need a natural isomorphism

$$f_{W_1, W_2} : \mathcal{F}(W_1 \boxtimes W_2) \rightarrow \mathcal{F}(W_1) \boxtimes_A \mathcal{F}(W_2).$$

We can define f_{W_1, W_2} by the composition

$$\begin{aligned} A \boxtimes (W_1 \boxtimes W_2) &\xrightarrow{\Delta_{A, W_1, W_2}} (A \boxtimes W_1) \boxtimes W_2 \xrightarrow{1_{A \boxtimes W_1} \boxtimes l_{W_2}^{-1}} (A \boxtimes W_1) \boxtimes (\underline{1} \boxtimes W_2) \\ &\xrightarrow{1_{A \boxtimes W_1} \boxtimes (\iota_A \boxtimes 1_{W_2})} (A \boxtimes W_1) \boxtimes (A \boxtimes W_2) \xrightarrow{\eta_{A \boxtimes W_1, A \boxtimes W_2}} (A \boxtimes W_1) \boxtimes_A (A \boxtimes W_2). \end{aligned} \quad (2.35)$$

We need to verify that f_{W_1, W_2} so defined is a morphism in $\text{Rep } A$, that is,

$$\mu_{(A \boxtimes W_1) \boxtimes_A (A \boxtimes W_2)} \circ (1_A \boxtimes f_{W_1, W_2}) = f_{W_1, W_2} \circ \mu_{A \boxtimes (W_1 \boxtimes W_2)}.$$

This can be proved as follows:

The detailed argument frequently uses properties of associativity isomorphisms, and in the first equality, we have used $\mu^{(1)}$ to define $\mu_{(A \boxtimes W_1) \boxtimes_A (A \boxtimes W_2)}$.

Now we prove that the $\text{Rep } A$ -morphisms f_{W_1, W_2} determine a natural transformation from $\mathcal{F} \circ \boxtimes$ to $\boxtimes_A \circ (\mathcal{F} \times \mathcal{F})$, that is, we show that if $f_1 : W_1 \rightarrow \tilde{W}_1$ and $f_2 : W_2 \rightarrow \tilde{W}_2$ are morphisms in \mathcal{SC} , then

$$(\mathcal{F}(f_1) \boxtimes_A \mathcal{F}(f_2)) \circ f_{W_1, W_2} = f_{\tilde{W}_1, \tilde{W}_2} \circ \mathcal{F}(f_1 \boxtimes f_2).$$

This follows using these diagrams:

In the second equality, we have used naturality of the left unit isomorphism and the evenness of ι_A and l_{W_2} to exchange their order with $\mathcal{F}(f_1) \boxtimes \mathcal{F}(f_2)$.

Next, we show that each f_{W_1, W_2} is an isomorphism by constructing an inverse. We define \tilde{g}_{W_1, W_2} to be the composition

$$\begin{aligned} (A \boxtimes W_1) \boxtimes (A \boxtimes W_2) &\xrightarrow{assoc.} (A \boxtimes (W_1 \boxtimes A)) \boxtimes W_2 \xrightarrow{(1_A \boxtimes \mathcal{R}_{A, W_1}^{-1}) \boxtimes 1_{W_2}} (A \boxtimes (A \boxtimes W_1)) \boxtimes W_2 \\ &\xrightarrow{assoc.} (A \boxtimes A) \boxtimes (W_1 \boxtimes W_2) \xrightarrow{\mu \boxtimes 1_{W_1} \boxtimes W_2} A \boxtimes (W_1 \boxtimes W_2), \end{aligned}$$

where the arrows marked *assoc.* refer to any composition of associativity isomorphisms between the source and target of the arrows. If we can show that

$$\tilde{g}_{W_1, W_2} \circ \mu^{(1)} = \tilde{g}_{W_1, W_2} \circ \mu^{(2)} : A \boxtimes ((A \boxtimes W_1) \boxtimes (A \boxtimes W_2)) \rightarrow A \boxtimes (W_1 \boxtimes W_2), \quad (2.36)$$

then the universal property of the cokernel $((A \boxtimes W_1) \boxtimes_A (A \boxtimes W_2), \eta_{A \boxtimes W_1, A \boxtimes W_2})$ implies that there is a unique morphism

$$g_{W_1, W_2} : (A \boxtimes W_1) \boxtimes_A (A \boxtimes W_2) \rightarrow A \boxtimes (W_1 \boxtimes W_2).$$

such that $g_{W_1, W_2} \circ \eta_{A \boxtimes W_1, A \boxtimes W_2} = \tilde{g}_{W_1, W_2}$. To show (2.36), we use the following diagrams, starting with $\tilde{g}_{W_1, W_2} \circ \mu^{(2)}$ on the left and ending with $\tilde{g}_{W_1, W_2} \circ \mu^{(1)}$ on the right:

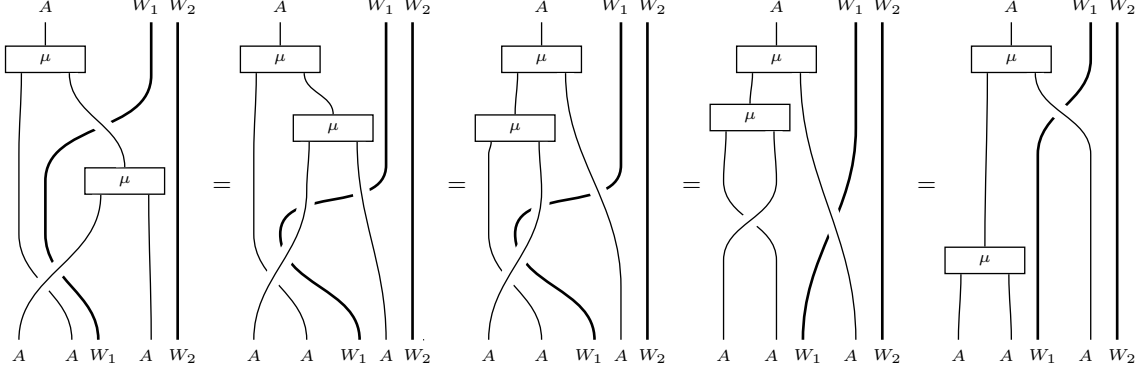

Next, we show that g_{W_1, W_2} is the inverse of f_{W_1, W_2} . To show $g_{W_1, W_2} \circ f_{W_1, W_2} = 1_{A \boxtimes (W_1 \boxtimes W_2)}$:

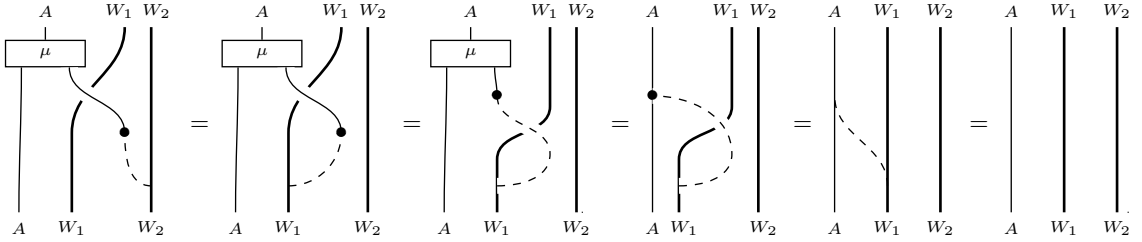

Now we consider $f_{W_1, W_2} \circ g_{W_1, W_2}$; note that

$$f_{W_1, W_2} \circ g_{W_1, W_2} \circ \eta_{A \boxtimes W_1, A \boxtimes W_2} = \eta_{A \boxtimes W_1, A \boxtimes W_2} \circ I,$$

where I is the endomorphism of $(A \boxtimes W_1) \boxtimes (A \boxtimes W_2)$ given by the composition

$$\begin{aligned} (A \boxtimes W_1) \boxtimes (A \boxtimes W_2) &\xrightarrow{\text{assoc.}} (A \boxtimes (W_1 \boxtimes A)) \boxtimes W_2 \xrightarrow{(1_A \boxtimes \mathcal{R}_{A, W_1}^{-1}) \boxtimes 1_{W_2}} (A \boxtimes (A \boxtimes W_1)) \boxtimes W_2 \\ &\xrightarrow{\text{assoc.}} (A \boxtimes A) \boxtimes (W_1 \boxtimes W_2) \xrightarrow{\mu \boxtimes 1_{W_1 \boxtimes W_2}} A \boxtimes (W_1 \boxtimes W_2) \xrightarrow{\mathcal{A}_{A, W_1, W_2}} (A \boxtimes W_1) \boxtimes W_2 \\ &\xrightarrow{1_{A \boxtimes W_1} \boxtimes ((\iota_A \boxtimes 1_{W_2}) \circ \mathcal{L}_{W_2}^{-1})} (A \boxtimes W_1) \boxtimes (A \boxtimes W_2). \end{aligned}$$

Thus by the surjectivity of $\eta_{A \boxtimes W_1, A \boxtimes W_2}$, it is enough to prove that $\eta_{A \boxtimes W_1, A \boxtimes W_2} \circ I = \eta_{A \boxtimes W_1, A \boxtimes W_2}$, or

$$\eta_{A \boxtimes W_1, A \boxtimes W_2} \circ (I - 1_{(A \boxtimes W_1) \boxtimes (A \boxtimes W_2)}) = 0.$$

For this, it is in turn enough to prove

$$I \circ J = \mu^{(1)} \circ (1_A \boxtimes (1_{A \boxtimes W_1} \boxtimes (\iota_A \boxtimes 1_{W_2}))), \quad (2.37)$$

$$J = \mu^{(2)} \circ (1_A \boxtimes (1_{A \boxtimes W_1} \boxtimes (\iota_A \boxtimes 1_{W_2}))), \quad (2.38)$$

where $J : A \boxtimes ((A \boxtimes W_1) \boxtimes (\mathbf{1} \boxtimes W_2)) \rightarrow (A \boxtimes W_1) \boxtimes (A \boxtimes W_2)$ is the isomorphism

$$\begin{aligned} J : A \boxtimes ((A \boxtimes W_1) \boxtimes (\mathbf{1} \boxtimes W_2)) &\xrightarrow{\mathcal{A}_{A, A \boxtimes W_1, \mathbf{1} \boxtimes W_2}} (A \boxtimes (A \boxtimes W_1)) \boxtimes (\mathbf{1} \boxtimes W_2) \\ &\xrightarrow{\mathcal{R}_{A, A \boxtimes W_1} \boxtimes \mathcal{L}_{W_2}} ((A \boxtimes W_1) \boxtimes A) \boxtimes W_2 \xrightarrow{\mathcal{A}_{A \boxtimes W_1, A, W_2}^{-1}} (A \boxtimes W_1) \boxtimes (A \boxtimes W_2). \end{aligned}$$

For (2.37) we proceed as follows:

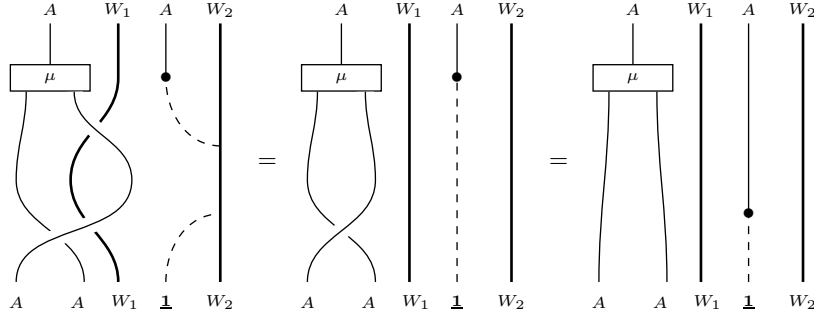

On the other hand, $\mu^{(2)} \circ (1_A \boxtimes (1_{A \boxtimes W_1} \boxtimes (\iota_A \boxtimes 1_{W_2})))$ can be handled with the diagrams:

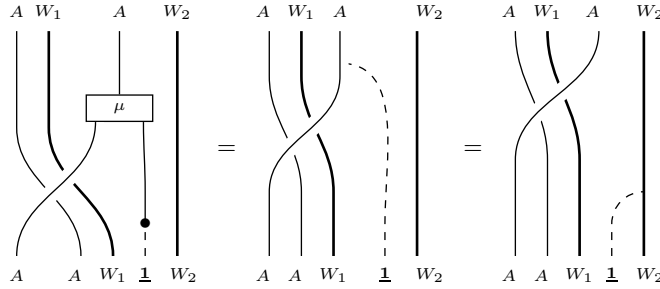

This completes the proof that $f_{W_1, W_2} \circ g_{W_1, W_2} = 1_{(A \boxtimes W_1) \boxtimes_A (A \boxtimes W_2)}$, and thus that the Rep A -morphisms f_{W_1, W_2} define an (even) natural isomorphism $f : \mathcal{F} \circ \boxtimes \rightarrow \boxtimes_A \circ (\mathcal{F} \times \mathcal{F})$.

Now we show that f and φ are compatible with the unit isomorphisms. To prove (2.33), we establish that for any object W of SC ,

$$\begin{aligned} (\iota_{A \boxtimes W}^A) \circ (\varphi \boxtimes_A 1_{A \boxtimes W}) \circ f_{\mathbf{1}, W} &= \mathcal{F}(l_W) : A \boxtimes (\mathbf{1} \boxtimes W) \rightarrow A \boxtimes W, \\ (r_{A \boxtimes W}^A) \circ (1_{A \boxtimes W} \boxtimes_A \varphi) \circ f_{W, \mathbf{1}} &= \mathcal{F}(r_W) : A \boxtimes (W \boxtimes \mathbf{1}) \rightarrow A \boxtimes W. \end{aligned}$$

The first follows from:

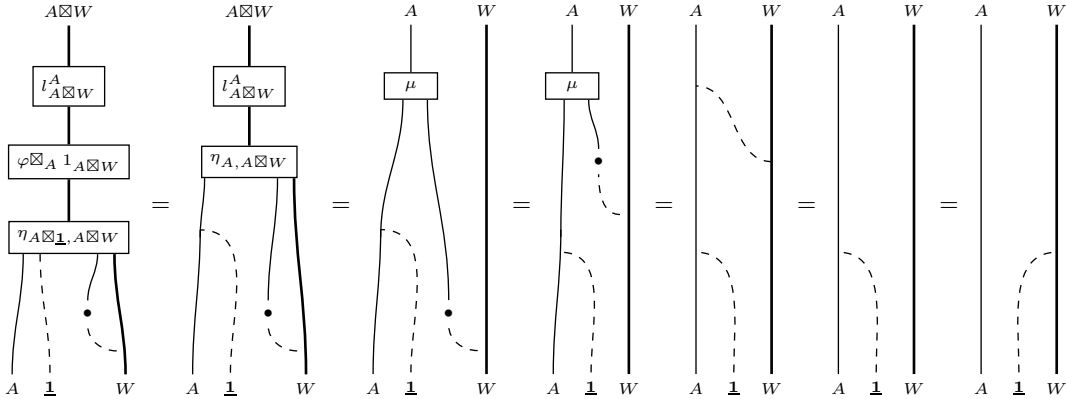

The second follows from:

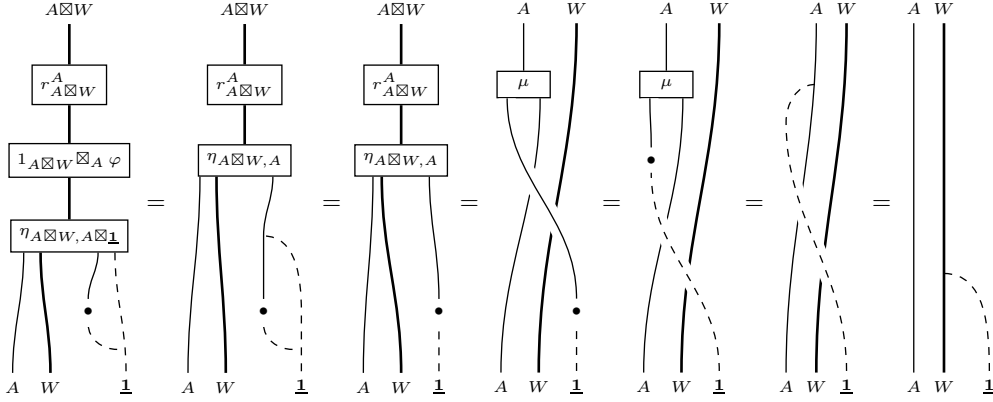

Finally, to prove that f is compatible with the associativity isomorphisms in \mathcal{SC} and $\text{Rep } A$, we have to prove the commutativity of (2.34) for objects W_1, W_2 , and W_3 in \mathcal{SC} . To simplify notation, we use ι_W for the composition

$$W \xrightarrow{\iota_W^{-1}} \underline{1} \boxtimes W \xrightarrow{\iota_{A \boxtimes W}} A \boxtimes W,$$

where W is an object of \mathcal{SC} . Then the lower left composition of morphisms in (2.34) is given by

$$\begin{aligned} & A \boxtimes (W_1 \boxtimes (W_2 \boxtimes W_3)) \xrightarrow{\underline{A}_{A, W_1, W_2 \boxtimes W_3}} (A \boxtimes W_1) \boxtimes (W_2 \boxtimes W_3) \\ & \xrightarrow{1_{A \boxtimes W_1} \boxtimes \iota_{W_2 \boxtimes W_3}} (A \boxtimes W_1) \boxtimes (A \boxtimes (W_2 \boxtimes W_3)) \xrightarrow{1_{A \boxtimes W_1} \boxtimes \underline{A}_{A, W_2, W_3}} (A \boxtimes W_1) \boxtimes ((A \boxtimes W_2) \boxtimes W_3) \\ & \xrightarrow{1_{A \boxtimes W_1} \boxtimes (1_{A \boxtimes W_2} \boxtimes \iota_{W_3})} (A \boxtimes W_1) \boxtimes ((A \boxtimes W_2) \boxtimes (A \boxtimes W_3)) \\ & \xrightarrow{\underline{A}_{A \boxtimes W_1, A \boxtimes W_2, A \boxtimes W_3}} ((A \boxtimes W_1) \boxtimes (A \boxtimes W_2)) \boxtimes (A \boxtimes W_3) \\ & \rightarrow ((A \boxtimes W_1) \boxtimes_A (A \boxtimes W_2)) \boxtimes_A (A \boxtimes W_3), \end{aligned}$$

where the last arrow is the natural composition of cokernel morphisms. Now, since $\underline{A}_{\underline{1}, W_2, W_3} \circ \iota_{W_2 \boxtimes W_3}^{-1} = \iota_{W_2}^{-1} \boxtimes 1_{W_3}$, we have

$$\underline{A}_{A, W_2, W_3} \circ \iota_{W_2 \boxtimes W_3} = \iota_{W_2} \boxtimes 1_{W_3}.$$

This together with the naturality of the associativity isomorphisms applied to ι_{W_2} and ι_{W_3} yields

$$\begin{aligned} & A \boxtimes (W_1 \boxtimes (W_2 \boxtimes W_3)) \xrightarrow{assoc} ((A \boxtimes W_1) \boxtimes W_2) \boxtimes W_3 \\ & \xrightarrow{(1_{A \boxtimes W_1} \boxtimes \iota_{W_2}) \boxtimes \iota_{W_3}} ((A \boxtimes W_1) \boxtimes (A \boxtimes W_2)) \boxtimes (A \boxtimes W_3) \\ & \rightarrow ((A \boxtimes W_1) \boxtimes_A (A \boxtimes W_2)) \boxtimes_A (A \boxtimes W_3). \end{aligned}$$

By the pentagon axiom, we can take the composition of associativity isomorphisms represented by the first arrow to be

$$(\underline{A}_{A, W_1, W_2} \boxtimes 1_{W_3}) \circ \underline{A}_{A, W_1 \boxtimes W_2, W_3} \circ (1_A \boxtimes \underline{A}_{W_1, W_2, W_3}).$$

Then we get

$$\begin{aligned} & A \boxtimes (W_1 \boxtimes (W_2 \boxtimes W_3)) \xrightarrow{1_A \boxtimes \underline{A}_{W_1, W_2, W_3}} A \boxtimes ((W_1 \boxtimes W_2) \boxtimes W_3) \\ & \xrightarrow{\underline{A}_{A, W_1 \boxtimes W_2, W_3}} (A \boxtimes (W_1 \boxtimes W_2)) \boxtimes W_3 \xrightarrow{1_{A \boxtimes (W_1 \boxtimes W_2)} \boxtimes \iota_{W_3}} (A \boxtimes (W_1 \boxtimes W_2)) \boxtimes (A \boxtimes W_3) \\ & \xrightarrow{\underline{A}_{A, W_1, W_2} \boxtimes 1_{A \boxtimes W_3}} ((A \boxtimes W_1) \boxtimes W_2) \boxtimes (A \boxtimes W_3) \\ & \xrightarrow{(1_{A \boxtimes W_1} \boxtimes \iota_{W_2}) \boxtimes 1_{A \boxtimes W_3}} ((A \boxtimes W_1) \boxtimes (A \boxtimes W_2)) \boxtimes (A \boxtimes W_3) \\ & \rightarrow ((A \boxtimes W_1) \boxtimes_A (A \boxtimes W_2)) \boxtimes_A (A \boxtimes W_3), \end{aligned}$$

and this is the upper right composition in (2.34), completing the proof of the theorem. \square

In addition to the induction functor, there is a restriction functor from $\text{Rep } A$ to \mathcal{SC} :

Definition 2.60. The restriction functor $\mathcal{G} : \text{Rep } A \rightarrow \mathcal{SC}$ is given by

$$\mathcal{G} : (W, \mu_W) \mapsto W; f \mapsto f.$$

The following adjointness of \mathcal{F} and \mathcal{G} is well known (see for instance [EGNO, Lemma 7.8.12]):

Lemma 2.61. *For any object X of \mathcal{SC} and any object W of $\text{Rep } A$, there is a natural isomorphism between $\text{Hom}_{\text{Rep } A}(\mathcal{F}(X), W)$ and $\text{Hom}_{\mathcal{SC}}(X, \mathcal{G}(W))$.*

For future reference, we record here the maps used in the proof:

$$\begin{aligned} \Phi : \text{Hom}_{\text{Rep } A}(\mathcal{F}(X), W) &\longrightarrow \text{Hom}_{\mathcal{SC}}(X, \mathcal{G}(W)) \\ f &\longmapsto f \circ (\iota_A \boxtimes 1_X) \circ \iota_X^{-1} \\ \Psi : \text{Hom}_{\mathcal{SC}}(X, \mathcal{G}(W)) &\longrightarrow \text{Hom}_{\text{Rep } A}(\mathcal{F}(X), W) \\ g &\longmapsto \mu_W \circ (1_A \boxtimes g). \end{aligned}$$

It is easy to verify that $\Psi(g)$ is indeed a morphism in $\text{Rep } A$, that Φ and Ψ are mutual inverses, and that they are natural isomorphisms.

2.8 More properties of $\text{Rep } A$ and the induction functor

In this subsection we study the relation between the induction functor (and restriction functor) constructed in the previous subsection and additional structures that can be imposed on \mathcal{SC} , such as rigidity and ribbon structure, which we recall below. Many of the results here are contained in [KO] and [EGNO], but in some cases a little additional care is needed in the superalgebra generality.

Our first goal is to show that tensoring in $\text{Rep } A$ preserves right exact sequences of parity-homogeneous morphisms; for this we need the following lemma:

Lemma 2.62 ([KO, Theorem 1.6(1)]). *The restriction functor \mathcal{G} is injective on morphisms and preserves exact sequences of parity-homogeneous morphisms.*

Proof. The first assertion is obvious. For the second, let $W_1 \xrightarrow{f_1} W_2 \xrightarrow{f_2} W_3 \rightarrow 0$ be right exact in $\text{Rep } A$ (that is, (W_3, f_2) is a $\text{Rep } A$ -cokernel of f_1) with f_1 and f_2 parity-homogeneous. We need to show that (W_3, f_2) is also an \mathcal{SC} -cokernel of f_1 . Proposition 2.32 and its proof show that f_1 has a $\text{Rep } A$ -cokernel (C, c) which is also a cokernel of f_1 in \mathcal{SC} . Thus there is a $\text{Rep } A$ -isomorphism $\eta : W_3 \rightarrow C$ such that $\eta \circ f_2 = c$; using this isomorphism, it is clear that (W_3, f_2) is a cokernel of f_1 in \mathcal{SC} .

One can show similarly that if $0 \rightarrow W_1 \xrightarrow{f_1} W_2 \xrightarrow{f_2} W_3$ is a left exact sequence of parity-homogeneous morphisms in $\text{Rep } A$, then (W_1, f_1) is also a kernel of f_2 in \mathcal{SC} . \square

Now we can prove that tensoring in $\text{Rep } A$ preserves right exact sequences of homogeneous morphisms:

Proposition 2.63. *For any object W in $\text{Rep } A$ and right exact sequence $W_1 \xrightarrow{f_1} W_2 \xrightarrow{f_2} W_3 \rightarrow 0$ in $\text{Rep } A$ with f_1 parity-homogeneous, the sequences*

$$W \boxtimes_A W_1 \xrightarrow{1_W \boxtimes_A f_1} W \boxtimes_A W_2 \xrightarrow{1_W \boxtimes_A f_2} W \boxtimes_A W_3 \rightarrow 0$$

and

$$W_1 \boxtimes_A W \xrightarrow{f_1 \boxtimes_A 1_W} W_2 \boxtimes_A W \xrightarrow{f_2 \boxtimes_A 1_W} W_3 \boxtimes_A W \rightarrow 0$$

are also right exact.

Proof. For the first sequence, we need to show that $(W \boxtimes_A W_3, 1_W \boxtimes_A f_2)$ is a cokernel of $1_W \boxtimes_A f_1$. By Lemma 2.62, (W_3, f_2) is a cokernel of f_1 in \mathcal{SC} , so because $W \boxtimes \cdot$ is right exact in \mathcal{SC} , the top row of the following commutative diagram is right exact:

$$\begin{array}{ccccccc} W \boxtimes W_1 & \xrightarrow{1_W \boxtimes f_1} & W \boxtimes W_2 & \xrightarrow{1_W \boxtimes f_2} & W \boxtimes W_3 & \longrightarrow & 0 \\ \downarrow \eta_{W, W_1} & & \downarrow \eta_{W, W_2} & & \downarrow \eta_{W, W_3} & & \\ W \boxtimes_A W_1 & \xrightarrow{1_W \boxtimes_A f_1} & W \boxtimes_A W_2 & \xrightarrow{1_W \boxtimes_A f_2} & W \boxtimes_A W_3 & \longrightarrow & 0 \end{array}$$

Now, if $g : W \boxtimes_A W_2 \rightarrow \widetilde{W}$ is a morphism in $\text{Rep } A$ such that $g \circ (1_W \boxtimes_A f_1) = 0$, then $g \circ \eta_{W, W_2} \circ (1_W \boxtimes f_1) = 0$ as well. Thus the universal property of the cokernel $(W \boxtimes W_3, 1_W \boxtimes f_2)$ implies that there is a unique \mathcal{SC} -morphism $\eta : W \boxtimes W_3 \rightarrow \widetilde{W}$ such that

$$\eta \circ (1_W \boxtimes f_2) = g \circ \eta_{W, W_2}.$$

To complete the proof that $W \boxtimes_A \cdot$ is right exact, we need to show that η is a $\text{Rep } A$ -intertwining operator, since then the universal property of the $\text{Rep } A$ -tensor product will induce a unique $\text{Rep } A$ -morphism $\tilde{g} : W \boxtimes_A W_3 \rightarrow \tilde{W}$ such that $\tilde{g} \circ \eta_{W, W_3} = \eta$, from which we get

$$\tilde{g} \circ (1_W \boxtimes_A f_2) = g$$

using the surjectivity of η_{W, W_2} .

To see that η is a $\text{Rep } A$ -intertwining operator, we use the fact that f_2 is a $\text{Rep } A$ -morphism, (2.13), the definition of η , and the fact that $g \circ \eta_{W, W_2}$ is a $\text{Rep } A$ -intertwining operator (recall Proposition 2.49):

$$\begin{aligned} \eta \circ \mu^{(i)} \circ (1_A \boxtimes (1_W \boxtimes f_2)) &= \eta \circ (1_W \boxtimes f_2) \circ \mu^{(i)} = g \circ \eta_{W, W_2} \circ \mu^{(i)} \\ &= \mu_{\tilde{W}} \circ (1_A \boxtimes (g \circ \eta_{W, W_2})) = \mu_{\tilde{W}} \circ (1_A \boxtimes \eta) \circ (1_A \boxtimes (1_W \boxtimes f_2)) \end{aligned}$$

for $i = 1, 2$. Since $1_A \boxtimes (1_W \boxtimes f_2)$ is surjective, $\eta \circ \mu^{(i)} = \mu_{\tilde{W}} \circ (1_A \boxtimes \eta)$ for $i = 1, 2$, as required.

The proof that $(W_3 \boxtimes_A W, f_2 \boxtimes_A 1_W)$ is a cokernel of $f_1 \boxtimes_A 1_W$ is the same. See also [EGNO, Exercise 7.8.23], but note that they work in a rigid category, which we do not assume here. \square

Remark 2.64. The preceding lemma and proposition show that \mathcal{G} is an exact functor from $\underline{\text{Rep}} A$ to $\underline{\mathcal{SC}}$, and that for any object in W in $\underline{\text{Rep}} A$, $W \boxtimes_A \cdot$ and $\cdot \boxtimes_A W$ are right exact functors on $\underline{\text{Rep}} A$. An easy consequence of Lemmas 2.61 and 2.62 is that if W is a projective object in $\underline{\mathcal{SC}}$, then $\mathcal{F}(W)$ is projective in $\underline{\text{Rep}} A$. All these results hold when $\underline{\mathcal{SC}}$ is replaced by \mathcal{C} and A is an ordinary algebra in \mathcal{C} .

We now study the interplay between induction, the braided monoidal supercategory $\text{Rep}^0 A$ of local A -modules, and additional structures on \mathcal{SC} . First, we show when an object of \mathcal{SC} induces to an object in $\text{Rep}^0 A$:

Proposition 2.65. *For an object W of \mathcal{SC} , $\mathcal{F}(W)$ is an object of $\text{Rep}^0 A$ if and only if $\mathcal{M}_{A, W} = 1_{A \boxtimes W}$.*

Proof. First suppose $\mathcal{F}(W) = A \boxtimes W$ is an object of $\text{Rep}^0 A$, that is, $\mu_{A \boxtimes W} \circ \mathcal{M}_{A, A \boxtimes W} = \mu_{A \boxtimes W}$. Then the following calculation shows that $\mathcal{M}_{A, W} = 1_{A \boxtimes W}$:

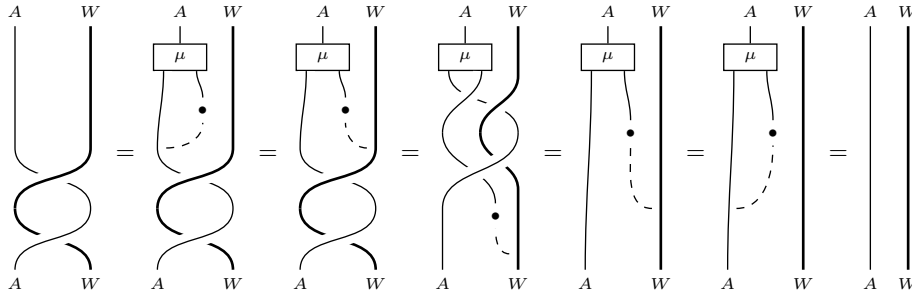

Conversely, if $\mathcal{M}_{A, W} = 1_{A \boxtimes W}$, then $\mu_{A \boxtimes W} \circ \mathcal{M}_{A, A \boxtimes W} = \mu_{A \boxtimes W}$ follows from:

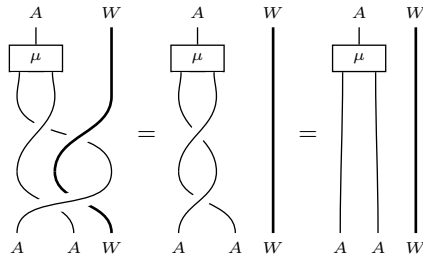

\square

Definition 2.66. Let \mathcal{SC}^0 denote the full subcategory of objects in \mathcal{SC} that induce to $\text{Rep}^0 A$.

In the next theorem, we show that induction $\mathcal{F} : \mathcal{SC}^0 \rightarrow \text{Rep}^0 A$ is a braided tensor functor. Recall the natural isomorphism $f : \mathcal{F} \circ \boxtimes \rightarrow \boxtimes_A \circ (\mathcal{F} \times \mathcal{F})$ and its inverse g from the proof of Theorem 2.59.

Theorem 2.67. *The category \mathcal{SC}^0 is an \mathbb{F} -linear additive braided monoidal supercategory, with structures induced from \mathcal{SC} , and $\mathcal{F} : \mathcal{SC}^0 \rightarrow \text{Rep}^0 A$ is a braided tensor functor.*

Proof. Since \mathcal{SC}^0 is a full subcategory of \mathcal{SC} , morphisms in \mathcal{SC}^0 form \mathbb{F} -superspaces, and the zero object of \mathcal{SC} is in \mathcal{SC}^0 . For biproducts, let $\{W_i\}$ be a finite set of objects in \mathcal{SC}^0 . Then Proposition 2.65, distributivity of tensor products over direct sums, and naturality of monodromy shows that $\bigoplus W_i$ induces to $\text{Rep}^0 A$. Thus \mathcal{SC}^0 is an \mathbb{F} -linear additive supercategory. To show that \mathcal{SC}^0 is braided monoidal, it is enough to show that it is closed under \boxtimes . By Theorem 2.55, $\mathcal{F}(W_1) \boxtimes_A \mathcal{F}(W_2)$ is an object $\text{Rep}^0 A$ for W_1, W_2 in \mathcal{SC}^0 , and moreover $\mathcal{F}(W_1 \boxtimes W_2) \cong \mathcal{F}(W_1) \boxtimes_A \mathcal{F}(W_2)$ since \mathcal{F} is a tensor functor. Hence $W_1 \boxtimes W_2$ is an object of \mathcal{SC}^0 .

To show that \mathcal{F} is a braided tensor functor on \mathcal{SC}^0 , we need to show that for objects W_1, W_2 in \mathcal{SC}^0 ,

$$\mathcal{F}(\underline{\mathcal{R}}_{W_1, W_2}) = g_{W_2, W_1} \circ \mathcal{R}_{\mathcal{F}(W_1), \mathcal{F}(W_2)}^A \circ f_{W_1, W_2}. \quad (2.39)$$

By definition, $g_{W_2, W_1} \circ \mathcal{R}_{\mathcal{F}(W_1), \mathcal{F}(W_2)}^A \circ f_{W_1, W_2}$ is the composition

$$\begin{aligned} A \boxtimes (W_1 \boxtimes W_2) &\xrightarrow{\underline{A}_{A, W_1, W_2}} (A \boxtimes W_1) \boxtimes W_2 \xrightarrow{1_{A \boxtimes W_1} \boxtimes \iota_{W_2}} (A \boxtimes W_1) \boxtimes (A \boxtimes W_2) \\ &\xrightarrow{\eta_{A \boxtimes W_1, A \boxtimes W_2}} (A \boxtimes W_1) \boxtimes_A (A \boxtimes W_2) \xrightarrow{\mathcal{R}_{A \boxtimes W_1, A \boxtimes W_2}^A} (A \boxtimes W_2) \boxtimes_A (A \boxtimes W_1) \xrightarrow{g_{W_2, W_1}} A \boxtimes (W_2 \boxtimes W_1), \end{aligned}$$

where $\iota_{W_2} = (\iota_A \boxtimes 1_{W_2}) \circ \iota_{W_2}^{-1}$. Then using the definition of $\mathcal{R}_{A \boxtimes W_1, A \boxtimes W_2}^A$ and borrowing notation from the proof of Theorem 2.59,

$$g_{W_2, W_1} \circ \mathcal{R}_{A \boxtimes W_1, A \boxtimes W_2}^A \circ \eta_{A \boxtimes W_1, A \boxtimes W_2} = g_{W_2, W_1} \circ \eta_{A \boxtimes W_2, A \boxtimes W_1} \circ \underline{\mathcal{R}}_{A \boxtimes W_1, A \boxtimes W_2} = \tilde{g}_{W_2, W_1} \circ \underline{\mathcal{R}}_{A \boxtimes W_1, A \boxtimes W_2}.$$

So we get the composition

$$\begin{aligned} A \boxtimes (W_1 \boxtimes W_2) &\xrightarrow{\underline{A}_{A, W_1, W_2}} (A \boxtimes W_1) \boxtimes W_2 \xrightarrow{1_{A \boxtimes W_1} \boxtimes \iota_{W_2}} (A \boxtimes W_1) \boxtimes (A \boxtimes W_2) \\ &\xrightarrow{\underline{\mathcal{R}}_{A \boxtimes W_1, A \boxtimes W_2}} (A \boxtimes W_2) \boxtimes (A \boxtimes W_1) \xrightarrow{\text{assoc.}} (A \boxtimes (W_2 \boxtimes A)) \boxtimes W_1 \\ &\xrightarrow{(1_A \boxtimes \underline{\mathcal{R}}_{A, W_2}^{-1}) \boxtimes 1_{W_1}} (A \boxtimes (A \boxtimes W_2)) \boxtimes W_1 \xrightarrow{\text{assoc.}} (A \boxtimes A) \boxtimes (W_2 \boxtimes W_1) \xrightarrow{\mu \boxtimes 1_{W_2 \boxtimes W_1}} A \boxtimes (W_2 \boxtimes W_1). \end{aligned} \quad (2.40)$$

Now we proceed as guided by the following diagrams:

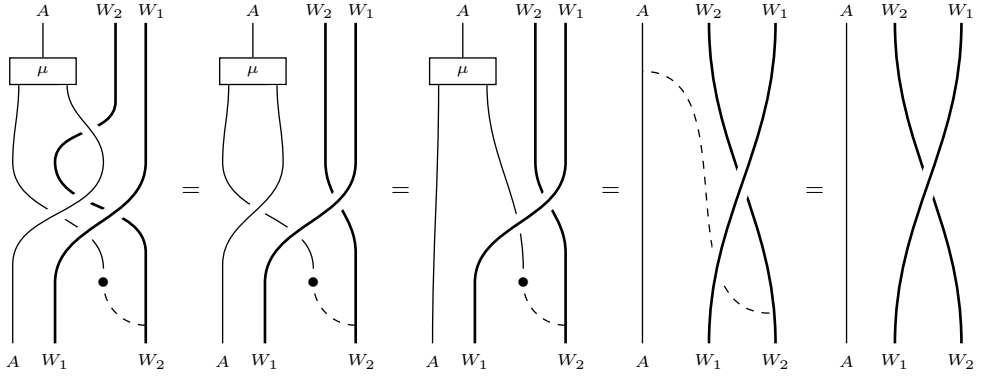

The last diagram simply represents $1_A \boxtimes \underline{\mathcal{R}}_{W_1, W_2} = \mathcal{F}(\underline{\mathcal{R}}_{W_1, W_2})$. □

Corollary 2.68. *If W_1 and W_2 are objects of \mathcal{SC}^0 , then*

$$f_{W_1, W_2} \circ \mathcal{F}(\mathcal{M}_{W_1, W_2}) = \mathcal{M}_{\mathcal{F}(W_1), \mathcal{F}(W_2)}^A \circ f_{W_1, W_2}.$$

Remark 2.69. The category \mathcal{SC}^0 may not be abelian: since \boxtimes on \mathcal{SC} is not necessarily left exact, \mathcal{SC}^0 might not be closed under kernels.

Next, we look at the relation between induction and duals in \mathcal{SC} ; first we recall the notion of duals in monoidal (super)categories:

Definition 2.70. ([EGNO, Definition 2.10.1]) A *left dual* (W^*, e_W, i_W) of an object W in a monoidal (super)category is an object W^* equipped with (even) morphisms $e_W : W^* \boxtimes W \rightarrow \underline{1}$ and $i_W : \underline{1} \rightarrow W \boxtimes W^*$ satisfying the *rigidity axioms*:

$$W \xrightarrow{i_W^{-1}} \underline{1} \boxtimes W \xrightarrow{i_W \boxtimes 1_W} (W \boxtimes W^*) \boxtimes W \xrightarrow{A_{W, W^*, W}^{-1}} W \boxtimes (W^* \boxtimes W) \xrightarrow{1_W \boxtimes e_W} W \boxtimes \underline{1} \xrightarrow{1_W} W \quad (2.41)$$

is 1_W and

$$W^* \xrightarrow{1_{W^*}^{-1}} W^* \boxtimes \underline{1} \xrightarrow{1_{W^*} \boxtimes i_W} W^* \boxtimes (W \boxtimes W^*) \xrightarrow{A_{W^*, W, W^*}} (W^* \boxtimes W) \boxtimes W^* \xrightarrow{e_W \boxtimes 1_{W^*}} \underline{1} \boxtimes W^* \xrightarrow{i_{W^*}} W^* \quad (2.42)$$

is 1_{W^*} .

A *right dual* $({}^*W, e'_W, i'_W)$ of W where now $e'_W : W \boxtimes {}^*W \rightarrow \underline{1}$ and $i'_W : \underline{1} \rightarrow {}^*W \boxtimes W$ can be defined using analogous rigidity axioms.

A monoidal (super)category is *rigid* if every object has a left and a right dual.

Remark 2.71. Left and right duals are unique up to unique isomorphism, if they exist (see for instance [EGNO, Proposition 2.10.5]).

If the braided tensor category \mathcal{C} is rigid, then so is the associated supercategory \mathcal{SC} :

Lemma 2.72. *Let $W = (W^{\bar{0}}, W^{\bar{1}})$ be an object of \mathcal{SC} . If both $W^{\bar{0}}$ and $W^{\bar{1}}$ possess left, respectively right, duals in \mathcal{C} , then the same holds for W in \mathcal{SC} . In particular, if \mathcal{C} is rigid then so is \mathcal{SC} .*

Proof. It is easy to check that if $W = W^{\bar{0}} \oplus W^{\bar{1}}$ is an object of \mathcal{SC} , then W^* can be taken to be $(W^{\bar{0}})^* \oplus (W^{\bar{1}})^*$ with

$$e_W : \left(((W^{\bar{0}})^* \boxtimes W^{\bar{0}}) \oplus ((W^{\bar{1}})^* \boxtimes W^{\bar{1}}) \right) \oplus \left(((W^{\bar{0}})^* \boxtimes W^{\bar{1}}) \oplus ((W^{\bar{1}})^* \boxtimes W^{\bar{0}}) \right) \rightarrow \mathbf{1} \oplus 0$$

given by $e_W = (e_{W^{\bar{0}}} \circ p_{(W^{\bar{0}})^* \boxtimes W^{\bar{0}}} + e_{W^{\bar{1}}} \circ p_{(W^{\bar{1}})^* \boxtimes W^{\bar{1}}}) \oplus 0$ and

$$i_W : \mathbf{1} \oplus 0 \rightarrow \left((W^{\bar{0}} \boxtimes (W^{\bar{0}})^*) \oplus (W^{\bar{1}} \boxtimes (W^{\bar{1}})^*) \right) \oplus \left((W^{\bar{0}} \boxtimes (W^{\bar{1}})^*) \oplus (W^{\bar{1}} \boxtimes (W^{\bar{0}})^*) \right)$$

given by $i_W = (q_{W^{\bar{0}} \boxtimes (W^{\bar{0}})^*} \circ i_{W^{\bar{0}}} + q_{W^{\bar{1}} \boxtimes (W^{\bar{1}})^*} \circ i_{W^{\bar{1}}}) \oplus 0$. Right duals can be arranged analogously. \square

Definition 2.73 (See [EGNO, Equation 2.47]). If $f : W_1 \rightarrow W_2$ is a morphism and W_1, W_2 possess left duals, the left dual morphism f^* is defined to be the composition

$$\begin{aligned} W_2^* &\xrightarrow{1_{W_2^*}^{-1}} W_2^* \boxtimes \underline{1} \xrightarrow{1_{W_2^*} \boxtimes i_{W_1}} W_2^* \boxtimes (W_1 \boxtimes W_1^*) \xrightarrow{A_{W_2^*, W_1, W_1^*}} (W_2^* \boxtimes W_1) \boxtimes W_1^* \\ &\xrightarrow{(1_{W_2^*} \boxtimes f) \boxtimes 1_{W_1^*}} (W_2^* \boxtimes W_2) \boxtimes W_1^* \xrightarrow{e_{W_2} \boxtimes 1_{W_1^*}} \underline{1} \boxtimes W_1^* \xrightarrow{i_{W_1^*}} W_1^*. \end{aligned} \quad (2.43)$$

The right dual morphism *f is defined analogously.

Remark 2.74. Left duality preserves the parity of morphisms because all structure morphisms including i_{W_1} and e_{W_2} are even. If all objects have left duals, the duality functor $W \mapsto W^*$, $f \mapsto f^*$ is contravariant in the sense that

$$(f_1 \circ f_2)^* = (-1)^{|f_1||f_2|} f_2^* \circ f_1^* \quad (2.44)$$

for parity-homogeneous morphisms f_1 and f_2 . Similar assertions hold for right duals.

We will need the following important properties of (left) dual morphisms:

Proposition 2.75. *Suppose W_1, W_2 are objects in a monoidal (super)category with left duals and $f : W_1 \rightarrow W_2$ is a morphism. Then the diagrams*

$$\begin{array}{ccc} \underline{1} & \xrightarrow{i_{W_2}} & W_2 \boxtimes W_2^* \\ \downarrow i_{W_1} & & \downarrow 1_{W_2} \boxtimes f^* \\ W_1 \boxtimes W_1^* & \xrightarrow{f \boxtimes 1_{W_1^*}} & W_2 \boxtimes W_1^* \end{array} \quad \text{and} \quad \begin{array}{ccc} W_2^* \boxtimes W_1 & \xrightarrow{1_{W_2^*} \boxtimes f} & W_2^* \boxtimes W_2 \\ \downarrow f^* \boxtimes 1_{W_1} & & \downarrow e_{W_2} \\ W_1^* \boxtimes W_1 & \xrightarrow{e_{W_1}} & \underline{1} \end{array}$$

commute.

Proof. The proof of $(1_{W_2} \boxtimes f^*) \circ i_{W_2} = (f \boxtimes 1_{W_1^*}) \circ i_{W_1}$ is as follows:

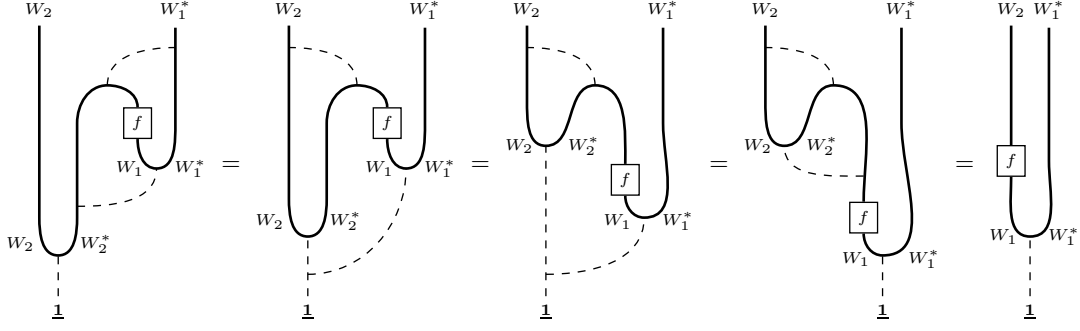

The first and third equalities follow from properties of unit and associativity isomorphisms. In the second equality, we use evenness of i_{W_2} to avoid a sign factor when we exchange its order with i_{W_1} and f . The last equality follows from the rigidity of W_2 .

The proof of $e_{W_1} \circ (f^* \boxtimes 1_{W_1}) = e_{W_2} \circ (1_{W_2^*} \boxtimes f)$ is similar and uses the rigidity of W_1 . \square

Remark 2.76. One can show that the left dual morphism f^* is characterized by the commutativity of either diagram in the preceding proposition. This property allows a relatively easy proof of (2.44).

Now we show that the induction functor $\mathcal{F} : \mathcal{SC} \rightarrow \text{Rep } A$ preserves duals; recall the natural isomorphism f , its inverse g , and the isomorphism $\varphi : \mathcal{F}(\underline{1}) \rightarrow A$ from the proof of Theorem 2.59:

Proposition 2.77 ([EGNO, Exercise 2.10.6], [KO, Lemma 1.16]). *If W is an object of \mathcal{SC} with left dual (W^*, e_W, i_W) , then $(\mathcal{F}(W^*), \tilde{e}_W, \tilde{i}_W)$ is a left dual of $\mathcal{F}(W)$ in $\text{Rep } A$, where*

$$\tilde{e}_W = \varphi \circ \mathcal{F}(e_W) \circ g_{W^*, W}$$

and

$$\tilde{i}_W = f_{W, W^*} \circ \mathcal{F}(i_W) \circ \varphi^{-1}.$$

An analogous result holds for right duals.

Proof. The following diagram whose left side is obtained by applying \mathcal{F} to (2.41) commutes because \mathcal{F} is a tensor functor:

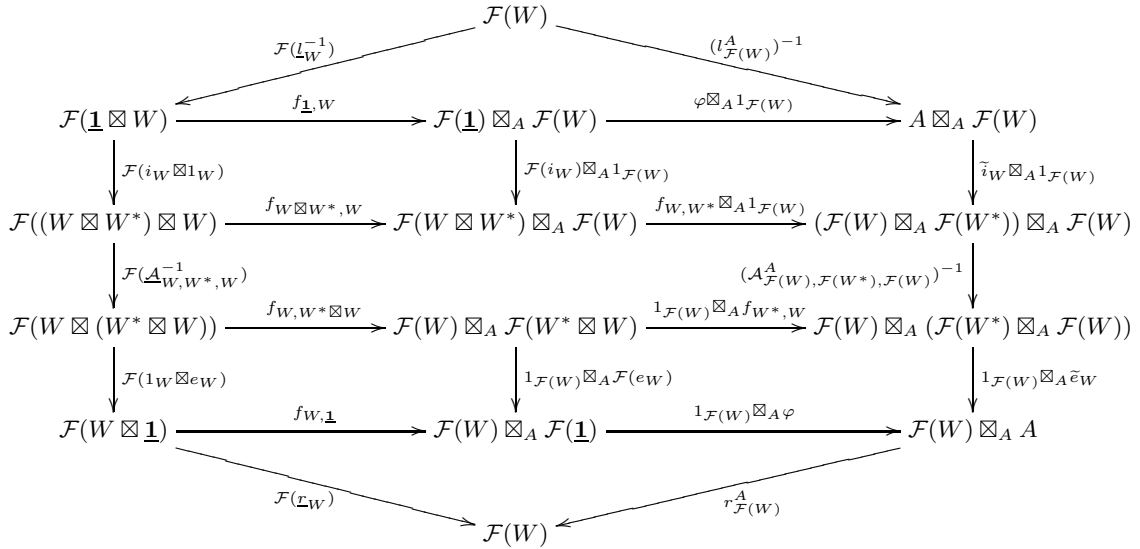

Since the left side equals $\mathcal{F}(1_W) = 1_A \boxtimes 1_W = 1_{A \boxtimes W} = 1_{\mathcal{F}(W)}$, the same holds for the right side. The second duality axiom (2.42) follows from a similar commutative diagram.

The analogous assertion for right duals follows similarly. \square

We also show that the induced dual of an induced object in $\text{Rep}^0 A$ is an object in $\text{Rep}^0 A$:

Lemma 2.78. *Let W be an object of \mathcal{SC} such that $\mathcal{F}(W)$ is an object of $\text{Rep}^0 A$. If (W^*, e_W, i_W) is a left dual of W in \mathcal{SC} , then $\mathcal{F}(W^*)$ is an object of $\text{Rep}^0 A$; a similar result holds for right duals.*

Proof. By Proposition 2.65, we need to prove $\mathcal{M}_{A,W^*} = 1_{A \boxtimes W^*}$. Proposition 2.65 implies that $\mathcal{M}_{A,W} = 1_{A \boxtimes W}$, which is equivalent to $\underline{\mathcal{R}}_{A,W} = \underline{\mathcal{R}}_{W,A}^{-1}$. Using [EGNO, Lemma 8.9.1], which holds in any braided monoidal supercategory, we have (with $\underline{\mathcal{A}}$ denoting suitable compositions of associativity isomorphisms):

$$\begin{aligned} \underline{\mathcal{R}}_{W^*,A} &= \underline{L}_{A \boxtimes W^*} \circ (e_W \boxtimes 1_{A \boxtimes W^*}) \circ \underline{\mathcal{A}} \circ (1_{W^*} \boxtimes \underline{\mathcal{R}}_{W,A}^{-1} \boxtimes 1_{W^*}) \circ \underline{\mathcal{A}} \circ (1_{W^* \boxtimes A} \boxtimes i_W) \circ \underline{L}_{W^* \boxtimes A}^{-1} \\ \underline{\mathcal{R}}_{A,W^*}^{-1} &= \underline{L}_{A \boxtimes W^*} \circ (e_W \boxtimes 1_{A \boxtimes W^*}) \circ \underline{\mathcal{A}} \circ (1_{W^*} \boxtimes \underline{\mathcal{R}}_{A,W} \boxtimes 1_{W^*}) \circ \underline{\mathcal{A}} \circ (1_{W^* \boxtimes A} \boxtimes i_W) \circ \underline{L}_{W^* \boxtimes A}^{-1}. \end{aligned}$$

Since $\underline{\mathcal{R}}_{A,W} = \underline{\mathcal{R}}_{W,A}^{-1}$, we get $\underline{\mathcal{R}}_{W^*,A} = \underline{\mathcal{R}}_{A,W^*}^{-1}$ and thus $\mathcal{M}_{A,W^*} = 1_{A \boxtimes W^*}$. The proof for right duals is similar. \square

Now we examine the relations between $\text{Rep}^0 A$, the induction functor, and a twist on \mathcal{SC} (we recall the notion of a twist in the following definition). If \mathcal{SC} is a braided tensor category of modules for a vertex operator (super)algebra, then \mathcal{SC} has a twist given by $\theta_W = e^{2\pi i L_W(0)}$ for any module W in \mathcal{SC} .

Definition 2.79 (see [EGNO, Definition 8.10.1]). A *twist*, or *balancing transformation*, is an even natural automorphism θ of the identity functor on \mathcal{SC} which satisfies $\theta_{\mathbf{1}} = 1_{\mathbf{1}}$ and the *balancing equation*

$$\theta_{W_1 \boxtimes W_2} = \mathcal{M}_{W_1, W_2} \circ (\theta_{W_1} \boxtimes \theta_{W_2})$$

for all objects W_1, W_2 .

A twist θ is a *ribbon structure* if \mathcal{SC} is rigid and θ satisfies $(\theta_W)^* = \theta_{W^*}$ for all objects W .

Remark 2.80. In a ribbon category, left and right duals can be taken to be the same, so from now on, we shall omit references to right duals.

In the case of a vertex operator (super)algebra extension $V \subseteq A$, we have $L_V(0) = L_A(0)|_V$, so that the braided monoidal (super)category $\text{Rep}^0 A$ has a natural twist, provided each θ_W for W in $\text{Rep}^0 A$ is a morphism in $\text{Rep}^0 A$. This is shown in the following lemma under a mild condition on A :

Lemma 2.81 (see also [KO, Theorem 1.17(1)]). *Suppose \mathcal{SC} has a twist θ such that $\theta_A = 1_A$. Then an object (W, μ_W) of $\text{Rep} A$ is an object of $\text{Rep}^0 A$ if and only if $\theta_W \in \text{End}_{\text{Rep} A} W$. Moreover, θ satisfies*

$$\theta_{W_1 \boxtimes_A W_2} = \mathcal{M}_{W_1, W_2}^A \circ (\theta_{W_1} \boxtimes_A \theta_{W_2})$$

for objects W_1, W_2 in $\text{Rep}^0 A$. In particular, θ is a twist on $\text{Rep}^0 A$.

Proof. By definition, (W, μ_W) is an object of $\text{Rep}^0 A$ if and only if $\mu_W \circ \underline{\mathcal{R}}_{W,A} \circ \underline{\mathcal{R}}_{A,W} = \mu_W$. We have

$$\mu_W \circ \underline{\mathcal{R}}_{W,A} \circ \underline{\mathcal{R}}_{A,W} = \mu_W \circ \theta_{A \boxtimes W} \circ (\theta_A^{-1} \boxtimes \theta_W^{-1}) = \theta_W \circ \mu_W \circ (1_A \boxtimes \theta_W^{-1}),$$

where we have used the naturality of θ and $\theta_A = 1_A$ in the second equality. Hence, $\mu_W = \mu_W \circ \underline{\mathcal{R}}_{W,A} \circ \underline{\mathcal{R}}_{A,W}$ if and only if $\mu_W \circ (1_A \boxtimes \theta_W) = \theta_W \circ \mu_W$.

Now the second assertion follows using the diagrams:

$$\begin{array}{ccccc} W_1 \boxtimes W_2 & \xrightarrow{\theta_{W_1} \boxtimes \theta_{W_2}} & W_1 \boxtimes W_2 & \xrightarrow{\mathcal{M}_{W_1, W_2}} & W_1 \boxtimes W_2 & , & W_1 \boxtimes W_2 & \xrightarrow{\theta_{W_1} \boxtimes \theta_{W_2}} & W_1 \boxtimes W_2 \\ \downarrow \eta_{W_1, W_2} & & \downarrow \eta_{W_1, W_2} & & \downarrow \eta_{W_1, W_2} & & \downarrow \eta_{W_1, W_2} & & \downarrow \eta_{W_1, W_2} \\ W_1 \boxtimes_A W_2 & \xrightarrow{\theta_{W_1} \boxtimes_A \theta_{W_2}} & W_1 \boxtimes_A W_2 & \xrightarrow{\mathcal{M}_{W_1, W_2}^A} & W_1 \boxtimes_A W_2 & & W_1 \boxtimes_A W_2 & \xrightarrow{\theta_{W_1} \boxtimes_A \theta_{W_2}} & W_1 \boxtimes_A W_2 \end{array}$$

where the first square commutes by the definition of tensor product of morphisms in $\text{Rep} A$, since θ_{W_1} and θ_{W_2} are morphisms in $\text{Rep}^0 A$; the second square commutes by (2.28); and the last square commutes by the naturality of θ . Since the top rows of the two diagrams are equal, and since η_{W_1, W_2} is an epimorphism, the bottom rows are also equal. \square

Corollary 2.82. *Suppose \mathcal{SC} has a twist θ such that $\theta_A = 1_A$. If W is an object of \mathcal{SC} such that $\mathcal{F}(W)$ is an object of $\text{Rep}^0 A$, then $\mathcal{F}(\theta_W) = \theta_{\mathcal{F}(W)}$ as morphisms in $\text{Rep}^0 A$.*

Proof. By the previous lemma, $\mathcal{F}(\theta_W)$ and $\theta_{\mathcal{F}(W)}$ are morphisms in $\text{Rep}^0 A$. Then by Proposition 2.65,

$$\theta_{\mathcal{F}(W)} = \theta_{A \boxtimes W} = \mathcal{M}_{A, W} \circ (\theta_A \boxtimes \theta_W) = 1_A \boxtimes \theta_W = \mathcal{F}(\theta_W)$$

as required. \square

In ribbon categories, there is a natural notion of trace of an endomorphism:

Definition 2.83. The *trace* of a morphism $f : W \rightarrow W$ in a ribbon (super)category with ribbon structure θ is the morphism $\text{Tr}(f) \in \text{End}(\mathbf{1})$ given by the composition

$$\mathbf{1} \xrightarrow{i_W} W \boxtimes W^* \xrightarrow{(\theta_W \circ f) \boxtimes 1_{W^*}} W \boxtimes W^* \xrightarrow{\mathcal{R}_{W, W^*}} W^* \boxtimes W \xrightarrow{e_W} \mathbf{1}.$$

The trace of a morphism in a ribbon (super)category satisfies the following expected super-symmetry:

Proposition 2.84. *If $f : W_2 \rightarrow W_1$ and $g : W_1 \rightarrow W_2$ are parity-homogeneous morphisms in a ribbon (super)category, then*

$$\text{Tr}(f \circ g) = (-1)^{|f||g|} \text{Tr}(g \circ f).$$

Proof. We use the following diagrams in the proof:

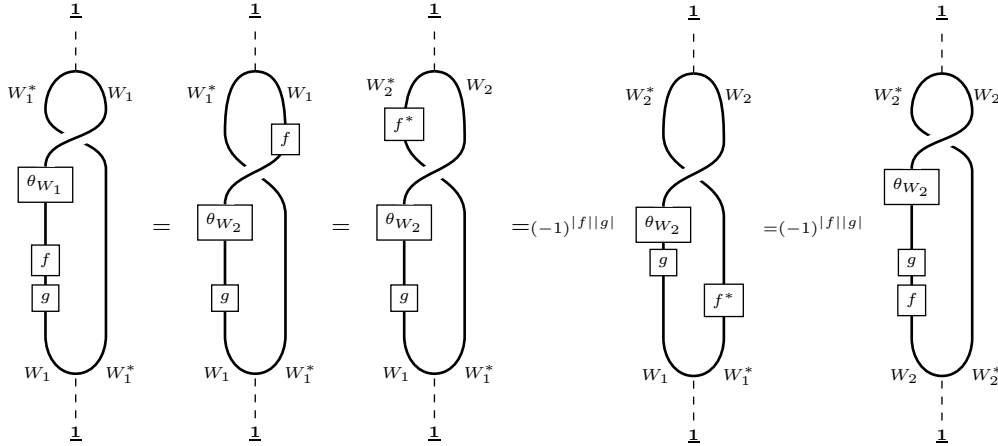

The first equality uses naturality of θ and the braiding, while the second and last use Proposition 2.75. The third equality uses the super interchange law (2.3). \square

Corollary 2.85. *If $f : W_1 \rightarrow W_1$ is a parity-homogeneous endomorphism in a ribbon (super)category and $g : W_2 \rightarrow W_1$ is a parity-homogeneous isomorphism, then*

$$\text{Tr}(g^{-1} \circ f \circ g) = (-1)^{|g|(|g|+|f|)} \text{Tr}(f).$$

Recall from Lemma 2.81 that if \mathcal{SC} has a twist θ such that $\theta_A = 1_A$, then θ also defines a twist on $\text{Rep}^0 A$. Moreover, if \mathcal{SC} is rigid and θ is a ribbon structure on \mathcal{SC} , Proposition 2.77 and Lemma 2.78 imply that the subcategory of induced objects in $\text{Rep}^0 A$ is rigid as well. In fact the subcategory of induced modules in $\text{Rep}^0 A$ is ribbon:

Proposition 2.86. *If \mathcal{SC} is a ribbon category with twist θ such that $\theta_A = 1_A$, then the induced objects in $\text{Rep}^0 A$ form a ribbon category.*

Proof. We just need to show that if $\mathcal{F}(W)$ is an induced object in $\text{Rep}^0 A$, with dual $(\mathcal{F}(W^*), \tilde{e}_W, \tilde{i}_W)$ as in Proposition 2.77, then $\theta_{\mathcal{F}(W)}^* = \theta_{\mathcal{F}(W^*)}$. To prove this, one first uses the definition of dual morphisms and a diagram similar to the one in the proof of Proposition 2.77 (more precisely, the corresponding commutative diagram for $\mathcal{F}(W^*)$), to show that $\theta_{\mathcal{F}(W)}^* = \mathcal{F}(\theta_W^*)$. Then because \mathcal{SC} is a ribbon category and using Corollary 2.82,

$$\mathcal{F}(\theta_W^*) = \mathcal{F}(\theta_{W^*}) = \theta_{\mathcal{F}(W^*)}$$

as required. \square

Now we can relate traces in \mathcal{SC} to traces in the ribbon category of induced objects in $\text{Rep}^0 A$:

Lemma 2.87. *Suppose \mathcal{SC} is a ribbon category with twist θ such that $\theta_A = 1_A$. If W is an object of \mathcal{SC} such that $\mathcal{F}(W)$ is an object of $\text{Rep}^0 A$ and if $f \in \text{End}(W)$, then*

$$\text{Tr}(\mathcal{F}(f)) = \varphi \circ \mathcal{F}(\text{Tr}(f)) \circ \varphi^{-1},$$

recalling the isomorphism $\varphi : \mathcal{F}(\mathbf{1}) \rightarrow A$ of Theorem 2.59.

Proof. Consider the diagram

$$\begin{array}{ccc}
\mathcal{F}(\mathbf{1}) & \xrightarrow{\varphi} & A \\
\downarrow \mathcal{F}(i_W) & & \downarrow \tilde{i}_{\mathcal{F}(W)} \\
\mathcal{F}(W \boxtimes W^*) & \xrightarrow{f_{W,W^*}} & \mathcal{F}(W) \boxtimes_A \mathcal{F}(W^*) \\
\downarrow \mathcal{F}((\theta_W \circ f) \boxtimes 1_{W^*}) & & \downarrow (\theta_{\mathcal{F}(W)} \circ \mathcal{F}(f)) \boxtimes_A 1_{\mathcal{F}(W^*)} \\
\mathcal{F}(W \boxtimes W^*) & \xrightarrow{f_{W,W^*}} & \mathcal{F}(W) \boxtimes_A \mathcal{F}(W^*) \\
\downarrow \mathcal{F}(\mathcal{R}_{W,W^*}) & & \downarrow \mathcal{R}_{\mathcal{F}(W),\mathcal{F}(W^*)}^A \\
\mathcal{F}(W^* \boxtimes W) & \xrightarrow{f_{W^*,W}} & \mathcal{F}(W^*) \boxtimes_A \mathcal{F}(W) \\
\downarrow \mathcal{F}(e_W) & & \downarrow \tilde{e}_W \\
\mathcal{F}(\mathbf{1}) & \xrightarrow{\varphi} & A
\end{array}$$

The top and bottom squares commute by the definitions of $\tilde{i}_{\mathcal{F}(W)}$ and $\tilde{e}_{\mathcal{F}(W)}$ (recall Proposition 2.77). The second square commutes because f is a natural isomorphism and because

$$\mathcal{F}(\theta_W \circ f) = \mathcal{F}(\theta_W) \circ \mathcal{F}(f) = \theta_{\mathcal{F}(W)} \circ \mathcal{F}(f)$$

(recall Corollary 2.82). Also the third square commutes by Theorem 2.67. Now the proposition follows because the left column of the diagram is $\mathcal{F}(\text{Tr}(f))$ while the right column is $\text{Tr}(\mathcal{F}(f))$. \square

The results presented so far in this subsection build up to the final result which shows how induction relates categorical S -matrices in \mathcal{SC} and $\text{Rep}^0 A$, provided \mathcal{SC} and the subcategory of induced objects in $\text{Rep}^0 A$ are both ribbon categories:

Definition 2.88. For objects W_1 and W_2 of a ribbon category, the S^∞ -matrix is $S_{W_1, W_2}^\infty = \text{Tr}(\mathcal{M}_{W_1, W_2})$.

Theorem 2.89. Suppose \mathcal{SC} is a ribbon category with twist θ such that $\theta_A = 1_A$. Then for objects W_1 and W_2 of \mathcal{SC} such that $\mathcal{F}(W_1)$ and $\mathcal{F}(W_2)$ are objects in $\text{Rep}^0 A$,

$$S_{\mathcal{F}(W_1), \mathcal{F}(W_2)}^\infty = \varphi \circ \mathcal{F}(S_{W_1, W_2}^\infty) \circ \varphi^{-1}.$$

Proof. We calculate

$$\begin{aligned}
\varphi \circ \mathcal{F}(S_{W_1, W_2}^\infty) \circ \varphi^{-1} &= \varphi \circ \mathcal{F}(\text{Tr}(\mathcal{M}_{W_1, W_2})) \circ \varphi^{-1} = \text{Tr}(\mathcal{F}(\mathcal{M}_{W_1, W_2})) \\
&= \text{Tr}(\mathcal{M}_{\mathcal{F}(W_1), \mathcal{F}(W_2)}^A) = S_{\mathcal{F}(W_1), \mathcal{F}(W_2)}^\infty,
\end{aligned}$$

using Lemma 2.87, Corollary 2.68, and Corollary 2.85. \square

3 Vertex tensor categories

The goal of this section is to interpret the abstract categorical constructions of the previous section in the vertex operator algebra context. As shown in [HKL, CKL], a vertex operator (super)algebra extension $V \subseteq A$ amounts to a (super)algebra in a braided tensor category of V -modules. In this context, the category $\text{Rep}^0 A$ of local A -modules recalled in the previous section agrees (as categories) with the category of modules for the vertex operator algebra A (see [HKL]). Our main result in this section is that in fact these two categories agree as braided monoidal categories, where the category of vertex-algebraic A -modules has the braided monoidal category structure of [HLZ8]. As a consequence, all the tensor-categorical constructions and results of Section 2, especially the induction functor, apply naturally to the vertex-algebraic setting. We start this section with a discussion of the basic definitions and constructions of vertex tensor category theory before moving on to the main results. In particular, we include a discussion of the natural superalgebra generalization of the vertex tensor category constructions in [HLZ8] and show how these agree with the braided monoidal supercategory structure on $\text{Rep}^0 A$ when A is a vertex operator superalgebra extension of a vertex operator algebra V .

3.1 Modules and intertwining operators

We are interested in extensions $V \subseteq A$ where V is an ordinary \mathbb{Z} -graded vertex operator algebra and A is one of the following four possibilities:

1. A \mathbb{Z} -graded vertex operator algebra,
2. A \mathbb{Z} -graded vertex operator superalgebra,
3. A $\frac{1}{2}\mathbb{Z}$ -graded vertex operator algebra, or
4. A $\frac{1}{2}\mathbb{Z}$ -graded vertex operator superalgebra.

For the notion of (\mathbb{Z} -graded) vertex operator algebra $(V, Y, \mathbf{1}, \omega)$ and corresponding notation, see for instance [FLM, FHL, LL]. The definition of $\frac{1}{2}\mathbb{Z}$ -graded vertex operator algebra is exactly the same, except that half-integral conformal weights are allowed; quantum Hamiltonian reduction [KRW, KW1] is a prominent source of $\frac{1}{2}\mathbb{Z}$ -graded vertex operator algebras, including the Bershadsky-Polyakov algebra discussed in Section 4.4.3 below.

For the notion of vertex operator superalgebra, see for instance [DLe, Xu2, Li2]. Since slightly variant definitions of vertex operator superalgebra exist in the literature, let us clarify what we mean by this term. For us, a vertex operator superalgebra V has a parity decomposition $V^{\bar{0}} \oplus V^{\bar{1}}$ as well as typically a second $\mathbb{Z}/2\mathbb{Z}$ -grading coming from the conformal weight $\frac{1}{2}\mathbb{Z}$ -grading: $V = V_+ \oplus V_-$ where

$$V_+ = \bigoplus_{n \in \mathbb{Z}} V_n \quad \text{and} \quad V_- = \bigoplus_{n \in \mathbb{Z}} V_{n+\frac{1}{2}}.$$

In this section, we will not assume that these two $\mathbb{Z}/2\mathbb{Z}$ -gradings are the same; in fact, one could be trivial and the other not, yielding the possibilities of \mathbb{Z} -graded vertex operator superalgebra and $\frac{1}{2}\mathbb{Z}$ -graded vertex operator algebra. In any case, the vacuum and conformal vector of V are assumed even in both senses ($\mathbf{1}, \omega \in V^{\bar{0}} \cap V_+$) and the vertex operator Y is even with respect to both $\mathbb{Z}/2\mathbb{Z}$ -gradings. This means that the involutions $P_V = 1_{V^{\bar{0}}} \oplus (-1_{V^{\bar{1}}})$ (the *parity involution*) and $\theta_V = 1_{V_+} \oplus (-1_{V_-}) = e^{2\pi i L(0)}$ (the *twist*) are vertex operator superalgebra automorphisms. For a parity-homogeneous element v of a vertex operator superalgebra V , we use $|v| \in \mathbb{Z}/2\mathbb{Z}$ to denote the parity of v .

Since all four possibilities for an extended algebra that we shall consider are special cases of $\frac{1}{2}\mathbb{Z}$ -graded vertex operator superalgebra (where both, one, or none of $V^{\bar{1}}$ and V_- are zero), in this and the next two subsections, we will fix a $\frac{1}{2}\mathbb{Z}$ -graded vertex operator superalgebra V . Later, in Section 3.4 where we begin specifically studying extensions, we will take V to be a \mathbb{Z} -graded vertex operator algebra and A to be a $\frac{1}{2}\mathbb{Z}$ -graded superalgebra. The modules for a vertex operator superalgebra that we will consider fall in the following class (see for instance [HLZ1] for the vertex operator algebra case):

Definition 3.1. A *grading-restricted generalized V -module* is a \mathbb{C} -graded superspace

$$W = \bigoplus_{i \in \mathbb{Z}/2\mathbb{Z}} W^i = \bigoplus_{h \in \mathbb{C}} W_{[h]}$$

(graded by *parity* and *conformal weights*) equipped with a *vertex operator*

$$Y_W : V \otimes W \rightarrow W[[x, x^{-1}]]$$

$$v \otimes w \mapsto Y_W(v, x)w = \sum_{n \in \mathbb{Z}} v_n w x^{-n-1}$$

such that the following axioms hold:

1. *Grading compatibility:* For $i = \bar{0}, \bar{1}$, $W^i = \bigoplus_{h \in \mathbb{C}} W_{[h]}^i$, where $W_{[h]}^i = W^i \cap W_{[h]}$.
2. *The grading restriction conditions:* For any $h \in \mathbb{C}$, $W_{[h]}$ is finite dimensional and $W_{[h+n]} = 0$ for $n \in \mathbb{Z}$ sufficiently negative.
3. *Evenness of the vertex operator:* For any $v \in V^i$ and $w \in W^j$, $i, j \in \mathbb{Z}/2\mathbb{Z}$, $Y_W(v, x)w \in W^{i+j}[[x, x^{-1}]]$.
4. *Lower truncation:* For any $v \in V$ and $w \in W$, $v_n w = 0$ for n sufficiently positive, that is, $Y_W(v, x)w \in W((x))$.
5. *The vacuum property:* $Y_W(\mathbf{1}, x) = 1_W$.

6. The *Jacobi identity*: For any parity-homogeneous $u, v \in V$,

$$\begin{aligned} x_0^{-1} \delta \left(\frac{x_1 - x_2}{x_0} \right) Y_W(u, x_1) Y_W(v, x_2) - (-1)^{|u||v|} x_0^{-1} \delta \left(\frac{-x_2 + x_1}{x_0} \right) Y_W(v, x_2) Y_W(u, x_1) \\ = x_2^{-1} \delta \left(\frac{x_1 - x_0}{x_2} \right) Y_W(Y(u, x_0)v, x_2). \end{aligned}$$

7. The Virasoro algebra properties: If we write $Y_W(\omega, x) = \sum_{n \in \mathbb{Z}} L(n)x^{-n-2}$, then

$$[L(m), L(n)] = (m - n)L(m + n) + \frac{m^3 - m}{12} \delta_{m+n, 0} c$$

where c is the central charge of V . Moreover, for any $h \in \mathbb{C}$, $W_{[h]}$ is the generalized eigenspace of $L(0)$ with generalized eigenvalue h .

8. The $L(-1)$ -*derivative property*: For any $v \in V$,

$$Y_W(L(-1)v, x) = \frac{d}{dx} Y_W(v, x).$$

If (W_1, Y_{W_1}) and (W_2, Y_{W_2}) are grading-restricted generalized V -modules, then a *parity-homogeneous homomorphism* $f : W_1 \rightarrow W_2$ is a parity-homogeneous linear map which satisfies

$$f(Y_{W_1}(v, x)w_1) = (-1)^{|f||v|} Y_{W_2}(v, x)f(w_1)$$

for $w_1 \in W_1$ and parity-homogeneous $v \in V$. A *homomorphism* $f : W_1 \rightarrow W_2$ is any sum of an even and an odd homomorphism.

Remark 3.2. We do not require homomorphisms between grading-restricted generalized modules to be even. In fact, homomorphisms between V -modules W_1 and W_2 form a superspace. Note that some references (for example [Li2]) do not include the sign factor in the definition of V -module homomorphism, even when odd homomorphisms are allowed. However, the sign factor is natural in light of the general superalgebra principle that a sign factor should occur whenever the order of two entities with parity is reversed. Moreover, this sign factor is necessary for the notion of superalgebra module homomorphism to agree with the notion of Rep A -morphism from Section 2 in the context of a superalgebra extension $V \subseteq A$. (Recall the parity factor in the definition of tensor product of morphisms in \mathcal{SC} from Section 2.2.)

Remark 3.3. If (W, Y_W) is a grading-restricted generalized V -module, then $(\Pi(W), Y_{\Pi(W)})$ is as well, where $\Pi(W) = W$ with reversed parity decomposition: $\Pi(W)^i = W^{i+1}$ for $i = \bar{0}, \bar{1}$, and with $Y_{\Pi(W)} = Y_W$. Because Y_W is even, the parity involution $P_W = 1_{W^{\bar{0}}} \oplus (-1_{W^{\bar{1}}})$ on W is an odd V -module isomorphism between W and $\Pi(W)$.

Notation 3.4. From now on, we will typically use *module* to mean a grading-restricted generalized module. Also, for a parity-homogeneous element w in a V -module, we will denote the parity of w by $|w|$.

If (W, Y_W) is a V -module, then the *contragredient module* is the *graded dual*

$$W' = \bigoplus_{h \in \mathbb{C}} W_{[h]}^*$$

with parity decomposition $(W')^i = \bigoplus_{h \in \mathbb{C}} (W_{[h]}^i)^*$ for $i = \bar{0}, \bar{1}$. Since V is $\frac{1}{2}\mathbb{Z}$ -graded, there are two natural choices for the vertex operator $Y_{W'}$:

$$\langle Y_{W'}^\pm(v, x)w', w \rangle_W = (-1)^{|v||w'|} \langle w', Y_W(e^{\pm\pi i} x^{-2})^{L(0)} v, x^{-1} w \rangle_W, \quad (3.1)$$

for $w \in W$ and parity-homogeneous $v \in V$, $w' \in W'$, where $\langle \cdot, \cdot \rangle_W$ is the natural bilinear pairing between W and its graded dual. The proof that $Y_{W'}^\pm$ give V -module structures on W' is an easy superalgebra generalization of the proof for the vertex operator algebra case in [FHL]. Since $Y_{W'}^+(v, x) = Y_{W'}^-(\theta_V(v), x)$ for $v \in V$, the twist $\theta_{W'} = e^{2\pi i L_{W'}(0)}$ is an isomorphism between $(W', Y_{W'}^+)$ and $(W', Y_{W'}^-)$ (due to the general fact that for any V -module W , $\theta_W(Y_W(v, x)w) = Y_W(\theta_V(v), x)\theta_W(w)$ for $v \in V$, $w \in W$; see for instance [HLZ2, Equation 3.86]). Note that $\theta_{W'} = e^{2\pi i L_{W'}(0)}$ is well defined: because ω is even with integer conformal weight, $L_{W'}(0)$ is independent of the vertex operator structure on W' .

Remark 3.5. There are further V -module structures on W' appearing in the literature. For example, the definition in [Xu2] replaces the $(-1)^{|v||w'|}$ factor in (3.1) with $(-1)^{|v||w|}$. These structures are isomorphic to the ones in (3.1) via the parity automorphism $P_{W'} = 1_{(W')\bar{0}} \oplus (-1)_{(W')\bar{1}}$. More structures occur in [Li2, Ya3] where the $(-1)^{|v||w'|}$ factor in (3.1) is replaced by $e^{\pm\pi i|v|/2}$. These structures are equivalent to (3.1) via certain square roots of the parity involution on W' : $1_{(W')\bar{0}} \oplus (\pm i)1_{(W')\bar{1}}$.

Remark 3.6. The Jacobi identity in the definition of grading-restricted generalized V -module can be replaced with the following commutativity and associativity axiom: for any $w \in W$, $w' \in W'$, and parity-homogeneous $u, v \in V$, the series

$$\langle w', Y_W(u, z_1)Y_W(v, z_2)w \rangle_W$$

for $|z_1| > |z_2| > 0$,

$$(-1)^{|u||v|} \langle w', Y_W(v, z_2)Y_W(u, z_1)w \rangle_W$$

for $|z_2| > |z_1| > 0$, and

$$\langle w', Y_W(Y(u, z_1 - z_2)v, z_2)w \rangle_W$$

for $|z_2| > |z_1 - z_2| > 0$ converge absolutely to a common rational function on their respective domains.

We now recall the definition of (logarithmic) intertwining operator (from, for instance, [HLZ2] in the vertex operator algebra setting):

Definition 3.7. Suppose W_1, W_2 and W_3 are modules for a vertex operator superalgebra V . A *parity-homogeneous intertwining operator* of type $\binom{W_3}{W_1 W_2}$ is a parity-homogeneous linear map

$$\begin{aligned} \mathcal{Y} : W_1 \otimes W_2 &\rightarrow W_3[\log x]\{x\}, \\ w_1 \otimes w_2 &\mapsto \mathcal{Y}(w_1, x)w_2 = \sum_{n \in \mathbb{C}} \sum_{k \in \mathbb{N}} (w_1)_{n;k}^{\mathcal{Y}} w_2 x^{-n-1} (\log x)^k \in W_3[\log x]\{x\} \end{aligned}$$

satisfying the following conditions:

1. *Lower truncation:* For any $w_1 \in W_1$, $w_2 \in W_2$ and $n \in \mathbb{C}$,

$$(w_1)_{n+m;k}^{\mathcal{Y}} w_2 = 0 \quad \text{for } m \in \mathbb{N} \text{ sufficiently large, independently of } k. \quad (3.2)$$

2. *The Jacobi identity:*

$$\begin{aligned} (-1)^{|\mathcal{Y}||v|} x_0^{-1} \delta \left(\frac{x_1 - x_2}{x_0} \right) Y_{W_3}(v, x_1) \mathcal{Y}(w_1, x_2) &- (-1)^{|v||w_1|} x_0^{-1} \delta \left(\frac{x_2 - x_1}{-x_0} \right) \mathcal{Y}(w_1, x_2) Y_{W_2}(v, x_1) \\ &= x_2^{-1} \delta \left(\frac{x_1 - x_0}{x_2} \right) \mathcal{Y}(Y_{W_1}(v, x_0)w_1, x_2) \end{aligned} \quad (3.3)$$

for parity-homogeneous $v \in V$ and $w_1 \in W_1$.

3. *The $L(-1)$ -derivative property:* for any $w_1 \in W_1$,

$$\mathcal{Y}(L(-1)w_1, x) = \frac{d}{dx} \mathcal{Y}(w_1, x). \quad (3.4)$$

An *intertwining operator* of type $\binom{W_3}{W_1 W_2}$ is any sum of an even and an odd intertwining operator.

Remark 3.8. We use $\mathcal{V}_{W_1, W_2}^{W_3}$ to denote the superspace of intertwining operators of type $\binom{W_3}{W_1 W_2}$; the dimension and superdimension of $\mathcal{V}_{W_1, W_2}^{W_3}$ are the corresponding *fusion rules*:

$$N_{W_1, W_2}^{\pm W_3} = \dim \left(\mathcal{V}_{W_1, W_2}^{W_3} \right)^{\bar{0}} \pm \dim \left(\mathcal{V}_{W_1, W_2}^{W_3} \right)^{\bar{1}}.$$

By slight generalizations (for the possibility of non-even intertwining operators) of [HL3, Proposition 7.1], [Xu2, Theorem 4.1], [Li2, Proposition 3.3.2], [HLZ2, Proposition 3.44], we have for any V -modules W_1, W_2 , and W_3 and $r \in \mathbb{Z}$ an even isomorphism $\Omega_r : \mathcal{V}_{W_1, W_2}^{W_3} \rightarrow \mathcal{V}_{W_2, W_1}^{W_3}$ given by

$$\Omega_r(\mathcal{Y})(w_2, x)w_1 = (-1)^{|w_1||w_2|} e^{xL(-1)} \mathcal{Y}(w_1, e^{(2r+1)\pi i} x)w_2$$

for $\mathcal{Y} \in \mathcal{V}_{W_1, W_2}^{W_3}$ and parity-homogeneous $w_1 \in W_1, w_2 \in W_2$. The inverse of Ω_r is Ω_{-r-1} . When $\mathcal{Y} = Y_W$ is a module vertex operator, $\Omega_r(Y_W)$ is independent of r since $Y_W(\cdot, x) \cdot$ involves only integral powers of

x . In this case, we drop the subscript r on Ω and use the notation $\Omega(Y_W)$. By generalizations of [HL3, Proposition 7.3], [Xu2, Theorem 4.4], [Li2, Proposition 3.3.4], [HLZ2, Proposition 3.46], we also have for any $r \in \mathbb{Z}$ an even linear isomorphism $A_r : \mathcal{V}_{W_1 W_2}^{W_3} \rightarrow \mathcal{V}_{W_1 W'_3}^{W'_2}$ given by

$$\langle A_r(\mathcal{Y})(w_1, x)w'_3, w_2 \rangle_{W_2} = (-1)^{(|\mathcal{Y}|+|w_1|)|w'_3|} \langle w'_3, \mathcal{Y}(e^{xL(1)}(e^{(2r+1)\pi i}x^{-2})^{L(0)}w_1, x^{-1})w_2 \rangle_{W_3}$$

for $w_2 \in W_2$ and parity-homogeneous $\mathcal{Y} \in \mathcal{V}_{W_1 W_2}^{W_3}$, $w_1 \in W_1$, and $w'_3 \in W'_3$. The inverse of A_r is A_{-r-1} . A consequence of these isomorphisms is that the fusion rules $N_{W_i, W_j}^{\pm W'_k}$ for any permutation (i, j, k) of $(1, 2, 3)$ are equal.

Let us now fix a full subcategory \mathcal{C} of V -modules. In order to apply the vertex tensor category theory of [HLZ1]-[HLZ8] to \mathcal{C} , we will need to impose a number of conditions on \mathcal{C} . The following conditions come from Assumption 10.1 in [HLZ6], and more assumptions will be clarified later:

Assumption 3.9. All modules in \mathcal{C} are \mathbb{R} -graded by conformal weights, and for any module $W = \bigoplus_{n \in \mathbb{R}} W_{[n]}$ in \mathcal{C} , there is some $K \in \mathbb{Z}_+$ such that $(L(0) - n)^K \cdot W_{[n]} = 0$ for all $n \in \mathbb{R}$.

Remark 3.10. The assumption that modules in \mathcal{C} are \mathbb{R} -graded by conformal weights can be modified somewhat; see for instance [Hu10].

Remark 3.11. The assumption that the possible Jordan block sizes of $L(0)$ acting on conformal weight spaces are uniformly bounded for each V -module W in \mathcal{C} implies that for any intertwining operator \mathcal{Y} of type $\binom{W_3}{W_1 W_2}$ in \mathcal{C} , there is some $K \in \mathbb{N}$ depending on W_1, W_2 , and W_3 such that

$$\mathcal{Y}(w_1, x)w_2 = \sum_{n \in \mathbb{R}} \sum_{k=0}^K (w_1)_{n;k}^{\mathcal{Y}} w_2 x^{-n-1} (\log x)^k$$

for any $w_1 \in W_1$ and $w_2 \in W_2$. That is, finitely many powers of $\log x$ appear in the expansion of $\mathcal{Y}(w_1, x)w_2$ independently of w_1 and w_2 . (See Proposition 3.20 in [HLZ2].)

3.2 Multivalued functions, intertwining maps, and compositions of intertwining operators

In this subsection, we recall the notion of $P(z)$ -intertwining map among V -modules for $z \in \mathbb{C}^\times$ and discuss assumptions and properties of our category \mathcal{C} of V -modules related to convergence of multivalued functions defined using compositions of intertwining operators.

We first fix some notation that we will use throughout this section for branches of logarithm. For any $z \in \mathbb{C}^\times$, we use the notation

$$\log z = \log |z| + i \arg z,$$

where $0 \leq \arg z < 2\pi$, to denote the principal branch of logarithm on \mathbb{C}^\times with a cut along the positive real axis. More generally, we use the notation

$$l_p(z) = \log z + 2\pi ip$$

for any $p \in \mathbb{Z}$, so that $\log z = l_0(z)$. For branches of logarithm with a cut along the negative real axis, we use the notation $l_{p-1/2}(z)$ for $p \in \mathbb{Z}$ to denote the branch with

$$(2p-1)\pi i \leq \text{Im } l_{p-1/2}(z) < (2p+1)\pi i.$$

For a formal series $f(x) \in W[\log x]\{x\}$, where W is some superspace, we use the notation

$$f(e^{l_p(z)}) = f(x)|_{x^n = e^{n l_p(z)}, \log x = l_p(z)}$$

for any $p \in \frac{1}{2}\mathbb{Z}$ to denote the (not necessarily convergent in any sense) series obtained by substituting x with z using the branch $l_p(z)$ of logarithm. We use similar notation for substituting formal variables with complex numbers in multivariable formal series.

We will need to consider multivalued functions of several complex variables in what follows, so we discuss some terminology and properties of multivalued functions here. Recall that a multivalued function f defined on a connected set $U \subseteq \mathbb{C}^n$, $n \in \mathbb{Z}_+$, is *analytic* if for any $(z_1, \dots, z_n) \in U$, any value of $f(z_1, \dots, z_n)$ is the value at (z_1, \dots, z_n) of a single-valued analytic branch of f defined on a simply-connected open neighborhood of (z_1, \dots, z_n) . If f is a multivalued analytic function on a connected open set $U \subseteq \mathbb{C}^n$ and $\tilde{U} \subseteq U$ is a connected open subset, we say that \tilde{f} is a *restriction* of f to \tilde{U} if the values

of $\tilde{f}(z_1, \dots, z_n)$ for $(z_1, \dots, z_n) \in \tilde{U}$ are a subset of the values of $f(z_1, \dots, z_n)$, and if any two values of \tilde{f} at any two points in \tilde{U} can be obtained from each other by analytic continuation along a continuous path in \tilde{U} .

We say that two multivalued functions f_1 and f_2 on an open set $U \subseteq \mathbb{C}^n$ are equal if for any simply-connected open set $\tilde{U} \subseteq U$ and any single-valued branch \tilde{f}_1 of f_1 on \tilde{U} , there is a single-valued branch \tilde{f}_2 of f_2 on \tilde{U} which equals \tilde{f}_1 .

Proposition 3.12. *Suppose f_1 and f_2 are multivalued analytic functions defined on connected open sets $U_1, U_2 \subseteq \mathbb{C}^n$, respectively. Then f_1 and f_2 have equal restrictions to an open connected subset $\tilde{U} \subseteq U_1 \cap U_2$ if for some particular non-empty simply-connected open set $U' \subseteq \tilde{U}$ and some particular single-valued branch f'_1 of f_1 on U' , there is a single-valued branch f'_2 of f_2 on U' which equals f'_1 .*

Proof. Fix $(z'_1, \dots, z'_n) \in U'$, and consider the restrictions \tilde{f}_1 of f_1 and \tilde{f}_2 of f_2 to \tilde{U} whose values at any point $(z_1, \dots, z_n) \in \tilde{U}$ are obtained by analytic continuation of f'_1 and f'_2 , respectively, along continuous paths in \tilde{U} from (z'_1, \dots, z'_n) to (z_1, \dots, z_n) . To see that \tilde{f}_1 and \tilde{f}_2 are equal, suppose U'' is any non-empty simply-connected open subset of \tilde{U} and f''_1 is any single-valued branch of \tilde{f}_1 on U'' . Now, f''_1 is completely determined by its values in a simply-connected neighborhood of some fixed $(z''_1, \dots, z''_n) \in U''$, and these values can be obtained by analytic continuation of the branch f'_1 along some continuous path in \tilde{U} from (z'_1, \dots, z'_n) to (z''_1, \dots, z''_n) . Then we can analytically continue f'_2 along the same path to obtain a single-valued branch f''_2 of \tilde{f}_2 on U'' which is equal to f''_1 . Since U' and f'_1 are arbitrary, this proves that $\tilde{f}_1 = \tilde{f}_2$. \square

For a formal series $f(x) \in \mathbb{C}[\log x]\{x\}$ which converges absolutely on some open set in \mathbb{C} when the formal variable x is replaced by a complex number z using any branch of logarithm, we use the notation $f(z)$ to denote the corresponding multivalued function. We use similar notation for multivariable formal series.

The multivalued analytic functions that we will consider arise from composing intertwining operators, or more precisely intertwining maps, among V -modules in our category \mathcal{C} . We now give the superalgebra generalization of the notion of $P(z)$ -intertwining map among V -modules for $z \in \mathbb{C}^\times$ from [HL2, HLZ3]. Here, the notation “ $P(z)$ ” stands for a Riemann sphere with a negatively oriented puncture at ∞ with local coordinate $w \mapsto 1/w$, and positively oriented punctures at z and 0 with local coordinates $w \mapsto w - z$ and $w \mapsto w$, respectively. First, if

$$W = \bigoplus_{h \in \mathbb{C}} W_{[h]}$$

is a \mathbb{C} -graded superspace (such as a V -module), then the *algebraic completion* of W is the superspace

$$\overline{W} = \prod_{h \in \mathbb{C}} W_{[h]},$$

where $\overline{W}^i = \overline{W}^{\bar{i}}$ for $i = \bar{0}, \bar{1}$. For any $h \in \mathbb{C}$, we use π_h to denote the canonical even projection $\overline{W} \rightarrow W_{[h]}$. It is easy to see that $\overline{W} = (W')^*$.

Definition 3.13. Suppose W_1, W_2 , and W_3 are modules in \mathcal{C} and $z \in \mathbb{C}^\times$. A *parity-homogeneous $P(z)$ -intertwining map* of type $\binom{W_3}{W_1 W_2}$ is a parity-homogeneous linear map

$$I : W_1 \otimes W_2 \rightarrow \overline{W_3}$$

satisfying the following conditions:

1. *Lower truncation:* For any $w_1 \in W_1, w_2 \in W_2$ and $n \in \mathbb{C}$,

$$\pi_{n-m}(I(w_1 \otimes w_2)) = 0 \quad \text{for } m \in \mathbb{N} \text{ sufficiently large.} \quad (3.5)$$

2. The *Jacobi identity*:

$$\begin{aligned} (-1)^{|I||v|} x_0^{-1} \delta \left(\frac{x_1 - z}{x_0} \right) Y_{W_3}(v, x_1) I(w_1 \otimes w_2) - (-1)^{|v||w_1|} x_0^{-1} \delta \left(\frac{z - x_1}{-x_0} \right) I(w_{(1)} \otimes Y_{W_2}(v, x_1) w_2) \\ = z^{-1} \delta \left(\frac{x_1 - x_0}{z} \right) I(Y_{W_1}(v, x_0) w_1 \otimes w_2) \end{aligned} \quad (3.6)$$

for $w_2 \in W_2$ and parity-homogeneous $v \in V, w_1 \in W_1$.

A $P(z)$ -intertwining map of type $\binom{W_3}{W_1 W_2}$ is any sum of an even and an odd $P(z)$ -intertwining map.

Remark 3.14. We use $\mathcal{M}[P(z)]_{W_1 W_2}^{W_3}$, or simply $\mathcal{M}_{W_1 W_2}^{W_3}$ if z is clear, to denote the superspace of $P(z)$ -intertwining maps of type $\binom{W_3}{W_1 W_2}$.

The definitions suggest that a $P(z)$ -intertwining map is essentially an intertwining operator with the formal variable x specialized to the complex number z . In fact, generalizing Proposition 4.8 in [HLZ3] to the superalgebra setting, we have:

Proposition 3.15. *For any $p \in \mathbb{Z}$, there is an even linear isomorphism $\mathcal{V}_{W_1 W_2}^{W_3} \rightarrow \mathcal{M}_{W_1 W_2}^{W_3}$ given by*

$$\mathcal{Y} \mapsto I_{\mathcal{Y}, p},$$

where

$$I_{\mathcal{Y}, p}(w_1 \otimes w_2) = \mathcal{Y}(w_1, e^{lp(z)})w_2$$

for $w_1 \in W_1$ and $w_2 \in W_2$. The inverse is given by

$$I \mapsto \mathcal{Y}_{I, p}$$

where

$$\mathcal{Y}_{I, p}(w_1, x)w_2 = \left(\frac{e^{lp(z)}}{x}\right)^{-L(0)} I \left(\left(\frac{e^{lp(z)}}{x}\right)^{L(0)} w_1 \otimes \left(\frac{e^{lp(z)}}{x}\right)^{L(0)} w_2 \right)$$

for $w_1 \in W_1$ and $w_2 \in W_2$.

Remark 3.16. We could construct an isomorphism as in Proposition 3.15 for $p \in \mathbb{Z} + \frac{1}{2}$ as well, but we will not need this.

We now impose the assumption that products and iterates of intertwining maps among modules in \mathcal{C} satisfy the convergence condition of Proposition 7.3 and Definition 7.4 in [HLZ5]:

Assumption 3.17. Suppose W_1, W_2, W_3, W_4 , and M_1 are modules in \mathcal{C} , I_1 is a $P(z_1)$ -intertwining map of type $\binom{W_4}{W_1 M_1}$, and I_2 is a $P(z_2)$ -intertwining map of type $\binom{M_1}{W_2 W_3}$. Then if $|z_1| > |z_2| > 0$, the series

$$\langle w'_4, I_1(w_1 \otimes I_2(w_2 \otimes w_3)) \rangle = \sum_{n \in \mathbb{R}} \langle w'_4, I_1(w_1 \otimes \pi_n(I_2(w_2 \otimes w_3))) \rangle$$

converges absolutely for any $w_1 \in W_1, w_2 \in W_2, w_3 \in W_3$, and $w'_4 \in W'_4$. Moreover, suppose M_2 is another module in \mathcal{C} , I^1 is a $P(z_2)$ -intertwining map of type $\binom{W_4}{M_2 W_3}$, and I^2 is a $P(z_0)$ -intertwining map of type $\binom{M_2}{W_1 W_2}$. Then if $|z_2| > |z_0| > 0$, the series

$$\langle w'_4, I^1(I^2(w_1 \otimes w_2) \otimes w_3) \rangle = \sum_{n \in \mathbb{R}} \langle w'_4, I^1(\pi_n(I^2(w_1 \otimes w_2)) \otimes w_3) \rangle$$

converges absolutely for any $w_1 \in W_1, w_2 \in W_2, w_3 \in W_3$, and $w'_4 \in W'_4$.

The isomorphism in Proposition 3.15 implies that products and iterates of intertwining operators, with formal variables specialized to complex numbers in the appropriate domain using any branch of logarithm, converge absolutely. In fact, a product of intertwining operators of the form

$$\langle w'_4, \mathcal{Y}_1(w_1, z_1) \mathcal{Y}_2(w_2, z_2) w_3 \rangle$$

defines a multivalued analytic function on the domain $|z_1| > |z_2| > 0$, and an iterate of intertwining operators of the form

$$\langle w'_4, \mathcal{Y}^1(\mathcal{Y}^2(w_1, z_0) w_2, z_2) w_3 \rangle$$

defines a multivalued analytic function on the domain $|z_2| > |z_0| > 0$ (see Proposition 7.14 in [HLZ5]). If we set $z_0 = z_1 - z_2$, the product and iterate restrict to multivalued analytic functions on the intersection $|z_1| > |z_2| > |z_1 - z_2| > 0$.

We conclude this subsection with two propositions we shall use later to conclude that multivalued functions given by products and iterates of intertwining operators are equal. First we introduce two useful non-empty simply-connected open sets $S_1, S_2 \subseteq \mathbb{C}^2$ that were used to study branches of products and iterates of intertwining operators in [Ch]:

$$S_1 = \{(z_1, z_2) \in \mathbb{C}^2 \mid \operatorname{Re} z_1 > \operatorname{Re} z_2 > \operatorname{Re}(z_1 - z_2) > 0, \operatorname{Im} z_1 > \operatorname{Im} z_2 > \operatorname{Im}(z_1 - z_2) > 0\}$$

and

$$S_2 = \{(z_1, z_2) \in \mathbb{C}^2 \mid \operatorname{Re} z_2 > \operatorname{Re} z_1 > \operatorname{Re}(z_2 - z_1) > 0, \operatorname{Im} z_2 > \operatorname{Im} z_1 > \operatorname{Im}(z_2 - z_1) > 0\}.$$

Then we have:

Proposition 3.18. *Suppose $W_1, W_2, W_3, W_4, M_1,$ and M_2 are modules in \mathcal{C} and $\mathcal{Y}_1, \mathcal{Y}_2, \mathcal{Y}^1,$ and \mathcal{Y}^2 are intertwining operators of types $\binom{W_4}{W_1 M_1}, \binom{M_1}{W_2 W_3}, \binom{W_4}{M_2 W_3},$ and $\binom{M_2}{W_1 W_2},$ respectively, with \mathcal{Y}_2 parity-homogeneous. If*

$$(-1)^{|\mathcal{Y}_2||w_1|} \langle w'_4, \mathcal{Y}_1(w_1, e^{\log r_1}) \mathcal{Y}_2(w_2, e^{\log r_2}) w_3 \rangle = \langle w'_4, \mathcal{Y}^1(\mathcal{Y}^2(w_1, e^{\log(r_1-r_2)}) w_2, e^{\log r_2}) w_3 \rangle$$

for any $w_2 \in W_2, w_3 \in W_3, w'_4 \in W'_4,$ and parity-homogeneous $w_1 \in W_1,$ and for some $r_1, r_2 \in \mathbb{R}$ satisfying $r_1 > r_2 > r_1 - r_2 > 0,$ then

$$(-1)^{|\mathcal{Y}_2||w_1|} \langle w'_4, \mathcal{Y}_1(w_1, e^{\log z_1}) \mathcal{Y}_2(w_2, e^{\log z_2}) w_3 \rangle = \langle w'_4, \mathcal{Y}^1(\mathcal{Y}^2(w_1, e^{\log(z_1-z_2)}) w_2, e^{\log z_2}) w_3 \rangle$$

for any $w_2 \in W_2, w_3 \in W_3, w'_4 \in W'_4,$ and parity-homogeneous $w_1 \in W_1,$ and for any $(z_1, z_2) \in S_1.$ Moreover, the multivalued analytic functions defined by the product of \mathcal{Y}_1 and \mathcal{Y}_2 on the domain $|z_1| > |z_2| > 0$ and by the iterate of \mathcal{Y}^1 and \mathcal{Y}^2 on the domain $|z_2| > |z_1 - z_2| > 0$ have equal restrictions to the region $|z_1| > |z_2| > |z_1 - z_2| > 0.$

Proof. The second assertion of the proposition follows immediately from the first and Proposition 3.12. By Proposition 7.14 in [HLZ5],

$$P(z_1, z_2) = (-1)^{|\mathcal{Y}_2||w_1|} \langle w'_4, \mathcal{Y}_1(w_1, e^{l_{-1/2}(z_1)}) \mathcal{Y}_2(w_2, e^{l_{-1/2}(z_2)}) w_3 \rangle$$

is analytic and single-valued on the simply-connected open set defined by $|z_1| > |z_2| > 0$ and $\arg z_1, \arg z_2 \neq \pi,$ and

$$I(z_1, z_2) = \langle w'_4, \mathcal{Y}^1(\mathcal{Y}^2(w_1, e^{l_{-1/2}(z_1-z_2)}) w_2, e^{l_{-1/2}(z_2)}) w_3 \rangle$$

is analytic and single-valued on the simply-connected open set defined by $|z_2| > |z_1 - z_2| > 0$ and $\arg z_2, \arg(z_1 - z_2) \neq \pi.$ Moreover, the partial derivatives of these functions are given by the $L(-1)$ -derivative property for intertwining operators.

Since $l_{-1/2}(r) = \log r$ for r a positive real number, we have by assumption $P(r_1, r_2) = I(r_1, r_2)$ for some $r_1, r_2 \in \mathbb{R}$ satisfying $r_1 > r_2 > r_1 - r_2 > 0.$ Also, our assumption, the $L(-1)$ -derivative property, and the evenness of $L(-1)$ imply that all partial derivatives of P and I agree at $(r_1, r_2).$ This means that the power series expansions of P and I around (r_1, r_2) are the same, so there is a simply-connected open neighborhood of (r_1, r_2) on which P and I are equal. Then it follows that $P(z_1, z_2) = I(z_1, z_2)$ whenever (z_1, z_2) is in the connected component of (r_1, r_2) in the open set defined by

$$|z_1| > |z_2| > |z_1 - z_2| > 0 \text{ and } \arg z_1, \arg z_2, \arg(z_1 - z_2) \neq \pi.$$

Since (r_1, r_2) is in the boundary of S_1 and S_1 is connected, S_1 is contained in the connected component of $(r_1, r_2).$ Thus $P(z_1, z_2) = I(z_1, z_2)$ for $(z_1, z_2) \in S_1.$ Since also $l_{-1/2}(z_1) = \log z_1, l_{-1/2}(z_2) = \log z_2,$ and $l_{-1/2}(z_1 - z_2) = \log(z_1 - z_2)$ for $(z_1, z_2) \in S_1,$ the proposition follows. \square

Remark 3.19. In the setting of Proposition 3.18 and its proof, note that any pair $(r'_1, r'_2) \in \mathbb{R}^2$ such that $r'_1 > r'_2 > r'_1 - r'_2 > 0$ also lies in the connected component of (r_1, r_2) in the region defined by

$$|z_1| > |z_2| > |z_1 - z_2| > 0 \text{ and } \arg z_1, \arg z_2, \arg(z_1 - z_2) \neq \pi.$$

Moreover, $l_{-1/2}(r) = \log r$ for r a positive real number. Thus the conclusion of Proposition 3.18 holds with $(z_1, z_2) \in S_1$ replaced by $(r'_1, r'_2) \in \mathbb{R}^2$ satisfying $r'_1 > r'_2 > r'_1 - r'_2 > 0.$

The second proposition has a similar proof to the first:

Proposition 3.20. *Suppose $W_1, W_2, W_3, W_4, M_1,$ and M_2 are modules in \mathcal{C} and $\mathcal{Y}_1, \mathcal{Y}_2, \mathcal{Y}^1,$ and \mathcal{Y}^2 are intertwining operators of types $\binom{M_1}{W_1 W_3}, \binom{W_4}{W_2 M_1}, \binom{W_4}{M_2 W_3},$ and $\binom{M_2}{W_1 W_2},$ respectively. If*

$$(-1)^{|w_1||w_2|} \langle w'_4, \mathcal{Y}_2(w_2, e^{\log r_2}) \mathcal{Y}_1(w_1, e^{\log r_1}) w_3 \rangle = \langle w'_4, \mathcal{Y}^1(\mathcal{Y}^2(w_1, e^{l_{-1/2}(r_1-r_2)}) w_2, e^{\log r_2}) w_3 \rangle$$

for any $w_3 \in W_3, w'_4 \in W'_4,$ for any parity-homogeneous $w_1 \in W_1, w_2 \in W_2,$ and for some $r_1, r_2 \in \mathbb{R}$ satisfying $r_2 > r_1 > r_2 - r_1 > 0,$ then

$$(-1)^{|w_1||w_2|} \langle w'_4, \mathcal{Y}_2(w_1, e^{\log z_2}) \mathcal{Y}_1(w_1, e^{\log z_1}) w_3 \rangle = \langle w'_4, \mathcal{Y}^1(\mathcal{Y}^2(w_1, e^{l_{-1/2}(z_1-z_2)}) w_2, e^{\log z_2}) w_3 \rangle$$

for any $w_3 \in W_3, w'_4 \in W'_4,$ for any parity-homogeneous $w_1 \in W_1, w_2 \in W_2,$ and for any $(z_1, z_2) \in S_2.$ Moreover, the multivalued analytic functions defined by the product of \mathcal{Y}_2 and \mathcal{Y}_1 on the domain $|z_2| > |z_1| > 0$ and by the iterate of \mathcal{Y}^1 and \mathcal{Y}^2 on the domain $|z_2| > |z_1 - z_2| > 0$ have equal restrictions to the region $|z_2| > |z_1|, |z_1 - z_2| > 0.$

3.3 An exposition of vertex tensor category constructions

We now discuss tensor structure on the category \mathcal{C} of V -modules, giving the natural generalization of [HLZ8] to the superalgebra setting. The constructions actually give more than braided monoidal supercategory structure: they yield *vertex tensor category* structure, in the terminology of [HL1], and we shall need this extra structure for our main results. The vertex tensor category structure reflects the complex analytic properties of intertwining operators and their compositions, while the braided monoidal (super)category structure corresponds to topological structure. For further exposition of relevant constructions and results, see [HL6]. Most of the definitions and results here are contained (for the vertex operator algebra setting) in [HLZ1]-[HLZ8], as well as in the earlier papers [HL2]-[HL4], [Hu2, Hu7], but we include proofs for some propositions when [HLZ8] does not contain a detailed proof, or when the superalgebra generality differs from the algebra case.

3.3.1 $P(z)$ -tensor products

We recall the definition of $P(z)$ -tensor product of V -modules for $z \in \mathbb{C}^\times$ from [HLZ3]:

Definition 3.21. Suppose W_1 and W_2 are modules in \mathcal{C} and $z \in \mathbb{C}^\times$. A $P(z)$ -tensor product of W_1 and W_2 in \mathcal{C} is a module $W_1 \boxtimes_{P(z)} W_2$ in \mathcal{C} together with an even $P(z)$ -intertwining map $\boxtimes_{P(z)}$ of type $\binom{W_1 \boxtimes_{P(z)} W_2}{W_1 W_2}$ which satisfies the following universal property: for any module W_3 in \mathcal{C} and $P(z)$ -intertwining map I of type $\binom{W_3}{W_1 W_2}$, there is a unique homomorphism $\eta_I : W_1 \boxtimes_{P(z)} W_2 \rightarrow W_3$ such that $\overline{\eta_I} \circ \boxtimes_{P(z)} = I$, where $\overline{\eta_I}$ denotes the natural extension of η_I to $\overline{W_1 \boxtimes_{P(z)} W_2}$.

Remark 3.22. To obtain braided monoidal supercategory structure on \mathcal{C} , one must choose a particular tensor product. It is conventional to choose $\boxtimes_{P(1)}$, and to simplify notation, we use \boxtimes to denote $\boxtimes_{P(1)}$. We remark that specialization of vertex tensor structure to braided tensor structure is not automatic due to convergence issues discussed further below.

Remark 3.23. A construction (subject to certain conditions) of $W_1 \boxtimes_{P(z)} W_2$ as the contragredient of a certain V -module contained in $(W_1 \otimes W_2)^*$ may be found in [HLZ4]. Because $P(z)$ -tensor products are defined by a universal property, any other construction is naturally isomorphic to this one.

Notation 3.24. We use the following notation for the tensor product intertwining map $\boxtimes_{P(z)}$ of type $\binom{W_1 \boxtimes_{P(z)} W_2}{W_1 W_2}$:

$$\boxtimes_{P(z)}(w_1 \otimes w_2) = w_1 \boxtimes_{P(z)} w_2$$

for $w_1 \in W_1, w_2 \in W_2$. We also use the simplified notation $\boxtimes_{P(1)}(w_1 \otimes w_2) = w_1 \boxtimes w_2$.

For any $z \in \mathbb{C}^\times$, we want the $P(z)$ -tensor product to be a functor from $\mathcal{C} \times \mathcal{C}$ to \mathcal{C} , so we also need tensor products of morphisms. If $f_1 : W_1 \rightarrow \widetilde{W}_1$ and $f_2 : W_2 \rightarrow \widetilde{W}_2$ are morphisms in \mathcal{C} , then $\boxtimes_{P(z)} \circ (f_1 \otimes f_2)$, where $\boxtimes_{P(z)}$ is the tensor product intertwining map for \widetilde{W}_1 and \widetilde{W}_2 , is a $P(z)$ -intertwining map of type $\binom{\widetilde{W}_1 \boxtimes_{P(z)} \widetilde{W}_2}{\widetilde{W}_1 \widetilde{W}_2}$. Here $f_1 \otimes f_2$ is the tensor product of linear maps in the tensor supercategory of superspaces, defined by

$$(f_1 \otimes f_2)(w_1 \otimes w_2) = (-1)^{|f_2||w_1|} (f_1(w_1) \otimes f_2(w_2))$$

when f_2 is parity-homogeneous, for $w_2 \in W_2$ and parity-homogeneous $w_1 \in W_1$. Then we define

$$f_1 \boxtimes_{P(z)} f_2 : W_1 \boxtimes_{P(z)} W_2 \rightarrow \widetilde{W}_1 \boxtimes_{P(z)} \widetilde{W}_2$$

to be the unique morphism induced by the universal property of $W_1 \boxtimes_{P(z)} W_2$ and $\boxtimes_{P(z)} \circ (f_1 \otimes f_2)$. In particular,

$$\overline{f_1 \boxtimes_{P(z)} f_2}(w_1 \boxtimes_{P(z)} w_2) = (-1)^{|f_2||w_1|} (f_1(w_1) \boxtimes_{P(z)} f_2(w_2)) \quad (3.7)$$

if f_2 is parity-homogeneous, for any $w_2 \in W_2$ and parity-homogeneous $w_1 \in W_1$. With this definition, the $P(z)$ -tensor product of V -module homomorphisms satisfies the super interchange law

$$(f_1 \boxtimes_{P(z)} f_2) \circ (g_1 \boxtimes_{P(z)} g_2) = (-1)^{|f_2||g_1|} (f_1 \circ g_1) \boxtimes_{P(z)} (f_2 \circ g_2)$$

when f_2 and g_1 are parity-homogeneous, because the tensor product of linear maps between superspaces satisfies this property.

3.3.2 Parallel transport isomorphisms

To define braiding and associativity isomorphisms in \mathcal{C} , we shall need the parallel transport isomorphisms constructed in [HL1, Hu7, HLZ8]. Suppose W_1 and W_2 are modules in \mathcal{C} , $z_1, z_2 \in \mathbb{C}^\times$ and γ is a continuous path in \mathbb{C}^\times from z_1 to z_2 . The parallel transport isomorphism (below, we will show that it is indeed an isomorphism, and moreover, a natural isomorphism)

$$T_\gamma = T_{\gamma; W_1, W_2} : W_1 \boxtimes_{P(z_1)} W_2 \rightarrow W_1 \boxtimes_{P(z_2)} W_2$$

is the unique morphism induced by the universal property of $W_1 \boxtimes_{P(z_1)} W_2$ and the $P(z_1)$ -intertwining map $\mathcal{Y}_{\boxtimes_{P(z_2)}, 0}(\cdot, e^{l(z_1)}) \cdot$ of type $\binom{W_1 \boxtimes_{P(z_2)} W_2}{W_1 W_2}$, where $l(z_1)$ is the branch of logarithm determined by $\log z_2$ and the path γ . Notice that T_γ is uniquely determined by the condition

$$\overline{T_\gamma}(w_1 \boxtimes_{P(z_1)} w_2) = \mathcal{Y}_{\boxtimes_{P(z_2)}, 0}(w_1, e^{l(z_1)})w_2 \quad (3.8)$$

for all $w_1 \in W_1, w_2 \in W_2$.

Suppose γ_1 is a path in \mathbb{C}^\times from z_1 to z_2 and γ_2 is a path in \mathbb{C}^\times from z_2 to z_3 . Let $\gamma_2 \cdot \gamma_1$ denote the path from z_1 to z_3 obtained by following γ_1 and then γ_2 .

Proposition 3.25. *For modules W_1 and W_2 in \mathcal{C} , $T_{\gamma_2 \cdot \gamma_1} = T_{\gamma_2} \circ T_{\gamma_1}$.*

Proof. By (3.8) and the $L(0)$ -conjugation property of intertwining operators [HLZ2, Proposition 3.36(b)],

$$\begin{aligned} \overline{T_{\gamma_2} \circ T_{\gamma_1}}(w_1 \boxtimes_{P(z_1)} w_2) &= \overline{T_{\gamma_2}}(\mathcal{Y}_{\boxtimes_{P(z_2)}, 0}(w_1, e^{l(z_1)})w_2) \\ &= e^{(l(z_1) - \log z_2)L(0)} \overline{T_{\gamma_2}}(\mathcal{Y}_{\boxtimes_{P(z_2)}, 0}(e^{-(l(z_1) - \log z_2)L(0)} w_1, e^{\log z_2})e^{-(l(z_1) - \log z_2)L(0)} w_2)) \\ &= e^{(l(z_1) - \log z_2)L(0)} \overline{T_{\gamma_2}}(e^{-(l(z_1) - \log z_2)L(0)} w_1 \boxtimes_{P(z_2)} e^{-(l(z_1) - \log z_2)L(0)} w_2) \\ &= e^{(l(z_1) - \log z_2)L(0)} \mathcal{Y}_{\boxtimes_{P(z_3)}, 0}(e^{-(l(z_1) - \log z_2)L(0)} w_1, e^{l'(z_2)})e^{-(l(z_1) - \log z_2)L(0)} w_2) \\ &= \mathcal{Y}_{\boxtimes_{P(z_3)}, 0}(w_1, e^{l(z_1) + l'(z_2) - \log z_2})w_2 \end{aligned}$$

for any $w_1 \in W_1$ and $w_2 \in W_2$, where $l(z_1)$ is the branch of logarithm determined by $\log z_2$ and γ_1 , and $l'(z_2)$ is the branch of logarithm determined by $\log z_3$ and γ_2 . To complete the proof, we just need to show that $l(z_1) + l'(z_2) - \log z_2$ is the branch of logarithm at z_1 determined by $\log z_3$ and $\gamma_2 \cdot \gamma_1$. In fact, the branch of logarithm determined by $\log z_3$ and $\gamma_2 \cdot \gamma_1$ has value

$$l'(z_2) = \log z_2 + 2\pi ip$$

at z_2 for some $p \in \mathbb{Z}$. Then this branch of logarithm has value

$$l(z_1) + 2\pi ip = l(z_1) + l'(z_2) - \log z_2$$

at z_1 , as desired. \square

Corollary 3.26. *The parallel transport T_γ is an isomorphism.*

Proof. The parallel transport T_γ depends only on the homotopy class of γ in \mathbb{C}^\times because the branch of logarithm $l(z_1)$ depends only on the homotopy class of γ . Therefore the preceding proposition shows that the inverse of T_γ is the parallel transport $T_{\gamma'}$ where γ' is the path from z_2 to z_1 obtained by reversing γ . Thus T_γ is in fact an isomorphism. \square

Proposition 3.27. *The parallel transport isomorphisms determine an even natural isomorphism from $\boxtimes_{P(z_1)}$ to $\boxtimes_{P(z_2)}$. In particular, for any morphisms $f_1 : W_1 \rightarrow \widetilde{W}_1$ and $f_2 : W_2 \rightarrow \widetilde{W}_2$ in \mathcal{C} ,*

$$T_{\gamma; \widetilde{W}_1, \widetilde{W}_2} \circ (f_1 \boxtimes_{P(z_1)} f_2) = (f_1 \boxtimes_{P(z_2)} f_2) \circ T_{\gamma; W_1, W_2}.$$

Proof. The evenness of T_γ follows from (3.8) and the evenness of $\boxtimes_{P(z_1)}$ and $\mathcal{Y}_{\boxtimes_{P(z_2)}, 0}$. Now observe that if f_2 is parity-homogeneous,

$$\overline{T_{\gamma; \widetilde{W}_1, \widetilde{W}_2} \circ (f_1 \boxtimes_{P(z_1)} f_2)}(w_1 \boxtimes_{P(z_1)} w_2) = (-1)^{|f_2||w_1|} \mathcal{Y}_{\boxtimes_{P(z_2)}, 0}(f_1(w_1), e^{l(z_1)})f_2(w_2),$$

for any $w_2 \in W_2$ and parity-homogeneous $w_1 \in W_1$, where $l(z_1)$ is the branch of logarithm determined by $\log z_2$ and γ . On the other hand, since $L(0)$ is even,

$$\overline{(f_1 \boxtimes_{P(z_2)} f_2) \circ T_{\gamma; W_1, W_2}}(w_1 \boxtimes_{P(z_1)} w_2) = \overline{f_1 \boxtimes_{P(z_2)} f_2}(\mathcal{Y}_{\boxtimes_{P(z_2)}, 0}(w_1, e^{l(z_1)})w_2)$$

$$\begin{aligned}
&= e^{(l(z_1)-\log z_2)L(0)} \overline{f_1 \boxtimes_{P(z_2)} f_2} \left(\mathcal{Y}_{\boxtimes_{P(z_2)},0}(e^{-(l(z_1)-\log z_2)L(0)} w_1, e^{\log z_2}) e^{-(l(z_1)-\log z_2)L(0)} w_2 \right) \\
&= e^{(l(z_1)-\log z_2)L(0)} \overline{f_1 \boxtimes_{P(z_2)} f_2} \left(e^{-(l(z_1)-\log z_2)L(0)} w_1 \boxtimes_{P(z_2)} e^{-(l(z_1)-\log z_2)L(0)} w_2 \right) \\
&= (-1)^{|f_2||w_1|} e^{(l(z_1)-\log z_2)L(0)} \left(e^{-(l(z_1)-\log z_2)L(0)} f_1(w_1) \boxtimes_{P(z_2)} e^{-(l(z_1)-\log z_2)L(0)} f_2(w_2) \right) \\
&= (-1)^{|f_2||w_1|} \mathcal{Y}_{\boxtimes_{P(z_2)},0}(f_1(w_1), e^{l(z_1)}) f_2(w_2)
\end{aligned}$$

for any $w_2 \in W_2$ and parity-homogeneous $w_1 \in W_1$. Thus the two compositions are the same. \square

We will frequently use parallel transport isomorphisms corresponding to paths γ from z_1 to z_2 in \mathbb{C}^\times with a cut along the positive real axis. That is, such paths will neither cross the positive real axis nor approach it from the lower half plane. This will ensure that $l(z_1) = \log z_1$. Since the corresponding parallel transport isomorphism depends only the endpoints z_1 and z_2 , we will denote it by $T_{z_1 \rightarrow z_2}$. That is, $T_{z_1 \rightarrow z_2} : W_1 \boxtimes_{P(z_1)} W_2 \rightarrow W_1 \boxtimes_{P(z_2)} W_2$ is the isomorphism characterized by

$$\overline{T_{z_1 \rightarrow z_2}}(w_1 \boxtimes_{P(z_1)} w_2) = \mathcal{Y}_{\boxtimes_{P(z_2)},0}(w_1, e^{\log z_1}) w_2 \quad (3.9)$$

for $w_1 \in W_1, w_2 \in W_2$.

3.3.3 Unit isomorphisms

We now discuss unit isomorphisms in \mathcal{C} . The unit object in \mathcal{C} is V . For any module W in \mathcal{C} and $z \in \mathbb{C}^\times$, we have a unique homomorphism $l_{P(z)} : V \boxtimes_{P(z)} W \rightarrow W$ induced by the universal property of $V \boxtimes_{P(z)} W$ and the $P(z)$ -intertwining map $Y_W(\cdot, z) \cdot$ (we do not need to specify a branch of logarithm because Y_W involves only integral powers of the formal variable x). In the braided monoidal supercategory structure on \mathcal{C} , the left unit isomorphism is $l_W = l_{P(1)}$. For the right unit isomorphism, we have for any $z \in \mathbb{C}^\times$ a unique homomorphism $r_{P(z)} : W \boxtimes_{P(z)} V \rightarrow W$ induced by the universal property of $W \boxtimes_{P(z)} V$ and the $P(z)$ -intertwining map $\Omega(Y_W)(\cdot, z) \cdot$. Then the right unit isomorphism in the braided monoidal supercategory \mathcal{C} is $r_W = r_{P(1)}$. The unit isomorphisms for W in \mathcal{C} are characterized by the conditions

$$\overline{l_W}(v \boxtimes w) = Y_W(v, 1)w$$

and

$$\overline{r_W}(w \boxtimes v) = (-1)^{|v||w|} e^{L(-1)} Y_W(v, -1)w$$

for parity-homogeneous $v \in V$ and $w \in W$.

3.3.4 Braiding isomorphisms

Next we recall the braiding isomorphisms in \mathcal{C} . Let W_1 and W_2 be modules in \mathcal{C} and let $z \in \mathbb{C}^\times$. First, we define

$$\mathcal{R}_{P(z); W_1, W_2}^+ = \mathcal{R}_{P(z)}^+ : W_1 \boxtimes_{P(z)} W_2 \rightarrow W_2 \boxtimes_{P(-z)} W_1$$

to be the unique morphism induced by the universal property of $W_1 \boxtimes_{P(z)} W_2$ and the $P(z)$ -intertwining map $\Omega_0(\mathcal{Y}_{\boxtimes_{P(-z)},0})(\cdot, e^{\log z}) \cdot$ of type $\binom{W_2 \boxtimes_{P(-z)} W_1}{W_1 W_2}$. Thus $\mathcal{R}_{P(z)}^+$ is determined by the property

$$\begin{aligned}
\overline{\mathcal{R}_{P(z)}^+}(w_1 \boxtimes_{P(z)} w_2) &= (-1)^{|w_1||w_2|} e^{zL(-1)} \mathcal{Y}_{\boxtimes_{P(-z)},0}(w_2, e^{\log z + \pi i}) w_1 \\
&= (-1)^{|w_1||w_2|} e^{zL(-1)} \mathcal{Y}_{\boxtimes_{P(-z)},0}(w_2, e^{l_{1/2}(-z)}) w_1
\end{aligned} \quad (3.10)$$

for parity-homogeneous $w_1 \in W_1$ and $w_2 \in W_2$. We also define

$$\mathcal{R}_{P(z); W_1, W_2}^- = \mathcal{R}_{P(z)}^- : W_1 \boxtimes_{P(z)} W_2 \rightarrow W_2 \boxtimes_{P(-z)} W_1$$

to be the unique morphism induced by the universal property of $W_1 \boxtimes_{P(z)} W_2$ and the $P(z)$ -intertwining map $\Omega_{-1}(\mathcal{Y}_{\boxtimes_{P(-z)},0})(\cdot, e^{\log z}) \cdot$ of type $\binom{W_2 \boxtimes_{P(-z)} W_1}{W_1 W_2}$. Then $\mathcal{R}_{P(z)}^-$ is determined by the condition

$$\begin{aligned}
\overline{\mathcal{R}_{P(z)}^-}(w_1 \boxtimes_{P(z)} w_2) &= (-1)^{|w_1||w_2|} e^{zL(-1)} \mathcal{Y}_{\boxtimes_{P(-z)},0}(w_2, e^{\log z - \pi i}) w_1 \\
&= (-1)^{|w_1||w_2|} e^{zL(-1)} \mathcal{Y}_{\boxtimes_{P(-z)},0}(w_2, e^{l_{-1/2}(-z)}) w_1
\end{aligned} \quad (3.11)$$

for parity-homogeneous $w_1 \in W_1$ and $w_2 \in W_2$.

Proposition 3.28. *For any $z \in \mathbb{C}^\times$, $\mathcal{R}_{P(z); W_1, W_2}^+$ and $\mathcal{R}_{P(-z); W_2, W_1}^-$ are inverses of each other.*

Proof. For any $z \in \mathbb{C}^\times$ and parity-homogeneous $w_1 \in W_1$, $w_2 \in W_2$, we have

$$\begin{aligned}
\overline{\mathcal{R}_{P(-z)}^- \circ \mathcal{R}_{P(z)}^+}(w_1 \boxtimes_{P(z)} w_2) &= (-1)^{|w_1||w_2|} \overline{\mathcal{R}_{P(-z)}^-} \left(e^{zL(-1)} \mathcal{Y}_{\boxtimes_{P(-z)},0}(w_2, e^{l_{1/2}(-z)}) w_1 \right) \\
&= (-1)^{|w_1||w_2|} e^{zL(-1)} e^{(l_{1/2}(-z) - \log(-z))L(0)} \\
&\quad \cdot \overline{\mathcal{R}_{P(-z)}^-} \left(e^{-(l_{1/2}(-z) - \log(-z))L(0)} w_2 \boxtimes_{P(-z)} e^{-(l_{1/2}(-z) - \log(-z))L(0)} w_1 \right) \\
&= e^{zL(-1)} e^{(l_{1/2}(-z) - \log(-z))L(0)} e^{-zL(-1)} \\
&\quad \cdot \mathcal{Y}_{\boxtimes_{P(z)},0}(e^{-(l_{1/2}(-z) - \log(-z))L(0)} w_1, e^{l_{-1/2}(z)}) e^{-(l_{1/2}(-z) - \log(-z))L(0)} w_2, \quad (3.12)
\end{aligned}$$

using the evenness of $L(0)$. Now, $e^{(l_{1/2}(-z) - \log(-z))L(0)} = e^{2\pi i p L(0)}$ for $p = 0$ or 1 . Then Remark 3.40 in [HLZ2] implies that $e^{(l_{1/2}(-z) - \log(-z))L(0)}$ is a V -module homomorphism and thus commutes with $e^{-zL(-1)}$. Hence the right side of (3.12) reduces to

$$\begin{aligned}
&e^{(l_{1/2}(-z) - \log(-z))L(0)} \mathcal{Y}_{\boxtimes_{P(z)},0}(e^{-(l_{1/2}(-z) - \log(-z))L(0)} w_1, e^{l_{-1/2}(z)}) e^{-(l_{1/2}(-z) - \log(-z))L(0)} w_2 \\
&= \mathcal{Y}_{\boxtimes_{P(z)},0}(w_1, e^{l_{-1/2}(z) + l_{1/2}(-z) - \log(-z)}) w_2 \\
&= \mathcal{Y}_{\boxtimes_{P(z)},0}(w_1, e^{\log z}) w_2 = w_1 \boxtimes_{P(z)} w_2
\end{aligned}$$

because

$$l_{-1/2}(z) + l_{1/2}(-z) - \log(-z) = (\log(-z) - \pi i) + (\log z + \pi i) - \log(-z) = \log z.$$

This shows that $\mathcal{R}_{P(z)}^- \circ \mathcal{R}_{P(z)}^+ = 1_{W_1 \boxtimes_{P(z)} W_2}$. Similarly, $\mathcal{R}_{P(z)}^+ \circ \mathcal{R}_{P(-z)}^- = 1_{W_2 \boxtimes_{P(-z)} W_1}$. \square

Following [HLZ8], we can now define the braiding isomorphism in \mathcal{C} to be

$$\mathcal{R}_{W_1, W_2} = T_{-1 \rightarrow 1} \circ \mathcal{R}_{P(1)}^+ : W_1 \boxtimes W_2 \rightarrow W_2 \boxtimes W_1.$$

The braiding isomorphism satisfies

$$\begin{aligned}
\overline{\mathcal{R}_{W_1, W_2}}(w_1 \boxtimes w_2) &= (-1)^{|w_1||w_2|} e^{L(-1)} \overline{T_{-1 \rightarrow 1}} \left(\mathcal{Y}_{\boxtimes_{P(-1)},0}(w_2, e^{l_{1/2}(-1)}) w_1 \right) \\
&= (-1)^{|w_1||w_2|} e^{L(-1)} \overline{T_{-1 \rightarrow 1}}(w_2 \boxtimes_{P(-1)} w_1) = (-1)^{|w_1||w_2|} e^{L(-1)} \mathcal{Y}_{\boxtimes_{P(1)},0}(w_2, e^{\log(-1)}) w_1 \\
&= (-1)^{|w_1||w_2|} e^{L(-1)} \mathcal{Y}_{\boxtimes_{P(1)},0}(w_2, e^{\pi i}) w_1 \quad (3.13)
\end{aligned}$$

for parity-homogeneous $w_1 \in W_1$ and $w_2 \in W_2$. The braiding isomorphism \mathcal{R}_{W_1, W_2} is also naturally related to $\mathcal{R}_{P(z)}^+$ for any $z \in \mathbb{C}^\times$:

Proposition 3.29. *For any $z \in \mathbb{C}^\times$, $\mathcal{R}_{W_1, W_2} = T_{-z \rightarrow 1} \circ \mathcal{R}_{P(z)}^+ \circ T_{1 \rightarrow z}$. Moreover, $\mathcal{R}_{W_1, W_2}^{-1} = T_{z \rightarrow 1} \circ \mathcal{R}_{P(-z)}^- \circ T_{1 \rightarrow -z}$.*

Proof. The second assertion follows immediately from the first by Proposition 3.28 and the fact that $T_{z_2 \rightarrow z_1} = T_{z_1 \rightarrow z_2}^{-1}$ for any $z_1, z_2 \in \mathbb{C}^\times$. To prove the first assertion, we observe that

$$\begin{aligned}
\overline{T_{-z \rightarrow 1} \circ \mathcal{R}_{P(z)}^+ \circ T_{1 \rightarrow z}}(w_1 \boxtimes w_2) &= \overline{T_{-z \rightarrow 1} \circ \mathcal{R}_{P(z)}^+}(\mathcal{Y}_{\boxtimes_{P(z)},0}(w_1, e^{\log 1}) w_2) \\
&= e^{-\log z L(0)} \overline{T_{-z \rightarrow 1} \circ \mathcal{R}_{P(z)}^+}(e^{\log z L(0)} w_1 \boxtimes_{P(z)} e^{\log z L(0)} w_2) \\
&= (-1)^{|w_1||w_2|} e^{-\log z L(0)} e^{zL(-1)} \overline{T_{-z \rightarrow 1}} \left(\mathcal{Y}_{\boxtimes_{P(-z)},0}(e^{\log z L(0)} w_2, e^{l_{1/2}(-z)}) e^{\log z L(0)} w_1 \right) \\
&= (-1)^{|w_1||w_2|} e^{-\log z L(0)} e^{zL(-1)} e^{(l_{1/2}(-z) - \log(-z))L(0)} \\
&\quad \cdot \overline{T_{-z \rightarrow 1}}(e^{(\log z - l_{1/2}(-z) + \log(-z))L(0)} w_2 \boxtimes_{P(-z)} e^{(\log z - l_{1/2}(-z) + \log(-z))L(0)} w_1) \\
&= (-1)^{|w_1||w_2|} e^{L(-1)} e^{-l_{-1/2}(z)L(0)} \mathcal{Y}_{\boxtimes_{P(1)},0}(e^{l_{-1/2}(z)L(0)} w_2, e^{\log(-z)}) e^{l_{-1/2}(z)L(0)} w_1 \\
&= (-1)^{|w_1||w_2|} e^{L(-1)} \mathcal{Y}_{\boxtimes_{P(1)},0}(w_2, e^{\log(-z) - l_{-1/2}(z)}) w_1 \\
&= (-1)^{|w_1||w_2|} e^{L(-1)} \mathcal{Y}_{\boxtimes_{P(1)},0}(w_2, e^{\pi i}) w_1
\end{aligned}$$

for any parity-homogeneous $w_1 \in W_1$, $w_2 \in W_2$. To obtain the fifth equality, we have used the commutation relation $z^{-L(0)} e^{zL(-1)} = e^{z z^{-1} L(-1)} z^{-L(0)}$ (see Remark 3.38 in [HLZ2]) and the equality

$$\log z - l_{1/2}(-z) + \log(-z) = \log z - (\log z + \pi i) + (l_{-1/2}(z) + \pi i) = l_{-1/2}(z).$$

Then by (3.13), $T_{-z \rightarrow 1} \circ \mathcal{R}_{P(z)}^+ \circ T_{1 \rightarrow z}$ agrees with \mathcal{R}_{W_1, W_2} , as desired. \square

Since the naturality of braiding isomorphisms in a supercategory involves a sign factor, we include a proof here to illustrate the essential role of the sign factor in (3.7):

Proposition 3.30. *For parity-homogeneous homomorphisms $f_1 : W_1 \rightarrow \widetilde{W}_1$ and $f_2 : W_2 \rightarrow \widetilde{W}_2$ in \mathcal{C} ,*

$$\mathcal{R}_{\widetilde{W}_1, \widetilde{W}_2} \circ (f_1 \boxtimes f_2) = (-1)^{|f_1||f_2|} (f_2 \boxtimes f_1) \circ \mathcal{R}_{W_1, W_2}.$$

Proof. Using (3.7), (3.13), and the evenness of $L(0)$, $L(-1)$, we have:

$$\begin{aligned} \overline{\mathcal{R}_{\widetilde{W}_1, \widetilde{W}_2} \circ (f_1 \boxtimes f_2)}(w_1 \boxtimes w_2) &= (-1)^{|f_2||w_1|} \overline{\mathcal{R}_{\widetilde{W}_1, \widetilde{W}_2}}(f_1(w_1) \boxtimes f_2(w_2)) \\ &= (-1)^{|f_2||w_1| + (|f_1| + |w_1|)(|f_2| + |w_2|)} e^{L(-1)} \mathcal{Y}_{\boxtimes_{P(1)}, 0}(f_2(w_2), e^{\pi i}) f_1(w_1) \\ &= (-1)^{|f_1||f_2| + |w_1||w_2| + |f_1||w_2|} e^{L(-1)} e^{\pi i L(0)} \left(e^{-\pi i L(0)} f_2(w_2) \boxtimes e^{-\pi i L(0)} f_1(w_1) \right) \\ &= (-1)^{|f_1||f_2|} \overline{f_2 \boxtimes f_1} \left((-1)^{|w_1||w_2|} e^{L(-1)} \mathcal{Y}_{\boxtimes_{P(1)}, 0}(w_2, e^{\pi i}) w_1 \right) \\ &= (-1)^{|f_1||f_2|} \overline{(f_2 \boxtimes f_1)} \circ \overline{\mathcal{R}_{W_1, W_2}}(w_1 \boxtimes w_2) \end{aligned}$$

for parity-homogeneous $w_1 \in W_1$ and $w_2 \in W_2$. \square

We now show how to characterize the monodromy isomorphisms in \mathcal{C} . Notice that (3.13) implies that $\overline{\mathcal{R}_{W_1, W_2}} \circ \boxtimes_{P(1)} = \Omega_0(\mathcal{Y}_{\boxtimes_{P(1)}, 0})(\cdot, e^{\log 1})$; by Proposition 3.15, this means that

$$\mathcal{R}_{W_1, W_2}(\mathcal{Y}_{\boxtimes_{P(1)}, 0}(w_1, x)w_2) = \Omega_0(\mathcal{Y}_{\boxtimes_{P(1)}, 0})(w_1, x)w_2 = (-1)^{|w_1||w_2|} e^{xL(-1)} \mathcal{Y}_{\boxtimes_{P(1)}, 0}(w_2, e^{\pi i}x)w_1 \quad (3.14)$$

for parity-homogeneous $w_1 \in W_1$, $w_2 \in W_2$. Now it is easy to see from (3.14) that the monodromy isomorphisms in \mathcal{C} are given by

$$\mathcal{M}_{W_1, W_2}(\mathcal{Y}_{\boxtimes_{P(1)}, 0}(w_1, x)w_2) = \mathcal{Y}_{\boxtimes_{P(1)}, 0}(w_1, e^{2\pi i}x)w_2 \quad (3.15)$$

for $w_1 \in W_1$ and $w_2 \in W_2$. Comparing this with (3.8), we see immediately that the monodromy isomorphisms in \mathcal{C} are indeed given by the monodromy of certain paths in \mathbb{C}^\times :

Proposition 3.31. *For any $p \in \mathbb{Z}$, $\mathcal{M}_{W_1, W_2}^p = T_{\gamma^p, W_1, W_2}$ where γ^p is a continuous path from 1 to 1 in \mathbb{C}^\times that wraps around the origin p times clockwise.*

3.3.5 Associativity isomorphisms

Now we recall the associativity isomorphisms in \mathcal{C} from [HLZ8]. Suppose W_1 , W_2 , and W_3 are objects of \mathcal{C} . Then for $z_1, z_2 \in \mathbb{C}^\times$ which satisfy $|z_1| > |z_2| > 0$, the convergence condition for intertwining maps implies that there is an element

$$w_1 \boxtimes_{P(z_1)} (w_2 \boxtimes_{P(z_2)} w_3) \in \overline{W_1 \boxtimes_{P(z_1)} (W_2 \boxtimes_{P(z_2)} W_3)}$$

for any $w_1 \in W_1$, $w_2 \in W_2$, and $w_3 \in W_3$ defined by its action on $(W_1 \boxtimes_{P(z_1)} (W_2 \boxtimes_{P(z_2)} W_3))'$:

$$\langle w', w_1 \boxtimes_{P(z_1)} (w_2 \boxtimes_{P(z_2)} w_3) \rangle = \sum_{n \in \mathbb{R}} \langle w', w_1 \boxtimes_{P(z_1)} \pi_n(w_2 \boxtimes_{P(z_2)} w_3) \rangle$$

for any $w' \in (W_1 \boxtimes_{P(z_1)} (W_2 \boxtimes_{P(z_2)} W_3))'$. Similarly, for $z_0, z_2 \in \mathbb{C}^\times$ which satisfy $|z_2| > |z_0| > 0$, there is an element

$$(w_1 \boxtimes_{P(z_0)} w_2) \boxtimes_{P(z_2)} w_3 \in \overline{(W_1 \boxtimes_{P(z_0)} W_2) \boxtimes_{P(z_2)} W_3}$$

which is defined by

$$\langle w', (w_1 \boxtimes_{P(z_0)} w_2) \boxtimes_{P(z_2)} w_3 \rangle = \sum_{n \in \mathbb{R}} \langle w', \pi_n(w_1 \boxtimes_{P(z_0)} w_2) \boxtimes_{P(z_2)} w_3 \rangle$$

for any $w' \in ((W_1 \boxtimes_{P(z_0)} W_2) \boxtimes_{P(z_2)} W_3)'$. Then under suitable conditions, [HLZ6, Theorem 10.3] shows that for $z_1, z_2 \in \mathbb{C}^\times$ which satisfy

$$|z_1| > |z_2| > |z_1 - z_2| > 0,$$

there is a natural isomorphism

$$\mathcal{A}_{z_1, z_2} : W_1 \boxtimes_{P(z_1)} (W_2 \boxtimes_{P(z_2)} W_3) \rightarrow (W_1 \boxtimes_{P(z_1 - z_2)} W_2) \boxtimes_{P(z_2)} W_3$$

characterized by the condition

$$\overline{\mathcal{A}_{z_1, z_2}}(w_1 \boxtimes_{P(z_1)} (w_2 \boxtimes_{P(z_2)} w_3)) = (w_1 \boxtimes_{P(z_1 - z_2)} w_2) \boxtimes_{P(z_2)} w_3 \quad (3.16)$$

for any $w_1 \in W_1$, $w_2 \in W_2$, $w_3 \in W_3$. This isomorphism is even because the tensor product intertwining maps $\boxtimes_{P(z)}$ for $z \in \mathbb{C}^\times$ are even.

To obtain the natural associativity isomorphism $\mathcal{A}_{W_1, W_2, W_3}$ in the braided monoidal supercategory \mathcal{C} , choose $r_1, r_2 \in \mathbb{R}$ which satisfy $r_1 > r_2 > r_1 - r_2 > 0$ and set

$$\mathcal{A}_{W_1, W_2, W_3} = T_{r_2 \rightarrow 1} \circ (T_{r_1 - r_2 \rightarrow 1} \boxtimes_{P(r_2)} 1_{W_3}) \circ \mathcal{A}_{r_1, r_2} \circ (1_{W_1} \boxtimes_{P(r_1)} T_{1 \rightarrow r_2}) \circ T_{1 \rightarrow r_1}.$$

Note that $\mathcal{A}_{W_1, W_2, W_3}$ is even because \mathcal{A}_{z_1, z_2} and the parallel transport isomorphisms are even. It is also independent of the choice of r_1, r_2 :

Proposition 3.32. *The associativity isomorphism $\mathcal{A}_{W_1, W_2, W_3}$ is independent of the choice of $r_1, r_2 \in \mathbb{R}$ satisfying $r_1 > r_2 > r_1 - r_2 > 0$.*

Proof. We need to show that for any $r'_1, r'_2 \in \mathbb{R}$ satisfying $r'_1 > r'_2 > r'_1 - r'_2 > 0$,

$$\mathcal{A}_{W_1, W_2, W_3} = T_{r'_2 \rightarrow 1} \circ (T_{r'_1 - r'_2 \rightarrow 1} \boxtimes_{P(r'_2)} 1_{W_3}) \circ \mathcal{A}_{r'_1, r'_2} \circ (1_{W_1} \boxtimes_{P(r'_1)} T_{1 \rightarrow r'_2}) \circ T_{1 \rightarrow r'_1},$$

or equivalently,

$$\begin{aligned} & \mathcal{A}_{r_1, r_2} \circ (1_{W_1} \boxtimes_{P(r_1)} T_{1 \rightarrow r_2}) \circ T_{1 \rightarrow r_1} \circ T_{1 \rightarrow r'_1}^{-1} \circ (1_{W_1} \boxtimes_{P(r'_1)} T_{1 \rightarrow r'_2}^{-1}) \\ &= (T_{r_1 - r_2 \rightarrow 1} \boxtimes_{P(r_2)} 1_{W_3}) \circ T_{r_2 \rightarrow 1}^{-1} \circ T_{r'_2 \rightarrow 1} \circ (T_{r'_1 - r'_2 \rightarrow 1} \boxtimes_{P(r'_2)} 1_{W_3}) \circ \mathcal{A}_{r'_1, r'_2}. \end{aligned}$$

By Proposition 3.25, the fact that $T_{z_1 \rightarrow z_2}^{-1} = T_{z_2 \rightarrow z_1}$ for $z_1, z_2 \in \mathbb{C}^\times$, and the naturality of the parallel transport isomorphisms,

$$(1_{W_1} \boxtimes_{P(r_1)} T_{1 \rightarrow r_2}) \circ T_{1 \rightarrow r_1} \circ T_{1 \rightarrow r'_1}^{-1} \circ (1_{W_1} \boxtimes_{P(r'_1)} T_{1 \rightarrow r'_2}^{-1}) = (1_{W_1} \boxtimes_{P(r_1)} T_{r'_2 \rightarrow r_2}) \circ T_{r'_1 \rightarrow r_1}$$

and

$$(T_{r_1 - r_2 \rightarrow 1} \boxtimes_{P(r_2)} 1_{W_3}) \circ T_{r_2 \rightarrow 1}^{-1} \circ T_{r'_2 \rightarrow 1} \circ (T_{r'_1 - r'_2 \rightarrow 1} \boxtimes_{P(r'_2)} 1_{W_3}) = T_{r'_2 \rightarrow r_2} \circ (T_{r'_1 - r'_2 \rightarrow r_1 - r_2} \boxtimes_{P(r'_2)} 1_{W_3}).$$

Thus we are reduced to proving

$$\mathcal{A}_{r_1, r_2} \circ (1_{W_1} \boxtimes_{P(r_1)} T_{r'_2 \rightarrow r_2}) \circ T_{r'_1 \rightarrow r_1} = T_{r'_2 \rightarrow r_2} \circ (T_{r'_1 - r'_2 \rightarrow r_1 - r_2} \boxtimes_{P(r'_2)} 1_{W_3}) \circ \mathcal{A}_{r'_1, r'_2}.$$

By Corollary 7.17 in [HLZ5], it is enough to show that

$$\begin{aligned} & \overline{\mathcal{A}_{r_1, r_2} \circ (1_{W_1} \boxtimes_{P(r_1)} T_{r'_2 \rightarrow r_2}) \circ T_{r'_1 \rightarrow r_1}}(w_1 \boxtimes_{P(r'_1)} (w_2 \boxtimes_{P(r'_2)} w_3)) \\ &= \overline{T_{r'_2 \rightarrow r_2} \circ (T_{r'_1 - r'_2 \rightarrow r_1 - r_2} \boxtimes_{P(r'_2)} 1_{W_3}) \circ \mathcal{A}_{r'_1, r'_2}}(w_1 \boxtimes_{P(r'_1)} (w_2 \boxtimes_{P(r'_2)} w_3)) \end{aligned}$$

for all $w_1 \in W_1$, $w_2 \in W_2$, and $w_3 \in W_3$. In fact, by (3.7), (3.9), and (3.16),

$$\begin{aligned} & \overline{\mathcal{A}_{r_1, r_2} \circ (1_{W_1} \boxtimes_{P(r_1)} T_{r'_2 \rightarrow r_2}) \circ T_{r'_1 \rightarrow r_1}}(w_1 \boxtimes_{P(r'_1)} (w_2 \boxtimes_{P(r'_2)} w_3)) \\ &= (\mathcal{A}_{r_1, r_2} \circ \mathcal{Y}_{\boxtimes_{P(r_1)}, 0})(w_1, e^{\log r'_1}) \mathcal{Y}_{\boxtimes_{P(r_2)}, 0}(w_2, e^{\log r'_2}) w_3, \end{aligned} \quad (3.17)$$

while

$$\begin{aligned} & \overline{T_{r'_2 \rightarrow r_2} \circ (T_{r'_1 - r'_2 \rightarrow r_1 - r_2} \boxtimes_{P(r'_2)} 1_{W_3}) \circ \mathcal{A}_{r'_1, r'_2}}(w_1 \boxtimes_{P(r'_1)} (w_2 \boxtimes_{P(r'_2)} w_3)) \\ &= \mathcal{Y}_{\boxtimes_{P(r_2)}, 0}(\mathcal{Y}_{\boxtimes_{P(r_1 - r_2)}, 0}(w_1, e^{\log(r'_1 - r'_2)}) w_2, e^{\log r'_2}) w_3. \end{aligned} \quad (3.18)$$

Now, (3.16) shows that (3.17) equals (3.18) for all $w_1 \in W_1$, $w_2 \in W_2$, and $w_3 \in W_3$ when $(r'_1, r'_2) = (r_1, r_2)$. Then Remark 3.19 shows that (3.17) and (3.18) are equal for general (r'_1, r'_2) . \square

Remark 3.33. By the same argument as in the above proof, using Proposition 3.18,

$$\mathcal{A}_{W_1, W_2, W_3} = T_{z_2 \rightarrow 1} \circ (T_{z_1 - z_2 \rightarrow 1} \boxtimes_{P(z_2)} 1_{W_3}) \circ \mathcal{A}_{z_1, z_2} \circ (1_{W_1} \boxtimes_{P(z_1)} T_{1 \rightarrow z_2}) \circ T_{1 \rightarrow z_1}$$

for $(z_1, z_2) \in S_1$.

The equality in Remark 3.33 need not hold for arbitrary $z_1, z_2 \in \mathbb{C}^\times$ such that $|z_1| > |z_2| > |z_1 - z_2| > 0$. To see what happens in general, note that \mathcal{A}_{z_1, z_2} is characterized by the equality

$$\begin{aligned} \langle w', (\mathcal{A}_{z_1, z_2} \circ \mathcal{Y}_{\boxtimes_{P(z_1)}, 0})(w_1, e^{\log z_1}) \mathcal{Y}_{\boxtimes_{P(z_2)}, 0}(w_2, e^{\log z_2}) w_3 \rangle \\ = \langle w', \mathcal{Y}_{\boxtimes_{P(z_2)}, 0}(\mathcal{Y}_{\boxtimes_{P(z_1-z_2)}, 0}(w_1, e^{\log(z_1-z_2)}) w_2, e^{\log z_2}) w_3 \rangle \end{aligned}$$

for $w' \in ((W_1 \boxtimes_{P(z_1-z_2)} W_2) \boxtimes_{P(z_2)} W_3)'$, $w_1 \in W_1$, $w_2 \in W_2$, and $w_3 \in W_3$. This implies an equality of single-valued branches of the multivalued functions given by the product and iterate of intertwining operators in a simply-connected neighborhood of (z_1, z_2) . We can analytically continue these single-valued branches along the following path Γ which is contained in the region $|z'_1| > |z'_2| > |z'_1 - z'_2| > 0$: first hold z_2 fixed while rotating z_1 along the circle of radius $|z_1|$ until it is collinear with 0 and z_2 (that is, rotate z_1 to $\frac{|z_1|}{|z_2|} z_2$); then rotate $\frac{|z_1|}{|z_2|} z_2$ and z_2 together clockwise to $(|z_1|, |z_2|)$. As we analytically continue along the first stage of Γ , the branch of logarithm for z_1 and $z_1 - z_2$ may change from \log to, say, l and \tilde{l} , respectively. All branches of logarithm remain unchanged during the second stage of Γ . Thus

$$\begin{aligned} \langle w', (\mathcal{A}_{z_1, z_2} \circ \mathcal{Y}_{\boxtimes_{P(z_1)}, 0})(w_1, e^{l(z_1)}) \mathcal{Y}_{\boxtimes_{P(z_2)}, 0}(w_2, e^{\log |z_2|}) w_3 \rangle \\ = \langle w', \mathcal{Y}_{\boxtimes_{P(z_2)}, 0}(\mathcal{Y}_{\boxtimes_{P(z_1-z_2)}, 0}(w_1, e^{\tilde{l}(|z_1|-|z_2|)}) w_2, e^{\log |z_2|}) w_3 \rangle \end{aligned}$$

for $w' \in ((W_1 \boxtimes_{P(z_1-z_2)} W_2) \boxtimes_{P(z_2)} W_3)'$, $w_1 \in W_1$, $w_2 \in W_2$, and $w_3 \in W_3$. Similar to the proof of Proposition 3.32, this equality is equivalent to the equality of isomorphisms:

$$\begin{aligned} \mathcal{A}_{z_1, z_2} \circ T_\gamma \circ (1_{W_1} \boxtimes_{P(z_1)} T_{|z_2| \rightarrow z_2}) \circ T_{|z_1| \rightarrow z_1} \\ = (T_{\tilde{\gamma}} \boxtimes_{P(z_2)} 1_{W_3}) \circ (T_{|z_1|-|z_2| \rightarrow z_1-z_2} \boxtimes_{P(z_2)} 1_{W_3}) \circ T_{|z_2| \rightarrow z_2} \circ \mathcal{A}_{|z_1|, |z_2|}, \end{aligned}$$

where γ is a path from z_1 to itself such that $l(z_1)$ is the branch of logarithm determined by $\log z_1$ and γ , and $\tilde{\gamma}$ is a path from $z_1 - z_2$ to itself such that $\tilde{l}(z_1 - z_2)$ is the branch of logarithm determined by $\log(z_1 - z_2)$ and $\tilde{\gamma}$. Combining this with the relation between $\mathcal{A}_{|z_1|, |z_2|}$ and $\mathcal{A}_{W_1, W_2, W_3}$ in Proposition 3.32, we get

$$\begin{aligned} (T_{\tilde{\gamma}}^{-1} \boxtimes_{P(z_2)} 1_{W_3}) \circ \mathcal{A}_{z_1, z_2} \circ T_\gamma \\ = (T_{1 \rightarrow z_1-z_2} \boxtimes_{P(z_2)} 1_{W_3}) \circ T_{1 \rightarrow z_2} \circ \mathcal{A}_{W_1, W_2, W_3} \circ T_{z_1 \rightarrow 1} \circ (1_{W_1} \boxtimes_{P(z_1)} T_{z_2 \rightarrow 1}) \end{aligned} \quad (3.19)$$

for any modules W_1, W_2, W_3 in \mathcal{C} and $(z_1, z_2) \in (\mathbb{C}^\times)^2$ such that $|z_1| > |z_2| > |z_1 - z_2| > 0$. The paths γ and $\tilde{\gamma}$ depend only on (z_1, z_2) and not on W_1, W_2, W_3 .

3.3.6 Existence of vertex tensor category structure

In the tensor-categorical constructions on \mathcal{C} above, the vertex tensor category structure consists in the tensor products, unit, and braiding isomorphisms defined for each $z \in \mathbb{C}^\times$; the associativity isomorphisms \mathcal{A}_{z_1, z_2} defined for $|z_1| > |z_2| > |z_1 - z_2| > 0$; and the parallel transport isomorphisms. We have seen how braided monoidal supercategory structure, using $\boxtimes = \boxtimes_{P(1)}$ as the tensor functor, can be obtained from the vertex tensor category structure using parallel transports. However, the existence of vertex tensor category structure on \mathcal{C} is in general a hard question because several analytic and algebraic assumptions on \mathcal{C} are imposed in [HLZ1]-[HLZ8]. Here we review these assumptions and discuss some results showing when these assumptions hold.

So far, we have assumed that \mathcal{C} is a full subcategory of V -modules, all modules in \mathcal{C} are \mathbb{R} -graded by conformal weights, and the Jordan block sizes of $L(0)$ acting on the conformal weight spaces $W_{[n]}$, $n \in \mathbb{R}$, are uniformly bounded for each module in \mathcal{C} (recall Assumption 3.9). We have also assumed convergence for compositions of intertwining maps (recall Assumption 3.17). Based on Assumption 10.1 in [HLZ6] and Assumption 12.1 in [HLZ8], we impose:

Assumption 3.34. The vertex operator superalgebra V is an object of \mathcal{C} , and \mathcal{C} is closed under images, contragredients, finite direct sums, $P(z)$ -tensor products for at least one (equivalently, all) $z \in \mathbb{C}^\times$.

In discussing the associativity isomorphisms in \mathcal{C} , we showed how the convergence condition for intertwining maps implies the existence of triple tensor product elements of the forms $w_1 \boxtimes_{P(z_1)} (w_2 \boxtimes_{P(z_2)} w_3)$ and $(w_1 \boxtimes_{P(z_1-z_2)} w_2) \boxtimes_{P(z_2)} w_3$. However, this is not enough for the existence of associativity isomorphisms relating these triple tensor product elements. For this, sufficient conditions are given in [HLZ7, Theorem 11.4]. First, we say that a V -module W is *lower bounded* if $W_{[n]} = 0$ for $n \in \mathbb{R}$ sufficiently negative.

Assumption 3.35. Every finitely-generated lower bounded V -module is an object of \mathcal{C} , and the *convergence and extension property* for either products or iterates of intertwining operators in \mathcal{C} holds. See [HLZ7] for the technical statement of the convergence and extension property. Essentially, for a product of intertwining operators of the form

$$\langle w'_4, \mathcal{Y}_1(w_1, z_1) \mathcal{Y}_2(w_2, z_2) w_3 \rangle, \quad (3.20)$$

the convergence and extension property holds if (3.20) converges absolutely to a multivalued analytic function on $|z_1| > |z_2| > 0$ and can be analytically continued to a multivalued analytic function on $|z_2| > |z_1 - z_2| > 0$ with at worst logarithmic singularities at $z_1 = z_2$ and $z_2 = 0$. The convergence and extension property for iterates is similar.

Remark 3.36. The condition that every finitely-generated lower bounded V -module is an object of \mathcal{C} is not strictly necessary. In fact, only certain specific finitely-generated lower bounded V -modules appearing in the proof of [HLZ7, Theorem 11.4] must be in \mathcal{C} (see [Hu10]). Since the first version of this paper was written, there has been progress in verifying this weaker condition in the case that \mathcal{C} is the category of C_1 -cofinite V -modules; see especially Theorems 3.3.4 and 3.3.5 in [CY].

Finally, to guarantee that the associativity isomorphisms in \mathcal{C} satisfy the pentagon axiom, we need to require that products of three intertwining operators in \mathcal{C} converge to suitable multivalued functions (see Assumption 12.2 in [HLZ8]):

Assumption 3.37. For objects $W_1, W_2, W_3, W_4, W_5, M_1$, and M_2 of \mathcal{C} , intertwining operators $\mathcal{Y}_1, \mathcal{Y}_2$, and \mathcal{Y}_3 of types $\binom{W_5}{W_1 M_1}$, $\binom{M_1}{W_2 M_2}$, and $\binom{M_2}{W_3 W_4}$, respectively, and $z_1, z_2, z_3 \in \mathbb{C}^\times$ satisfying $|z_1| > |z_2| > |z_3| > 0$, the double sum

$$\sum_{m, n \in \mathbb{R}} \langle w'_5, \mathcal{Y}_1(w_1, z_1) \pi_m (\mathcal{Y}_2(w_2, z_2) \pi_n (\mathcal{Y}_3(w_3, z_3) w_4)) \rangle$$

converges absolutely for any $w_1 \in W_1, w_2 \in W_2, w_3 \in W_3, w_4 \in W_4$, and $w'_5 \in W'_5$ and is a restriction to $|z_1| > |z_2| > |z_3| > 0$ of a multivalued analytic function on the region given by $z_i \neq 0, z_i \neq z_j$ for $i = 1, 2, 3$ and $j \neq i$. Moreover, near any possible singular point of the form $z_i = 0, \infty$ or $z_i = z_j$ for $i = 1, 2, 3, j \neq i$, this multivalued function can be expanded as a series having the same form as the expansion around a singular point of a solution to a differential equation with regular singular points.

Remark 3.38. In practice, one shows that Assumptions 3.35 and 3.37 hold by showing that products and iterates of intertwining operators are in fact solutions to differential equations with regular singular points (see for instance [Hu3, HL5, Hu5]).

If all assumptions listed so far hold, then \mathcal{C} is a \mathbb{C} -linear monoidal supercategory (see [HLZ8, Theorem 12.15]). In practice, one would like simple conditions on V that guarantee all these assumptions hold. The strongest result of this type so far is due to Huang [Hu8] (and also see [Hu8] for relevant notation):

Theorem 3.39 ([Hu8, Theorem 4.13]). *Let V be a vertex operator algebra satisfying:*

1. V is C_1^a -cofinite,
2. Every irreducible V -module is \mathbb{R} -graded and C_1 -cofinite,
3. There exists a positive integer N that bounds the differences in the lowest conformal weights of any two irreducible modules and such that the N th Zhu algebra $A_N(V)$ is finite dimensional.

Then the category \mathcal{C} of grading-restricted generalized V -modules is a vertex tensor category.

An important consequence of this theorem is the following:

Corollary 3.40 ([Hu8, Proposition 4.1, Theorem 4.13]). *If V is C_2 -cofinite and has positive energy ($V_n = 0$ for $n < 0$ and $V_0 = \mathbb{C}\mathbf{1}$), then the category \mathcal{C} of grading-restricted generalized V -modules is a vertex tensor category.*

Remark 3.41. As mentioned in Remark 3.36, there has been recent progress beyond Theorem 3.39 in verifying the assumptions of this subsection for the category \mathcal{C}_V^1 of C_1 -cofinite modules for a vertex operator algebra V . Especially, results in [CY] show that \mathcal{C}_V^1 is a vertex tensor category if it is closed under contragredients. Moreover, a noteworthy consequence of our results in the following subsections is that if V is known to have a vertex tensor category \mathcal{C} of modules and $A \supseteq V$ is a (super)algebra extension of V in \mathcal{C} , then the category of A -modules in \mathcal{C} is also a vertex tensor category. That is, it is not necessary to directly verify the assumptions in this subsection for the category of A -modules in \mathcal{C} . This idea was recently applied to singlet vertex operator algebras in [CMY1].

3.4 Complex analytic formulation of categorical Rep A -intertwining operators

In this subsection, we begin studying (super)algebra extensions of vertex operator algebras. Here, we fix an ordinary \mathbb{Z} -graded vertex operator algebra V , and we assume that V has a full abelian subcategory \mathcal{C} of modules that has vertex tensor category structure, and thus braided tensor category structure, as described in the previous subsection. Note that in the braided and vertex tensor category structure on \mathcal{C} , all sign factors in the definitions of the previous subsection may be ignored.

Since our goal is to study superalgebra extensions of V in \mathcal{C} , we recall Theorem 3.2 and Remark 3.3 in [HKL], and their generalization to superalgebra extensions in Theorem 3.13 of [CKL]:

Theorem 3.42. *Vertex operator superalgebra extensions A of V in \mathcal{C} such that $V \subseteq A^{\bar{0}}$ are precisely superalgebras (A, μ, ι_A) in the braided tensor category \mathcal{C} which satisfy:*

1. ι_A is injective;
2. A is $\frac{1}{2}\mathbb{Z}$ -graded by conformal weights: $\theta_A^2 = 1_A$ where $\theta_A = e^{2\pi i L_A(0)}$; and
3. μ has no monodromy: $\mu \circ (\theta_A \boxtimes \theta_A) = \theta_A \circ \mu$.

We now fix a vertex operator superalgebra extension A in \mathcal{C} such that $V \subseteq A^{\bar{0}}$, and we recall the braided tensor supercategory \mathcal{SC} and \mathbb{C} -linear monoidal supercategory $\text{Rep } A$ from Section 2. Since objects of \mathcal{C} are vector spaces, as a category we can identify \mathcal{SC} simply with \mathcal{C} , except that morphism spaces in \mathcal{SC} are equipped with superspace structure (coming from parity decompositions of objects in \mathcal{C}). With this identification, tensor products of objects, unit isomorphisms, and associativity isomorphisms in \mathcal{SC} agree with those in \mathcal{C} , but tensor products of morphisms and braiding isomorphisms in \mathcal{SC} come with sign factors. Note also that \mathcal{SC} has the vertex tensor category structure of the previous subsection, with all sign factors included. In fact, \mathcal{SC} is the vertex tensor category of V -modules in \mathcal{C} where V is considered as a vertex operator superalgebra with zero odd component.

Our goal is to identify categorical Rep A -intertwining operators with certain vertex-algebraic intertwining operators among modules in \mathcal{C} . For this purpose, let (W_1, μ_{W_1}) , (W_2, μ_{W_2}) , and (W_3, μ_{W_3}) be objects of $\text{Rep } A$. It is easy to see from Definition 2.44 that a Rep A -intertwining operator of type $\binom{W_3}{W_1 W_2}$ is a \mathcal{C} -morphism $\eta : W_1 \boxtimes W_2 \rightarrow W_3$ such that the following pairs of compositions are equal:

$$\begin{aligned} A \boxtimes (W_1 \boxtimes W_2) &\xrightarrow{\mathbb{A}_{A, W_1, W_2}} (A \boxtimes W_1) \boxtimes W_2 \xrightarrow{\mu_{W_1} \boxtimes 1_{W_2}} W_1 \boxtimes W_2 \xrightarrow{\eta} W_3 \\ A \boxtimes (W_1 \boxtimes W_2) &\xrightarrow{1_A \boxtimes \eta} A \boxtimes W_3 \xrightarrow{\mu_{W_3}} W_3. \end{aligned} \quad (3.21)$$

and

$$\begin{aligned} (W_1 \boxtimes A) \boxtimes W_2 &\xrightarrow{\mathbb{R}_{A, W_1}^{-1} \boxtimes 1_{W_2}} (A \boxtimes W_1) \boxtimes W_2 \xrightarrow{\mu_{W_1} \boxtimes 1_{W_2}} W_1 \boxtimes W_2 \xrightarrow{\eta} W_3 \\ (W_1 \boxtimes A) \boxtimes W_2 &\xrightarrow{\mathbb{A}_{W_1, A, W_2}^{-1}} W_1 \boxtimes (A \boxtimes W_2) \xrightarrow{1_{W_1} \boxtimes \mu_{W_2}} W_1 \boxtimes W_2 \xrightarrow{\eta} W_3, \end{aligned} \quad (3.22)$$

The tensor products of morphisms and braiding isomorphism here are in the supercategory \mathcal{SC} , while the associativity isomorphisms in \mathcal{SC} may be identified with associativity isomorphisms in \mathcal{C} . We would like to show that (3.21) and (3.22) are equivalent to complex analytic associativity and skew-associativity conditions, respectively, for an intertwining operator associated to η .

Now if η is a Rep A -intertwining operator of type $\binom{W_3}{W_1 W_2}$, then $I_\eta = \bar{\eta} \circ \boxtimes$ is a $P(1)$ -intertwining map among a triple of V -modules of type $\binom{W_3}{W_1 W_2}$, and we define the V -intertwining operator $\mathcal{Y}_\eta = \mathcal{Y}_{I_\eta, 0}$; note that

$$\bar{\eta}(w_1 \boxtimes w_2) = \mathcal{Y}_\eta(w_1, e^{\log 1} w_2).$$

For $z \in \mathbb{C}^\times$, let

$$\eta_z = \eta \circ T_{z \rightarrow 1} : W_1 \boxtimes_{P(z)} W_2 \rightarrow W_3.$$

It is clear that $\eta = \eta_1$. Moreover,

$$\begin{aligned} \bar{\eta}_z(w_1 \boxtimes_{P(z)} w_2) &= \overline{\eta \circ T_{z \rightarrow 1}}(w_1 \boxtimes_{P(z)} w_2) \\ &= \bar{\eta}(\mathcal{Y}_{\boxtimes_{P(1)}, 0}(w_1, e^{\log z} w_2)) \\ &= \bar{\eta}\left(e^{\log z L(0)} \mathcal{Y}_{\boxtimes_{P(1)}, 0}(e^{-\log z L(0)} w_1, e^{\log 1} w_2) e^{-\log z L(0)} w_2\right) \\ &= e^{\log z L(0)} \bar{\eta}\left(e^{-\log z L(0)} w_1 \boxtimes e^{-\log z L(0)} w_2\right) \end{aligned}$$

$$\begin{aligned}
&= e^{\log z L(0)} \mathcal{Y}_\eta(e^{-\log z L(0)} w_1, e^{\log 1}) e^{-\log z L(0)} w_2 \\
&= \mathcal{Y}_\eta(w_1, e^{\log z}) w_2
\end{aligned}$$

for any $z \in \mathbb{C}^\times$, $w_1 \in W_1$, and $w_2 \in W_2$. This calculation shows that η_z is the unique morphism induced by the universal property of $W_1 \boxtimes_{P(z)} W_2$ and the $P(z)$ -intertwining map $\mathcal{Y}_\eta(\cdot, e^{\log z})$.

Remark 3.43. For the special case where $\eta = \mu_W$ is a Rep A -intertwining operator of type $\binom{W}{A}$, we set $Y_W = \mathcal{Y}_{\mu_W}$. Then the preceding calculation shows that

$$\overline{\mu_{W;z}}(a \boxtimes_{P(z)} w) = Y_W(a, e^{\log z}) w$$

for $z \in \mathbb{C}^\times$, $a \in A$, and $w \in W$.

Our main theorem in this subsection is the following characterization of Rep A intertwining operators in terms of complex variables. In the proof, we will need technical Proposition 3.69 presented in Section 3.7. The name *skew-associativity* for the second property of \mathcal{Y}_η in the theorem comes from [Ro].

Theorem 3.44. *A parity-homogeneous \mathcal{C} -morphism $\eta : W_1 \boxtimes W_2 \rightarrow W_3$ is a Rep A -intertwining operator if and only if the following two properties hold:*

1. (Associativity) For $a \in A$ homogeneous, $w_1 \in W_1$, $w_2 \in W_2$, $w'_3 \in W'_3$, and $(z_1, z_2) \in S_1$,

$$(-1)^{|\eta||a|} \langle w'_3, Y_{W_3}(a, e^{\log z_1}) \mathcal{Y}_\eta(w_1, e^{\log z_2}) w_2 \rangle = \langle w'_3, \mathcal{Y}_\eta(Y_{W_1}(a, e^{\log(z_1-z_2)}) w_1, e^{\log z_2}) w_2 \rangle. \quad (3.23)$$

In particular, the multivalued analytic functions

$$(-1)^{|\eta||a|} \langle w'_3, Y_{W_3}(a, z_1) \mathcal{Y}_\eta(w_1, z_2) w_2 \rangle$$

on the region $|z_1| > |z_2| > 0$ and

$$\langle w'_3, \mathcal{Y}_\eta(Y_{W_1}(a, z_1 - z_2) w_1, z_2) w_2 \rangle$$

on the region $|z_2| > |z_1 - z_2| > 0$ have equal restrictions to their common domain.

2. (Skew-associativity) For $a \in A$ and $w_1 \in W_1$ homogeneous, $w_2 \in W_2$, $w'_3 \in W'_3$, and $(z_1, z_2) \in S_2$,

$$(-1)^{|a||w_1|} \langle w'_3, \mathcal{Y}_\eta(w_1, e^{\log z_2}) Y_{W_2}(a, e^{\log z_1}) w_2 \rangle = \langle w'_3, \mathcal{Y}_\eta(Y_{W_1}(a, e^{l-1/2(z_1-z_2)}) w_1, e^{\log z_2}) w_2 \rangle. \quad (3.24)$$

In particular, the multivalued functions

$$(-1)^{|a||w_1|} \langle w'_3, \mathcal{Y}_\eta(w_1, z_2) Y_{W_2}(a, z_1) w_2 \rangle$$

on the region $|z_2| > |z_1| > 0$ and

$$\langle w'_3, \mathcal{Y}_\eta(Y_{W_1}(a, z_1 - z_2) w_1, z_2) w_2 \rangle$$

on the region $|z_2| > |z_1 - z_2| > 0$ have equal restrictions to their common domain.

Proof. By Proposition 3.12 and the observation that the regions $|z_1| > |z_2| > |z_1 - z_2| > 0$ and $|z_2| > |z_1|, |z_1 - z_2| > 0$ are connected, it is enough to prove that η is a Rep A -intertwining operator if and only if (3.23) and (3.24) hold. In fact, we will prove that (3.21) is equivalent to (3.23) and that (3.22) is equivalent to (3.24).

First we consider the associativity. Fix $r_1, r_2 \in \mathbb{R}$ such that $r_1 > r_2 > r_1 - r_2 > 0$, and consider the following diagram:

$$\begin{array}{ccc}
A \boxtimes_{P(r_1)} (W_1 \boxtimes_{P(r_2)} W_2) & \xrightarrow{T_{r_1 \rightarrow 1} \circ (1_A \boxtimes_{P(r_1)} T_{r_2 \rightarrow 1})} & A \boxtimes (W_1 \boxtimes W_2) \\
\downarrow 1_A \boxtimes_{P(r_1)} \eta_{r_2} & & \downarrow 1_A \boxtimes \eta \\
A \boxtimes_{P(r_1)} W_3 & \xrightarrow{T_{r_1 \rightarrow 1}} & A \boxtimes W_3 \\
& \searrow \mu_{W_3 ; r_1} & \downarrow \mu_{W_3} \\
& & W_3
\end{array} \quad (3.25)$$

The square commutes by definition of η_{r_2} and the naturality of the parallel transport isomorphisms, and the triangle commutes by definition of $\mu_{W_3; r_1}$. We also consider the diagram:

$$\begin{array}{ccc}
A \boxtimes_{P(r_1)} (W_1 \boxtimes_{P(r_2)} W_2) & \xrightarrow{T_{r_1 \rightarrow 1} \circ (1_A \boxtimes_{P(r_1)} T_{r_2 \rightarrow 1})} & A \boxtimes (W_1 \boxtimes W_2) \\
\mathcal{A}_{r_1, r_2} \downarrow & & \downarrow \underline{\mathcal{A}}_{A, W_1, W_2} \\
(A \boxtimes_{P(r_1-r_2)} W_1) \boxtimes_{P(r_2)} W_2 & \xrightarrow{T_{r_2 \rightarrow 1} \circ (T_{r_1-r_2 \rightarrow 1} \boxtimes_{P(r_2)} 1_{W_2})} & (A \boxtimes W_1) \boxtimes W_2 \\
\mu_{W_1; r_1-r_2} \boxtimes_{P(r_2)} 1_{W_2} \downarrow & & \downarrow \mu_{W_1} \boxtimes 1_{W_2} \\
W_1 \boxtimes_{P(r_2)} W_2 & \xrightarrow{T_{r_2 \rightarrow 1}} & W_1 \boxtimes W_2 \\
& \searrow \eta_{r_2} & \downarrow \eta \\
& & W_3
\end{array} \tag{3.26}$$

In this diagram, the top square commutes by definition of $\mathcal{A}_{A, W_1, W_2}$ (or $\underline{\mathcal{A}}_{A, W_1, W_2}$) and the fact that $T_{z_1 \rightarrow z_2}^{-1} = T_{z_2 \rightarrow z_1}$ for $z_1, z_2 \in \mathbb{C}^\times$. The middle square commutes by definition of $\mu_{W_1; r_1-r_2}$ and naturality of parallel transports, and the bottom triangle commutes by definition of η_{r_2} .

Now, (3.21) translates to the equality of morphisms in the right columns of the two commuting diagrams above. Hence, (3.21) is equivalent to the equality of the left columns. The equality of left columns is the equality of morphisms determined by the following mappings:

$$a \boxtimes_{P(r_1)} (w_1 \boxtimes_{P(r_2)} w_2) \mapsto (-1)^{|\eta||a|} a \boxtimes_{P(r_1)} \mathcal{Y}_\eta(w_1, e^{\log r_2} w_2) \mapsto (-1)^{|\eta||a|} Y_{W_3}(a, e^{\log r_1}) \mathcal{Y}_\eta(w_1, e^{\log r_2} w_2)$$

and

$$\begin{aligned}
a \boxtimes_{P(r_1)} (w_1 \boxtimes_{P(r_2)} w_2) &\mapsto (a \boxtimes_{P(r_1-r_2)} w_1) \boxtimes_{P(r_2)} w_2 \\
&\mapsto Y_{W_1}(a, e^{\log(r_1-r_2)} w_1) \boxtimes_{P(r_2)} w_2 \mapsto \mathcal{Y}_\eta(Y_{W_1}(a, e^{\log(r_1-r_2)} w_1), e^{\log r_2} w_2)
\end{aligned}$$

for all $w_1 \in W_1$, $w_2 \in W_2$, and parity-homogeneous $a \in A$. (Everything is absolutely convergent for the r_1 and r_2 we have chosen.) We therefore deduce that (3.21) implies

$$(-1)^{|\eta||a|} Y_{W_3}(a, e^{\log r_1}) \mathcal{Y}_\eta(w_1, e^{\log r_2} w_2) = \mathcal{Y}_\eta(Y_{W_1}(a, e^{\log(r_1-r_2)} w_1), e^{\log r_2} w_2) \tag{3.27}$$

as elements of $\overline{W_3}$ for all $a \in A$, $w_1 \in W_1$, $w_2 \in W_1$. Then by Proposition 3.18, (3.23) holds for all $(z_1, z_2) \in S_1$.

Conversely, (3.23) for $(z_1, z_2) \in S_1$ implies (3.27) because (r_1, r_2) lies on the boundary of S_1 . Then (3.27) implies the equality of left columns of (3.25) and (3.26), thereby implying the equality of the right columns, that is, (3.21). This completes the proof that (3.21) is equivalent to (3.23).

Now we consider the skew-associativity. Fix $r_1, r_2 \in \mathbb{R}$ such that $r_2 > r_1 > 2(r_2 - r_1) > 0$ (recall Proposition 3.32) and consider the diagram:

$$\begin{array}{ccc}
(W_1 \boxtimes_{P(r_2-r_1)} A) \boxtimes_{P(r_1)} W_2 & \xrightarrow{T_{r_1 \rightarrow 1} \circ (T_{r_2-r_1 \rightarrow 1} \boxtimes_{P(r_1)} 1_{W_2})} & (W_1 \boxtimes A) \boxtimes W_2 \\
\mathcal{A}_{r_2, r_1}^{-1} \downarrow & & \downarrow \mathcal{A}_{W_1, A, W_2}^{-1} \\
W_1 \boxtimes_{P(r_2)} (A \boxtimes_{P(r_1)} W_2) & \xrightarrow{T_{r_2 \rightarrow 1} \circ (1_{W_1} \boxtimes_{P(r_2)} T_{r_1 \rightarrow 1})} & W_1 \boxtimes (A \boxtimes W_2) \\
1_{W_1} \boxtimes_{P(r_2)} \mu_{W_2; r_1} \downarrow & & \downarrow 1_{W_1} \boxtimes \mu_{W_2} \\
W_1 \boxtimes_{P(r_2)} W_2 & \xrightarrow{T_{r_2 \rightarrow 1}} & W_1 \boxtimes W_2 \\
& \searrow \eta_{r_2} & \downarrow \eta \\
& & W_3
\end{array} \tag{3.28}$$

This diagram commutes for the same reasons as does (3.26). Moreover, the composition of morphisms in the left column is the morphism uniquely determined by

$$(w_1 \boxtimes_{P(r_2-r_1)} a) \boxtimes_{P(r_1)} w_2 \mapsto \mathcal{Y}_\eta(w_1, e^{\log r_2}) Y_{W_2}(a, e^{\log r_1} w_2)$$

for $w_1 \in W_1$, $a \in A$, and $w_2 \in W_2$. We also consider the diagram:

$$\begin{array}{ccc}
(W_1 \boxtimes_{P(r_2-r_1)} A) \boxtimes_{P(r_1)} W_2 & \xrightarrow{T_{r_1 \rightarrow 1} \circ (T_{r_2-r_1 \rightarrow 1} \boxtimes_{P(r_1)} 1_{W_2})} & (W_1 \boxtimes A) \boxtimes W_2 \\
\downarrow (\mathcal{R}_{P(r_2-r_1)}^- \boxtimes_{P(r_2)} 1_{W_2}) \circ T_{r_1 \rightarrow r_2} & & \downarrow \mathcal{R}_{A, W_1}^{-1} \boxtimes 1_{W_2} \\
(A \boxtimes_{P(r_1-r_2)} W_1) \boxtimes_{P(r_2)} W_2 & \xrightarrow{T_{r_2 \rightarrow 1} \circ (T_{r_1-r_2 \rightarrow 1} \boxtimes_{P(r_2)} 1_{W_2})} & (A \boxtimes W_1) \boxtimes W_2 \\
\downarrow \mu_{W_1; r_1-r_2} \boxtimes_{P(r_2)} 1_{W_2} & & \downarrow \mu_{W_1} \boxtimes 1_{W_2} \\
W_1 \boxtimes_{P(r_2)} W_2 & \xrightarrow{T_{r_2 \rightarrow 1}} & W_1 \boxtimes W_2 \\
& \searrow \eta_{r_2} & \downarrow \eta \\
& & W_3
\end{array} \tag{3.29}$$

The top square commutes by Proposition 3.29, the naturality of the parallel transport isomorphisms, and Proposition 3.25. The middle square commutes by naturality of parallel transports and the definition of $\mu_{W_1; r_1-r_2}$, and the triangle commutes by definition of η_{r_2} . Using Proposition 3.69 below, the composition of the left arrows is the morphism determined by:

$$\begin{aligned}
& (w_1 \boxtimes_{P(r_2-r_1)} a) \boxtimes_{P(r_1)} w_2 \mapsto (-1)^{|a||w_1|} \left(\mathcal{Y}_{\boxtimes_{P(r_1-r_2)}, 0}(a, e^{l_{-1/2}(r_1-r_2)}) w_1 \right) \boxtimes_{P(r_2)} w_2 \\
& = (-1)^{|a||w_1|} \left(e^{(l_{-1/2}-\log)(r_1-r_2)L(0)} \cdot \left(e^{-(l_{-1/2}-\log)(r_1-r_2)L(0)} a \boxtimes_{P(r_1-r_2)} e^{-(l_{-1/2}-\log)(r_1-r_2)L(0)} w_1 \right) \right) \boxtimes_{P(r_2)} w_2 \\
& \mapsto (-1)^{|a||w_1|} \left(e^{(l_{-1/2}-\log)(r_1-r_2)L(0)} \cdot Y_{W_1}(e^{-(l_{-1/2}-\log)(r_1-r_2)L(0)} a, e^{\log(r_1-r_2)}) e^{-(l_{-1/2}-\log)(r_1-r_2)L(0)} w_1 \right) \boxtimes_{P(r_2)} w_2 \\
& = (-1)^{|a||w_1|} Y_{W_1}(a, e^{l_{-1/2}(r_1-r_2)}) w_1 \boxtimes_{P(r_2)} w_2 \\
& \mapsto (-1)^{|a||w_1|} \mathcal{Y}_\eta(Y_{W_1}(a, e^{l_{-1/2}(r_1-r_2)}) w_1, e^{\log r_2}) w_2
\end{aligned}$$

for all $w_2 \in W_2$ and parity-homogeneous $w_1 \in W_1$, $a \in A$.

Now, the equality of the morphisms in (3.22) translates to the equality of the right arrows in the two diagrams above, which implies the equality of the left arrows. Thus (3.22) implies

$$(-1)^{|a||w_1|} \mathcal{Y}_\eta(w_1, e^{\log r_2}) Y_{W_2}(a, e^{\log r_1}) w_2 = \mathcal{Y}_\eta(Y_{W_1}(a, e^{l_{-1/2}(r_1-r_2)}) w_1, e^{\log r_2}) w_2 \tag{3.30}$$

as elements of $\overline{W_3}$. Then Proposition 3.20 implies that (3.24) holds for all $(z_1, z_2) \in S_2$.

Conversely, if (3.24) holds for all $(z_1, z_2) \in S_2$, then (3.30) follows because (r_1, r_2) is in the boundary of S_2 . This means that the compositions of morphisms in the left columns of (3.28) and (3.29) are equal, so that the right columns are equal as well. Thus the equality of the morphisms in (3.22) follows. \square

Remark 3.45. For a parity-homogeneous Rep A -intertwining operator η of type $\binom{W_3}{W_1 W_2}$, we can combine the associativity and skew-associativity properties of the corresponding intertwining operator \mathcal{Y}_η to obtain the following commutativity property: For any $w_2 \in W_2$, $w'_3 \in W'_3$, and parity-homogeneous $a \in A$, $w_1 \in W_1$, the multivalued analytic functions

$$(-1)^{|\eta||a|} \langle w'_3, Y_{W_3}(a, z_1) \mathcal{Y}_\eta(w_1, z_2) w_2 \rangle$$

on the region $|z_1| > |z_2| > 0$ and

$$(-1)^{|a||w_1|} \langle w'_3, \mathcal{Y}_\eta(w_1, z_2) Y_{W_2}(a, z_1) w_2 \rangle$$

on the region $|z_2| > |z_1| > 0$ are analytic extensions of each other. Specifically, the branch

$$(-1)^{|a||w_1|} \langle w'_3, \mathcal{Y}_\eta(w_1, e^{\log z_2}) Y_{W_2}(a, e^{\log z_1}) w_2 \rangle$$

of $(-1)^{|a||w_1|} \langle w'_3, \mathcal{Y}_\eta(w_1, z_2) Y_{W_2}(a, z_1) w_2 \rangle$ on S_2 is determined by the branch

$$(-1)^{|\eta||a|} \langle w'_3, Y_{W_3}(a, e^{\log z_1}) \mathcal{Y}_\eta(w_1, e^{\log z_2}) w_2 \rangle$$

of $(-1)^{|\eta||a|} \langle w'_3, Y_{W_3}(a, z_1) \mathcal{Y}_\eta(w_1, z_2) w_2 \rangle$ on S_1 and a certain path γ contained in the region $|z_2| > |z_1 - z_2| > 0$. We can choose the path γ as follows. Choose $r_1, r_2 \in \mathbb{R}$ such that $r_1 > r_2 > r_1 - r_2 > 0$ (so that (r_1, r_2) is on the border of S_1), and let γ be the path from (r_1, r_2) to $(r_1, 2r_1 - r_2)$ obtained by holding r_1 fixed and moving r_2 to $2r_1 - r_2$ clockwise along the semicircle in the upper half plane whose center is r_1 and radius $r_1 - r_2$. Notice that $(r_1, 2r_1 - r_2)$ is on the border of S_2 , and that along this path, $\log(r_1 - r_2)$ changes continuously to $l_{-1/2}(r_1 - (2r_1 - r_2))$.

3.5 Vertex tensor category structure on $\text{Rep}^0 A$

In this subsection we interpret the monoidal supercategory structure on $\text{Rep} A$ and the braided monoidal supercategory structure on $\text{Rep}^0 A$ using vertex-algebraic intertwining operators. This will allow us to show that the braided monoidal supercategory structure on $\text{Rep}^0 A$ constructed in [KO] and reviewed in Section 2 agrees with the vertex-algebraic braided monoidal supercategory structure on the category of grading-restricted generalized A -modules in \mathcal{C} constructed in [HLZ8] and reviewed in Section 3.3.

3.5.1 Objects in $\text{Rep} A$ and $\text{Rep}^0 A$

First we describe objects and morphisms in $\text{Rep} A$ in terms of intertwining operators:

Proposition 3.46. *An object of $\text{Rep} A$ amounts to a V -module W equipped with an even V -intertwining operator Y_W of type $\binom{W}{AW}$ that satisfies the following properties:*

1. (Associativity) For $a_1, a_2 \in A$, $w \in W$, $w' \in W'$, and $(z_1, z_2) \in S_1$,

$$\langle w', Y_W(a_1, e^{\log z_1}) Y_W(a_2, e^{\log z_2}) w \rangle = \langle w', Y_W(Y(a_1, e^{\log(z_1 - z_2)}) a_2, e^{\log z_2}) w \rangle.$$

In particular, the multivalued analytic functions

$$\langle w', Y_W(a_1, z_1) Y_W(a_2, z_2) w \rangle$$

on the region $|z_1| > |z_2| > 0$ and

$$\langle w', Y_W(Y(a_1, z_1 - z_2) a_2, z_2) w \rangle$$

on the region $|z_2| > |z_1 - z_2| > 0$ have equal restrictions to their common domain.

2. (Unit) $Y_W(\mathbf{1}, x) = 1_W$, or equivalently, $Y_W|_{V \otimes W}$ is the vertex operator of V acting on W .

Parity-homogeneous morphisms in $\text{Rep} A$ amount to parity-homogeneous V -module homomorphisms $f : W_1 \rightarrow W_2$ such that

$$f(Y_{W_1}(a, x) w_1) = (-1)^{|f||a|} Y_{W_2}(a, x) f(w_1)$$

for $w_1 \in W_1$ and parity-homogeneous $a \in A$.

Proof. Given an object (W, μ_W) of $\text{Rep} A$ as defined in Definition 2.29, we recall from Remark 3.43 the V -intertwining operator Y_W of type $\binom{W}{AW}$ characterized by

$$\overline{\mu_W}(a \boxtimes w) = Y_W(a, e^{\log 1}) w \tag{3.31}$$

for $a \in A$ and $w \in W$. Conversely, given a V -intertwining operator Y_W of type $\binom{W}{AW}$, the universal property of $A \boxtimes W$ implies there is a unique V -homomorphism $\mu_W : A \boxtimes W \rightarrow W$ such that (3.31) holds. By (3.31), the intertwining operator Y_W is even if and only if μ_W is even. So we need to show that the associativity and unit properties for Y_W in the proposition are equivalent to the associativity and unit properties of μ_W in Definition 2.29.

For the associativity, Theorem 3.44 and its proof imply that the associativity for Y_W in the statement of the proposition is equivalent to the equality

$$\mu_W \circ (1_A \boxtimes \mu_W) = \mu_W \circ (\mu \boxtimes 1_W) \circ \underline{A}_{A, A, W},$$

which is the associativity property for μ_W in Definition 2.29.

For the unit property, consider the diagram

$$\begin{array}{ccccc} W & \xrightarrow{\iota_{P(z)}^{-1}} & V \boxtimes_{P(z)} W & \xrightarrow{\iota_{A \boxtimes P(z)} 1_W} & A \boxtimes_{P(z)} W & \xrightarrow{\mu_{W; z}} & W \\ & \searrow \iota_W^{-1} & \downarrow T_{z \rightarrow 1} & & \downarrow T_{z \rightarrow 1} & \nearrow \mu_W & \\ & & V \boxtimes W & \xrightarrow{\iota_{A \boxtimes 1_W}} & A \boxtimes W & & \end{array}$$

for $z \in \mathbb{C}^\times$. The square commutes by naturality of the parallel transport isomorphisms, and the right triangle commutes by the definition of $\mu_{W;z}$ from the previous subsection. Recall also from Remark 3.43 that

$$\overline{\mu_{W;z}}(a \boxtimes_{P(z)} w) = Y_W(a, e^{\log z})w$$

for $a \in A$ and $w \in W$. To see that the left triangle in the diagram commutes, we calculate, recalling the definition of $l_{P(z)}$ and temporarily using \tilde{Y}_W to denote the vertex operator of V acting on W :

$$\begin{aligned} \overline{l_{P(z)} \circ T_{1 \rightarrow z}}(v \boxtimes w) &= \overline{l_{P(z)}}(\mathcal{Y}_{\boxtimes_{P(z)},0}(v, e^{\log 1})w) \\ &= \overline{l_{P(z)}}\left(e^{-\log z L(0)} \mathcal{Y}_{\boxtimes_{P(z)},0}(e^{\log z L(0)}v, e^{\log z})e^{\log z L(0)}w\right) \\ &= e^{-\log z L(0)} \overline{l_{P(z)}}\left(e^{\log z L(0)}v \boxtimes_{P(z)} e^{\log z L(0)}w\right) \\ &= e^{-\log z L(0)} \tilde{Y}_W(e^{\log z L(0)}, z)e^{\log z L(0)}w \\ &= \tilde{Y}_W(v, 1)w = l_W(v \boxtimes w) \end{aligned}$$

for any $v \in V$ and $w \in W$, so indeed $l_W = l_{P(z)} \circ T_{1 \rightarrow z}$.

Now, the unit property for μ_W holds if and only if the bottom (or equivalently, the top) row of the diagram equals the identity on W . The top row is given by the mapping

$$\tilde{Y}_W(v, z)w \mapsto v \boxtimes_{P(z)} w \mapsto v \boxtimes_{P(z)} w \mapsto Y_W(v, e^{\log z})w,$$

since ι_A is simply the inclusion of V into A . This is the identity if and only if

$$\tilde{Y}_W(v, z) = Y_W(v, e^{\log z})w$$

for any $v \in V$ and $w \in W$, or equivalently by Proposition 3.15,

$$\tilde{Y}_W(v, x)w = Y_W(v, x)w$$

for $v \in V$ and $w \in W$. Thus the unit property for μ_W holds if and only if $\tilde{Y}_W = Y_W|_{V \otimes W}$. In particular, taking $v = \mathbf{1}$ yields $Y_W(\mathbf{1}, x) = 1_W$ for an object of $\text{Rep } A$. But in fact $Y_W(\mathbf{1}, x) = 1_W$ is also equivalent to the unit property for μ_W because the composition in the top row in the diagram is also given by

$$w \mapsto \mathbf{1} \boxtimes_{P(z)} w \mapsto Y_W(\mathbf{1}, e^{\log z})w,$$

which equals the identity on W if and only if $Y_W(\mathbf{1}, x) = 1_W$.

Now we show that a parity-homogeneous V -module homomorphism $f : W_1 \rightarrow W_2$ between two modules in $\text{Rep } A$ is a parity-homogeneous $\text{Rep } A$ -morphism in the sense of Definition 2.29 if and only if

$$f(Y_{W_1}(a, x)w_1) = (-1)^{|f||a|}Y_{W_2}(a, x)f(w_1)$$

for any $w_1 \in W_1$ and parity-homogeneous $a \in A$. The diagrams

$$\begin{array}{ccccc} A \boxtimes_{P(z)} W_1 & \xrightarrow{\mu_{W_1;z}} & W_1 & \xrightarrow{f} & W_2 \\ T_{z \rightarrow 1} \downarrow & \nearrow \mu_{W_1} & & & \\ A \boxtimes W_1 & & & & \end{array}$$

and

$$\begin{array}{ccccc} A \boxtimes_{P(z)} W_1 & \xrightarrow{1_A \boxtimes_{P(z)} f} & A \boxtimes_{P(z)} W_2 & \xrightarrow{\mu_{W_2;z}} & W_2 \\ T_{z \rightarrow 1} \downarrow & & T_{z \rightarrow 1} \downarrow & \nearrow \mu_{W_2} & \\ A \boxtimes W_1 & \xrightarrow{1_A \boxtimes f} & A \boxtimes W_2 & & \end{array}$$

commute for any $z \in \mathbb{C}^\times$ by the naturality of the parallel transport isomorphisms and the definitions of $\mu_{W_1;z}$ and $\mu_{W_2;z}$. Thus using (3.7),

$$f \circ \mu_{W_1} = \mu_{W_2} \circ (1_A \boxtimes f)$$

if and only if

$$\bar{f}(Y_{W_1}(a, e^{\log z})w_1) = (-1)^{|f||a|}Y_{W_2}(a, e^{\log z})f(w_1)$$

for $w_1 \in W_1$ and parity-homogeneous $a \in A$, or equivalently by Proposition 3.15, if and only if

$$f(Y_{W_1}(a, x)w_1) = (-1)^{|f||a|}Y_{W_2}(a, x)f(w_1)$$

for $w_1 \in W_1$ and parity-homogeneous $a \in A$. \square

Remark 3.47. Suppose we are given a V -module W with a V -intertwining operator of type $\binom{W}{AW}$ that satisfies associativity and unit property as in Proposition 3.46. Then, since (W, μ_W) is an object of $\text{Rep } A$, μ_W is a $\text{Rep } A$ -intertwining operator and Theorem 3.44 shows that Y_W also satisfies skew-associativity: For any $w \in W$, $w' \in W'$, parity-homogeneous $a_1, a_2 \in A$, and $(z_1, z_2) \in S_2$,

$$(-1)^{|a_1||a_2|}\langle w', Y_W(a_2, e^{\log z_2})Y_W(a_1, e^{\log z_1})w \rangle = \langle w'_3, Y_W(Y_W(a_1, e^{-1/2(z_1-z_2)})a_2, e^{\log z_2})w \rangle.$$

In particular, the multivalued analytic functions

$$(-1)^{|a_1||a_2|}\langle w', Y_W(a_2, z_2)Y_W(a_1, z_1)w \rangle$$

on the region $|z_2| > |z_1| > 0$ and

$$\langle w', Y_W(Y_W(a_1, z_1 - z_2)a_2, z_2)w \rangle$$

on the region $|z_2| > |z_1 - z_2| > 0$ have equal restrictions to their common domain.

The vertex-algebraic characterization of the category $\text{Rep}^0 A$ was given in [HKL, Theorem 3.4] and in [CKL, Theorem 3.14] for the superalgebra setting:

Proposition 3.48. *An object (W, Y_W) of $\text{Rep } A$ is an object of $\text{Rep}^0 A$ if and only if (W, Y_W) is a grading-restricted generalized A -module in the category \mathcal{C} .*

Since this proposition is in [HKL, CKL] we only briefly discuss its proof. From (3.15), a $\text{Rep } A$ -module (W, Y_W) is in $\text{Rep}^0 A$ if and only if

$$Y_W(a, x)w = Y_W(a, e^{2\pi i}x)w$$

for $a \in A$ and $w \in W$. This condition will hold if and only if Y_W involves only integral powers of the formal variable x , so that W is in $\text{Rep}^0 A$ if and only if $Y_W(a, x)w \in W[[x, x^{-1}]]$ for $a \in A$ and $w \in W$, as is the case with grading-restricted generalized A -modules. The grading restriction conditions, vacuum property, and Virasoro algebra properties for a grading-restricted generalized A -module follow because W is a grading-restricted generalized V -module and from the unit property of an object in $\text{Rep } A$. Lower truncation and the $L(-1)$ -derivative property follow because Y_W is a V -intertwining operator. Finally, the Jacobi identity for Y_W is equivalent to the associativity of Y_W and the skew-symmetry of the vertex operator Y on A , as in the proof of [HKL, Theorem 3.2].

3.5.2 Intertwining operators and tensor products in $\text{Rep } A$ and $\text{Rep}^0 A$

Now we relate the tensor product \boxtimes_A on $\text{Rep } A$ and $\text{Rep}^0 A$ to intertwining operators. Suppose W_1, W_2 , and W_3 are three modules in $\text{Rep } A$.

Definition 3.49. An A -intertwining operator of type $\binom{W_3}{W_1 W_2}$ is any sum of even and odd V -intertwining operators which satisfy the associativity and skew-associativity conditions of Theorem 3.44

Equivalently by Theorem 3.44, a V -intertwining operator \mathcal{Y} of type $\binom{W_3}{W_1 W_2}$ is an A -intertwining operator if and only if the unique V -module homomorphism $\eta_{\mathcal{Y}} : W_1 \boxtimes W_2 \rightarrow W_3$ induced by $\mathcal{Y}(\cdot, e^{\log 1})$ and the universal property of $W_1 \boxtimes W_2$ is a categorical $\text{Rep } A$ -intertwining operator.

For a pair of modules W_1 and W_2 in $\text{Rep } A$, we denote by \mathcal{Y}_{W_1, W_2} the A -intertwining operator $\mathcal{Y}_{\eta_{W_1, W_2}}$ induced by the $\text{Rep } A$ -intertwining operator $\eta_{W_1, W_2} : W_1 \boxtimes W_2 \rightarrow W_1 \boxtimes_A W_2$. Then $W_1 \boxtimes_A W_2$ satisfies the following universal property:

Proposition 3.50. *For any module W_3 in $\text{Rep } A$ and A -intertwining operator \mathcal{Y} of type $\binom{W_3}{W_1 W_2}$, there is a unique $\text{Rep } A$ -morphism $f : W_1 \boxtimes_A W_2 \rightarrow W_3$ such that $f \circ \mathcal{Y}_{W_1, W_2} = \mathcal{Y}$.*

Proof. If \mathcal{Y} is an A -intertwining operator of type $\binom{W_3}{W_1 W_2}$, let $\eta_{\mathcal{Y}} : W_1 \boxtimes W_2 \rightarrow W_3$ be the unique $\text{Rep } A$ -intertwining operator such that $\eta_{\mathcal{Y}} \circ \boxtimes = \mathcal{Y}(\cdot, e^{\log 1})$. Then by Proposition 2.47, there is a unique $\text{Rep } A$ -morphism $f : W_1 \boxtimes_A W_2 \rightarrow W_3$ such that $f \circ \eta_{W_1, W_2} = \eta_{\mathcal{Y}}$. Thus for $w_1 \in W_1$ and $w_2 \in W_2$,

$$\mathcal{Y}(w_1, e^{\log 1})w_2 = \overline{\eta_{\mathcal{Y}}}(w_1 \boxtimes w_2) = \overline{f \circ \eta_{W_1, W_2}}(w_1 \boxtimes w_2) = \overline{f}(\mathcal{Y}_{W_1, W_2}(w_1, e^{\log 1})w_2).$$

By Proposition 3.15, it follows that $\mathcal{Y}(w_1, x)w_2 = f(\mathcal{Y}_{W_1, W_2}(w_1, x)w_2)$, as desired. \square

Remark 3.51. For any $z \in \mathbb{C}^\times$ and modules W_1, W_2 in $\text{Rep } A$, we can define $W_1 \boxtimes_{P(z)}^A W_2$ to be the object $W_1 \boxtimes_A W_2$ of $\text{Rep } A$ equipped with the $P(z)$ -intertwining map $\boxtimes_{P(z)}^A = \mathcal{Y}_{W_1, W_2}(\cdot, e^{\log z})$. Then the same kind of argument as in the preceding proposition shows that this module and $P(z)$ -intertwining map satisfy a universal property for an appropriate notion of $P(z)$ -intertwining map in $\text{Rep } A$. We will use this $P(z)$ -tensor product in $\text{Rep } A$ to obtain some elements of vertex tensor category structure on $\text{Rep } A$ below, although $\text{Rep } A$ will not have parallel transport or braiding isomorphisms.

It is clear from the characterization (2.12) of tensor products of morphisms in $\text{Rep } A$, and the characterization (3.7) of tensor products of morphisms in \mathcal{C} , that for any morphisms $f_1 : W_1 \rightarrow \widetilde{W}_1$ and $f_2 : W_2 \rightarrow \widetilde{W}_2$ in $\text{Rep } A$, with f_2 parity-homogeneous, we have

$$\overline{f_1 \boxtimes_A f_2}(\mathcal{Y}_{W_1, W_2}(w_1, e^{\log 1})w_2) = (-1)^{|f_2||w_1|} \mathcal{Y}_{\widetilde{W}_1, \widetilde{W}_2}(f_1(w_1), e^{\log 1})f_2(w_2)$$

for $w_2 \in W_2$ and parity-homogeneous $w_1 \in W_1$. Equivalently,

$$(f_1 \boxtimes_A f_2)(\mathcal{Y}_{W_1, W_2}(w_1, x)w_2) = (-1)^{|f_2||w_1|} \mathcal{Y}_{\widetilde{W}_1, \widetilde{W}_2}(f_1(w_1), x)f_2(w_2)$$

for $w_2 \in W_2$ and parity-homogeneous $w_1 \in W_1$.

Remark 3.52. For any $z \in \mathbb{C}^\times$, if we use the notation $f_1 \boxtimes_A f_2 = f_1 \boxtimes_{P(z)}^A f_2$ when we view $f_1 \boxtimes_A f_2$ as a morphism between $P(z)$ -tensor products, we have

$$\overline{f_1 \boxtimes_{P(z)}^A f_2}(w_1 \boxtimes_{P(z)}^A w_2) = (-1)^{|f_2||w_1|} f_1(w_1) \boxtimes_{P(z)}^A f_2(w_2)$$

for $w_2 \in W_2$ and parity-homogeneous $w_1 \in W_1$.

Now we consider the tensor product on $\text{Rep}^0 A$. Since $\text{Rep}^0 A$ is the category of grading-restricted generalized A -modules in \mathcal{C} , we have two tensor products on $\text{Rep}^0 A$: the tensor product \boxtimes_A on $\text{Rep } A$ and the vertex-algebraic tensor product of A -modules from [HLZ3]. Thus to apply all results regarding \boxtimes_A to the vertex-algebraic category of A -modules, it is critical to show these tensor products are the same. To do so, we must show that the notion of A -intertwining operator defined above among objects of $\text{Rep}^0 A$ agrees with the notion of (logarithmic) intertwining operator among grading-restricted generalized modules for A as a vertex operator superalgebra. To prove this, we need the following theorem:

Theorem 3.53. *Given a vertex operator superalgebra A and grading-restricted generalized A -modules W_1, W_2 , and W_3 , consider a parity-homogeneous map*

$$\begin{aligned} \mathcal{Y} : W_1 \otimes W_2 &\longrightarrow W_3[\log x]\{x\} \\ w_1 \otimes w_2 &\longmapsto \mathcal{Y}(w_1, x)w_2 = \sum_{n \in \mathbb{C}} \sum_{k \in \mathbb{Z}} (w_1)_{n; k}^{\mathcal{Y}} w_2 x^{-n-1} (\log x)^k \end{aligned}$$

that satisfies the following properties:

1. Lower truncation: For any $w_1 \in W_1, w_2 \in W_2$ and $n \in \mathbb{C}$, $(w_1)_{n+m; k}^{\mathcal{Y}} w_2 = 0$ for sufficiently large $m \in \mathbb{N}$ independently of k .
2. The $L(-1)$ -derivative formula: $[L(-1), \mathcal{Y}(w_1, x)] = \frac{d}{dx} \mathcal{Y}(w_1, x) = \mathcal{Y}(L(-1)w_1, x)$ for $w_1 \in W_1$.
3. The $L(0)$ -bracket formula: $[L(0), \mathcal{Y}(w_1, x)] = x \frac{d}{dx} \mathcal{Y}(w_1, x) + \mathcal{Y}(L(0)w_1, x)$ for $w_1 \in W_1$.
4. Given $w'_3 \in W'_3, w_2 \in W_2$, and parity-homogeneous $a \in A, w_1 \in W_1$, the following series define multivalued analytic functions on the indicated domains that have equal restrictions to their respective intersections:

$$(-1)^{|\mathcal{Y}||a|} \langle w'_3, Y_{W_3}(a, z_1) \mathcal{Y}(w_1, z_2) w_2 \rangle \quad |z_1| > |z_2| > 0 \quad (3.32)$$

$$\langle w'_3, \mathcal{Y}(Y_{W_1}(a, z_1 - z_2) w_1, z_2) w_2 \rangle \quad |z_2| > |z_1 - z_2| > 0 \quad (3.33)$$

$$(-1)^{|a||w_1|} \langle w'_3, \mathcal{Y}(w_1, z_2) Y_{W_2}(a, z_1) w_2 \rangle \quad |z_2| > |z_1| > 0. \quad (3.34)$$

Moreover, the principal branches (that is, $z_2 = e^{\log z_2}$) of the first and second multivalued functions yield single-valued functions that are equal on the simply-connected domain S_1 , and the principal branches of the second and third multivalued functions yield single-valued functions that are equal on the simply connected domain S_2 .

5. There exists a multivalued analytic function f defined on $\{(z_1, z_2) \in \mathbb{C}^2 \mid z_1, z_2, z_1 - z_2 \neq 0\}$ that restricts to the three multivalued functions above on their respective domains.

Then \mathcal{Y} is a logarithmic intertwining operator of type $\binom{W_3}{W_1 W_2}$ in the sense of Definition 3.7. In particular, \mathcal{Y} satisfies the Jacobi identity.

Proof. First fix $z_2 \in \mathbb{C}^\times$ such that $\operatorname{Re} z_2, \operatorname{Im} z_2 > 0$. Then $f_{z_2}(z_1) = f(z_1, e^{\log z_2})$ yields a possibly multivalued analytic function of z_1 defined on $\{z_1 \in \mathbb{C}^\times \mid z_1 \neq z_2\}$. However, $f_{z_2}(z_1)$ has single-valued restrictions to each of $\{z_1 \in \mathbb{C}^\times \mid |z_1| > |z_2|\}$, $\{z_1 \in \mathbb{C}^\times \mid |z_2| > |z_1 - z_2| > 0\}$ and $\{z_1 \in \mathbb{C}^\times \mid |z_2| > |z_1|\}$, and these restrictions are equal on certain simply-connected subsets of the intersections of these domains. Thus these restrictions define a single-valued analytic function on the union of these domains. This implies that f_{z_2} has a single-valued restriction \tilde{f}_{z_2} to $\mathbb{C}^\times \setminus \{z_2\}$ as follows:

Fix z'_1 such that, say, $(z'_1, z_2) \in S_2$, so that z'_1 is in the domain of both the iterate (3.33) and the product (3.34). Then define \tilde{f}_{z_2} by restricting the values of f_{z_2} at $z_1 \in \mathbb{C}^\times \setminus \{z_2\}$ to be only those obtainable by analytic continuation along paths in $\mathbb{C}^\times \setminus \{z_2\}$ from z'_1 to z_1 , starting with the value $\langle w'_3, \mathcal{Y}(Y_{W_1}(a, z'_1 - z_2)w_1, e^{\log z_2})w_2 \rangle$ (or equivalently, $(-1)^{|a||w_1|} \langle w'_3, \mathcal{Y}(w_1, e^{\log z_2})Y_{W_2}(a, z'_1)w_2 \rangle$) of $f_{z_2}(z'_1)$.

To show that \tilde{f}_{z_2} is actually single-valued, we need to show that for any $z_1 \in \mathbb{C}^\times \setminus \{z_2\}$ and any two paths γ_1 and γ_2 in $\mathbb{C}^\times \setminus \{z_2\}$ from z'_1 to z_1 , the values of $f_{z_2}(z_1)$ determined by γ_1 and γ_2 are the same; equivalently, we need to show that the value of $f_{z_2}(z'_1)$ is unchanged after analytic continuation along the path $\tilde{\gamma}$ obtained by following γ_1 and then following the reversal of γ_2 . In fact, $\tilde{\gamma}$ is homotopic to some path consisting of a sequence of loops around z_2 and 0 that stay in the domains of (3.33) and (3.34), respectively. Since the union of these domains is contained in the domain of a single-valued branch of f_{z_2} , and since the value of $f_{z_2}(z'_1)$ that we start with is the value of this single-valued branch, the value of $f_{z_2}(z'_1)$ is unchanged after analytic continuation along $\tilde{\gamma}$. Thus γ_1 and γ_2 determine the same value of f_{z_2} at z_1 , and \tilde{f}_{z_2} is a single-valued analytic restriction of f_{z_2} .

Now, (3.32) along with the lower truncation property for Y_{W_3} shows that the restriction \tilde{f}_{z_2} has at worst a pole at $z_1 = \infty$. Similarly, (3.33) shows that \tilde{f}_{z_2} has at worst a pole at $z_1 = z_2$ and (3.34) shows that \tilde{f}_{z_2} has at worst a pole at $z_1 = 0$. A complex-analytic function with only singularities at 0, z_2, ∞ that are at worst poles has to be a rational function. Now standard arguments using properties of formal delta-functions (see for instance Proposition 8.10.7 in [FLM], Propositions 3.4.1 and 4.5.1 in [FHL], or Propositions 3.4.1 and 4.4.2 in [LL]) show that $I(w_1 \otimes w_2) := \mathcal{Y}(w_1, e^{\log z_2})w_2$ satisfies the Jacobi identity and is a $P(z_2)$ -intertwining map.

Now we apply the $L(0)$ -conjugation formula

$$\mathcal{Y}(w_1, x)w_2 = y^{-L(0)} \mathcal{Y}(y^{L(0)} w_1, xy) y^{L(0)} w_2,$$

which follows from the $L(0)$ -bracket formula, in the case $y = \frac{e^{\log z}}{x}$. This shows that $\mathcal{Y}(w_1, x)w_2 = \mathcal{Y}_{I,0}(w_1, x)w_2$, for $w_1 \in W_1$ and $w_2 \in W_2$. Hence \mathcal{Y} is an intertwining operator of type $\binom{W_3}{W_1 W_2}$. \square

This result allows us to obtain the following fundamental theorem:

Theorem 3.54. *Suppose W_1, W_2 , and W_3 are three modules in $\operatorname{Rep}^0 A$. Then \mathcal{Y} is an A -intertwining of type $\binom{W_3}{W_1 W_2}$ in the sense of Definition 3.49 if and only if \mathcal{Y} is an intertwining operator among A -modules in the sense of Definition 3.7.*

Proof. An intertwining operator in the sense of Definition 3.7 is an intertwining operator in the sense of Definition 3.49 by standard commutativity and associativity results for intertwining operators (see for instance Propositions 4.2.4 and 4.3.4 in [LL] for the case that \mathcal{Y} is a module vertex operator; the proof for general \mathcal{Y} is the same).

Conversely, suppose \mathcal{Y} satisfies the associativity and skew-associativity conditions of Theorem 3.53. Since \mathcal{Y} is an intertwining operator among V -modules, it satisfies conditions (1), (2) and (3) from Theorem 3.53. It satisfies condition (4) due to Theorem 3.44. Condition (5) follows from Lemma 4.1 in [Hu4] and our assumptions on the category \mathcal{C} (in particular the associativity of intertwining operators among V -modules in \mathcal{C} ; see for instance Corollary 9.30 in [HLZ6]). Therefore, by the conclusion of Theorem 3.53, \mathcal{Y} is an intertwining operator among A -modules in the sense of Definition 3.7. \square

As a consequence of this result, we see that \boxtimes_A in $\operatorname{Rep}^0 A$ agrees with the vertex-algebraic notion of tensor product of modules:

Corollary 3.55. *Suppose W_1 and W_2 are two modules in $\operatorname{Rep}^0 A$. Then for any $z \in \mathbb{C}^\times$, $(W_1 \boxtimes_A W_2, \mathcal{Y}_{W_1, W_2}(\cdot, e^{\log z} \cdot))$ is a $P(z)$ -tensor product of W_1 and W_2 .*

Proof. Suppose W_3 is another module in $\text{Rep}^0 A$ and I is a $P(z)$ -intertwining map of type $\binom{W_3}{W_1 W_2}$. Then by Proposition 3.50 and Theorem 3.54 there is a unique A -module homomorphism $f : W_1 \boxtimes_A W_2 \rightarrow W_3$ such that $f \circ \mathcal{Y}_{W_1, W_2} = \mathcal{Y}_{I, 0}$. In particular, this means

$$\overline{f}(\mathcal{Y}_{W_1, W_2}(w_1, e^{\log z})w_2) = \mathcal{Y}_{I, 0}(w_1, e^{\log z})w_2 = I(w_1 \otimes w_2)$$

for $w_1 \in W_1, w_2 \in W_2$, showing that $(W_1 \boxtimes_A W_2, \mathcal{Y}_{W_1, W_2}(\cdot, e^{\log z})\cdot)$ satisfies the universal property of a $P(z)$ -tensor product as given in Definition 3.21. \square

Remark 3.56. In particular, the preceding corollary shows that $(W_1 \boxtimes_A W_2, \boxtimes_A = \mathcal{Y}_{W_1, W_2}(\cdot, e^{\log 1})\cdot)$ is a $P(1)$ -tensor product of W_1 and W_2 in the category of A -modules in \mathcal{C} . In the remainder of this subsection, we will show that the rest of the braided monoidal supercategory structure on $\text{Rep}^0 A$ agrees with the braided monoidal supercategory structure on a category of A -modules constructed in [HLZ8].

3.5.3 Parallel transport isomorphisms in $\text{Rep}^0 A$

We have shown in Corollary 3.55 that $P(z)$ -tensor products in $\text{Rep}^0 A$ exist for any $z \in \mathbb{C}^\times$. Since the existence of natural parallel transport isomorphisms associated to continuous curves in \mathbb{C}^\times only depends on the existence of $P(z)$ -tensor products and properties of intertwining operators, we have natural parallel transport isomorphisms in $\text{Rep}^0 A$.

Suppose W_1 and W_2 are two modules in $\text{Rep}^0 A$, and γ is a continuous path in \mathbb{C}^\times from z_1 to z_2 . Then by (3.8), the parallel transport isomorphism

$$T_\gamma^A : W_1 \boxtimes_A W_2 \rightarrow W_1 \boxtimes_A W_2$$

is determined by the condition

$$\overline{T}_\gamma^A(w_1 \boxtimes_{P(z_1)}^A w_2) = \mathcal{Y}_{W_1, W_2}(w_1, e^{l(z_1)})w_2$$

for $w_1 \in W_1, w_2 \in W_2$, where $l(z_1)$ is the branch of logarithm determined by $\log z_2$ and the path γ . Now, if $l(z_1) = \log z_1 + 2\pi ip$ for some $p \in \mathbb{Z}$, Proposition 3.15 implies that also

$$T_\gamma^A(\mathcal{Y}_{W_1, W_2}(w_1, x)w_2) = \mathcal{Y}_{W_1, W_2}(w_1, e^{2\pi ip}x)w_2 \quad (3.35)$$

for $w_1 \in W_1, w_2 \in W_2$.

Similar to parallel transport isomorphisms among V -modules in \mathcal{C} , we use the notation $T_{z_1 \rightarrow z_2}^A$ when γ is a path in \mathbb{C}^\times with a branch cut along the positive real axis. But note that since $l(z_1) = \log z_1$ for such a path, these isomorphisms are the identity given our realization of $P(z)$ -tensor products in Corollary 3.55.

Remark 3.57. If W_1 and W_2 are modules in $\text{Rep} A$ but are not in $\text{Rep}^0 A$, we cannot obtain parallel transport isomorphisms unless γ has trivial monodromy. This is because vertex operators for modules in $\text{Rep} A$ may have non-trivial monodromy (non-integral powers of the formal variable x), so that we cannot guarantee $\mathcal{Y}_{W_1, W_2}(\cdot, e^{2\pi ip}x)$ is an A -intertwining operator for $p \neq 0$ when W_1 and W_2 are not objects of $\text{Rep}^0 A$.

3.5.4 Unit isomorphisms in $\text{Rep} A$ and $\text{Rep}^0 A$

Here we describe the unit isomorphisms in $\text{Rep} A$ in terms of A -intertwining operators. For the left unit isomorphisms, the definitions show that the diagram

$$\begin{array}{ccccc} A \otimes W & \xrightarrow{\boxtimes} & \overline{A \boxtimes W} & \xrightarrow{\overline{\eta_{A, W}}} & \overline{A \boxtimes_A W} \\ & \searrow \mathcal{Y}_W(\cdot, e^{\log 1}) & \downarrow \overline{\mu_W} & & \swarrow \overline{l_W^A} \\ & & W & & \end{array}$$

commutes, from which we obtain

$$l_W^A(\mathcal{Y}_{A, W}(a, x)w) = Y_W(a, x)w$$

for $a \in A$ and $w \in W$ since $\overline{\eta_{A, W}} \circ \boxtimes = \mathcal{Y}_{A, W}(\cdot, e^{\log 1})$.

Remark 3.58. For $z \in \mathbb{C}^\times$, if we use the notation $l_{P(z)}^A$ for l_W^A when we view l_W^A as a map on a $P(z)$ -tensor product, we have

$$\overline{l_{P(z)}^A}(a \boxtimes_{P(z)}^A w) = Y_W(a, e^{\log z})w$$

for $a \in A$ and $w \in W$.

For the right unit isomorphisms in $\text{Rep } A$, we use Proposition 3.29, the definition of $\mu_{W;-1}$, and the definition of r_W^A to obtain the commutative diagram

$$\begin{array}{ccccc} & & A \boxtimes_{P(-1)} W & & \\ & \nearrow \mathcal{R}_{P(1)}^- & \downarrow T_{-1 \rightarrow 1} & \searrow \mu_{W;-1} & \\ W \boxtimes A & \xrightarrow{\mathcal{R}_{A,W}^{-1}} & A \boxtimes W & \xrightarrow{\mu_W} & W \\ & \searrow \eta_{W,A} & & \nearrow r_W^A & \\ & & W \boxtimes_A A & & \end{array}$$

Then we use $\overline{\eta_{W,A}} \circ \boxtimes = \mathcal{Y}_{W,A}(\cdot, e^{\log 1})$. and (3.11) to calculate

$$\begin{aligned} \overline{r_W^A}(\mathcal{Y}_{W,A}(w, e^{\log 1})a) &= \overline{\mu_{W;-1} \circ \mathcal{R}_{P(1)}^-}(w \boxtimes a) \\ &= \overline{\mu_{W;-1}} \left((-1)^{|w||a|} e^{L(-1)} \mathcal{Y}_{\boxtimes_{P(-1)},0}(a, e^{-\pi i})w \right) \\ &= (-1)^{|w||a|} \overline{\mu_{W;-1}} \left(e^{L(-1)} e^{-2\pi i L(0)} \mathcal{Y}_{\boxtimes_{P(-1)},0}(e^{2\pi i L(0)} a, e^{\pi i}) e^{2\pi i L(0)} w \right) \\ &= (-1)^{|w||a|} e^{L(-1)} e^{-2\pi i L(0)} \overline{\mu_{W;-1}} \left(e^{2\pi i L(0)} a \boxtimes_{P(-1)} e^{2\pi i L(0)} w \right) \\ &= (-1)^{|w||a|} e^{L(-1)} e^{-2\pi i L(0)} Y_W(e^{2\pi i L(0)} a, e^{\pi i}) e^{2\pi i L(0)} w \\ &= (-1)^{|w||a|} e^{L(-1)} Y_W(a, e^{-\pi i})w \\ &= \Omega_{-1}(Y_W)(w, e^{\log 1})a \end{aligned}$$

for parity-homogeneous $w \in W$, $a \in A$. Thus by Proposition 3.15, we have

$$r_W^A(\mathcal{Y}_{W,A}(w, x)a) = \Omega_{-1}(Y_W)(w, x)a = (-1)^{|w||a|} e^{xL(-1)} Y_W(a, e^{-\pi i} x)w$$

for parity-homogeneous $w \in W$, $a \in A$.

Remark 3.59. For $z \in \mathbb{C}^\times$, if we use the notation $r_{P(z)}^A$ to denote r_W^A when we view r_W^A as a map from the $P(z)$ -tensor product, we have

$$\overline{r_{P(z)}^A}(w \boxtimes_{P(z)}^A a) = (-1)^{|w||a|} e^{zL(-1)} Y_W(a, e^{\log z - \pi i})w = (-1)^{|w||a|} e^{zL(-1)} Y_W(a, e^{l_{-1/2}(-z)})w$$

for parity-homogeneous $w \in W$, $a \in A$.

Remark 3.60. If W is a module in $\text{Rep}^0 A$, the unit isomorphisms l_W^A and r_W^A have the same description. However, since in this case Y_W has only integral powers of the formal variable x , we can simplify the notation as follows:

$$\begin{aligned} l_W^A(\mathcal{Y}_{A,W}(a, x)w) &= Y_W(a, x)w \\ \overline{l_{P(z)}^A}(a \boxtimes_{P(z)}^A w) &= Y_W(a, z)w \end{aligned}$$

for $a \in A$, $w \in W$, $z \in \mathbb{C}^\times$, and

$$\begin{aligned} r_W^A(\mathcal{Y}_{W,A}(w, x)a) &= (-1)^{|w||a|} e^{xL(-1)} Y_W(a, -x)w \\ \overline{r_{P(z)}^A}(w \boxtimes_{P(z)}^A a) &= (-1)^{|w||a|} e^{zL(-1)} Y_W(a, -z)w \end{aligned}$$

for parity-homogeneous $a \in A$, $w \in W$, and $z \in \mathbb{C}^\times$. This is in agreement with the construction of unit isomorphisms in [HLZ8].

3.5.5 Braiding isomorphisms in $\text{Rep}^0 A$

Here we discuss the braiding isomorphisms in $\text{Rep}^0 A$ in terms of intertwining operators. For modules W_1 and W_2 in $\text{Rep}^0 A$, it is easy to see from (2.28), (3.14), and the definition of \mathcal{Y}_{W_1, W_2} that

$$\mathcal{R}_{W_1, W_2}^A(\mathcal{Y}_{W_1, W_2}(w_1, x)w_2) = \Omega_0(\mathcal{Y}_{W_2, W_1})(w_1, x)w_2 = (-1)^{|w_1||w_2|} e^{xL(-1)} \mathcal{Y}_{W_2, W_1}(w_2, e^{\pi i} x)w_1$$

and

$$(\mathcal{R}_{W_1, W_2}^A)^{-1}(\mathcal{Y}_{W_2, W_1}(w_2, x)w_1) = \Omega_{-1}(\mathcal{Y}_{W_1, W_2})(w_2, x)w_1 = (-1)^{|w_1||w_2|} e^{xL(-1)} \mathcal{Y}_{W_1, W_2}(w_1, e^{-\pi i} x)w_2$$

for parity-homogeneous $w_1 \in W_1, w_2 \in W_2$. Moreover, using Remark 3.15, the monodromy isomorphisms in $\text{Rep}^0 A$ are characterized by

$$\mathcal{M}_{W_1, W_2}^A(\mathcal{Y}_{W_1, W_2}(w_1, x)w_2) = \mathcal{Y}_{W_1, W_2}(w_1, e^{2\pi i} x)w_2$$

for $w_1 \in W_1$ and $w_2 \in W_2$.

Remark 3.61. By (3.35), the parallel transport isomorphism T_γ^A on $W_1 \boxtimes_A W_2$ is $(\mathcal{M}_{W_1, W_2}^A)^p$ where $p \in \mathbb{Z}$ corresponds to the monodromy of the closed curve γ in \mathbb{C}^\times .

When we view $W_1 \boxtimes_A W_2$ as the $P(z)$ -tensor product in the category of A -modules, using $\boxtimes_{P(z)}^A = \mathcal{Y}_{W_1, W_2}(\cdot, e^{\log z})$, we can use the notation $\mathcal{R}_{P(z); W_1, W_2}^{A;+} = \mathcal{R}_{P(z)}^{A;+}$ for \mathcal{R}_{W_1, W_2}^A and $\mathcal{R}_{P(z); W_1, W_2}^{A;-} = \mathcal{R}_{P(z)}^{A;-}$ for $(\mathcal{R}_{W_2, W_1}^A)^{-1}$. With this notation we have

$$\begin{aligned} \mathcal{R}_{P(z)}^{A;+}(w_1 \boxtimes_{P(z)}^A w_2) &= (-1)^{|w_1||w_2|} e^{zL(-1)} \mathcal{Y}_{W_2, W_1}(w_2, e^{\log z + \pi i})w_1 \\ &= (-1)^{|w_1||w_2|} e^{zL(-1)} \mathcal{Y}_{W_2, W_1}(w_2, e^{l_{1/2}(-z)})w_1 \end{aligned}$$

and

$$\begin{aligned} \mathcal{R}_{P(z)}^{A;-}(w_1 \boxtimes_{P(z)}^A w_2) &= (-1)^{|w_1||w_2|} e^{zL(-1)} \mathcal{Y}_{W_2, W_1}(w_2, e^{\log z - \pi i})w_1 \\ &= (-1)^{|w_1||w_2|} e^{zL(-1)} \mathcal{Y}_{W_2, W_1}(w_2, e^{l_{-1/2}(-z)})w_1 \end{aligned}$$

for parity-homogeneous $w_1 \in W_1, w_2 \in W_2$. Also, the results of Propositions 3.28 and 3.29 hold with morphisms in \mathcal{C} replaced by the corresponding morphisms in $\text{Rep}^0 A$ (recall that the parallel transport isomorphisms appearing in these propositions are trivial in $\text{Rep}^0 A$ due to our particular realization of $P(z)$ -tensor products in $\text{Rep}^0 A$). Moreover, $\mathcal{R}_{W_1, W_2}^A = T_{-1 \rightarrow 1}^A \circ \mathcal{R}_{P(1)}^{A;+}$ since $T_{-1 \rightarrow 1}^A$ is trivial.

These results show that the braiding isomorphisms in $\text{Rep}^0 A$ agree with the vertex-algebraic braiding isomorphisms between A -modules constructed in [HLZ8] and reviewed in Subsection 3.3.

3.5.6 Associativity isomorphisms in $\text{Rep} A$ and $\text{Rep}^0 A$

Finally, we describe the associativity isomorphisms in $\text{Rep} A$ (and also $\text{Rep}^0 A$) in terms of intertwining operators. First, we have:

Proposition 3.62. *Choose $r_1, r_2 \in \mathbb{R}_+$ such that $r_1 > r_2 > r_1 - r_2 > 0$. Then for modules W_1, W_2 , and W_3 in $\text{Rep} A$, the associativity isomorphism $\mathcal{A}_{W_1, W_2, W_3}^A$ is characterized by the equality*

$$\begin{aligned} \overline{\mathcal{A}_{W_1, W_2, W_3}^A} \left(\mathcal{Y}_{W_1, W_2 \boxtimes_A W_3}(w_1, e^{\log r_1}) \mathcal{Y}_{W_2, W_3}(w_2, e^{\log r_2}) w_3 \right) \\ = \mathcal{Y}_{W_1 \boxtimes_A W_2, W_3}(w_1, e^{\log(r_1 - r_2)}) w_2, e^{\log r_2}) w_3 \end{aligned} \quad (3.36)$$

for all $w_1 \in W_1, w_2 \in W_2$, and $w_3 \in W_3$.

Proof. The definitions of $\underline{\mathcal{A}}_{W_1, W_2, W_3}$ and $\mathcal{A}_{W_1, W_2, W_3}^A$ imply that $\mathcal{A}_{W_1, W_2, W_3}^A$ is characterized by the commutativity of the diagram

$$\begin{array}{ccc} W_1 \boxtimes_{P(r_1)} (W_2 \boxtimes_{P(r_2)} W_3) & \xrightarrow{\mathcal{A}_{r_1, r_2}} & (W_1 \boxtimes_{P(r_1 - r_2)} W_2) \boxtimes_{P(r_2)} W_3 \\ \downarrow T_{r_1 \rightarrow 1} \circ (1_{W_1} \boxtimes_{P(r_1)} T_{r_2 \rightarrow 1}) & & \downarrow T_{r_2 \rightarrow 1} \circ (T_{r_1 - r_2 \rightarrow 1} \boxtimes_{P(r_2)} 1_{W_3}) \\ W_1 \boxtimes (W_2 \boxtimes W_3) & \xrightarrow{\underline{\mathcal{A}}_{W_1, W_2, W_3}} & (W_1 \boxtimes W_2) \boxtimes W_3 \\ \downarrow \eta_{W_1, W_2 \boxtimes_A W_3} \circ (1_{W_1} \boxtimes \eta_{W_2, W_3}) & & \downarrow \eta_{W_1 \boxtimes_A W_2, W_3} \circ (\eta_{W_1, W_2} \boxtimes 1_{W_3}) \\ W_1 \boxtimes_A (W_2 \boxtimes_A W_3) & \xrightarrow{\mathcal{A}_{W_1, W_2, W_3}^A} & (W_1 \boxtimes_A W_2) \boxtimes_A W_3 \end{array}$$

Now, the composition of the top and right arrows in this diagram is given by

$$\begin{aligned} w_1 \boxtimes_{P(r_1)} (w_2 \boxtimes_{P(r_2)} w_3) &\mapsto (w_1 \boxtimes_{P(r_1-r_2)} w_2) \boxtimes_{P(r_2)} w_3 \mapsto (\mathcal{Y}_{\boxtimes_{P(1)},0}(w_1, e^{\log(r_1-r_2)})w_2) \boxtimes_{P(r_2)} w_3 \\ &\mapsto \mathcal{Y}_{\boxtimes_{P(1)},0}(\mathcal{Y}_{\boxtimes_{P(1)},0}(w_1, e^{\log(r_1-r_2)})w_2, e^{\log r_2})w_3 \mapsto \mathcal{Y}_{\boxtimes_{P(1)},0}(\mathcal{Y}_{W_1,W_2}(w_1, e^{\log(r_1-r_2)})w_2, e^{\log r_2})w_3 \\ &\mapsto \mathcal{Y}_{W_1 \boxtimes_A W_2, W_3}(\mathcal{Y}_{W_1, W_2}(w_1, e^{\log(r_1-r_2)})w_2, e^{\log r_2})w_3 \end{aligned}$$

for $w_1 \in W_1$, $w_2 \in W_2$, and $w_3 \in W_3$. Similarly, the composition of the left and bottom arrows in the diagram is given by

$$w_1 \boxtimes_{P(r_1)} (w_2 \boxtimes_{P(r_2)} w_3) \mapsto \overline{\mathcal{A}_{W_1, W_2, W_3}^A} \left(\mathcal{Y}_{W_1, W_2 \boxtimes_A W_3}(w_1, e^{\log r_1}) \mathcal{Y}_{W_2, W_3}(w_2, e^{\log r_2}) w_3 \right)$$

for $w_1 \in W_1$, $w_2 \in W_2$, and $w_3 \in W_3$. Thus $\mathcal{A}_{W_1, W_2, W_3}^A$ is indeed characterized by (3.36). \square

As an immediate consequence of Proposition 3.18, we then have:

Corollary 3.63. *For $(z_1, z_2) \in S_1$, the associativity isomorphism $\mathcal{A}_{W_1, W_2, W_3}^A$ satisfies*

$$\begin{aligned} \overline{\mathcal{A}_{W_1, W_2, W_3}^A} \left(\mathcal{Y}_{W_1, W_2 \boxtimes_A W_3}(w_1, e^{\log z_1}) \mathcal{Y}_{W_2, W_3}(w_2, e^{\log z_2}) w_3 \right) \\ = \mathcal{Y}_{W_1 \boxtimes_A W_2, W_3}(\mathcal{Y}_{W_1, W_2}(w_1, e^{\log(z_1-z_2)})w_2, e^{\log z_2})w_3 \end{aligned}$$

for $w_1 \in W_1$, $w_2 \in W_2$, and $w_3 \in W_3$. In particular, for $w_1 \in W_1$, $w_2 \in W_2$, $w_3 \in W_3$, and $w' \in ((W_1 \boxtimes_A W_2) \boxtimes_A W_3)'$, the multivalued functions

$$\langle w', \overline{\mathcal{A}_{W_1, W_2, W_3}^A}(\mathcal{Y}_{W_1, W_2 \boxtimes_A W_3}(w_1, z_1) \mathcal{Y}_{W_2, W_3}(w_2, z_2) w_3) \rangle$$

on $|z_1| > |z_2| > 0$ and

$$\langle w', \mathcal{Y}_{W_1 \boxtimes_A W_2, W_3}(\mathcal{Y}_{W_1, W_2}(w_1, z_1 - z_2) w_2, z_2) w_3 \rangle$$

on $|z_2| > |z_1 - z_2| > 0$ have equal restrictions to the region $|z_1| > |z_2| > |z_1 - z_2| > 0$.

To obtain full vertex tensor category structure, we need, as in \mathcal{C} , isomorphisms

$$\mathcal{A}_{z_1, z_2}^A : W_1 \boxtimes_{P(z_1)}^A (W_2 \boxtimes_{P(z_2)}^A W_3) \rightarrow (W_1 \boxtimes_{P(z_1-z_2)}^A W_2) \boxtimes_{P(z_2)}^A W_3$$

for any $|z_1| > |z_2| > |z_1 - z_2| > 0$ which satisfy

$$\overline{\mathcal{A}_{z_1, z_2}^A} \left(w_1 \boxtimes_{P(z_1)}^A (w_2 \boxtimes_{P(z_2)}^A w_3) \right) = (w_1 \boxtimes_{P(z_1-z_2)}^A w_2) \boxtimes_{P(z_2)}^A w_3 \quad (3.37)$$

for $w_1 \in W_1$, $w_2 \in W_2$, and $w_3 \in W_3$. The preceding corollary shows that when $(z_1, z_2) \in S_1$, we can take $\mathcal{A}_{z_1, z_2}^A = \mathcal{A}_{W_1, W_2, W_3}^A$, but this will not work in general. Instead, assuming W_1 , W_2 , and W_3 are modules in $\text{Rep}^0 A$, we can take

$$\mathcal{A}_{z_1, z_2}^A = (T_{\tilde{\gamma}}^A \boxtimes_{P(z_2)}^A 1_{W_3}) \circ \mathcal{A}_{W_1, W_2, W_3}^A \circ (T_{\gamma}^A)^{-1} \quad (3.38)$$

where γ and $\tilde{\gamma}$ are paths from z_1 to itself and $z_1 - z_2$ to itself, respectively, as in (3.19). Then reversing the steps used to derive (3.19) shows that (3.37) holds. Thus we can conclude the following theorem:

Theorem 3.64. *For modules W_1 , W_2 , and W_3 in $\text{Rep}^0 A$ and $z_1, z_2 \in \mathbb{C}^\times$ satisfying $|z_1| > |z_2| > |z_1 - z_2| > 0$, there are natural isomorphisms*

$$\mathcal{A}_{z_1, z_2}^A : W_1 \boxtimes_{P(z_1)}^A (W_2 \boxtimes_{P(z_2)}^A W_3) \rightarrow (W_1 \boxtimes_{P(z_1-z_2)}^A W_2) \boxtimes_{P(z_2)}^A W_3$$

such that

$$\overline{\mathcal{A}_{z_1, z_2}^A} \left(w_1 \boxtimes_{P(z_1)}^A (w_2 \boxtimes_{P(z_2)}^A w_3) \right) = (w_1 \boxtimes_{P(z_1-z_2)}^A w_2) \boxtimes_{P(z_2)}^A w_3$$

for $w_1 \in W_1$, $w_2 \in W_2$, and $w_3 \in W_3$. Moreover, for $(z_1, z_2) \in S_1$,

$$\mathcal{A}_{W_1, W_2, W_3}^A = T_{z_2 \rightarrow z_1}^A \circ (T_{z_1 - z_2 \rightarrow z_1} \boxtimes_{P(z_2)}^A 1_{W_3}) \circ \mathcal{A}_{z_1, z_2}^A \circ (1_{W_1} \boxtimes_{P(z_1)}^A T_{1 \rightarrow z_2}^A) \circ T_{1 \rightarrow z_1}^A;$$

the same relation holds with $(z_1, z_2) \in S_1$ replaced by $(r_1, r_2) \in \mathbb{R}^2$ such that $r_1 > r_2 > r_1 - r_2 > 0$.

By Theorem 3.64, the associativity isomorphisms \mathcal{A}^A in $\text{Rep}^0 A$ agree with the associativity isomorphisms obtained in [HLZ8] from vertex tensor category structure on the category of A -modules. Combining this fact with all the other results and discussion in this subsection, we have the following fundamental theorem on $\text{Rep}^0 A$ and its braided monoidal category structure:

Theorem 3.65. *Suppose A is a vertex operator superalgebra extension of a vertex operator algebra V such that $V \subseteq A^0$, and suppose \mathcal{C} is a category of grading-restricted generalized V -modules that contains A and satisfies conditions necessary so that \mathcal{C} has the vertex tensor category structure (and thus braided tensor category structure) given in [HLZ1]-[HLZ8]. Then:*

1. $\text{Rep}^0 A$ is the category of grading-restricted generalized A -modules in \mathcal{C} ([HKL], [CKL]).
2. $\text{Rep}^0 A$ has vertex tensor category structure (and thus braided monoidal supercategory structure) as given in [HLZ1]-[HLZ8].
3. The Huang-Lepowsky-Zhang braided monoidal supercategory structure on $\text{Rep}^0 A$ given in [HLZ8] and Section 3.3 is isomorphic to the Kirillov-Ostrik braided monoidal supercategory structure on $\text{Rep}^0 A$ given in [KO] and Section 2.

Remark 3.66. As mentioned above, the isomorphism between $\text{Rep}^0 A$ and the category of grading-restricted generalized A -modules in \mathcal{C} was obtained in Theorem 3.4 of [HKL], and in Theorem 3.14 of [CKL] for the superalgebra generality. In Theorem 3.65, we have considerably strengthened these results by showing that the isomorphism is actually an isomorphism of braided monoidal supercategories.

Remark 3.67. An entirely analogous theorem to Theorem 3.65 shows that the braided tensor category structure on the subcategory $\underline{\text{Rep}}^0 A$ of $\text{Rep}^0 A$ consisting only of even morphisms is equivalent to the braided tensor category structure induced from vertex tensor category structure on the category of A -modules in \mathcal{C} with only even morphisms. The proof of such a theorem is exactly the same as the proof of Theorem 3.65 (except that all sign factors involving parity of morphisms may be deleted) since all structure morphisms discussed in the previous subsections are even.

3.6 Induction as a vertex tensor functor

In Theorems 2.59 and 2.67, we showed that induction is a tensor functor on \mathcal{SC} and a braided tensor functor on the subcategory \mathcal{SC}^0 of objects that induce to $\text{Rep}^0 A$. It is easy to see that \mathcal{SC}^0 is a vertex tensor category, since it inherits parallel transport, unit, associativity, and braiding isomorphisms from \mathcal{SC} ; moreover, \mathcal{SC}^0 is closed under the $P(1)$ -tensor product (and thus all $P(z)$ -tensor products) because induction is a tensor functor. In this subsection, we show that induction $\mathcal{F} : \mathcal{SC}^0 \rightarrow \text{Rep}^0 A$ is compatible with all the vertex tensor category structures on \mathcal{SC}^0 and $\text{Rep}^0 A$. That is, induction is a *vertex tensor functor* in the following sense:

1. There is an even isomorphism $\varphi : \mathcal{F}(V) \rightarrow A$.
2. For every $z \in \mathbb{C}^\times$, there is an even natural isomorphism $f_{P(z)} : \mathcal{F} \circ \boxtimes_{P(z)} \rightarrow \boxtimes_{P(z)}^A \circ (\mathcal{F} \times \mathcal{F})$.
3. The natural isomorphisms $f_{P(z)}$ are compatible with parallel transport isomorphisms in \mathcal{SC}^0 and $\text{Rep}^0 A$ in the sense that the diagram

$$\begin{array}{ccc} \mathcal{F}(W_1 \boxtimes_{P(z_1)} W_2) & \xrightarrow{\mathcal{F}(T_{\gamma; W_1, W_2})} & \mathcal{F}(W_1 \boxtimes_{P(z_2)} W_2) \\ \downarrow f_{P(z_1); W_1, W_2} & & \downarrow f_{P(z_2); W_1, W_2} \\ \mathcal{F}(W_1) \boxtimes_{P(z_1)}^A \mathcal{F}(W_2) & \xrightarrow{T_{\gamma; \mathcal{F}(W_1), \mathcal{F}(W_2)}^A} & \mathcal{F}(W_1) \boxtimes_{P(z_2)}^A \mathcal{F}(W_2) \end{array}$$

commutes for any modules W_1, W_2 in \mathcal{SC}^0 and any continuous path γ from z_1 to z_2 in \mathbb{C}^\times .

4. The natural isomorphisms $f_{P(z)}$ and the isomorphism φ are compatible with the unit isomorphisms in \mathcal{SC}^0 and $\text{Rep}^0 A$ in the sense that the diagrams

$$\begin{array}{ccc} \mathcal{F}(V \boxtimes_{P(z)} W) & \xrightarrow{f_{P(z); V, W}} & \mathcal{F}(V) \boxtimes_{P(z)}^A \mathcal{F}(W) \\ \downarrow \mathcal{F}(l_{P(z); W}) & & \downarrow \varphi \boxtimes_{P(z)}^A 1_{\mathcal{F}(W)} \\ \mathcal{F}(W) & \xrightarrow{(l_{P(z); \mathcal{F}(W)}^A)^{-1}} & A \boxtimes_{P(z)}^A \mathcal{F}(W) \end{array}$$

and

$$\begin{array}{ccc} \mathcal{F}(W \boxtimes_{P(z)} V) & \xrightarrow{f_{P(z); W, V}} & \mathcal{F}(W) \boxtimes_{P(z)}^A \mathcal{F}(V) \\ \downarrow \mathcal{F}(r_{P(z); W}) & & \downarrow 1_{\mathcal{F}(W)} \boxtimes_{P(z)}^A \varphi \\ \mathcal{F}(W) & \xrightarrow{(r_{P(z); \mathcal{F}(W)}^A)^{-1}} & \mathcal{F}(W) \boxtimes_{P(z)}^A A \end{array}$$

commute for any object W in \mathcal{SC}^0 , $z \in \mathbb{C}^\times$.

5. The natural isomorphisms $f_{P(z)}$ are compatible with the associativity isomorphisms in \mathcal{SC}^0 and $\text{Rep}^0 A$ in the sense that the diagram

$$\begin{array}{ccc}
\mathcal{F}(W_1 \boxtimes_{P(z_1)} (W_2 \boxtimes_{P(z_2)} W_3)) & \xrightarrow{\mathcal{F}(A_{z_1, z_2})} & \mathcal{F}((W_1 \boxtimes_{P(z_1-z_2)} W_2) \boxtimes_{P(z_2)} W_3) \\
\downarrow f_{P(z_1); W_1, W_2 \boxtimes_{P(z_2)} W_3} & & f_{P(z_2); W_1 \boxtimes_{P(z_1-z_2)} W_2, W_3} \downarrow \\
\mathcal{F}(W_1) \boxtimes_{P(z_1)}^A \mathcal{F}(W_2 \boxtimes_{P(z_2)} W_3) & & \mathcal{F}(W_1 \boxtimes_{P(z_1-z_2)} W_2) \boxtimes_{P(z_2)}^A \mathcal{F}(W_3) \\
\downarrow 1_{\mathcal{F}(W_1)} \boxtimes_{P(z_1)}^A f_{P(z_2); W_2, W_3} & & f_{P(z_1-z_2); W_1, W_2} \boxtimes_{P(z_2)}^A 1_{\mathcal{F}(W_3)} \downarrow \\
\mathcal{F}(W_1) \boxtimes_{P(z_1)}^A (\mathcal{F}(W_2) \boxtimes_{P(z_2)}^A \mathcal{F}(W_3)) & \xrightarrow{A_{z_1, z_2}^A} & (\mathcal{F}(W_1) \boxtimes_{P(z_1-z_2)}^A \mathcal{F}(W_2)) \boxtimes_{P(z_2)}^A \mathcal{F}(W_3)
\end{array} \tag{3.39}$$

commutes for all modules W_1, W_2, W_3 in \mathcal{SC}^0 and $z_1, z_2 \in \mathbb{C}^\times$ such that $|z_1| > |z_2| > |z_1 - z_2| > 0$.

6. The natural isomorphisms $f_{P(z)}$ are compatible with the braidings in \mathcal{SC}^0 and $\text{Rep}^0 A$ in the sense that the diagram

$$\begin{array}{ccc}
\mathcal{F}(W_1 \boxtimes_{P(\pm z)} W_2) & \xrightarrow{\mathcal{F}(\mathcal{R}_{P(\pm z)}^\pm)} & \mathcal{F}(W_2 \boxtimes_{P(\mp z)} W_1) \\
\downarrow f_{P(\pm z); W_1, W_2} & & \downarrow f_{P(\mp z); W_2, W_1} \\
\mathcal{F}(W_1) \boxtimes_{P(\pm z)}^A \mathcal{F}(W_2) & \xrightarrow{\mathcal{R}_{P(\pm z)}^{A; \pm}} & \mathcal{F}(W_2) \boxtimes_{P(\mp z)}^A \mathcal{F}(W_1)
\end{array} \tag{3.40}$$

commutes for all modules W_1, W_2 in \mathcal{SC}^0 and $z \in \mathbb{C}^\times$.

Theorem 3.68. *The induction functor $\mathcal{F} : \mathcal{SC}^0 \rightarrow \text{Rep}^0 A$ is a vertex tensor functor with respect to the vertex tensor category structure on \mathcal{SC}^0 inherited from \mathcal{C} and the vertex tensor category structure on $\text{Rep}^0 A$ given in Theorem 3.65.*

Proof. Throughout this proof, W and W_i for $i = 1, 2, 3$ will denote objects of \mathcal{SC}^0 . We will derive the required properties using $\varphi = r_A : \mathcal{F}(V) \rightarrow A$ and

$$f_{P(z); W_1, W_2} = T_{1 \rightarrow z}^A \circ f_{W_1, W_2} \circ \mathcal{F}(T_{z \rightarrow 1}) : \mathcal{F}(W_1 \boxtimes_{P(z)} W_2) \rightarrow \mathcal{F}(W_1) \boxtimes_{P(z)}^A \mathcal{F}(W_2)$$

for $z \in \mathbb{C}^\times$ and modules W_1, W_2 in \mathcal{SC}^0 , using properties of parallel transports and the fact that \mathcal{F} is a braided monoidal functor. First note that for each $z \in \mathbb{C}^\times$, $f_{P(z)}$ is an even natural isomorphism since it is a composition of even natural isomorphisms.

To show that the $f_{P(z)}$ are compatible with parallel transports, suppose γ is a continuous path from z_1 to z_2 in \mathbb{C}^\times and let $\tilde{\gamma}$ denote the path from 1 to itself obtained by first following a path from 1 to z_1 in \mathbb{C}^\times with a cut along the positive real axis, then following γ from z_1 to z_2 , and then following a path from z_2 to 1 in \mathbb{C}^\times with a cut along the positive real axis. Thus $T_{\tilde{\gamma}}^{(A)} = T_{z_2 \rightarrow 1}^{(A)} \circ T_{\gamma}^{(A)} \circ T_{1 \rightarrow z_1}^{(A)}$. By Proposition 3.31 and Remark 3.61, $T_{\tilde{\gamma}; W_1, W_2} = \mathcal{M}_{W_1, W_2}^p$ and $T_{\tilde{\gamma}; \mathcal{F}(W_1), \mathcal{F}(W_2)}^A = (\mathcal{M}_{\mathcal{F}(W_1), \mathcal{F}(W_2)}^A)^p$, where $p \in \mathbb{Z}$ gives the monodromy of $\tilde{\gamma}$. Using these facts together with Corollary 2.68, we calculate

$$\begin{aligned}
f_{P(z_2); W_1, W_2} \circ \mathcal{F}(T_{\gamma; W_1, W_2}) &= T_{1 \rightarrow z_2}^A \circ f_{W_1, W_2} \circ \mathcal{F}(T_{z_2 \rightarrow 1}) \circ \mathcal{F}(T_{\gamma}) \\
&= T_{1 \rightarrow z_2}^A \circ f_{W_1, W_2} \circ \mathcal{F}(T_{\tilde{\gamma}}) \circ \mathcal{F}(T_{z_1 \rightarrow 1}) \\
&= T_{1 \rightarrow z_2}^A \circ f_{W_1, W_2} \circ \mathcal{F}(\mathcal{M}_{W_1, W_2}^p) \circ \mathcal{F}(T_{z_2 \rightarrow 1}) \\
&= T_{1 \rightarrow z_2}^A \circ (\mathcal{M}_{\mathcal{F}(W_1), \mathcal{F}(W_2)}^A)^p \circ f_{W_1, W_2} \circ \mathcal{F}(T_{z_2 \rightarrow 1}) \\
&= T_{1 \rightarrow z_2}^A \circ T_{\tilde{\gamma}}^A \circ f_{W_1, W_2} \circ \mathcal{F}(T_{z_1 \rightarrow 1}) \\
&= T_{\gamma}^A \circ T_{1 \rightarrow z_1}^A \circ f_{W_1, W_2} \circ \mathcal{F}(T_{z_1 \rightarrow 1}) = T_{\gamma; \mathcal{F}(W_1), \mathcal{F}(W_2)}^A \circ f_{P(z_1); W_1, W_2},
\end{aligned}$$

as desired.

We prove that $f_{P(z)}$ and φ are compatible with the left unit isomorphisms. Every morphism in the following diagram is invertible. The outer rectangle commutes since \mathcal{F} is a monoidal functor, the top by definition of $f_{P(z)}$, the left by properties of unit morphisms in \mathcal{SC} , the bottom by properties of unit

morphisms in $\text{Rep } A$, and the right by naturality of parallel transports. Hence, the square in the middle commutes.

$$\begin{array}{ccc}
\mathcal{F}(V \boxtimes W) & \xrightarrow{f_{V,W}} & \mathcal{F}(V) \boxtimes_A \mathcal{F}(W) \\
\downarrow \mathcal{F}(l_W) & \searrow \mathcal{F}(T_{1 \rightarrow z}) & \swarrow T_{1 \rightarrow z}^A \\
& \mathcal{F}(V \boxtimes_{P(z)} W) \xrightarrow{f_{P(z);V,W}} \mathcal{F}(V) \boxtimes_{P(z)}^A \mathcal{F}(W) & \\
& \downarrow \mathcal{F}(l_{P(z);W}) & \downarrow \varphi \boxtimes_{P(z)}^A 1_{\mathcal{F}(W)} \\
& \mathcal{F}(W) \xrightarrow{(l_{P(z);\mathcal{F}(W)})^{-1}} A \boxtimes_{P(z)}^A \mathcal{F}(W) & \\
& \downarrow 1_{\mathcal{F}(W)} = \mathcal{F}(1_W) & \downarrow \varphi \boxtimes_A 1_{\mathcal{F}(W)} \\
\mathcal{F}(W) & \xrightarrow{(l_{\mathcal{F}(W)})^{-1}} & A \boxtimes_A \mathcal{F}(W).
\end{array}$$

The proof of the right unit property is exactly similar.

To prove that (3.39) commutes, first recall from (3.19) and (3.38) that in both \mathcal{SC}^0 and $\text{Rep}^0 A$ (suppressing module subscripts from isomorphisms),

$$\begin{aligned}
& ((T_{\tilde{\gamma}}^{(A)})^{-1} \boxtimes_{P(z_2)}^{(A)} 1) \circ \mathcal{A}_{z_1, z_2}^{(A)} \circ T_{\gamma}^{(A)} \\
&= (T_{1 \rightarrow z_1 - z_2}^{(A)} \boxtimes_{P(z_2)}^{(A)} 1) \circ T_{1 \rightarrow z_2}^{(A)} \circ \mathcal{A}^{(A)} \circ T_{z_1 \rightarrow 1}^{(A)} \circ (1 \boxtimes_{P(z_1)}^{(A)} T_{z_2 \rightarrow 1}^{(A)}),
\end{aligned}$$

where γ and $\tilde{\gamma}$ are certain paths from z_1 to itself and $z_1 - z_2$ to itself, respectively, that depend only on (z_1, z_2) . (Recall that with our realization of $P(z)$ -tensor products in $\text{Rep}^0 A$, parallel transports for paths where the branch of logarithm does not change are the identity.) Thus

$$T_{z_2 \rightarrow 1}^{(A)} \circ (T_{\tilde{\gamma}'}^{(A)} \boxtimes_{P(z_2)}^{(A)} 1) \circ \mathcal{A}_{z_1, z_2}^{(A)} = \mathcal{A}^{(A)} \circ T_{\gamma'}^{(A)} \circ (1 \boxtimes_{P(z_1)}^{(A)} T_{z_2 \rightarrow 1}^{(A)}),$$

where γ' is a path from z_1 to 1 obtained by first following the reversal of γ and then following a path from z_1 to 1 in \mathbb{C}^\times with a cut along the positive real axis, and where $\tilde{\gamma}'$ is a path from $z_1 - z_2$ to 1 obtained by first following the reversal of $\tilde{\gamma}$ and then following a path from $z_1 - z_2$ to 1 in \mathbb{C}^\times with a cut along the positive real axis. Using this relation, together with the definition of the $f_{P(z)}$, the naturality of the $f_{P(z)}$, the compatibility of the $f_{P(z)}$ with parallel transports, and the naturality of parallel transports, we obtain the following two commutative diagrams. Here, to save space, we use the notation $\tilde{\cdot}$ for $\mathcal{F}(\cdot)$, we use $z_0 = z_1 - z_2$, and we suppress module subscripts on most isomorphisms:

$$\begin{array}{ccccc}
W_1 \boxtimes_{P(z_1)} (\widetilde{W_2} \boxtimes_{P(z_2)} W_3) & \xrightarrow{1 \boxtimes_{P(z_1)} \widetilde{T}_{z_2 \rightarrow 1}} & W_1 \boxtimes_{P(z_1)} (\widetilde{W_2} \boxtimes W_3) & \xrightarrow{\widetilde{T}_{\gamma'}} & W_1 \boxtimes (\widetilde{W_2} \boxtimes W_3) \\
\downarrow f_{P(z_1)} & & \downarrow f_{P(z_1)} & & \downarrow f_{W_1, W_2 \boxtimes W_3} \\
\widetilde{W}_1 \boxtimes_{P(z_1)}^A (\widetilde{W}_2 \boxtimes_{P(z_2)}^A W_3) & \xrightarrow{1 \boxtimes_{P(z_1)}^A \widetilde{T}_{z_2 \rightarrow 1}} & \widetilde{W}_1 \boxtimes_{P(z_1)}^A (\widetilde{W}_2 \boxtimes^A W_3) & \xrightarrow{T_{\gamma'}^A} & \widetilde{W}_1 \boxtimes_A (\widetilde{W}_2 \boxtimes W_3) \\
\downarrow 1 \boxtimes_{P(z_1)}^A f_{P(z_2)} & & \downarrow 1 \boxtimes_{P(z_1)}^A f_{W_1, W_2} & & \downarrow 1 \boxtimes_A f_{W_1, W_2} \\
\widetilde{W}_1 \boxtimes_{P(z_1)}^A (\widetilde{W}_2 \boxtimes_{P(z_2)}^A \widetilde{W}_3) & \xrightarrow{1 \boxtimes_{P(z_1)}^A T_{z_2 \rightarrow 1}^A} & \widetilde{W}_1 \boxtimes_{P(z_1)}^A (\widetilde{W}_2 \boxtimes_A \widetilde{W}_3) & \xrightarrow{T_{\gamma'}^A} & \widetilde{W}_1 \boxtimes_A (\widetilde{W}_2 \boxtimes_A \widetilde{W}_3) \\
\downarrow \mathcal{A}_{z_1, z_2}^A & & & & \downarrow \mathcal{A}_{\widetilde{W}_1, \widetilde{W}_2, \widetilde{W}_3}^A \\
(\widetilde{W}_1 \boxtimes_{P(z_0)}^A \widetilde{W}_2) \boxtimes_{P(z_2)}^A \widetilde{W}_3 & \xrightarrow{T_{\tilde{\gamma}'}^A \boxtimes_{P(z_2)}^A 1} & (\widetilde{W}_1 \boxtimes_A \widetilde{W}_2) \boxtimes_{P(z_2)}^A \widetilde{W}_3 & \xrightarrow{T_{z_2 \rightarrow 1}^A} & (\widetilde{W}_1 \boxtimes_A \widetilde{W}_2) \boxtimes_A \widetilde{W}_3
\end{array}$$

and

$$\begin{array}{ccccc}
W_1 \boxtimes_{P(z_1)} (\widetilde{W_2} \boxtimes_{P(z_2)} W_3) & \xrightarrow{1 \boxtimes_{P(z_1)} \widetilde{T}_{z_2 \rightarrow 1}} & W_1 \boxtimes_{P(z_1)} (\widetilde{W_2} \boxtimes W_3) & \xrightarrow{\widetilde{T}_{\gamma'}} & W_1 \boxtimes (\widetilde{W_2} \boxtimes W_3) \\
\downarrow \widetilde{A}_{z_1, z_2} & & & & \downarrow \widetilde{A}_{W_1, W_2, W_3} \\
(W_1 \boxtimes_{P(z_0)} \widetilde{W_2}) \boxtimes_{P(z_2)} W_3 & \xrightarrow{T_{\gamma'} \boxtimes_{P(z_2)} 1} & (W_1 \boxtimes \widetilde{W_2}) \boxtimes_{P(z_2)} W_3 & \xrightarrow{\widetilde{T}_{z_2 \rightarrow 1}} & (W_1 \boxtimes \widetilde{W_2}) \boxtimes W_3 \\
\downarrow f_{P(z_2)} & & \downarrow f_{P(z_2)} & & \downarrow f_{W_1 \boxtimes W_2, W_3} \\
(W_1 \boxtimes_{P(z_0)} \widetilde{W_2}) \boxtimes_{P(z_2)}^A \widetilde{W_3} & \xrightarrow{\widetilde{T}_{\gamma'} \boxtimes_{P(z_2)}^A 1} & (W_1 \boxtimes \widetilde{W_2}) \boxtimes_{P(z_2)}^A \widetilde{W_3} & \xrightarrow{T_{z_2 \rightarrow 1}^A} & (\widetilde{W_1} \boxtimes \widetilde{W_2}) \boxtimes_A \widetilde{W_3} \\
\downarrow f_{P(z_0)} \boxtimes_{P(z_2)}^A 1 & & \downarrow f_{W_1, W_2} \boxtimes_{P(z_2)}^A 1 & & \downarrow f_{W_1, W_2} \boxtimes_A 1 \\
(\widetilde{W_1} \boxtimes_{P(z_0)}^A \widetilde{W_2}) \boxtimes_{P(z_2)}^A \widetilde{W_3} & \xrightarrow{T_{\gamma'}^A \boxtimes_{P(z_2)}^A 1} & (\widetilde{W_1} \boxtimes_A \widetilde{W_2}) \boxtimes_{P(z_2)}^A \widetilde{W_3} & \xrightarrow{T_{z_2 \rightarrow 1}^A} & (\widetilde{W_1} \boxtimes_A \widetilde{W_2}) \boxtimes_A \widetilde{W_3}
\end{array}$$

The right columns of these two diagrams are equal because \mathcal{F} is a tensor functor, so the left columns are also equal, proving that the $f_{P(z)}$ are compatible with the associativity isomorphisms in \mathcal{SC}^0 and $\text{Rep}^0 A$.

For proving that (3.40) commutes, we use the following diagram:

$$\begin{array}{ccc}
\mathcal{F}(W_1 \boxtimes W_2) & \xrightarrow{\mathcal{F}(\mathcal{R}_{W_1, W_2}) \text{ or } \mathcal{F}(\mathcal{R}_{W_2, W_1}^{-1})} & \mathcal{F}(W_2 \boxtimes W_1) \\
\downarrow f_{W_1, W_2} & \begin{array}{c} \searrow \mathcal{F}(T_{1 \rightarrow \pm z}) \\ \mathcal{F}(W_1 \boxtimes_{P(\pm z)} W_2) \xrightarrow{\mathcal{F}(\mathcal{R}_{P(\pm z)}^\pm)} \mathcal{F}(W_2 \boxtimes_{P(\mp z)} W_1) \\ \downarrow f_{P(\pm z); W_1, W_2} \quad \downarrow f_{P(\mp z); W_2, W_1} \\ \mathcal{F}(W_1) \boxtimes_{P(\pm z)}^A \mathcal{F}(W_2) \xrightarrow{\mathcal{R}_{P(\pm z)}^{A, \pm}} \mathcal{F}(W_2) \boxtimes_{P(\mp z)}^A \mathcal{F}(W_1) \end{array} & \downarrow f_{W_2, W_1} \\
\mathcal{F}(W_1) \boxtimes_A \mathcal{F}(W_2) & \xrightarrow{\mathcal{R}_{W_1, W_2}^A \text{ or } (\mathcal{R}_{W_2, W_1}^A)^{-1}} & \mathcal{F}(W_2) \boxtimes_A \mathcal{F}(W_1) \\
& \begin{array}{c} \nearrow T_{1 \rightarrow \pm z}^A \\ \searrow T_{1 \rightarrow \mp z}^A \end{array} &
\end{array} \tag{3.41}$$

where every arrow is invertible, the outer square commutes by Theorem 2.67, the top and bottom squares commute by Proposition 3.29, and the left and right squares commute by definition of $f_{P(z)}$. \square

3.7 Some analytic lemmas

Here we state and prove a proposition that was used in the proof of Theorem 3.44. Also, for use in the next section, we generalize to $\text{Rep} A$ some results on ideals and submodules which are well known for ordinary A -modules, that is, objects of $\text{Rep}^0 A$ (see for instance [LL]).

For now, the setting is the same as in Section 3.3; in particular, \mathcal{C} is a vertex tensor category of modules for a vertex operator superalgebra. The following result is similar to [HLZ8, Proposition 12.13]:

Proposition 3.69. *Let W_1, W_2 , and W_3 be modules in \mathcal{C} and suppose $r_1, r_2 \in \mathbb{R}$ satisfy $r_2 > r_1 > 2(r_2 - r_1) > 0$. Then*

$$\begin{aligned}
& \overline{(\mathcal{R}_{P(r_2-r_1)}^- \boxtimes_{P(r_2)} 1_{W_3}) \circ T_{r_1 \rightarrow r_2} ((w_1 \boxtimes_{P(r_2-r_1)} w_2) \boxtimes_{P(r_1)} w_3)} \\
& \quad = (-1)^{|w_1||w_2|} \left(\mathcal{J}_{\boxtimes_{P(r_1-r_2)}, 0}(w_2, e^{l-1/2(r_1-r_2)} w_1) \boxtimes_{P(r_2)} w_3 \right)
\end{aligned}$$

for all $w_3 \in W_3$ and parity-homogeneous $w_1 \in W_1, w_2 \in W_2$.

Remark 3.70. In the statement of Proposition 3.69, we could replace (r_1, r_2) with (z_1, z_2) coming from a larger set (such as an appropriate connected set related to S_2). But here we choose to restrict $r_1, r_2 \in \mathbb{R}$ for simplicity and with an eye towards applying Proposition 3.20.

Proof. By definition (see (3.9) and (3.11)) we have

$$\langle w', \overline{(\mathcal{R}_{P(r_2-r_1)}^- \boxtimes_{P(r_2)} 1_{W_3}) \circ T_{r_1 \rightarrow r_2} ((w_1 \boxtimes_{P(r_2-r_1)} w_2) \boxtimes_{P(r_1)} w_3)} \rangle$$

$$\begin{aligned}
&= \sum_{n \in \mathbb{R}} \left\langle w', \overline{(\mathcal{R}_{P(r_2-r_1)}^- \boxtimes_{P(r_2)} 1_{W_3}) \circ T_{r_1 \rightarrow r_2}} (\pi_n(w_1 \boxtimes_{P(r_2-r_1)} w_2) \boxtimes_{P(r_1)} w_3) \right\rangle \\
&= \sum_{n \in \mathbb{R}} \left\langle w', \mathcal{Y}_{\boxtimes_{P(r_2)}, 0} \left(\pi_n((-1)^{|w_1||w_2|} e^{(r_2-r_1)L(-1)}) \mathcal{Y}_{\boxtimes_{P(r_1-r_2)}, 0}(w_2, e^{l_{-1/2}(r_1-r_2)} w_1), e^{\log r_1} \right) w_3 \right\rangle \\
&= (-1)^{|w_1||w_2|} \sum_{n \in \mathbb{R}} \sum_{j \geq 0} \frac{(r_2-r_1)^j}{j!} \\
&\quad \cdot \left\langle w', \mathcal{Y}_{\boxtimes_{P(r_2)}, 0} \left(L(-1)^j \pi_{n-j}(\mathcal{Y}_{\boxtimes_{P(r_1-r_2)}, 0}(w_2, e^{l_{-1/2}(r_1-r_2)} w_1), e^{\log r_1}) w_3 \right) \right\rangle
\end{aligned}$$

for $w' \in ((W_1 \boxtimes_{P(r_1-r_2)} W_2) \boxtimes_{P(r_2)} W_3)'$. Now we would like to use the $L(-1)$ -derivative property and the Taylor theorem, but we cannot do this directly because we would need to rearrange the iterated sum over n and j by replacing π_{n-j} with π_n , but we cannot assume the double sum over n and j converges absolutely. To deal with this problem, we consider the open set $U \subseteq \mathbb{C}$ consisting of $\varepsilon \in \mathbb{C}$ such that

$$r_1 - 2(r_2 - r_1) > |\varepsilon|, \quad |r_2 - r_1 + \varepsilon| > r_2 - r_1, \quad \text{and} \quad |r_2 + \varepsilon| > r_1.$$

From the assumptions on r_1 and r_2 , U is non-empty and $\varepsilon = 0$ is on the boundary of U . For notational convenience, we also set $\mathcal{Y}_{\boxtimes_{P(r_2)}, 0} = \mathcal{Y}^1$, $\mathcal{Y}_{\boxtimes_{P(r_1-r_2)}, 0} = \mathcal{Y}^2$, and $r_1 - r_2 = r_0$.

Now from Proposition 12.7, part 4 in [HLZ8], the double sum

$$\begin{aligned}
&\sum_{m, n \in \mathbb{R}} \left\langle w', \mathcal{Y}^1(\pi_m(\Omega(Y_{W_2 \boxtimes_{P(r_0)} W_1})(\pi_n(\mathcal{Y}^2(w_2, e^{l_{-1/2}(r_0)} w_1), -r_0 + \varepsilon)\mathbf{1}), e^{\log r_1}) w_3) \right\rangle \\
&= \sum_{m, n \in \mathbb{R}} \left\langle w', \mathcal{Y}^1(\pi_m(e^{(-r_0+\varepsilon)L(-1)} \pi_n(\mathcal{Y}^2(w_2, e^{l_{-1/2}(r_0)} w_1))), e^{\log r_1}) w_3 \right\rangle
\end{aligned}$$

for $w' \in ((W_1 \boxtimes_{P(r_1-r_2)} W_2) \boxtimes_{P(r_2)} W_3)'$ is absolutely convergent when

$$|-r_0 + \varepsilon| > |r_0| > 0 \quad \text{and} \quad r_1 > |r_0| + |-r_0 + \varepsilon| > 0.$$

In particular, the double sum is absolutely convergent when $\varepsilon \in U$, so from now on we assume $\varepsilon \in U$. Since the double sum converges absolutely, we can write it as an iterated sum as follows:

$$\begin{aligned}
&\sum_{m, n \in \mathbb{R}} \left\langle w', \mathcal{Y}^1(\pi_m(e^{(-r_0+\varepsilon)L(-1)} \pi_n(\mathcal{Y}^2(w_2, e^{l_{-1/2}(r_0)} w_1))), e^{\log r_1}) w_3 \right\rangle \\
&= \sum_{m \in \mathbb{R}} \sum_{n \in \mathbb{R}} \left\langle w', \mathcal{Y}^1(\pi_m(e^{(-r_0+\varepsilon)L(-1)} \pi_n(\mathcal{Y}^2(w_2, e^{l_{-1/2}(r_0)} w_1))), e^{\log r_1}) w_3 \right\rangle \\
&= \sum_{m \in \mathbb{R}} \sum_{j \geq 0} \frac{(-r_0 + \varepsilon)^j}{j!} \left\langle w', \mathcal{Y}^1(L(-1)^j \pi_{m-j}(\mathcal{Y}^2(w_2, e^{l_{-1/2}(r_0)} w_1), e^{\log r_1}) w_3) \right\rangle \\
&= \sum_{m \in \mathbb{R}} \sum_{j \geq 0} \frac{(-r_0 + \varepsilon)^j}{j!} \left\langle w', \mathcal{Y}^1(\pi_m(L(-1)^j \mathcal{Y}^2(w_2, e^{l_{-1/2}(r_0)} w_1), e^{\log r_1}) w_3) \right\rangle \\
&= \sum_{m \in \mathbb{R}} \left\langle w', \mathcal{Y}^1(\pi_m(e^{(-r_0+\varepsilon)L(-1)} \mathcal{Y}^2(w_2, e^{l_{-1/2}(r_0)} w_1), e^{\log r_1}) w_3) \right\rangle.
\end{aligned}$$

On the other hand, because of the absolute convergence of the double sum, we can reindex the third sum above and use the $L(-1)$ -derivative property for intertwining operators to obtain

$$\begin{aligned}
&\sum_{m \in \mathbb{R}} \sum_{j \geq 0} \frac{(-r_0 + \varepsilon)^j}{j!} \left\langle w', \mathcal{Y}^1(L(-1)^j \pi_{m-j}(\mathcal{Y}^2(w_2, e^{l_{-1/2}(r_0)} w_1), e^{\log r_1}) w_3) \right\rangle \\
&= \sum_{m \in \mathbb{R}} \sum_{j \geq 0} \frac{(-r_0 + \varepsilon)^j}{j!} \left(\frac{d}{dx} \right)^j \left\langle w', \mathcal{Y}^1(\pi_m(\mathcal{Y}^2(w_2, e^{l_{-1/2}(r_0)} w_1), x) w_3) \right\rangle \Big|_{x=e^{\log r_1}} \\
&= \sum_{m \in \mathbb{R}} \left\langle w', \mathcal{Y}^1(\pi_m(\mathcal{Y}^2(w_2, e^{l_{-1/2}(r_0)} w_1), x - r_0 + \varepsilon) w_3) \right\rangle \Big|_{x=e^{\log r_1}}.
\end{aligned}$$

Since $r_1 - r_0 + \varepsilon = r_2 + \varepsilon$, we need to determine the correct branch of $\log(r_2 + \varepsilon)$ to use when we substitute $x = e^{\log r_1}$. Now,

$$\log(x - r_0 + \varepsilon) \Big|_{x=e^{\log r_1}} = \left(\log x + \log \left(1 + \frac{-r_0 + \varepsilon}{x} \right) \right) \Big|_{x=e^{\log r_1}} = \log r_1 + \log \left(1 + \frac{-r_0 + \varepsilon}{r_1} \right),$$

where $\log\left(1 + \frac{-r_0 + \varepsilon}{r_1}\right)$ represents the standard power series for $\log(1+x)$ evaluated at $x = \frac{-r_0 + \varepsilon}{r_1}$. Since $|\varepsilon| < r_1 - 2|r_0|$ for $\varepsilon \in U$, we have $|-r_0 + \varepsilon| < |r_1|$, as is necessary for the power series to converge. Moreover, $1 + (-r_0 + \varepsilon)/r_1 = (r_2 + \varepsilon)/r_1$ is contained in the disk of radius 1 centered at 1. Since the power series $\log(1+x)$ converges to the branch of logarithm which equals 0 at 1 and is holomorphic on the disk of radius 1 centered at 1, we see that we must have

$$\log\left(1 + \frac{-r_0 + \varepsilon}{r_1}\right) = l_{-1/2}\left(\frac{r_2 + \varepsilon}{r_1}\right) = l_{-1/2}(r_2 + \varepsilon) - \log r_1,$$

where the second equality holds because r_1 is a positive real number. Thus we conclude that $\log(x - r_0 + \varepsilon)|_{x=e^{\log r_1}} = l_{-1/2}(r_2 + \varepsilon)$ for $\varepsilon \in U$.

To summarize, we have now shown that

$$\sum_{m \in \mathbb{R}} \left\langle w', \mathcal{Y}^1(\pi_m(e^{(-r_0 + \varepsilon)L(-1)} \mathcal{Y}^2(w_2, e^{l_{-1/2}(r_0)} w_1), e^{\log r_1}) w_3) \right\rangle \quad (3.42)$$

$$= \sum_{m \in \mathbb{R}} \left\langle w', \mathcal{Y}^1(\pi_m(\mathcal{Y}^2(w_2, e^{l_{-1/2}(r_0)} w_1), e^{l_{-1/2}(r_2 + \varepsilon)}) w_3) \right\rangle \quad (3.43)$$

for all $\varepsilon \in U$. Our goal is to show that they are also equal for $\varepsilon = 0$, in which case (3.42) is

$$(-1)^{|w_1||w_2|} \left\langle w', \overline{(\mathcal{R}_{P(r_2-r_1)}^- \boxtimes_{P(r_2)} 1W_3) \circ T_{r_1 \rightarrow r_2}((w_1 \boxtimes_{P(r_2-r_1)} w_2) \boxtimes_{P(r_1)} w_3))} \right\rangle$$

and (3.43) is

$$\begin{aligned} & \left\langle w', \mathcal{Y}_{\boxtimes_{P(r_2)}, 0} \left(\mathcal{Y}_{\boxtimes_{P(r_1-r_2)}, 0}(w_2, e^{l_{-1/2}(r_1-r_2)} w_1, e^{l_{-1/2}(r_2)}) w_3 \right) \right\rangle \\ &= \left\langle w', \mathcal{Y}_{\boxtimes_{P(r_2)}, 0} \left(\mathcal{Y}_{\boxtimes_{P(r_1-r_2)}, 0}(w_2, e^{l_{-1/2}(r_1-r_2)} w_1, e^{\log r_2}) w_3 \right) \right\rangle \\ &= \left\langle w', \left(\mathcal{Y}_{\boxtimes_{P(r_1-r_2)}, 0}(w_2, e^{l_{-1/2}(r_1-r_2)} w_1) \right) \boxtimes_{P(r_2)} w_3 \right\rangle. \end{aligned}$$

It is enough to show that both series converge to analytic functions of ε in a neighborhood of 0, since their equality on U will then show they are equal everywhere on their common domain, including $\varepsilon = 0$.

First, (3.43) converges absolutely to an analytic function in a neighborhood of $\varepsilon = 0$ since the iterate of intertwining operators converges to an analytic function of ε in the region given by the conditions

$$|r_2 + \varepsilon| > |r_0| \text{ and } \arg(r_2 + \varepsilon) \neq \pi$$

([HLZ5, Proposition 7.14]). This region includes $\varepsilon = 0$ because $r_2 > |r_0|$. To analyze (3.42), first note that $l_{-1/2}(r_0) = \log(-r_0) - \pi i$, so that

$$e^{(-r_0 + \varepsilon)L(-1)} \mathcal{Y}^2(w_2, e^{l_{-1/2}(r_0)} w_1) = (-1)^{|w_1||w_2|} e^{\varepsilon L(-1)} \Omega_{-1}(\mathcal{Y}^2)(w_1, e^{\log(-r_0)} w_2).$$

Now we need the following lemma:

Lemma 3.71. *Suppose \mathcal{Y} is an intertwining operator of type $(\begin{smallmatrix} W \\ W_1 W_2 \end{smallmatrix})$ where W is a V -module. For all $m \in \mathbb{R}$ and for r a positive real number, there is a neighborhood \tilde{U} of 0 in \mathbb{C} such that for $\varepsilon \in \tilde{U}$,*

$$\pi_m(e^{\varepsilon L(-1)} \mathcal{Y}(w_1, e^{\log r} w_2)) = \sum_{j \geq 0} \frac{\varepsilon^j}{j!} \pi_m(\mathcal{Y}(w_1, e^{l_{-1/2}(r+\varepsilon)} w_2) L(-1)^j w_2)$$

for all $w_1 \in W_1$ and $w_2 \in W_2$.

Proof. It is enough to show that

$$\langle w', e^{\varepsilon L(-1)} \mathcal{Y}(w_1, e^{\log r} w_2) \rangle = \sum_{j \geq 0} \frac{\varepsilon^j}{j!} \langle w', \mathcal{Y}(w_1, e^{l_{-1/2}(r+\varepsilon)} w_2) L(-1)^j w_2 \rangle$$

for any $w' \in W'$ and ε in some neighborhood of 0. We first observe that

$$I(\varepsilon) = \langle w', e^{\varepsilon L(-1)} \mathcal{Y}(w_1, e^{\log r} w_2) \rangle = \langle e^{\varepsilon L(1)} w', \mathcal{Y}(w_1, e^{\log r} w_2) \rangle$$

is a polynomial in ε , and so converges for all $\varepsilon \in \mathbb{C}$. On the other hand,

$$p(z, \varepsilon) = \sum_{j \geq 0} \frac{\varepsilon^j}{j!} \langle w', \mathcal{Y}(w_1, e^{l_{-1/2}(z)}) L(-1)^j w_2 \rangle = \langle w', \mathcal{Y}(w_1, e^{l_{-1/2}(z)}) \Omega(Y_{W_2})(w_2, \varepsilon) \mathbf{1} \rangle$$

converges absolutely to a single-valued analytic function of z and ε in the region given by the conditions

$$|z| > |\varepsilon| > 0 \text{ and } \arg z \neq \pi$$

(recall [HLZ5, Proposition 7.14]; we do not need to specify a branch of $\log \varepsilon$ or impose a condition on $\arg \varepsilon$ since $\Omega(Y_{W_2})(\cdot, x)$ has only integral powers of x). But in fact, $p(z, \varepsilon)$ remains analytic in ε at $\varepsilon = 0$ because

$$\sum_{j \geq 0} \frac{\varepsilon^j}{j!} \langle w', \mathcal{Y}(w_1, e^{l_{-1/2}(z)}) L(-1)^j w_2 \rangle$$

for z fixed is a power series in ε with positive radius of convergence at least $|z|$. Also, $p(z, 0)$ is analytic when $|z| > 0$ and $\arg z \neq \pi$. Now, since r is a positive real number, there is a neighborhood \tilde{U} of 0 such that $|r + \varepsilon| > |\varepsilon|$ and $\arg(r + \varepsilon) \neq \pi$ for $\varepsilon \in \tilde{U}$. Then $P(\varepsilon) = p(r + \varepsilon, \varepsilon)$ is analytic in ε on \tilde{U} .

Now, $I(\varepsilon)$ and $P(\varepsilon)$ are both analytic functions on \tilde{U} . To show that they are equal on \tilde{U} , it is sufficient to show that all derivatives of I and P agree at $\varepsilon = 0$, because this will show that they have the same power series expansion at 0 and thus are equal in a neighborhood of 0. In fact, for $K \geq 0$,

$$\begin{aligned} \left(\frac{d}{d\varepsilon} \right)^K I(\varepsilon) \Big|_{\varepsilon=0} &= \langle w', e^{\varepsilon L(-1)} L(-1)^K \mathcal{Y}(w_1, e^{\log r}) w_2 \rangle \Big|_{\varepsilon=0} \\ &= \sum_{k=0}^K \binom{K}{k} \langle w', \mathcal{Y}(L(-1)^k w_1, e^{\log r}) L(-1)^{K-k} w_2 \rangle, \end{aligned} \quad (3.44)$$

where for the second equality we use the $L(-1)$ -commutator formula

$$L(-1)\mathcal{Y}(w_1, x)w_2 = \mathcal{Y}(L(-1)w_1, x)w_2 + \mathcal{Y}(w_1, x)L(-1)w_2$$

(see for instance [HLZ2, Equation 3.28]). On the other hand, using Equation 7.37 in the statement of [HLZ5, Proposition 7.14],

$$\begin{aligned} \left(\frac{d}{d\varepsilon} \right)^K P(\varepsilon) &= \sum_{k=0}^K \binom{K}{k} \frac{\partial^K}{\partial z^k \partial \varepsilon^{K-k}} p(z, \varepsilon) \Big|_{z=r+\varepsilon} \\ &= \sum_{k=0}^K \binom{K}{k} \left(\frac{d}{dx} \right)^k \langle w', \mathcal{Y}(w_1, x) e^{\varepsilon L(-1)} L(-1)^{K-k} w_2 \rangle \Big|_{x=e^{l_{-1/2}(r+\varepsilon)}} \\ &= \sum_{k=0}^K \binom{K}{k} \langle w', \mathcal{Y}(L(-1)^k w_1, e^{l_{-1/2}(r+\varepsilon)}) e^{\varepsilon L(-1)} L(-1)^{K-k} w_2 \rangle, \end{aligned}$$

which agrees with (3.44) at $\varepsilon = 0$ because $\log r = l_{-1/2}(r)$. This completes the proof of the lemma. \square

Continuing with the proof of the proposition, we can use the lemma to see that for a neighborhood of $\varepsilon = 0$, we have the equality as series over $m \in \mathbb{R}$:

$$\begin{aligned} &\sum_{m \in \mathbb{R}} \left\langle w', \mathcal{Y}^1(\pi_m(e^{(-r_0+\varepsilon)L(-1)})\mathcal{Y}^2(w_2, e^{l_{-1/2}(r_0)})w_1, e^{\log r_1})w_3 \right\rangle \\ &= (-1)^{|w_1||w_2|} \sum_{m \in \mathbb{R}} \left\langle w', \mathcal{Y}^1(\pi_m(e^{\varepsilon L(-1)})\Omega_{-1}(\mathcal{Y}^2)(w_1, e^{\log(-r_0)})w_2, e^{\log r_1})w_3 \right\rangle \\ &= (-1)^{|w_1||w_2|} \sum_{m \in \mathbb{R}} \sum_{j \geq 0} \frac{\varepsilon^j}{j!} \left\langle w', \mathcal{Y}^1(\pi_m(\Omega_{-1}(\mathcal{Y}^2)(w_1, e^{l_{-1/2}(-r_0+\varepsilon)})L(-1)^j w_2, e^{\log r_1})w_3 \right\rangle \\ &= (-1)^{|w_1||w_2|} \sum_{m \in \mathbb{R}} \sum_{n \in \mathbb{R}} \left\langle w', \mathcal{Y}^1(\pi_m(\Omega_{-1}(\mathcal{Y}^2)(w_1, e^{l_{-1/2}(-r_0+\varepsilon)})\pi_n(\Omega(Y_{W_2})(w_2, \varepsilon)\mathbf{1})), e^{\log r_1})w_3 \right\rangle. \end{aligned}$$

By Proposition 12.7, part 3, of [HLZ8] and its proof, the last of the above series, considered as a double sum over $m, n \in \mathbb{R}$, converges absolutely, when

$$r_1 > |-r_0 + \varepsilon| > |\varepsilon| > 0,$$

to an analytic function of ε defined in some open neighborhood surrounding 0 which might not include 0 itself. However, we show that this double series remains analytic at 0. Note that

$$\begin{aligned}
& \sum_{m,n \in \mathbb{R}} \left\langle w', \mathcal{Y}^1(\pi_m(\Omega_{-1}(\mathcal{Y}^2)(w_1, e^{l_{-1/2}(z_0)})\pi_n(\Omega(Y_{W_2})(w_2, \varepsilon)\mathbf{1})), e^{\log r_1})w_3 \right\rangle \\
&= \sum_{n \in \mathbb{R}} \sum_{m \in \mathbb{R}} \left\langle w', \mathcal{Y}^1(\pi_m(\Omega_{-1}(\mathcal{Y}^2)(w_1, e^{l_{-1/2}(z_0)})\pi_n(e^{\varepsilon L(-1)}w_2)), e^{\log r_1})w_3 \right\rangle \\
&= \sum_{j \geq 0} \frac{\varepsilon^j}{j!} \left\langle w', \mathcal{Y}^1(\Omega_{-1}(\mathcal{Y}^2)(w_1, e^{l_{-1/2}(z_0)})L(-1)^j w_2, e^{\log r_1})w_3 \right\rangle
\end{aligned} \tag{3.45}$$

defines an analytic function in z_0 and ε when z_0 is contained in a sufficiently small open neighborhood of $-r_0$ and when ε is contained in a sufficiently small open neighborhood (possibly not including 0 itself) surrounding 0. But for each such z_0 , (3.45) is a power series in ε with positive radius of convergence, so the analytic function it defines is still analytic at $\varepsilon = 0$. Then replacing z_0 with $-r_0 + \varepsilon$ for ε sufficiently small, we see that

$$\sum_{m,n \in \mathbb{R}} \left\langle w', \mathcal{Y}^1(\pi_m(\Omega_{-1}(\mathcal{Y}^2)(w_1, e^{l_{-1/2}(-r_0+\varepsilon)})\pi_n(\Omega(Y_{W_2})(w_2, \varepsilon)\mathbf{1})), e^{\log r_1})w_3 \right\rangle$$

is an analytic function of ε at 0, and this means that (3.42) converges absolutely to an analytic function of ε in an open set containing 0.

Finally, since (3.42) and (3.43) converge absolutely to analytic functions on some common open set containing 0, since this common open set has a non-empty intersection with U (since 0 is contained in the boundary of U), and since the two analytic functions agree on U , we can conclude that (3.42) and (3.43) are equal when $\varepsilon = 0$. This completes the proof of the proposition. \square

Now we take as our setting an extension $V \subseteq A$ where A is a vertex operator superalgebra containing V in its even part. It is not necessary to assume A is an object in a vertex tensor category of V -modules since modules in $\text{Rep } A$ can be defined as in Proposition 3.46; we just need the relevant compositions of vertex operators to converge in their respective domains.

We recall the notion of left (respectively, right and two-sided) ideal in A (see for instance [LL, Definition 3.9.7 and Remark 3.9.8] in the vertex operator algebra setting): a (not necessarily parity-graded) subspace $I \subseteq A$ such that for all $a \in A$, $b \in I$, $Y(a, x)b \in I((x))$ (respectively, $Y(b, x)a \in I((x))$ and both $Y(b, x)a, Y(a, x)b \in I((x))$). Equivalently, for all $z \in \mathbb{C}^\times$, $Y(a, z)b \in \overline{I}$ (respectively, $Y(b, z)a \in \overline{I}$ and both $Y(b, z)a, Y(a, z)b \in \overline{I}$). For an object (W, Y_W) in $\text{Rep } A$ and a subset $T \subseteq W$, define (see [LL, Equation 4.5.33])

$$\text{Ann}_A(T) = \{a \in A \mid Y_W(a, x)t = 0 \text{ for all } t \in T\}.$$

Lemma 3.72. *A parity-graded one-sided ideal I of a vertex operator superalgebra A is two-sided.*

Proof. The result follows by observing that given parity-homogeneous elements $a \in A$, $b \in I$, we have

$$Y(a, x)b = (-1)^{|a||b|} e^{xL(-1)}Y(b, -x)a$$

using skew-symmetry, and moreover $L(-1)$ preserves one-sided ideals (see [LL, Remark 3.9.8]). \square

Now we have the following analogue of [LL, Theorem 4.5.11]:

Lemma 3.73. *The annihilator $\text{Ann}_A(T)$ is a left ideal of A . If T contains the (non-zero) parity-homogeneous components of its elements, then $\text{Ann}_A(T)$ is parity-graded and hence a two-sided ideal.*

Proof. The annihilator $\text{Ann}_A(T)$ is clearly a subspace of A . Now we need to show that for any $a \in A$, $b \in \text{Ann}_A(T)$, $n \in \mathbb{Z}$, and $t \in T$,

$$Y_W(a_n b, x)t = 0.$$

This is equivalent to

$$\langle w', Y_W(a_n b, x)t \rangle = 0$$

for any $w' \in W'$, which, using the theory of unique expansion sets (see [HLZ5, Definition 7.5 and Proposition 7.8]) and our assumptions on the conformal weights of W , is equivalent to

$$\langle w', Y_W(a_n b, e^{\log z_2}t) \rangle = 0$$

for all z_2 in some non-empty open subset of \mathbb{C}^\times . To show this, fix $z_2 \in \mathbb{C}^\times$ such that $\operatorname{Re} z_2, \operatorname{Im} z_2 > 0$. Then applying the associativity property of Proposition 3.46 to Y_W and using $b \in \operatorname{Ann}_A(T)$, we get

$$\begin{aligned} \sum_{n \in \mathbb{Z}} \langle w', Y_W(a_n b, e^{\log z_2} t) z_0^{-n-1} \rangle &= \langle w', Y_W(Y(a, z_0) b, e^{\log z_2} t) \rangle \\ &= \langle w', Y_W(a, e^{\log(z_0+z_2)}) Y_W(b, e^{\log z_2} t) \rangle = 0, \end{aligned}$$

for any $z_0 \in \mathbb{C}^\times$ such that $(z_0 + z_2, z_2) \in S_1$. Such z_0 form a non-empty open set, so the (single-valued) meromorphic function $\sum_{n \in \mathbb{Z}} \langle w', Y_W(a_n b, e^{\log z_2} t) z_0^{-n-1} \rangle$ is identically zero on its entire domain (all z_0 such that $0 < |z_0| < |z_2|$). In particular, all coefficients of its Laurent series expansion are zero. Thus

$$\langle w', Y_W(a_n b, e^{\log z_2} t) \rangle = 0$$

for all $n \in \mathbb{Z}$ and all $z_2 \in \mathbb{C}^\times$ such that $\operatorname{Re} z_2, \operatorname{Im} z_2 > 0$. Since such z_2 form a non-empty open set, it follows that $\langle w', Y_W(a_n b, x) t \rangle = 0$, as desired. Thus $\operatorname{Ann}_A(T)$ is a left ideal.

For the second statement, if $b \in \operatorname{Ann}_A(T)$ has parity decomposition $b = b^{\bar{0}} + b^{\bar{1}}$, then for each non-zero parity-homogeneous $t \in T$, the coefficients of $Y_W(b^{\bar{0}}, x) t$ and $Y_W(b^{\bar{1}}, x) t$ are homogeneous of different parities. Thus because their sum is zero, they are individually zero and $b^{\bar{0}}, b^{\bar{1}} \in \operatorname{Ann}_A(T)$. Now, $\operatorname{Ann}_A(T)$ is two-sided by Lemma 3.72. \square

Now we prove for objects in $\operatorname{Rep} A$ the analogue of [LL, Proposition 4.5.6]. For a module (W, Y_W) in $\operatorname{Rep} A$ and a subset $T \subseteq W$, recall that the A -submodule $\langle T \rangle$ generated by T is the smallest subspace of W containing T and closed under the vertex operator Y_W . The submodule $\langle T \rangle$ is graded by conformal weights since it is closed under $L(0)$, but it may not be parity-graded.

Lemma 3.74. *The submodule $\langle T \rangle$ is spanned by the vectors $a_{n;k} t$ for $a \in A$, $n \in \mathbb{R}$, $k \in \mathbb{N}$, and $t \in T$. The parity-graded submodule generated by T is spanned by the parity-homogeneous components of $a_{n;k} t$ for $a \in A$, $n \in \mathbb{R}$, $k \in \mathbb{N}$, and $t \in T$.*

Proof. Set \widetilde{W} to be the span of the vectors $a_{n;k} t$ for $a \in A$, $n \in \mathbb{R}$, $k \in \mathbb{N}$, and $t \in T$. To show that $\widetilde{W} = \langle T \rangle$, it is sufficient to show that \widetilde{W} is closed under Y_W . We claim that \widetilde{W} is graded by conformal weights. Indeed, it follows from the straightforward generalization of [LL, Proposition 4.5.7] to logarithmic intertwining operators among V -modules, as in the proof of [LL, Proposition 4.5.6], that \widetilde{W} is a V -submodule of W . In particular, \widetilde{W} is $L(0)$ -stable and thus graded by conformal weights (see [HLZ1, Remark 2.13]).

Now set

$$\widetilde{W}^\perp = \{w' \in W' \mid \langle w', \widetilde{w} \rangle = 0 \text{ for all } \widetilde{w} \in \widetilde{W}\}.$$

Since \widetilde{W} is graded by conformal weights, so is \widetilde{W}^\perp . Then it follows that $\widetilde{W} = (\widetilde{W}^\perp)^\perp$ since this relation holds when restricted to each finite-dimensional weight space. In other words, $\widetilde{w} \in \widetilde{W}$ if and only if $\langle w', \widetilde{w} \rangle = 0$ for all $w' \in \widetilde{W}^\perp$. Thus $\widetilde{W} = \langle T \rangle$ if and only if for all $a_1 \in A$,

$$\langle w', Y_W(a_1, x_1)(a_2)_{n;k} t \rangle = 0$$

for all $w' \in \widetilde{W}^\perp$, $a_2 \in A$, $n \in \mathbb{R}$, $k \in \mathbb{N}$, $t \in T$. Using [HLZ5, Proposition 7.8], this is equivalent to

$$\langle w', Y_W(a_1, e^{\log z_1})(a_2)_{n;k} t \rangle = 0$$

for all z_1 in some non-empty open subset of \mathbb{C}^\times . We take z_1 such that $\operatorname{Re} z_1, \operatorname{Im} z_1 > 0$. Then by the associativity property of Proposition 3.46,

$$\begin{aligned} \sum_{n \in \mathbb{R}} \sum_{k \in \mathbb{N}} \langle w', Y_W(a_1, e^{\log z_1})(a_2)_{n;k} t \rangle e^{(-n-1) \log z_2} (\log z_2)^k &= \langle w', Y_W(a_1, e^{\log z_1}) Y_W(a_2, e^{\log z_2} t) \rangle \\ &= \langle w', Y_W(Y(a_1, e^{\log(z_1-z_2)}) a_2, e^{\log z_2} t) \rangle = \sum_{n \in \mathbb{R}} \langle w', Y_W(\pi_n(Y(a_1, e^{\log(z_1-z_2)}) a_2), e^{\log z_2} t) \rangle = 0 \end{aligned}$$

for all z_2 such that $(z_1, z_2) \in S_1$. Since such z_2 form a non-empty open set, [HLZ5, Proposition 7.8] implies that each coefficient of $e^{(-n-1) \log z_2} (\log z_2)^k$ in the first series above equals 0, as desired.

Now the subspace spanned by the parity-homogeneous components of $a_{n;k} t$ for $a \in A$, $n \in \mathbb{R}$, $k \in \mathbb{N}$, and $t \in T$ is certainly parity-graded and contained in any parity-graded submodule of W containing T . Then the above argument with T replaced by the parity-homogeneous components of elements of T shows that this subspace is a submodule. Thus the second conclusion of the lemma follows. \square

4 Applications

In this section, we apply our results on tensor categories for vertex operator superalgebra extensions, especially the induction functor, to several explicit examples.

4.1 Examples of vertex operator superalgebra extensions

In general, it is difficult to prove that one indeed has a vertex operator superalgebra extension. Therefore, we start with some strategies.

4.1.1 Simple current extensions

Certain types of simple current extensions were studied in [CKL]. Here we summarize a few important results. Let \mathcal{C} be a ribbon vertex tensor category of generalized modules for a simple vertex operator algebra V . Let J be a simple current, that is, J is simple and there exists a simple object J^{-1} such that $J^{-1} \boxtimes J \cong V$. Let $c_{J,J}$ be the scalar such that $\mathcal{R}_{J,J} = c_{J,J} 1_{J \boxtimes J}$ and let θ_J be the scalar by which the twist θ acts on J .

Theorem 4.1. [CKL, Corollary 2.8] *The following relation (spin statistics) holds:*

$$c_{J,J} = \theta_J \text{qdim}(J).$$

Theorem 4.2. [CKL, Theorem 3.9] *Let J be a self-dual simple current ($J \boxtimes J \cong V$) with $\theta_J = \pm 1$. This leads to the following four cases, with $A = V \oplus J$.*

1. When $\theta_J = 1$ and $\text{qdim}(J) = 1$, A has a natural structure of a \mathbb{Z} -graded vertex operator algebra.
2. When $\theta_J = 1$ and $\text{qdim}(J) = -1$, A has a natural structure of a \mathbb{Z} -graded vertex operator superalgebra with even part V and odd part J .
3. When $\theta_J = -1$ and $\text{qdim}(J) = 1$, A has a natural structure of a $\frac{1}{2}\mathbb{Z}$ -graded vertex operator superalgebra, with even part V and odd part J .
4. When $\theta_J = -1$ and $\text{qdim}(J) = -1$, A has a natural structure of a $\frac{1}{2}\mathbb{Z}$ -graded vertex operator algebra.

In many cases, $\text{qdim}(J)$ is easily deduced from modular S -matrices. Naturally, we refer to the cases with $\text{qdim}(J) = 1$ as producing ‘‘correct statistics’’ and $\text{qdim}(J) = -1$ as ‘‘wrong statistics.’’ In the next subsection, we will derive Verlinde formulae corresponding to these cases. A natural generalization of the above theorem when J is not necessarily self-dual was also given in [CKL], using [Ca].

There is also a criterion based on conformal weights that determines when objects in \mathcal{C} induce to objects of $\text{Rep}^0 A$. Let G be the group generated by a simple current J and let

$$A = \bigoplus_{g \in G} J^g.$$

Assume that A is a vertex operator superalgebra, which is the case if the twist satisfies

$$\theta_{J^g} \in \pm 1 \quad \text{and} \quad \theta_{J^g} = \theta_{J^{g+2}}$$

for all g [CKL, Theorem 3.12]. Let h_\bullet denote conformal dimensions, that is, lowest conformal weights.

Theorem 4.3. [CKL, Theorems 3.18 and 3.20] *Let P be an indecomposable generalized V -module in \mathcal{C} .*

1. *If P is a subquotient of a tensor product of several simple modules, then $\mathcal{F}(P)$ is in $\text{Rep}^0 A$ if and only if $h_{J \boxtimes P} - h_J - h_P \in \mathbb{Z}$.*
2. *Suppose J has finite order and P satisfies both $\dim(\text{Hom}(P, P)) < \infty$ and $\dim(\text{Hom}(J \boxtimes P, J \boxtimes P)) < \infty$. Assume also that $L(0)$ has Jordan blocks of bounded size on both P and $J \boxtimes P$. Then $\mathcal{F}(P)$ is an object of $\text{Rep}^0 A$ if and only if $h_{J \boxtimes P} - h_J - h_P \in \mathbb{Z}$.*

If \mathcal{C} is locally finite, the finiteness assumptions in part (2) are satisfied automatically. Among other things, this criterion led to a new proof of rationality of parafermions for affine Lie algebras at positive integral levels in [CKLR]. We shall use this and similar criteria below.

We now present two propositions that we shall frequently use below. The first is stated for extensions that are not necessarily of simple current type:

Proposition 4.4. *Let A be a vertex operator (super)algebra extension of V with $V \subseteq A^{\bar{0}}$ and both A, V simple, and suppose $A = \bigoplus_{i \in I} A_i$ as a V -module with each A_i a simple V -module. If W is a simple V -module such that each non-zero $A_i \boxtimes_V W$ is a simple V -module and each non-zero $A_i \boxtimes_V W \not\cong A_j \boxtimes_V W$ unless $i = j$, then $\mathcal{F}(W)$ is a simple object of $\text{Rep } A$.*

Proof. Since $A_i \boxtimes_V W \not\cong A_j \boxtimes_V W$ unless $i = j$, the A_i are non-isomorphic V -modules. Since $V \subseteq A^{\bar{0}}$, the parity-homogeneous components of A are V -modules, and so because the A_i are distinct and simple, the Density Theorem implies that $A^{\bar{0}}$ and $A^{\bar{1}}$ are direct sums of certain A_i . That is, each A_i has definite parity.

We have $\mathcal{F}(W) = \bigoplus_{i \in I} A_i \boxtimes_V W$. We will identify the component isomorphic to W in $\mathcal{F}(W)$ with W and let $W_j = A_j \boxtimes_V W$. Since W is a simple V -module, it must have definite parity as an object of \mathcal{SC} ; thus the parity-homogeneous components of $\mathcal{F}(W)$ are $A^{\bar{0}} \boxtimes_V W$ and $A^{\bar{1}} \boxtimes_V W$. If X is a non-zero A -submodule of $\mathcal{F}(W)$, then because the $A_i \boxtimes_V W$ are simple and mutually inequivalent, the Density Theorem implies there is some $j \in I$ such that $W_j = A_j \boxtimes_V W \subseteq X$. Let $\langle W_j \rangle$ be the A -submodule of $\mathcal{F}(W)$ generated by W_j .

Now, we prove that $\langle W_j \rangle = \mathcal{F}(W)$, so that $\mathcal{F}(W) = \langle W_j \rangle \subseteq X$, that is, $X = \mathcal{F}(W)$. We use the observation that for any non-zero and parity-homogeneous $a \in A, w \in W$,

$$\langle a_{n;k}w \mid n \in \mathbb{R}, k \in \mathbb{N} \rangle = \langle w \rangle,$$

where angle braces denote the generated submodule and $a_{n;k}w$ is the coefficient of $x^{-n-1}(\log x)^k$ in $Y_W(a, x)w$. Indeed, it is clear that $\langle a_{n;k}w \mid n \in \mathbb{R}, k \in \mathbb{N} \rangle \subseteq \langle w \rangle$. Then a is in the $\mathbb{Z}/2\mathbb{Z}$ -graded annihilator ideal (see Lemma 3.73) of the image of w in the $\mathbb{Z}/2\mathbb{Z}$ -graded quotient module $\langle w \rangle / \langle a_{n;k}w \mid n \in \mathbb{R}, k \in \mathbb{N} \rangle$. Since $a \neq 0$ and A is simple, this means A annihilates the image of w in the quotient. Since the image of w also generates the quotient, the quotient is zero and $\langle a_{n;k}w \mid n \in \mathbb{R}, k \in \mathbb{N} \rangle = \langle w \rangle$, justifying the observation. Now take a non-zero $a \in A_j$ and non-zero $w \in W$; both of these vectors are parity-homogeneous. Then the observation implies

$$\langle W_j \rangle \supseteq \langle a_{n;k}w \mid n \in \mathbb{R}, k \in \mathbb{N} \rangle = \langle w \rangle = \mathcal{F}(W)$$

as desired; here we are identifying $w \in W$ with $\mathbf{1} \boxtimes_V w \in V \boxtimes_V W$. \square

Proposition 4.5. *Let \mathcal{C} be a semisimple vertex tensor category of modules for a simple vertex operator algebra A_0 , and let A be a simple (super)algebra in \mathcal{C} such that $A = \bigoplus_{g \in G} A_g$ for G a finite abelian group and $A_g \boxtimes A_h \cong A_{gh}$ for $g, h \in G$. Assume fixed-point freeness: for every simple module W in \mathcal{C} , $A_g \boxtimes W \cong W$ implies $g = 1$. Then:*

1. *If W is simple in \mathcal{SC} , then $\mathcal{F}(W)$ is simple in $\text{Rep } A$.*
2. *Every simple object in $\text{Rep } A$ is isomorphic to an induced object.*
3. *If W is simple in \mathcal{SC} , then $\mathcal{F}(W)$ is isomorphic to $\mathcal{F}(A_g \boxtimes W)$ in $\text{Rep } A$ for any $g \in G$.*
4. *Suppose \mathcal{C} is a ribbon category and $\theta_A = 1_A$. If W_1, W_2 are two simple objects of \mathcal{SC} such that $\mathcal{F}(W_1), \mathcal{F}(W_2)$ are objects of $\text{Rep}^0 A$, then for every g, h in G ,*

$$S_{\mathcal{F}(A_g \boxtimes W_1), \mathcal{F}(A_h \boxtimes W_2)}^{\infty} = S_{\mathcal{F}(W_1), \mathcal{F}(W_2)}^{\infty}.$$

Proof. Since $A_g \boxtimes A_{-g} \cong A_0$, each A_g is a simple current, and hence $A_g \boxtimes W$ is simple for any simple object W of \mathcal{C} (see [CKLR]). Now the first assertion is immediate from Proposition 4.4.

Now let X be a simple object in $\text{Rep } A$. By the semisimplicity of \mathcal{C} (and thus also of \mathcal{SC}) we have $X \cong_{\mathcal{SC}} \bigoplus_{i \in I} X_i$, where the X_i are simple objects in \mathcal{SC} . For any such X_i , we have the (non-zero, even) \mathcal{C} -inclusion $X_i \hookrightarrow \mathcal{G}(X)$ where \mathcal{G} is the restriction functor, so by Lemma 2.61, there is a non-zero, even $\text{Rep } A$ -morphism $f : \mathcal{F}(X_i) \rightarrow X$. Since $A_g \boxtimes \cdot$ is fixed-point free, Proposition 4.4 shows that $\mathcal{F}(X_i)$ is simple. Then by Schur's Lemma, $f : \mathcal{F}(X_i) \rightarrow X$ is an isomorphism.

This argument also implies that $\mathcal{F}(X_i) \cong \mathcal{F}(X_j) \cong X$ whenever X_i, X_j are two summands appearing in the direct sum decomposition of $\mathcal{G}(X)$. Now, if W is simple in \mathcal{C} , then $A_g \boxtimes W$ and $W \cong A_0 \boxtimes W$ are summands in $\mathcal{G}(\mathcal{F}(W))$. Hence, the previous argument shows that $\mathcal{F}(W) \cong \mathcal{F}(A_g \boxtimes W)$ for any $g \in G$.

From Proposition 2.86, induced objects in $\text{Rep}^0 A$ form a ribbon category since $\theta_A = 1_A$. Then the conclusion about the S^{∞} -matrix is easy by properties of traces and monodromies: if $f_1 : X_1 \rightarrow \tilde{X}_1$ and $f_2 : X_2 \rightarrow \tilde{X}_2$ are any even isomorphisms in a ribbon supercategory, then

$$S_{\tilde{X}_1, \tilde{X}_2}^{\infty} = \text{Tr}(\mathcal{M}_{\tilde{X}_1, \tilde{X}_2}) = \text{Tr}((f_1 \boxtimes f_2) \circ \mathcal{M}_{X_1, X_2} \circ (f_1^{-1} \boxtimes f_2^{-1})) = \text{Tr}(\mathcal{M}_{X_1, X_2}) = S_{X_1, X_2}^{\infty},$$

using Corollary 2.85. \square

Remark 4.6. In Propositions 4.4 and 4.5, there is some ambiguity about what is a simple object in $\text{Rep } A$: should it have no proper non-zero A -submodules, or should it have no proper non-zero $\mathbb{Z}/2\mathbb{Z}$ -graded A -submodules? We will discuss this issue in more detail in Section 4.2, but for now we note that it does not affect the results here. In the proof of Proposition 4.4, no $\mathbb{Z}/2\mathbb{Z}$ -grading assumption was needed for the submodule X , because the conclusion that $\langle W_j \rangle \subseteq X$ for some j followed from properties of modules for the vertex operator algebra V . Thus under the assumptions of Proposition 4.4, simple V -modules induce to modules in $\text{Rep } A$ which are simple in both possible senses. The distinction between the two possible meanings of simplicity in $\text{Rep } A$ also does not affect Proposition 4.5 because the evenness of the morphism $f : \mathcal{F}(X_i) \rightarrow X$ in the proof of part 2 implies that its kernel and image are $\mathbb{Z}/2\mathbb{Z}$ -graded; hence Schur's Lemma applies regardless of what is meant by the simplicity of X .

Example 4.7. Some of the best-known rational and C_2 -cofinite vertex algebras are those associated to even lattices L , denoted V_L [FLM, Do]. The inequivalent simple modules M_λ are parameterized by $\lambda \in L'/L$ with L' the lattice dual to L . Moreover, the fusion rules are given by addition in L'/L , that is,

$$M_\lambda \boxtimes M_\mu \cong M_{\lambda+\mu}.$$

Especially, every simple object is a simple current. Their dimensions $\text{qdim}(M_\lambda) = 1$ follow immediately from the modular transformations of characters. Let $L \subseteq N \subseteq L'$. If N is an even lattice, then the M_λ for $\lambda \in N/L$ are \mathbb{Z} -graded, so

$$A = \bigoplus_{\lambda \in N/L} M_\lambda$$

is a vertex algebra extension of V . If N is an integral lattice, then A is a vertex superalgebra.

More interesting vertex operator (super)algebras can be constructed from known ones via standard constructions such as kernel of screenings, cohomologies, and cosets. We illustrate this next in a few examples involving well-known vertex operator algebras such as lattice and Virasoro vertex operator algebras, and affine vertex operator algebras associated to \mathfrak{sl}_2 . We start with extensions of tensor products of triplet algebras as subalgebras of lattice vertex superalgebras.

4.1.2 Extensions associated to $\mathcal{W}(p)$ -algebras via kernels of screening charges

The general idea of this section is as follows: Let V be a vertex operator algebra, W a V -module, and Q a screening operator, that is, the zero-mode of an intertwiner from V to W , such that its kernel is a vertex operator subalgebra $U \subseteq V$. Then one uses extensions of V to construct extensions of the subalgebra U . In our example here, V will be a lattice vertex operator algebra, and we will construct some new vertex operator algebras as extensions of tensor products of $\mathcal{W}(p)$ -algebras. The $\mathcal{W}(p)$ -algebras are non-rational vertex operator algebras, but they are C_2 -cofinite, simple, and self-contragredient. They are by far the best understood class of vertex operator algebras of this type: see for example [Kau, FGST2, AM2, AM3, AM4, TW1]. We use [CRW] as reference.

Define $\alpha_+ = \sqrt{2p}$ and $\alpha_- = -\sqrt{2/p}$. Consider the vertex operator algebra $V_{\sqrt{2p}\mathbb{Z}}$ associated to the lattice $\sqrt{2p}\mathbb{Z}$. The vertex subalgebra of $V_{\sqrt{2p}\mathbb{Z}}$ given by

$$X_1^+(p) = \mathcal{W}(p) = \text{Ker} \left(\int Q_- : V_{\sqrt{2p}\mathbb{Z}} \rightarrow V_{\sqrt{2p}\mathbb{Z} + \alpha_-} \right)$$

is the triplet algebra $\mathcal{W}(p)$, where Q_- is the vertex operator corresponding to the dual lattice element e^{α_-} , and \int stands for its zero mode. The subalgebra $\mathcal{W}(p)$ has a different conformal vector than $V_{\alpha_+\mathbb{Z}}$, given by

$$\frac{1}{2}a(-1)^2 + \frac{p-1}{\sqrt{2p}}a(-2)$$

with $\langle a, a \rangle = 1$. The kernel

$$X_1^-(p) = \text{Ker} \left(\int Q_- : V_{\sqrt{2p}\mathbb{Z} + p} \rightarrow V_{\sqrt{2p}\mathbb{Z} + p + \alpha_-} \right)$$

is a simple $\mathcal{W}(p)$ -module denoted by $X_1^-(p)$. From [CKL, Equation 4.5], the dimension of this module is

$$\text{qdim}(X_1^-(p)) = -(-1)^p.$$

Let

$$\mathcal{W} := \mathcal{W}(p_1) \otimes \cdots \otimes \mathcal{W}(p_n)$$

for a choice of n triplet algebras $\mathcal{W}(p_1), \dots, \mathcal{W}(p_n)$. Define two lattices

$$L := \sqrt{2p_1}\mathbb{Z} \oplus \sqrt{2p_2}\mathbb{Z} \oplus \dots \oplus \sqrt{2p_{n-1}}\mathbb{Z} \oplus \sqrt{2p_n}\mathbb{Z} \quad \text{and}$$

$$N := \sqrt{\frac{p_1}{2}}\mathbb{Z} \oplus \sqrt{\frac{p_2}{2}}\mathbb{Z} \oplus \dots \oplus \sqrt{\frac{p_{n-1}}{2}}\mathbb{Z} \oplus \sqrt{\frac{p_n}{2}}\mathbb{Z}$$

so that $N/L \cong (\mathbb{Z}/2\mathbb{Z})^n$. Let $L \subseteq R \subseteq N$ be another lattice, so that R/L can be identified with a binary code $C_R \subseteq (\mathbb{Z}/2\mathbb{Z})^n$. We require R to be an integral lattice so that one has the lattice vertex operator algebra V_R if R is even and the lattice vertex operator superalgebra otherwise. Let

$$\mathcal{W}_R := \bigcap_{i=1}^n \text{Ker} \left(\int Q_-^{(i)} : V_R \rightarrow V_{R+\alpha_-^{(i)}} \right)$$

where $Q_-^{(i)}$ is the screening charge of $\mathcal{W}(p_i)$ and $\alpha_-^{(i)}$ is the dual lattice vector with all entries equal to zero except the i -th one being $-\sqrt{2/p_i}$. Then \mathcal{W}_R is a vertex algebra as it is the joint kernel of screenings of a vertex operator algebra. Defining $\pi : \mathbb{Z}/2\mathbb{Z} \rightarrow \{\pm\}$ by $\pi(0) = +$ and $\pi(1) = -$, we have

$$\mathcal{W}_R \cong \bigoplus_{x \in C_R} M(x), \quad M(x) = X_1^{\pi(x_1)}(p_1) \otimes \dots \otimes X_1^{\pi(x_n)}(p_n)$$

as a module for \mathcal{W} . Note the conformal dimension

$$\Delta(X_1^-(p_i)) = \frac{3p_i - 2}{4}.$$

We have several interesting cases:

1. If $p_i \equiv 0 \pmod{4}$ for all $i = 1, \dots, n$, then N is an even lattice and hence so is R . It follows that V_R is a vertex operator algebra and hence so is \mathcal{W}_R . Since $\Delta(X_1^-(p_i)) = \frac{3p_i - 2}{4} \equiv \frac{1}{2} \pmod{\mathbb{Z}}$, even code words correspond to \mathbb{Z} -graded modules and odd code words to $(\mathbb{Z} + \frac{1}{2})$ -graded modules. This means that if C_R is an even code, then \mathcal{W}_R is a \mathbb{Z} -graded vertex operator algebra, and otherwise \mathcal{W}_R is a $\frac{1}{2}\mathbb{Z}$ -graded vertex operator algebra.
2. If $p_i \equiv 2 \pmod{4}$ for all $i = 1, \dots, n$, then N is an odd lattice. It follows that R is an even lattice if C_R is an even code and an odd lattice otherwise. Hence V_R is a vertex operator algebra if C_R is even and a vertex operator superalgebra otherwise. Since $\Delta(X_1^-(p_i)) = \frac{3p_i - 2}{4} \equiv 0 \pmod{\mathbb{Z}}$, all modules are \mathbb{Z} -graded. This means that if C_R is an even code, then \mathcal{W}_R is a \mathbb{Z} -graded vertex operator algebra, and otherwise \mathcal{W}_R is a \mathbb{Z} -graded vertex operator superalgebra.
3. If $p_i \equiv 1 \pmod{4}$ for all $i = 1, \dots, n$ and C_R is a doubly even code, then R is an even lattice. Hence V_R is a vertex operator algebra. Since $\Delta(X_1^-(p_i)) = \frac{3p_i - 2}{4} \equiv \frac{1}{4} \pmod{\mathbb{Z}}$, \mathcal{W}_R is \mathbb{Z} -graded, that is, \mathcal{W}_R is a \mathbb{Z} -graded vertex operator algebra.

4.1.3 Extensions associated to Virasoro algebras via screenings and cosets

Now we will construct extensions of tensor products of Virasoro algebras. We present two methods, using screening charges and cosets. While the first method is more general (and similar to the previous section), the second has the advantage that it allows one to prove that the extension algebra is a simple vertex operator algebra. The general idea is as follows:

Let V be a vertex operator algebra and $U \subseteq V$ a vertex operator subalgebra with a different conformal vector. Then the subalgebra

$$C = \text{Com}(U, V) = \{c \in V \mid [Y(c, x_1), Y(u, x_2)] = 0 \text{ for all } u \in U\}$$

is called the commutant or coset subalgebra of V . Often, U is an affine vertex subalgebra of V , and it turns out that many important vertex operator algebras appear as cosets of affine vertex subalgebras inside larger structures. Probably the best-known family is $V = V^{k-1}(\mathfrak{g}) \otimes L_1(\mathfrak{g})$ and $U = V^k(\mathfrak{g})$ for \mathfrak{g} a simply-laced Lie algebra and $V^k(\mathfrak{g})$ the universal affine vertex operator algebra of \mathfrak{g} at level k and $L_k(\mathfrak{g})$ its simple quotient. In this case the coset is the principal W -algebra of \mathfrak{g} at a certain level $\ell(k)$ depending on k [ACL2]. This means that the coset of $U = V^k(\mathfrak{g})$ in $V = V^{k-2}(\mathfrak{g}) \otimes L_1(\mathfrak{g}) \otimes L_1(\mathfrak{g})$ is automatically an extension of the tensor product of the principal W -algebras of \mathfrak{g} at levels $\ell(k-1)$ and $\ell(k)$. The principal W -algebra of \mathfrak{sl}_2 at level k is the Virasoro algebra at central charge $13 - 6(k+2) - 6(k+2)^{-1}$. It turns out that more general coset theorems can be very effectively used to construct many families of extensions of tensor products of W -algebras; see [ACF, Theorem 9.1].

We turn to the example of the Virasoro algebra. As reference on screening charges and the subtleties on choosing contours we refer to [TK1, TK2, TW2]; we also use [IK, dFMS]. Denote by $\text{Vir}(u, v)$ the simple rational Virasoro vertex operator algebra of central charge

$$c = 1 - 6 \frac{(u-v)^2}{uv}.$$

Then let $\alpha_+ = \sqrt{2v/u}$ and $\alpha_- = -\sqrt{2u/v}$ so that $\alpha_+ \alpha_- = -2$. Further set $\alpha_0 = \alpha_+ + \alpha_-$. We set

$$\alpha_{r,s} = \frac{1-r}{2} \alpha_+ + \frac{1-s}{2} \alpha_-$$

Modules of $\text{Vir}(u, v)$ are then constructible as cohomology of an s -fold contour, a screening charge $Q_{[s]}$, acting on Fock modules of a rank one Heisenberg vertex operator algebra. The result is

$$H^{Q_{[s]}}(\mathcal{F}_\lambda) = \begin{cases} W_{r,s} & \text{if } \lambda = \alpha_{r,s} \text{ for } 1 \leq r \leq u-1 \text{ and } 1 \leq s \leq v-1 \\ 0 & \text{otherwise} \end{cases}. \quad (4.1)$$

The $W_{r,s}$ are simple, every simple $\text{Vir}(u, v)$ -module is isomorphic to at least one of them, and further $W_{r,s} \cong W_{u-r, v-s}$. The conformal dimension of $W_{r,s}$ is

$$h_{r,s} = \frac{1}{2} \alpha_{r,s} (\alpha_{r,s} - \alpha_0) = \frac{(rv-us)^2 - (u-v)^2}{4uv}$$

with $\alpha_0 = \alpha_+ + \alpha_-$. The Virasoro vertex operator algebra itself is $W_{1,1}$. We next want to extend

$$V = \text{Vir}(u_1, v_1) \otimes \cdots \otimes \text{Vir}(u_n, v_n)$$

for some choice of n Virasoro vertex operator algebras. Let

$$\alpha_\pm^{(i)} := \pm \sqrt{2 \left(\frac{v_i}{u_i} \right)^{\pm 1}} \quad \text{and} \quad \alpha_{r,s}^{(i)} = \frac{1-r}{2} \alpha_+^{(i)} + \frac{1-s}{2} \alpha_-^{(i)}.$$

Let

$$L = \alpha_{2,1}^{(1)} \mathbb{Z} \oplus \alpha_{2,1}^{(2)} \mathbb{Z} \oplus \cdots \oplus \alpha_{2,1}^{(n-1)} \mathbb{Z} \oplus \alpha_{2,1}^{(n)} \mathbb{Z}$$

and N an even sublattice. Let $Q^{(i)} = Q_{[1]}^{(i)}$. The cohomology $H^Q(V_N)$ of

$$Q = Q^{(1)} + \cdots + Q^{(n)}$$

associated to the n screening charges $Q^{(1)}, \dots, Q^{(n)}$ corresponding to the choice of n Virasoro vertex operator algebras is then a module for V . Since V_N a vertex operator algebra, the same is true for $H^Q(V_N)$ provided the latter is \mathbb{Z} -graded by $L(0)$. If we replace N by an integral lattice we might end up with a vertex operator superalgebra. This grading question is described by the inner product with a vector

$$\rho = \alpha_0^{(1)} + \cdots + \alpha_0^{(n)}, \quad \alpha_0^{(i)} = \alpha_+^{(i)} + \alpha_-^{(i)},$$

namely:

Theorem 4.8. *If N is an even lattice extending the rank n Heisenberg vertex operator algebra, then $H^Q(V_N)$ is a vertex operator algebra if and only if $(\rho, \lambda) \in 2\mathbb{Z}$ for all λ in N . Let $L \supseteq N$ be another lattice such that $L/N = \mathbb{Z}/2\mathbb{Z}$ and with glue vector γ , that is $L = N \cup (N + \gamma)$. Then we have the following cases:*

1. $H^Q(V_L)$ is a \mathbb{Z} -graded vertex operator algebra if γ^2 and (ρ, γ) are even.
2. $H^Q(V_L)$ is a $\frac{1}{2}\mathbb{Z}$ -graded vertex operator algebra if γ^2 is even and (ρ, γ) is odd.
3. $H^Q(V_L)$ is a $\frac{1}{2}\mathbb{Z}$ -graded vertex operator superalgebra if γ^2 is odd and (ρ, γ) is even.
4. $H^Q(V_L)$ is a \mathbb{Z} -graded vertex operator superalgebra if γ^2 and (ρ, γ) are odd.

The following illustrates the theorem:

Corollary 4.9. *Let u, v, w be positive integers such that both v and w are coprime to u . Then*

$$\mathcal{A}_{u,v,w} := \bigoplus_{i=1}^{u-1} W_{i,1}^{(u,v)} \otimes W_{i,1}^{(u,w)}$$

for $v+w = 2du$ has a vertex operator superalgebra structure extending $\text{Vir}(u, v) \otimes \text{Vir}(u, w)$ if d is odd and a vertex operator algebra structure extending $\text{Vir}(u, v) \otimes \text{Vir}(u, w)$ if d is even.

Proof. We have that $\alpha_+^{(1)} = \sqrt{2v/u}$ and $\alpha_+^{(2)} = \sqrt{2w/u}$. Define $\lambda = \frac{1}{2} (\alpha_+^{(1)}, \alpha_+^{(2)}) \in \mathbb{R}^2$ and the rank one lattice $L = \lambda\mathbb{Z}$. Then from (4.1) it is clear that

$$H^Q(\mathcal{F}_{(1-i)\lambda}) = \begin{cases} W_{i,1}^{(u,v)} \otimes W_{i,1}^{(u,w)} & \text{if } 1 \leq i \leq u-1 \\ 0 & \text{otherwise} \end{cases}$$

and hence

$$H^Q(V_L) = \bigoplus_{i=1}^{u-1} W_{i,1}^{(u,v)} \otimes W_{i,1}^{(u,w)}.$$

It remains to verify conformal dimensions. We have

$$\Delta(\mathcal{F}_\lambda) = \frac{\lambda^2}{2} = \frac{1}{4} \frac{v+w}{u} = \frac{d}{2}$$

so that V_L is a vertex operator algebra if d is even and a vertex operator superalgebra if d is odd. Moreover the conformal dimension of $H^Q(\mathcal{F}_{(1-i)\lambda})$ is

$$\begin{aligned} \Delta(H^Q(\mathcal{F}_{(1-i)\lambda})) &= \frac{(vi-u)^2 - (v-u)^2}{4uv} + \frac{(wi-u)^2 - (w-u)^2}{4uw} \\ &= 1-i + \frac{(i^2-1)(v+w)}{4u} = 1-i + \frac{d(i^2-1)}{2} \end{aligned}$$

so that we have

$$\Delta(F_\lambda) \equiv \Delta(H^Q(\mathcal{F}_{(1-i)\lambda})) \pmod{\mathbb{Z}},$$

that is, $H^Q(V_L)$ is also a vertex operator superalgebra if d is odd and a vertex operator algebra if d is even. \square

It is not clear from the construction whether the vertex operator (super)algebra structure on $\mathcal{A}_{u,v,w}$ is simple. When $d = 1$, another construction shows that $\mathcal{A}_{u,v,w}$ can be given a simple vertex operator (super)algebra structure:

Theorem 4.10. *Let*

$$k = \frac{v}{u-v} - 2 = \frac{u}{w-u} - 3, \quad v+w = 2u \quad \text{and} \quad v < u.$$

Then

$$\mathcal{A}_{u,v,w} \cong C_k := \text{Com}(L_{k+2}(\mathfrak{sl}_2), \mathcal{F}(4) \otimes L_k(\mathfrak{sl}_2))$$

as $\text{Vir}(u,w) \otimes \text{Vir}(u,v)$ -modules. In particular, C_k is a simple vertex operator algebra extension of a rational vertex operator algebra.

Proof. Let ω_0, ω_1 be the fundamental weights of $\widehat{\mathfrak{sl}}_2$, so that $L_k(\mathfrak{sl}_2) = L(k\omega_0)$. Recall that the vertex operator superalgebra $\mathcal{F}(4)$ of four free fermions is isomorphic to

$$\mathcal{F}(4) \cong (L_1(\mathfrak{sl}_2) \otimes L_1(\mathfrak{sl}_2)) \oplus (L(\omega_1) \otimes L(\omega_1)).$$

Using Remark 10.3 of [IK] it is a computation to verify that

$$\begin{aligned} \mathcal{F}(4) \otimes L(k\omega_0) &\cong (L(\omega_0) \otimes L(\omega_0) \otimes L(k\omega_0)) \oplus (L(\omega_1) \otimes L(\omega_1) \otimes L(k\omega_0)) \\ &\cong \left(\bigoplus_{\substack{m=1 \\ m \text{ odd}}}^{u-1} L(\omega_0) \otimes L((k+2-m)\omega_0 + (m-1)\omega_1) \otimes W_{m,1}^{(u,v)} \right) \oplus \\ &\quad \oplus \left(\bigoplus_{\substack{m=2 \\ m \text{ even}}}^{u-1} L(\omega_1) \otimes L((k+2-m)\omega_0 + (m-1)\omega_1) \otimes W_{m,1}^{(u,v)} \right) \\ &\cong \bigoplus_{m=1}^{u-1} \bigoplus_{\substack{m'=1 \\ m' \text{ odd}}}^{w-1} L((k+3-m')\omega_0 + (m'-1)\omega_1) \otimes W_{m,m'}^{(u,w)} \otimes W_{m,1}^{(u,v)} \end{aligned}$$

as $L_{k+2}(\mathfrak{sl}_2) \otimes \text{Vir}(u,w) \otimes \text{Vir}(u,v)$ -module. In other words

$$\mathcal{A}_{u,v,w} \cong \text{Com}(L_{k+2}(\mathfrak{sl}_2), \mathcal{F}(4) \otimes L_k(\mathfrak{sl}_2)) =: C_k$$

as $\text{Vir}(u, w) \otimes \text{Vir}(u, v)$ -modules. Cosets of this type are simple [ACKL, Corollary 2.2] since $L_{k+2}(\mathfrak{sl}_2)$ is rational. Simplicity also follows without using rationality from [Li1, Ca] since all three vertex operator superalgebras involved have positive energy and unique vacuum, since the weight-1 space of each is in the kernel of the Virasoro mode $L(1)$, and since the unique non-degenerate supersymmetric invariant bilinear form on $\mathcal{F}(4) \otimes L(k\omega_0)$ restricts to a non-degenerate supersymmetric invariant bilinear form on $L_{k+2}(\mathfrak{sl}_2) \otimes C_k$. See the following remark for a discussion of this issue. \square

Remark 4.11. In many cases, simplicity of a vertex operator algebra is equivalent to existence of a non-degenerate symmetric invariant bilinear form. A precise statement is:

Let $V = \bigoplus_{n \in \mathbb{Z}} V_n$ be a vertex operator algebra such that $V_n = 0$ for $n < 0$ (positive energy) and $V_0 = \mathbb{C}1$ (unique vacuum) and $L(1)V_1 = 0$. Then there is a unique (up to scale) symmetric invariant bilinear form B_V on V [Li1, Theorem 3.1]. Let $I \subsetneq V$ be an ideal; then $I \cap V_0 = \{0\}$ and thus by [Li1, Equation 3.1],

$$B_V(u, v) = 0 \quad \text{for all } u \in I, v \in V.$$

In other words, this bilinear form is non-degenerate if and only if V is simple.

Let V now be a vertex operator superalgebra which is an order-two simple current extension of its even vertex operator subalgebra $V^{\bar{0}}$. That is, the odd part $V^{\bar{1}}$ of V is a self-dual simple current. Assume that $V^{\bar{0}}$ satisfies the same conditions as V above, so that $V^{\bar{0}}$ is simple if and only if the unique invariant symmetric bilinear form on $V^{\bar{0}}$ is non-degenerate. This induces a supersymmetric invariant bilinear form on $V = V^{\bar{0}} \oplus V^{\bar{1}}$ by [Ca, Lemma 3.2.5] and the same argument as above carries over so that this induced bilinear form is non-degenerate if and only if V is simple.

The well-known fusion rules of the Virasoro minimal models allow us to induce $W_{1,s}^{(u,v)} \otimes W_{1,t}^{(u,w)}$. Call A the superalgebra object corresponding to either C_k or $\mathcal{A}_{u;v,w}$.

Corollary 4.12. $\mathcal{F}(W_{1,s}^{(u,v)} \otimes W_{1,t}^{(u,w)})$ is in $\text{Rep}^0 A$ if and only if $s + t \in 2\mathbb{Z}$.

Proof. We know from Lemma 2.65 that a module W induces to a $\text{Rep}^0 A$ -object if and only if the monodromy $\mathcal{M}_{A,W} = 1_{A \boxtimes W}$. Now, using Virasoro fusion rules,

$$(W_{i,1}^{(u,v)} \otimes W_{i,1}^{(u,w)}) \boxtimes (W_{1,s}^{(u,v)} \otimes W_{1,t}^{(u,w)}) = (W_{i,1}^{(u,v)} \boxtimes W_{1,s}^{(u,v)}) \otimes (W_{i,1}^{(u,w)} \boxtimes W_{1,t}^{(u,w)}) = W_{i,s}^{(u,v)} \otimes W_{i,t}^{(u,w)}.$$

Using balancing and conformal dimensions, $\mathcal{M}_{A,W} = 1_{A \boxtimes W}$ if and only if $h_{i,1}^{(u,v)} + h_{i,1}^{(u,w)} + h_{1,s}^{(u,v)} + h_{1,t}^{(u,w)} - h_{i,s}^{(u,v)} - h_{i,t}^{(u,w)} \in \mathbb{Z}$, for all i . This in turn happens if and only if $(i-1)(s+t)/2 \in \mathbb{Z}$ for all i . \square

There are also extensions of E_6 and E_8 type:

Corollary 4.13. Let $u = 11$, $v = 10$, and $w = 12$, that is, $k + 2 = 10$; then

$$C_k \oplus \mathcal{F}(W_{1,1}^{(u,v)} \otimes W_{1,7}^{(u,w)})$$

is a vertex operator superalgebra extension of C_k .

Let $u = 29$, $v = 28$, and $w = 30$, that is, $k + 2 = 28$; then

$$C_k \oplus \mathcal{F}(W_{1,1}^{(u,v)} \otimes W_{1,11}^{(u,w)}) \oplus \mathcal{F}(W_{1,1}^{(u,v)} \otimes W_{1,19}^{(u,w)}) \oplus \mathcal{F}(W_{1,1}^{(u,v)} \otimes W_{1,29}^{(u,w)})$$

is a vertex operator superalgebra extension of C_k .

Proof. The well-known type E_6 , respectively E_8 , extensions of $L_{10}(\mathfrak{sl}_2)$ and $L_{28}(\mathfrak{sl}_2)$ are given by [KO, Example 5.3]:

$$L_{10}(\mathfrak{sl}_2) \oplus L(4\omega_0 + 6\omega_1), \quad \text{respectively} \quad L_{28}(\mathfrak{sl}_2) \oplus L(18\omega_0 + 10\omega_1) \oplus L(10\omega_0 + 18\omega_1) \oplus L(28\omega_1).$$

The corresponding statement for the even vertex operator subalgebra of C_k then follows by mirror extension for rational vertex operator algebras [Lin, CKM]. The odd part of C_k is a simple current of order two for the even vertex operator subalgebra of C_k . It induces to a simple current of the extension of the even vertex operator subalgebra of C_k and the corresponding simple current extensions are the claimed vertex operator superalgebra extensions of C_k . \square

Another extension of $L_k(\mathfrak{sl}_2)$ is the following. Let $k = -2 + \frac{1}{p}$ for a positive integer p . This is not an admissible level for \mathfrak{sl}_2 and in that instance $L_k(\mathfrak{sl}_2)$ has a simple vertex operator algebra extension [Cr1]

$$\mathcal{Y}_p = \bigoplus_{m=0}^{\infty} (2m+1)L((k-2m)\omega_0 + 2m\omega_1).$$

In fact the group $SU(2)$ acts via automorphisms and

$$\mathcal{Y}_p \cong \bigoplus_{m=0}^{\infty} \rho_{2m\omega_1} \otimes L((k-2m)\omega_0 + 2m\omega_1).$$

as $SU(2) \otimes L_k(\mathfrak{sl}_2)$ -module [ACGY]. It is an interesting question to identify and understand the Virasoro vertex operator algebra extension $\text{Com}(V_{k+1}(\mathfrak{sl}_2), L_1(\mathfrak{sl}_2) \otimes \mathcal{Y}_p)$. A natural expectation is that this coset is closely related to the triplet algebra $\mathcal{W}(p+1)$.

Remark 4.14. Another interesting observation is that $L_{k+2}(\mathfrak{sl}_2) \subseteq L_k(\mathfrak{sl}_2) \otimes \mathcal{F}(3)$ so that $\mathcal{F}(1) \subseteq C_k$. Let $D_k = \text{Com}(\mathcal{F}(1), C_k)$. Then [CL2, Example 7.8] suggests that the even vertex operator subalgebra of D_k is strongly generated by three fields of conformal dimension 2, 4, and 6. There are two known families of vertex algebras of this type, namely the principal W -algebra of type B_3 and the \mathbb{Z}_2 -orbifold of the $N = 1$ super Virasoro algebra and indeed this coset coincides with the simple \mathbb{Z}_2 -orbifold of the $N = 1$ super Virasoro algebra at corresponding central charge [CFL, Remark 5.3].

4.2 Verlinde formulae

One of the high points of the theory of regular vertex operator algebras is the Verlinde formula, conjectured by Verlinde [Ve] and proven by Huang [Hu6], for the fusion rules of the vertex operator algebra in terms of the modular S -matrix. We start by recalling this formula:

Let V be a regular vertex operator algebra, X a V -module, and $[\text{Rep } V]$ the set of equivalence classes of simple V -modules. The modular S -matrix is defined by the modular S -transformation of torus one-point functions. For this let $L(0)$ be the Virasoro zero-mode of V and c the central charge; then the character of X is defined to be the graded trace

$$\text{ch}[X](\tau, v) := \text{tr}_X \left(q^{L(0) - \frac{c}{24}} o(v) \right), \quad q = e^{2\pi i \tau},$$

for $v \in V$ and $o(v)$ the zero-mode of the corresponding vertex operator. Including zero-modes $o(v)$ ensures that characters of inequivalent simple V -modules are linearly independent. Thus the \mathbb{C} -linear span of characters is isomorphic to the vector space $\mathbb{C}[\text{Rep } V]$ whose basis elements are labeled by the elements of $[\text{Rep } V]$. We fix one representative of each equivalence class. Abusing notation slightly, we denote this set of representatives by $[\text{Rep } V]$ as well. Then Möbius transformations on the linear span of characters define an action of $\text{SL}(2, \mathbb{Z})$. If $v \in V$ has conformal weight $\text{wt}[v]$ with respect to Zhu's modified vertex operator algebra structure on V [Zh], the modular S -transformation has the form

$$\text{ch}[X] \left(-\frac{1}{\tau}, v \right) = \tau^{\text{wt}[v]} \sum_{Y \in [\text{Rep } V]} S_{X,Y} \text{ch}[Y](\tau, v). \quad (4.2)$$

Recall that the fusion rules are defined as the dimensions of spaces of intertwining operators. Verlinde's formula for \mathbb{Z} -graded vertex operator algebras is then

$$N_{X,Y}^W = \sum_{Z \in [\text{Rep } V]} \frac{S_{X,Z} \cdot S_{Y,Z} \cdot (S^{-1})_{Z,W}}{S_{V,Z}}, \quad (4.3)$$

and the fusion product satisfies

$$X \boxtimes_V Y \cong \bigoplus_{W \in [\text{Rep } V]} N_{X,Y}^W \cdot W.$$

In this subsection, we will get Verlinde formulae for regular vertex operator superalgebras of correct and wrong boson-fermion statistics, as well as for regular vertex operator algebras with wrong statistics. The main idea is to use the induction functor to show and then exploit the correspondence between simple modules for V and for $A = V \oplus J$, where A is a simple current extension of order 2.

4.2.1 Preliminaries

We begin by discussing the notions of simplicity of objects in $\text{Rep } A$ and $\underline{\text{Rep}} A$. Recall from Proposition 2.14 that \mathcal{SC} is abelian and from Remark 2.31 that $\text{Rep } A$ is not necessarily abelian (although its underlying category $\underline{\text{Rep}} A$ is abelian). For this reason, some care is needed in dealing with the notion of simple object in $\text{Rep } A$. It is useful to define simplicity in $\text{Rep } A$ and $\underline{\text{Rep}} A$ in terms of submodules:

Definition 4.15. An A -submodule of an object (X, μ_X) in $\text{Rep } A$ is an object W of \mathcal{SC} together with an injection $h : W \rightarrow X$ such that $\text{Im}(\mu_X \circ (1_A \boxtimes h)) \subseteq \text{Im}(h)$. We say that two A -submodules (W, h) and $(\widetilde{W}, \widetilde{h})$ are *equivalent* if there is an \mathcal{SC} -isomorphism $k : W \rightarrow \widetilde{W}$ such that $\widetilde{h} \circ k = h$.

Remark 4.16. For a vertex operator superalgebra extension $V \subseteq A$ with V contained in the even part of A , an equivalence class of A -submodules of an object (X, μ_X) in $\text{Rep } A$ amounts to a not-necessarily- $\mathbb{Z}/2\mathbb{Z}$ -graded subspace of X that is closed under the vertex operator Y_X for A acting on X .

Definition 4.17. Suppose A is a vertex operator superalgebra extension of V such that $V \subseteq A^{\bar{0}}$. An object (X, μ_X) is *simple* as an object of $\text{Rep } A$, respectively as an object of $\underline{\text{Rep}} A$, if 0 and X are the only A -submodules, respectively the only $\mathbb{Z}/2\mathbb{Z}$ -graded A -submodules, of X up to equivalence.

Recall that sometimes an object in a category is defined to be simple if all its endomorphisms are scalar multiples of the identity. This notion of simplicity is equivalent to Definition 4.17 if $\underline{\text{Rep}} A$ is semisimple, that is, if every object of $\underline{\text{Rep}} A$ is a direct sum of finitely many simple objects in the sense of Definition 4.17:

Proposition 4.18. *Suppose A is a vertex operator superalgebra extension of V such that $V \subseteq A^{\bar{0}}$. If (X, μ_X) is simple as an object of $\text{Rep } A$, respectively as an object of $\underline{\text{Rep}} A$, then $\text{End}_{\text{Rep } A}(X) = \mathbb{C}1_X$, respectively $\text{End}_{\underline{\text{Rep}} A}(X) = \mathbb{C}1_X$. The converse holds if $\underline{\text{Rep}} A$ is semisimple.*

Proof. Suppose (X, μ_X) is simple as an object of $\underline{\text{Rep}} A$ and $f \in \text{End}_{\underline{\text{Rep}} A}(X)$. Since f preserves the finite-dimensional weight spaces of X , f has an eigenvalue λ . Since f is even, the corresponding eigenspace X_λ is a non-zero $\mathbb{Z}/2\mathbb{Z}$ -graded A -submodule of X . Since X is a simple object of $\underline{\text{Rep}} A$, $X_\lambda = X$ and $f = \lambda 1_X$.

Now suppose (X, μ_X) is simple as an object of $\text{Rep } A$ and $f \in \text{End}_{\text{Rep } A}(X)$ with parity decomposition $f = f^{\bar{0}} + f^{\bar{1}}$. Both $f^{\bar{0}}$ and $f^{\bar{1}}$ are $\text{Rep } A$ -endomorphisms of X ; we need to show that $f^{\bar{0}}$ is a scalar multiple of 1_X and $f^{\bar{1}} = 0$. Now, $f^{\bar{0}}$ is a scalar multiple of 1_X by the argument of the previous paragraph. As for $f^{\bar{1}}$, suppose λ is an eigenvalue of $f^{\bar{1}}$, which exists because $f^{\bar{1}}$ preserves the finite-dimensional weight spaces of X due to the evenness of $L(0)$, and let X_λ be the corresponding eigenspace. We claim that

$$W = \{w + iP_X(w) \mid w \in X_\lambda\}$$

is an A -submodule of X , where P_X is the parity involution of X . Indeed, for $a \in A$ with parity decomposition $a = a^{\bar{0}} + a^{\bar{1}}$, we have

$$\begin{aligned} Y_X(a, x)(w + iP_X(w)) &= \left(Y_X(a^{\bar{0}}, x)w + iY_X(a^{\bar{1}}, x)P_X(w) \right) + \left(iY_X(a^{\bar{0}}, x)P_X(w) + Y_X(a^{\bar{1}}, x)w \right) \\ &= \left(Y_X(a^{\bar{0}}, x)w + iY_X(a^{\bar{1}}, x)P_X(w) \right) + iP_X \left(Y_X(a^{\bar{0}}, x)w - iP_X(Y_X(a^{\bar{1}}, x)w) \right) \\ &= \left(Y_X(a^{\bar{0}}, x)w + iY_X(a^{\bar{1}}, x)P_X(w) \right) + iP_X \left(Y_X(a^{\bar{0}}, x)w + iY_X(a^{\bar{1}}, x)P_X(w) \right) \end{aligned}$$

for $w \in X_\lambda$, and the coefficients of powers of x and $\log x$ in $Y_X(a^{\bar{0}}, x)w + iY_X(a^{\bar{1}}, x)P_X(w)$ lie in X_λ because

$$\begin{aligned} f^{\bar{1}} \left(Y_X(a^{\bar{0}}, x)w + iY_X(a^{\bar{1}}, x)P_X(w) \right) &= Y_X(a^{\bar{0}}, x)f^{\bar{1}}(w) - iY_X(a^{\bar{1}}, x)(f^{\bar{1}} \circ P_X)(w) \\ &= Y_X(a^{\bar{0}}, x)f^{\bar{1}}(w) + iY_X(a^{\bar{1}}, x)(P_X \circ f^{\bar{1}})(w) \\ &= \lambda \left(Y_X(a^{\bar{0}}, x)w + iY_X(a^{\bar{1}}, x)P_X(w) \right). \end{aligned}$$

Because X is simple as an object of $\text{Rep } A$, either $W = 0$ or $W = X$. If $W = 0$, then $w = -iP_X(w)$ for all $w \in X_\lambda$, so that $X_\lambda = P_X(X_\lambda)$. If on the other hand $W = X$, then for any non-zero $w \in X_\lambda$, there is some non-zero $w' \in X_\lambda$ such that $w = w' + iP_X(w')$; thus $P_X(w') = -i(w - w')$ and $X_\lambda \cap P_X(X_\lambda) \neq 0$. Either way, $X_\lambda \cap P_X(X_\lambda) \neq 0$; but it is easy to see that $P_X(X_\lambda)$ is the eigenspace of $f^{\bar{1}}$ with eigenvalue $-\lambda$. Thus we must have $\lambda = 0$. In particular, $\text{Ker } f^{\bar{1}}$ is non-zero; $\text{Ker } f^{\bar{1}}$ is also an A -submodule because $f^{\bar{1}}$ is parity-homogeneous. Thus since X is simple, $\text{Ker } f^{\bar{1}} = X$ and $f^{\bar{1}} = 0$, as desired.

For the converse, assume $\underline{\text{Rep}} A$ is semisimple. If (X, μ_X) is an object of $\text{Rep } A$ such that $\text{End}_{\underline{\text{Rep}} A} = \mathbb{C}1_X$, suppose that W is a $\mathbb{Z}/2\mathbb{Z}$ -graded A -submodule of X . Then because $\underline{\text{Rep}} A$ is semisimple (with simple objects defined as in Definition 4.17), there is a $\mathbb{Z}/2\mathbb{Z}$ -graded A -submodule \widetilde{W} of X such that $X = W \oplus \widetilde{W}$. Then the projection $q_W \circ p_W$ with respect to this direct sum decomposition is a $\underline{\text{Rep}} A$ -endomorphism of X , which must be a scalar multiple of 1_X . This can only happen if $W = 0$ or $W = X$, so X is simple as an object of $\underline{\text{Rep}} A$.

Now suppose $\text{End}_{\text{Rep } A} = \mathbb{C}1_X$, and suppose $W \subseteq X$ is an A -submodule. It is easy to see that $P_X(W)$ is also an A -submodule. Now, the A -submodules $W + P_X(W)$ and $W \cap P_X(W)$ are P_X -stable, which means that they are $\mathbb{Z}/2\mathbb{Z}$ -graded. Since by assumption $\text{End}_{\text{Rep } A} = \mathbb{C}1_X = \text{End}_{\text{Rep } A}(X)$, the previous paragraph shows that X is simple in Rep A . Thus $X + P_X(W)$ and $W \cap P_X(W)$ are both either 0 or X . If $W + P_X(W) = 0$, then $W = 0$. If on the other hand $W \cap P_X(W) = X$, then $W = X$. The other possibility is $W + P_X(W) = X$ and $W \cap P_X(W) = 0$. In this case, $X = W \oplus P_X(W)$ as an object of $\text{Rep } A$ with neither W nor $P_X(W)$ equal to 0. But this is a contradiction since then projection onto either W or $P_X(W)$ is a non-scalar $\text{Rep } A$ -endomorphism of X . Thus either $W = 0$ or $W = X$, and X is simple as an object of $\text{Rep } A$. \square

It is clear that simplicity in $\text{Rep } A$ is a stronger condition than simplicity in Rep A . The next two propositions, which are independent of the statistics of A , characterize the discrepancy between these two conditions; they can be proved similarly to [Wal, Yal], but we reproduce the proofs for completeness.

Proposition 4.19. *Suppose A is a vertex operator superalgebra extension of V such that $V \subseteq A^{\bar{0}}$, and suppose $X = X^{\bar{0}} \oplus X^{\bar{1}}$ is a simple object of Rep A . Then either X is simple as an object of $\text{Rep } A$ or there exist an $A^{\bar{0}}$ -isomorphism $\varphi : X^{\bar{0}} \xrightarrow{\sim} X^{\bar{1}}$ and A -submodules $W_{\pm} \subseteq X$ such that*

$$\begin{aligned} X &= W_+ \oplus W_- \quad \text{as } A^{\bar{0}}\text{-modules, and hence as } V\text{-modules,} \\ W_{\pm} &= \{x^{\bar{0}} \pm \varphi(x^{\bar{0}}) \mid x^{\bar{0}} \in X^{\bar{0}}\}, \\ X^{\bar{0}} &\cong X^{\bar{1}} \cong W_+ \cong W_- \quad \text{as } A^{\bar{0}}\text{-modules, and hence as } V\text{-modules.} \end{aligned} \tag{4.4}$$

Proof. We may assume X is not simple as an object of $\text{Rep } A$ so that there is a non-zero, proper A -submodule $W_+ \subseteq X$. As in the proof of the preceding proposition, $W_- = P_X(W_+)$ is an A -submodule, and $W_+ + W_-$ and $W_+ \cap W_-$ are $\mathbb{Z}/2\mathbb{Z}$ -graded A -submodules. Since X is simple as an object of Rep A , we have $W_+ + W_- = X$ and $W_+ \cap W_- = 0$, so that $X = W_+ \oplus W_-$ as V -modules.

Now any $x^{\bar{0}} \in X^{\bar{0}}$ can be written uniquely as $x^{\bar{0}} = w_+ + w_-$ for some $w_{\pm} \in W_{\pm}$. Since $P_X(x^{\bar{0}}) = x^{\bar{0}}$, the uniqueness implies that $w_- = P_X(w_+)$ and so $x^{\bar{0}} = w_+ + P_X(w_+) = 2w_+$. Similarly, any $x^{\bar{1}} \in X^{\bar{1}}$ can be written uniquely as $x^{\bar{1}} = w_+ - P_X(w_+) = 2w_+$. Therefore, there is a unique linear isomorphism $\varphi : X^{\bar{0}} \xrightarrow{\sim} X^{\bar{1}}$ satisfying

$$x^{\bar{0}} + \varphi(x^{\bar{0}}) \in W_+ \tag{4.5}$$

given by $\varphi(w_+) = w_+$; that is, φ maps $x^{\bar{0}} = w_+ + P_X(w_+)$ to $x^{\bar{1}} = w_+ - P_X(w_+)$. It is now clear that (4.4) is satisfied. We just need to prove that φ is a morphism of $A^{\bar{0}}$ -modules. Since $x^{\bar{0}} + \varphi(x^{\bar{0}}) \in W_+$,

$$\begin{aligned} Y_X(a^{\bar{0}}, x)(x^{\bar{0}} + \varphi(x^{\bar{0}})) &= Y_X(a^{\bar{0}}, x)x^{\bar{0}} + Y_X(a^{\bar{0}}, x)\varphi(x^{\bar{0}}) \in W_+[\log x]\{x\}, \\ Y_X(a^{\bar{0}}, x)x^{\bar{0}} &\in X^{\bar{0}}[\log x]\{x\}, \quad Y_X(a^{\bar{0}}, x)\varphi(x^{\bar{0}}) \in X^{\bar{1}}[\log x]\{x\}. \end{aligned}$$

for any $a^{\bar{0}} \in A^{\bar{0}}$. These parity considerations together with (4.5) now show that

$$\varphi(Y_X(a^{\bar{0}}, x)x^{\bar{0}}) = Y_X(a^{\bar{0}}, x)\varphi(x^{\bar{0}}). \tag{4.6}$$

Now the last assertion of (4.4) is clear. \square

Proposition 4.20. *Suppose A is a vertex operator superalgebra extension of V such that $V \subseteq A^{\bar{0}}$. Then A is simple as an object of $\text{Rep } A$ if and only if it is simple as an object of Rep A .*

Proof. We only need to prove the “if” direction as the “only if” direction is clear. Assume towards a contradiction that A is simple in Rep A but not in $\text{Rep } A$. Let $\varphi : A^{\bar{0}} \rightarrow A^{\bar{1}}$ be the $A^{\bar{0}}$ -isomorphism of Proposition 4.19. Then for any $a^{\bar{0}}, b^{\bar{0}} \in A^{\bar{0}}$, $a^{\bar{1}} \in A^{\bar{1}}$, the first equation below is (4.6) and the second follows similarly:

$$\varphi(Y(a^{\bar{0}}, x)b^{\bar{0}}) = Y(a^{\bar{0}}, x)\varphi(b^{\bar{0}}), \tag{4.7}$$

$$\varphi(Y(a^{\bar{1}}, x)\varphi(b^{\bar{0}})) = Y(a^{\bar{1}}, x)b^{\bar{0}}. \tag{4.8}$$

Now we get

$$\begin{aligned} \varphi(Y(\varphi(a^{\bar{0}}), x)\varphi(b^{\bar{0}})) &= Y(\varphi(a^{\bar{0}}), x)b^{\bar{0}} = e^{xL(-1)}Y(b^{\bar{0}}, -x)\varphi(a^{\bar{0}}) = e^{xL(-1)}\varphi(Y(b^{\bar{0}}, -x)a^{\bar{0}}) \\ &= \varphi(e^{xL(-1)}Y(b^{\bar{0}}, -x)a^{\bar{0}}) = \varphi(Y(a^{\bar{0}}, x)b^{\bar{0}}), \end{aligned}$$

which implies

$$Y(\varphi(a^{\bar{0}}), x)\varphi(b^{\bar{0}}) = Y(a^{\bar{0}}, x)b^{\bar{0}}$$

since φ is an isomorphism. However, parity considerations show

$$Y(\varphi(a^{\bar{0}}), x)\varphi(b^{\bar{0}}) = -e^{xL(-1)}Y(\varphi(b^{\bar{0}}), -x)\varphi(a^{\bar{0}}) = -e^{xL(-1)}Y(b^{\bar{0}}, -x)a^{\bar{0}} = -Y(a^{\bar{0}}, x)b^{\bar{0}},$$

implying that $Y(a^{\bar{0}}, x)b^{\bar{0}}$ is identically 0, contradicting the properties of the vacuum. \square

In light of the previous proposition, we omit specifying the category when we say that a vertex operator superalgebra extension is simple.

Remark 4.21. For Propositions 4.18, 4.19, and 4.20, we do not need to assume that A is an object of a vertex tensor category of V -modules, since the categories $\text{Rep } A$ and $\underline{\text{Rep}} A$ can be defined using Proposition 3.46. We just need to assume the convergence of the relevant compositions of V -intertwining operators.

Proposition 4.22. *Suppose $A = V \oplus J$ is a simple vertex operator superalgebra and A is an object in a vertex tensor category \mathcal{C} of V -modules. Then V is simple and J is a simple current for $V = A^{\bar{0}}$. Moreover, if $X = X^{\bar{0}} \oplus X^{\bar{1}}$ is simple in $\underline{\text{Rep}} A$ then $X^{\bar{0}}$ is simple as a V -module and $X^{\bar{1}} \cong J \boxtimes X^{\bar{0}}$.*

Proof. The conclusions that V is simple and J is a simple current follow from variants of [DM2] and [Miy, CaM]. The simplicity of V and J is also a special case of the last conclusion of the proposition. For the simple current property of J , see also [CKLR, Theorem 3.1 and Appendix A].

Now, if $W^{\bar{0}}$ is a proper V -submodule of $X^{\bar{0}}$, then

$$W^{\bar{0}} \oplus \text{Span}\{j_{n;k}w \mid j \in A^{\bar{1}} = J, n \in \mathbb{R}, k \in \mathbb{N}, w \in W^{\bar{0}}\}$$

is a proper $\mathbb{Z}/2\mathbb{Z}$ -graded A -submodule of X by Lemma 3.74. Since X is simple in $\underline{\text{Rep}} A$, this means $W^{\bar{0}} = 0$ and $X^{\bar{0}}$ is a simple V -module. Similarly, $X^{\bar{1}}$ is a simple V -module.

Next, to show that $X^{\bar{1}} \cong J \boxtimes X^{\bar{0}}$, we may assume that X is non-zero. We claim that

$$\text{Span}\{j_{n;k}x^{\bar{0}} \mid j \in J, n \in \mathbb{R}, k \in \mathbb{N}, x^{\bar{0}} \in X^{\bar{0}}\}$$

is non-zero. Indeed, if not, then $J \subseteq \text{Ann}_A(X^{\bar{0}})$, and this ideal (recall Lemma 3.73) is then A since A is simple. In particular, $\mathbf{1} \in \text{Ann}_A(X^{\bar{0}})$ implies $X^{\bar{0}} = 0$. Then since $j_{n;k}x^{\bar{1}} \in X^{\bar{0}}$ for $j \in J, n \in \mathbb{R}, k \in \mathbb{N}$, and $x^{\bar{1}} \in X^{\bar{1}}$, the same argument shows $\text{Ann}_A(X^{\bar{1}}) = A$ and $X^{\bar{1}} = 0$. This contradicts $X \neq 0$, proving the claim. Now the V -intertwining operator $Y_X|_{J \boxtimes X^{\bar{0}}}$ induces a non-zero homomorphism $J \boxtimes X^{\bar{0}} \rightarrow X^{\bar{1}}$. Since J is a simple current and $X^{\bar{0}}, X^{\bar{1}}$ are simple, we have $J \boxtimes X^{\bar{0}} \cong X^{\bar{1}}$ by Schur's Lemma. \square

Corollary 4.23. *Suppose $A = V \oplus J$ is a simple vertex operator superalgebra and A is an object in a vertex tensor category \mathcal{C} of V -modules. If $X = X^{\bar{0}} \oplus X^{\bar{1}}$ is simple in $\underline{\text{Rep}} A$, then $X \cong \mathcal{F}(X^{\bar{0}})$ in $\text{Rep } A$.*

Proof. The preceding proposition and its proof show that

$$\mu_X|_{A \boxtimes X^{\bar{0}}} = \mu_X \circ (1_A \boxtimes q_{X^{\bar{0}}}) : \mathcal{F}(X^{\bar{0}}) = (V \boxtimes X^{\bar{0}}) \oplus (J \boxtimes X^{\bar{0}}) \rightarrow X = X^{\bar{0}} \oplus X^{\bar{1}}$$

is a V -module isomorphism. But it is easy to see from the associativity of μ_X that $\mu_X|_{A \boxtimes X^{\bar{0}}}$ is a morphism in $\text{Rep } A$. Thus it is an isomorphism in $\text{Rep } A$. \square

In the other direction, we can exploit the $\mathbb{Z}/2\mathbb{Z}$ grading to conclude that simple objects induce to simple objects, provided $\underline{\text{Rep}} A$ is semisimple:

Corollary 4.24. *Suppose $A = V \oplus J$ is a simple vertex operator superalgebra such that A is an object in a vertex tensor category \mathcal{C} of V -modules and $\underline{\text{Rep}} A$ is semisimple. Then simple modules $X^{\bar{0}}$ in SC induce to simple modules in $\underline{\text{Rep}} A$.*

Proof. Since $\underline{\text{Rep}} A$ is semisimple, it is enough to show that if $W = W^{\bar{0}} \oplus W^{\bar{1}}$ is a non-zero $\underline{\text{Rep}} A$ -simple A -submodule, then $W = \mathcal{F}(X^{\bar{0}}) = X^{\bar{0}} \oplus (J \boxtimes X^{\bar{0}})$. Since $X^{\bar{0}}$ is simple and J is a simple current by Proposition 4.22, $J \boxtimes X^{\bar{0}}$ is simple as well. Thus it is enough to show that $W^{\bar{0}}$ and $W^{\bar{1}}$ are both non-zero. Since W is simple in $\underline{\text{Rep}} A$, Proposition 4.22 implies $W^{\bar{0}} = 0$ if and only if $W^{\bar{1}} \cong J \boxtimes W^{\bar{0}} = 0$ as well. Therefore since W is non-zero, the conclusion follows. \square

We shall show below that if A has wrong statistics, that is, if A is \mathbb{Z} -graded, then every simple object of $\text{Rep } A$ is also simple in $\text{Rep } A$. Thus to derive Verlinde formulae in these cases, we can enumerate simple objects using either definition of simplicity. For vertex operator superalgebras of correct statistics, however, we shall need to work with simple objects in [Rep \$A\$](#) .

Notation 4.25. Henceforth, in this subsection on Verlinde formulae, \mathcal{C} will be a modular tensor category of modules for a regular vertex operator algebra V . In particular, we have the modular S -matrix S^X arising from characters of irreducible V -modules and the categorical S -matrix S^∞ arising from traces of monodromies for irreducible V -modules. The two S -matrices are equal up to a non-zero constant depending solely on \mathcal{C} . Therefore, the lemmas in this section will be deduced for S^∞ but will hold, with suitable modifications, for S^X as well. Thus for this section, we drop the superscripts and use just S .

Unlike in previous sections where we used W_i to denote modules for various vertex operator algebras, here for simplicity of notation we shall use capital letters U, W, X, \dots to denote modules.

We shall fix a simple (super)algebra A in \mathcal{C} that is an extension of V by a simple current J of order 2. We shall assume that $\mathcal{M}_{J,J} = 1_V$. We denote $\text{qdim}(J) = d$; note that $d = \pm 1$. We denote the set of isomorphism classes of simple objects in \mathcal{C} by \mathcal{S} . For a simple object $X \in \mathcal{S}$, we define ϵ_X via $\mathcal{M}_{X,J} = \epsilon_X 1_{X \boxtimes J}$. Since $J \boxtimes J \cong V$, $\epsilon_X = \pm 1$ for any simple object $X \in \mathcal{S}$ [CKL]. Since $\mathcal{M}_{J,J} = 1_V$, it is clear that $\epsilon_{X \boxtimes J} = \epsilon_X$ [CKL].

We note a general lemma which we shall use below.

Lemma 4.26. *Let \mathcal{C} be a modular tensor category with unit object $\mathbf{1}$ and let J be a simple current with $\text{qdim}(J) = d$. For a simple object X , define ϵ_X by $\mathcal{M}_{X,J} = \epsilon_X 1_{X \boxtimes J}$. Then for any simple objects W, X and $i, j, t \in \mathbb{N}$,*

$$(S^{\pm 1})_{W \boxtimes J^t, X} = (\epsilon_X d)^{\pm t} (S^{\pm 1})_{W, X}. \quad (4.9)$$

In particular, if J has order 2 and $\mathcal{M}_{J,J} = \mathbf{1}$ then $d, \epsilon_W, \epsilon_X = \pm 1$ and

$$(S^{\pm 1})_{W \boxtimes J^i, X \boxtimes J^j} = d^{i+j} (\epsilon_W^i \epsilon_X^j) (S^{\pm 1})_{W, X}. \quad (4.10)$$

Proof. First we have the identity

$$S_{J,X} = \text{Tr}(\mathcal{M}_{J,X}) = \epsilon_X S_{\mathbf{1}, J \boxtimes X} = \epsilon_X \frac{S_{\mathbf{1}, J} S_{\mathbf{1}, X}}{S_{\mathbf{1}, \mathbf{1}}} = \epsilon_X d S_{\mathbf{1}, X}.$$

Note from [BK] that in ribbon categories, $(W \boxtimes J)^* \cong J^* \boxtimes X^*$, where $*$ denotes the dual. Also, $(S^{-1})_{X,W} = \alpha S_{X,W^*}$, where α is a global non-zero constant depending only on \mathcal{C} ; this follows from formulas (3.2.d) and (3.2.h) in [Tu1]. Therefore, for simple objects $W, X \in \mathcal{S}$,

$$\begin{aligned} (S^{-1})_{W \boxtimes J^t, X} &= (S^{-1})_{X, W \boxtimes J^t} = \alpha S_{X, (W \boxtimes J^t)^*} = \alpha S_{X, J^{-t} \boxtimes W^*} = \alpha \left(\frac{S_{X, J^{-1}}}{S_{X, \mathbf{1}}} \right)^t S_{X, W^*} \\ &= \alpha \left(\frac{S_{X, J}}{S_{X, \mathbf{1}}} \right)^{-t} S_{X, W^*} = \alpha (\epsilon_X d)^{-t} S_{X, W^*} = (\epsilon_X d)^{-t} (S^{-1})_{X, W} = (\epsilon_X d)^{-t} (S^{-1})_{W, X}. \end{aligned}$$

The other case is

$$S_{W \boxtimes J^t, X} = S_{\mathbf{1}, X} \frac{S_{W \boxtimes J^t, X}}{S_{\mathbf{1}, X}} = S_{\mathbf{1}, X} \frac{S_{W, X}}{S_{\mathbf{1}, X}} \left(\frac{S_{J, X}}{S_{\mathbf{1}, X}} \right)^t = S_{W, X} (\epsilon_X d)^t.$$

□

4.2.2 Superalgebras with wrong statistics

Here we assume that $A = V \oplus J$ is a simple, regular vertex operator superalgebra such that $J \boxtimes J \cong V$, $\theta_A = 1_A$, $\text{qdim}(J) = d = -1$ and $\mathcal{M}_{J,J} = 1_V$. Examples include affine Lie superalgebra vertex operator superalgebras, viewed as superalgebras in the representation categories of their even subalgebras, provided the even subalgebra is regular. Since A is a superalgebra, every object in $\text{Rep } A$ by definition has a $\mathbb{Z}/2\mathbb{Z}$ -grading. In the following lemma, we collect basic facts regarding simple objects in $\text{Rep } A$, most of which are specializations of previous results:

Lemma 4.27. *We have the following:*

1. For every simple object $X \in \mathcal{S}$, $J \boxtimes X \not\cong X$.

2. For every simple object $X = X^{\bar{0}} \oplus X^{\bar{1}}$ in $\underline{\text{Rep}} A$, $X^{\bar{0}}$ and $X^{\bar{1}}$ are simple in \mathcal{C} , and moreover, $X \cong \mathcal{F}(X^{\bar{0}})$, that is, $X^{\bar{1}} \cong J \boxtimes X^{\bar{0}}$.
3. If X is simple in $\underline{\text{Rep}} A$ then X is simple in $\text{Rep} A$.
4. Given a simple object $X^{\bar{0}} \in \mathcal{S}$, $\mathcal{F}(X^{\bar{0}})$ is simple in $\text{Rep} A$.
5. Given a simple object $X = X^{\bar{0}} \oplus X^{\bar{1}}$ in $\text{Rep} A$, X is an object in $\text{Rep}^0 A$ if and only if $\epsilon_{X^{\bar{0}}} = 1$.
6. Given a simple object $X = X^{\bar{0}} \oplus X^{\bar{1}}$ in $\text{Rep} A$, we have $S_{J, X^{\bar{0}}}^{\infty} = -\epsilon_{X^{\bar{0}}} \text{qdim}(X^{\bar{0}})$.
7. Given simple objects $X = X^{\bar{0}} \oplus X^{\bar{1}}$, $W = W^{\bar{0}} \oplus W^{\bar{1}}$ in $\text{Rep} A$ and $i, j \in \mathbb{Z}/2\mathbb{Z}$, we have $(S^{\pm 1})_{X^i, W^j} = (-1)^{i+j} \epsilon_{X^{\bar{0}}}^j \epsilon_{W^{\bar{0}}}^i (S^{\pm 1})_{X^{\bar{0}}, W^{\bar{0}}}$.

Proof. For (1), the categorical dimension of the simple V -module X is non-zero since \mathcal{C} is modular. Now, $\text{qdim}(J \boxtimes X) = \text{qdim}(J) \text{qdim}(X) = -\text{qdim}(X)$. (2) is Proposition 4.22 and Corollary 4.23 specialized to this situation. Proposition 4.19, (1), and (2) imply (3). Proposition 4.4 and (1) (or alternatively Corollary 4.24 and (3)) imply (4). Proposition 2.65 and (2) imply (5). (6) is clear from the definition of S^{∞} and $\text{qdim}(J) = -1$. Finally, (7) is Lemma 4.26 applied to this case. \square

Notation 4.28. Given $X = X^{\bar{0}} \oplus X^{\bar{1}}$ in $\text{Rep} A$, we let $\text{ch}^{\pm}[X] = \text{ch}[X^{\bar{0}}] \pm \text{ch}[X^{\bar{1}}]$. We refer to ch^{-} as the supercharacter. If X is simple, we say that X is untwisted if $\epsilon_{X^{\bar{0}}} = 1$ and twisted if $\epsilon_{X^{\bar{0}}} = -1$. By Lemma 4.27(5), untwisted objects are precisely the simple A -modules in \mathcal{C} ; twisted modules, on the other hand, are twisted with respect to the parity automorphism of A .

We also let \sim be the equivalence relation on \mathcal{S} given by $X \sim X \boxtimes J$. The equivalence classes \mathcal{S}/\sim correspond to simple objects in $\text{Rep} A$, with a fixed choice of representative in each class determining the parity. We fix such a choice now. The corresponding set of representatives can be identified with $[\text{Rep} A]$ in the Introduction. These representatives will be denoted by a superscript $\bar{0}$, such as $X^{\bar{0}}$, and correspondingly, we will let $\mathcal{S} = \mathcal{S}^{\bar{0}} \cup \mathcal{S}^{\bar{1}}$, where the union is disjoint thanks to (1) above.

As in the Introduction, we let $[\text{Rep}^0 A], [\text{Rep}^{\text{tw}} V] \subseteq [\text{Rep} A]$ be the representatives of simple untwisted and twisted objects, respectively.

Definition 4.29. Let $A = V \oplus J$ be a vertex operator superalgebra such that the representation category of its even part V is a modular tensor category, and let X be a simple A -module. We define

$$\text{adim}^{\pm}[X] := \lim_{iy \rightarrow 0^+} \frac{\text{ch}^{\pm}[X](iy)}{\text{ch}^{\pm}[A](iy)} = \lim_{iy \rightarrow i\infty} \frac{\text{ch}^{\pm}[X](-1/iy)}{\text{ch}^{\pm}[A](-1/iy)},$$

whenever the limit exists. These asymptotic dimensions were analyzed and used extensively in [DW3, DJX]. In those papers, asymptotic dimensions were denoted qdim , but we avoid this notation since for us qdim is the categorical dimension, that is, the trace of the identity morphism.

The calculation for the modular S -transformation of (super)characters is as follows. Let $X = X^{\bar{0}} \oplus X^{\bar{1}}$ be a simple object in $\text{Rep} A$ and let $v \in V$ be homogeneous of weight $\text{wt}[v]$ with respect to Zhu's modified vertex operator algebra structure on V [Zh]:

$$\begin{aligned} (\text{ch}^{\pm}[X])(-1/\tau, v) &= \tau^{\text{wt}[v]} \sum_{W \in \mathcal{S}} (S_{X^{\bar{0}}, W} \pm S_{X^{\bar{1}}, W}) \text{ch}[W](\tau, v) \\ &= \tau^{\text{wt}[v]} \sum_{W \in \mathcal{S}} (1 \pm d\epsilon_W) S_{X^{\bar{0}}, W} \text{ch}[W](\tau, v) \\ &= \tau^{\text{wt}[v]} \sum_{W^{\bar{0}} \in \mathcal{S}^{\bar{0}}} (1 \pm d\epsilon_{W^{\bar{0}}}) (S_{X^{\bar{0}}, W^{\bar{0}}} \text{ch}[W^{\bar{0}}](\tau, v) + S_{X^{\bar{0}}, W^{\bar{1}}} \text{ch}[W^{\bar{1}}](\tau, v)) \\ &= \tau^{\text{wt}[v]} \sum_{W^{\bar{0}} \in \mathcal{S}^{\bar{0}}} S_{X^{\bar{0}}, W^{\bar{0}}} (1 \pm d\epsilon_{W^{\bar{0}}}) (\text{ch}[W^{\bar{0}}](\tau, v) + d\epsilon_{X^{\bar{0}}} \text{ch}[W^{\bar{1}}](\tau, v)) \\ &= \tau^{\text{wt}[v]} \sum_{W^{\bar{0}} \in \mathcal{S}^{\bar{0}}} S_{X^{\bar{0}}, W^{\bar{0}}} \cdot (1 \pm d\epsilon_{W^{\bar{0}}}) \cdot (\text{ch}^{d\epsilon_{X^{\bar{0}}}}[\mathcal{F}(W^{\bar{0}})](\tau, v)) \\ &= \tau^{\text{wt}[v]} \sum_{W^{\bar{0}} \in \mathcal{S}^{\bar{0}}} S_{X^{\bar{0}}, W^{\bar{0}}} \cdot (1 \mp \epsilon_{W^{\bar{0}}}) \cdot (\text{ch}^{-\epsilon_{X^{\bar{0}}}}[\mathcal{F}(W^{\bar{0}})](\tau, v)) \\ &= \tau^{\text{wt}[v]} \sum_{\substack{W^{\bar{0}} \in \mathcal{S}^{\bar{0}} \\ \epsilon_{W^{\bar{0}}} = \mp 1}} 2 \cdot S_{X^{\bar{0}}, W^{\bar{0}}} \cdot (\text{ch}^{-\epsilon_{X^{\bar{0}}}}[\mathcal{F}(W^{\bar{0}})](\tau, v)). \end{aligned}$$

Note that $\mathcal{F}(W^{\bar{0}})$ exhaust the representatives of simple objects in $\text{Rep } A$, up to parity. Taking into account various cases, we can summarize how the (super)characters close under modular transformations for a simple object X in $\text{Rep } A$.

$$\begin{array}{c|c|c} X = X^{\bar{0}} \oplus X^{\bar{1}} & \text{ch}^+[X] & \text{ch}^-[X] \\ \hline X \text{ is untwisted} & \sum \text{ch}^-[\text{twisted}] & \sum \text{ch}^-[\text{untwisted}] \\ X \text{ is twisted} & \sum \text{ch}^+[\text{twisted}] & \sum \text{ch}^+[\text{untwisted}] \end{array}$$

We can summarize the information in the following way. We let $\mathcal{S}^{\bar{0}} = \{X_1^{\bar{0}}, X_2^{\bar{0}}, \dots, W_1^{\bar{0}}, W_2^{\bar{0}}, \dots\}$ where the X 's induce to untwisted modules and the W 's induce to twisted modules. Then, we have the following same pattern in the $S^{\pm 1}$ -matrices:

$$S = \begin{array}{c|cccccc} & X_1^{\bar{0}} & X_1^{\bar{1}} & \dots & W_1^{\bar{0}} & W_1^{\bar{1}} & \dots \\ \hline X_1^{\bar{0}} & a & -a & \dots & b & -b & \dots \\ X_1^{\bar{1}} & -a & a & \dots & b & -b & \dots \\ \vdots & \vdots & \vdots & \vdots & \vdots & \vdots & \vdots \\ W_1^{\bar{0}} & b & b & \dots & c & c & \dots \\ W_1^{\bar{1}} & -b & -b & \dots & c & c & \dots \\ \vdots & \vdots & \vdots & \vdots & \vdots & \vdots & \vdots \end{array}, \quad S^{-1} = \begin{array}{c|cccccc} & X_1^{\bar{0}} & X_1^{\bar{1}} & \dots & W_1^{\bar{0}} & W_1^{\bar{1}} & \dots \\ \hline X_1^{\bar{0}} & e & -e & \dots & f & -f & \dots \\ X_1^{\bar{1}} & -e & e & \dots & f & -f & \dots \\ \vdots & \vdots & \vdots & \vdots & \vdots & \vdots & \vdots \\ W_1^{\bar{0}} & f & f & \dots & g & g & \dots \\ W_1^{\bar{1}} & -f & -f & \dots & g & g & \dots \\ \vdots & \vdots & \vdots & \vdots & \vdots & \vdots & \vdots \end{array}, \quad (4.11)$$

and hence, if we change the basis, denoting $X_i^{\pm} = X_i^{\bar{0}} \pm X_i^{\bar{1}}$ and similarly for the W 's, we get the following two matrices respectively, which have a pattern similar to each other:

$$\tilde{S} = \begin{array}{c|cccccc} & X_1^+ & X_1^- & \dots & W_1^+ & W_1^- & \dots \\ \hline X_1^+ & 0 & 0 & \dots & 0 & 2b & \dots \\ X_1^- & 0 & 2a & \dots & 0 & 0 & \dots \\ \vdots & \vdots & \vdots & \vdots & \vdots & \vdots & \vdots \\ W_1^+ & 0 & 0 & \dots & 2c & 0 & \dots \\ W_1^- & 2b & 0 & \dots & 0 & 0 & \dots \\ \vdots & \vdots & \vdots & \vdots & \vdots & \vdots & \vdots \end{array}, \quad \tilde{S}^{-1} = \begin{array}{c|cccccc} & X_1^+ & X_1^- & \dots & W_1^+ & W_1^- & \dots \\ \hline X_1^+ & 0 & 0 & \dots & 0 & 2f & \dots \\ X_1^- & 0 & 2e & \dots & 0 & 0 & \dots \\ \vdots & \vdots & \vdots & \vdots & \vdots & \vdots & \vdots \\ W_1^+ & 0 & 0 & \dots & 2g & 0 & \dots \\ W_1^- & 2f & 0 & \dots & 0 & 0 & \dots \\ \vdots & \vdots & \vdots & \vdots & \vdots & \vdots & \vdots \end{array}. \quad (4.12)$$

In particular, we have the following observation:

Given simple modules $U = U^{\bar{0}} \oplus U^{\bar{1}}$ and $Z = Z^{\bar{0}} \oplus Z^{\bar{1}}$ in $\text{Rep } A$, there exists a unique coefficient in the $\tilde{S}^{\pm 1}$ matrices corresponding to U^{\pm} and Z^{\pm} that can be non-zero. We denote this coefficient $(\tilde{S}^{\pm 1})_{U,Z}$. For example, in the matrices above, $\tilde{S}_{X_1, W_1} := \tilde{S}_{X_1^+, W_1^-} = 2S_{X_1^{\bar{0}}, W_1^{\bar{0}}}$.

The T -transformation is easy. Note that by balancing, for any simple $X^{\bar{0}} \in \mathcal{S}$, (after identifying θ with the scalar by which it acts), we have: $\theta_{X^{\bar{0}}, J} = \epsilon_{X^{\bar{0}}} \theta_{X^{\bar{0}}}$. Hence for a simple $\text{Rep } A$ -object $X = X^{\bar{0}} \oplus X^{\bar{1}}$,

$$\begin{aligned} \text{ch}^{\pm}[X](\tau + 1) &= \text{ch}[X^{\bar{0}}](\tau + 1) \pm \text{ch}[X^{\bar{1}}](\tau + 1) \\ &= \theta_{X^{\bar{0}}} \text{ch}[X^{\bar{0}}](\tau) \pm \epsilon_{X^{\bar{0}}} \theta_{X^{\bar{0}}} \text{ch}[X^{\bar{1}}](\tau) \\ &= \theta_{X^{\bar{0}}} \text{ch}^{\pm \epsilon_{X^{\bar{0}}}}[X](\tau). \end{aligned}$$

Now we turn to fusion rules. Let $U = U^{\bar{0}} \oplus U^{\bar{1}}, W = W^{\bar{0}} \oplus W^{\bar{1}}, X = X^{\bar{0}} \oplus X^{\bar{1}}$ be simple objects in $\text{Rep } A$. We let $N_{U,W}^{\pm X} = N_{U^{\bar{0}}, W^{\bar{0}}}^{X^{\bar{0}}} \pm N_{U^{\bar{0}}, W^{\bar{0}}}^{X^{\bar{1}}}$. First,

$$\begin{aligned} N_{U^{\bar{0}}, W^{\bar{0}}}^{X^{\bar{0}}} &= \sum_{Z \in \mathcal{S}} \frac{S_{U^{\bar{0}}, Z} \cdot S_{W^{\bar{0}}, Z} \cdot (S^{-1})_{Z, X^{\bar{0}}}}{S_{V, Z}} \\ &= \sum_{Z^{\bar{0}} \in \mathcal{S}^{\bar{0}}} \left(1 + \frac{\epsilon_{U^{\bar{0}}} \epsilon_{W^{\bar{0}}}}{\epsilon_{X^{\bar{0}}}} \right) \frac{S_{U^{\bar{0}}, Z^{\bar{0}}} \cdot S_{W^{\bar{0}}, Z^{\bar{0}}} \cdot (S^{-1})_{Z^{\bar{0}}, X^{\bar{0}}}}{S_{V, Z^{\bar{0}}}} \end{aligned}$$

$$= \sum_{Z^{\bar{0}} \in \mathcal{S}^{\bar{0}}} 2 \cdot \frac{S_{U^{\bar{0}}, Z^{\bar{0}}} \cdot S_{W^{\bar{0}}, Z^{\bar{0}}} \cdot (S^{-1})_{Z^{\bar{0}}, X^{\bar{0}}}}{S_{V, Z^{\bar{0}}}}.$$

if $\epsilon_{X^{\bar{0}}} = \epsilon_{U^{\bar{0}}}\epsilon_{W^{\bar{0}}}$. Noting that $\epsilon_{X^{\bar{0}}} = \epsilon_{X^{\bar{1}}}$ (since $\mathcal{M}_{J,J} = 1_V$), we see that if $\epsilon_{X^{\bar{0}}} = \epsilon_{U^{\bar{0}}}\epsilon_{W^{\bar{0}}}$:

$$\begin{aligned} N_{U,W}^{\pm X} &= \sum_{Z^{\bar{0}} \in \mathcal{S}^{\bar{0}}} 2 \cdot \frac{S_{U^{\bar{0}}, Z^{\bar{0}}} \cdot S_{W^{\bar{0}}, Z^{\bar{0}}} \cdot \left((S^{-1})_{Z^{\bar{0}}, X^{\bar{0}}} \pm (S^{-1})_{Z^{\bar{0}}, X^{\bar{1}}} \right)}{S_{V, Z^{\bar{0}}}} \\ &= \sum_{Z^{\bar{0}} \in \mathcal{S}^{\bar{0}}} 2 \cdot (1 \pm d\epsilon_{Z^{\bar{0}}}) \cdot \frac{S_{U^{\bar{0}}, Z^{\bar{0}}} \cdot S_{W^{\bar{0}}, Z^{\bar{0}}} \cdot (S^{-1})_{Z^{\bar{0}}, X^{\bar{0}}}}{S_{V, Z^{\bar{0}}}} \\ &= \sum_{\substack{Z^{\bar{0}} \in \mathcal{S}^{\bar{0}} \\ \epsilon_{Z^{\bar{0}}} = \mp 1}} 4 \cdot \frac{S_{U^{\bar{0}}, Z^{\bar{0}}} \cdot S_{W^{\bar{0}}, Z^{\bar{0}}} \cdot (S^{-1})_{Z^{\bar{0}}, X^{\bar{0}}}}{S_{V, Z^{\bar{0}}}} \\ &= \sum_{\substack{Z \text{ simple} \\ \epsilon_{Z^{\bar{0}}} = \mp 1}} \frac{\tilde{S}_{U,Z} \cdot \tilde{S}_{W,Z} \cdot (\tilde{S}^{-1})_{Z,X}}{\tilde{S}_{A,Z}} \end{aligned}$$

From this, we get the following fusion (super)coefficients, recalling that for a simple object $Z = Z^{\bar{0}} \oplus Z^{\bar{1}}$ in $\text{Rep } A$, we let Z^{\pm} be the elements $Z^{\bar{0}} \pm Z^{\bar{1}}$ in the Grothendieck ring. With $U, W, X \in [\text{Rep } A]$ and

$$t : [\text{Rep } A] \rightarrow \mathbb{Z}/2\mathbb{Z}, \quad X \mapsto \begin{cases} 1 & \text{if } X \in [\text{Rep}^{\text{tw}} A] \\ 0 & \text{if } X \in [\text{Rep}^0 A], \end{cases}$$

we have:

$$\begin{aligned} N_{U,W}^{+X} &= \delta_{t(U)+t(W), t(X)} \sum_{Z \in [\text{Rep}^{\text{tw}} A]} \frac{\tilde{S}_{U,Z} \cdot \tilde{S}_{W,Z} \cdot (\tilde{S}^{-1})_{Z,X}}{\tilde{S}_{V,Z}} \\ N_{U,W}^{-X} &= \delta_{t(U)+t(W), t(X)} \sum_{Z \in [\text{Rep}^0 A]} \frac{\tilde{S}_{U,Z} \cdot \tilde{S}_{W,Z} \cdot (\tilde{S}^{-1})_{Z,X}}{\tilde{S}_{V,Z}}. \end{aligned} \tag{4.13}$$

We understand the numbers N^{\pm} as follows. Let $U = U^{\bar{0}} \oplus U^{\bar{1}}$, $W = W^{\bar{0}} \oplus W^{\bar{1}}$, and $X = X^{\bar{0}} \oplus X^{\bar{1}}$ be simple modules in $\text{Rep } A$, and let Π denote the parity reversal functor, that is, $\Pi(X) = X^{\bar{1}} \oplus X^{\bar{0}}$. Note that $\mathcal{F}(X^{\bar{1}}) = \Pi(X)$. Since $\mathcal{F}(U^{\bar{0}}) \boxtimes_A \mathcal{F}(W^{\bar{0}}) \cong \mathcal{F}(U^{\bar{0}} \boxtimes W^{\bar{0}})$, we have that

$$\begin{aligned} \mathcal{F}(U^{\bar{0}}) \boxtimes_A \mathcal{F}(W^{\bar{0}}) &= \bigoplus_{X \in \mathcal{S}} N_{U^{\bar{0}}, W^{\bar{0}}}^X \mathcal{F}(X) \\ &= \bigoplus_{X^{\bar{0}} \in \mathcal{S}^{\bar{0}}} N_{U^{\bar{0}}, W^{\bar{0}}}^{X^{\bar{0}}} \mathcal{F}(X^{\bar{0}}) \oplus \bigoplus_{X^{\bar{1}} \in \mathcal{S}^{\bar{1}}} N_{U^{\bar{0}}, W^{\bar{0}}}^{X^{\bar{1}}} \mathcal{F}(X^{\bar{1}}). \end{aligned}$$

Correspondingly, intertwining operators in \mathcal{C} of type $\binom{X^{\bar{0}}}{U^{\bar{0}} W^{\bar{0}}}$ lift to even intertwining operators, and those of type $\binom{X^{\bar{1}}}{U^{\bar{0}} W^{\bar{0}}}$ lift to odd intertwining operators. Therefore, $N_{U,W}^{+X}$ is the dimension of the space of A -intertwining operators of type $\binom{X}{U W}$, and $N_{U,W}^{-X}$ is the corresponding superdimension.

Now we analyze the properties of asymptotic dimensions. Suppose there exists a unique untwisted simple module $Z_{(+)}$ with lowest conformal dimension among untwisted simple modules, and there also exists a unique simple twisted module $Z_{(-)}$ of lowest conformal dimension among twisted simple modules. We assume that $\text{ch}^- [Z_{(+)}]$ does not vanish and that the lowest conformal weight spaces of $Z_{(\pm)}$ are purely even. For a simple A -module X , we have:

$$\text{adim}^{\pm} [X] = \lim_{iy \rightarrow i\infty} \frac{\text{ch}^{\pm} [X](-1/iy)}{\text{ch}^{\pm} [A](-1/iy)} = \frac{\tilde{S}_{X, Z_{(\mp)}}}{\tilde{S}_{A, Z_{(\mp)}}} = \frac{S_{X^0, Z_{(\mp)}^0}}{S_{V, Z_{(\mp)}^0}}. \tag{4.14}$$

Now, for simple modules X and Y in $\text{Rep } A$, we have that:

$$\text{adim}^{\pm} [X] \text{adim}^{\pm} [Y] = \frac{S_{X^{\bar{0}}, Z_{(\mp)}^{\bar{0}}}}{S_{V, Z_{(\mp)}^{\bar{0}}}} \frac{S_{Y^{\bar{0}}, Z_{(\mp)}^{\bar{0}}}}{S_{V, Z_{(\mp)}^{\bar{0}}}}$$

$$\begin{aligned}
&= \sum_{\substack{W^{\bar{0}} \in \mathcal{S}^{\bar{0}} \\ \epsilon_{W^{\bar{0}}} = \epsilon_{X^{\bar{0}}} \epsilon_{Y^{\bar{0}}}}} N_{X^{\bar{0}}, Y^{\bar{0}}}^{W^{\bar{0}}} \frac{S_{W^{\bar{0}}, Z^{\bar{0}}(\mp)}}{S_{V, Z^{\bar{0}}(\mp)}} + N_{X^{\bar{0}}, Y^{\bar{0}}}^{W^{\bar{1}}} \frac{S_{W^{\bar{1}}, Z^{\bar{0}}(\mp)}}{S_{V, Z^{\bar{0}}(\mp)}} \\
&= \sum_{\substack{W^{\bar{0}} \in \mathcal{S}^{\bar{0}} \\ \epsilon_{W^{\bar{0}}} = \epsilon_{X^{\bar{0}}} \epsilon_{Y^{\bar{0}}}}} \left(N_{X^{\bar{0}}, Y^{\bar{0}}}^{W^{\bar{0}}} + d\epsilon_{Z^{\bar{0}}(\mp)} N_{X^{\bar{0}}, Y^{\bar{0}}}^{W^{\bar{1}}} \right) \frac{S_{W^{\bar{0}}, Z^{\bar{0}}(\mp)}}{S_{V, Z^{\bar{0}}(\mp)}} \\
&= \sum_{\substack{W^{\bar{0}} \in \mathcal{S}^{\bar{0}} \\ \epsilon_{W^{\bar{0}}} = \epsilon_{X^{\bar{0}}} \epsilon_{Y^{\bar{0}}}}} N_{X, Y}^{\pm W} \frac{\tilde{S}_{W, Z(\mp)}}{\tilde{S}_{A, Z(\mp)}} = \sum_{\substack{W^{\bar{0}} \in \mathcal{S}^{\bar{0}} \\ \epsilon_{W^{\bar{0}}} = \epsilon_{X^{\bar{0}}} \epsilon_{Y^{\bar{0}}}}} N_{X, Y}^{\pm W} \text{adim}^{\pm}[W]. \tag{4.15}
\end{aligned}$$

This shows that asymptotic dimensions respect the tensor product on $\text{Rep } A$.

4.2.3 Algebras with wrong statistics

Now let $A = V \oplus J$ be a vertex operator algebra such that $\theta_J = -1_J$, $\text{qdim}(J) = -1$, and $\mathcal{M}_{J, J} = 1_V$. In this case, objects of $\text{Rep } A$ do not have an inherent $\mathbb{Z}/2\mathbb{Z}$ -grading. However, (1)–(3) of Proposition 4.5 apply in this setting (since $\text{qdim}(J) = -1$ implies fixed-point freeness) to yield the following lemma:

Lemma 4.30. *Every simple object X in $\text{Rep } A$ is an induced object; in particular, $X = X^{\bar{0}} \oplus X^{\bar{1}}$ where $X^{\bar{0}}$ is simple in \mathcal{C} and $X^{\bar{1}} = J \boxtimes X^{\bar{0}}$. Conversely, simple objects in \mathcal{C} induce to simple objects in $\text{Rep } A$.*

From Lemma 4.26, the properties of Hopf links are the same as in the wrong statistics superalgebra case. Thus every statement in the wrong statistics superalgebra case goes through here as well after fixing an arbitrary choice of $\mathbb{Z}/2\mathbb{Z}$ -decomposition for every simple object of $\text{Rep } A$, except for the T -transformation. We list relevant results in the Introduction, Section 1.5.2, and we now only indicate the difference in the modular T -transformation.

In this case, for a simple module $X^{\bar{0}}$ in \mathcal{C} , after identifying θ with the scalar by which it acts, we have $\theta_{X^{\bar{0}} \boxtimes J} = -\epsilon_{X^{\bar{0}}} \theta_{X^{\bar{0}}}$. Hence, for a simple module $X = X^{\bar{0}} \oplus X^{\bar{1}}$ in $\text{Rep } A$,

$$\begin{aligned}
\text{ch}^{\pm}[X](\tau + 1) &= \text{ch}[X^{\bar{0}}](\tau + 1) \pm \text{ch}[X^{\bar{1}}](\tau + 1) \\
&= \theta_{X^{\bar{0}}} \text{ch}[X^{\bar{0}}](\tau) \mp \epsilon_{X^{\bar{0}}} \theta_{X^{\bar{0}}} \text{ch}[X^{\bar{1}}](\tau) \\
&= \theta_{X^{\bar{0}}} \text{ch}^{\mp \epsilon_{X^{\bar{0}}}}[X](\tau).
\end{aligned}$$

The analysis of asymptotic dimensions carried out in (4.15) also goes through if we assume that $\text{ch}^-[Z_{(-)}]$ does not vanish and that the lowest conformal weight spaces of $Z_{(\pm)}$ are purely even.

4.2.4 Superalgebras with correct statistics

Recall that “correct statistics” means that for $A = V \oplus J$, $\text{qdim}(J) = 1$ and $\theta_J = \pm 1_J$. This means that for a simple module $X^{\bar{0}}$ in \mathcal{C} , we do not necessarily have $X^{\bar{0}} \cong J \boxtimes X^{\bar{0}}$. This complicates things somewhat, especially when A is a vertex operator algebra.

From Corollary 4.24, simple modules of \mathcal{C} induce to simple modules of $\text{Rep } A$, and from Corollary 4.23, simple modules of $\text{Rep } A$ are induced from simple modules in \mathcal{C} . In the discussion below, it will be important to consider those modules of $\text{Rep } A$ that are simple in $\text{Rep } A$.

Notation 4.31. Consider the set of representatives of isomorphism classes of simple objects in $\text{Rep } A$ up to parity. Each such simple module can be written uniquely as $X \cong X^{\bar{0}} \oplus X^{\bar{1}}$ where the X^i are in \mathcal{S} with $X^{\bar{1}} \cong J \boxtimes X^{\bar{0}}$. Let $\mathcal{S}^{\bar{0}}$ be those $X^{\bar{0}}$ such that $X^{\bar{0}} \not\cong X^{\bar{1}}$. Let $\mathcal{S}^{\bar{1}}$ be the set of simple V -modules obtained by tensoring J to the objects in $\mathcal{S}^{\bar{0}}$ and let $\mathcal{S}^f = \mathcal{S} \setminus (\mathcal{S}^{\bar{0}} \cup \mathcal{S}^{\bar{1}})$, that is, those simple modules that are fixed under the action of J .

In this case, we have the following S -matrix relations:

Lemma 4.32. *Let W and X be simple V -modules in \mathcal{S} and let $X^{(i)} = J^i \boxtimes X$ for $i \in \mathbb{N}$.*

1. For $i, j \in \mathbb{N}$, $(S^{\pm})_{W^{(i)}, X^{(j)}} = \epsilon_X^i \epsilon_W^j (S^{\pm})_{W, X}$.
2. If $X \in \mathcal{S}^f$, then $\epsilon_X = -1$.
3. If $X \in \mathcal{S}^f$ and if $\epsilon_W = -1$, then $(S^{\pm})_{W, X} = 0$.

Proof. Item (1) is Lemma 4.26 applied to this setting. Item (2) follows from the balancing equation: $\theta_{J \boxtimes X} = \mathcal{M}_{J, X} \circ (\theta_J \boxtimes \theta_X)$. For item (3), it follows from item (1) that

$$(S^\pm)_{W, X} = (S^\pm)_{W, X \boxtimes J} = \epsilon_W (S^\pm)_{W, X} = -(S^\pm)_{W, X},$$

so that $(S^\pm)_{W, X} = 0$. \square

Now let $X = X^{\bar{0}} \oplus X^{\bar{1}}$, with $X^i \in \mathcal{S}$, be a simple module in Rep A. We proceed as for wrong statistics superalgebras, but now using Lemma 4.32, to obtain:

$$\begin{aligned} (\text{ch}^\pm[X])(-1/\tau) &= \sum_{W^{\bar{0}} \in \mathcal{S}^{\bar{0}}, \epsilon_{W^{\bar{0}}} = \pm 1} 2 \cdot S_{X^{\bar{0}}, W^{\bar{0}}} \text{ch}^{\epsilon_{X^{\bar{0}}}}[\mathcal{F}(W^{\bar{0}})](\tau) + \sum_{W^{\bar{0}} \in \mathcal{S}^f} (1 \mp 1) \cdot S_{X^{\bar{0}}, W^{\bar{0}}} \text{ch}[W^{\bar{0}}](\tau) \\ &= \sum_{W^{\bar{0}} \in \mathcal{S}^{\bar{0}}, \epsilon_{W^{\bar{0}}} = \pm 1} 2 \cdot S_{X^{\bar{0}}, W^{\bar{0}}} \text{ch}^{\epsilon_{X^{\bar{0}}}}[\mathcal{F}(W^{\bar{0}})](\tau) + \sum_{W^{\bar{0}} \in \mathcal{S}^f} (1 \mp 1) \cdot S_{X^{\bar{0}}, W^{\bar{0}}} \cdot \frac{1}{2} \cdot \text{ch}[\mathcal{F}(W^{\bar{0}})](\tau). \end{aligned}$$

We can summarize the information as before. Let $X_1^{\bar{0}}, X_2^{\bar{0}}, \dots$ be simple V -modules in $\mathcal{S}^{\bar{0}}$ that induce to untwisted modules, let $W_1^{\bar{0}}, W_2^{\bar{0}}, \dots$ be simple V -modules in $\mathcal{S}^{\bar{0}}$ that induce to twisted modules, and let W_1^f, W_2^f, \dots be V -modules in \mathcal{S}^f . By Lemma 4.32, the S -matrix for \mathcal{C} has the following pattern:

$$S = \begin{array}{c|cccccccc} & X_1^{\bar{0}} & X_1^{\bar{1}} & \dots & W_1^{\bar{0}} & W_1^{\bar{1}} & \dots & W_1^f & \dots \\ \hline X_1^{\bar{0}} & a & a & \dots & b & b & \dots & e & \dots \\ X_1^{\bar{1}} & a & a & \dots & -b & -b & \dots & -e & \dots \\ \vdots & \vdots & \vdots & \vdots & \vdots & \vdots & \vdots & \vdots & \vdots \\ W_1^{\bar{0}} & b & -b & \dots & c & -c & \dots & 0 & \dots \\ W_1^{\bar{1}} & b & -b & \dots & -c & c & \dots & 0 & \dots \\ \vdots & \vdots & \vdots & \vdots & \vdots & \vdots & \vdots & \vdots & \dots \\ W_1^f & e & -e & \dots & 0 & 0 & \dots & 0 & \dots \\ \vdots & \vdots & \vdots & \vdots & \vdots & \vdots & \vdots & \vdots & \vdots \end{array} \quad (4.16)$$

The S^{-1} -matrix follows the exact same pattern. If we change the basis, denoting $X_i^\pm = X_i^{\bar{0}} \pm X_i^{\bar{1}}$ and similarly $W_i^\pm = W_i^{\bar{0}} \pm W_i^{\bar{1}}$, $W_i^{f\pm} = W_i^f + W_i^f$, we obtain the following *non-symmetric* matrix, with a similar pattern for its inverse. This matrix, as before, describes the transformation laws for characters and supercharacters of simple modules in Rep A.

$$\tilde{S} = \begin{array}{c|cccccccc} & X_1^+ & X_1^- & \dots & W_1^+ & W_1^- & \dots & W_1^{f+} & \dots \\ \hline X_1^+ & 2a & 0 & \dots & 0 & 0 & \dots & 0 & \dots \\ X_1^- & 0 & 0 & \dots & 2b & 0 & \dots & e & \dots \\ \vdots & \vdots & \vdots & \vdots & \vdots & \vdots & \vdots & \vdots & \vdots \\ W_1^+ & 0 & 2b & \dots & 0 & 0 & \dots & 0 & \dots \\ W_1^- & 0 & 0 & \dots & 0 & 2c & \dots & 0 & \dots \\ \vdots & \vdots & \vdots & \vdots & \vdots & \vdots & \vdots & \vdots & \dots \\ W_1^{f+} & 0 & 2e & \dots & 0 & 0 & \dots & 0 & \dots \\ \vdots & \vdots & \vdots & \vdots & \vdots & \vdots & \vdots & \vdots & \vdots \end{array} \quad (4.17)$$

Again, as before, we have:

Given simple modules $U = U^{\bar{0}} \oplus U^{\bar{1}}$ and $Z = Z^{\bar{0}} \oplus Z^{\bar{1}}$, there exists a unique coefficient in the $\tilde{S}^{\pm 1}$ matrices corresponding to U^\pm and Z^\pm that can be non-zero. We denote this coefficient $(\tilde{S}^{\pm 1})_{U, Z}$. For example, in the matrices above, $\tilde{S}_{W_1, X_1} := \tilde{S}_{W_1^+, X_1^-} = 2S_{W_1^{\bar{0}}, X_1^{\bar{0}}}$. However, \tilde{S} is *non-symmetric* when one subscript corresponds to a fixed-point object.

From the \tilde{S} -matrix, we can summarize the (super)character S -transformation properties as:

$X = X^{\bar{0}} \oplus X^{\bar{1}}$	$\text{ch}^+[X]$	$\text{ch}^-[X]$
X is untwisted	$\sum \text{ch}^+[\text{untwisted}]$	$\sum \text{ch}^+[\text{twisted}]$
X is twisted, $X^{\bar{0}} \not\cong X^{\bar{1}}$	$\sum \text{ch}^+[\text{untwisted}]$	$\sum \text{ch}^+[\text{twisted}]$
X is twisted, $X^{\bar{0}} \cong X^{\bar{1}}$	$\sum \text{ch}^+[\text{untwisted}]$	0

As in the wrong statistics case, we calculate the even and odd fusion coefficients. For simple modules $U = U^{\bar{0}} \oplus U^{\bar{1}}$, $W = W^{\bar{0}} \oplus W^{\bar{1}}$, $X = X^{\bar{0}} \oplus X^{\bar{1}}$,

$$N_{U^{\bar{0}}, W^{\bar{0}}}^{X^{\bar{0}}} = \sum_{\substack{Z^{\bar{0}} \in \mathcal{S}^{\bar{0}} \\ \epsilon_{X^{\bar{0}}} = \epsilon_{U^{\bar{0}}} \epsilon_{W^{\bar{0}}}}} 2 \cdot \frac{S_{U^{\bar{0}}, Z^{\bar{0}}} S_{W^{\bar{0}}, Z^{\bar{0}}}(S^{-1})_{Z^{\bar{0}}, X^{\bar{0}}}}{S_{V, Z^{\bar{0}}}} + \sum_{\substack{Z^{\bar{0}} \in \mathcal{S}^f \\ \epsilon_{X^{\bar{0}}} = \epsilon_{U^{\bar{0}}} = \epsilon_{W^{\bar{0}}} = 1}} \frac{S_{U^{\bar{0}}, Z^{\bar{0}}} S_{W^{\bar{0}}, Z^{\bar{0}}}(S^{-1})_{Z^{\bar{0}}, X^{\bar{0}}}}{S_{V, Z^{\bar{0}}}}.$$

Therefore,

$$\begin{aligned} N_{U, W}^{\pm X} &= \sum_{\substack{Z^{\bar{0}} \in \mathcal{S}^{\bar{0}} \\ \epsilon_{X^{\bar{0}}} = \epsilon_{U^{\bar{0}}} \epsilon_{W^{\bar{0}}}}} 2 \cdot (1 \pm \epsilon_{Z^{\bar{0}}}) \cdot \frac{S_{U^{\bar{0}}, Z^{\bar{0}}} S_{W^{\bar{0}}, Z^{\bar{0}}}(S^{-1})_{Z^{\bar{0}}, X^{\bar{0}}}}{S_{V, Z^{\bar{0}}}} \\ &+ \sum_{\substack{Z^{\bar{0}} \in \mathcal{S}^f \\ \epsilon_{X^{\bar{0}}} = \epsilon_{U^{\bar{0}}} = \epsilon_{W^{\bar{0}}} = 1}} (1 \mp 1) \cdot \frac{S_{U^{\bar{0}}, Z^{\bar{0}}} S_{W^{\bar{0}}, Z^{\bar{0}}}(S^{-1})_{Z^{\bar{0}}, X^{\bar{0}}}}{S_{V, Z^{\bar{0}}}}. \end{aligned} \quad (4.18)$$

Setting

$$t : [\text{Rep } A] \rightarrow \mathbb{Z}/2\mathbb{Z}, \quad X \mapsto \begin{cases} \bar{0} & \text{if } X \in [\text{Rep}^{\bar{0}} A] \\ \bar{1} & \text{if } X \in [\text{Rep}^{\text{tw}} A] \end{cases} \quad \text{and} \quad n_W = \begin{cases} 2 & \text{if } W \in [\text{Rep}^{\text{fix}} A] \\ 1 & \text{else} \end{cases},$$

we thus have

$$\begin{aligned} N_{U, W}^{+X} &= n_X \cdot \delta_{t(U)+t(W), t(X)} \sum_{Z \in [\text{Rep}^{\bar{0}} A]} \frac{\tilde{S}_{U, Z} \cdot \tilde{S}_{W, Z} \cdot (\tilde{S}^{-1})_{Z, X}}{\tilde{S}_{A, Z}} \\ N_{U, W}^{-X} &= \delta_{t(U)+t(W), t(X)} \sum_{Z \in [\text{Rep}^{\text{tw}} A]} \frac{\tilde{S}_{U, Z} \cdot \tilde{S}_{W, Z} \cdot (\tilde{S}^{-1})_{Z, X}}{\tilde{S}_{A, Z}} \end{aligned} \quad (4.19)$$

Again, we remind the reader that \tilde{S} is not symmetric for all values of the subscripts.

Now we analyze the asymptotic dimensions. Suppose there exist $Z_{(\pm)}$ as in the wrong statistics case. We assume that $\text{ch}^-[Z_{(-)}]$ does not vanish; in particular, $Z_{(-)}$ is not a fixed-point-type twisted module and the lowest conformal weight spaces of $Z_{(\pm)}$ are purely even. Then we have:

$$\text{adim}^{\pm}[X] = \frac{\tilde{S}_{X, Z_{(\pm)}}}{\tilde{S}_{A, Z_{(\pm)}}} = \frac{S_{X^{\bar{0}}, Z_{(\pm)}^{\bar{0}}}}{S_{V, Z_{(\pm)}^{\bar{0}}}}.$$

Therefore,

$$\begin{aligned} \text{adim}^{\pm}[X] \text{adim}^{\pm}[Y] &= \frac{S_{X^{\bar{0}}, Z_{(\pm)}^{\bar{0}}}}{S_{V, Z_{(\pm)}^{\bar{0}}}} \frac{S_{Y^{\bar{0}}, Z_{(\pm)}^{\bar{0}}}}{S_{V, Z_{(\pm)}^{\bar{0}}}} = \sum_{\substack{W \in \mathcal{S} \\ \epsilon_W = \epsilon_{X^{\bar{0}}} \epsilon_{Y^{\bar{0}}}}} N_{X^{\bar{0}}, Y^{\bar{0}}}^W \frac{S_{W, Z_{(\pm)}^{\bar{0}}}}{S_{V, Z_{(\pm)}^{\bar{0}}}} \\ &= \sum_{\substack{W^{\bar{0}} \in \mathcal{S}^{\bar{0}} \\ \epsilon_{W^{\bar{0}}} = \epsilon_{X^{\bar{0}}} \epsilon_{Y^{\bar{0}}}}} \left(N_{X^{\bar{0}}, Y^{\bar{0}}}^{W^{\bar{0}}} \frac{S_{W^{\bar{0}}, Z_{(\pm)}^{\bar{0}}}}{S_{V, Z_{(\pm)}^{\bar{0}}}} + N_{X^{\bar{0}}, Y^{\bar{0}}}^{W^{\bar{1}}} \frac{S_{W^{\bar{1}}, Z_{(\pm)}^{\bar{0}}}}{S_{V, Z_{(\pm)}^{\bar{0}}}} \right) + \sum_{\substack{W^f \in \mathcal{S}^f \\ \epsilon_{X^{\bar{0}}} \epsilon_{Y^{\bar{0}}} = -1}} N_{X^{\bar{0}}, Y^{\bar{0}}}^{W^f} \frac{S_{W^f, Z_{(\pm)}^{\bar{0}}}}{S_{V, Z_{(\pm)}^{\bar{0}}}} \\ &= \sum_{\substack{W^{\bar{0}} \in \mathcal{S}^{\bar{0}} \\ \epsilon_{W^{\bar{0}}} = \epsilon_{X^{\bar{0}}} \epsilon_{Y^{\bar{0}}}}} \left(N_{X^{\bar{0}}, Y^{\bar{0}}}^{W^{\bar{0}}} \pm N_{X^{\bar{0}}, Y^{\bar{0}}}^{W^{\bar{1}}} \right) \frac{S_{W^{\bar{0}}, Z_{(\pm)}^{\bar{0}}}}{S_{V, Z_{(\pm)}^{\bar{0}}}} + \sum_{\substack{W^f \in \mathcal{S}^f \\ \epsilon_{X^{\bar{0}}} \epsilon_{Y^{\bar{0}}} = -1}} N_{X^{\bar{0}}, Y^{\bar{0}}}^{W^f} \frac{S_{W^f, Z_{(\pm)}^{\bar{0}}}}{S_{V, Z_{(\pm)}^{\bar{0}}}} \\ &= \sum_{\substack{W \text{ non-fixed-point simple} \\ \epsilon_{W^{\bar{0}}} = \epsilon_{X^{\bar{0}}} \epsilon_{Y^{\bar{0}}}}} N_{X, Y}^{\pm W} \frac{\tilde{S}_{W, Z_{(\pm)}}}{\tilde{S}_{A, Z_{(\pm)}}} + \sum_{\substack{W^f \in \mathcal{S}^f \\ \epsilon_{X^{\bar{0}}} \epsilon_{Y^{\bar{0}}} = -1}} N_{X^{\bar{0}}, Y^{\bar{0}}}^{W^f} \frac{S_{W^f, Z_{(\pm)}^{\bar{0}}}}{S_{V, Z_{(\pm)}^{\bar{0}}}} \end{aligned}$$

$$= \sum_{\substack{W \text{ non-fixed-point simple} \\ \epsilon_{W\bar{0}} = \epsilon_{X\bar{0}} \epsilon_{Y\bar{0}}}} N_{X,Y}^{\pm W} \text{adim}^{\pm}[W] + \sum_{\substack{W^f \in \mathcal{S}^f \\ \epsilon_{X\bar{0}} \epsilon_{Y\bar{0}} = -1}} N_{X\bar{0}, Y\bar{0}}^{W^f} \frac{S_{W^f, Z\bar{0}}^{\pm}}{S_{V, Z\bar{0}}^{\pm}}.$$

Hence, for adim^- we have:

$$\text{adim}^- [X] \text{adim}^- [Y] = \sum_{\substack{W \text{ simple} \\ \epsilon_{W\bar{0}} = \epsilon_{X\bar{0}} \epsilon_{Y\bar{0}}}} N_{X,Y}^{-W} \text{adim}^- [W], \quad (4.20)$$

so asymptotic superdimension respects the tensor product on $\text{Rep } A$. The relation $\text{adim}^+ [X] \text{adim}^+ [Y] = \text{adim}^+ [X \boxtimes_A Y]$ also holds if X and Y are both untwisted or both twisted.

Remark 4.33. Several observations about fixed-point simple modules are in order; let T be such a module. First, by definition, (and also from (4.18)), $N_{X,Y}^{-T} = 0$, $N_{T,Y}^{-W} = 0$, $N_{X,T}^{-W} = 0$. For such a T , one can alternately define $N_{X,Y}^{+T} = N_{X\bar{0}, Y\bar{0}}^{T\bar{0}}$, which also makes (4.19) uniform. Since $\text{ch}^- [T] = 0$, the negative asymptotic dimension $\text{adim}^- [T] = 0$. It is now clear that (4.20) completely disregards such modules T .

Since this scenario is a little tricky with an asymmetric \tilde{S} -matrix, we present a quick example:

Example 4.34. Let A be the vertex operator superalgebra of one free fermion. Up to isomorphisms, it has one simple untwisted module, say $U = A$, and one twisted module, say T . The twisted module is a fixed point. We have the following characters:

$$\begin{aligned} \text{ch}^+ [U] &= q^{-1/24} \prod_{n \geq 0} (1 + q^{n+1/2}) = \frac{\eta(\tau)^2}{\eta(\tau/2)\eta(2\tau)}, & \text{ch}^- [U] &= q^{-1/24} \prod_{n \geq 0} (1 - q^{n+1/2}) = \frac{\eta(\tau/2)}{\eta(\tau)}, \\ \text{ch}^+ [T] &= 2q^{1/12} \prod_{n \geq 1} (1 + q^n) = 2 \frac{\eta(2\tau)}{\eta(\tau)}, & \text{ch}^- [T] &= 0. \end{aligned}$$

We also have the following fusion rules as modules for the even part of A :

$$N_{U^i, U^j}^{U^k} = \delta_{i+j, k}, \quad N_{U^i, T^j}^{T^k} = 1, \quad N_{T^i, T^j}^{U^k} = 1.$$

The \tilde{S} -matrix can be calculated using the transformation properties of η :

$$\tilde{S} = \begin{array}{c|ccc} & U^+ & U^- & T^+ \\ \hline U^+ & 1 & 0 & 0 \\ U^- & 0 & 0 & 1/\sqrt{2} \\ T^+ & 0 & \sqrt{2} & 0 \end{array} = \tilde{S}^{-1}.$$

Now we are ready to calculate the fusion rules.

$$\begin{aligned} N_{U,U}^{+U} &= \sum_{\epsilon_Z=1} \frac{\tilde{S}_{U,Z} \tilde{S}_{U,Z}(\tilde{S}^{-1})_{Z,U}}{\tilde{S}_{A,Z}} = \frac{\tilde{S}_{U,U} \tilde{S}_{U,U} \tilde{S}_{U,U}}{\tilde{S}_{A,U}} = 1, \\ N_{U,U}^{-U} &= \sum_{\epsilon_Z=-1} \frac{\tilde{S}_{U,Z} \tilde{S}_{U,Z}(\tilde{S}^{-1})_{Z,U}}{\tilde{S}_{A,Z}} = \frac{\tilde{S}_{U,T} \tilde{S}_{U,T} \tilde{S}_{T,U}}{\tilde{S}_{U,T}} = \frac{(1/\sqrt{2})(1/\sqrt{2})(\sqrt{2})}{(1/\sqrt{2})} = 1, \\ N_{U,T}^{+T} &= \sum_{\epsilon_Z=1} 2 \cdot \frac{\tilde{S}_{U,Z} \tilde{S}_{T,Z}(\tilde{S}^{-1})_{Z,T}}{\tilde{S}_{A,Z}} = 2 \cdot \frac{\tilde{S}_{U,U} \tilde{S}_{T,U} \tilde{S}_{U,T}}{\tilde{S}_{U,U}} = 2(1/\sqrt{2})(\sqrt{2}) = 2, \\ N_{U,T}^{-T} &= \sum_{\epsilon_Z=-1} \frac{\tilde{S}_{U,Z} \tilde{S}_{T,Z}(\tilde{S}^{-1})_{Z,T}}{\tilde{S}_{A,Z}} = \frac{\tilde{S}_{U,T} \tilde{S}_{T,T} \tilde{S}_{T,T}}{\tilde{S}_{U,T}} = 0, \\ N_{T,T}^{+U} &= \sum_{\epsilon_Z=1} \frac{\tilde{S}_{T,Z} \tilde{S}_{T,Z}(\tilde{S}^{-1})_{Z,U}}{\tilde{S}_{A,Z}} = \frac{\tilde{S}_{T,U} \tilde{S}_{T,U} \tilde{S}_{U,U}}{\tilde{S}_{U,U}} = 2, \\ N_{T,T}^{-U} &= \sum_{\epsilon_Z=-1} \frac{\tilde{S}_{T,Z} \tilde{S}_{T,Z}(\tilde{S}^{-1})_{Z,U}}{\tilde{S}_{A,Z}} = \frac{\tilde{S}_{T,T} \tilde{S}_{T,T} \tilde{S}_{T,U}}{\tilde{S}_{U,T}} = 0. \end{aligned}$$

4.3 Cosets by lattice vertex operator algebras: General results

If V is a vertex operator algebra and U a vertex operator subalgebra of V (with a different conformal vector), then the commutant $C = \text{Com}(U, V)$ is called the coset vertex operator subalgebra of U in V . If $U = \text{Com}(C, V)$, then U and C are said to be a mutually commuting or Howe pair in V . The aim of this section is to show that much of the representation theories of the two vertex operator algebras V and C are related, and thus one can reconstruct structure in one of them from that in the other.

4.3.1 Coset modules

Surely the simplest cosets are those by lattice or Heisenberg vertex operator subalgebras. Recently, some results regarding such cosets in the general non-rational setting have been given [CKLR], but for this section, we concentrate on the rational picture and rederive several results well-established in the literature in a new and more general way using the machinery developed thus far. Most notably, we exhibit a natural use of the induction functor and the characterization of $\text{Rep}^0 A$. We begin by recalling several results from [CKLR] and elsewhere. Recall that a vertex operator algebra is of CFT type if it has no negatively-graded weight spaces and if $V_0 = \mathbb{C}1$.

Theorem 4.35. [CKLR, Corollary 4.13] *Let V be a simple, self-contragredient, rational, and C_2 -cofinite vertex operator algebra of CFT type. If L is an even positive definite lattice such that the lattice vertex operator algebra V_L is a vertex subalgebra of V and V_L is maximal with this property, then the coset $C = \text{Com}(V_L, V)$ is simple, rational, and C_2 -cofinite.*

We note an easy lemma which we shall frequently use:

Lemma 4.36. *Let A , B and $A \otimes B$ be regular vertex operator algebras. Then*

$$(A_1 \otimes B_1) \boxtimes_{A \otimes B} (A_2 \otimes B_2) \cong (A_1 \boxtimes_A A_2) \otimes (B_1 \boxtimes_B B_2)$$

for A -modules A_1, A_2 and B -modules B_1, B_2 .

Remark 4.37. If the vertex operator algebras involved are not regular, then the conclusion of the lemma still holds when the left side is already known to be a module that cleanly factors as a tensor product of two modules. This is the case, for instance, when A is a lattice or Heisenberg vertex operator algebra and if we are working with a semisimple category of modules.

Let $V = M_0, M_1, \dots, M_n$ denote the inequivalent simple V -modules, and let L' be the dual lattice of L . Then there is a lattice $N, L \subseteq N \subseteq L'$ such that

$$V = \bigoplus_{\nu+L \in N/L} V_{\nu+L} \otimes M_{0,\nu}$$

as a $V_L \otimes C$ -module, with $C = M_{0,0}$. The finite group N/L acts by automorphisms on V ; hence each $V_{\nu+L} \otimes M_{0,\nu}$ is a simple $V_L \otimes C$ -module [DM1, DLM1] and also a simple current for $V_L \otimes C$ [CaM].

Remark 4.38. The simple currents $V_{\nu+L} \otimes M_{0,\nu}$ are fixed-point free since this holds for the simple modules for a lattice vertex operator algebra. Hence, Proposition 4.5 implies that two simple V -modules are isomorphic if and only if they are isomorphic as $V_L \otimes C$ -modules.

By [CKLR], all $M_{0,\nu}$ are simple currents for $C = M_{0,0}$ with fusion rules

$$M_{0,\nu_1} \boxtimes_C M_{0,\nu_2} = M_{0,\nu_1+\nu_2} \text{ for } \nu_1, \nu_2 \in N/L.$$

Moreover, they are pairwise inequivalent, which is a consequence of the maximality of L or V_L . A similar $V_L \otimes C$ -decomposition holds [CKLR, Theorem 3.8] for each simple V -module M_i :

$$M_i = \bigoplus_{\lambda+L \in L'/L} V_{\lambda+L} \otimes M_{i,\lambda},$$

with

$$M_{0,\nu} \boxtimes_C M_{i,\lambda} = M_{i,\nu+\lambda} \text{ for } \nu \in N/L, \lambda \in L'/L.$$

Simplicity of M_i implies that if $M_{i,\lambda_1}, M_{i,\lambda_2} \neq 0$ then $\lambda_1 - \lambda_2 \in N/L$. Therefore, for each M_i , we fix a choice of $\lambda_i \in L'/L$ such that $\lambda_0 = 0$ and

$$M_i = \bigoplus_{\nu+L \in N/L} V_{\lambda_i+\nu+L} \otimes M_{i,\lambda_i+\nu}. \quad (4.21)$$

The $M_{i,\lambda}$ are simple C -modules by [CKLR, Theorem 3.8], but for any fixed i , they need not be pairwise non-isomorphic. In any case, the decomposition (4.21) implies that each M_i can be obtained as the induction of a simple $V_L \otimes C$ -module, for example $V_{\lambda_i+L} \otimes M_{i,\lambda_i}$. We shall investigate additional properties of the $M_{i,\mu}$ below.

If X is a simple C -module then by [CKLR, Theorem 4.3, Lemma 4.9] and the proof of [CKLR, Theorem 4.12], there exists a $\lambda + L \in L'/L$ such that

$$\mathcal{F}(V_{\lambda+\nu'+L} \otimes X) \cong_{V_L \otimes C} \bigoplus_{\nu+L \in N/L} V_{\lambda+\nu'+\nu+L} \otimes (M_{0,\nu} \boxtimes_C X) \quad (4.22)$$

is an untwisted V -module if and only if $\nu' + L \in N'/L$, where $L \subseteq N' \subseteq L'$ is the lattice dual to N . This result follows directly from the characterization of $\text{Rep}^0 V$ in [HKL, CKL]. As a corollary, setting $\nu' = 0$, we can always tensor a given simple C -module X with a V_L -module such that the result induces to an untwisted V -module. This V -module is simple by Proposition 4.4, so

$$\mathcal{F}(V_{\lambda+L} \otimes X) \cong M_i$$

for some $i \in \{0, \dots, n\}$. It would make sense to identify X with $M_{i,\lambda}$, but this identification is not unique and needs to be clarified. Consider the special case $X = C = M_{0,0}$; then for $\nu + L \in N'/L$,

$$M^\nu := \mathcal{F}(V_{\nu+L} \otimes C) \quad (4.23)$$

satisfy the following for $\nu_1, \nu_2 \in N'/L$:

$$\begin{aligned} M^{\nu_1} \boxtimes_V M^{\nu_2} &= \mathcal{F}(V_{\nu_1+L} \otimes C) \boxtimes_V \mathcal{F}(V_{\nu_2+L} \otimes C) \\ &\cong \mathcal{F}((V_{\nu_1+L} \otimes C) \boxtimes_{V_L \otimes C} (V_{\nu_2+L} \otimes C)) = \mathcal{F}(V_{\nu_1+\nu_2+L} \otimes C) \cong M^{\nu_1+\nu_2}. \end{aligned} \quad (4.24)$$

Proposition 4.39. *For $\nu + L \in N'/L$, the M^ν are pairwise non-isomorphic untwisted V -modules for V , and they are simple currents for V .*

Proof. Since the $M_{0,\nu}$ are pairwise inequivalent for $\nu \in N/L$, the M^ν are pairwise non-isomorphic since their decompositions as $V_L \otimes C$ -modules are non-isomorphic. From (4.24), it is clear that $M^{-\nu} \boxtimes_V M^\nu \cong M^0 \cong V$, so they are invertible objects, that is, simple currents [CKLR]. Since all vertex operator algebras under consideration are rational, tensor products and hence monodromy factor over the tensor product of vertex operator algebras. This immediately implies that the monodromy of $V_{\nu+L} \otimes C$ with $V_{\mu+L} \otimes M_{0,\mu}$ is trivial for any $\mu \in N$ and $\nu \in N'$, which in turn implies that $\mathcal{F}(V_{\nu+L} \otimes C)$ is a module in $\text{Rep}^0 V$. \square

We have the following isomorphisms among the $M_{i,\lambda_i+\nu}$:

Theorem 4.40. *For $\lambda + L, \mu + L \in L'/L$ and $0 \leq i, j \leq n$, $M_{i,\lambda} \cong M_{j,\mu}$ if and only if $\mu - \lambda \in N'$ and $M^{\mu-\lambda} \boxtimes_V M_i \cong M_j$. In particular, $M_{i,\lambda} \cong M_{j,\lambda}$ if and only if $i = j$.*

Proof. The ‘‘if’’ direction follows from the induction functor and the ‘‘only if’’ direction follows from the observation (4.22) and Proposition 4.39. \square

Recall that for each M_i , we have fixed a choice of $\lambda_i + L \in L'/L$. We define an equivalence relation on the set $\{(i, \lambda_i + \nu) \mid 0 \leq i \leq n, \nu + L \in N/L\}$:

$$(i, \psi) \sim (j, \phi) \leftrightarrow M_{i,\psi} \cong M_{j,\phi},$$

and we let S be the set of equivalence classes under \sim .

Corollary 4.41. *The number of inequivalent simple C -modules is*

$$|S| = \frac{(n+1)|N/L|}{|N'/L|}.$$

Proof. There are $n+1$ inequivalent simple V -modules, all obtained by inducing $V_L \otimes C$ -modules. For each simple C -module there exist $|N'/L|$ inequivalent simple V_L -modules such that their tensor product induces to a (simple) V -module. Moreover, by Proposition 4.5, each simple V -module can be obtained by inducing any one of $|N/L|$ inequivalent simple $V_L \otimes C$ -modules. \square

4.3.2 Fusion

The coset decomposition gives a relation between fusion rules. We define fusion coefficients for both V - and C -modules as usual:

$$M_i \boxtimes_V M_j \cong \bigoplus_{k=0}^n N(V)_{ij}^k M_k,$$

and for $(i, \nu_i), (j, \nu_j) \in S$,

$$M_{i, \nu_i} \boxtimes_C M_{j, \nu_j} \cong \bigoplus_{(k, \nu_k) \in S} N(C)_{(i, \nu_i)(j, \nu_j)}^{(k, \nu_k)} M_{k, \nu_k}$$

where the latter sum is over S , the set of inequivalent C -modules, that is, we use the identification of the last theorem. Since intertwining operators preserve Heisenberg weights, we have

$$N(V)_{ij}^k \neq 0 \implies \nu_k - \nu_i - \nu_j + L \in N/L.$$

Theorem 4.42. *Fusion rules are related as follows:*

$$\begin{aligned} M_{i, \mu_i} \boxtimes_C M_{j, \mu_j} &\cong \bigoplus_{k=0}^n N(V)_{ij}^k M_{k, \mu_i + \mu_j}, \quad (\text{here, the summands are pairwise inequivalent}) \\ M_i \boxtimes_V M_j &\cong \bigoplus_{\substack{\mu + L \in N'/L \\ (k, \lambda_i + \lambda_j + \mu) \in S}} N(C)_{(i, \lambda_i)(j, \lambda_j)}^{(k, \lambda_i + \lambda_j + \mu)} M^{-\mu} \boxtimes_V M_k. \end{aligned}$$

Proof. First we prove $N(C)_{(i, \mu_i)(j, \mu_j)}^{(k, \mu_i + \mu_j)} = N(V)_{ij}^k$ using the following natural maps between spaces of intertwining operators:

$$\begin{aligned} \mathcal{Y}_C \left(\begin{array}{c} M_{k, \mu_i + \mu_j} \\ M_{i, \mu_i} M_{j, \mu_j} \end{array} \right) &\xrightarrow{\cong} \mathcal{Y}_{V_L \otimes C} \left(\begin{array}{c} V_{\mu_i + \mu_j + L} \otimes M_{k, \mu_i + \mu_j} \\ V_{\mu_i + L} \otimes M_{i, \mu_i} \quad V_{\mu_j + L} \otimes M_{j, \mu_j} \end{array} \right) \\ &\xrightarrow{\cong} \text{Hom}_{V_L \otimes C} \left((V_{\mu_i + L} \otimes M_{i, \mu_i}) \boxtimes_{V_L \otimes C} (V_{\mu_j + L} \otimes M_{j, \mu_j}), V_{\mu_i + \mu_j + L} \otimes M_{k, \mu_i + \mu_j} \right) \\ &\xrightarrow{\mathcal{F}} \text{Hom}_V \left(\mathcal{F}((V_{\mu_i + L} \otimes M_{i, \mu_i}) \boxtimes_{V_L \otimes C} (V_{\mu_j + L} \otimes M_{j, \mu_j})), \mathcal{F}(V_{\mu_i + \mu_j + L} \otimes M_{k, \mu_i + \mu_j}) \right) \\ &\xrightarrow{\cong} \text{Hom}_V \left(\mathcal{F}(V_{\mu_i + L} \otimes M_{i, \mu_i}) \boxtimes_V \mathcal{F}(V_{\mu_j + L} \otimes M_{j, \mu_j}), \mathcal{F}(V_{\mu_i + \mu_j + L} \otimes M_{k, \mu_i + \mu_j}) \right) \\ &\xrightarrow{\cong} \text{Hom}_V (M_i \boxtimes_V M_j, M_k) \xrightarrow{\cong} \mathcal{Y}_V \left(\begin{array}{c} M_k \\ M_i M_j \end{array} \right) \end{aligned} \quad (4.25)$$

The first map is a bijection by [ADL, Theorem 2.10]. Since all spaces of intertwining operators here are finite dimensional (we are working in a C_2 -cofinite setting), it suffices to give an injection in the reverse direction. By analyzing Heisenberg weights, any non-zero intertwining operator in $\mathcal{Y}_V \left(\begin{array}{c} M_k \\ M_i M_j \end{array} \right)$ when restricted to $(V_{\mu_i + L} \otimes M_{k, \mu_i}) \otimes (V_{\mu_j + L} \otimes M_{k, \mu_j})$ must have coefficients in $V_{\mu_i + \mu_j + L} \otimes M_{k, \mu_i + \mu_j}$. Since M_i and M_j are simple V -modules, [DL, Proposition 11.9] implies that the restriction $\mathcal{Y}_V \left(\begin{array}{c} M_k \\ M_i M_j \end{array} \right) \rightarrow \mathcal{Y}_{V_L \otimes C} \left(\begin{array}{c} V_{\mu_i + \mu_j + L} \otimes M_{k, \mu_i + \mu_j} \\ V_{\mu_i + L} \otimes M_{i, \mu_i} \quad V_{\mu_j + L} \otimes M_{j, \mu_j} \end{array} \right)$ is an injection. Now, $\mathcal{Y}_C \left(\begin{array}{c} M_{k, \mu_k} \\ M_{i, \mu_i} M_{j, \mu_j} \end{array} \right) = 0$ unless $M_{k, \mu_k} \cong M_{k', \mu_i + \mu_j}$ for some k' using the composition of the first three injections in (4.25) (with $\mu_i + \mu_j$ replaced by μ_k in C -modules but not in V_L -modules), the observation (4.22), and Theorem 4.40. Moreover, the modules $M_{k, \mu_i + \mu_j}$ for $0 \leq k \leq n$ are distinct by Theorem 4.40. This gives the first conclusion of the theorem.

For the second statement,

$$\begin{aligned} M_i \boxtimes_V M_j &\cong \mathcal{F}(V_{\lambda_i + L} \otimes M_{i, \lambda_i}) \boxtimes_V \mathcal{F}(V_{\lambda_j + L} \otimes M_{j, \lambda_j}) \\ &\cong \mathcal{F}((V_{\lambda_i + L} \otimes M_{i, \lambda_i}) \boxtimes_{V_L \otimes C} (V_{\lambda_j + L} \otimes M_{j, \lambda_j})) \\ &\cong \bigoplus_{\lambda + L \in L'/L, (k, \nu) \in S} N(V_L \otimes C)_{V_{\lambda_i + L} \otimes M_{i, \lambda_i}, V_{\lambda_j + L} \otimes M_{j, \lambda_j}}^{V_{\lambda + L} \otimes M_{k, \nu}} \mathcal{F}(V_{\lambda + L} \otimes M_{k, \nu}) \\ &\cong \bigoplus_{\lambda + L \in L'/L, (k, \nu) \in S} N(V_L)_{V_{\lambda_i + L} V_{\lambda_j + L}}^{V_{\lambda + L}} N(C)_{(i, \lambda_i)(j, \lambda_j)}^{(k, \nu)} \mathcal{F}(V_{\lambda + L} \otimes M_{k, \nu}) \\ &\cong \bigoplus_{(k, \nu) \in S} N(C)_{(i, \lambda_i)(j, \lambda_j)}^{(k, \nu)} \mathcal{F}(V_{\lambda_i + \lambda_j + L} \otimes M_{k, \nu}). \end{aligned}$$

The module on the left side is in $\text{Rep}^0 V$, but from (4.22), $\mathcal{F}(V_{\lambda_i+\lambda_j+L} \otimes M_{k,\nu})$ is not in $\text{Rep}^0 V$ unless $\nu - \lambda_i - \lambda_j \in N'$. Thus

$$\begin{aligned} M_i \boxtimes_V M_j &\cong \bigoplus_{(k,\nu) \in S} N(C)_{(i,\lambda_i)(j,\lambda_j)}^{(k,\nu)} \mathcal{F}(V_{\lambda_i+\lambda_j+L} \otimes M_{k,\nu}) \\ &\cong \bigoplus_{\substack{\mu+L \in N'/L, \\ (k,\lambda_i+\lambda_j+\mu) \in S}} N(C)_{(i,\lambda_i)(j,\lambda_j)}^{(k,\lambda_i+\lambda_j+\mu)} \mathcal{F}(V_{\lambda_i+\lambda_j+L} \otimes M_{k,\lambda_i+\lambda_j+\mu}) \\ &\cong \bigoplus_{\substack{\mu+L \in N'/L, \\ (k,\lambda_i+\lambda_j+\mu) \in S}} N(C)_{(i,\lambda_i)(j,\lambda_j)}^{(k,\lambda_i+\lambda_j+\mu)} M^{-\mu} \boxtimes_V M_k \end{aligned}$$

as desired \square

For Heisenberg cosets of affine Lie algebra vertex operator algebras at positive integral levels, these results have appeared previously in [DLWY, DR, DW3, ADJR].

4.3.3 Modular transformations and characters

A V -module M_i is graded by conformal weights as well as the lattice L' :

$$M_i = \bigoplus_{\substack{n \in h_i + \mathbb{Z} \\ \lambda \in L'}} M_{n,\lambda}.$$

The character of M_i can be refined to a component of a vector-valued Jacobi form by

$$\text{ch}[M_i](u, \tau) := q^{-\frac{c_V}{24}} \sum_{\substack{n \in h_i + \mathbb{Z} \\ \lambda \in L'}} \dim(M_{n,\lambda}) q^n z^\lambda$$

with $q = e^{2\pi i \tau}$ as usual and $z^\lambda := e^{2\pi i \langle u, \lambda \rangle}$ for u in the complexification of L' and $\langle \cdot, \cdot \rangle$ the bilinear form of L' . Modularity in this setting is due to [KM] while the modularity of ordinary traces as for example those of C -modules is the famous result of Zhu [Zh].

We thus define the modular S - and T -matrices as follows:

$$\text{ch}[M_i](u, \tau + 1) = T_i^{X,V} \text{ch}[M_i](u, \tau) \quad \text{and} \quad \text{ch}[M_i]\left(\frac{u}{\tau}, -\frac{1}{\tau}\right) = e^{\pi \frac{u^2}{\tau}} \sum_{j=0}^n S_{i,j}^{X,V} \text{ch}[M_j](u, \tau),$$

as well as

$$\text{ch}[M_{i,\nu_i}](\tau + 1) = T_{i,\nu_i}^{X,C} \text{ch}[M_{i,\nu_i}](\tau), \quad \text{and} \quad \text{ch}[M_{i,\nu_i}]\left(-\frac{1}{\tau}\right) = \sum_{(j,\nu_j) \in S} S_{(i,\nu_i),(j,\nu_j)}^{X,C} \text{ch}[M_{(j,\nu_j)}](\tau).$$

Theorem 4.43. *The modular S - and T -matrices are related as follows:*

$$T_i^{X,V} = e^{\pi i \left(\langle \nu_i, \nu_i \rangle - \frac{\text{rank}(L)}{12} \right)} T_{i,\nu_i}^{X,C} \quad \text{and} \quad S_{i,j}^{X,V} = e^{2\pi i \langle \nu_i, \nu_j \rangle} \frac{|N/L|}{\sqrt{|L'/L|}} S_{(i,\nu_i),(j,\nu_j)}^{X,C}.$$

Proof. The T -matrix relation follows from the definitions, the fact that induction preserves twists and hence conformal dimensions mod \mathbb{Z} , and the fact that central charges satisfy $c_V = c_{V_L \otimes C} = \text{rank}(L) + c_C$.

For the S -matrix statement, Theorem 2.89 shows that for modules $\mathcal{F}(B), \mathcal{F}(C)$ in $\text{Rep}^0 V$,

$$S_{\mathcal{F}(B), \mathcal{F}(C)}^\infty = \mathcal{F}(S_{B,C}^\infty)$$

where the left side is the Hopf link in $\text{Rep}^0 V$ and the right side is the Hopf link in \mathcal{C} , the category of $V_L \otimes C$ -modules. The modular and categorical S -matrices are proportional [Hu7, Theorem 4.5], with proportionality constant the dimension $D(\mathcal{C})$ of the category, that is,

$$S^X = \frac{1}{D(\mathcal{C})} S^\infty.$$

[KO, Theorem 4.5] shows that $\text{Rep}^0 V$ is a modular tensor category and that

$$D(\text{Rep}^0 V) = D(\mathcal{C}) / \text{qdim}_{\mathcal{C}}(V).$$

Note that [HKL, Theorem 3.4] and our main result, Theorem 3.65, show that $\text{Rep}^0 V$ is precisely the modular vertex tensor category of untwisted modules for the regular vertex operator algebra V .

Next, the dimensions of all simple currents appearing in a vertex operator algebra extension of correct statistics are 1. Indeed, fix such a simple current, say J . Then, $\theta_J = 1_J$ and moreover, skew-symmetry considerations coupled with (3.14) show that $\mathcal{R}_{J,J} = 1_{J \boxtimes J}$. Now, the spin statistics theorem ([CKL], [EGNO, Exercise 8.10.15]) shows that $\text{qdim}(J) = 1$. We therefore have $\text{qdim}_{\mathcal{C}}(V) = |N/L|$, since qdim is additive over direct sums.

Finally, we have:

$$\begin{aligned} S_{i,j}^{\mathcal{X},V} &= \frac{1}{D(\text{Rep}^0 V)} S_{i,j}^{\infty} = \frac{\text{qdim}_{\mathcal{C}}(V)}{D(\mathcal{C})} S_{i,j}^{\infty} = \frac{|N/L|}{D(\mathcal{C})} S_{i,j}^{\infty} = \frac{|N/L|}{D(\mathcal{C})} S_{\nu_i+L \otimes M_{(i,\nu_i)}, \nu_j+L \otimes M_{(j,\nu_j)}}^{\infty} \\ &= |N/L| \cdot S_{\nu_i+L \otimes M_{(i,\nu_i)}, \nu_j+L \otimes M_{(j,\nu_j)}}^{\mathcal{X},V} = |N/L| \cdot S_{\nu_i+L, \nu_j+L}^{\mathcal{X},V_L} \cdot S_{(i,\nu_i), (j,\nu_j)}^{\mathcal{X},C} \\ &= |N/L| \cdot \frac{e^{2\pi i(\nu_i, \nu_j)}}{\sqrt{|L'/L|}} \cdot S_{(i,\nu_i), (j,\nu_j)}^{\mathcal{X},C}. \end{aligned}$$

Note that $S_{\nu_i+L, \nu_j+L}^{\mathcal{X},V_L}$ can be calculated as follows. First, $S_{\nu_i+L, \nu_j+L}^{\infty, V_L} = e^{2\pi i(\nu_i, \nu_j)}$ by calculating monodromies. Then by [Hu7, Theorem 4.5], this differs from $S_{\nu_i+L, \nu_j+L}^{\mathcal{X}, V_L}$ only by a proportionality constant which we can calculate using well-known modularity properties of lattice theta functions. \square

Finally let us compute the relation of the associated characters.

Theorem 4.44. *Characters are related as follows:*

$$\text{ch}[M_i](u, \tau) = \sum_{\nu+L \in N/L} \frac{\theta_{\lambda_i+\nu+L}(u, \tau)}{\eta(\tau)^{\text{rank}(L)}} \text{ch}[M_{i, \lambda_i+\nu}](\tau)$$

and

$$\text{ch}[M_{i, \nu_i}](\tau) = \frac{\eta(\tau)^{\text{rank}(L)}}{|L'/L| \theta_{\nu_i+L}(0, \tau)} \sum_{\gamma+L \in L'/L} e^{-2\pi i(\nu_i, \gamma)} \text{ch}[M_i](\gamma, \tau)$$

Proof. The first statement is just the character version of the module decomposition. For the second, we use

$$\theta_{\lambda+L}(u + \gamma, \tau) = e^{2\pi i(\gamma, \lambda)} \theta_{\lambda+L}(u, \tau)$$

together with the orthogonality relations for irreducible characters of L'/L ,

$$\sum_{\gamma+L \in L'/L} e^{2\pi i(\gamma, \mu-\lambda)} = |L'/L| \delta_{\mu+L, \lambda+L}$$

for $\mu+L, \lambda+L \in L'/L$, so that we get the projection

$$\delta_{\mu+L, \lambda+L} \theta_{\lambda+L}(u, \tau) = \frac{1}{|L'/L|} \sum_{\gamma+L \in L'/L} e^{-2\pi i(\gamma, \lambda)} \theta_{\mu+L}(u + \gamma, \tau).$$

Then we calculate using the first statement of the theorem:

$$\begin{aligned} &\frac{1}{|L'/L|} \sum_{\gamma+L \in L'/L} e^{-2\pi i(\nu_i, \gamma)} \text{ch}[M_i](u + \gamma, \tau) \\ &= \frac{1}{|L'/L|} \sum_{\gamma+L \in L'/L} \sum_{\nu+L \in N/L} e^{-2\pi i(\nu_i, \gamma)} \frac{\theta_{\nu_i+\nu+L}(u + \gamma, \tau)}{\eta(\tau)^{\text{rank}(L)}} \text{ch}[M_{i, \nu_i+\nu}](\tau) \\ &= \sum_{\nu+L \in N/L} \delta_{\nu_i+\nu+L, \nu_i+L} \frac{\theta_{\nu_i+L}(u, \tau)}{\eta(\tau)^{\text{rank}(L)}} \text{ch}[M_{i, \nu_i+\nu}](\tau) = \frac{\theta_{\nu_i+L}(u, \tau)}{\eta(\tau)^{\text{rank}(L)}} \text{ch}[M_{i, \nu_i}](\tau). \end{aligned}$$

Setting $u = 0$ yields the second conclusion of the theorem. \square

4.3.4 Solving the coset problem

The above results give a precise way to understand C if V is sufficiently well understood:

1. Start with a simple, rational, C_2 -cofinite vertex operator algebra V that contains a lattice vertex operator algebra V_L where L is positive definite and even. Prove that V_L is maximal or find the maximal extension of V_L contained in V .
2. Decompose V as a $V_L \otimes C$ -module:

$$V = \bigoplus_{\mu+L \in N/L} V_{\mu+L} \otimes M_{0,\mu}.$$

This can be done on the level of characters since Jacobi theta functions of lattices are linearly independent. This determines N and hence N' .

3. We have shown that there are certain simple current V -modules M^μ for $\mu \in N'/L$ which form an abelian intertwining algebra of type N'/L . These determine the set S of inequivalent simple C -modules: all we need to know are the fusion rules of the M^μ with any of the M_i .
4. Get characters, fusion rules, and S - and T -matrices using the above theorems.

The only subtlety arising here is that fixed points of the M^μ make enumeration of the inequivalent simple C -modules more technical. When V is a simple affine vertex operator algebra, N'/L is given by spectral flow (automorphisms coming from affine Weyl translations) which gives explicit character relations, so this is actually verifiable on the level of characters.

4.3.5 Solving the inverse coset problem

Now assume that C is sufficiently well understood. Can we reconstruct V ? This question actually fits very well in a program one of us has developed together with A. Linshaw [CL1, CL2]. In [CL2], we found minimal strong generating sets of families of coset vertex operator algebras C_k inside larger structures A_k . If the strong generator type coincides with the one of a known W -algebra, then one might ask if they are isomorphic. In practice, there will be special values of the deformation parameter k for which A_k is believed to be interesting, for example admissible levels of W -algebras [KW2, Ar1]. In this case a strategy might be to find the coset, and use its properties to deduce properties of V :

1. Suppose we have a vertex operator algebra V and we believe (or might even know) that V_L and C form a commuting pair inside V . Then use [CKLR] to find a lattice $N \supseteq L$ such that

$$\bigoplus_{\mu+L \in N/L} V_{\mu+L} \otimes C_\mu$$

is a vertex operator algebra. Here the C_μ must be simple current C -modules that give rise to an abelian intertwining algebra of type N/L . There are usually very few choices for that which means there are few possibilities for N .

2. Prove that

$$V \cong \bigoplus_{\mu+L \in N/L} V_{\mu+L} \otimes C_\mu.$$

The strategy is to prove that the operator product algebra of a given type is unique and hence both sides are homomorphic images of the same vertex operator algebra and hence are isomorphic if both of them are simple. This strategy is feasible in many cases and has been successfully applied in the setting of minimal W -algebras, [ACL1, ACKL]. It would be nice to extend this further, as for example settling [CKL, Conjecture 4.3].

3. Use our results, that is, induction, to determine all V -modules and compute their fusion rules and modular properties as above. Recall from Remark 4.38 that simple V -modules are isomorphic if and only if they are isomorphic as $V_L \otimes C$ -modules.

This inverse coset construction has now been efficiently applied to understand the representation theory of the simple affine vertex operator superalgebra $L_k(\mathfrak{osp}(1|2))$ at positive integer level k as an extension of $L_k(\mathfrak{sl}_2) \otimes \text{Vir}(k+2, 2k+3)$ [CFK]. Further examples of understanding more subtle affine vertex operator superalgebras via the inverse coset construction are under investigation.

4.4 Coset theories: Examples

In this subsection we use the theory and results of previous sections to study the representations of some regular vertex operator (super)algebras arising as lattice cosets. The examples presented here illustrate how induction can be used to solve both coset and inverse coset problems.

4.4.1 Type A parafermion algebras

Parafermion algebras are cosets of Heisenberg (equivalently, lattice) vertex subalgebras of affine vertex operator algebras. They first appeared in [LW, DLe] and have received attention in number theory due to their connection with integer partitions [LW]. As they have been treated in many fairly recent works [ALY, DLY, DLWY, DR, DW1, DW2, DW3], we will not derive new results here. However, these algebras nicely illustrate the efficiency of the theory of vertex operator algebra extensions. We focus on parafermion algebras of type A .

Fix $n \geq 1$ and consider the simple affine vertex operator algebra $L_k(\mathfrak{sl}_{n+1})$ of type A_n at positive integer level k . The Cartan subalgebra of \mathfrak{sl}_{n+1} , embedded into the conformal weight-1 subspace of $L_k(\mathfrak{sl}_{n+1})$, generates a Heisenberg vertex subalgebra with different conformal vector. The maximal lattice vertex subalgebra of $L_k(\mathfrak{sl}_{n+1})$ extending this Heisenberg algebra is V_L for $L = \sqrt{k}A_n$, and the parafermion algebra is then defined to be the coset $C = \text{Com}(V_L, L_k(\mathfrak{sl}_{n+1}))$. The lattice determining the decomposition of $L_k(\mathfrak{sl}_{n+1})$ as a $V_L \otimes C$ -module is $N = \frac{1}{\sqrt{k}}A_n$.

The inequivalent simple $L_k(\mathfrak{sl}_{n+1})$ -modules are the simple highest-weight $\widehat{\mathfrak{sl}}_{n+1}$ -modules $L(\Lambda)$ of highest weight $\Lambda = \lambda_0\omega_0 + \cdots + \lambda_n\omega_n$, where the ω_i are the fundamental weights of $\widehat{\mathfrak{sl}}_{n+1}$ and $\lambda_0 + \cdots + \lambda_n = k$; we denote the set of such weights by P_k^+ . Recall from (4.23) that $L_k(\mathfrak{sl}_{n+1})$ has simple currents parametrized by cosets in

$$N'/L = \sqrt{k}A'_n/\sqrt{k}A_n \cong A'_n/A_n \cong \mathbb{Z}/(n+1)\mathbb{Z}.$$

Thus these must be all $n+1$ of the simple current $L_k(\mathfrak{sl}_{n+1})$ -modules classified in [Fu]: they are the modules $L(k\omega_i)$, $0 \leq i \leq n$, with fusion rules

$$L(k\omega_i) \boxtimes L(k\omega_j) = L(k\omega_{\overline{i+j}}), \quad \overline{i+j} = \begin{cases} i+j & \text{if } i+j \leq k \\ i+j-k & \text{else} \end{cases}$$

and action on simple modules given by

$$L(k\omega_j) \boxtimes L(\Lambda) = L(s_j(\Lambda))$$

where the s_j cyclically permute the fundamental weights, that is, $s_j(\omega_i) = \omega_{\overline{i+j}}$. This is the same as addition of weight modulo kA_n .

Now given $\Lambda = \lambda_0\omega_0 + \cdots + \lambda_n\omega_n \in P_k^+$, let $\bar{\Lambda} = \frac{1}{\sqrt{k}}(\lambda_1\omega_1 + \cdots + \lambda_n\omega_n) \in L'$. Recalling (4.21), simple modules of the parafermion coset are labeled $M_{\bar{\Lambda}, \Gamma}$ for $\Lambda \in P_k^+$, $\Gamma + L \in L'/L$, with the condition that $\bar{\Lambda} - \Gamma \in N/L = \frac{1}{\sqrt{k}}A_n/\sqrt{k}A_n$. Further, by Theorem 4.40,

$$M_{\bar{\Lambda}, \Gamma} \cong M_{\bar{\Lambda}', \Gamma'} \quad \text{if and only if there exists } 0 \leq j \leq n \text{ such that } \Lambda' = s_j(\Lambda) \text{ and } \Gamma' = \Gamma + \sqrt{k}\omega_j. \quad (4.26)$$

Fusion rules for $L_k(\mathfrak{sl}_{n+1})$ -modules can in principal be computed using Verlinde's formula, but the combinatorics is involved. For A_1 and A_2 explicit formulae are known (see for instance [dFMS, BSVW]). For A_1 , $P_k^+ = \{((k-i)\omega_0 + i\omega_1) \mid 0 \leq i \leq k\}$, and abbreviating $(k-i)\omega_0 + i\omega_1$ by $\pi(k, i)$, we have

$$L_{s_{12}}(\pi(k, i)) \boxtimes L_{s_{12}}(\pi(k, j)) = \sum_{\substack{|i-j| \leq t \leq \min(i+j, 2k-i-j) \\ i+j+t \equiv 0 \pmod{2}}} L_{s_{12}}(\pi(k, t)).$$

Therefore, from Theorem 4.42, we precisely recover the fusion rules of [DW3]: for $\nu_i + L, \nu_j + L \in N/L$,

$$M_{\overline{\pi(k, i)}, \overline{\pi(k, i)} + \nu_i} \boxtimes_C M_{\overline{\pi(k, j)}, \overline{\pi(k, j)} + \nu_j} = \bigoplus_{\substack{|i-j| \leq t \leq \min(i+j, 2k-i-j) \\ i+j+t \equiv 0 \pmod{2}}} M_{\overline{\pi(k, t)}, \overline{\pi(k, i)} + \overline{\pi(k, j)} + \nu_i + \nu_j}.$$

Note that when $i+j+t$ is even, $\overline{\pi(k, t)} - \overline{\pi(k, i)} - \overline{\pi(k, j)} \in N$, so every summand is well-defined. Also, from (4.26), it is clear that the summands are mutually inequivalent.

Type A_1 parafermion characters can be read off from Theorem 4.44, and modular character transformations from Theorem 4.43. The T -matrix is easy:

$$T_{M_{\overline{\pi(k,a)}, \overline{\pi(k,a)+\nu}}^{\chi,C}} = \exp\left(-\pi i \left\langle \overline{\pi(k,a)} + \nu, \overline{\pi(k,a)} + \nu \right\rangle + \frac{\pi i}{12} + 2\pi i \left(\frac{a(a+2)}{4(k+2)} - \frac{k}{8(k+2)} \right)\right)$$

For the S -matrix, for brevity, set

$$W_a = M_{\overline{\pi(k,a)}, \overline{\pi(k,a)+\nu_a}}, \quad W_b = M_{\overline{\pi(k,b)}, \overline{\pi(k,b)+\nu_b}},$$

where $\nu_a + L, \nu_b + L \in N/L$. Then,

$$S_{W_a, W_b}^{\chi,C} = \sqrt{\frac{2}{k}} \cdot \sqrt{\frac{2}{k+2}} \cdot \sin\left(\frac{\pi(a+1)(b+1)}{k+2}\right) \cdot \exp\left(-2\pi i \left\langle \overline{\pi(k,a)} + \nu_a, \overline{\pi(k,b)} + \nu_b \right\rangle\right).$$

Remark 4.45. It is reasonable to conjecture that the category of admissible-level $L_k(\mathfrak{sl}_2)$ -modules as stated in [CRi3, AM1] has the structure of a vertex tensor category. If this is true, then one can also study the parafermion cosets of admissible-level affine vertex operator algebras in a manner very similar to the rational case. This is interesting since these parafermion cosets allow for large extensions that are conjecturally C_2 -cofinite but not rational [ACR].

4.4.2 Rational $N = 2$ superconformal algebras \mathcal{L}_k

In this section, we discuss a family of vertex operator superalgebras of correct statistics: the rational $N = 2$ superconformal algebras. They are important in superstring theory, where the chiral algebra of the underlying conformal field theory must be the $N = 2$ superconformal algebra or an extension. Thus they appeared in the physics literature already in the 1980s; see for example [DPZ]. In the mathematics literature, modules were classified in [Ad1] and fusion rules in [Ad2, Wa2]; we rederive these results here. Interesting results are also possible beyond rationality [Sa].

Fix a positive integer level k ; the $N = 2$ superconformal algebra \mathcal{L}_k is rational at such levels with central charge $c = 3k/(k+2)$. Although \mathcal{L}_k is normally defined as a vertex operator superalgebra structure on the simple level- k vacuum module for the $N = 2$ superconformal Lie superalgebra (see for example [Ad1, Section 1]), we shall here use a lattice coset realization of \mathcal{L}_k due to [CL2]. To begin, we need to introduce some lattices, using notation as in [CKLR, CL2]:

$$L_\alpha = \mathbb{Z}\alpha, \quad L_\beta = \mathbb{Z}\beta, \quad L_\gamma = \mathbb{Z}\gamma, \quad L_\mu = \mathbb{Z}\mu$$

with

$$\alpha^2 = 2k, \quad \beta^2 = 4, \quad \alpha\beta = 0, \quad \gamma = \alpha + \frac{k}{2} \cdot \beta, \quad \mu = \alpha - \beta$$

so that

$$\begin{aligned} \mu^2 &= 2(k+2), & \gamma^2 &= k(k+2), & \gamma\mu &= 0, \\ \alpha &= \frac{2}{k+2}\gamma + \frac{k}{k+2}\mu, & \beta &= \frac{2}{k+2}\gamma - \frac{2}{k+2}\mu. \end{aligned}$$

Let $a\alpha + b\beta$ in $L'_\alpha \oplus L'_\beta$, which implies that $a \in \frac{1}{2k}\mathbb{Z}$, $b \in \frac{1}{4}\mathbb{Z}$. We have

$$a\alpha + b\beta = \frac{ka - 2b}{k+2}\mu + \frac{2(a+b)}{k+2}\gamma \in L'_\mu \oplus \frac{1}{2}L'_\gamma. \quad (4.27)$$

Now we can present the coset realization of \mathcal{L}_k from [CL2]:

$$\mathcal{L}_k = \text{Com}\left(V_{L_\mu}, L_k(\mathfrak{sl}_2) \otimes V_{L_{\frac{1}{2}\beta}}\right),$$

and the even vertex operator subalgebra of \mathcal{L}_k is

$$\mathcal{L}_k^{\bar{0}} = \text{Com}\left(V_{L_\mu}, L_k(\mathfrak{sl}_2) \otimes V_{L_\beta}\right).$$

Our strategy is to first understand $\mathcal{L}_k^{\bar{0}}$ -modules and then induce to \mathcal{L}_k .

Recall from the preceding parafermion example that V_{L_α} is a vertex subalgebra of $L_k(\mathfrak{sl}_2)$, and the V_{L_α} -modules appearing in the decomposition of $L_k(\mathfrak{sl}_2)$ are exactly $V_{\frac{n}{k}\alpha+L_\alpha}$ for $n = 0, 1, \dots, k-1$. It follows from (4.27) that $V_{\nu+L_\mu}$ is a submodule of $L_k(\mathfrak{sl}_2) \otimes V_{L_\beta}$ if and only if $\nu+L \in N/L_\mu$ with $N = 2L'_\mu$. Further, we have $N' = \frac{1}{2}L_\mu$ so L_μ has index two in N' . Denote by ω_0, ω_1 the fundamental weights of $\widehat{\mathfrak{sl}}_2$ so that the simple $L_k(\mathfrak{sl}_2)$ -modules are precisely the integrable highest-weight modules $L(\lambda)$ with highest weight $(k-\lambda)\omega_0 + \lambda\omega_1$ for $\lambda \in \{0, 1, \dots, k\}$. Using (4.27) it follows that for $b \in \mathbb{Z}$, $V_{\nu+L_\mu}$ is a submodule of $L(\lambda) \otimes V_{\frac{b}{4}\beta+L_\beta}$ if and only if $\nu - \frac{\lambda-b}{2(k+2)}\mu \in N$ so that we get

$$L(\lambda) \otimes V_{\frac{b}{4}\beta+L_\beta} \cong \bigoplus_{\nu - \frac{\lambda-b}{2(k+2)}\mu + L_\mu \in N/L_\mu} V_{\nu+L_\mu} \otimes M(\lambda, b, \nu) \quad (4.28)$$

as $V_{L_\mu} \otimes \mathcal{L}_k^{\bar{0}}$ -modules and further, all $M(\lambda, b, \nu)$ are simple $\mathcal{L}_k^{\bar{0}}$ -modules and every simple $\mathcal{L}_k^{\bar{0}}$ -module is isomorphic to exactly two of these since $|N'/L_\mu|=2$ (see Theorem 4.40 and Corollary 4.41). It remains to identify those that are isomorphic. The order-2 simple current of $L_k(\mathfrak{sl}_2) \otimes V_{L_\beta}$ that identifies isomorphic $\mathcal{L}_k^{\bar{0}}$ -modules is

$$M^{\frac{1}{2}\mu} = \mathcal{F}(V_{\frac{1}{2}\mu+L_\mu} \otimes \mathcal{L}_k^{\bar{0}}) = \bigoplus_{\nu+L_\mu \in N/L_\mu} V_{\frac{1}{2}\mu+\nu+L_\mu} \otimes M(0, 0, \nu) \cong L(\lambda) \otimes V_{\frac{b}{4}\beta+L_\beta}$$

for some $\lambda \in \{0, 1, \dots, k\}$ and $b \in \{0, 1, 2, 3\}$. Since $L(\lambda) \otimes V_{\frac{b}{4}\beta+L_\beta}$ is a direct sum of the $V_{L_\alpha} \otimes V_{L_\beta}$ -modules $V_{(\frac{\lambda}{2k} + \frac{n}{k})\alpha+L_\alpha} \otimes V_{\frac{b}{4}\beta+L_\beta}$ for $0 \leq n \leq k-1$ and since $\frac{1}{2}\mu = \frac{1}{2}\alpha - \frac{1}{2}\beta$, we have

$$\left(\frac{1}{2} - \frac{\lambda}{2k} - \frac{n}{k}\right)\alpha \in L_\alpha \quad \text{and} \quad \left(-\frac{1}{2} - \frac{b}{4}\right)\beta \in L_\beta.$$

From this it follows that $\lambda = k$ and $b = 2$, that is,

$$M^{\frac{1}{2}\mu} \cong L(k) \otimes V_{\frac{1}{2}\beta+L_\beta}.$$

Then from Theorem 4.40 we get

$$M(\lambda, b, \nu) \cong M(\lambda', b', \nu') \quad \text{if and only if} \quad \lambda' = k - \lambda, \quad \nu' \equiv \nu + \frac{1}{2}\mu \pmod{L_\mu}, \quad b' \equiv b + 2 \pmod{4}. \quad (4.29)$$

Fusion rules and modular character transformations of these modules now follow from Theorems 4.42, 4.43, and 4.44. Namely,

$$\begin{aligned} M(\lambda, b, \nu) \boxtimes_{\mathcal{L}_k^{\bar{0}}} M(\lambda', b', \nu') &\cong \bigoplus_{0 \leq \lambda'' \leq k} (N^{\mathfrak{sl}_2})_{\lambda, \lambda'}^{\lambda''} M(\lambda'', b + b', \nu + \nu') \\ &\cong \bigoplus_{\substack{|\lambda - \lambda'| \leq \lambda'' \leq \min(\lambda + \lambda', 2k - \lambda - \lambda') \\ \lambda + \lambda' + \lambda'' \equiv 0 \pmod{2}}} M(\lambda'', b + b', \nu + \nu'), \end{aligned}$$

In this decomposition, the summands are pairwise inequivalent. Now we calculate the characters and modular data. Let $0 \leq \lambda, \lambda' \leq k$, $b, b' \in \mathbb{Z}/4\mathbb{Z}$ and $\nu, \nu' \in L'_\mu/L_\mu$. Using Theorem 4.43 we have:

$$\begin{aligned} T_{M(\lambda, b, \nu)}^X &= \exp\left(2\pi i \left(\frac{\lambda(\lambda+2)}{4(k+2)} + \frac{b^2}{8} - \frac{1}{2}\langle \nu, \nu \rangle - \frac{k}{8(k+2)}\right)\right), \quad (4.30) \\ S_{M(\lambda, b, \nu), M(\lambda', b', \nu')}^X &= \frac{\sqrt{|L'_\mu/L_\mu|}}{|N/L_\mu|} \cdot \exp(-2\pi i \langle \nu, \nu' \rangle) \cdot S_{\lambda, \lambda'}^{X, L_k(\mathfrak{sl}_2)} \cdot S_{V_{b\beta/4+L_\beta}, V_{b'\beta/4+L_\beta}}^{X, V_{L_\beta}} \\ &= \frac{2}{k+2} \cdot \exp(-2\pi i \langle \nu, \nu' \rangle) \cdot \sin\left(\frac{\pi(\lambda+1)(\lambda'+1)}{k+2}\right) \cdot \frac{1}{2} \exp\left(\pi i \frac{bb'}{2}\right) \\ &= \frac{1}{k+2} \cdot \sin\left(\frac{\pi(\lambda+1)(\lambda'+1)}{k+2}\right) \cdot \exp\left(2\pi i \left(\frac{bb'}{4} - \langle \nu, \nu' \rangle\right)\right) \quad (4.31) \end{aligned}$$

From Theorem 4.44 and (4.28), we have the following characters (with the Jacobi variable u denoting the Heisenberg weights corresponding to V_{L_μ}):

$$\text{ch}[L(\lambda) \otimes V_{\frac{b}{4}\beta+L_\beta}](u, \tau) = \sum_{\nu+L_\mu \in N/L_\mu} \frac{\theta_{\frac{\lambda-b}{2(k+2)}\mu+\nu+L_\mu}(u, \tau)}{\eta(\tau)} \text{ch}\left[M\left(\lambda, b, \frac{\lambda-b}{2(k+2)}\mu + \nu\right)\right](\tau)$$

$$\text{ch}[M(\lambda, b, \nu)](\tau) = \frac{\eta(\tau)}{2(k+2) \cdot \theta_{\nu+L_\mu}(0, \tau)} \sum_{\gamma+L_\mu \in L'_\mu/L_\mu} e^{-2\pi i(\nu, \gamma)} \text{ch}[L(\lambda) \otimes V_{\frac{b}{4}\beta+L_\beta}](\gamma, \tau).$$

We can now study modules for the vertex operator superalgebra \mathcal{L}_k via induction by viewing \mathcal{L}_k as a superalgebra in the representation category of $\mathcal{L}_k^{\bar{0}}$. In particular, induction yields a classification of untwisted and twisted simple \mathcal{L}_k -modules, as well as fusion rules. We also get S -transformations for (super)characters of simple \mathcal{L}_k -modules as in Section 4.2.4.

From the fusion coefficients, S - and T -matrices, or otherwise, it is clear that $J = M(0, 2, 0)$ is a simple current for $\mathcal{L}_k^{\bar{0}} = M(0, 0, 0)$ such that $\theta_J = -1_J$ and $\text{qdim}(J) = 1$. Therefore, $\mathcal{L}_k = M(0, 0, 0) \oplus M(0, 2, 0)$ is a $\frac{1}{2}\mathbb{Z}$ -graded vertex operator superalgebra with even part graded by \mathbb{Z} and odd part graded by $\frac{1}{2} + \mathbb{Z}$, that is, \mathcal{L}_k is a vertex operator superalgebra of correct statistics. Further, the fusion of the simple current $M(0, 2, 0)$ is

$$M(0, 2, 0) \boxtimes_{\mathcal{L}_k^{\bar{0}}} M(\lambda, b, \nu) \cong M(\lambda, b+2, \nu)$$

so that the induced modules are

$$\mathcal{F}(M(\lambda, b, \nu)) = M(\lambda, b, \nu) \oplus M(\lambda, b+2, \nu).$$

From (4.29) we conclude that $M(\lambda, b, \nu) \cong M(\lambda, b+2, \nu)$ is impossible since $0 \not\equiv \frac{1}{2}\mu \pmod{L_\mu}$. This implies that there are no twisted modules of fixed-point type, so by Proposition 4.5, each induced module is simple, and moreover every simple \mathcal{L}_k -module is induced from a simple $\mathcal{L}_k^{\bar{0}}$ -module. It is easy to decide whether induced modules are twisted or untwisted using the twist, that is, conformal dimension. From the T -matrix (4.30), the conformal dimension $h_{\lambda, b, \nu}$ of $M(\lambda, b, \nu)$ is

$$h_{\lambda, b, \nu} = \frac{\lambda(\lambda+2)}{4(k+2)} + \frac{b^2}{8} - \frac{\langle \nu, \nu \rangle}{2}.$$

From this and the balancing equation, $\mathcal{F}(M(\lambda, b, \nu))$ is untwisted if b is even and twisted if b is odd.

Analyzing the fusion for $\mathcal{L}_k^{\bar{0}} = M(0, 0, 0)$ -modules, we have the following fusion for \mathcal{L}_k -modules:

$$N^+ \begin{array}{l} \mathcal{F}(M(\lambda'', b'', \nu'')) \\ \mathcal{F}(M(\lambda, b, \nu)), \mathcal{F}(M(\lambda', b', \nu')) \end{array} = \begin{cases} (N^{\text{sl}_2})_{\lambda, \lambda'}^{\lambda''} & \text{if } b+b'-b'' \equiv 0, 2 \pmod{4}, \nu+\nu'-\nu'' \in L_\mu, \\ (N^{\text{sl}_2})_{\lambda, \lambda'}^{k-\lambda''} & \text{if } b+b'-b'' \equiv 0, 2 \pmod{4}, \nu+\nu'-\nu'' - \mu/2 \in L_\mu. \end{cases},$$

$$N^- \begin{array}{l} \mathcal{F}(M(\lambda'', b'', \nu'')) \\ \mathcal{F}(M(\lambda, b, \nu)), \mathcal{F}(M(\lambda', b', \nu')) \end{array} = \begin{cases} (N^{\text{sl}_2})_{\lambda, \lambda'}^{\lambda''} & \text{if } b+b'-b'' \equiv 0 \pmod{4}, \nu+\nu'-\nu'' \in L_\mu, \\ (N^{\text{sl}_2})_{\lambda, \lambda'}^{k-\lambda''} & \text{if } b+b'-b'' \equiv 2 \pmod{4}, \nu+\nu'-\nu'' - \mu/2 \in L_\mu, \\ -(N^{\text{sl}_2})_{\lambda, \lambda'}^{\lambda''} & \text{if } b+b'-b'' \equiv 2 \pmod{4}, \nu+\nu'-\nu'' \in L_\mu, \\ -(N^{\text{sl}_2})_{\lambda, \lambda'}^{k-\lambda''} & \text{if } b+b'-b'' \equiv 0 \pmod{4}, \nu+\nu'-\nu'' - \mu/2 \in L_\mu \end{cases}.$$

Note how the conditions on b , b' , and b'' for obtaining non-zero fusion rules implies that the tensor product of two twisted or two untwisted modules is untwisted and the tensor product of one twisted and one untwisted module is twisted.

Now we summarize the S -transformations for (super)characters of simple \mathcal{L}_k -modules. The simple modules for $\mathcal{L}_k^{\bar{0}} = M(0, 0, 0)$ are indexed by a set \mathcal{S} of triples (λ, b, ν) , where $0 \leq \lambda \leq k$, $0 \leq b \leq 3$ and $\nu + L_\mu \in L'_\mu/L_\mu$. Let us fix a choice of representatives of \mathcal{S} , say $\mathcal{S}^{\bar{0}}$, under the equivalence $X \sim J \boxtimes X$. Further choose $\mathcal{S}^{\bar{0}, \text{loc}}$ amongst $\mathcal{S}^{\bar{0}}$ for which b is even, that is, these induce to untwisted modules, and let $\mathcal{S}^{\bar{0}, \text{tw}} = \mathcal{S}^{\bar{0}} \setminus \mathcal{S}^{\bar{0}, \text{loc}}$. Then we have the following: for $(\lambda, b, \nu) \in \mathcal{S}^{\bar{0}, \text{loc}}$,

$$\text{ch}^+[\mathcal{F}(M(\lambda, b, \nu))] \left(-\frac{1}{\tau} \right) = \sum_{(\lambda', b', \nu') \in \mathcal{S}^{\bar{0}, \text{loc}}} 2 \cdot S_{M(\lambda, b, \nu), M(\lambda', b', \nu')}^X \cdot \text{ch}^+[\mathcal{F}(M(\lambda', b', \nu'))](\tau)$$

$$\text{ch}^-[\mathcal{F}(M(\lambda, b, \nu))] \left(-\frac{1}{\tau} \right) = \sum_{(\lambda', b', \nu') \in \mathcal{S}^{\bar{0}, \text{tw}}} 2 \cdot S_{M(\lambda, b, \nu), M(\lambda', b', \nu')}^X \cdot \text{ch}^+[\mathcal{F}(M(\lambda', b', \nu'))](\tau),$$

and for $(\lambda, b, \nu) \in \mathcal{S}^{\bar{0}, \text{tw}}$,

$$\text{ch}^+[\mathcal{F}(M(\lambda, b, \nu))] \left(-\frac{1}{\tau} \right) = \sum_{(\lambda', b', \nu') \in \mathcal{S}^{\bar{0}, \text{loc}}} 2 \cdot S_{M(\lambda, b, \nu), M(\lambda', b', \nu')}^X \cdot \text{ch}^-[\mathcal{F}(M(\lambda', b', \nu'))](\tau)$$

$$\text{ch}^-[\mathcal{F}(M(\lambda, b, \nu))] \left(-\frac{1}{\tau} \right) = \sum_{(\lambda', b', \nu') \in \mathcal{S}^{\bar{0}, \text{tw}}} 2 \cdot S_{M(\lambda, b, \nu), M(\lambda', b', \nu')}^X \cdot \text{ch}^-[\mathcal{F}(M(\lambda', b', \nu'))](\tau),$$

where the S -matrix for $\mathcal{L}_k^{\bar{0}}$ is given by (4.31). Fusion rules for \mathcal{L}_k -modules may also be computed using the S -matrix for the above (super)character transformations and the Verlinde formula of Section 4.2.4.

4.4.3 Bershadsky-Polyakov algebra

Finally, we discuss two examples of vertex operator (super)algebras with wrong statistics. One source of such algebras is quantum Hamiltonian reduction associated to certain nilpotent elements of a simple Lie (super)algebra. Such W -algebras and their cosets have recently appeared prominently as invariants of interfaces of 4-dimensional $\mathcal{N} = 4$ supersymmetric gauge theories [GR], and these algebras enjoy a triality [CL3] vastly generalizing Feigin-Frenkel duality [FF] and the coset realization of principal W -algebras [ACL2] for type A . The first new members are the subregular W -algebras of \mathfrak{sl}_n , which have fields of conformal weight $\frac{n}{2}$, and the principal W -superalgebras of $\mathfrak{sl}_{n|1}$, which have odd fields of conformal weight $\frac{n+1}{2}$. Hence these have wrong statistics if n is odd. Moreover, the natural generalization of Feigin-Frenkel duality, conjectured by Feigin and Semikhatov [FeS], relates the subregular W -algebra of \mathfrak{sl}_n at level k to the principal W -superalgebra of $\mathfrak{sl}_{n|1}$ at level ℓ , where the levels are assumed to be non-critical and related by $(k+n)(\ell+n-1) = 1$ [CGN]. We discuss now a simple example of such a dual pair in the instance $n = 3$. This subregular W -algebra of \mathfrak{sl}_3 was first discussed by Bershadsky and Polyakov [Be, Po] and is thus named after them.

The Bershadsky-Polyakov algebra at level $k = -1/2$, which corresponds to the parameter $\ell = 1$ in [ACL1], is an example of a vertex operator algebra with wrong statistics, and it is rational [Ar2]. We obtain its representation theory using an inverse coset construction. Specifically, the Bershadsky-Polyakov algebra is constructed here as a simple current extension of a tensor product of commuting lattice and Virasoro vertex operator algebras.

Consider the Virasoro minimal model vertex operator algebra $\text{Vir}(3, 5)$ of central charge $c = -3/5$. This algebra is simple, rational, C_2 -cofinite, and of CFT type. It has four irreducible modules up to isomorphism, $W_{1,s}$ for $1 \leq s \leq 4$, with $\text{Vir}(3, 5) = W_{1,1}$. The conformal dimension of $W_{1,s}$ is $h_{1,s} = ((5-3s)^2 - 4)/60$, and tensor products are given by:

$$W_{1,s} \boxtimes W_{1,n} \cong \bigoplus_{\substack{l=|n-s|+1 \\ l+n+s \text{ odd}}}^{\min(n+s-1, 9-n-s)} W_{1,l}.$$

In other words, the fusion rules are:

$$N(\text{Vir}(3, 5))_{(1,t),(1,t')}^{(1,t'')} = \begin{cases} 1 & \text{if } |t-t'| + 1 \leq t'' \leq \min\{t+t'-1, 9-t-t'\}, t+t'+t'' \text{ is odd,} \\ 0 & \text{otherwise.} \end{cases}$$

In particular, $W_{1,4}$ is a simple current of order 2 and conformal dimension $3/4$; it has quantum dimension -1 as can be seen from the S -matrix coefficients (4.34) below.

Let $L = \beta\mathbb{Z}$ be an even positive definite lattice such that $\langle \beta, \beta \rangle = 6$. We consider the vertex operator algebra $V = V_L \otimes \text{Vir}(3, 5)$. It has a simple current extension $A = V \oplus J$ with $J = V_{\frac{1}{2}\beta+L} \otimes W_{1,4}$. Using quantum dimensions, it can be quickly checked that this extension is a vertex operator algebra with wrong statistics [CKL]. The algebra A is precisely the Bershadsky-Polyakov algebra at $\ell = 1$ [Kawas, ACL1].

Now let $V_{\frac{i}{6}\beta+L} \otimes W_{1,s}$ be a simple module for V , and let us denote its conformal weight by $h_{i,1,s}$. Since fusion factors over tensor products of vertex operator algebras in the rational setting, we have:

$$\begin{aligned} \mathcal{F}(V_{\frac{i}{6}\beta+L} \otimes W_{1,s}) &\cong \left(V_{\frac{i}{6}\beta+L} \otimes W_{1,s} \right) \oplus \left(V_{\frac{i+3}{6}\beta+L} \otimes W_{1,5-s} \right), \\ h_{i+3,1,5-s} &= \frac{i^2 + 6i + 9}{12} + \frac{(10-3s)^2 - 4}{60}, \quad h_{i,1,s} = \frac{i^2}{12} + \frac{(5-3s)^2 - 4}{60} \\ \Rightarrow h_{i+3,1,5-s} - h_{i,1,s} + \mathbb{Z} &= \frac{i-s}{2} + \mathbb{Z}. \end{aligned}$$

Therefore,

$$\mathcal{F}(V_{\frac{i}{6}\beta+L} \otimes W_{1,s}) = \begin{cases} \text{Untwisted} & \text{if } i-s \equiv 1 \pmod{2}, \\ \text{Twisted} & \text{if } i-s \equiv 0 \pmod{2}. \end{cases} \quad (4.32)$$

Up to isomorphism, there are 24 simple V -modules $X_{i,s} = V_{\frac{i}{6}\beta+L} \otimes W_{1,s}$ for $0 \leq i \leq 5$ and $1 \leq s \leq 4$. These modules fall into 12 classes under the equivalence relation $X \sim J \boxtimes X$ for X simple, and of these equivalence classes, 6 induce to untwisted and 6 induce to twisted modules. Moreover, every simple (un)twisted A -module can be realized as one of these. Let $\mathcal{S}^{\bar{0}}$ denote the pairs (i, s) corresponding to a choice of equivalence class representatives of V -modules, and let $\mathcal{S}^{\bar{0}, \text{loc}}$, respectively $\mathcal{S}^{\bar{0}, \text{tw}}$, denote the set of pairs $(i, s) \in \mathcal{S}^{\bar{0}}$ such that $\mathcal{F}(X_{i,s})$ is untwisted, respectively twisted. Thus every untwisted,

respectively twisted, simple A -module is isomorphic to exactly one of the induced modules $\mathcal{F}(X_{i,s})$ for $(i,s) \in \mathcal{S}^{0,\text{loc}}$, respectively $(i,s) \in \mathcal{S}^{0,\text{tw}}$. The fusion of simple A -modules is given by

$$\mathcal{F}(X_{i,r}) \boxtimes_A \mathcal{F}(X_{j,s}) \cong \mathcal{F}(X_{i,r} \boxtimes_V X_{j,s}) \cong \bigoplus_{\substack{l=|r-s|+1 \\ l+r+s \text{ odd}}}^{\min(r+s-1, 9-r-s)} \mathcal{F}(X_{i+j,l}).$$

Note how fusion respects the twisting (4.32). Noting also that $\mathcal{F}(X_{i+j,s}) \cong \mathcal{F}(X_{i+j+3,5-s})$, the fusion rules are:

$$N_{\mathcal{F}(X_{i,r}), \mathcal{F}(X_{j,s})}^{\mathcal{F}(X_{k,t})} = \begin{cases} N(\text{Vir}(3,5))_{(1,r),(1,s)}^{(1,t)} & \text{if } k-i-j \equiv 0 \pmod{6} \\ N(\text{Vir}(3,5))_{(1,r),(1,s)}^{(1,5-t)} & \text{if } k-i-j \equiv 3 \pmod{6} \\ 0 & \text{otherwise.} \end{cases} \quad (4.33)$$

Now we discuss S -transformations of characters of (twisted) A -modules. First we recall the modular S -matrix for $\text{Vir}(3,5)$ from [dFMS, Equation 10.134]:

$$S_{W_{(r,s)}^X, W_{(\rho,\sigma)}} = 2\sqrt{\frac{2}{15}}(-1)^{1+s\rho+r\sigma} \sin\left(\frac{5\pi}{3}r\rho\right) \sin\left(\frac{3\pi}{5}s\sigma\right),$$

where $W_{1,1} = W_{(1,1)}$ but for other s , $W_{1,s} = W_{(2,5-s)}$. Therefore we obtain, for $2 \leq s, \sigma \leq 4$,

$$\begin{aligned} S_{W_{1,1}, W_{1,1}}^X &= -2\sqrt{\frac{2}{15}} \sin\left(\frac{5\pi}{3}\right) \sin\left(\frac{3\pi}{5}\right) = \sqrt{\frac{2}{5}} \sin\left(\frac{3\pi}{5}\right), \\ S_{W_{1,1}, W_{1,\sigma}}^X &= 2\sqrt{\frac{2}{15}}(-1)^\sigma \sin\left(\frac{10\pi}{3}\right) \sin\left(\frac{3\pi}{5}(5-\sigma)\right) = (-1)^{\sigma+1} \sqrt{\frac{2}{5}} \sin\left(\frac{3\pi\sigma}{5}\right), \\ S_{W_{1,s}, W_{1,\sigma}}^X &= -2\sqrt{\frac{2}{15}} \sin\left(\frac{20\pi}{3}\right) \sin\left(\frac{3\pi}{5}(5-s)(5-\sigma)\right) = (-1)^{s+\sigma} \sqrt{\frac{2}{5}} \sin\left(\frac{3\pi s\sigma}{5}\right). \end{aligned}$$

Note that in fact

$$S_{W_{1,s}, W_{1,\sigma}}^X = (-1)^{s+\sigma} \sqrt{\frac{2}{5}} \sin\left(\frac{3\pi s\sigma}{5}\right) \quad (4.34)$$

for all $1 \leq s, \sigma \leq 4$. As in Section 4.3.3, the modular S -matrix for V_L is given by:

$$S_{V_{\frac{i}{6}\beta+L}, V_{\frac{j}{6}\beta+L}}^X = \frac{1}{6} \exp\left(2\pi i \frac{ab}{6}\right).$$

Using these S -matrices, (super)characters of A -modules have the following modular S -transformations: for $(i,s) \in \mathcal{S}^{0,\text{loc}}$,

$$\begin{aligned} \text{ch}^+[\mathcal{F}(X_{i,s})]\left(-\frac{1}{\tau}\right) &= \sum_{(j,r) \in \mathcal{S}^{0,\text{tw}}} 2 \cdot S_{V_{\frac{j}{6}\beta+L}, V_{\frac{i}{6}\beta+L}}^X \cdot S_{W_{1,s}, W_{1,r}}^{\text{Vir}(3,5)} \cdot \text{ch}^-[\mathcal{F}(X_{j,r})](\tau) \\ \text{ch}^-[\mathcal{F}(X_{i,s})]\left(-\frac{1}{\tau}\right) &= \sum_{(j,r) \in \mathcal{S}^{0,\text{loc}}} 2 \cdot S_{V_{\frac{j}{6}\beta+L}, V_{\frac{i}{6}\beta+L}}^X \cdot S_{W_{1,s}, W_{1,r}}^{\text{Vir}(3,5)} \cdot \text{ch}^-[\mathcal{F}(X_{j,r})](\tau), \end{aligned}$$

and for $(i,s) \in \mathcal{S}^{0,\text{tw}}$,

$$\begin{aligned} \text{ch}^+[\mathcal{F}(X_{i,s})]\left(-\frac{1}{\tau}\right) &= \sum_{(j,r) \in \mathcal{S}^{0,\text{tw}}} 2 \cdot S_{V_{\frac{j}{6}\beta+L}, V_{\frac{i}{6}\beta+L}}^X \cdot S_{W_{1,s}, W_{1,r}}^{\text{Vir}(3,5)} \cdot \text{ch}^+[\mathcal{F}(X_{j,r})](\tau) \\ \text{ch}^-[\mathcal{F}(X_{i,s})]\left(-\frac{1}{\tau}\right) &= \sum_{(j,r) \in \mathcal{S}^{0,\text{loc}}} 2 \cdot S_{V_{\frac{j}{6}\beta+L}, V_{\frac{i}{6}\beta+L}}^X \cdot S_{W_{1,s}, W_{1,r}}^{\text{Vir}(3,5)} \cdot \text{ch}^+[\mathcal{F}(X_{j,r})](\tau). \end{aligned}$$

The fusion rules for A -modules can also be derived using these S -matrices for A together with the Verlinde formula of Section 4.2.

4.4.4 Superalgebra with wrong statistics

We can easily modify the inverse coset construction of the previous example to study the representation theory of a vertex operator superalgebra with wrong statistics. This algebra is in fact the simple principal W -superalgebra of $\mathfrak{sl}_{3|1}$ at level $\ell = -1/3$, by a special case of the main theorems of both [CGN, CL3].

We again work with $\text{Vir}(3,5)$, but now we tensor it with V_L where $L = \gamma\mathbb{Z}$ with $\langle \gamma, \gamma \rangle = 10$. Let $V = V_L \otimes \text{Vir}(3,5)$. As before, V is a simple, rational, C_2 -cofinite, vertex operator algebra of CFT type; V has an order-2 simple current $J = V_{\frac{1}{2}\gamma+L} \otimes W_{1,4}$ with $\text{qdim}(J) = -1$ and $\theta_J = 1_J$. We set $A = V \oplus J$, and by [CKL], A is a superalgebra of wrong statistics. By Proposition 4.5, every simple module in $\text{Rep } A$ is an induced module, and conversely, every simple V -module induces to a simple $\text{Rep } A$ -module. Let $X_{i,s} = V_{\frac{i}{10}\gamma+L} \otimes W_{1,s}$, and let us denote its conformal weight by $h_{i,1,s}$. Then

$$\begin{aligned} \mathcal{F}(X_{i,s}) &= X_{i,s} \oplus X_{i+5,5-s} \\ h_{i+5,1,5-s} &= \frac{i^2 + 10i + 25}{20} + \frac{(10-3s)^2 - 4}{60}, \quad h_{i,1,s} = \frac{i^2}{20} + \frac{(5-3s)^2 - 4}{60} \\ \Rightarrow h_{i+5,1,5-s} - h_{i,1,s} + \mathbb{Z} &= \frac{i-s+1}{2} + \mathbb{Z}. \end{aligned}$$

Therefore,

$$\mathcal{F}(X_{i,s}) = \begin{cases} \text{Untwisted} & \text{if } i-s \equiv 1 \pmod{2} \\ \text{Twisted} & \text{if } i-s \equiv 0 \pmod{2} \end{cases}.$$

Similar to the previous example, there are 40 simple V -modules up to isomorphism indexed by the pairs (i, j) with $0 \leq i \leq 9$, $1 \leq j \leq 4$, which fall into 20 classes under the identification $X \sim J \boxtimes X$. Of these equivalence classes, 10 induce to untwisted modules and 10 to twisted modules. As before, we denote sets of representatives of these classes by \mathcal{S}^0 , $\mathcal{S}^{0,\text{loc}}$, and $\mathcal{S}^{0,\text{tw}}$. Up to (possibly odd) isomorphism, each untwisted, respectively twisted, simple A -module is induced from exactly one module $X_{i,s}$ for $(i, s) \in \mathcal{S}^{0,\text{loc}}$, respectively $(i, s) \in \mathcal{S}^{0,\text{tw}}$.

Similar to (4.33), we have the following (super)fusion rules:

$$\begin{aligned} (N^\pm)_{\mathcal{F}(X_{i,s}), \mathcal{F}(X_{j,r})}^{\mathcal{F}(X_{k,t})} &= N_{X_{i,s}, X_{j,r}}^{X_{k,t}} \pm N_{X_{i,s}, X_{j,r}}^{X_{5+k,5-t}} \\ &= \begin{cases} N(\text{Vir}(3,5))_{(1,s), (1,r)}^{(1,t)} & \text{if } k \equiv i+j \pmod{10} \\ \pm N(\text{Vir}(3,5))_{(1,s), (1,r)}^{(1,5-t)} & \text{if } k \equiv i+j+5 \pmod{10} \end{cases}. \end{aligned}$$

The S -transformations of (super)characters of $\mathcal{F}(X_{i,s})$ for $(i, s) \in \mathcal{S}^0$ have exactly the same form as for the Bershadsky-Polyakov algebra; the only difference is that we use the S -matrix for $V_{\gamma\mathbb{Z}}$ rather than $V_{\beta\mathbb{Z}}$. Fusion rules for A -modules may also be computed using the resulting S -matrix for A .

For further examples of regular vertex operator superalgebras with wrong statistics, see the analysis of the affine vertex operator superalgebra $L_k(\mathfrak{osp}(1|2))$ and its parafermion coset, at positive integer level k , in [CFK].

References

- [ABD] T. Abe, G. Buhl and C. Dong, Rationality, regularity, and C_2 -cofiniteness, *Trans. Amer. Math. Soc.* **356** (2004), no. 8, 3391–3402.
- [ADL] T. Abe, C. Dong and H. Li, Fusion rules for the vertex operator algebra $M(1)^+$ and V_L^+ , *Comm. Math. Phys.* **253** (2005), no. 1, 171–219.
- [Ad1] D. Adamović, Representations of the $N = 2$ superconformal vertex algebra, *Internat. Math. Res. Notices* 1999, no. 2, 61–79.
- [Ad2] D. Adamović, Vertex algebra approach to fusion rules for $N = 2$ superconformal minimal models, *J. Algebra* **239** (2001), no. 2, 549–572.
- [ACGY] D. Adamović, T. Creutzig, N. Genra and J. Yang, The vertex algebras $\mathcal{R}^{(p)}$ and $\mathcal{V}^{(p)}$, *Comm. Math. Phys.* **383** (2021), no. 2, 1207–1241.
- [AM1] D. Adamović and A. Milas, Vertex operator algebras associated to modular invariant representations for $A_1^{(1)}$, *Math. Res. Lett.* **2** (1995), no. 5, 563–575.

- [AM2] D. Adamović and A. Milas, On the triplet vertex algebra $W(p)$, *Adv. Math.* **217** (2008), no. 6, 2664–2699.
- [AM3] D. Adamović and A. Milas, Lattice construction of logarithmic modules for certain vertex algebras, *Selecta Math. (N.S.)* **15** (2009), no. 4, 535–561.
- [AM4] D. Adamović and A. Milas, On W -algebras associated to $(2, p)$ minimal models and their representations, *Int. Math. Res. Not. IMRN* 2010, no. 20, 3896–3934.
- [ADJR] C. Ai, C. Dong, X. Jiao and L. Ren, The irreducible modules and fusion rules for the parafermion vertex operator algebras, *Trans. Amer. Math. Soc.* **370** (2018), no. 8, 5963–5981.
- [AC] C. Alfes and T. Creutzig, The mock modular data of a family of superalgebras, *Proc. Amer. Math. Soc.* **142** (2014), no. 7, 2265–2280.
- [Ar1] T. Arakawa, Representation theory of W -algebras, *Invent. Math.* **169** (2007), no. 2, 219–320.
- [Ar2] T. Arakawa, Rationality of Bershadsky-Polyakov vertex algebras, *Comm. Math. Phys.* **323** (2013), no. 2, 627–633.
- [ACF] T. Arakawa, T. Creutzig and B. Feigin, Urod algebras and translation of W -algebras, [arXiv:2010.02427](https://arxiv.org/abs/2010.02427).
- [ACKL] T. Arakawa, T. Creutzig, K. Kawasetsu and A. Linshaw, Orbifolds and cosets of minimal W -algebras, *Comm. Math. Phys.* **355** (2017), no. 1, 339–372.
- [ACL1] T. Arakawa, T. Creutzig and A. Linshaw, Cosets of Bershadsky-Polyakov algebras and rational W -algebras of type A , *Selecta Math. (N.S.)* **23** (2017), no. 4, 2369–2395.
- [ACL2] T. Arakawa, T. Creutzig and A. Linshaw, W -algebras as coset vertex algebras, *Invent. Math.* **218** (2019), no. 1, 145–195.
- [ALY] T. Arakawa, C. Lam and H. Yamada, Zhu’s algebra, C_2 -algebra and C_2 -cofiniteness of parafermion vertex operator algebras, *Adv. Math.* **264** (2014), 261–295.
- [ACR] J. Auger, T. Creutzig and D. Ridout, Modularity of logarithmic parafermion vertex algebras, *Lett. Math. Phys.* **108** (2018), no. 12, 2543–2587.
- [BK] B. Bakalov and A. Kirillov, Jr., *Lectures on Tensor Categories and Modular Functors*, University Lecture Series, Vol. 21, American Mathematical Society, Providence, RI, 2001.
- [BSVW] A. Barker, D. Swinarski, L. Vogelstein and J. Wu, A new proof of a formula for the type A_2 fusion rules, *J. Math. Phys.* **56** (2015), no. 1, 011703, 10 pp.
- [Be] M. Bershadsky, Conformal field theories via Hamiltonian reduction, *Comm. Math. Phys.* **139** (1991), no. 1, 71–82.
- [BLKR] M. Bischoff, R. Longo, Y. Kawahigashi, and K.-H. Rehren, Tensor categories and endomorphisms of von Neumann algebras—with applications to quantum field theory, Springer Briefs in Mathematical Physics, Vol. 3, Springer, 2015.
- [BöE1] J. Böckenhauer and D. Evans, Modular invariants, graphs, and α -induction for nets of subfactors, I, *Comm. Math. Phys.* **197** (1998), no. 2, 361–386.
- [BöE2] J. Böckenhauer and D. Evans, Modular invariants from subfactors, *Quantum symmetries in theoretical physics and mathematics (Bariloche, 2000)*, 95–131, Contemp. Math., **294**, Amer. Math. Soc., Providence, RI, 2002.
- [BEK] J. Böckenhauer, D. Evans and Y. Kawahigashi, On α -induction, chiral generators and modular invariants for subfactors, *Comm. Math. Phys.* **208** (1999), no. 2, 429–487.
- [BrE] J. Brundan and A. Ellis, Monoidal supercategories, *Comm. Math. Phys.* **351** (2017), no. 3, 1045–1089.
- [Ca] S. Carnahan, Building vertex algebras from parts, *Comm. Math. Phys.* **373** (2020), no. 1, 1–43.
- [CaM] S. Carnahan and M. Miyamoto, Regularity of fixed-point vertex operator algebras, [arXiv:1603.05645](https://arxiv.org/abs/1603.05645).
- [CKLW] S. Carpi, Y. Kawahigashi, R. Longo and M. Weiner, From vertex operator algebras to conformal nets and back, *Mem. Amer. Math. Soc.* **254** (2018), no. 1213, vi+85 pp.
- [Ch] L. Chen, On axiomatic approaches to intertwining operator algebras, *Commun. Contemp. Math.* **18** (2016), no. 4, 1550051, 62 pp.

- [Cr1] T. Creutzig, W -algebras for Argyres–Douglas theories, *Eur. J. Math.* **3** (2017), no. 3, 659–690.
- [Cr2] T. Creutzig, Fusion categories for affine vertex algebras at admissible levels, *Selecta Math. (N.S.)* **25** (2019), no. 2, Paper No. 27, 21 pp.
- [CDR] T. Creutzig, J. Duncan and W. Riedler, Self-dual vertex operator superalgebras and superconformal field theory, *J. Phys. A* **51** (2018), no. 3, 034001, 29 pp.
- [CFL] T. Creutzig, B. Feigin, and A. Linshaw, $N = 4$ superconformal algebras and diagonal cosets, *Int. Math. Res. Not. IMRN* 2020, rnaa078, <https://doi.org/10.1093/imrn/rnaa078>.
- [CFK] T. Creutzig, J. Frohlich and S. Kanade, Representation theory of $L_k(\mathfrak{osp}(1|2))$ from vertex tensor categories and Jacobi forms, *Proc. Amer. Math. Soc.* **146** (2018), no. 11, 4571–4589.
- [CGai] T. Creutzig and D. Gaiotto, Vertex algebras for S -duality, *Comm. Math. Phys.* **379** (2020), no. 3, 785–845.
- [CGan] T. Creutzig and T. Gannon, Logarithmic conformal field theory, log-modular tensor categories and modular forms, *J. Phys. A* **50** (2017), no. 40, 404004, 37 pp.
- [CGR] T. Creutzig, A. Gainutdinov and I. Runkel, A quasi-Hopf algebra for the triplet vertex operator algebra, *Commun. Contemp. Math.* **22** (2020), no. 3, 1950024, 71 pp.
- [CGN] T. Creutzig, N. Genra and S. Nakatsuka, Duality of subregular \mathcal{W} -algebras and principal \mathcal{W} -superalgebras, *Adv. Math.* **383** (2021), 107685, 52 pp.
- [CHY] T. Creutzig, Y.-Z. Huang and J. Yang, Braided tensor categories of admissible modules for affine Lie algebras, *Comm. Math. Phys.* **362** (2018), no. 3, 827–854.
- [CKL] T. Creutzig, S. Kanade and A. Linshaw, Simple current extensions beyond semi-simplicity, *Commun. Contemp. Math.* **22** (2020), no. 1, 1950001, 49 pp.
- [CKLR] T. Creutzig, S. Kanade, A. Linshaw and D. Ridout, Schur-Weyl duality for Heisenberg cosets, *Transform. Groups* **24** (2019), no. 2, 301–354.
- [CKM] T. Creutzig, S. Kanade and R. McRae, Gluing vertex algebras, [arXiv:1906.00119](https://arxiv.org/abs/1906.00119).
- [CL1] T. Creutzig and A. Linshaw, The super $W_{1+\infty}$ algebra with integral central charge, *Trans. Amer. Math. Soc.* **367** (2015), no. 8, 5521–5551.
- [CL2] T. Creutzig and A. Linshaw, Cosets of affine vertex algebras inside larger structures, *J. Algebra* **517** (2019), 396–438.
- [CL3] T. Creutzig and A. Linshaw, Trialities of \mathcal{W} -algebras, [arXiv:2005.10234](https://arxiv.org/abs/2005.10234).
- [CMY1] T. Creutzig, R. McRae and J. Yang, On ribbon categories for singlet vertex algebras, to appear in *Comm. Math. Phys.*, [arXiv:2007.12735](https://arxiv.org/abs/2007.12735).
- [CMY2] T. Creutzig, R. McRae and J. Yang, Tensor structure on the Kazhdan-Lusztig category for affine $\mathfrak{gl}(1|1)$, to appear in *Int. Math. Res. Not. IMRN*, [arXiv:2009.00818](https://arxiv.org/abs/2009.00818).
- [CrM] T. Creutzig and A. Milas, False theta functions and the Verlinde formula, *Adv. Math.* **262** (2014), 520–545
- [CMR] T. Creutzig, A. Milas and M. Rupert, Logarithmic link invariants of $\overline{U}_q^H(\mathfrak{sl}_2)$ and asymptotic dimensions of singlet vertex algebras, *J. Pure Appl. Algebra* **222** (2018), no. 10, 3224–3247.
- [CQS] T. Creutzig, T. Quella and V. Schomerus, Branes in the $GL(1|1)$ WZNW-model, *Nucl. Phys. B* **792** (2008), no. 3, 257–283.
- [CRi1] T. Creutzig and D. Ridout, Modular data and Verlinde formulae for fractional level WZW models I, *Nucl. Phys. B* **865** (2012), no. 1, 83–114.
- [CRi2] T. Creutzig and D. Ridout, Relating the archetypes of logarithmic conformal field theory, *Nucl. Phys. B* **872** (2013), no. 3, 348–391.
- [CRi3] T. Creutzig and D. Ridout, Modular data and Verlinde formulae for fractional level WZW models II, *Nucl. Phys. B* **875** (2013), no. 2, 423–458.
- [CRi4] T. Creutzig and D. Ridout, Logarithmic conformal field theory: beyond an introduction, *J. Phys. A* **46** (2013), no. 49, 494006, 72 pp.
- [CRW] T. Creutzig, D. Ridout and S. Wood, Coset constructions of logarithmic $(1, p)$ -models, *Lett. Math. Phys.* **104** (2014), no. 5, 553–583.

- [CRu] T. Creutzig and M. Rupert, Uprolling unrolled quantum groups, *Commun. Contemp. Math.* (2021), 2150023, <https://doi.org/10.1142/S0219199721500231>.
- [CY] T. Creutzig and J. Yang, Tensor categories of affine Lie algebras beyond admissible levels, *Math. Ann.* (2021), <https://doi.org/10.1007/s00208-021-02159-w>.
- [DMNO] A. Davydov, M. Müger, D. Nikshych and V. Ostrik, The Witt group of non-degenerate braided fusion categories, *J. Reine Angew. Math.* **677** (2013), 135–177.
- [DPZ] P. Di Vecchia, J. Petersen and H. Zheng, $N = 2$ extended superconformal theories in two dimensions, *Phys. Lett. B* **162** (1985), no. 4–6, 327–332.
- [Do] C. Dong, Vertex algebras associated with even lattices, *J. Algebra* **161** (1993), no. 1, 245–265.
- [DH1] C. Dong and J. Han, Some finite properties for vertex operator superalgebras, *Pacific J. Math.* **258** (2012), no. 2, 269–290.
- [DH2] C. Dong and J. Han, On rationality of vertex operator superalgebras, *Int. Math. Res. Not. IMRN* 2014, no. 16, 4379–4399.
- [DJX] C. Dong, X. Jiao and F. Xu, Quantum dimensions and quantum Galois theory, *Trans. Amer. Math. Soc.* **365** (2013), no. 12, 6441–6469.
- [DLY] C. Dong, C. Lam and H. Yamada, W -algebras related to parafermion algebras, *J. Algebra* **322** (2009), no. 7, 2366–2403.
- [DLWY] C. Dong, C. Lam, Q. Wang and H. Yamada, The structure of parafermion vertex operator algebras, *J. Algebra* **323** (2010), no. 2, 371–381.
- [DLe] C. Dong and J. Lepowsky, *Generalized Vertex Algebras and Relative Vertex Operators*, Progress in Math., Vol. 112, Birkhäuser, Boston, 1993.
- [DLM1] C. Dong, H. Li and G. Mason, Compact automorphism groups of vertex operator algebras, *Internat. Math. Res. Notices* 1996, no. 18, 913–921.
- [DLM2] C. Dong, H. Li and G. Mason, Regularity of rational vertex operator algebras, *Adv. Math.* **132** (1997), no. 1, 148–166.
- [DLi] C. Dong and Z. Lin, Induced modules for vertex operator algebras, *Comm. Math. Phys.* **179** (1996), no. 1, 157–183.
- [DM1] C. Dong and G. Mason, On quantum Galois theory, *Duke Math. J.* **86** (1997), no. 2, 305–321.
- [DM2] C. Dong, and G. Mason, Quantum Galois theory for compact Lie groups. *J. Algebra* **214** (1999), no. 1, 92–102.
- [DR] C. Dong and L. Ren, Representations of the parafermion vertex operator algebras, *Adv. Math.* **315** (2017), 88–101.
- [DW1] C. Dong and Q. Wang, The structure of parafermion vertex operator algebras: general case, *Comm. Math. Phys.* **299** (2010), no. 3, 783–792.
- [DW2] C. Dong and Q. Wang, On C_2 -cofiniteness of parafermion vertex operator algebras, *J. Algebra* **328** (2011), 420–431.
- [DW3] C. Dong and Q. Wang, Quantum dimensions and fusion rules for parafermion vertex operator algebras, *Proc. Amer. Math. Soc.* **144** (2016), no. 4, 1483–1492.
- [DZ] C. Dong and Z. Zhao, Modularity in orbifold theory for vertex operator superalgebras, *Comm. Math. Phys.* **260** (2005), no. 1, 227–256.
- [EGNO] P. Etingof, S. Gelaki, D. Nikshych and V. Ostrik, *Tensor Categories*, Mathematical Surveys and Monographs, Vol. 205, American Mathematical Society, Providence, RI, 2015.
- [ENO] P. Etingof, D. Nikshych and V. Ostrik, On fusion categories, *Ann. of Math. (2)* **162** (2005), no. 2, 581–642.
- [FGST1] B. Feigin, A. Gainutdinov, A. Semikhatov and I. Tipunin, The Kazhdan-Lusztig correspondence for the representation category of the triplet W -algebra in logarithmic conformal field theories, (Russian) *Teoret. Mat. Fiz.* **148** (2006), no. 3, 398–427; translation in *Theoret. and Math. Phys.* **148** (2006), no. 3, 1210–1235.
- [FGST2] B. Feigin, A. Gainutdinov, A. Semikhatov and I. Tipunin, Logarithmic extensions of minimal models: Characters and modular transformations, *Nucl. Phys. B* **757** (2006), no. 3, 303–343.

- [FF] B. Feigin and E. Frenkel, Duality in W -algebras, *Internat. Math. Res. Notices* 1991, no. 6, 75–82.
- [FeS] B. Feigin and A. Semikhatov, $\mathcal{W}_n^{(2)}$ algebras, *Nuclear Phys. B* **698** (2004), no. 3, 409–449.
- [FFRS1] J. Fjelstad, J. Fuchs, I. Runkel and C. Schweigert, Topological and conformal field theory as Frobenius algebras, *Categories in algebra, geometry, and mathematical physics*, 225–247, Contemp. Math., Vol. 431, American Mathematical Society, Providence, RI, 2007.
- [FFRS2] J. Fjelstad, J. Fuchs, I. Runkel and C. Schweigert, TFT construction of RCFT correlators V: Proof of modular invariance and factorisation, *Theory Appl. Categ.* **16** (2006), no. 16, 342–433.
- [dFMS] P. Di Francesco, P. Mathieu and D. Sénéchal, *Conformal Field Theory*, Graduate Texts in Contemporary Physics, Springer-Verlag, New York, 1997.
- [FHL] I. Frenkel, Y.-Z. Huang and J. Lepowsky, On axiomatic approaches to vertex operator algebras and modules, *Mem. Amer. Math. Soc.* **104** (1993), no. 494, viii+64 pp.
- [FLM] I. Frenkel, J. Lepowsky and A. Meurman, *Vertex Operator Algebras and the Monster*, Academic Press, Boston, 1988.
- [Fu] J. Fuchs, Simple WZW currents, *Comm. Math. Phys.* **136** (1991), no. 2, 345–356.
- [FRS1] J. Fuchs, I. Runkel and C. Schweigert, TFT construction of RCFT correlators I: Partition functions, *Nucl. Phys. B* **646** (2002), no. 3, 353–497.
- [FRS2] J. Fuchs, I. Runkel and C. Schweigert, Ribbon categories and (unoriented) CFT: Frobenius algebras, automorphisms, reversions, *Categories in algebra, geometry and mathematical physics*, 203–224, Contemp. Math., **431**, Amer. Math. Soc., Providence, RI, 2007.
- [FRS3] J. Fuchs, I. Runkel and C. Schweigert, The fusion algebra of bimodule categories, *Appl. Categ. Structures* **16** (2008), no. 1-2, 123–140.
- [FuS] J. Fuchs, and C. Schweigert, Hopf algebras and finite tensor categories in conformal field theory, *Rev. Union Mat. Argentina* **51** (2010), no. 2, 43–90.
- [GLO] A. Gainutdinov, S. Lentner and T. Ohrmann, Modularization of small quantum groups, [arXiv:1809.02116](https://arxiv.org/abs/1809.02116).
- [GR] D. Gaiotto and M. Rapčák, Vertex algebras at the corner, *J. High Energy Phys.* 2019, no. 1, 160, front matter+85 pp.
- [Ga] C. Galindo, Crossed product tensor categories, *J. Algebra* **337** (2011), 233–252.
- [Hö] G. Höhn, Genera of vertex operator algebras and three-dimensional topological quantum field theories, *Vertex operator algebras in mathematics and physics (Toronto, ON, 2000)*, 89–107, Fields Inst. Commun., Vol. 39, American Mathematical Society, Providence, RI, 2003.
- [Hu1] Y.-Z. Huang, *Two-dimensional Conformal Geometry and Vertex Operator Algebras*, Progress in Math., Vol. 148, Birkhäuser, Boston, MA, 1997.
- [Hu2] Y.-Z. Huang, A theory of tensor products for module categories for a vertex operator algebra, IV, *J. Pure Appl. Alg.* **100** (1995), no. 1-3, 173–216.
- [Hu3] Y.-Z. Huang, Virasoro vertex operator algebras, (nonmeromorphic) operator product expansion and the tensor product theory, *J. Algebra* **182** (1996), no. 1, 201–234.
- [Hu4] Y.-Z. Huang, Generalized rationality and a “Jacobi identity” for intertwining operator algebras. *Selecta Math. (N.S.)* **6** (2000), no. 3, 225–267.
- [Hu5] Y.-Z. Huang, Differential equations and intertwining operators, *Commun. Contemp. Math.* **7** (2005), no. 3, 375–400.
- [Hu6] Y.-Z. Huang, Vertex operator algebras and the Verlinde conjecture, *Commun. Contemp. Math.* **10** (2008), no. 1, 103–154.
- [Hu7] Y.-Z. Huang, Rigidity and modularity of vertex tensor categories, *Commun. Contemp. Math.* **10** (2008), suppl. 1, 871–911.
- [Hu8] Y.-Z. Huang, Cofiniteness conditions, projective covers and the logarithmic tensor product theory, *J. Pure Appl. Algebra* **213** (2009), no. 4, 458–475.
- [Hu9] Y.-Z. Huang, Two constructions of grading-restricted vertex (super)algebras, *J. Pure Appl. Algebra* **220** (2016), no. 11, 3628–3649.

- [Hu10] Y.-Z. Huang, On the applicability of logarithmic tensor category theory, [arXiv:1702.00133](#).
- [HKL] Y.-Z. Huang, A. Kirillov and J. Lepowsky, Braided tensor categories and extensions of vertex operator algebras, *Comm. Math. Phys.* **337** (2015), no. 3, 1143–1159.
- [HK1] Y.-Z. Huang and L. Kong, Open-string vertex algebras, tensor categories and operads, *Comm. Math. Phys.* **250** (2004), no. 3, 433–471.
- [HK2] Y.-Z. Huang and L. Kong, Full field algebras, *Comm. Math. Phys.* **272** (2007), no. 2, 345–396.
- [HK3] Y.-Z. Huang and L. Kong, Modular invariance for conformal full field algebras, *Trans. Amer. Math. Soc.* **362** (2010), no. 6, 3027–3067.
- [HL1] Y.-Z. Huang and J. Lepowsky, Tensor products of modules for a vertex operator algebra and vertex tensor categories, *Lie Theory and Geometry*, 349–383, Progress in Math., Vol. 123, Birkhäuser, Boston, MA, 1994.
- [HL2] Y.-Z. Huang and J. Lepowsky, A theory of tensor products for module categories for a vertex operator algebra, I, *Selecta Math. (N. S.)* **1** (1995), no. 4, 699–756.
- [HL3] Y.-Z. Huang and J. Lepowsky, A theory of tensor products for module categories for a vertex operator algebra, II, *Selecta Math. (N. S.)* **1** (1995), no. 4, 757–786.
- [HL4] Y.-Z. Huang and J. Lepowsky, A theory of tensor products for module categories for a vertex operator algebra, III, *J. Pure Appl. Alg.* **100** (1995), no. 1-3, 141–171.
- [HL5] Y.-Z. Huang and J. Lepowsky, Intertwining operator algebras and vertex tensor categories for affine Lie algebras, *Duke Math. J.* **99** (1999), no. 1, 113–134.
- [HL6] Y.-Z. Huang and J. Lepowsky, Tensor categories and the mathematics of rational and logarithmic conformal field theory, *J. Phys. A* **46** (2013), no. 49, 494009, 21 pp.
- [HLZ1] Y.-Z. Huang, J. Lepowsky and L. Zhang, Logarithmic tensor category theory for generalized modules for a conformal vertex algebra, I: Introduction and strongly graded algebras and their generalized modules, *Conformal field theories and tensor categories*, 169–248, Math. Lect. Peking Univ., Springer, Heidelberg, 2014.
- [HLZ2] Y.-Z. Huang, J. Lepowsky and L. Zhang, Logarithmic tensor category theory for generalized modules for a conformal vertex algebra, II: Logarithmic formal calculus and properties of logarithmic intertwining operators, [arXiv:1012.4196](#).
- [HLZ3] Y.-Z. Huang, J. Lepowsky and L. Zhang, Logarithmic tensor category theory for generalized modules for a conformal vertex algebra, III: Intertwining maps and tensor product bifunctors, [arXiv:1012.4197](#).
- [HLZ4] Y.-Z. Huang, J. Lepowsky and L. Zhang, Logarithmic tensor category theory for generalized modules for a conformal vertex algebra, IV: Constructions of tensor product bifunctors and the compatibility conditions, [arXiv:1012.4198](#).
- [HLZ5] Y.-Z. Huang, J. Lepowsky and L. Zhang, Logarithmic tensor category theory for generalized modules for a conformal vertex algebra, V: Convergence condition for intertwining maps and the corresponding compatibility condition, [arXiv:1012.4199](#).
- [HLZ6] Y.-Z. Huang, J. Lepowsky and L. Zhang, Logarithmic tensor category theory for generalized modules for a conformal vertex algebra, VI: Expansion condition, associativity of logarithmic intertwining operators, and the associativity isomorphisms, [arXiv:1012.4202](#).
- [HLZ7] Y.-Z. Huang, J. Lepowsky and L. Zhang, Logarithmic tensor category theory for generalized modules for a conformal vertex algebra, VII: Convergence and extension properties and applications to expansion for intertwining maps, [arXiv:1110.1929](#).
- [HLZ8] Y.-Z. Huang, J. Lepowsky and L. Zhang, Logarithmic tensor category theory for generalized modules for a conformal vertex algebra, VIII: Braided tensor category structure on categories of generalized modules for a conformal vertex algebra, [arXiv:1110.1931](#).
- [HM1] Y.-Z. Huang and A. Milas, Intertwining operator superalgebras and vertex tensor categories for superconformal algebras. I, *Commun. Contemp. Math.* **4** (2002), 327–355.
- [HM2] Y.-Z. Huang and A. Milas, Intertwining operator superalgebras and vertex tensor categories for superconformal algebras. II, *Trans. Amer. Math. Soc.* **354** (2002), 363–385.
- [IK] K. Iohara and Y. Koga, *Representation Theory of the Virasoro Algebra*, Springer Monographs in Mathematics, Springer-Verlag, London, 2011.

- [KRW] V. Kac, S.-S. Roan and M. Wakimoto, Quantum reduction for affine superalgebras, *Comm. Math. Phys.* **241** (2003), no. 2-3, 307–342.
- [KW1] V. Kac and M. Wakimoto, Quantum reduction and representation theory of superconformal algebras, *Adv. Math.* **185** (2004), no. 2, 400–458.
- [KW2] V. Kac and M. Wakimoto, On rationality of W -algebras, *Transform. Groups* **13** (2008), no. 3-4, 671–713.
- [KW3] V. Kac and M. Wakimoto, Representations of affine superalgebras and mock theta functions, *Transform. Groups* **19** (2014), no. 2, 387–455.
- [KW4] V. Kac and M. Wakimoto, Representations of affine superalgebras and mock theta functions II, *Adv. Math.* **300** (2016), 17–70.
- [KW5] V. Kac and M. Wakimoto, Representations of affine superalgebras and mock theta functions III, *Izv. Ross. Akad. Nauk Ser. Mat.* **80** (2016), no. 4, 65–122; reprinted in *Izv. Math.* **80** (2016), no. 4, 693–750.
- [Kas] C. Kassel, *Quantum Groups*, Graduate Texts in Mathematics, Vol. 155, Springer-Verlag, New York, 1995.
- [Kau] H. Kausch, Extended conformal algebras generated by a multiplet of primary fields, *Phys. Lett. B* **259** (1991), no. 4, 448–455.
- [Kawah] Y. Kawahigashi, Conformal field theory, tensor categories and operator algebras, *J. Phys. A* **48** (2015), no. 30, 303001, 57 pp.
- [Kawas] K. Kawasetsu, W -algebras with non-admissible levels and the Deligne exceptional series, *Int. Math. Res. Not. IMRN* 2018, no. 3, 641–676.
- [Ki1] A. Kirillov, Jr., Modular categories and orbifold models, *Comm. Math. Phys.* **229** (2002), no. 2, 309–335.
- [Ki2] A. Kirillov, Jr., On G -equivariant modular categories, [arXiv:math/0401119](https://arxiv.org/abs/math/0401119).
- [KO] A. Kirillov, Jr. and V. Ostrik, On a q -analogue of the McKay correspondence and the ADE classification of \mathfrak{sl}_2 conformal field theories, *Adv. Math.* **171** (2002), no. 2, 183–227.
- [KS] H. Kondo, Y. Saito, Indecomposable decomposition of tensor products of modules over the restricted quantum universal enveloping algebra associated to \mathfrak{sl}_2 , *J. Algebra* **330** (2011), 103–129.
- [Ko] L. Kong, Full field algebras, operads and tensor categories, *Adv. Math.* **213** (2007), no. 1, 271–340.
- [KM] M. Krauel and G. Mason, Jacobi trace functions in the theory of vertex operator algebras, *Commun. Number Theory Phys.* **9** (2015), no. 2, 273–306.
- [LL] J. Lepowsky and H. Li, *Introduction to Vertex Operator Algebras and Their Representations*, Progress in Math., Vol. 227, Birkhäuser, Boston, 2003.
- [LW] J. Lepowsky and R. Wilson, A new family of algebras underlying the Rogers–Ramanujan identities and generalizations, *Proc. Nat. Acad. Sci. U.S.A.* **78** (1981), no. 12, part 1, 7254–7258.
- [Li1] H. Li, Symmetric invariant bilinear forms on vertex operator algebras, *J. Pure Appl. Algebra* **96** (1994), no. 3, 279–297.
- [Li2] W. Li, *Representations of Vertex Operator Superalgebras and Abelian Intertwining Algebras*, Ph.D. thesis, Rutgers University, 1997.
- [Lin] X. Lin, Mirror extensions of rational vertex operator algebras, *Trans. Amer. Math. Soc.* **369** (2017), no. 6, 3821–3840.
- [LR] R. Longo and K.-H. Rehren, Nets of subfactors, Workshop on Algebraic Quantum Field Theory and Jones Theory (Berlin, 1994), *Rev. Math. Phys.* **7** (1995), no. 4, 567–597.
- [McR] R. McRae, Twisted modules and G -equivariantization in logarithmic conformal field theory, *Comm. Math. Phys.* **383** (2021), no. 3, 1939–2019.
- [Mil1] A. Milas, Weak modules and logarithmic intertwining operators for vertex operator algebras, *Recent developments in infinite-dimensional Lie algebras and conformal field theory (Charlottesville, VA, 2000)*, 201–225, Contemp. Math., **297**, Amer. Math. Soc., Providence, RI, 2002.

- [Mil2] A. Milas, Logarithmic intertwining operators and vertex operators, *Comm. Math. Phys.* **277** (2008), no. 2, 497–529.
- [Miy] M. Miyamoto, Flatness and semi-rigidity of vertex operator algebras, [arXiv:1104.4675](https://arxiv.org/abs/1104.4675).
- [MS] G. Moore and N. Seiberg, Classical and quantum conformal field theory, *Comm. Math. Phys.* **123** (1989), no. 2, 177–254.
- [Mü1] M. Müger, Galois extensions of braided tensor categories and braided crossed G -categories, *J. Algebra* **277** (2004), no. 1, 256–281.
- [Mü2] M. Müger, Conformal orbifold theories and braided crossed G -categories. *Comm. Math. Phys.* **260** (2005), no. 3, 727–762.
- [Ne] C. Negron, Log-modular quantum groups at even roots of unity and the quantum Frobenius I, *Comm. Math. Phys.* **382** (2021), no. 2, 773–814.
- [Os] V. Ostrik, Module categories, weak Hopf algebras and modular invariants, *Transform. Groups* **8** (2003), no. 2, 177–206.
- [OS] V. Ostrik and M. Sun, Level-rank duality via tensor categories, *Comm. Math. Phys.* **326** (2014), no. 1, 49–61.
- [Pa] B. Pareigis, On braiding and dyslexia, *J. Algebra* **171** (1995), no. 2, 413–425.
- [Po] A. Polyakov, Gauge transformations and diffeomorphisms, *Int. J. Mod. Phys. A* **5** (1990), no. 5, 833–842.
- [Ro] T. Robinson, On replacement axioms for the Jacobi identity for vertex algebras and their modules, *J. Pure Appl. Algebra* **214** (2010), no. 10, 1740–1758.
- [Sa] R. Sato, Equivalences between weight modules via $N = 2$ coset constructions, [arXiv:1605.02343](https://arxiv.org/abs/1605.02343).
- [TK1] A. Tsuchiya and A. Kanie, Fock space representations of the Virasoro algebra: Intertwining operators, *Publ. Res. Inst. Math. Sci.* **22** (1986), no. 2, 259–327.
- [TK2] A. Tsuchiya and A. Kanie, Fock space representations of Virasoro algebra and intertwining operators, *Proc. Japan Acad. Ser. A Math. Sci.* **62** (1986), no. 1, 12–15.
- [TW1] A. Tsuchiya and S. Wood, The tensor structure on the representation category of the W_p triplet algebra, *J. Phys. A* **46** (2013), no. 44, 445203, 40 pp.
- [TW2] A. Tsuchiya and S. Wood, On the extended W -algebra of type \mathfrak{sl}_2 at positive rational level, *Int. Math. Res. Not. IMRN* 2015, no. 14, 5357–5435.
- [Tu1] V. Turaev, *Quantum invariants of knots and 3-manifolds*, de Gruyter Studies in Mathematics, Vol. 18, Walter de Gruyter & Co., Berlin, 1994.
- [Tu2] V. Turaev, Homotopy field theory in dimension 3 and crossed group-categories, [arXiv:math/0005291](https://arxiv.org/abs/math/0005291)
- [Ve] E. Verlinde, Fusion rules and modular transformations in 2D conformal field theory, *Nucl. Phys. B* **300** (1988), no. 3, 360–376.
- [Wa1] M. Wakimoto, *Infinite-dimensional Lie algebras*, Translations of Mathematical Monographs, Vol. 195, Iwanami Series in Modern Mathematics, American Mathematical Society, Providence, RI, 2001.
- [Wa2] M. Wakimoto, Fusion rules for $N = 2$ superconformal modules, [arXiv:hep-th/9807144](https://arxiv.org/abs/hep-th/9807144).
- [Xu1] F. Xu, New braided endomorphisms from conformal inclusions, *Comm. Math. Phys.* **192** (1998), no. 2, 349–403.
- [Xu2] X. Xu, Intertwining operators for twisted modules of a colored vertex operator superalgebra, *J. Algebra* **175** (1995), no. 1, 241–273.
- [Ya1] H. Yamauchi, *A Theory of Simple Current Extensions of Vertex Operator Algebras and Applications to the Moonshine Vertex Operator Algebra*, Ph.D. thesis, University of Tsukuba, 2004.
- [Ya2] H. Yamauchi, Module categories of simple current extensions of vertex operator algebras, *J. Pure Appl. Algebra* **189** (2004), no. 1-3, 315–328.
- [Ya3] H. Yamauchi, Extended Griess algebras and Matsuo-Norton trace formulae, *Conformal field theory, automorphic forms and related topics*, 75–107, Contrib. Math. Comput. Sci., Vol. 8, Springer, Heidelberg, 2014.

[Zh] Y. Zhu, Modular invariance of characters of vertex operator algebras, *J. Amer. Math. Soc.* **9** (1996), no. 1, 237–302.

(T. C.) Department of Mathematical and Statistical Sciences, University of Alberta, Edmonton, Alberta T6G 2G1, Canada
E-mail: creutzig@ualberta.ca

(S. K.) Department of Mathematical and Statistical Sciences, University of Alberta, Edmonton, Alberta T6G 2G1, Canada
Current address: Department of Mathematics, University of Denver, Denver, Colorado 80210, USA
E-mail: shashank.kanade@du.edu

(R. M.) Department of Mathematics, Vanderbilt University, Nashville, Tennessee 37240, USA
Current address: Yau Mathematical Sciences Center, Tsinghua University, Beijing 100084, China
E-mail: rhmcræ@tsinghua.edu.cn