

TROPICAL MODULI SPACES OF STABLE MAPS TO A CURVE

ANDREAS GATHMANN, HANNAH MARKWIG, AND DENNIS OCHSE

ABSTRACT. We construct moduli spaces of rational covers of an arbitrary smooth tropical curve in \mathbb{R}^r as tropical varieties. They are contained in the balanced fan parametrizing tropical stable maps of the appropriate degree to \mathbb{R}^r . The weights of the top-dimensional polyhedra are given in terms of certain lattice indices and local Hurwitz numbers.

1. INTRODUCTION

Tropical enumerative geometry has developed from interesting applications following so-called correspondence theorems which settle the equality of certain enumerative numbers in algebraic geometry to their tropical counterparts [Mik05]. There is an ongoing effort to put the striking similarities between algebro-geometric and tropical enumerative geometry onto a more solid ground.

Modern enumerative algebraic geometry is based on the moduli spaces $\overline{M}_{g,n}(X, \beta)$ of n -pointed stable maps of genus g and class β to a smooth projective variety X [FP97], together with their virtual fundamental classes [BF97, Beh97] that resolve the issues arising when these spaces are not of the expected dimension. Hence a key ingredient for the further development of tropical enumerative geometry is the construction of tropical analogues of these concepts. If $g = 0$ and X is a toric variety, corresponding to rational tropical curves in \mathbb{R}^r , such tropical spaces have been constructed as balanced fans in [GKM09]. In this case, ideas relating to virtual fundamental classes are not needed, and the intersection theory of the resulting spaces recovers the correspondence theorems for rational tropical curves in \mathbb{R}^r [Gro14].

For more general target spaces, we run into the same problems as in algebraic geometry: the naively defined spaces of tropical curves in a tropical variety are usually not of the expected dimension, maybe not even pure-dimensional. However, as there is no general theory of virtual fundamental classes in tropical geometry yet, the tropical approach to this problem is different: right from the start we have to construct the moduli spaces as balanced polyhedral complexes of the expected dimension — which necessarily means that they are *not* just the spaces of maps from a tropical curve to the given target. From an algebro-geometric point of view, one could say that this constructs the moduli space and its virtual fundamental class at the same time, with the additional benefit that (in accordance with the general philosophy of tropical intersection theory) we actually obtain a virtual *cycle* and not just a *cycle class*.

Key words and phrases. Tropical geometry, enumerative geometry, Gromov-Witten theory.
2010 Mathematics Subject Classification: 14T05, 14N35, 51M20.

A general approach how this idea might be realized has been presented in [GO17]. Here, we will restrict ourselves to the case when $g = 0$ and the target is a smooth (rational) tropical curve L in \mathbb{R}^r . The resulting moduli spaces $\mathcal{M}_{0,n}(L, \Sigma)$ (where Σ is a degree of tropical curves as in definition 2.4) then describe rational covers of a rational smooth tropical curve.

Tropical covers and tropical Hurwitz numbers (i.e. enumerative numbers counting covers with prescribed properties [BBM11, CJM10]) are useful e.g. for the study of the structural behavior of Hurwitz numbers [CJM11] and in the tropical enumeration of Zeuthen numbers [BBM14]. Spaces of tropical (admissible) covers have been studied in [CMR14] as tropicalizations of corresponding algebro-geometric spaces, in terms of a tropicalization map on the Berkovich analytification. The space of tropical covers of \mathbb{R} has been described in [CMR16] as tropicalization of the open part of a suitable space of relative stable maps (whose compactification is then realized as a tropical compactification defined by the tropical moduli space). The present work complements this point of view by fixing a rational smooth tropical curve $L \subset \mathbb{R}^r$, restricting to genus 0 covers, and embedding the abstract polyhedral subcomplex of the abstract cone complex described in [CMR14] as a balanced polyhedral subcomplex. In this way, we make these moduli spaces accessible to the current state of the art of tropical intersection theory.

As mentioned above, to construct the moduli spaces $\mathcal{M}_{0,n}(L, \Sigma)$ we cannot just take the subset of $\mathcal{M}_{0,n}(\mathbb{R}^r, \Sigma)$ consisting of all stable maps whose image lies in L , as this would yield a non-pure subcomplex with strata of too big dimension. Instead, we have to incorporate the so-called Riemann-Hurwitz condition (see definition 3.2), which implies the algebraic realizability of the corresponding maps. For an example, let $L \subset \mathbb{R}^2$ be the standard tropical line, let Σ be the degree consisting of the directions $(-1, 0)$, $(-1, 0)$, $(0, -1)$, $(0, -1)$, $(2, 2)$, and set $n = 0$. A fan curve in L of this degree — in fact representing the origin of the fan $\mathcal{M}_{0,0}(L, \Sigma)$ — is shown in picture (a) below. It is given by a map from an abstract star curve with 5 ends to L , with the directions and weights on the ends as indicated in the picture.

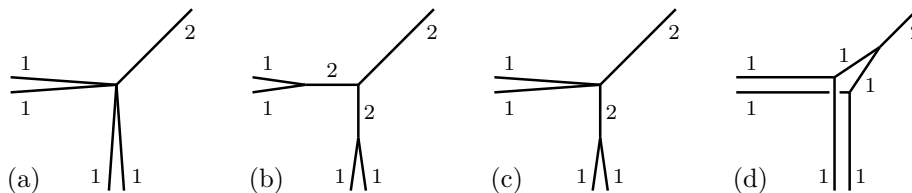

Possible resolutions of this curve in L are shown in (b), (c), and (d). However, case (b) is excluded in $\mathcal{M}_{0,0}(L, \Sigma)$ as its central vertex violates the Riemann-Hurwitz condition: it would correspond to an algebraic degree-2 cover of the projective line by itself with three ramification points of order 2, which does not exist. In contrast, the combinatorial types (c) and (d) are allowed, and represent two rays in $\mathcal{M}_{0,0}(L, \Sigma)$ since they describe 1-dimensional families of curves. They both have a similar type obtained by symmetry: in (c) the bounded weight-2 edge could also be on the horizontal edge of L , and in (d) there are two choices how to group the weight-1 ends. In total, this means that $\mathcal{M}_{0,0}(L, \Sigma)$ is a 1-dimensional fan with four rays. The weights that we will construct on these rays incorporate the triple Hurwitz numbers corresponding to the local degrees of the maps at each point

mapping to the vertex of L ; they all turn out to be 1 here. In this example, it is then easy to check explicitly that $\mathcal{M}_{0,0}(L, \Sigma) \subset \mathcal{M}_{0,0}(\mathbb{R}^2, \Sigma) \cong \mathcal{M}_{0,5} \times \mathbb{R}^2$ is indeed balanced. Our main result on the moduli spaces $\mathcal{M}_{0,n}(L, \Sigma)$ is that this construction works in general:

Theorem 1.1

Let L be a smooth tropical curve in \mathbb{R}^r and Σ a degree of tropical stable maps to L (see definitions 2.4 and 3.3). Then the space $\mathcal{M}_{0,n}(L, \Sigma)$ (with weights defined in terms of local Hurwitz numbers) is a balanced weighted polyhedral subcomplex of $\mathcal{M}_{0,n}(\mathbb{R}^r, \Sigma)$ of pure dimension

$$|\Sigma| - \deg(\Sigma) \cdot \left(\sum_{W \in L} (\text{val}(W) - 2) \right) - 2.$$

We expect that $\mathcal{M}_{0,n}(L, \Sigma)$ is in fact the tropicalization of (relevant parts) of the corresponding algebro-geometric moduli space.

Theorem 1.1 is proved in two major steps: the first being the treatment of 1-dimensional moduli spaces of the form above (see theorem 4.3), and the second the generalization to arbitrary dimension. For the generalization to arbitrary dimension, we use a general gluing construction for tropical moduli spaces which was developed by the first and last author in [GO17] and has further applications to other target spaces.

This paper is organized as follows. In section 2 we review the necessary preliminaries. The tropical moduli spaces $\mathcal{M}_{0,n}(L, \Sigma)$ are then defined in section 3. More precisely, we define their structure as a polyhedral subcomplex of $\mathcal{M}_{0,n}(\mathbb{R}^r, \Sigma)$ in subsection 3.1, and the weights of their maximal cells in subsection 3.2. The definition of the weights relies on the gluing construction of [GO17], which we therefore review in subsection 3.2, together with the main result of [GO17] allowing a gluing construction of tropical moduli spaces under some requirements. In our case, these requirements are satisfied if all one-dimensional tropical moduli spaces $\mathcal{M}_{0,n}(L, \Sigma)$ are balanced fans. We prove this fact in section 4 (see theorem 4.3). Theorem 1.1 is then an immediate consequence of the foundational work on the gluing construction in [GO17].

1.1. Acknowledgments. We would like to thank Erwan Brugallé, Renzo Cavalieri, Simon Hampe, and Diane Maclagan for helpful discussions.

This work would not have been possible without extensive computations of example classes which enabled us to establish and prove conjectures about polyhedra and their weights in our moduli spaces. We used the polymake-extension a-tint [GJ00, Ham14] and GAP [GAP16].

Part of this work was accomplished at the Mittag-Leffler Institute in Stockholm, during the semester program in spring 2011 on Algebraic Geometry with a View towards Applications. The authors would like to thank the institute for hospitality.

The first and second author were partially funded by DFG grant GA 636/4-2 resp. MA 4797/3-2, as part of the DFG Priority Program 1489.

We thank an anonymous referee for helpful comments on an earlier version of this paper.

2. PRELIMINARIES

2.1. Background on tropical varieties and intersection theory. To fix notation, we quickly review notions of tropical intersection theory. Some of our constructions involve partially open versions of tropical varieties, i.e. varieties containing polyhedra that are open at some faces. We adapt the usual conventions to this situation. For a more detailed survey of the relevant preliminaries, see [GO17, section 2.1].

We let Λ be a lattice in an r -dimensional real vector space V . A (*partially open*) (*rational*) *polyhedron* in V is a finite intersection of (open or) closed affine half-spaces given by (strict or) non-strict inequalities whose linear parts are given by elements in the dual of Λ . We denote by V_σ the linear space obtained by shifting the affine span of σ to the origin and define $\Lambda_\sigma := V_\sigma \cap \Lambda$. A *face* $\tau \leq \sigma$ (also written as $\tau < \sigma$ if it is proper) is a non-empty subset of σ that can be obtained by changing some of the defining non-strict inequalities into equalities. If $\dim \tau = \dim \sigma - 1$ we call τ a *facet* of σ . In this case we denote by $u_{\sigma/\tau} \in \Lambda_\sigma/\Lambda_\tau$ the *primitive normal vector* of σ relative to τ , i.e. the unique generator of $\Lambda_\sigma/\Lambda_\tau$ lying in the half-line of σ in $V_\sigma/V_\tau \cong \mathbb{R}$. The well-known notion of a (pure-dimensional) *weighted polyhedral complex* X (formed by cells σ as above, and with integer weights on maximal cells), its dimension and support are easily adapted to the case of partially open polyhedral complexes. Such a (partially open) weighted polyhedral complex (X, ω) is called a (*partially open*) *tropical variety* (or *cycle*, if negative weights occur) if it satisfies the balancing condition, i.e. for each cell τ of codimension 1 we have

$$\sum_{\sigma:\sigma>\tau} \omega(\sigma) \cdot u_{\sigma/\tau} = 0 \quad \in V/V_\tau.$$

For intersection-theoretic purposes, the exact polyhedral complex structure is often not important, and we fix it only up to refinements respecting the weights.

Example 2.1 (Smooth curves)

Let $V = \mathbb{R}^q$. We let L_1^q denote the 1-dimensional tropical variety containing the origin and rays spanned by $-e_i$ (where e_i denotes the canonical basis vectors) and $-e_0 := \sum e_i$, with all weights one. This is the tropicalization of a general line over the Puiseux series with constant coefficient equations [FS05, proposition 2.5 and theorem 4.1]. A one-dimensional tropical variety $L \subset \mathbb{R}^r$ with all weights one is called a *rational smooth curve* if its underlying polyhedral complex is rational (i.e. combinatorially a tree), and if it locally at each vertex equals L_1^q up to a *unimodular transformation*, i.e. up to an isomorphism of vector spaces which is also an isomorphism of the underlying lattices [All12].

Some of our constructions involve *quotients* X/W of partially open tropical varieties X by a *lineality space* W . We say that a vector subspace W of V is a lineality space for X if for all $\sigma \in X$ and $x \in \sigma$ the intersection $\sigma \cap (x + W)$ is open in $x + W$ and equal to $|\sigma| \cap (x + W)$. Note that for the case of a closed polyhedral complex this generalizes the usual notion of a lineality space (which is commonly the maximal subspace with this property). For more details on such quotients, see [GO17, section 2.2].

A *morphism* between (partially open) tropical cycles X and Y is a map $f : |X| \rightarrow |Y|$ which is locally affine linear, with the linear part induced by a map between

the underlying lattices [AR10, definition 7.1]. A *rational function* on a tropical variety X is a continuous function $\varphi : |X| \rightarrow \mathbb{R}$ that is affine linear on each cell, and whose linear part is integer, i.e. in the dual of the lattice. We associate a *divisor* $\varphi \cdot X$ to a rational function; a cycle of codimension 1 in X support on the cells at which φ is not locally linear [AR10, construction 3.3]. Multiple intersection products $\varphi_1 \cdot \dots \cdot \varphi_m \cdot X$ are commutative by [AR10, proposition 3.7].

Remark 2.2 (Weights of intersections as lattice indices)

Often, the weight of a cell of a multiple intersection product can be computed locally in terms of a lattice index. To do this, we write locally $\varphi_i = \max\{h_i, 0\}$ for linearly independent integer linear functions h_1, \dots, h_m , and let H be a matrix representing the integer linear map $\Lambda \rightarrow \mathbb{Z}^m : x \mapsto (h_1(x), \dots, h_m(x))$. Then the local weight of $\varphi_1 \cdot \dots \cdot \varphi_m \cdot X$ equals the greatest common divisor of the maximal minors of H [MR09, lemma 5.1].

Rational functions can be pulled back along a morphism $f : X \rightarrow Y$ to rational functions $f^*(\varphi) = \varphi \circ f$ on X . We can push forward a subvariety Z of X to a subvariety $f_*(Z)$ of $Y \subset \Lambda' \otimes_{\mathbb{Z}} \mathbb{R}$ [AR10, proposition 4.6 and corollary 7.4]: For suitable refinements of the polyhedral structures of X and Y , we obtain $f(\sigma) \in Y$ for all $\sigma \in X$, and define the weight of the push-forward to be

$$\omega_{f_*(Z)}(\sigma') := \sum_{\sigma} \omega_X(\sigma) \cdot |\Lambda'_{\sigma'} / f(\Lambda_{\sigma})|,$$

where the sum goes over all top-dimensional cells $\sigma \in Z$ with $f(\sigma) = \sigma'$. In the partially open case, we will restrict ourselves to injective morphisms in order to avoid problems with overlapping cells with different boundary behavior.

2.2. Tropical moduli spaces of curves. An *(abstract) N -marked rational tropical curve* is a tuple $(\Gamma, x_1, \dots, x_N)$, where Γ is a metric tree with N unbounded edges labeled x_1, \dots, x_N (also called *marked ends*) that have infinite length, and such that the valence of each vertex is at least 3. The set of all N -marked tropical curves is denoted $\mathcal{M}_{0,N}$. It follows from [SS04, theorem 3.4], [Mik07, section 2], or [GKM09, theorem 3.7] that $\mathcal{M}_{0,N}$ can be embedded as a tropical variety via the distance map, more precisely, as a balanced, simplicial, $(N-3)$ -dimensional fan whose top-dimensional cones all have weight one. The distance map sends a tropical curve to the vector of distances of its ends in $\mathbb{R}^{\binom{N}{2}}$. We mod out an N -dimensional lineality space U_N , identifying vectors corresponding to trees whose metrics only differ on the ends. For a tree with only one bounded edge of length one, the ends with markings $I \subset \{1, \dots, N\}$, $1 < |I| < N-1$, on one side and the ends with markings I^c on the other, we denote the equivalence class of its image under the distance map in $\mathbb{R}^{\binom{N}{2}}/U_N$ by v_I . The vectors v_I generate the rays of $\mathcal{M}_{0,N}$ and the lattice we fix for $\mathbb{R}^{\binom{N}{2}}/U_N$.

For local computations, we sometimes use a finite index set I instead of $\{1, \dots, N\}$ as labels for the markings, and denote the corresponding moduli spaces by $\mathcal{M}_{0,I}$. Also, we can modify the definition above by assigning bounded lengths in $\mathbb{R}_{>0}$ to the ends, corresponding to not taking the quotient by U_N . In this case we obtain a partially open moduli space which we will denote by $\mathcal{M}'_{0,N}$. There is then a

map $\mathcal{M}'_{0,N} \rightarrow \mathcal{M}_{0,N}$ forgetting the lengths of the bounded ends, which is just the quotient by U_N .

For every subset $I \subset \{1, \dots, N\}$ of cardinality at least three, there is a *forgetful map* $\text{ft}_I : \mathcal{M}_{0,N} \rightarrow \mathcal{M}_{0,|I|}$ which maps $(\Gamma, x_1, \dots, x_N)$ to the tree where we remove all ends x_i with labels $i \notin I$ (and possibly straighten 2-valent vertices). Forgetful maps are morphisms by [GKM09, proposition 3.9]. In coordinates, we project to distances of ends in I .

Lemma 2.3

A vector x in $\mathbb{R}^{\binom{N}{2}}/U_N$ is zero if and only if $\text{ft}_I(x) = 0$ for all $I \subset \{1, \dots, N\}$ with $|I| = 4$.

Proof:

As ft_I is linear, the “only if” direction is obvious. For the other direction, denote the standard basis vectors of $\mathbb{R}^{\binom{N}{2}}$ by e_{ij} for $i < j$. Let $\tilde{x} = \sum_{i < j} \lambda_{ij} e_{ij} \in \mathbb{R}^{\binom{N}{2}}$ be a representative of x . For any I with $|I| = 4$, the assumption $\text{ft}_I(x) = 0$ means that the projection $\sum_{i,j \in I; i < j} \lambda_{ij} e_{ij}$ is in U_4 . By definition of U_4 , it follows that there is a vector $\mu \in \mathbb{R}^I$ such that $\lambda_{ij} = \mu_i + \mu_j$ for all $i < j$ in I , and thus that $\lambda_{ik} + \lambda_{jl} = \lambda_{ij} + \lambda_{kl}$ if $I = \{i, j, k, l\}$.

But this means that for all $i = 1, \dots, N$ the assignment

$$\lambda_i := \frac{1}{2}(\lambda_{ij} + \lambda_{ik} - \lambda_{jk}) \quad \text{for arbitrary } j, k \neq i$$

is well-defined, because if m is another index we have

$$\begin{aligned} \frac{1}{2}(\lambda_{ij} + \lambda_{ik} - \lambda_{jk}) &= \frac{1}{2}(\lambda_{im} + \lambda_{ik} - \lambda_{mk}) + \frac{1}{2}(\lambda_{ij} - \lambda_{im} + \lambda_{mk} - \lambda_{jk}) \\ &= \frac{1}{2}(\lambda_{im} + \lambda_{ik} - \lambda_{mk}). \end{aligned}$$

As the definition of λ_i also implies that $\lambda_{ij} = \lambda_i + \lambda_j$ for all $i < j$, we conclude that $\tilde{x} \in U_N$, and hence $x = 0$. \square

Definition 2.4 (Tropical stable maps)

Let $n \in \mathbb{N}$ and $N \geq n$. Consider a tuple $(\Gamma, x_1, \dots, x_N, h)$, where $(\Gamma, x_1, \dots, x_N)$ is an N -marked abstract rational tropical curve and $h : \Gamma \rightarrow \mathbb{R}^r$ is a continuous map that is integer linear on each edge. For an edge e starting at a vertex V of Γ , we denote the tangent vector of $h|_e$ at V by $v(e, V) \in \mathbb{Z}^r$ and call it the *direction* of e at V . If e is an end and V its only neighboring vertex we write $v(e, V)$ also as $v(e)$ for simplicity.

We say that $(\Gamma, x_1, \dots, x_N, h)$ is an n -marked (*rational*) *tropical stable map* to \mathbb{R}^r , also called a (*parametrized*) n -marked curve in \mathbb{R}^r [GKM09, definition 4.1], if

- h satisfies the balancing condition $\sum_{e \ni V} v(e, V) = 0$ at each vertex V of Γ ;
- $v(x_i) = 0$ for $i = 1, \dots, n$ (i.e. each of the first n ends is contracted by h), whereas $v(x_i) \neq 0$ for $i > n$ (i.e. the remaining $N - n$ ends are “non-contracted ends”).

Two n -marked tropical stable maps $(\Gamma, x_1, \dots, x_N, h)$ and $(\tilde{\Gamma}, \tilde{x}_1, \dots, \tilde{x}_N, \tilde{h})$ in \mathbb{R}^r are isomorphic (and will from now on be identified) if there is an isomorphism φ of the underlying N -marked abstract curves such that $\tilde{h} \circ \varphi = h$.

The *degree* of an n -marked tropical stable map is the N -tuple

$$\Sigma = (v(x_1), \dots, v(x_N)) \in (\mathbb{Z}^r)^N$$

of directions of its ends, including the zero directions at the first n ends. Its *combinatorial type* is given by the data of the combinatorial type of the underlying abstract marked tropical curve $(\Gamma, x_1, \dots, x_N)$ (i.e. where we drop the metrization data) together with the directions of all its edges.

The space of all n -marked rational tropical stable maps of a given degree Σ in \mathbb{R}^r is denoted by $\mathcal{M}_{0,n}(\mathbb{R}^r, \Sigma)$.

Since n equals the number of zero-entries in Σ and thus can be deduced from Σ , we sometimes drop the subscript and write only $\mathcal{M}_0(\mathbb{R}^r, \Sigma)$. While all N ends come with markings x_1, \dots, x_N , only the ends with markings x_1, \dots, x_n are contracted (i.e. have zero direction) and are thus highlighted in the notation.

Remark 2.5 ($\mathcal{M}_{0,n}(\mathbb{R}^r, \Sigma)$ as a tropical variety)

We assume $n \geq 1$. Then by [GKM09, proposition 4.7], $\mathcal{M}_{0,n}(\mathbb{R}^r, \Sigma)$ is a tropical variety, identified with $\mathcal{M}_{0,N} \times \mathbb{R}^r$ via the map

$$\mathcal{M}_{0,n}(\mathbb{R}^r, \Sigma) \rightarrow \mathcal{M}_{0,N} \times \mathbb{R}^r, \quad (\Gamma, x_1, \dots, x_N, h) \mapsto ((\Gamma, x_1, \dots, x_N), h(x_1))$$

which forgets h , but records the image $h(x_1)$ of a root vertex. It thus inherits the fan structure of $\mathcal{M}_{0,N}$. In particular, it can be embedded via this map into $\mathbb{R}^{\binom{N}{2}}/U_N \times \mathbb{R}^r$. When we work with an element of $\mathcal{M}_{0,n}(\mathbb{R}^r, \Sigma)$ in coordinates, we usually give its coordinates in $\mathbb{R}^{\binom{N}{2}} \times \mathbb{R}^r$, i.e. its image under the distance map and the position of the root vertex. If $n = 0$ it is still possible to find suitable coordinates for $\mathcal{M}_{0,n}(\mathbb{R}^r, \Sigma)$ as $\mathcal{M}_{0,N} \times \mathbb{R}^r$, not by evaluating a marked end but by evaluating for example a barycenter [Och13, construction 1.2.21].

For each $i = 1, \dots, n$, we have the *evaluation map*

$$\text{ev}_i : \mathcal{M}_{0,n}(\mathbb{R}^r, \Sigma) \rightarrow \mathbb{R}^r$$

assigning to a tropical stable map $(\Gamma, x_1, \dots, x_n, h)$ the position $h(x_i)$ of its i -th marked end. It is shown in [GKM09, proposition 4.8] that these maps are morphisms of tropical fans.

As above, we will also allow curves in \mathbb{R}^r where some of the non-contracted ends are bounded, and write the corresponding moduli spaces as $\mathcal{M}'_{0,n}(\mathbb{R}^r, \Sigma)$.

In the following, we will compute several intersection products in cells of tropical moduli spaces. Since we are often interested in a local situation, we can restrict to curves of a given combinatorial type α . Local coordinates for the cell of curves of type α are given by the coordinates of the root vertex and the lengths of each bounded edge. The map sending a unit vector in these local coordinates to a vector v_I as above is a unimodular transformation to the vector space spanned by the corresponding cell in the moduli space. Therefore we can compute lattice indices also in these local coordinates.

3. THE POLYHEDRAL COMPLEX $\mathcal{M}_{0,n}(L, \Sigma)$ AND ITS GLUING WEIGHTS

For the whole section, let $L \subset \mathbb{R}^r$ be a smooth tropical curve as in example 2.1, and let Σ be the degree of a tropical n -marked stable map to \mathbb{R}^r . We want to define a moduli space $\mathcal{M}_{0,n}(L, \Sigma)$ of tropical n -marked stable maps to L as a tropical variety. Let us first construct this space as a polyhedral complex, and then define its weights in the next subsection.

3.1. The polyhedral complex $\mathcal{M}_{0,n}(L, \Sigma)$. We have already mentioned that not all stable maps with image in L will be allowed in $\mathcal{M}_{0,n}(L, \Sigma)$. Instead, we have to impose the so-called Riemann-Hurwitz condition that we introduce now. As we will see in construction 3.11, it corresponds to a local realizability condition.

Notation 3.1 (Covering degrees)

Let $(\Gamma, x_1, \dots, x_N, h) \in \mathcal{M}_{0,n}(\mathbb{R}^r, \Sigma)$ satisfy $h(\Gamma) \subset L$ as sets. As L is irreducible we have $h_*(\Gamma) = d \cdot L$ for some integer d (which depends only on Σ). We call d the *covering degree* of the stable map and denote it by $\deg(\Sigma)$.

For a vertex V of Γ , the *local degree* Σ_V at V is the collection of the directions of its adjacent edges, labeled in an arbitrary way starting with the zero directions. We let $N_V = |\Sigma_V|$ and n_V the number of zero directions in Σ_V (which may come from marked ends or contracted bounded edges). The local covering degree will be denoted $d_V = \deg(\Sigma_V)$.

Definition 3.2 (Riemann-Hurwitz number)

Let $(\Gamma, x_1, \dots, x_N, h) \in \mathcal{M}_{0,n}(\mathbb{R}^r, \Sigma)$ satisfy $h(\Gamma) \subset L$. We define the *Riemann-Hurwitz number* of a vertex V of Γ with image $W = h(V)$ as

$$\text{RH}(V) = N_V - n_V - d_V \cdot (\text{val}(W) - 2) - 2$$

(where $\text{val } W = 2$ if W lies in the interior of an edge of L). Note that it depends only on the combinatorial type of the stable map.

The Riemann-Hurwitz number gives a realizability condition for tropical stable maps to smooth curves. It appears e.g. in [BBM11, definition 2.2], [Cap14, proposition 2.4], [CMR14, section 3.2.2], and [BM13a, definition 3.11].

Definition 3.3 ($\mathcal{M}_{0,n}(L, \Sigma)$ as a polyhedral complex)

Let α be a combinatorial type of tropical stable maps in $\mathcal{M}_{0,n}(\mathbb{R}^r, \Sigma)$. We denote the subset of maps $(\Gamma, x_1, \dots, x_N, h)$ of type α and satisfying $h(\Gamma) \subset L$ by $\mathcal{M}(\alpha)$; this is easily seen to be a partially open polyhedron. Let $\mathcal{M}_{0,n}(L, \Sigma)$ be the set of all such cells $\mathcal{M}(\alpha)$ with $\text{RH}(V) \geq 0$ for all vertices V in α ; this is a polyhedral complex [BM13b].

Note that this definition of $\mathcal{M}_{0,n}(L, \Sigma)$ formally differs from the one used in [GO17] in order to make it compatible with the literature mentioned above. In [GO17, definition 3.8], more cells are included a priori, but they obtain weight zero in the gluing construction of subsection 3.2.

Remark 3.4 (Dimension of $\mathcal{M}_{0,n}(L, \Sigma)$)

By an easy generalization of [BM13b, lemma 2.14], it follows that $\mathcal{M}_{0,n}(L, \Sigma)$ is pure

of dimension $|\Sigma| - \deg(\Sigma) \cdot \sum_{W \in L} (\text{val}(W) - 2) - 2$. The maximal cells correspond to combinatorial types such that

- each vertex mapping to a vertex of L satisfies $\text{RH}(V) = 0$,
- each vertex mapping to an edge of L is 3-valent, and
- no edge is contracted to a vertex.

More precisely, we have:

Lemma 3.5 (Dimension of cells of $\mathcal{M}_{0,n}(L, \Sigma)$)

Let α be a combinatorial type in $\mathcal{M}_{0,n}(L, \Sigma)$. The dimension of the corresponding cell $\mathcal{M}(\alpha)$ equals the number of vertices mapping to edges of L plus the number of bounded edges mapping to vertices of L .

Intuitively, this holds true since we can independently vary the length of each bounded edge mapping to a vertex without leaving the cell of a combinatorial type, as well as the lengths of edges adjacent to a vertex mapping to an edge, in the appropriate way that “moves” the vertex along the edge.

3.2. The gluing construction for moduli spaces. In this section, we want to equip $\mathcal{M}_{0,n}(L, \Sigma)$ with weights satisfying the balancing condition, to make it a tropical variety. To do this, we review the general technique developed in [GO17], adapted to the case when the target of the stable maps is a smooth curve. The idea is to construct the tropical moduli spaces by a gluing procedure from local moduli spaces for the vertices. This construction depends on a condition: all vertices appearing in a combinatorial type of the moduli space are required to be “good”. We start by repeating the relevant definitions in the case of smooth curves.

Notation 3.6 (Links of vertices)

Let $(\Gamma, x_1, \dots, x_n, h) \in \mathcal{M}_{0,n}(L, \Sigma)$, and let V be a vertex of Γ . We denote by L_V the link of L around $h(V)$. Generalizing the notation of example 2.1, we denote a point by L_0^q , so that L_V is (an affine shift of a unimodular transformation of) $L_r^q \times \mathbb{R}^s$, where $r + s = 1$ and $q = 0$ if $r = 0$. Hence we have $(r, s) = (1, 0)$ if V maps to a vertex of L (of valence $q + 1$), and $(r, s) = (0, 1)$ if V maps to an edge. Note that there is an associated local moduli space $\mathcal{M}_0(L_V, \Sigma_V)$.

Definition 3.7 (Resolution dimension)

For a tropical stable map $(\Gamma, x_1, \dots, x_n, h) \in \mathcal{M}_{0,n}(L, \Sigma)$, let V be a vertex of Γ with image $W = h(V) \in L$. As in notation 3.6, we have $L_V \cong L_r^q \times \mathbb{R}^s$ with $r + s = 1$ and $q = 0$ if $r = 0$. Treating again a point on an edge of L as a 2-valent vertex, we define the *resolution dimension* of V as

$$\text{rdim}(V) = N_V - d_V \cdot (\text{val}(W) - 2) + r - 3$$

and the *classification number* as

$$c_V = N_V + r \in \mathbb{N}.$$

Remark 3.8 (Dimension of local moduli spaces)

By the dimension formula, we see that the local moduli space at V has dimension $\dim \mathcal{M}_0(L_V, \Sigma_V) = \text{rdim}(V) + s$, where again $L_V \cong L_r^q \times \mathbb{R}^s$. As this moduli space

has an s -dimensional lineality space coming from shifting the curves along \mathbb{R}^s , the resolution dimension of V is just the dimension of the local moduli space at V modulo its lineality space.

Remark 3.9 (Dimension of $\mathcal{M}_{0,n}(L, \Sigma)$ in terms of resolution dimensions)

Let α be a combinatorial type in $\mathcal{M}_{0,n}(L, \Sigma)$, and assume that α has s vertices mapping to an edge in L (i.e. so that the corresponding link is $L_0^0 \times \mathbb{R}$). Adding up the resolution dimensions of all vertices in α , we obtain by remark 3.4

$$\sum_V \text{rdim}(V) + s = \dim \mathcal{M}_{0,n}(L, \Sigma).$$

Remark 3.10

Note that $\text{rdim}(V)$ and $\text{RH}(V)$ are very similar: in fact, $\text{rdim}(V)$ is just $\text{RH}(V)$ with additional contributions

- (a) n_V of the number of contracted edges at V , and
- (b) -1 if V maps to an edge of L .

In particular, the condition $\text{RH}(V) \geq 0$ of definition 3.3 also implies $\text{rdim}(V) \geq 0$ (otherwise we would have $\text{RH}(V) = 0$ and $\text{rdim}(V) = -1$, i.e. V maps to an edge, $N_V = 2$, and $n_V = 0$, which is a contradiction since we do not allow 2-valent vertices).

The reason to introduce the numbers of definition 3.7 is that they are used in the recursive definition of good vertices and the weights of $\mathcal{M}_{0,n}(L, \Sigma)$ below. For this construction we start with the case of resolution dimension 0 and pass to the general case by gluing. The initial case is obtained by passing to the corresponding situation in algebraic geometry and considering (algebraic) Hurwitz numbers.

Construction 3.11 (Algebraic moduli spaces for a vertex)

Let V be a vertex of a combinatorial type in $\mathcal{M}_{0,n}(L, \Sigma)$ such that $L_V \cong L_1^q$. Up to unimodular transformation, $\Sigma_V = (\delta_1, \dots, \delta_{N_V})$ is a degree of tropical stable maps to \mathbb{R}^q with ends in the directions of L_1^q . We decompose $\{1, \dots, N_V\}$ into a partition η_0, \dots, η_q and η , where

$$\eta_i = \{j | \delta_j = -m_j e_i \text{ for some } m_j \in \mathbb{N}_{>0}\}$$

and $\eta = \{j | \delta_j = 0\}$. This also uniquely defines the values m_j as the weights of the edges adjacent to V .

To construct an algebraic moduli space for V , fix $q+1$ distinct points P_0, \dots, P_q on the complex projective line \mathbb{P}^1 . Inside the well-known moduli stack $\overline{M}_{0,N_V}(\mathbb{P}^1, d_V)$ of N_V -marked degree- d_V rational stable maps to \mathbb{P}^1 , consider the substack $M(\Sigma_V)$ of all smooth stable maps $\mathcal{C} = (C, x_1, \dots, x_{N_V}, \pi)$ such that $\pi^* P_i = \sum_{j \in \eta_i} m_j x_j$ for all $i = 0, \dots, q$, i.e. such that the ramification profile of π over P_0, \dots, P_q is as specified by Σ_V . We denote its closure inside $\overline{M}_{0,N_V}(\mathbb{P}^1, d_V)$ by $\overline{M}(\Sigma_V)$, and its boundary by $\partial M(\Sigma_V) = \overline{M}(\Sigma_V) \setminus M(\Sigma_V)$. Its dimension is

$$\dim M(\Sigma_V) = 2d_V - 2 + N_V - d_V \cdot (q+1) = \text{rdim}(V).$$

Construction 3.12 (The case of resolution dimension 0)

Let V be a vertex of a combinatorial type in $\mathcal{M}_{0,n}(L, \Sigma)$ with $\text{rdim}(V) = 0$, where

$L_V \cong L_r^q \times \mathbb{R}^s$ as above. Then $\dim \mathcal{M}_0(L_V, \Sigma_V) \cong \mathbb{R}^s$ by remark 3.8, i.e. the local moduli space at V consists of only one cell. We make it into a tropical variety by giving it the following local weight ω_V , depending on whether V maps to a vertex or to an edge of L .

- (a) If $L_V \cong L_1^q$, the algebraic moduli space $\overline{M}(\Sigma_V)$ of construction 3.11 has dimension zero. We define the *local weight* of V to be $\omega_V := \deg \overline{M}(\Sigma_V)$; i.e. the number of points in $\overline{M}(\Sigma_V)$, counted with weight $|\text{Aut}(\pi)|^{-1}$ as we work with a stack. This number is also called the (*marked*) *Hurwitz number* and denoted $H(\Sigma_V)$.
- (b) If $L_V \cong L_0^0 \times \mathbb{R}$, the dimension condition implies $N_V = 3$. In this case, we set $\omega_V := 1$.

In fact, the second case could be treated similarly to the first one by introducing a rubber variant of the moduli space $\overline{M}(\Sigma_V)$. We avoid this formulation for the sake of simplicity.

Let us now describe the gluing construction that gives the local moduli space $\mathcal{M}_0(L_V, \Sigma_V)$ of a vertex V the structure of a tropical variety if $\text{rdim}(V) > 0$. In the following, any combinatorial type occurring in $\mathcal{M}_0(L_V, \Sigma_V)$ will be called a *resolution* of V . For a combinatorial type α occurring in a moduli space we denote by $\mathcal{N}(\alpha)$ the “neighborhood of α ”, i.e. the union of all cells $\mathcal{M}(\beta)$ whose closure intersects $\mathcal{M}(\alpha)$.

Definition 3.13 of a good vertex and the following gluing construction 3.14 depend on each other and work in a combined recursion on the classification number of vertices. The following definition of a good vertex thus assumes that good vertices of lower classification number are already defined recursively. Moreover, for every combinatorial type α in a local moduli space $\mathcal{M}_0(L_V, \Sigma_V)$ all of whose vertices have smaller classification number and are good it assumes that there is a gluing cycle in the neighborhood $\mathcal{N}(\alpha)$ from construction 3.14.

Definition 3.13 (Good vertices [GO17, definition 3.11])

Let V be a vertex of a (local) tropical stable map in $\mathcal{M}_0(L_V, \Sigma_V)$, so that in particular $\text{rdim}(V) \geq 0$. The vertex V is called *good* if the following holds:

- (a) Every vertex of every resolution α of V in $\mathcal{M}_0(L_V, \Sigma_V)$ (which has classification number smaller than c_V by [GO17, lemma 3.6]) is good (so that a gluing cycle is defined on $\mathcal{N}(\alpha)$ by construction 3.14).
- (b) If $\text{rdim}(V) > 0$ the maximal types in $\mathcal{M}_0(L_V, \Sigma_V)$ are resolutions of V . We let $\mathcal{M}_0(L_V, \Sigma_V)$ be a weighted polyhedral complex by defining the weights on maximal cells $\mathcal{M}(\alpha) = \mathcal{N}(\alpha)$ using the gluing construction 3.14. If $\text{rdim}(V) = 0$, we equip the unique cell of $\mathcal{M}_0(L_V, \Sigma_V)$ with the weight of construction 3.12. We require that the space $\mathcal{M}_0(L_V, \Sigma_V)$ is a tropical cycle with these weights.
- (c) For every resolution α of V in $\mathcal{M}_0(L_V, \Sigma_V)$ and every maximal type β such that $\overline{\mathcal{M}(\beta)}$ contains $\mathcal{M}(\alpha)$ in $\mathcal{M}_0(L_V, \Sigma_V)$ (β is then also a resolution of V), the weight of β is the same in the gluing cycles $\mathcal{N}(\alpha)$ and $\mathcal{N}(\beta)$.

In the following review of the gluing construction from [GO17, construction 3.12], we omit some of the technical details for the sake of clarity.

Construction 3.14 (The gluing construction for a combinatorial type α)

Fix a (not necessarily maximal) combinatorial type α of curves in $\mathcal{M}_{0,n}(L, \Sigma)$ and assume that all its vertices are good. We will construct weights on the maximal cells of the neighborhood $\mathcal{N}(\alpha)$ such that this partially open polyhedral complex becomes a tropical cycle. In particular, if α is already maximal this defines a weight on $\mathcal{M}(\alpha) = \mathcal{N}(\alpha)$.

We cut each bounded edge of α at some point in its interior, and in addition introduce lengths for all ends. This yields a set of connected components α_V , each containing only one vertex V , edges of directions Σ_V , and (now bounded) ends labeled by an index set I_V .

For every such vertex V , consider the local moduli space $\mathcal{M}_0(L_V, \Sigma_V)$, which is a tropical variety since V is good. We introduce lengths on all ends of Σ_V , obtaining a moduli space $\mathcal{M}'_0(L_V, \Sigma_V)$ (of which $\mathcal{M}_0(L_V, \Sigma_V)$ is a quotient) as in subsection 2.2. Each bounded end $i \in I_V$ is mapped to an edge or vertex of L that we denote by σ_i . We consider the open subcomplex of $\mathcal{M}'_0(L_V, \Sigma_V)$ of all curves for which the evaluation at i still lies in σ_i , i.e. the partially open tropical subvariety

$$\mathcal{M}_V := \bigcap_{i \in I_V} \text{ev}_i^{-1}(\sigma_i)$$

of $\mathcal{M}'_0(L_V, \Sigma_V)$.

Now we want to glue these pieces \mathcal{M}_V back together. Consider a bounded edge e of α adjacent to two vertices $V_1(e)$ and $V_2(e)$, and denote the two bounded ends produced by cutting e by $i_1(e) \in I_{V_1(e)}$ and $i_2(e) \in I_{V_2(e)}$, where $\sigma_{i_1(e)} = \sigma_{i_2(e)} =: \sigma_e$. There is a corresponding evaluation map

$$\text{ev}_e := (\text{ev}_{i_1(e)} \times \text{ev}_{i_2(e)}) : \prod_V \mathcal{M}_V \longrightarrow \sigma_e \times \sigma_e$$

at the endpoints of these two bounded ends in the factors for V_1 and V_2 . To impose the condition that these ends fit together to form the edge e we need to pull back the diagonal Δ_{σ_e} via ev_e [GO17, appendix A]. We abbreviate all these pull-backs by

$$\text{ev}^*(\Delta_L) \cdot \prod_V \mathcal{M}_V := \prod_e \text{ev}_e^* \Delta_{\sigma_e} \cdot \prod_V \mathcal{M}_V,$$

where e runs over all bounded edges e of α . By construction, this cycle consists of stable map pieces that glue back to a stable map in $\mathcal{M}_{0,n}(L, \Sigma)$. However, it also carries the superfluous information on the position of the gluing points. To get rid of this we apply the quotient map q by the lineality space generated by the appropriate differences of vectors taking care of the lengths of the bounded ends, and by the vectors taking care of ends which should be unbounded. We finally use a morphism f identifying a stable map glued from pieces with the corresponding element in $\mathcal{M}_{0,n}(L, \Sigma)$, where we use the distance and barycentric coordinates mentioned in remark 2.5. Hence we get a partially open tropical cycle

$$f_* q \left[\text{ev}^*(\Delta_L) \cdot \prod_V \mathcal{M}_V \right] \quad \text{in } \mathcal{M}_{0,n}(L, \Sigma).$$

Its weights on the maximal cells of $\mathcal{M}_{0,n}(L, \Sigma)$ will be called the *gluing weights*. It is easy to see that the gluing morphism f is unimodular and induces a bijection of

cells. In particular, the weight of a maximal cell in $f_*q[\text{ev}^*(\Delta_L) \cdot \prod_V \mathcal{M}_V]$ is equal to the weight of $\text{ev}^*(\Delta_L) \cdot \prod_V \mathcal{M}_V$ in the corresponding cell of $\prod_V \mathcal{M}_V$. By remark 2.2, it can be computed as the greatest common divisor of the maximal minors of a matrix whose rows represent the differences $\text{ev}_{i_1(e)} - \text{ev}_{i_2(e)}$ in local coordinates.

Example 3.15

Let $L = L_1^2$ be a tropical line in \mathbb{R}^2 and let α be a combinatorial type of degree- Σ curves in L_1^2 as shown below on the left (where the directions of the edges indicate their images in \mathbb{R}^2). Then $\text{rdim}(V_0) = 0$. We assume in addition that $\text{rdim}(V_1) = 0$.

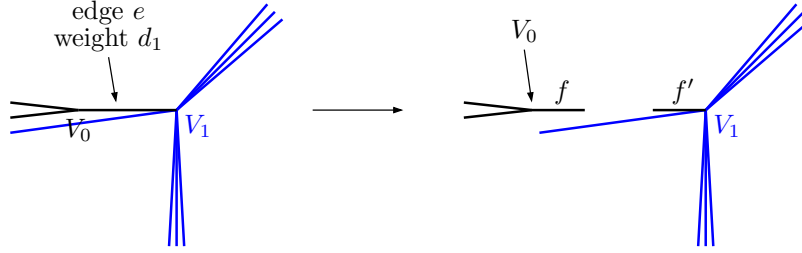

We cut the unique bounded edge e of weight d_1 , obtaining two bounded ends that we denote f and f' . By the assumption on the resolution dimension, the local moduli spaces for V_0 and V_1 consist of only one cell each, and we can explicitly describe isomorphisms to open polyhedra in some \mathbb{R}^k as follows. The space \mathcal{M}_{V_0} is isomorphic to $\mathbb{R}_{>0}^2$, where one coordinate that we denote by l_f corresponds to the length of the bounded end, and the other that we call x_{V_0} to the position of the image of V_0 on the corresponding ray of L . The space \mathcal{M}_{V_1} is $\mathbb{R}_{>0}$ with coordinate $l_{f'}$ corresponding to the length of its bounded end. By construction 3.12, the weight of \mathcal{M}_{V_1} is the Hurwitz number $\omega_{V_1} = H(\Sigma_{V_1})$, whereas \mathcal{M}_{V_0} has weight 1. Using these coordinates, we can pull back the diagonal of L as $\text{ev}_e^* \max\{x - y, 0\} = \max\{\text{ev}_f - \text{ev}_{f'}, 0\}$, where x, y are the coordinates of L^2 on the left ray. By remark 2.2, the weight of $\text{ev}^* \Delta_L \cdot (\mathcal{M}_{V_0} \times \mathcal{M}_{V_1})$ equals the weight of $\mathcal{M}_{V_0} \times \mathcal{M}_{V_1}$ times the greatest common divisor of the maximal minors of the matrix

$$\frac{\quad}{\text{ev}_f - \text{ev}_{f'}} \begin{vmatrix} x_{V_0} & l_f & l_{f'} \\ 1 & -d_1 & -d_1 \end{vmatrix}$$

which is 1. Hence the cell corresponding to α in $\mathcal{M}_0(L, \Sigma)$ has weight $\omega_\alpha = H(\Sigma_{V_1})$. The analogous result holds for $L = L_1^q$ for all q .

Example 3.16

Let $L = L_1^2$ be a tropical line in \mathbb{R}^2 again, and let α be the combinatorial type of degree- Σ curves mapping to L_1^2 depicted below, with V_1 and V_2 mapping to the vertex of L . As above, we then have $\text{rdim}(V_0) = 0$, and assume in addition that $\text{rdim}(V_1) = \text{rdim}(V_2) = 0$.

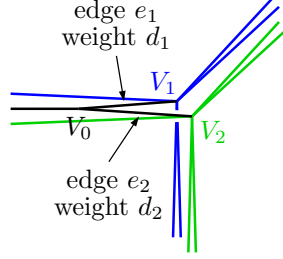

We cut the two edges e_1 of weight d_1 and e_2 of weight d_2 , obtaining four new bounded ends that we denote by f_i and f'_i for $i = 1, 2$. As before, each local moduli space consists of only one cell. The space \mathcal{M}_{V_0} is isomorphic to $\mathbb{R}_{>0}^3$, where two coordinates (l_{f_1} and l_{f_2}) correspond to the lengths of the bounded ends and one (x_{V_0}) to the position of the image of V_0 on the corresponding ray of L . By construction 3.12, it is equipped with weight $\omega_{V_0} = 1$. Similarly, \mathcal{M}_{V_i} for $i = 1, 2$ is isomorphic to $\mathbb{R}_{>0}$, where the coordinate $l_{f'_i}$ is given by the length of the bounded end, and equipped with the appropriate Hurwitz number $\omega_{V_i} = H(\Sigma_{V_i})$ as weight. As in the previous example, pulling back the diagonal of L^2 twice and using remark 2.2, we deduce that the weight of $\text{ev}^* \Delta_L \cdot (\mathcal{M}_{V_0} \times \mathcal{M}_{V_1} \times \mathcal{M}_{V_2})$ equals the weight of $\mathcal{M}_{V_0} \times \mathcal{M}_{V_1} \times \mathcal{M}_{V_2}$ times the greatest common divisor of the maximal minors of the matrix

$$\begin{array}{c|ccccc} & x_{V_0} & l_{f_1} & l_{f_2} & l_{f'_1} & l_{f'_2} \\ \hline \text{ev}_{f_1} - \text{ev}_{f'_1} & 1 & -d_1 & 0 & -d_1 & 0 \\ \text{ev}_{f_2} - \text{ev}_{f'_2} & 1 & 0 & -d_2 & 0 & -d_2, \end{array}$$

which is $\gcd(d_1, d_2)$. Thus the weight of the cell corresponding to α in $\mathcal{M}_0(L, \Sigma)$ equals

$$\omega_\alpha = \gcd(d_1, d_2) \omega_{V_0} \omega_{V_1} \omega_{V_2} = \gcd(d_1, d_2) \cdot H(\Sigma_{V_1}) \cdot H(\Sigma_{V_2}).$$

As in example 3.15, the same result holds for $L = L_1^q$ for all q .

We end this section by stating the main result of [GO17], together with a lemma that provides a major simplification for checking the requirements of the following theorem:

Theorem 3.17 (The gluing theorem [GO17, corollary 3.17])

Assume that all vertices V that can possibly occur in combinatorial types of the moduli space $\mathcal{M}_{0,n}(L, \Sigma)$ are good. Then the gluing construction is well-defined for all these combinatorial types. In particular, $\mathcal{M}_{0,n}(L, \Sigma)$ is a tropical variety.

Lemma 3.18 (Restriction to resolution dimension one [GO17, corollary 3.18])

If all vertices V of combinatorial types of $\mathcal{M}_{0,n}(L, \Sigma)$ with $\text{rdim}(V) = 1$ are good, then all vertices are good.

4. ONE-DIMENSIONAL MODULI SPACES OF RATIONAL COVERS OF SMOOTH TROPICAL CURVES

Throughout this section, let V be a vertex of a combinatorial type in $\mathcal{M}_{0,n}(L, \Sigma)$ with $\text{rdim}(V) = 1$. Our aim is to show that V is good, so that we can apply lemma 3.18 and the gluing theorem 3.17 to deduce theorem 1.1. We continue to

use the notation of section 3. Moreover, let I_V be the set of labels of the ends in the local moduli space $\mathcal{M}_0(L_V, \Sigma_V)$, so that $\mathcal{M}_0(L_V, \Sigma_V) = \mathcal{M}_{0, I_V}(L_V, \Sigma_V)$. As in construction 3.11, let $m_j \in \mathbb{N}_{>0}$ be the weight of the end $j \in I_V$.

To prove that V is good, we have to show by definition 3.13 that

- (1) every vertex appearing in a non-trivial resolution in $\mathcal{M}_0(L_V, \Sigma_V)$ is good;
- (2) $\mathcal{M}_0(L_V, \Sigma_V)$ is a tropical variety with the gluing weights; and
- (3) for every non-trivial resolution α of V , the weight of each maximal cell in the neighborhood $\mathcal{N}(\alpha)$ is the same no matter if we apply the gluing construction for α or just for this maximal cell.

Assume first that V maps to an edge of L , so that $L_V \cong L_0^0 \times \mathbb{R}$. Then $\text{rdim}(V) = 1$ implies $n_V = 4$, hence the possible resolutions are just the usual resolutions of a 4-valent vertex. Also, any gluing weight is just 1, and the balancing condition is satisfied — this is just the usual balancing condition of $\mathcal{M}_{0,4}$. It follows that V is good.

We can thus assume now that V maps to a vertex of L , so that $L_V \cong L_1^q$. By Remark 3.8, this means that $\dim \mathcal{M}_0(L_V, \Sigma_V) = 1$. In particular, every resolution of V corresponds already to a maximal cell of the local moduli space, which implies that condition (3) above is trivially satisfied. Moreover, lemma 3.5 implies that every non-trivial resolution of V has at least one vertex mapping to an edge of L , or a bounded edge contracted to a vertex. In the former case, remark 3.9 then shows that all vertices in this resolution must have resolution dimension 0 and are thus good, and the latter case is an immediate contradiction to remark 3.4. Hence condition (1) is always satisfied as well, and it only remains to check the balancing condition (2).

Next, since $1 - n_V = \text{rdim}(V) - n_V = \text{RH}(V) \geq 0$, we can either have $n_V = 1$ and $\text{RH}(V) = 0$, or $n_V = 0$ and $\text{RH}(V) = 1$. In the first case, there is one contracted end, say with the marking 1, adjacent to the vertex. In the possible resolutions, this contracted end is adjacent to any other of the non-contracted ends, leading to a generating vector of the form $v_{\{1,i\}}$ for the corresponding ray in $\mathcal{M}_0(L_V, \Sigma_V)$. As in example 3.15, we can see that any gluing weight equals $H(\Sigma_V \setminus \{0\})$. We have $\sum_{i=2}^{N_V} v_{\{1,i\}} = 0$ in $\mathcal{M}_0(\mathbb{R}^q, \Sigma_V)$, and hence the balancing condition is satisfied in this case.

So the only thing left to be done is to study the remaining case, where we have a vertex V mapping to a vertex of L , without contracted ends and having $\text{rdim}(V) = 1$, and to prove the balancing condition (2) for the 1-dimensional local moduli space $\mathcal{M}_{0,n}(L, \Sigma)$ in this situation. We start by listing the possible resolutions of such a vertex, i.e. the maximal cones of $\mathcal{M}_{0,n}(L, \Sigma)$.

Construction 4.1 (Resolutions of a vertex with $\text{rdim}(V) = 1$)

Let V be a vertex of a combinatorial type in $\mathcal{M}_{0,n}(L, \Sigma)$. Assume that V maps to $L_V \cong L_1^q$ and satisfies $\text{rdim}(V) = 1$ and $n_V = 0$.

As $\dim \mathcal{M}_0(L_V, \Sigma_V) = 1$, it follows from remark 3.4 and lemma 3.5 that in each (necessarily maximal) resolution of V , there is one (necessarily 3-valent) vertex V_0 mapping to an edge of L_1^q . This vertex can either join two ends or split an end, so that we obtain the following two types of resolutions:

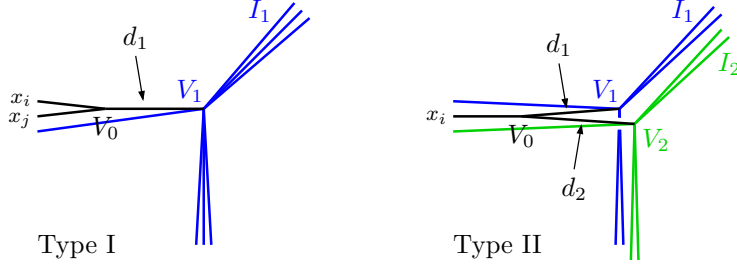

- (I) There is exactly one vertex V_1 mapping to the vertex of L_V . The vertex V_0 is adjacent to two ends $i, j \in I_V$ and a bounded edge of weight $d_1 = m_i + m_j$ connecting V_0 to V_1 . The ends in $I_1 := I_V \setminus \{i, j\}$ are adjacent to V_1 .

Such a type exists for all choices of ends i and j of the same (primitive) direction.

- (II) There are exactly two vertices V_1, V_2 mapping to the vertex of L_V . The vertex V_0 is adjacent to an end $i \in I_V$ and two bounded edges of weights d_1, d_2 with $d_1 + d_2 = m_i$ connecting V_0 to V_1 and V_2 , respectively. The two vertices V_1 and V_2 are adjacent to ends in I_1 and I_2 , respectively, where $I_1 \cup I_2 \cup \{i\} = I_V$.

Such a type exists for all choices of i and all partitions of $I_V \setminus \{i\}$ into I_1 and I_2 for which there is a stable map with the above conditions.

With the notations of section 2, these types correspond to rays of $\mathcal{M}_0(L_V, \Sigma_V)$ generated by the vectors $v_{\{i, j\}}$ for type I and $d_2 v_{I_1} + d_1 v_{I_2}$ for type II (where the latter does not need to be primitive).

Let us now consider the corresponding algebraic situation, i.e. the 1-dimensional algebraic moduli space $\overline{M}(\Sigma_V)$ of construction 3.11. By the Riemann-Hurwitz condition, a point in the open part $M(\Sigma_V)$ corresponds to a cover with precisely one simple ramification which is not marked, and whose image does not coincide with one of the points P_0, \dots, P_q at which we fixed the ramification imposed by Σ_V . The boundary points correspond to degenerate covers that we obtain when the additional branch point runs into a point P_s for $s \in \{0, \dots, q\}$.

As deformations of covers are always local around special fibers [Vak00, proposition 1.1], we see that a cover in $\partial M(\Sigma_V)$ must have exactly one collapsed component, which then has exactly three special points. So we have the following two types for the curves in the boundary $\partial M(\Sigma_V)$, which are exactly dual to the tropical picture above (see [BM13b, proposition 3.12] for a related statement):

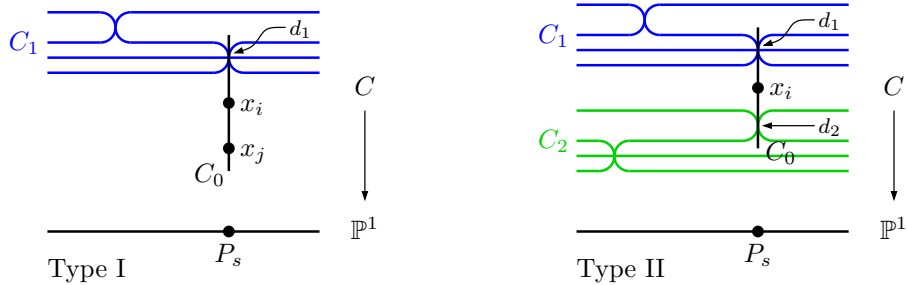

Here, C_0 is the collapsed component, and C_k for $k \in \{1, 2\}$ denotes the at most 2 non-collapsed irreducible components. In the type I case, the map $\pi|_{C_1}$ has order $d_1 := m_i + m_j$ at the singular point of C . In the type II case, the orders d_1 and d_2 of $\pi|_{C_1}$ and $\pi|_{C_2}$ at the singular points of C add up to m_i .

To check the balancing condition in the 1-dimensional fan $\mathcal{M}_0(L_V, \Sigma_V)$, it suffices by lemma 2.3 to consider the situation after applying the various forgetful maps to $\mathcal{M}_{0,4}$. We will do this first in the algebraic and then in the tropical case.

Lemma 4.2 (The pull-back of the forgetful map)

Let $\mathcal{C} \in \partial M(\Sigma_V)$ be a stable map in the boundary of the local moduli space of a vertex V as in construction 4.1. Consider the forgetful map $\text{ft}_I : \overline{M}(\Sigma_V) \rightarrow \overline{M}_{0,I} \cong \mathbb{P}^1$ for a choice of four-element subset $I = \{i, j, k, l\} \subset I_V$. Then the multiplicity $\text{ord}_{\mathcal{C}} \text{ft}_I^*(ij|kl)$ of the pullback of the divisor $(ij|kl)$ on $\overline{M}_{0,I}$ at \mathcal{C} equals

- (a) 1 if \mathcal{C} is of type I, with $x_i, x_j \in C_0$ and $x_k, x_l \in C_1$ or vice versa;
- (b) d_1 if \mathcal{C} is of type II, with $x_i \in C_0$, and $x_j \in C_1$ and $x_k, x_l \in C_2$ or vice versa;
- (c) $d_1 + d_2$ if \mathcal{C} is of type II, with $x_i, x_j \in C_1$ and $x_k, x_l \in C_2$ or vice versa.

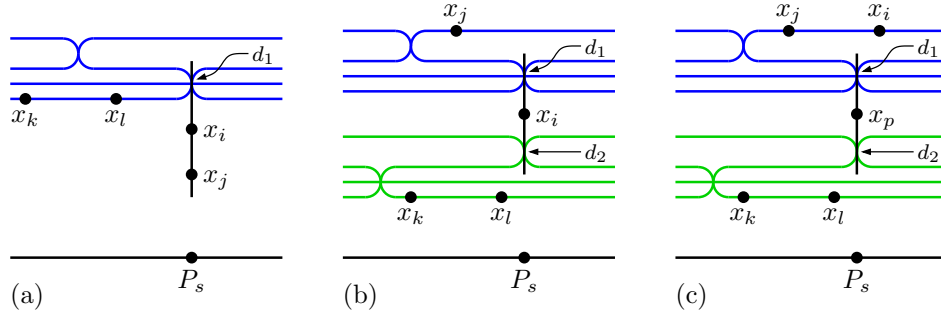

These are all cases in which we have a non-zero multiplicity.

Proof:

Since x_i, x_j and x_k, x_l must lie on different components after applying the forgetful map and \mathcal{C} has at least two and at most three components, it is obvious that we can only have the three cases stated in the lemma. We want to determine the multiplicity of \mathcal{C} in $\text{ft}_I^*(ij|kl)$ for each case. By [Vak00, proposition 1.1], we may replace our family $\overline{M}(\Sigma_V)$ of curves around \mathcal{C} by another family \overline{M} of curves étale locally isomorphic to the original ones around the collapsed component. The following picture illustrates the new curve \mathcal{C} after this replacement in each case; the corresponding families are described below.

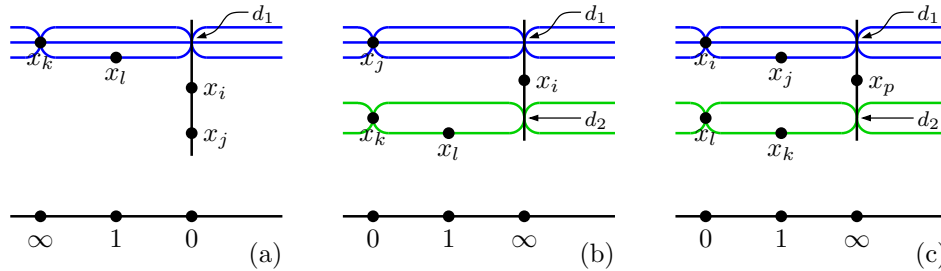

Case (a): Let M be the moduli space of all smooth covers $(C, x_i, x_j, x_k, x_l, \pi)$ of \mathbb{P}^1 of degree $d_1 = m_i + m_j$ satisfying

$$\pi^*0 = m_j x_j + m_i x_i, \quad \pi^*\infty = d_1 x_k, \quad \text{and} \quad \pi(x_l) = 1.$$

On the source curve $C \cong \mathbb{P}^1$, we set $x_i = 0$, $x_j = \infty$, $x_k = 1$, and $x_l = (1 : w)$ with $w \in \mathbb{C}^* \setminus \{1\}$. Then every element in M can be written as

$$\pi(z_0 : z_1) = ((z_0 - z_1)^{d_1} : \lambda z_0^{m_j} z_1^{m_i})$$

for $\lambda \in \mathbb{C}^*$ satisfying $\lambda w^{m_i} = (1 - w)^{d_1}$. Thus, the 1-dimensional space M is parametrized by those $(\lambda, w) \in \mathbb{C}^* \times (\mathbb{C}^* \setminus \{1\})$ with $\lambda w^{m_i} = (1 - w)^{d_1}$. The non-marked branch point of π can be computed to be at $P = (d_1^{d_1} : (-1)^{m_i} m_j^{m_j} m_i^{m_i} \cdot \lambda)$, since the equation $\pi(z_0 : z_1) = P$ has a double root at $(m_j : -m_i)$.

Hence, in this family the singular curve \mathcal{C} in the picture above corresponds to the coordinates $(\lambda, w) = (0, 1)$. After inserting this point into the family, we obtain $\overline{M} \cong \mathbb{C}^*$ via $(\lambda, w) \mapsto w$. The divisor $\text{ft}_I^*(ij|kl)$ is given by the function $w - 1$, which vanishes to order 1 at \mathcal{C} . As \mathcal{C} has no automorphisms due to the marked point x_l , we obtain $\text{ord}_{\mathcal{C}} \text{ft}_I^*(ij|kl) = 1$ as claimed.

Case (b): Now let M be the space of those smooth covers $(C, x_i, x_j, x_k, x_l, \pi)$ of \mathbb{P}^1 of degree $d = m_i$ such that

$$\pi^*0 = d_1 x_j + d_2 x_k, \quad \pi^*\infty = d x_i, \quad \text{and} \quad \pi(x_l) = 1$$

for fixed d_1, d_2 with $d_1 + d_2 = d$. We set $x_k = 1$, $x_i = \infty$, $x_j = 0$, and $x_l = (1 : w)$, where $w \in \mathbb{C}^* \setminus \{1\}$. Then every element of M can be written as

$$\pi(z_0 : z_1) = (\lambda z_0^d : (z_0 - z_1)^{d_2} z_1^{d_1}),$$

where $\lambda \in \mathbb{C}^*$ satisfies $\lambda = (1 - w)^{d_1} w^{d_2}$. The non-marked branch point of a cover π can be computed to be at $P = (\lambda \cdot d^d : d_1^{d_1} d_2^{d_2})$, since the equation $\pi(z_0 : z_1) = P$ has a double root at $(d : d_1)$.

Again, as in the picture above we want to insert the special fiber \mathcal{C} over $(\lambda, w) = (0, 1)$ to obtain the space \overline{M} . As before, $\overline{M} \cong \mathbb{C}^*$ via $(\lambda, w) \mapsto w$, and the divisor $\text{ft}_I^*(ij|kl)$ is given by the function $w - 1$, which vanishes to order 1 at \mathcal{C} . Since \mathcal{C} has d_1 automorphisms on C_1 (which is totally ramified over 0 and ∞), we obtain $\text{ord}_{\mathcal{C}} \text{ft}_I^*(ij|kl) = d_1$.

Case (c): In this case, we use the previous computations and the WDVV equations. Denote by x_p the marked point of \mathcal{C} on the collapsed component. We consider the moduli space \overline{M} which is the closure of all smooth $(C, x_i, x_j, x_k, x_l, x_p, \pi)$ of degree $d = m_p$ such that

$$\pi^*0 = d_1 x_i + d_2 x_l, \quad \pi^*\infty = d x_p, \quad \text{and} \quad \pi(x_j) = \pi(x_k) = 1$$

for fixed d_1, d_2 with $d_1 + d_2 = d$. Again, by the Riemann-Hurwitz formula this is a 1-dimensional space, with one non-marked ramification for a smooth curve in \overline{M} . By letting the additional branch point run into 0, 1 and ∞ , we can see that ∂M contains the following reducible curves:

- (1) a degree- d_1 component with x_i, x_j connected to a degree- d_2 component with x_k, x_l via a collapsed component over ∞ with x_p (this is the curve in the picture above);

- (2) a degree- d_1 component with x_i, x_k connected to a degree- d_2 component with x_j, x_l via a collapsed component over ∞ with x_p ;
- (3) one collapsed component over 0 with x_i, x_l and one degree- d component with x_j, x_k, x_p ;
- (4) one collapsed component over 1 with x_j, x_k and one degree- d component with x_i, x_l, x_p .

The non-collapsed components in types (1), (2), and (3) are all completely ramified over two points. In types (1) and (2), exactly one point with no ramification is marked, killing the automorphisms. Hence, for each of these types (1) and (2) we have one corresponding boundary point in \overline{M} . In type (3), the point x_j fixes the automorphisms, but then we have a choice to mark any preimage of 1 but x_j to be x_k . Hence there are $d-1$ boundary points corresponding to a cover of type (3). For type (4), a computation of the corresponding Hurwitz number shows that there is a unique such cover, so that we have one such boundary point in \overline{M} .

By the WDVV equations for $\text{ft}_I : M \rightarrow \overline{M}_{0,4}$, we have $\text{ft}_I^*(ij|kl) = \text{ft}_I^*(il|kj)$. The left side of this equation is obviously supported on the boundary point of type (1) that we are interested in, whereas the right side is supported on all boundary points of type (3) or (4). The multiplicity of $\text{ft}_I^*(il|kj)$ is 1 at each such boundary point by our former computation. As there are d such boundary points, in total we obtain $\text{ord}_{\mathcal{C}} \text{ft}_I^*(ij|kl) = d$. \square

Theorem 4.3 (One-dimensional moduli spaces $\mathcal{M}_0(L_V, \Sigma_V)$)

Let V be a vertex as in construction 4.1: mapping to $L_V \cong L_1^q$ and satisfying $\text{rdim}(V) = 1$ and $n_V = 0$. Then $\mathcal{M}_0(L_V, \Sigma_V)$ with the weights obtained from the gluing construction 3.14 is a one-dimensional balanced fan. In particular, V is good.

Proof:

The rays of $\mathcal{M}_0(L_V, \Sigma_V)$ are given by the combinatorial types α of construction 4.1. With the notation used there, we can take as spanning vectors for these rays $u_\alpha = v_{\{i,j\}}$ in a type I case and $u_\alpha = d_2 v_{I_1} + d_1 v_{I_2}$ in a type II case. As the integer length of these vectors is 1 and $\text{gcd}(d_1, d_2)$, respectively, it follows from examples 3.15 and 3.16 that the gluing weight times the primitive vector in direction of the ray corresponding to α equals $H_\alpha u_\alpha$, where H_α denotes the Hurwitz number of V_1 for type I, and the product of the Hurwitz numbers of V_1 and V_2 for type II. Hence we have to show that $\sum_\alpha H_\alpha u_\alpha = 0$.

By lemma 2.3, it suffices to prove that $\sum_\alpha H_\alpha \text{ft}_I(u_\alpha) = 0$ for all four-element subsets $I = \{i, j, k, l\}$ of I_V . The combinatorial types α for which $\text{ft}_I(u_\alpha)$ is a multiple of $v_{\{i,j\}}$ are exactly the ones corresponding to the three cases in lemma 4.2. Due to the definition of u_α , this multiple is 1, d_1 , and $d_1 + d_2$, respectively, and hence always equal to $\text{ord}_{\mathcal{C}} \text{ft}_I^*(ij|kl)$ for a stable map \mathcal{C} of this type. As the number of such stable maps is exactly H_α , it follows that $\sum_\alpha H_\alpha \text{ft}_I(u_\alpha)$ contains the vector $v_{\{i,j\}}$ with a factor of $\text{deg} \text{ft}_I^*(ij|kl)$. But the same holds for the other two splittings of I , and thus we conclude as desired that

$$\sum_\alpha H_\alpha \text{ft}_I(u_\alpha) = \text{deg} \text{ft}_I^*(ij|kl) v_{\{i,j\}} + \text{deg} \text{ft}_I^*(ik|jl) v_{\{i,k\}} + \text{deg} \text{ft}_I^*(il|jk) v_{\{i,l\}} = 0$$

since these three divisors are linearly equivalent and $v_{\{i,j\}} + v_{\{i,k\}} + v_{\{i,l\}} = 0$ in $\mathcal{M}_{0,I}$. \square

Proof of theorem 1.1:

Theorem 4.3 together with the arguments at the beginning of section 4 shows that all vertices V of combinatorial types of $\mathcal{M}_{0,n}(L, \Sigma)$ with $\text{rdim}(V) = 1$ are good. By lemma 3.18 we conclude that all vertices are good. Hence $\mathcal{M}_{0,n}(L, \Sigma)$ is a tropical variety by theorem 3.17, with the weights given in constructions 3.12 and 3.14. The claim about the dimension follows from subsection 3.1. \square

Remark 4.4

By lemma 3.18, the case of one-dimensional moduli spaces of tropical stable maps to a curve represents a main building block for the proof of Theorem 1.1 stating that arbitrary-dimensional moduli spaces of tropical stable maps to a curve are balanced. It was also a natural starting point for the investigation of the balancing condition for tropical moduli spaces of stable maps to a curve. In collaboration with Simon Hampe, the polymake extension a-tint [GJ00, Ham14] was used to compute — for a large series of relevant examples — the generating vectors of rays for such one-dimensional moduli spaces. GAP [GAP16] was used to compute conjectural local weights in terms of Hurwitz numbers, and to check the balancing condition. These experiments with one-dimensional moduli spaces helped us to form a precise conjecture for the weights. Finally, the computation of a series of one-dimensional balanced examples led to the proof of the balancing condition in the one-dimensional case, and thus also in the general case. This work thus heavily relies on the examples computed with the help of a-tint and GAP.

REFERENCES

- [All12] Lars Allermann, *Tropical intersection products on smooth varieties*, Journal of the EMS **14** (2012), no. 1, 107–126.
- [AR10] Lars Allermann and Johannes Rau, *First steps in tropical intersection theory*, Math. Z. **264** (2010), no. 3, 633–670, arXiv:0709.3705.
- [BBM11] Benoît Bertrand, Erwan Brugallé, and Grigory Mikhalkin, *Tropical Open Hurwitz numbers*, Rend. Semin. Mat. Univ. Padova **125** (2011), 157–171.
- [BBM14] ———, *Genus 0 characteristic numbers of tropical projective plane*, Compos. Math. **150** (2014), no. 1, 46–104, arXiv:1105.2004.
- [Beh97] K. Behrend, *Gromov-Witten invariants in algebraic geometry*, Invent. Math. **127** (1997), no. 3, 601–617.
- [BF97] Kai Behrend and Barbara Fantechi, *The intrinsic normal cone*, Invent. Math. **128** (1997), 45–88.
- [BM13a] Erwan Brugallé and Hannah Markwig, *Deformation of tropical Hirzebruch surfaces and enumerative geometry*, Preprint, arXiv:1303.1340, J. Algebraic Geom. (to appear), 2013.
- [BM13b] Arne Buchholz and Hannah Markwig, *Tropical covers of curves and their moduli spaces*, Comm. Contemp. Math. (2013), doi:10.1142/S0219199713500454.
- [Cap14] Lucia Caporaso, *Gonality of algebraic curves and graphs*, Springer Proc. Math. Stat. **71** (2014), 77–108.
- [CJM10] Renzo Cavalieri, Paul Johnson, and Hannah Markwig, *Tropical Hurwitz numbers*, J. Algebr. Comb. **32** (2010), no. 2, 241–265, arXiv:0804.0579.
- [CJM11] Renzo Cavalieri, Paul Johnson, and Hannah Markwig, *Wall crossings for double Hurwitz numbers*, Adv. Math. **228** (2011), no. 4, 1894–1937, arXiv:1003.1805.

- [CMR14] Renzo Cavalieri, Hannah Markwig, and Dhruv Ranganathan, *Tropicalizing the space of admissible covers*, Preprint, arXiv:1401.4626, Math. Ann. (to appear), 2014.
- [CMR16] ———, *Tropical compactification and the Gromov–Witten theory of \mathbb{P}^1* , *Selecta Math.* **1-34** (2016), doi:10.1007/s00029-016-0265-7, arXiv:1410.2837.
- [FP97] William Fulton and Rahul Pandharipande, *Notes on stable maps and quantum cohomology*, Algebraic Geometry, Santa Cruz 1995 (János Kollár et al., ed.), Proceedings of Symposia in Pure Mathematics, no. 62,2, Amer. Math. Soc., 1997, pp. 45–96.
- [FS05] Eva Maria Feichtner and Bernd Sturmfels, *Matroid polytopes, nested sets and Bergman fans*, *Portugaliae Mathematica* **62** (2005), 437–468, arXiv:math.CO:0411260.
- [GAP16] The GAP Group, *GAP – Groups, Algorithms, and Programming, Version 4.8.6*, 2016.
- [GJ00] Ewgenij Gawrilow and Michael Joswig, *polymake: a framework for analyzing convex polytopes*, Polytopes — Combinatorics and Computation (Gil Kalai and Günter M. Ziegler, eds.), Birkhäuser, 2000, pp. 43–74.
- [GKM09] Andreas Gathmann, Michael Kerber, and Hannah Markwig, *Tropical fans and the moduli space of rational tropical curves*, *Compos. Math.* **145** (2009), no. 1, 173–195, arXiv:0708.2268.
- [GO17] Andreas Gathmann and Dennis Ochse, *Moduli spaces of tropical curves in tropical varieties*, arXiv:1705.07626, 2017.
- [Gro14] Andreas Gross, *Correspondence theorems via tropicalizations of moduli spaces*, *Comm. Contemp. Math.* (to appear), arXiv:1406.1999, 2014.
- [Ham14] Simon Hampe, *a-tint: a polymake extension for algorithmic tropical intersection theory*, *European J. Combin.* **36C** (2014), 579–607, arXiv:1208.4248.
- [Mik05] Grigory Mikhalkin, *Enumerative tropical geometry in \mathbb{R}^2* , *J. Amer. Math. Soc.* **18** (2005), 313–377, arXiv:math.AG/0312530.
- [Mik07] ———, *Moduli spaces of rational tropical curves*, Proceedings of Gökova Geometry-Topology Conference GGT 2006 (2007), 39–51, arXiv:0704.0839.
- [MR09] Hannah Markwig and Johannes Rau, *Tropical descendant Gromov–Witten invariants*, *Manuscripta Math.* **129** (2009), no. 3, 293–335, arXiv:0809.1102.
- [Och13] Dennis Ochse, *Moduli spaces of rational tropical stable maps into smooth tropical varieties*, Ph.D. thesis, TU Kaiserslautern, 2013.
- [SS04] David Speyer and Bernd Sturmfels, *The tropical Grassmannian*, *Adv. Geom.* **4** (2004), 389–411.
- [Vak00] Ravi Vakil, *The enumerative geometry of rational and elliptic curves in projective space*, *J. Reine Angew. Math. (Crelle’s Journal)* **529** (2000), 101–153.

ANDREAS GATHMANN, FACHBEREICH MATHEMATIK, TECHNISCHE UNIVERSITÄT KAISERSLAUTERN, POSTFACH 3049, 67653 KAISERSLAUTERN, GERMANY

E-mail address: andreas@mathematik.uni-kl.de

HANNAH MARKWIG, EBERHARD KARLS UNIVERSITÄT TÜBINGEN, FACHBEREICH MATHEMATIK, INSTITUT FÜR GEOMETRIE, AUF DER MORGENSTELLE 10, 72076 TÜBINGEN, GERMANY

E-mail address: hannah@math.uni-tuebingen.de

DENNIS OCHSE, FACHBEREICH MATHEMATIK, TECHNISCHE UNIVERSITÄT KAISERSLAUTERN, POSTFACH 3049, 67653 KAISERSLAUTERN, GERMANY

E-mail address: ochse@mathematik.uni-kl.de