

**UNOBSTRUCTED IMMERSED LAGRANGIAN
CORRESPONDENCE AND FILTERED A_∞ FUNCTOR**

KENJI FUKAYA

ABSTRACT. In this paper we ‘construct’ a 2-functor from the unobstructed immersed Weinstein category to the category of all filtered A_∞ categories. We consider arbitrary (compact) symplectic manifolds and its arbitrary (relatively spin) immersed Lagrangian submanifolds. The filtered A_∞ category associated to (X, ω) is defined by using Lagrangian Floer theory in such generality. ([FOOO1, AJ].) The morphism of unobstructed immersed Weinstein category (from (X_1, ω_1) to (X_2, ω_2)) is by definition a pair of an immersed Lagrangian submanifold of the direct product and its bounding cochain (in the sense of [FOOO1, AJ]). Such a morphism transforms an (immersed) Lagrangian submanifold of (X_1, ω_1) to one of (X_2, ω_2) . The key new result proved in this paper shows that this geometric transformation preserves unobstructed-ness of the Lagrangian Floer theory.

Thus, this paper generalizes earlier results by Wehrheim-Woodward and Mau’s-Wehrheim-Woodward so that it works in complete generality in the compact case.

The main idea of the proofs are based on Lekili-Lipyanskiy’s Y diagram and a lemma from homological algebra, together with systematic use of Yoneda functor. In other words the proofs are based on a different idea from those which are studied by Bottmann-Mau’s-Wehrheim-Woodward, where strip shrinking and figure 8 bubble plays the central role.

Kenji Fukaya is supported partially by NSF Grant No. 1406423, and Simons Collaboration on Homological Mirror Symmetry.

CONTENTS

1. Introduction	4
2. Filtered A_∞ category: Review	10
2.1. A_∞ category	10
2.2. A_∞ functor	15
2.3. Functor category	17
2.4. A_∞ -Whitehead Theorem	20
2.5. A_∞ -Yoneda embedding	21
3. Floer theory of immersed Lagrangian submanifolds: Review.	24
3.1. Immersed Lagrangian submanifold	24
3.2. Moduli space of pseudo-holomorphic polygons	33
3.3. The filtered A_∞ algebra associated to an immersed Lagrangian submanifold	45
3.4. Filtered A_∞ categories of immersed Lagrangian Floer theory	54
3.5. Opposite A_∞ category and $\omega \mapsto -\omega$	57
4. Preliminary on Lagrangian correspondence.	60
5. The Künneth bi-functor in Lagrangian Floer theory.	63
5.1. Algebraic framework of A_∞ bi-functors and tri-functors	63
5.2. A geometric realization of an A_∞ tri-module 1	74
5.3. A geometric realization of an A_∞ tri-module 2	85
6. Unobstructedness is preserved by an unobstructed Lagrangian correspondence.	89
6.1. Right filtered A_∞ modules and cyclic elements.	90
6.2. A geometric realization of a cyclic element.	92
6.3. Well-defined-ness of bounding cochains up to gauge equivalence.	95
7. Representability of correspondence functor	96
7.1. Statement	96
7.2. Proof	98
8. Compositions of Lagrangian correspondences	102
8.1. Unobstructed-ness of composed correspondences	102
8.2. Construction of a tri-module	106
9. Compatibility of compositions	113
9.1. Statement	113
9.2. Lekili-Lipyanskiy's Y-diagram	114
9.3. Proof of Proposition 9.2 (2)	127
10. The compatibility as 2-functors	130
10.1. The composition of A_∞ functors defines a bi-functor	130
10.2. Proof of Theorem 9.1	134
10.3. The compatibility as bi-functors	137
10.4. Proof of Theorem 10.16	143
10.5. Proof of Propositions 10.10 and 10.23	145
10.6. A note on 2-categories of A_∞ categories	153
11. Associativity of compositions	153
11.1. Statement of the result of Section 11	153
11.2. Opposite bi-modules and Opposite drums	154
11.3. Double pants diagrams	156
11.4. Proof of the associativity	165

12.	Two different ways to compactify the moduli space of pseudo-holomorphic disks in the direct product	167
12.1.	The reason why we need a different compactification	167
12.2.	The definition of the compactification $\mathcal{M}'(L_{12}; \vec{a}; E)$	173
12.3.	Kuranishi structure of the compactification $\mathcal{M}'(L_{12}; \vec{a}; E)$	186
12.4.	Gluing analysis for the construction of a Kuranishi chart	205
13.	Homotopy equivalence and homotopy between filtered A_∞ functors	222
14.	Independence of the filtered A_∞ functors of the choices	227
14.1.	Statement	227
14.2.	Higher pseudo-isotopy	229
14.3.	Well defined-ness of a filtered A_∞ category up to strong homotopy equivalence	232
14.4.	Proof of Theorem 14.6	240
14.5.	Coincidence of A_∞ structures defined by the two compactifications	243
15.	Independence of the filtered A_∞ functors of the Hamiltonian isotopy	247
15.1.	Algebraic preliminary	247
15.2.	Homotopy equivalence over Λ in the geometric situation	248
15.3.	The main theorem	249
15.4.	Proof of the main theorem	251
15.5.	Proof of Theorem 15.5	253
15.6.	Completion by Hofer distance	272
16.	Künneth bi-functor revisited	273
16.1.	Tensor product of filtered A_∞ categories	273
16.2.	Künneth functor in Lagrangian Floer theory	276
16.3.	The Künneth functor and the correspondence tri-module	283
16.4.	Proof of Lemmas 16.6, 16.7 and 16.16	284
17.	Orientation and sign	287
17.1.	Koszul rule in A_∞ structures.	288
17.2.	Orientation of the moduli space of the simplest quilt	291
17.3.	Orientation of the moduli space of pseudo-holomorphic drums	299
17.4.	Orientation of the moduli space of Y -diagrams	302
17.5.	Orientation of the moduli space of double pants diagrams	306
17.6.	Orientation and sign for A_∞ -structure in the Morse-Bott case	307
18.	Concluding remarks	310
18.1.	What we need to convert informal Definition 1.1/Informal summary 1.2 into formal ones	310
18.2.	Relations to the works by Bottman-Wehrheim	313
18.3.	Relation to the works by Ma'u-Wehrheim-Woodward	315
	Index	318
	References	321

1. INTRODUCTION

The purpose of this paper is to ‘construct’ a 2-functor from the ‘unobstructed immersed Weinstein category’ to the ‘category of all filtered A_∞ categories’. The next definition is a variation of one proposed by Weinstein [Wei].

Definition 1.1. (Informal definition) The *unobstructed Weinstein category* is a category whose object is a compact symplectic manifold and a morphism from (X_1, ω_1) to (X_2, ω_2) is a pair of an immersed Lagrangian submanifold L_{12} of $(X_1 \times X_2, -\pi_1^*(\omega_1) + \pi_2^*(\omega_2))$ and a bounding cochain b_{12} on it. \diamond

The notion of a bounding cochain is introduced in [FOOO1] and its generalization to the immersed case is by [AJ]. We emphasize that Definition 1.1 is an informal definition. Various issues which will appear when one tries to define such a 2-category literary are discussed in Subsection 18.1.

We consider a 2-category whose objects are (strict and unital) filtered A_∞ categories (see [Fu7, FOOO3] and Section 3 for its definition) and morphisms are (strict and unital) filtered A_∞ functors. See Section 10 Theorem 10.1 and Subsection 10.6 for a version of the construction of such a 2-category.

The main result of this paper could be summarized as follows.

Informal Summary 1.2. *There exists a 2-functor from the unobstructed immersed Weinstein category to the 2-category of all filtered A_∞ categories.* \diamond

This statement is informal and the author does *not* claim that its proof is in this paper. The precise statements which we prove in this paper will be given in this introduction and the main body of the paper. The relation between those results (proved in this paper) and the results which would literary prove Informal summary 1.2 is discussed in Subsection 18.1.

The idea to associate an A_∞ category (whose object is a Lagrangian submanifold and whose morphisms are Floer cohomology) is started by the author’s paper [Fu2] (inspired by a S. Donaldson’s talk at University of Warwick 1992). The most essential step to make this construction rigorous was carried out in [FOOO1], based on the virtual fundamental chain technique ([FOn]). [FOOO1] contains the detailed proof of the cases of a single Lagrangian submanifold and a pair of Lagrangian submanifolds. The construction of a (unital and strict) filtered A_∞ category based on the Lagrangian Floer theory in [FOOO1] along the same line as [FOOO1] was written in [AFOOO, Fu7, FOOO3]. Akaho and Joyce [AJ] generalized this story and include Lagrangian submanifolds which are not necessary embedded but are immersed. Thus we obtain the next:

Theorem 1.3. *Let (X, ω) be a compact symplectic manifold and \mathbb{L} a finite set of its spin immersed Lagrangian submanifolds.¹ We assume that the self intersection of elements of \mathbb{L} and intersection between two elements of \mathbb{L} are transversal.*

Then there exists a (strict and unital) filtered A_∞ category, $\mathfrak{Fukst}((X, \omega), \mathbb{L})$, such that:

- (1) *An object of $\mathfrak{Fukst}((X, \omega), \mathbb{L})$ is a pair (L, b) where L is an element of \mathbb{L} and b is a bounding cochain of L in the sense of [FOOO1, AJ].*

¹In the introduction we assume spin-ness of Lagrangian submanifolds rather than relatively-spin-ness, for simplicity. The statement in the relatively spin case will be given in the main body of the paper.

- (2) The module of morphisms $CF((L_1, b_1), (L_2, b_2))$ from (L_1, b_1) to (L_2, b_2) is given as follows.
- (a) If $L_1 \neq L_2$ then $CF((L_1, b_1), (L_2, b_2))$ is the free Λ_0 module whose basis is identified with the intersection $L_1 \cap L_2$. Here the universal Novikov ring Λ_0 is defined in Definition 2.1.
 - (b) If $L_1 = L_2 = L$ then $CF((L_1, b_1), (L_2, b_2))$ is the completion of the tensor product $\Omega(\tilde{L} \times_X \tilde{L}) \otimes \Lambda_0$ of the de Rham complex $\Omega(\tilde{L} \times_X \tilde{L})$ and Λ_0 . Here our immersed Lagrangian submanifold L is given by an immersion $\tilde{L} \rightarrow X$ and $\tilde{L} \times_X \tilde{L}$ is the fiber product of \tilde{L} with itself.
- (3) The cohomology group of $CF((L_1, b_1), (L_2, b_2))$ is the Floer cohomology $HF((L_1, b_1), (L_2, b_2))$ defined in [FOOO1, AJ]. \diamond

Theorem 1.3 is Theorem 3.14 in Section 3, which is slightly more general.

Remark 1.4. In item (2)(b) we may also take $H(\tilde{L} \times_X \tilde{L}; \Lambda_0)$ (the cohomology group with Λ_0 coefficient) instead of $\Omega(\tilde{L} \times_X \tilde{L}) \widehat{\otimes} \Lambda_0$. The process to produce a structure on $H(\tilde{L} \times_X \tilde{L}; \Lambda_0)$ from one on $\Omega(\tilde{L} \times_X \tilde{L}) \otimes \Lambda_0$ is purely algebraic and automatic. See [FOOO1, Theorem 5.4.2] for example. \diamond

Theorem 1.3 is not new and the most essential part of its proof had been given in [FOOO1, AJ]. (We use the de Rham version, while [FOOO1, AJ] uses the singular homology version. This difference however is not important but is rather of technical nature.) In the de Rham version it is also written and proved in [AFOOO].

Theorem 1.3 is the object part of ‘2-functor’ mentioned in Informal summary 1.2. The main new point of this paper is the morphism part of the ‘2 functor’ mentioned in Informal summary 1.2. The next theorem is the key new result. Let (X_i, ω_i) be a compact symplectic manifold for $i = 1, 2$. We assume they are spin.² Let L_1, L_{12} be spin immersed Lagrangian submanifolds of (X_1, ω_1) and $(X_1 \times X_2, -\pi_1^*(\omega_1) + \pi_2^*(\omega_2))$ respectively. We say that they are transversal if the fiber product $\tilde{L}_1 \times_{X_1} \tilde{L}_{12}$ is transversal. In that case the map $\tilde{L}_1 \times_{X_1} \tilde{L}_{12} \rightarrow X_2$ defines an immersed Lagrangian submanifold which we write $L_1 \times_{X_1} L_{12}$.

Theorem 1.5. *If L_1 and L_{12} are unobstructed³ and the immersion $\tilde{L}_1 \times_{X_1} \tilde{L}_{12} \rightarrow X_2$ is self-clean, then $L_1 \times_{X_1} L_{12}$ is also unobstructed. There exists a way to obtain a bounding cochain of $L_1 \times_{X_1} L_{12}$ from bounding cochains of L_1 and of L_{12} , which is independent of the choices up to gauge equivalence. \diamond*

Theorem 1.5 is Theorems 6.3 and 7.3, which are proved in Sections 6 and 7. Note that for generic (embedded) Lagrangian submanifolds L_1, L_{12} of (X_1, ω_1) and $(X_1 \times X_2, -\pi_1^*(\omega_1) + \pi_2^*(\omega_2))$, the fiber product $L_1 \times_{X_1} L_{12}$ is an immersed Lagrangian submanifold of X_2 . However it is not necessary embedded. Therefore including immersed Lagrangian submanifolds is inevitable.

Remark 1.6.

- (1) The relation between a Lagrangian correspondence and an A_∞ functor was studied in the earlier works by Wehrheim-Woodward, Ma’u-Wehrheim-Woodward ([MWW, WW2] etc.). Note that, in their situation where all the Lagrangian submanifolds involved are embedded and monotone, the

²The case when X_1 or X_2 is not spin is included in the main body of the paper.

³A Lagrangian submanifold is said to be unobstructed if there exists a bounding cochain of it.

statement corresponding to Theorem 1.5 is classical (due to Oh), since we can take 0 as the bounding cochain.

- (2) To include more general objects than embedded and monotone Lagrangian submanifolds, Wehrheim-Woodward proceeds as follows. They first consider embedded and monotone Lagrangian submanifolds (with bounding cochain 0). They then enhance the set of such Lagrangian submanifolds so that a sequence of Lagrangian correspondences

$$L_1 \times_{X_1} L_{12} \times_{X_2} L_{23} \times_{X_3} \cdots \times_{X_{k-1}} L_{(k-1)k}$$

is regarded as an object of $\mathfrak{Fut}^\#(X_k, \omega_k)$, the extended version of $\mathfrak{Fut}(X_k, \omega_k)$.

Theorem 1.5 enables us to work with genuine geometric Lagrangian submanifolds rather than extended objects. We will discuss the relation between our results and one by [MWW, WW2] more in Subsection 18.3

- (3) The statement of Theorem 1.5 was known as a conjecture for a while. For example the author discussed this conjecture with several mathematicians during the years 2008-2015. It was also mentioned by K. Wehrheim's talk in 2012 [Weh] and is written as a 'conjecture' in [BW].

More precisely it had been conjectured that the virtual fundamental chain of an appropriate moduli space of Figure 8 bubbles gives the bounding cochain in Theorem 1.5. The conjecture of this form is still open. It is the opinion of the author that to prove this version of the conjecture is a very interesting analytic problem. If this conjecture is proved and a bounding cochain is obtained as the virtual fundamental chain of the moduli space of Figure 8 bubbles, the author has no doubt that such a bounding cochain is gauge equivalent to the bounding cochain we obtained in Theorem 1.5. We will discuss this point more in Subsection 18.2.

- (4) Until 2015, the author did not have an idea to prove Theorem 1.5 other than those by using 'strip shrinking' and 'Figure 8 bubble', which are emphasized in [BW].⁴ By this reason the author did not have a plan to study this conjecture until 2015. In 2015 May, the author realized that using the method of Lekili-Lipyanskiy [LL] and homological algebra we can prove Theorem 1.5 much easier than the idea using 'strip shrinking' or 'Figure 8 bubble'. He then started working on Lagrangian correspondence and its relation to Lagrangian Floer theory. (The main motivation of the author's study is its application to the gauge theory ([DF, Fu10, Fu11])). This paper is an outcome of that study.◊

We also remark that to define Floer cohomology of a Lagrangian submanifold (beyond the monotone or exact cases) we need a bounding cochain. So proving the existence of a bounding cochain is the key step for applications of Lagrangian Floer theory. In general proving the existence of a bounding cochain is not easy. Theorem 1.5 provides a useful tool to prove it.

The next theorem is a more functorial version of Theorem 1.5. Let $\mathbb{L}_1, \mathbb{L}_2$ and \mathbb{L}_{12} be finite sets of spin immersed Lagrangian submanifolds of (X_1, ω_1) , (X_2, ω_2) and $(X_1 \times X_2, -\pi_1^*(\omega_1) + \pi_2^*(\omega_2))$, respectively. We assume each of them satisfies the transversality conditions in Theorem 1.3. Moreover we assume that for each

⁴See [BW] or Subsections 18.2 and 18.3 for 'strip shrinking' and 'Figure 8 bubble'. Studying them certainly are interesting in its own and potentially can be applied to various geometric problems.

$L_1 \in \mathbb{L}_1$ and $L_{12} \in \mathbb{L}_{12}$ the fiber product $L_1 \times_{X_1} L_{12}$ is transversal and is an element of \mathbb{L}_2 .

Theorem 1.7. *In the situation of Theorem 1.5, there exists a filtered A_∞ bi-functor $\mathfrak{F}\mathfrak{u}\mathfrak{k}\mathfrak{st}((X_1, \omega_1), \mathbb{L}_1) \times \mathfrak{F}\mathfrak{u}\mathfrak{k}\mathfrak{st}((X_1 \times X_2, -\pi_1^*(\omega_1) + \pi_2^*(\omega_2)), \mathbb{L}_{12}) \rightarrow \mathfrak{F}\mathfrak{u}\mathfrak{k}\mathfrak{st}((X_2, \omega_2), \mathbb{L}_2)$ such that it sends the pair of objects $(L_1, b_1), (L_{12}, b_{12})$ to $L_1 \times_{X_1} L_{12}$ equipped with the bounding cochain given in Theorem 1.5. \diamond*

See Definition 5.1 for the definition of a filtered A_∞ bi-functor. Theorem 1.7 provides the morphism part of the ‘2-functor’ mentioned in Informal summary 1.2. Theorem 1.7 is Corollary 7.4 and is proved in Section 7. We call the bi-functor in Theorem 1.7 the correspondence bi-functor. We like to mention that in the situation when all the Lagrangian submanifolds involved are embedded and monotone, Theorem 1.7 was proved by Ma’u-Wehrheim-Woodward in [MWW]. See Subsection 18.3 for more explanation on the relation of Theorem 1.7 to [MWW].

The next theorem gives a definition of the composition of morphisms in unobstructed immersed Weinstein category. In other words Theorem 1.8 could be used to give a definition of unobstructed immersed Weinstein category as a (topological) 2-category.⁵

Let (X_i, ω_i) , $i = 1, 2, 3$ be compact symplectic manifolds which are spin. Let \mathbb{L}_{ij} , $(ij) = (12), (23)$ or (13) , be finite sets of spin Lagrangian submanifolds of $(X_i \times X_j, -\pi_1^*(\omega_i) + \pi_2^*(\omega_j))$. We assume that for any $L_{12} \in \mathbb{L}_{12}$, $L_{23} \in \mathbb{L}_{23}$ the fiber product $L_{12} \times_{X_2} L_{23}$ is transversal and becomes an element of \mathbb{L}_{13} .

Theorem 1.8. *There exists a filtered A_∞ bi-functor*

$$\begin{aligned} \text{comp} : & \mathfrak{F}\mathfrak{u}\mathfrak{k}\mathfrak{st}((X_1 \times X_2, -\pi_1^*(\omega_1) + \pi_2^*(\omega_2)), \mathbb{L}_{12}) \\ & \times \mathfrak{F}\mathfrak{u}\mathfrak{k}\mathfrak{st}((X_2 \times X_3, -\pi_1^*(\omega_2) + \pi_2^*(\omega_3)), \mathbb{L}_{23}) \\ & \rightarrow \mathfrak{F}\mathfrak{u}\mathfrak{k}\mathfrak{st}((X_1 \times X_3, -\pi_1^*(\omega_1) + \pi_2^*(\omega_3)), \mathbb{L}_{13}) \end{aligned}$$

such that it sends a pair of objects $(L_{12}, b_{12}), (L_{23}, b_{23})$ to (L_{13}, b_{13}) , where $L_{13} = L_{12} \times_{X_2} L_{23}$ and b_{13} is a bounding cochain of L_{13} which is determined from b_{12} and b_{23} in a way independent of the choices up to gauge equivalence.

We call this functor the composition functor.

The composition functor is associative, in the sense that the next diagram commutes up to homotopy equivalence, as A_∞ tri-functors.

$$\begin{array}{ccc} \mathfrak{F}\mathfrak{u}\mathfrak{k}\mathfrak{st}(X_1 \times X_2) \times \mathfrak{F}\mathfrak{u}\mathfrak{k}\mathfrak{st}(X_2 \times X_3) & \longrightarrow & \mathfrak{F}\mathfrak{u}\mathfrak{k}\mathfrak{st}(X_1 \times X_3) \\ \times \mathfrak{F}\mathfrak{u}\mathfrak{k}\mathfrak{st}(X_3 \times X_4) & & \times \mathfrak{F}\mathfrak{u}\mathfrak{k}\mathfrak{st}(X_3 \times X_4) \\ \downarrow & & \downarrow \\ \mathfrak{F}\mathfrak{u}\mathfrak{k}\mathfrak{st}(X_1 \times X_2) \times \mathfrak{F}\mathfrak{u}\mathfrak{k}\mathfrak{st}(X_2 \times X_4) & \longrightarrow & \mathfrak{F}\mathfrak{u}\mathfrak{k}\mathfrak{st}(X_1 \times X_4). \end{array} \quad (1.1)$$

\diamond

The first half of Theorem 1.8 is Theorems 8.2 and 8.5 which are proved in Section 8. The second half of Theorem 1.8 is Theorem 11.2 proved in Section 11.

Remark 1.9. Actually Theorem 1.7 follows from Theorem 1.8 by putting X_1 to be a point. \diamond

⁵We say ‘topological’ 2-category since to compose two (unobstructed immersed) Lagrangian correspondences we need to assume transversality. Therefore morphisms can be composed only generically.

In the situation when all the Lagrangian submanifolds involved are embedded and monotone, Theorem 1.8 (and Theorem 1.10 below) were also proved by Ma'u-Wehrheim-Woodward in [MWW]. We also remark that Wehrheim-Woodward and Ma'u-Wehrheim-Woodward studied a fiber product of Lagrangian correspondences (under the assumption that it becomes embedded Lagrangian correspondence) in their study of the composition of Lagrangian correspondences. See Subsection 18.3 for more explanation on the relation of Theorems 1.7, 1.8 and 1.10 to [MWW].

The next theorem says that the correspondence bi-functor in Theorem 1.7 is compatible with the composition functor in Theorem 1.8. To state it we need some digression. Let \mathcal{C}_i be a strict and unital filtered A_∞ category for $i = 1, 2$. Then we can define a filtered A_∞ category $\mathcal{F}UNC(\mathcal{C}_1, \mathcal{C}_2)$ whose object is a strict and unital filtered A_∞ functor. (This is the unital and strict version of Theorem 2.19 whose proof is the same as Theorem 2.19). For three strict and unital filtered A_∞ categories \mathcal{C}_i , $i = 1, 2, 3$ we can define a filtered A_∞ bi-functor

$$\mathcal{F}UNC(\mathcal{C}_1, \mathcal{C}_2) \times \mathcal{F}UNC(\mathcal{C}_2, \mathcal{C}_3) \rightarrow \mathcal{F}UNC(\mathcal{C}_1, \mathcal{C}_3) \quad (1.2)$$

which gives a composition of filtered A_∞ functors among objects. (See Theorem 10.1.) The bi-functor (1.2) is associative. Roughly speaking (1.2) is defined as follows. We first define a homotopy equivalence from functor category $\mathcal{F}UNC(\mathcal{C}_1, \mathcal{C}_2)$ to a full subcategory of the DG-category of left \mathcal{C}_1 and right \mathcal{C}_2 bi-modules. (This is a version of Yoneda's lemma.) We also prove that the composition of A_∞ functors corresponds to the tensor product of the bi-modules. Then using the fact that tensor product of bi-modules is an object part of the DG-bi-functor, we obtain (1.2). (See Subsection 10.6.)

On the other hand, the correspondence bi-functor in Theorem 1.7 can be reinterpreted as a filtered A_∞ functor

$$\begin{aligned} \mathfrak{F}ukst((X_1 \times X_2, -\pi_1^*(\omega_1) + \pi_2^*(\omega_2)), \mathbb{L}_{12}) \\ \rightarrow \mathcal{F}UNC(\mathfrak{F}ukst((X_1, \omega_1), \mathbb{L}_1), \mathfrak{F}ukst((X_2, \omega_2), \mathbb{L}_2)) \end{aligned} \quad (1.3)$$

to the functor category.

Theorem 1.10. *The next diagram commutes up to homotopy equivalence.*

$$\begin{array}{ccc} \mathfrak{F}ukst(X_1 \times X_2) \times \mathfrak{F}ukst(X_2 \times X_3) & \longrightarrow & \mathfrak{F}ukst(X_1 \times X_3) \\ \downarrow & & \downarrow \\ \mathcal{F}UNC(\mathfrak{F}ukst(X_1), \mathfrak{F}ukst(X_2)) & \longrightarrow & \mathcal{F}UNC(\mathfrak{F}ukst(X_1), \mathfrak{F}ukst(X_3)) \\ \times \mathcal{F}UNC(\mathfrak{F}ukst(X_2), \mathfrak{F}ukst(X_3)) & & \end{array} \quad (1.4)$$

Here the vertical arrows are functors (1.3), the upper horizontal arrow is the composition functor in Theorem 1.8 and lower horizontal arrow is the functor (1.2).⁶◊

Theorem 1.10 is Theorems 9.1 and 10.16 which are proved in Sections 9 and 10.

Remark 1.11. The object part of Theorem 1.10, that is, the commutativity of the Diagram (1.4) as the maps between the sets of objects, implies Theorem 1.7 by putting X_1 to be a point. The (homotopy) commutativity of Diagram (1.4) as A_∞ bi-functors is more involved.◊

⁶We take appropriate finite sets \mathbb{L}_{ij} of Lagrangian submanifolds of $X_i \times X_j$.

All the constructions of this paper are based on a study of moduli spaces of pseudo-holomorphic curves. Even though we use the moduli space of pseudo-holomorphic quilts in the sense of [WW3] we do *not* use the most difficult part of the analytic study of the moduli space of pseudo-holomorphic quilts. Especially we do *not* study ‘strip shrinking’ and ‘Figure 8 bubble’. Our proof relies much on the cobordism argument which was initiated by Y. Lekili and M. Lipyanskiy [LL] and various technique from homological algebra. By this reason we do not need new analytic detail to carry out in this paper, except we need to take a slightly different compactification of the moduli space of pseudo-holomorphic disks bounding a Lagrangian submanifold L_{12} of the product. This is because otherwise the moduli space of pseudo-holomorphic quilts would not carry a Kuranishi structure. We will explain this point in Section 12 and also provide the detail of this different compactification.

In Sections 13-15 we show that various filtered A_∞ (bi)-functors we construct in this paper are independent of the choices involved and also of the Hamiltonian isotopies of the Lagrangian submanifolds involved. More arguments on sign and orientation are given in the Appendix written by K. Ono.

In Section 16 we show that by a similar method used in the other part of this paper, we can show Künneth theorem in Lagrangian Floer theory. (We remark that Künneth theorem in Lagrangian Floer theory is also proved by [Am1, Am2].)

Section 17 is devoted to the discussion of sign and orientation.

Section 18 is a brief discussion on two points. One is the relation of this paper to the works by Wehrheim-Woodwards-Ma'u-Bottman. The other is an issue which will appear to define/prove ‘Definition 1.1’/‘Informal summary 1.2’ literary.

We expect that there are various applications of the whole construction (especially the part to construct a filtered A_∞ functor from a Lagrangian correspondence and several compatibility statements about it, which is new in this paper). Some of the applications are now on the way being worked out and being written or already available as a preprint. (See [DF, EL, Fu10, Fu11] and etc.) In this paper we concentrate in defining the basic objects in as much general form as possible, leaving applications to other papers. A generalization of the story to the case of non-compact Lagrangian submanifolds is now studied by Yuan-Gao [Ga].

The construction of this paper is based on various earlier works. The author tried to make this paper independent from various earlier papers, except the detail of the proofs, as much as possible. By this reason this paper contains several review sections. Another reason why the review sections are included is that we need to rewrite some of the earlier results to those based on the de Rham version of virtual fundamental chain technique, which we use systematically in this paper. We refer [FOOO10, FOOO11, FOOO13] for the most detailed exposition of the de Rham version of virtual fundamental chain technique. (Kuranishi structures and CF-perturbations.) If the reader wants to know definitions and statements of the theory in [FOOO10, FOOO11, FOOO13] only (and not its proof), there is a summary in [FOOO8, Part 7].

The construction of Kuranishi structures on the moduli spaces of pseudo-holomorphic curves are written in detail in [FOOO9, Part 4], [FOOO12], [FOOO14, FOOO15]. It is written also in Section 12 of this paper emphasizing the part where the construction we need in this paper is (slightly) different from the other papers.

The results of this paper were announced in [Fu10, Fu11] together with the main idea of its proof.

The author would like to thank J. Evans, Y. Lekili, Y.-G. Oh, H. Ohta, K. Ono for helpful discussions while he is working on the contents of this paper. He also would like to thank anonymous referees for careful and serious reading, which is a heavy and pains taking work, and for huge number of important comments, which improve this paper much compared to its earlier version. Special thanks are to K. Ono who agreed to publish his article on sign and orientation as Appendix of this paper.

2. FILTERED A_∞ CATEGORY: REVIEW

This section is a review of the homological algebra of filtered A_∞ categories. There is nothing really new in this section. Our purpose here is to provide the precise definitions of the various notions we use in this paper. We give proofs only in the case when the author is unable to find an appropriate reference in the literature. Our main reference in this section is [Fu7]. There are other references such as [BLM, DL, Fu5, Ke1, Ke2, KS, Le, Se2]. In this section, we will discuss the algebraic side of the story only. In the case when the reader has certain knowledge of A_∞ categories, the reader can skip this section and comes back when it is used in later sections.

2.1. A_∞ **category.** We first recall certain notations.

Definition 2.1.

- (1) Let R be a commutative ring with unit. We denote by Λ_0^R the set of all the formal sums

$$\sum_{i=0}^{\infty} a_i T^{\lambda_i} \quad (2.1)$$

where $a_i \in R$, $\lambda_i \in \mathbb{R}$ and $0 = \lambda_0 < \lambda_1 < \dots < \lambda_i < \lambda_{i+1} < \dots$ with $\lim_{i \rightarrow \infty} \lambda_i = +\infty$. We can define a ring structure on Λ_0^R in an obvious way.

We call Λ_0^R the *universal Novikov ring*. In the case when R is a field its maximal ideal is the set of formal sums (2.1) with $a_0 = 0$. We write it as Λ_+^R . In the case when R is a field the field of fractions of Λ_0^R is the set of the formal sums of the form (2.1) such that $\lambda_0 < \lambda_1 < \dots < \lambda_i < \lambda_{i+1} < \dots$ with $\lambda_i \in \mathbb{R}$ and $\lim_{i \rightarrow \infty} \lambda_i = +\infty$. We denote it by Λ^R and call it the *universal Novikov field*. We use the same notation Λ_+^R (resp. Λ^R) for this ideal (resp. ring) in case R is a ring but is not a field.

We call R the *ground ring*. Sometimes we omit R from the notation and write Λ_0 etc. in place of Λ_0^R etc. In the geometric applications in this paper we use $R = \mathbb{R}$, since we use the de Rham model for homology theory of spaces.

- (2) We define a filtration $\{\mathfrak{F}^\lambda \Lambda_0 \mid \lambda \geq 0\}$ as follows. The subset $\mathfrak{F}^\lambda \Lambda_0$ of Λ_0 consists of elements (2.1) such that $\lambda_i < \lambda$ implies $a_i = 0$. We call it the *energy filtration*. It induces a filtration on Λ and Λ_+ in an obvious way.

The energy filtration defines a metric on Λ_0 , Λ , Λ_+ such that $\mathfrak{F}^\lambda \Lambda_0$ is the $e^{-\lambda}$ -neighborhood of 0. The rings Λ_0 , Λ , Λ_+ are complete with respect to this metric.

We call this metric the *T-adic metric*.

We use also the name energy filtration for the filtration of various Λ_0 (or Λ) modules induced by this filtration of Λ_0 .

- (3) A *discrete monoid* G is a discrete subset of $\mathbb{R}_{\geq 0}$ such that $0 \in G$ and $g_1, g_2 \in G \Rightarrow g_1 + g_2 \in G$.
- (4) For a discrete monoid G we define a subring Λ_G of Λ_0 , where a formal sum (2.1) is an element of Λ_G if and only if $\lambda_i \in G$ for all i with $a_i \neq 0$. The T -adic metric of Λ_0 induces one on Λ_G .
- (5) Let \overline{C} be a free R module. We denote by C the completion of $\overline{C} \otimes_R \Lambda_0^R$. Here the T adic metric on $\overline{C} \otimes_R \Lambda_0^R$ is induced from one on Λ_0^R in an obvious way and the completion is taken with respect to this metric. We call such C a *completed free Λ_0 module*. We write

$$\mathfrak{F}^\lambda C = \{x \in C \mid x \equiv 0 \pmod{T^\lambda}\}.$$

An element of C is identified with an (infinite) sum

$$\sum_{i=0}^{\infty} T^{\lambda_i} x_i$$

such that $x_i \in \overline{C}$ and $\lambda_i \in \mathbb{R}_{\geq 0}$ with $\lim_{i \rightarrow \infty} \lambda_i = +\infty$.

- (6) For two completed free Λ_0 modules C_1, C_2 we denote by $C_1 \widehat{\otimes} C_2$ the T -adic completion of the algebraic tensor product over Λ_0 . When C_i is the completion of $\overline{C}_i \otimes_R \Lambda_0$, for $i = 1, 2$, $C_1 \widehat{\otimes} C_2$ is the completion of $\overline{C}_1 \otimes_R \overline{C}_2 \otimes_R \Lambda_0$.

An element of $C_1 \widehat{\otimes} C_2$ is identified with an (infinite) sum

$$\sum_{i=0}^{\infty} x_i \otimes y_i$$

such that $x_i \in \mathfrak{F}^{\lambda_{i,1}} C_1$, $y_i \in \mathfrak{F}^{\lambda_{i,2}} C_2$ with $\lim_{i \rightarrow \infty} \lambda_{i,1} + \lambda_{i,2} = +\infty$.

- (7) If \overline{C} is graded then C is graded. (Here we consider either \mathbb{Z} grading or \mathbb{Z}_{2N} grading. In our geometric application we mostly use \mathbb{Z}_2 grading, for the sake of simplicity.) Suppose C is graded. We define its *degree shift* $C[1]$ as follows. $C[1]^m = C^{m+1}$. Here C^m is degree m part.
- (8) An element x of a completed free Λ_0 module C is said to be *G -gapped* if

$$x = \sum_{g \in G} T^g x_g$$

where $x_g \in \overline{C}$.

- (9) A Λ_0 module homomorphism φ between completed free Λ_0 modules C_1, C_2 are said to be *G -gapped* if it sends an arbitrary G -gapped element to a G -gapped element. This condition is equivalent to the condition that

$$\varphi = \sum_{g \in G} T^g \varphi_g \tag{2.2}$$

where $\varphi_g : \overline{C}_1 \rightarrow \overline{C}_2$ are R module homomorphisms.

- (10) For a G -gapped homomorphism φ as in (2.2), we write

$$\overline{\varphi} = \varphi_0 : \overline{C}_1 \rightarrow \overline{C}_2$$

and call it the *R -reduction* of φ . \diamond

Definition 2.2. A *non-unital curved filtered A_∞ category* \mathcal{C} is a collection of the set $\mathfrak{Ob}(\mathcal{C})$, the set of objects, a graded completed free Λ_0 module $\mathcal{C}(c_1, c_2)$ for each $c_1, c_2 \in \mathfrak{Ob}(\mathcal{C})$, and the operations

$$\mathfrak{m}_k : \mathcal{C}[1](c_0, c_1) \widehat{\otimes} \cdots \widehat{\otimes} \mathcal{C}[1](c_{k-1}, c_k) \rightarrow \mathcal{C}[1](c_0, c_k),$$

of degree +1 for $k = 0, 1, 2, \dots$ and $c_i \in \mathfrak{Ob}(\mathcal{C})$. (Note that in the case when $k = 0$ the domain is 0 if $c_0 \neq c_1$ and is Λ_0 if $c_0 = c_1$.)

We call $\mathcal{C}[1](c_0, c_1)$ the *module of morphisms* and \mathfrak{m}_k the *structure operations*. We assume the following three conditions.

- (1) We require \mathfrak{m}_k to satisfy the A_∞ formula (2.7) described below.
- (2) The operations \mathfrak{m}_k preserves the filtration.⁷ Namely:

$$\mathfrak{m}_k (\mathfrak{F}^\lambda (\mathcal{C}[1](c_0, c_1) \widehat{\otimes} \cdots \widehat{\otimes} \mathcal{C}[1](c_{k-1}, c_k))) \subseteq \mathfrak{F}^\lambda (\mathcal{C}[1](c_0, c_k)).$$

- (3) We have

$$\mathfrak{m}_0(1) \equiv 0 \pmod{T^\epsilon},$$

for some $\epsilon > 0$.

To describe the A_∞ formula, we introduce notations. Let $a, b \in \mathfrak{Ob}(\mathcal{C})$. We put

$$B_k \mathcal{C}[1](a, b) := \bigoplus_{a=c_0, c_1, \dots, c_{k-1}, c_k=b} \widehat{\mathcal{C}[1](c_0, c_1) \widehat{\otimes} \cdots \widehat{\otimes} \mathcal{C}[1](c_{k-1}, c_k)}. \quad (2.3)$$

(Here and hereafter $\widehat{\bigoplus}$ denotes the T -adic completion of the direct sum.)

Note that in the case when $k = 0$

$$B_0 \mathcal{C}[1](c_0, c_1) := \begin{cases} 0 & \text{if } c_0 \neq c_1, \\ \Lambda_0 & \text{if } c_0 = c_1. \end{cases} \quad (2.4)$$

We denote

$$B \mathcal{C}[1](a, b) = \bigoplus_{k=0,1,2,\dots} \widehat{B_k \mathcal{C}[1](a, b)}, \quad B \mathcal{C}[1] := \bigoplus_{a,b} \widehat{B \mathcal{C}[1](a, b)}.$$

We define a homomorphism

$$\Delta : B_k \mathcal{C}[1](a, b) \rightarrow \bigoplus_{k_1+k_2=k} \widehat{\bigoplus_c B_{k_1} \mathcal{C}[1](a, c) \widehat{\otimes} B_{k_2} \mathcal{C}[1](c, b)} \quad (2.5)$$

by

$$\Delta(x_1 \otimes \cdots \otimes x_k) := \sum_{k_1=0}^k (x_1 \otimes \cdots \otimes x_{k_1}) \otimes (x_{k_1+1} \otimes \cdots \otimes x_k).$$

It induces maps

$$\Delta : B_k \mathcal{C}[1] \rightarrow \bigoplus_{\substack{k_1+k_2=k, \\ k_1=0,\dots,k}} \widehat{B_{k_1} \mathcal{C}[1] \widehat{\otimes} B_{k_2} \mathcal{C}[1]},$$

($k = 0, 1, 2, \dots$) and $\Delta : B \mathcal{C}[1] \rightarrow B \mathcal{C}[1] \widehat{\otimes} B \mathcal{C}[1]$. Then $(B \mathcal{C}[1](a, a), \Delta)$ and $(B \mathcal{C}[1], \Delta)$ are graded formal coalgebras.⁸

⁷Actually this condition follows automatically from Λ_0 linearity.

⁸The coalgebra structure is defined by a map $\Delta : C \rightarrow C \otimes C$. Here the target of our Δ is the completion $C \widehat{\otimes} C$. In such a case it is called a *formal coalgebra*. Such a notion appears in the theory of formal groups.

Operations \mathbf{m}_k define homomorphisms $: B_k\mathcal{C}[1](a, b) \rightarrow \mathcal{C}[1](a, b)$. It can be extended uniquely to coderivations

$$\hat{d}_k : B\mathcal{C}[1] \rightarrow B\mathcal{C}[1], \quad \hat{d}_k : B\mathcal{C}[1](a, b) \rightarrow B\mathcal{C}[1](a, b)$$

by

$$\hat{d}_k(x_1 \otimes \cdots \otimes x_n) := \sum_{\ell} (-1)^* x_1 \otimes \cdots \otimes \mathbf{m}_k(x_\ell, \dots, x_{\ell+k-1}) \otimes \cdots \otimes x_n,$$

where $*$ = $(\deg x_1 + 1) + \cdots + (\deg x_{\ell-1} + 1)$. We put

$$\hat{d} := \sum_k \hat{d}_k. \quad (2.6)$$

Now the A_∞ formula is

$$\hat{d} \circ \hat{d} = 0. \quad (2.7)$$

Note that (2.7) is equivalent to the equality

$$0 = \sum_{k_1+k_2=k+1} \sum_{i=0}^{k_1-1} (-1)^* \mathbf{m}_{k_1}(x_1, \dots, x_i, \mathbf{m}_{k_2}(x_{i+1}, \dots, x_{k_2}), \dots, x_k), \quad (2.8)$$

where $*$ = $i + \sum_{j=1}^i \deg x_j$.

We use the notation

$$\deg' x := \deg x - 1 \quad (2.9)$$

then $*$ = $\sum_{j=1}^i \deg' x_j$. \diamond

Remark 2.3. The sign convention in (2.8) is the same as [FOOO1] but is different from [Se2]. It seems that two different conventions are related to each other by the process to take opposite category (Definition 2.30). \diamond

Remark 2.4. We can define the notion of a non-unital A_∞ category over a ring R (which is not filtered) in the same way except the following.

- (1) We do not require the structure operations \mathbf{m}_k to preserve the filtration.
- (2) We require $\mathbf{m}_0 = 0$. In other words we require strictness, in the sense of Definition 2.5 (2).

Note that item (2) is our convention. At this stage this is only a matter of convention. Namely we may include the curved case over (unfiltered) ring. It may be natural to do so in the case when we study the situation where structure operations are converging (in the Lagrangian Floer theory) and the version over \mathbb{C} . Also in the case of monotone Lagrangian submanifolds with minimal Maslov number 2 such a situation appears naturally.

Since we required $\mathbf{m}_0 \equiv 0 \pmod{T^\epsilon}$ we include this condition.

There will appear more serious reasons related to item (2), as the story goes on. See Remarks 2.6, 2.12. \diamond

Definition 2.5. Let \mathcal{C} be a non-unital curved filtered A_∞ category.

- (1) We say \mathcal{C} is *G-gapped* if all the operations \mathbf{m}_k are *G-gapped*.
- (2) We say \mathcal{C} is a *non-unital filtered A_∞ category* if $\mathbf{m}_0 = 0$. We also say that \mathcal{C} is *strict* instead.
- (3) If \mathcal{C} is *G-gapped* we define *R-reduction* $\overline{\mathcal{C}}$ of our filtered A_∞ category as follows. It is an A_∞ category over R in the sense of Remark 2.4.
 - (a) $\mathfrak{D}\mathfrak{B}(\overline{\mathcal{C}}) = \mathfrak{D}\mathfrak{B}(\mathcal{C})$.

(b) For $c, c' \in \mathfrak{D}\mathfrak{B}(\overline{\mathcal{C}})$, there is a free R module $\overline{\mathcal{C}}(c, c')$ such that $\mathcal{C}(c, c')$ is a completion of $\overline{\mathcal{C}}(c, c') \otimes_R \Lambda_0$, by the definition of a completed free Λ_0 module. We take this R module $\overline{\mathcal{C}}(c, c')$ as the module of morphisms of $\overline{\mathcal{C}}$.

(c) The structure morphisms $\overline{\mathfrak{m}}_k$ are the R -reductions of \mathfrak{m}_k .

Note that $\overline{\mathfrak{m}}_0 = 0$ by Definition 2.2 (3). Other conditions for $\overline{\mathcal{C}}$ to be an A_∞ category follow from the corresponding properties of \mathcal{C} .

(4) We say \mathcal{C} is *unital* (or \mathcal{C} is a curved filtered A_∞ category) if there exists $\mathbf{e}_c \in \mathcal{C}^0(c, c)$ for each $c \in \mathfrak{D}\mathfrak{b}(\mathcal{C})$ such that the following holds.

(a) If $x_1 \in \mathcal{C}(c, c')$, $x_2 \in \mathcal{C}(c', c)$ then

$$\mathfrak{m}_2(\mathbf{e}_c, x_1) = x_1, \quad \mathfrak{m}_2(x_2, \mathbf{e}_c) = (-1)^{\deg x_2} x_2.$$

(b) If $k + \ell \neq 1$, $x_1 \otimes \cdots \otimes x_\ell \in B_\ell \mathcal{C}[1](a, c)$, $y_1 \otimes \cdots \otimes y_k \in B_k \mathcal{C}[1](c, b)$ then

$$\mathfrak{m}_{k+\ell+1}(x_1, \dots, x_\ell, \mathbf{e}_c, y_1, \dots, y_k) = 0. \quad (2.10)$$

(5) A *filtered A_∞ algebra* is a non-unital curved filtered A_∞ category with one object. Its unitality and strictness is defined as its unitality and strictness as a non-unital curved filtered A_∞ category.

(6) Let $\mathfrak{C} = (C, \{\mathfrak{m}_k\})$ be an A_∞ algebra. We define $\widetilde{\mathfrak{M}}(C; \Lambda_+)$, the *Maurer-Cartan solution space* of C , as the set of all elements $b \in C^1$ such that

(a) $b \equiv 0 \pmod{\Lambda_+}$.⁹

(b)

$$\sum_{k=0}^{\infty} \mathfrak{m}_k(b, \dots, b) = 0. \quad (2.11)$$

We remark that the left hand side is an infinite sum, which converges in T -adic topology.¹⁰¹¹ An element of $\widetilde{\mathfrak{M}}(\mathfrak{C}; \Lambda_+)$ is called a *bounding cochain*.

(7) Let \mathcal{C} be a non-unital curved filtered A_∞ category. We define a non-unital filtered A_∞ category \mathcal{C}^s as follows.

(a) An object of \mathcal{C}^s is a pair (c, b) where $c \in \mathfrak{D}\mathfrak{B}(\mathcal{C})$ and $b \in \widetilde{\mathfrak{M}}(\mathcal{C}(c, c); \Lambda_+)$.

(b) If $(c, b), (c', b')$ are objects of \mathcal{C}^s then $\mathcal{C}^s((c, b), (c', b')) = \mathcal{C}(c, c')$ by definition.

(c) If $(c_i, b_i) \in \mathfrak{D}\mathfrak{B}(\mathcal{C}^s)$ for $i = 0, \dots, k$ and $x_i \in \mathcal{C}^s((c_{i-1}, b_{i-1}), (c_i, b_i)) = \mathcal{C}(c_{i-1}, c_i)$ for $i = 1, \dots, k$. Then we define the structure operations $\mathfrak{m}_k^{(b_0, \dots, b_k)}$ of \mathcal{C}^s as follows.

$$\mathfrak{m}_k^{(b_0, \dots, b_k)}(x_1, \dots, x_k) = \sum_{\ell_0, \dots, \ell_k} \mathfrak{m}_{k+\ell_0+\dots+\ell_k}(b_0^{\ell_0}, x_1, b_1^{\ell_1}, \dots, b_{k-1}^{\ell_{k-1}}, x_k, b_k^{\ell_k}).$$

⁹We study the case when this condition is not satisfied sometimes and define $\widetilde{\mathfrak{M}}(\mathfrak{C}; \Lambda_0)$. In such a case the equation (2.11) is more delicate to define since the left hand side may not converge in T -adic topology. We do not discuss this generalization in this paper. See for example [FOOO6].

¹⁰In case \mathcal{C} is unital, we sometimes study the weaker equation which replaces the right hand side by $C\mathbf{e}$ for some $C \in \Lambda_+$. See [FOOO1, Section 4.3].

¹¹We can define an equivalence relation called gauge equivalence so that the A_∞ structure defined by the deformed operators \mathfrak{m}_k^b depends only on the gauge equivalence class of b . See [FOOO1, Section 3.6.3].

The proof of the fact that this formula defines a non-unital filtered A_∞ category is similar to the corresponding result in the case of an A_∞ algebra, which is proved as [FOOO1, Proposition 3.6.10].

We call \mathcal{C}^s the *associated strict category* to \mathcal{C} .

If \mathcal{C} is unital then \mathcal{C}^s is also unital. \diamond

Remark 2.6. Note that (2.11) does not make sense in the case of an (unfiltered) A_∞ category. In fact the left hand side is an infinite sum. (This is one reason why we assume strictness for (unfiltered) A_∞ category.)

There are several ways to go around this point. We will not discuss it here. \diamond

Remark 2.7. In Definition 2.5 (4) we required strict unitality. In [FOOO1, Definition 3.3.2] we defined the notion of a homotopy unit of a filtered A_∞ algebra. We can define the notion of a homotopy unit of a filtered A_∞ category in the same way. We do not discuss it in this paper, since in our geometric application we can construct a strict unit by using the de Rham model. \diamond

Definition 2.8. (Bondal and Kapranov [BK]) An A_∞ category is said to be a *differential graded category* or a *DG-category* if $\mathfrak{m}_k = 0$ for $k \neq 1, 2$. \diamond

Remark 2.9. In the usual definition of a DG-category, the space of morphisms $\mathcal{C}(c_1, c_2)$ is a chain complex with boundary operator d and the composition map

$$\circ : \mathcal{C}(c_1, c_2) \otimes \mathcal{C}(c_2, c_3) \rightarrow \mathcal{C}(c_1, c_3)$$

is assumed to be a chain map and the compositions are assumed to be associative (strictly). We change the sign and define

$$\begin{aligned} \mathfrak{m}_1(x) &:= (-1)^{\deg x + 1} d(x), \\ \mathfrak{m}_2(x, y) &:= (-1)^{\deg x (\deg y + 1)} y \circ x. \end{aligned}$$

Then it satisfies A_∞ relation (2.8). (See [Fu7, Example-Lemma 1.7].) There is an alternative choice of the sign, that is,

$$\begin{aligned} \mathfrak{m}_1(x) &:= d(x), \\ \mathfrak{m}_2(x, y) &:= (-1)^{\deg x} x \circ y. \end{aligned}$$

This is the choice in [FOOO13, Definition 21.21 (2)(3)]. \diamond

2.2. A_∞ functor.

Definition 2.10. Let \mathcal{C}_i , $i = 1, 2$ be non-unital curved filtered A_∞ categories. A *filtered A_∞ functor* $\mathcal{F} : \mathcal{C}_1 \rightarrow \mathcal{C}_2$ is a collection of \mathcal{F}_{ob} , \mathcal{F}_k , $k = 0, 1, 2, \dots$ such that:

- (1) We are given a set theoretical map $\mathcal{F}_{ob} : \mathfrak{Ob}(\mathcal{C}_1) \rightarrow \mathfrak{Ob}(\mathcal{C}_2)$, which we call the *object part* of \mathcal{F} .
- (2) For $c_1, c_2 \in \mathfrak{Ob}(\mathcal{C}_1)$, $\mathcal{F}_k(c_1, c_2) : B_k \mathcal{C}_1[1](c_1, c_2) \rightarrow \mathcal{C}_2[1](\mathcal{F}_{ob}(c_1), \mathcal{F}_{ob}(c_2))$ is a Λ_0 module homomorphism of degree 0. It preserves filtration in a similar sense as Definition 2.2 (2). We write \mathcal{F}_k in place of $\mathcal{F}_k(c_1, c_2)$ sometimes.
- (3) We require that $\mathcal{F}_0 \equiv 0 \pmod{T^\epsilon}$, $\epsilon > 0$. Note that \mathcal{F}_0 consists of maps $\mathcal{F}_0(c) : \Lambda_0 \rightarrow \mathcal{C}_2[1](\mathcal{F}_{ob}(c), \mathcal{F}_{ob}(c))$ for each $c \in \mathfrak{Ob}(\mathcal{C}_1)$.

(4) We extend $\mathcal{F}_k(c_1, c_2)$ to a formal coalgebra homomorphism

$$\widehat{\mathcal{F}}(c_1, c_2) : B\mathcal{C}_1[1](c_1, c_2) \rightarrow B\mathcal{C}_2[1](\mathcal{F}_{ob}(c_1), \mathcal{F}_{ob}(c_2)).$$

Then $\widehat{\mathcal{F}}(c_1, c_2)$ is a chain map with respect to the boundary operator \hat{d} in (2.6). \diamond

Remark 2.11. In Definition 2.10 we include the case $\mathcal{F}_0 \neq 0$, that is, a ‘curved’ filtered A_∞ functor. (In [Fu7] we did not include it. However the definition of filtered A_∞ algebra homomorphism in [FOOO1, Definition 3.2.29] includes the case $f_0 \neq 0$.)

The map $\widehat{\mathcal{F}}$ on $B_k\mathcal{C}_1[1](c_1, c_2)$ is defined by

$$\begin{aligned} & \widehat{\mathcal{F}}(x_1, \dots, x_k) \\ & := \sum_{\ell=1}^{\infty} \sum_{\substack{k_1, \dots, k_\ell \\ k_1 + \dots + k_\ell = k}} \mathcal{F}_{k_1}(x_1, \dots, x_{k_1}) \otimes \dots \otimes \mathcal{F}_{k_\ell}(x_{k-k_\ell+1}, \dots, x_k), \end{aligned} \quad (2.12)$$

for $k \geq 1$. For $k = 0$ it is

$$\widehat{\mathcal{F}}(1) := 1 + \sum_{\ell=1}^{\infty} \mathcal{F}_0(1)^{\otimes \ell}$$

$\widehat{\mathcal{F}}$ is a formal coalgebra homomorphism. \diamond

Remark 2.12. We define an A_∞ functor between (unfiltered) A_∞ categories in the same way.

We require $\mathcal{F}_0 = 0$ in the unfiltered situation.

There is more serious reason to require it compared to Remark 2.4 (2). We remark that in our situation where $\mathcal{F}_0 \neq 0$, the right hand side of (2.12) is an *infinite* sum. It converges in T -adic topology thanks to Definition 2.10 (3). In the case when we work over the ground ring, the unfiltered case, the right hand side of (2.12) should be a finite sum. \diamond

Definition 2.13. Let $\mathcal{F} : \mathcal{C}_1 \rightarrow \mathcal{C}_2$ be a filtered A_∞ functor between non-unital curved filtered A_∞ categories.

- (1) We say \mathcal{F} is *strict* if $\mathcal{F}_0 = 0$.
- (2) Suppose $\mathcal{C}_1, \mathcal{C}_2$ are G -gapped. We say \mathcal{F} is G -gapped if all the maps \mathcal{F}_k are G -gapped for $k = 0, 1, 2, \dots$
- (3) A G -gapped filtered A_∞ functor between non-unital curved filtered A_∞ categories induce an A_∞ functor between their R -reductions.
- (4) Suppose \mathcal{C}_1 and \mathcal{C}_2 are unital in addition. We say \mathcal{F} is (strictly) *unital* if the following two conditions are satisfied.
 - (a) $\mathcal{F}_1(\mathbf{e}_c) = \mathbf{e}_{\mathcal{F}_{ob}(c)}$.
 - (b)

$$\mathcal{F}_{k+l+1}(x_1, \dots, x_\ell, \mathbf{e}_c, y_1, \dots, y_\ell) = 0$$

for $k + \ell > 0$.

- (5) If $\mathcal{F} : \mathcal{C}_1 \rightarrow \mathcal{C}_2$ is a filtered A_∞ functor between non-unital curved filtered A_∞ categories then we obtain a strict filtered A_∞ functor $\mathcal{F}^s : \mathcal{C}_1^s \rightarrow \mathcal{C}_2^s$ between their associated strict categories as follows.

(a) Let $c \in \mathfrak{D}\mathfrak{B}(\mathcal{C}_1)$ and $b \in \widetilde{\mathfrak{M}}(\mathcal{C}(c, c); \Lambda_+)$. We put

$$\mathcal{F}_*(b) := \sum_{k=0}^{\infty} \mathcal{F}_k(b, \dots, b).$$

We can prove $\mathcal{F}_*(b) \in \widetilde{\mathfrak{M}}(\mathcal{C}(\mathcal{F}_{ob}(c), \mathcal{F}_{ob}(c)); \Lambda_+)$.
We define

$$\mathcal{F}_{ob}^s(c, b) := (\mathcal{F}_{ob}(c), \mathcal{F}_*(b)).$$

(b) Let $(c_i, b_i) \in \mathfrak{D}\mathfrak{B}(\mathcal{C}_1^i)$, $i = 0, \dots, k$ and $x_i \in \mathcal{C}_1^s((c_{i-1}, b_{i-1}), (c_i, b_i)) = \mathcal{C}_1(c_{i-1}, c_i)$, $i = 1, \dots, k$. We put

$$\mathcal{F}_k^s(x_1, \dots, x_k) := \sum_{\ell_0, \dots, \ell_k} \mathcal{F}_{k+\ell_0+\dots+\ell_k}(b_0^{\ell_0}, x_1, b_1^{\ell_1}, \dots, b_{k-1}^{\ell_{k-1}}, x_k, b_k^{\ell_k}).$$

We also put $\mathcal{F}_0^s = 0$. We can show that \mathcal{F}_{ob}^s and \mathcal{F}_k^s define a strict filtered A_∞ functor $\mathcal{F}^s : \mathcal{C}_1^s \rightarrow \mathcal{C}_2^s$, in the same way as [FOOO1, Lemma 3.6.36, Definition-Lemma 5.2.15, Lemma 5.2.16]. (They discuss the case of A_∞ algebra.) We say \mathcal{F}^s is the *associated strict functor* to \mathcal{F} . If \mathcal{F} is unital (resp. G -gapped) then so is \mathcal{F}^s .

- (6) The *identity functor* $\mathcal{I}\mathcal{D} : \mathcal{C} \rightarrow \mathcal{C}$ is defined by
- (a) $\mathcal{I}\mathcal{D}_{ob} =$ the identity map : $\mathfrak{D}\mathfrak{B}(\mathcal{C}) \rightarrow \mathfrak{D}\mathfrak{B}(\mathcal{C})$.
 - (b) $\mathcal{I}\mathcal{D}_1(c_1, c_2) : \mathcal{C}(c_1, c_2) \rightarrow \mathcal{C}(c_1, c_2)$ is the identity map.
 - (c) $\mathcal{I}\mathcal{D}_k = 0$ for $k \neq ob, 1$
- $\mathcal{I}\mathcal{D}$ is unital (resp. G -gapped) if so is \mathcal{C} . \diamond

Definition-Lemma 2.14. Let $\mathcal{F}^1 : \mathcal{C}_1 \rightarrow \mathcal{C}_2$, $\mathcal{F}^2 : \mathcal{C}_2 \rightarrow \mathcal{C}_3$ be filtered A_∞ functors.

- (1) We define their *composition* $\mathcal{F} = \mathcal{F}^2 \circ \mathcal{F}^1 : \mathcal{C}_1 \rightarrow \mathcal{C}_3$ as follows.

$$\begin{aligned} \mathcal{F}_{ob} &= \mathcal{F}_{ob}^2 \circ \mathcal{F}_{ob}^1 \\ \widehat{\mathcal{F}}(c_1, c_2) &= \widehat{\mathcal{F}}^2(\mathcal{F}_{ob}^1(c_1), \mathcal{F}_{ob}^1(c_2)) \circ \widehat{\mathcal{F}}^1(c_1, c_2) \\ &: B\mathcal{C}_1(c_1, c_2) \rightarrow B\mathcal{C}_3(\mathcal{F}_{ob}(c_1), \mathcal{F}_{ob}(c_2)). \end{aligned} \quad (2.13)$$

- (2) If $\mathcal{F}^1, \mathcal{F}^2$ are strict (resp. unital, G -gapped) then $\mathcal{F} = \mathcal{F}^2 \circ \mathcal{F}^1$ is strict (resp. unital, G -gapped).
- (3) If $\mathcal{F}^{1s}, \mathcal{F}^{2s}$ are strict functors associated to $\mathcal{F}^1, \mathcal{F}^2$ respectively then $\mathcal{F}^{1s} \circ \mathcal{F}^{2s}$ is the strict functor associated to $\mathcal{F}^1 \circ \mathcal{F}^2$.
- (4) $\mathcal{F} \circ \mathcal{I}\mathcal{D} = \mathcal{I}\mathcal{D} \circ \mathcal{F} = \mathcal{F}$. \diamond

The proof is easy and is omitted.

2.3. Functor category.

Definition 2.15. ([Fu7, Definition 7.49]) Let $\mathcal{F}, \mathcal{G} : \mathcal{C}_1 \rightarrow \mathcal{C}_2$ be two curved filtered A_∞ functors between non-unital curved filtered A_∞ categories.

A *pre-natural transformation* from \mathcal{F} to \mathcal{G} of degree d is a family of operators $\mathcal{T} = \{\mathcal{T}_k(a, b)\}$

$$\mathcal{T}_k(a, b) : B_k\mathcal{C}_1[1](a, b) \rightarrow \mathcal{C}_2[1](\mathcal{F}_{ob}(a), \mathcal{G}_{ob}(b))$$

of degree d for $k = 0, 1, 2, \dots$ and $a, b \in \mathfrak{D}\mathfrak{B}(\mathcal{C}_1)$, which preserves filtration in the same sense as Definition 2.2 (2).¹² We require that the image of \mathcal{T}_0 has strictly positive energy.

We write $\mathfrak{deg}\mathcal{T} := d + 1$ and $\mathfrak{deg}' := \mathfrak{deg} - 1 = d$.¹³

We say that \mathcal{T} is G -gapped if each of $\mathcal{T}_k(a, b)$ is G -gapped.

We denote by $\mathcal{F}\text{UNC}(\mathcal{F}, \mathcal{G})$ the set of all pre-natural transformations from \mathcal{F} to \mathcal{G} . It is a completed free Λ_0 module and is graded. We denote by $\mathcal{F}\text{UNC}^d(\mathcal{F}, \mathcal{G})$ the degree d part. In other words, if $\mathcal{T} \in \mathcal{F}\text{UNC}^d(\mathcal{F}, \mathcal{G})$ then $\mathfrak{deg}\mathcal{T} = d + 1$ and $\mathfrak{deg}'\mathcal{T} = d$. \diamond

Remark 2.16. We remark that $\mathcal{T}_0(a, b) = 0$ if $a \neq b$ and $\mathcal{T}_0(a, a)$ is a Λ_0 module homomorphism

$$\mathcal{T}_0(a, a) : B_0\mathcal{C}_1[1](a, a) = \Lambda_0 \rightarrow \mathcal{C}_2[1](\mathcal{F}_{ob}(a), \mathcal{G}_{ob}(a)).$$

We denote by $\mathcal{T}_0(a) \in \mathcal{C}_2[1](\mathcal{F}_{ob}(a), \mathcal{G}_{ob}(a))$ the element $\mathcal{T}_0(a, a)(1)$. \diamond

For $a', b' \in \mathfrak{D}\mathfrak{b}(\mathcal{C}_2)$, let

$$\pi_{a', b'} : B\mathcal{C}_2[1](a', b') \rightarrow \mathcal{C}_2[1](a', b')$$

be the projection.

Lemma-Definition 2.17.

(1) For each $\mathcal{T} = \{\mathcal{T}_k(a, b)\} \in \mathcal{F}\text{UNC}^d(\mathcal{F}, \mathcal{G})$ there exists uniquely a family

$$\widehat{\mathcal{T}}(a, b) : B\mathcal{C}_1[1](a, b) \rightarrow B\mathcal{C}_2[1](\mathcal{F}_{ob}(a), \mathcal{G}_{ob}(b)),$$

of Λ_0 module homomorphisms with the following properties.

$$\begin{aligned} \pi_{\mathcal{F}_{ob}(a), \mathcal{G}_{ob}(b)} \circ \widehat{\mathcal{T}}(a, b) &= \mathcal{T}_k(a, b) \quad \text{on } B_k\mathcal{C}_1[1](a, b). \\ \Delta \circ \widehat{\mathcal{T}}(a, b) &= \sum_c (\widehat{\mathcal{F}} \otimes_s \widehat{\mathcal{T}}(c, b) + \widehat{\mathcal{T}}(a, c) \otimes_s \widehat{\mathcal{G}}) \circ \Delta. \end{aligned} \quad (2.14)$$

Here \otimes_s is defined by $(A \otimes_s B)(\mathbf{x}, \mathbf{y}) = (-1)^{\deg B \deg' \mathbf{x}} A(\mathbf{x}) \otimes B(\mathbf{y})$.

(2) There exists $\delta\mathcal{T} = \{(\delta\mathcal{T})_k(a, b)\} \in \mathcal{F}\text{UNC}^{\mathfrak{deg}\mathcal{T}+1}(\mathcal{F}, \mathcal{G})$ uniquely such that

$$\widehat{\delta\mathcal{T}} = \hat{d} \circ \widehat{\mathcal{T}} + (-1)^{\mathfrak{deg}\mathcal{T}+1} \widehat{\mathcal{T}} \circ \hat{d}.$$

(3) $\delta(\delta\mathcal{T}) = 0$.

(4) A pre-natural transformation \mathcal{T} is said to be a natural transformation if $\delta\mathcal{T} = 0$. \diamond

(1) is [Fu7, Lemma 7.45]. (2) is [Fu7, Lemma 7.48]. (3) is [Fu7, Corollary 7.50].

Definition 2.18. Let $\mathcal{F}^{(i)} : \mathcal{C}_1 \rightarrow \mathcal{C}_2$, $i = 0, \dots, k$ be curved filtered A_∞ functors between non-unital curved A_∞ categories and $\mathcal{T}^{(i)} \in \mathcal{F}\text{UNC}^{d_i}(\mathcal{F}^{(i-1)}, \mathcal{F}^{(i)})$ for $i = 1, \dots, k$. (Here $k = 1, 2, \dots$)

We define $\mathfrak{m}_k(\mathcal{T}^{(1)}, \dots, \mathcal{T}^{(k)}) = \mathcal{T} \in \mathcal{F}\text{UNC}^d(\mathcal{F}^{(0)}, \mathcal{F}^{(k)})$ as follows. ($d = d_1 + \dots + d_k + 1$.)

If $k = 1$ then $\mathfrak{m}_1(\mathcal{T}^{(1)}) = -\delta(\mathcal{T}^{(1)})$, where δ is as in Definition 2.17 (2).

¹²It means that $\deg' \mathcal{T}_k(a, b)(\mathbf{x}) = \deg' \mathbf{x} + d$, where $\deg' x_1 \otimes \dots \otimes x_k = \sum \deg' x_i$.

¹³This convention is different from [Fu7, two lines below (7.44)]. Actually in [Fu7, (7.12.2)] \deg' is defined as $\deg + 1$, which is different from our convention here. The convention of this paper coincides with [FOOO1, (3.2.2)], which seems better than one in [Fu7]. (See a line after Definition 2.22, for example.) This inconsistency does not affect to the calculation of the sign in [Fu7] which we use much in this paper.

Suppose $k \geq 2$. Let $\mathbf{x} \in B(\mathcal{C}_1[1])$. We consider

$$\Delta^{2k}\mathbf{x} = \sum_a \mathbf{x}_a^{(1)} \otimes \cdots \otimes \mathbf{x}_a^{(2k+1)}.$$

Here $\Delta^m : B(\mathcal{C}_1[1]) \rightarrow \underbrace{B(\mathcal{C}_1[1]) \otimes \cdots \otimes B(\mathcal{C}_1[1])}_{m+1}$ is defined inductively by $\Delta^m :=$

$(\Delta \otimes \text{id}) \circ \Delta^{m-1}$, $\Delta^1 = \Delta$. We put

$$\mathcal{T}(\mathbf{x}) := - \sum_a (-1)^{*a} \mathbf{m} \left(\widehat{\mathcal{F}}^{(0)}(\mathbf{x}_a^{(1)}), \mathcal{T}^{(1)}(\mathbf{x}_a^{(2)}), \dots, \mathcal{T}^{(k)}(\mathbf{x}_a^{(2k)}), \widehat{\mathcal{F}}^{(k)}(\mathbf{x}_a^{(2k+1)}) \right),$$

where $*a = \sum_{j=1}^k \sum_{i=1}^{2j-1} d_j \deg' \mathbf{x}_a^{(i)}$. Note that

$$\deg' \mathcal{T}(\mathbf{x}) = \sum_{i=1}^{k+1} \deg' \mathbf{x}_a^{(i)} + \sum_{i=1}^k \mathfrak{deg}' \mathcal{T}^{(i)} + 1.$$

Therefore $\mathfrak{deg}' \mathcal{T} = \sum_{i=1}^k \mathfrak{deg}' \mathcal{T}^{(i)} + 1$. This is consistent with Definition 2.2.

We consider the case when $k = 0$. We will define $\mathbf{m}_0^{\mathcal{F}}(1) \in \text{FUNCC}(\mathcal{F}, \mathcal{F})$ (the \mathbf{m}_0 operator of the functor category). For $c \in \mathfrak{DB}(\mathcal{C}_2)$, the \mathbf{m}_0 operator of \mathcal{C}_2 determine an element $\mathbf{m}_0(1)_c \in \mathcal{C}[1](\mathcal{F}_{ob}(c), \mathcal{F}_{ob}(c))$. We put

$$\mathbf{m}_0^{\mathcal{F}}(1)_c := -\mathbf{m}_0(1)_c.$$

◇

Theorem 2.19. *Let $\mathcal{C}_1, \mathcal{C}_2$ be curved filtered A_∞ categories. Then, there exists a non-unital curved filtered A_∞ category $\text{FUNCC}(\mathcal{C}_1, \mathcal{C}_2)$ such that:*

- (1) *The set of its objects $\mathfrak{DB}(\text{FUNCC}(\mathcal{C}_1, \mathcal{C}_2))$ consists of filtered A_∞ functors $\mathcal{F} : \mathcal{C}_1 \rightarrow \mathcal{C}_2$.*
- (2) *For $\mathcal{F}, \mathcal{G} \in \mathfrak{DB}(\text{FUNCC}(\mathcal{C}_1, \mathcal{C}_2))$, the module of morphisms from \mathcal{F} to \mathcal{G} is $\text{FUNCC}(\mathcal{F}, \mathcal{G})$.*
- (3) *The structure operations $\mathbf{m}_k : B_k \text{FUNCC}(\mathcal{F}, \mathcal{G}) \rightarrow \text{FUNCC}(\mathcal{F}, \mathcal{G})$ are as in Definition 2.18.*

We denote by $\text{FUNCC}(\mathcal{C}_1, \mathcal{C}_2)$ the full subcategory of $\text{FUNCC}(\mathcal{C}_1, \mathcal{C}_2)$ the set of whose objects are strict filtered A_∞ functors.

If \mathcal{C}_2 is strict then $\text{FUNCC}(\mathcal{C}_1, \mathcal{C}_2)$ and $\text{FUNCC}(\mathcal{C}_1, \mathcal{C}_2)$ are strict.

In case $\mathcal{C}_1, \mathcal{C}_2$ are unital and/or strict, we consider only unital and/or strict filtered A_∞ functors as objects of $\text{FUNCC}(\mathcal{C}_1, \mathcal{C}_2)$. In that way we obtain strict and unital filtered A_∞ category. ◇

This is [Fu7, Theorem-Definition 7.55]. (Note that only the strict case is proved in [Fu7, Theorem-Definition 7.55]. However the proof there can be applied without change in our case. The functor category in the curved case is also studied in [DL, Section 3.4].) We call $\text{FUNCC}(\mathcal{C}_1, \mathcal{C}_2)$, $\text{FUNCC}(\mathcal{C}_1, \mathcal{C}_2)$ the *functor category*.

Proposition 2.20. *A strict A_∞ functor $\mathcal{F} : \mathcal{C}_1 \rightarrow \mathcal{C}_2$ induces strict A_∞ functors $\mathcal{F}_* : \text{FUNCC}(\mathcal{C}, \mathcal{C}_1) \rightarrow \text{FUNCC}(\mathcal{C}, \mathcal{C}_2)$, $\mathcal{F}^* : \text{FUNCC}(\mathcal{C}_2, \mathcal{C}) \rightarrow \text{FUNCC}(\mathcal{C}_1, \mathcal{C})$ such that $(\mathcal{F}_*)_{ob}(\mathcal{G}) = \mathcal{F} \circ \mathcal{G}$, $(\mathcal{F}^*)_{ob}(\mathcal{G}) = \mathcal{G} \circ \mathcal{F}$.*

The same is true if we replace FUNCC by FUNCC . (In that case we do not need to assume \mathcal{F} to be strict.) ◇

This is [Fu7, Proposition-Definition 8.41].

Definition 2.21. In the situation of Theorem 2.19 we assume that $\mathcal{C}_1, \mathcal{C}_2$ are G -gapped. We define a G -gapped filtered A_∞ category $\mathcal{F}UNC^G(\mathcal{C}_1, \mathcal{C}_2)$ as follows.

Its object is a G -gapped filtered A_∞ functors $\mathcal{F} : \mathcal{C}_1 \rightarrow \mathcal{C}_2$.

The morphisms and the structure maps are the same as Theorem 2.19 (2)(3). It is easy to see that the structure maps are G -gapped.

The G -gapped version of Proposition 2.20 holds.

We may replace $\mathcal{F}UNC$ by $\mathcal{F}UNCC$. \diamond

Hereafter in the case of G -gapped category we omit G and write $\mathcal{F}UNC(\mathcal{C}_1, \mathcal{C}_2)$ in place of $\mathcal{F}UNC^G(\mathcal{C}_1, \mathcal{C}_2)$.

Definition 2.22. ([Fu7, Definition 8.2]) Let $\mathcal{F} : \mathcal{C}_1 \rightarrow \mathcal{C}_2$ be a curved filtered A_∞ functors between non-unital curved filtered A_∞ categories. We assume \mathcal{C}_2 is unital in addition. We define the *identity natural transformation* $\text{Id}^{\mathcal{F}}$ as follows. Let $\mathbf{e}_c \in \mathcal{C}_2^0(c, c)$ be the unit in \mathcal{C}_2 . We put

$$\begin{aligned} \text{Id}_{ob}^{\mathcal{F}}(a) &= -\mathbf{e}_{\mathcal{F}_{ob}(a)} \in \mathcal{C}_2^{pb}(\mathcal{F}_0(a), \mathcal{F}_0(a)), \\ \text{Id}_k^{\mathcal{F}} &= 0, \quad \text{for } k \geq 1. \end{aligned}$$

\diamond

Note that $\text{deg}' \mathbf{e}_{\mathcal{F}_{ob}(a)} = \text{deg} \mathbf{e}_{\mathcal{F}_{ob}(a)} - 1 = -1$. Therefore $\text{deg} \text{Id}^{\mathcal{F}} = 0$.

It is easy to see from definition that $\text{Id}^{\mathcal{F}}$ satisfies (2.10) for the structure operations \mathbf{m}_k of $\mathcal{F}UNCC(\mathcal{C}_1, \mathcal{C}_2)$. Therefore, we have the following:

Lemma 2.23. *If \mathcal{C}_2 is unital then $\mathcal{F}UNCC(\mathcal{C}_1, \mathcal{C}_2)$ is unital.* \diamond

2.4. A_∞ -Whitehead Theorem. In this subsection all filtered A_∞ categories are assumed to be strict (except in Remark 2.29).

Definition 2.24. Let \mathcal{C} be a strict filtered A_∞ category and $c, c' \in \mathfrak{Ob}(\mathcal{C})$. Let $x \in \mathcal{C}^0(c, c')$. We say that x is a *homotopy equivalence* if there exists $y \in \mathcal{C}^0(c', c)$ such that:

- (1) $\mathbf{m}_1(x) = \mathbf{m}_1(y) = 0$.
- (2) $\mathbf{m}_2(y, x) - \mathbf{e}_c \in \text{Im } \mathbf{m}_1, \mathbf{m}_2(x, y) - \mathbf{e}_{c'} \in \text{Im } \mathbf{m}_1$.

Two objects $c, c' \in \mathfrak{Ob}(\mathcal{C})$ are said to be *homotopy equivalent* to each other if there exists a homotopy equivalence between them.

Homotopy equivalence is an equivalence relation by [Fu7, Lemma 6.24]. \diamond

Definition 2.25. Suppose that we are in the situation of Lemma 2.23 and we assume that \mathcal{C}_2 is strict. Two strict filtered A_∞ functors $\mathcal{F}, \mathcal{G} : \mathcal{C}_1 \rightarrow \mathcal{C}_2$ are said to be *homotopy equivalent* to each other if they are homotopy equivalent as objects of $\mathcal{F}UNC(\mathcal{C}_1, \mathcal{C}_2)$ in the sense of Definition 2.24. (Note that $\mathcal{F}UNC(\mathcal{C}_1, \mathcal{C}_2)$ is strict if \mathcal{C}_2 is strict.)

The homotopy equivalence among strict filtered A_∞ functors is an equivalence relation.

We can define the notion two G -gapped strict filtered A_∞ functors to be homotopy equivalent (as G -gapped strict filtered A_∞ functors) in a similar way. \diamond

Remark 2.26. We consider the case when $\mathcal{C}_1, \mathcal{C}_2$ have only one object. In this case curved filtered A_∞ functors $\mathcal{F}, \mathcal{G} : \mathcal{C}_1 \rightarrow \mathcal{C}_2$ are nothing but filtered A_∞ homomorphisms. The notion two (curved) filtered A_∞ homomorphisms to be homotopic is defined in [FOOO1, Definition 4.2.35]. We will define its category version in

Definition 13.5. To distinguish one we defined here from one in Definition 13.5 we will use the terminology ‘homotopy equivalent’ in place of ‘homotopic’ in Definition 2.25.¹⁴ We will prove in Section 13, that ‘homotopic’ implies ‘homotopy equivalent’. (Proposition 13.13.) The converse is not correct. (Example 13.15.) \diamond

Definition 2.27. Let $\mathcal{C}_1, \mathcal{C}_2$ be strict filtered A_∞ categories. We assume that they are unital. A strict A_∞ functor $\mathcal{F} : \mathcal{C}_1 \rightarrow \mathcal{C}_2$ is said to be a *homotopy equivalence* if there exists a strict A_∞ functor $\mathcal{G} : \mathcal{C}_2 \rightarrow \mathcal{C}_1$ such that the composition $\mathcal{F} \circ \mathcal{G}$ is homotopy equivalent to the identity functor $\mathcal{I} \mathcal{D}^{\mathcal{C}_2}$ and that $\mathcal{G} \circ \mathcal{F}$ is homotopy equivalent to the identity functor $\mathcal{I} \mathcal{D}^{\mathcal{C}_1}$.

We say \mathcal{G} a *homotopy inverse* to \mathcal{F} .

Two strict A_∞ categories are said to be *homotopy equivalent* to each other if there exists a homotopy equivalence between them. \diamond

We assume that the ground ring R is a field in the next theorem.

Theorem 2.28. *Let $\mathcal{C}_1, \mathcal{C}_2$ be filtered A_∞ categories. We assume they are unital, strict and gapped. Let $\mathcal{F} : \mathcal{C}_1 \rightarrow \mathcal{C}_2$ be a strict and gapped A_∞ functor such that:*

- (1) $\mathcal{F}_1 : \mathcal{C}_1(c_1, c'_1) \rightarrow \mathcal{C}_2(\mathcal{F}_{ob}(c_1), \mathcal{F}_{ob}(c'_1))$ induces an isomorphism on \mathfrak{m}_1 homology :
- (2) For any $c_2 \in \mathfrak{Ob}(\mathcal{C}_2)$ there exists $c_1 \in \mathfrak{Ob}(\mathcal{C}_1)$ such that $\mathcal{F}_{ob}(c_1)$ is homotopy equivalent to c_2 .

Then \mathcal{F} is a homotopy equivalence.

If $\mathcal{C}_1, \mathcal{C}_2, \mathcal{F}$ are G -gapped we may take homotopy inverse which is G -gapped also. Moreover homotopy equivalence in (2) is taken to be G -gapped. \diamond

The non-filtered version of this theorem is [Fu7, Theorem 8.6]. We can prove Theorem 2.28 in the same way.

Remark 2.29. Note that we assumed strictness of \mathcal{C} here. Actually Theorem 2.28(1) does not make sense in case $\mathfrak{m}_0 \neq 0$.

In a slightly different way, we can define homotopy equivalence of filtered A_∞ categories in the curved case and Theorem 2.28 holds in that generality. See Section 13 Theorem 13.11. (We remark that the assumption (1) of Theorem 13.11 does make sense in the curved case since $\overline{\mathcal{C}}$ is strict. In the curved case we replace (2) by the condition that \mathcal{F}_{ob} is a bijection.) \diamond

2.5. A_∞ -Yoneda embedding.

Definition 2.30. ([Fu7, Definition 7.8]) Let \mathcal{C} be a non-unital curved filtered A_∞ category. We define its *opposite A_∞ category* \mathcal{C}^{op} as follows.

- (1) $\mathfrak{Ob}(\mathcal{C}^{\text{op}}) = \mathfrak{Ob}(\mathcal{C})$.
- (2) Let $c, c' \in \mathfrak{Ob}(\mathcal{C}^{\text{op}}) = \mathfrak{Ob}(\mathcal{C})$. We put $\mathcal{C}^{\text{op}}(c, c') = \mathcal{C}(c', c)$.
- (3) We define structure operations $\mathfrak{m}_k^{\text{op}}$ of \mathcal{C}^{op} by :

$$\mathfrak{m}_k^{\text{op}}(x_1, \dots, x_k) = (-1)^* \mathfrak{m}_k(x_k, \dots, x_1),$$

$$\text{where } * = \sum_{1 \leq i < j \leq k} (\deg x_i + 1)(\deg x_j + 1) + 1. \diamond$$

Lemma 2.31.

- (1) \mathcal{C}^{op} is a non-unital curved filtered A_∞ category.
- (2) If \mathcal{C} is unital (resp. strict, G -gapped) then so is \mathcal{C}^{op} .

¹⁴This notation is different from [Fu7] at this point.

◇

(1) is [Fu7, Lemma 7.10]. (2) is immediate from the definition. (Definition 2.5 (3)(a).)

Definition 2.32. Let $\mathcal{C}_1, \mathcal{C}_2$ be non-unital curved filtered A_∞ categories. For a filtered A_∞ functor $\mathcal{F} : \mathcal{C}_1 \rightarrow \mathcal{C}_2$, we can construct its *opposite A_∞ functor* $\mathcal{F}^{\text{op}} : \mathcal{C}_1^{\text{op}} \rightarrow \mathcal{C}_2^{\text{op}}$ as follows.

$$(1) \mathcal{F}_{ob}^{\text{op}} := \mathcal{F}_{ob}.$$

$$(2) \mathcal{F}_k^{\text{op}}(\mathbf{x}) := (-1)^{\epsilon(\mathbf{x})} \mathcal{F}_k(\mathbf{x}^{\text{op}}). \text{ Here we put We put}$$

$$\mathbf{x}^{\text{op}} := x_k \otimes \cdots \otimes x_1, \quad (2.15)$$

and

$$\epsilon(\mathbf{x}) := \sum_{1 \leq i < j \leq k} (\deg x_i + 1)(\deg x_j + 1). \quad (2.16)$$

It is checked in [Fu7, Definition-Lemma 7.23] that \mathcal{F}^{op} is a filtered A_∞ functor.

It is easy to see that if \mathcal{F} is unital (resp. G -gapped) then the functor \mathcal{F}^{op} is also unital (resp. G -gapped).◇

The next lemma is easy to show.

Lemma 2.33. *If $\mathcal{C}_1, \mathcal{C}_2$ are non-unital strict filtered A_∞ categories then the set theoretical map $\mathcal{F} \mapsto \mathcal{F}^{\text{op}}$ is the object part of the isomorphism*

$$\text{FUNC}(\mathcal{C}_1, \mathcal{C}_2)^{\text{op}} \cong \text{FUNC}(\mathcal{C}_1^{\text{op}}, \mathcal{C}_2^{\text{op}}) \quad (2.17)$$

The same holds in the curved case. ◇

The proof is easy and is omitted.

Definition 2.34. We define a filtered A_∞ category \mathcal{CH} as follows. $\mathfrak{Ob}(\mathcal{CH})$ is the set of (all) chain complexes of completed free Λ_0 modules.¹⁵ Let $(C, d), (C', d) \in \mathfrak{Ob}(\mathcal{CH})$. Then

$$\mathcal{CH}^k((C, d), (C', d)) = \bigoplus_{\ell} \text{Hom}_R(C^\ell, C'^{\ell+k}).$$

We define

$$\mathbf{m}_1(x) := d \circ x + (-1)^{\deg x + 1} x \circ d, \quad (2.18)$$

$$\mathbf{m}_2(x, y) := (-1)^{\deg x(\deg y + 1)} y \circ x,$$

where \circ is the composition. We put $\mathbf{m}_k = 0$ for $k \geq 3$ and $k = 0$. It is checked in [Fu7, Proposition 7.7] that \mathcal{CH} is a filtered A_∞ category. It is strict and unital.◇

Suppose \mathcal{C} is a non-unital *strict* filtered A_∞ category. We will define the following four functors.

$$\begin{aligned} \mathfrak{Yon} &: \mathcal{C} \rightarrow \text{FUNC}(\mathcal{C}^{\text{op}}, \mathcal{CH}), \\ \mathfrak{OpYon} &: \mathcal{C}^{\text{op}} \rightarrow \text{FUNC}(\mathcal{C}, \mathcal{CH}), \\ \mathfrak{Yon}^{\text{op}} &: \mathcal{C}^{\text{op}} \rightarrow \text{FUNC}(\mathcal{C}, \mathcal{CH}^{\text{op}}), \\ \mathfrak{OpYon}^{\text{op}} &: \mathcal{C} \rightarrow \text{FUNC}(\mathcal{C}^{\text{op}}, \mathcal{CH}^{\text{op}}). \end{aligned} \quad (2.19)$$

¹⁵To avoid Russell paradox in set theory, we fix a sufficiently large set (a universe) and consider only completed free Λ_0 modules contained in this set.

The object parts of them are defined by:

$$\begin{aligned} (\mathfrak{Yon}_{ob}(c)_{ob})(b) &:= \mathcal{C}(b, c), \\ (\mathfrak{DpYon}_{ob}(c))_{ob}(b) &:= \mathcal{C}(c, b), \\ (\mathfrak{Yon}_{ob}^{\text{op}}(c))_{ob}(b) &:= \mathcal{C}(b, c), \\ (\mathfrak{DpYon}_{ob}^{\text{op}}(c))_{ob}(b) &:= \mathcal{C}(c, b). \end{aligned} \tag{2.20}$$

Definition 2.35. Let \mathcal{C} be a strict filtered A_∞ category. We define a filtered A_∞ functor $\mathfrak{Yon}_{ob}(c) : \mathcal{C}^{\text{op}} \rightarrow \mathcal{CH}$ as follows.

$$\mathfrak{Yon}_{ob}(c)_{ob}(b_0) := \mathcal{C}(b_0, c).$$

Let $\mathbf{x} \in B_k \mathcal{C}^{\text{op}}(b_0, b_k) = B_k \mathcal{C}(b_k, b_0)$, $y \in \mathfrak{Yon}_0(c)_{ob}(b_0) = \mathcal{C}(c, b_0)$, $k = 1, 2, \dots$. Then

$$\mathfrak{Yon}_{ob}(c)_k(\mathbf{x})(y) := (-1)^{\epsilon(\mathbf{x})} \mathfrak{m}(\mathbf{x}^{\text{op}}, y).$$

◇

See [Fu7, Definitions 7.28], where \mathfrak{Rep} is used instead of \mathfrak{Yon} . We apply the construction of $\mathfrak{Yon}_{ob}(c)$ to the opposite filtered A_∞ category \mathcal{C}^{op} and define $\mathfrak{DpYon}_{ob}(c)$ as follows.

Definition 2.36. $\mathfrak{DpYon}_{ob}(c) : \mathcal{C}^{\text{op}} \rightarrow \mathcal{CH}$ is defined by

- (1) $\mathfrak{DpYon}_{ob}(c)(b_0) := \mathcal{C}(c, b_0)$,
- (2) $\mathfrak{DpYon}_k(\mathbf{x})(y) := -(-1)^{\text{deg}' y} \mathfrak{m}_{k+1}(y, \mathbf{x})$.

◇¹⁶

Lemma 2.37. *There exist a filtered A_∞ functors $\mathfrak{Yon} : \mathcal{C} \rightarrow \text{FUNC}(\mathcal{C}^{\text{op}}, \mathcal{CH})$ and $\mathfrak{DpYon} : \mathcal{C} \rightarrow \text{FUNC}(\mathcal{C}^{\text{op}}, \mathcal{CH}^{\text{op}})$ such that its object part is given by Definitions 2.35 and 2.36.*

The case of \mathfrak{Yon} is [Fu7, Definitions 9.6 and Lemma 9.8]. The case of \mathfrak{DpYon} is obtained by applying the case of \mathfrak{Yon} to the opposite category \mathcal{C}^{op} .

Definition 2.38. We define $\mathfrak{Yon}^{\text{op}} : \mathcal{C}^{\text{op}} \rightarrow \text{FUNC}(\mathcal{C}, \mathcal{CH}^{\text{op}})$ and $\mathfrak{DpYon}^{\text{op}} : \mathcal{C}^{\text{op}} \rightarrow \text{FUNC}(\mathcal{C}^{\text{op}}, \mathcal{CH}^{\text{op}})$ to be the opposite functors of \mathfrak{Yon} and \mathfrak{DpYon} , respectively.

Remark 2.39. The functors $\mathfrak{Yon}_{ob}^{\text{op}}(c)$ and $\mathfrak{DpYon}_{ob}^{\text{op}}(c)$ are written as \mathcal{F}^c , ${}^c\mathcal{F}$ respectively in [Fu7, Section 7].

Definition 2.40. We say strict filtered A_∞ functors $\mathcal{C} \rightarrow \mathcal{CH}^{\text{op}}$, $\mathcal{C} \rightarrow \mathcal{CH}$, $\mathcal{C}^{\text{op}} \rightarrow \mathcal{CH}$, $\mathcal{C}^{\text{op}} \rightarrow \mathcal{CH}^{\text{op}}$ are *representable* if they are homotopy equivalent to $\mathfrak{Yon}_{ob}(c)$, $\mathfrak{DpYon}_{ob}(c)$ and $\mathfrak{Yon}_{ob}^{\text{op}}(c)$, $\mathfrak{DpYon}_{ob}^{\text{op}}(c)$, for some $c \in \mathfrak{Ob}(\mathcal{C}) = \mathfrak{Ob}(\mathcal{C}^{\text{op}})$, respectively. ◇

The next lemma is easy to show.

Lemma 2.41. *The unitality and G -gapped-ness are preserved by Definitions 2.35, 2.36, 2.40.* ◇

Definition 2.42. We denote by $\mathfrak{Rep}(\mathcal{C}^{\text{op}}, \mathcal{CH})$ the full subcategory of $\text{FUNC}(\mathcal{C}^{\text{op}}, \mathcal{CH})$ such that $\mathfrak{Ob}(\mathfrak{Rep}(\mathcal{C}^{\text{op}}, \mathcal{CH}))$ is the set of all filtered representable A_∞ functors. ◇

¹⁶There are errors in [Fu7] on the corresponding statements. It is corrected here. It does not affect other parts of [Fu7] since the functor \mathfrak{DpYon} is not used in [Fu7]. It will be used in this paper.

We denote by $\mathfrak{Rep}^G(\mathcal{C}^{\text{op}}, \mathcal{CH})$ the full subcategory of $\mathcal{FUNC}(\mathcal{C}^{\text{op}}, \mathcal{CH})$ whose objects consist of the G -gapped filtered representable A_∞ functors. The filtered A_∞ category $\mathfrak{Rep}^G(\mathcal{C}^{\text{op}}, \mathcal{CH})$ is G -gapped.

We next define a filtered A_∞ functor $\mathfrak{Yon} : \mathcal{C} \cong \mathfrak{Rep}^G(\mathcal{C}^{\text{op}}, \mathcal{CH})$.

Definition 2.43. For an object c of \mathcal{C} the object $\mathfrak{Yon}_{ob}(c)$ of $\mathfrak{Rep}^G(\mathcal{C}^{\text{op}}, \mathcal{CH})$ is defined by Definition 2.35. \diamond

Theorem 2.44. *Let \mathcal{C} be a G -gapped strict and unital filtered A_∞ category. Then, there exists a homotopy equivalence of G -gapped filtered A_∞ categories $\mathfrak{Yon} : \mathcal{C} \cong \mathfrak{Rep}^G(\mathcal{C}^{\text{op}}, \mathcal{CH})$, such that $\mathfrak{Yon}_{ob}(c)$ is as in Definition 2.35. \diamond*

This is a filtered version of [Fu7, Theorem 9.1]. Using Theorem 2.28 instead of [Fu7, Theorem 8.6], the proof of Theorem 2.44 is the same as the proof of [Fu7, Theorem 9.1].

Definition 2.45. We call $\mathfrak{Yon} : \mathcal{C} \cong \mathfrak{Rep}^G(\mathcal{C}^{\text{op}}, \mathcal{CH})$ the A_∞ Yoneda functor. \diamond

Remark 2.46. In Section 2 we describe the result over Λ_0 coefficient. In most of the places we can use Λ coefficient and forget the filtration. However we then need to assume that our filtered A_∞ category is strict. So to work over Λ coefficient in our geometric application, a natural way is to proceed as follows. We first define a curved filtered A_∞ category over Λ_0 . Take its associated strict category. Change the coefficient ring from Λ_0 to Λ . This is the way taken in [AFOOO].

We call a filtered A_∞ category, Λ_0 linear if its module of morphisms are Λ_0 module and its structure equations are Λ_0 linear. An A_∞ category over Λ (resp. R) is called also to be Λ linear (resp. R linear) .

There are certain cases where it is better to work over Λ_0 . For example reduction to R works only for Λ_0 linear category. \diamond

Yoneda's lemma in the case of curved filtered A_∞ category is discussed in [DL, Section 4].

3. FLOER THEORY OF IMMERSSED LAGRANGIAN SUBMANIFOLDS: REVIEW.

This section is a review of Floer theory of immersed Lagrangian submanifolds. Our main purpose here is to provide the precise definitions of various notions we use in this paper. We also include certain discussions on orientation in the Morse-Bott case, which we use in later sections. If the reader has certain knowledge on Lagrangian Floer theory and its immersed version, the reader may skip this section and comes back when it is quoted in later sections.

The Floer theory of immersed Lagrangian submanifolds is developed by Akaho-Joyce in [AJ], generalizing the case of embedded Lagrangian submanifolds in [FOOO1, FOOO2]. Here we rewrite the story by using the de Rham model. The main reference we use on the virtual fundamental chain technique in the de Rham model is [FOOO10, FOOO11, FOOO13]. Note that [FOOO1, FOOO2, FOOO10, FOOO11, FOOO13] do not discuss the construction of filtered A_∞ -categories but focus on filtered A_∞ algebras. The reference on the category case is [AFOOO, FOOO3, Fu7].

3.1. Immersed Lagrangian submanifold. Let (X, ω) be a symplectic manifold of real dimension $2n$. We assume it is either compact or tame. We sometimes say that X is a symplectic manifold for simplicity.

Notation 3.1. For a symplectic manifolds (X, ω_X) , (Y, ω_Y) we denote $(X \times Y, \pi_1^*(\omega_X) + \pi_2^*(\omega_Y))$ by $(X, \omega_X) \times (Y, \omega_Y)$.

Sometimes we denote $(X, -\omega_X)$ by $-X$ by an abuse of notation. We also denote $(X, \omega_X) \times (Y, \omega_Y)$ by $X \times Y$ sometimes. Moreover we write $-X \times Y$ instead of $(X, -\omega_X) \times (Y, \omega_Y)$ sometimes. \diamond

Definition 3.2.

- (1) An *immersed Lagrangian submanifold* L of (X, ω) is a pair (\tilde{L}, i_L) where \tilde{L} is a smooth manifold of dimension n and i_L is a smooth map $i_L : \tilde{L} \rightarrow X$ such that its derivative $d_p i_L : T_p \tilde{L} \rightarrow T_{i_L(p)} X$ is injective and that $i_L^* \omega = 0$.
- (2) Sometimes we denote by L the image of $i_L : \tilde{L} \rightarrow X$ by an abuse of notation.
- (3) In this paper all immersed Lagrangian submanifolds are assumed to be compact and oriented unless otherwise mentioned.
- (4) We say $L = (\tilde{L}, i_L)$ has *clean self-intersection* if the following holds.

(a) The fiber product

$$\tilde{L} \times_X \tilde{L} := \{(p, q) \in \tilde{L} \times \tilde{L} \mid i_L(p) = i_L(q)\}$$

is a smooth submanifold of $\tilde{L} \times \tilde{L}$.

(b) For $(p, q) \in \tilde{L} \times_X \tilde{L}$ we have :

$$T_{(p,q)}(\tilde{L} \times_X \tilde{L}) = \{(V, W) \in T_p \tilde{L} \times T_q \tilde{L} \mid (d_p i_L)(V) = (d_q i_L)(W)\}. \quad (3.1)$$

We remark that the left hand side is automatically contained in the right hand side. The condition is that the right hand side is contained in the left hand side.

Hereafter we put

$$L(+) = \tilde{L} \times_X \tilde{L}. \quad (3.2)$$

- (5) We decompose $L(+)$ into the disjoint union of finitely many connected components as

$$L(+) = \tilde{L} \sqcup \coprod_{a \in \mathcal{A}_L} L(a), \quad (3.3)$$

where \tilde{L} is identified with the intersection of $L(+)$ and the diagonal. We say \tilde{L} the *diagonal component* of $L(+)$ and other $L(a)$'s the *switching components*. We put $\mathcal{A}_L^+ = \{o\} \cup \mathcal{A}_L$, and $L(o) = \tilde{L}$.

- (6) We say that L has *transversal self-intersection* when it has clean self-intersection and all the switching components are zero dimensional.

\diamond

Remark 3.3. We consider sometimes the case when \tilde{L} is not connected. In such a case the diagonal component is not actually a connected component. We however call it the diagonal component by an abuse of notation. \diamond

We next define the notion of a relative spin structure of an immersed Lagrangian submanifold, following [FOOO2, Definition 8.1.2].

Definition 3.4. Let L be an immersed Lagrangian submanifold which has clean self-intersection. We fix a triangulation of X such that L is a subcomplex. It induces a triangulation of \tilde{L} such that i_L sends each simplex of \tilde{L} to a simplex of X by a diffeomorphism.

A *relative spin structure* of L is the following objects.

- (1) A real and oriented vector bundle V on the 3 skeleton $X_{[3]}$ of X .
- (2) A spin structure σ of the bundle $i_L^*(V) \oplus T\tilde{L}$ on the 3 skeleton $\tilde{L}_{[3]}$ of \tilde{L} .

We call V the *background datum* of our relative spin structure. We say also σ is a *V-relative spin structure*. \diamond

Remark 3.5. Let us put $[\text{st}] = w^2(V) \in H^2(X; \mathbb{Z}_2)$. Then a spin structure σ of the bundle $i_L^*(V) \oplus T\tilde{L}$ on the 3 skeleton $\tilde{L}_{[3]}$ of \tilde{L} exists if and only if $w^2(L) = i_L^*([\text{st}])$. Sometimes $[\text{st}]$ is called the *background class*. We use V rather than $[\text{st}]$ since to define the notion of a relative spin structure it is more precise when we use it. (We may say L is $[\text{st}]$ -relatively spin if $w^2(L) = i_L^*([\text{st}])$. We need to be more precise to define the notion of a relative spin structure of L .) \diamond

Note that the notion of a relative spin structure in Definition 3.4 depends on the choice of a triangulation of X . We can however show that this notion is independent of such a choice in a similar way as [FOOO2, Proposition 8.1.6].

The immersed Lagrangian Floer theory associates a filtered A_∞ algebra to an immersed Lagrangian submanifold (which is relatively spin and has clean self-intersection). The underlying vector space of filtered A_∞ algebra is the vector space of differential forms on $\tilde{L} \times_X \tilde{L}$. (More precisely the completion of its tensor product with Λ_0 .) By the same reason as the Floer cohomology of a pair of Lagrangian submanifolds (with clean intersection), we need to use a certain principal $O(1)$ bundle, which is equivalent to a \mathbb{Z}_2 -local system, on the switching components. (It is unnecessary in the self-transversal case which was the case of [AJ].) We next discuss this point following [FOOO1, Section 3.7.5], [FOOO2, Section 8.8] and will define Θ_a^- .

Definition 3.6.

- (1) Let $L(a)$ be one of the switching components of $L(+)$. $L(a)$ is a submanifold of $(\tilde{L} \times \tilde{L}) \setminus \text{diagonal}$. We compose $L(a) \rightarrow \tilde{L} \times \tilde{L}$ with the projection to the first factor to obtain $i_{a,l} : L(a) \rightarrow \tilde{L}$. This is a smooth immersion. Using the projection to the second factor we obtain $i_{a,r} : L(a) \rightarrow \tilde{L}$.
- (2) For $x \in X$ we denote by \mathcal{LGR}_x the set of all the oriented n -dimensional subspaces V of $T_x X$ such that $\omega = 0$ on V .
 $\bigcup_{x \in X} \mathcal{LGR}_x$ is a fiber bundle over X which we write \mathcal{LGR} .

\diamond

Below we assume

$$\dim L - \dim L(a) \geq 2 \tag{3.4}$$

for switching components $L(a)$. The orientation problem of the general case can be reduced to this case by the following trick. Let $u : (\Sigma, \partial\Sigma) \rightarrow (X, L)$ be a pseudo-holomorphic map. (See Definition 3.17.) For the orientation problem it suffices to consider the case $\Sigma \subset \mathbb{C}$. When we replace X, L, u by $X \times \mathbb{C}, L \times \partial\Sigma, u \times \text{identity}$, the moduli spaces of pseudo-holomorphic maps (together with their Kuranishi structures), do not change by this process. Therefore we may assume (3.4) without loss of generality.

We take and fix a Riemannian metric on \tilde{L} . This is nothing but the reduction of the structure group of its tangent bundle to $SO(n)$.

Definition 3.7. (See [FOOO2, pages 687 and 721]) Let $x \in L(a)$.

- (1) We denote by \mathcal{P}_x^a the set of all smooth maps $\lambda_x : [0, 1] \rightarrow \mathcal{LGR}_x$ such that:

- (a) $\lambda_x(0) = (d_x i_{a,l})(T_{i_{a,l}(x)} \tilde{L})$.
 - (b) $\lambda_x(1) = (d_x i_{a,r})(T_{i_{a,r}(x)} \tilde{L})$.
 - (c) $\lambda_x(t) \supseteq (d_x i_{a,l})(T_{i_{a,l}(x)} \tilde{L}) \cap (d_x i_{a,r})(T_{i_{a,r}(x)} \tilde{L})$.
- (2) For $\lambda_x \in \mathcal{P}_x^a$ we define the space \mathbf{I}_{λ_x} as the set of all smooth maps $\sigma : [0, 1] \times \mathbb{R}^n \rightarrow TX$ such that $\sigma(t; \cdot) : \mathbb{R}^n \rightarrow T_x X$ is a linear isometry between \mathbb{R}^n and the linear subspace $\lambda_x(t)$ of $T_x X$.
- (3) Let $P_{SO}L$ be the principal $SO(n)$ bundle associated to the tangent bundle. We may identify its fiber at $p \in \tilde{L}$ with the set of all orientation preserving isometries $\mathbb{R}^n \rightarrow T_p \tilde{L}$. For $x = (p, q) \in L(a)$ we consider

$$P_x = \frac{(P_{Spin}L)_p \times (P_{Spin}L)_q}{\{-1, +1\}}.$$

Here $(P_{Spin}L)_p$ is the double cover of the fiber of $P_{SO}L$ at p and can be identified with $Spin(n)$. The denominator $\{-1, +1\}$ is the group $O(1)$ consisting of $(1, 1) \in Spin(n) \times Spin(n)$ and $(-1, -1) \in Spin(n) \times Spin(n)$.

- (4) For $x = (p, q) \in L(a)$, we define a map $\mathbf{I}_{\lambda_x} \rightarrow (P_{SO}L)_p \times (P_{SO}L)_q$ by restricting $\sigma \in \mathbf{I}_{\lambda_x}$ to $t = 0, 1$. We also have a double cover $P_x \rightarrow (P_{SO}L)_p \times (P_{SO}L)_q$. We define the space $\tilde{\mathbf{I}}_{\lambda_x}$ by the fiber product.

$$\tilde{\mathbf{I}}_{\lambda_x} = \mathbf{I}_{\lambda_x} \times_{(P_{SO}L)_p \times (P_{SO}L)_q} P_x. \quad (3.5)$$

- (5) We put

$$\mathcal{I}_x = \bigcup_{\lambda_x \in \mathcal{P}_x^a} \mathbf{I}_{\lambda_x}, \quad \tilde{\mathcal{I}}_x = \bigcup_{\lambda_x \in \mathcal{P}_x^a} \tilde{\mathbf{I}}_{\lambda_x}.$$

The projection $\mathcal{I}_x \rightarrow \mathcal{P}_x^a$ is a fiber bundle.

◇

We next want to regard $\bigcup_{x \in L(a)} \tilde{\mathcal{I}}_x$ as a fiber bundle over $L(a)_{[3]}$. We use a relative spin structure for this purpose. Let V be a real and oriented vector bundle on the 3 skeleton $X_{[3]}$. We fix a metric on it. We may assume that $L(a)_{[3]}$ is contained in $X_{[3]}$. Let $x = (p, q) \in L(a)_{[3]}$. We denote by $P_{SO}(TL \oplus V)$ the principal SO bundle on $\tilde{L}_{[3]}$ whose fiber at p is the set of linear isometries $\mathbb{R}^{n+m} \rightarrow T_p L \oplus V_y$. (Here $y = i_L(p)$.) The spin structure of $TL \oplus V$ defines a fiber-wise double cover $P_{Spin}(TL \oplus V)$ of $P_{SO}(TL \oplus V)$ on $L(a)_{[3]}$. (Note that such a double cover may not exist for $P_{SO}L$.)

We choose an orientation preserving isometry $I_y : V_y \cong \mathbb{R}^m$. It induces an embedding $(P_{SO}L)_p \rightarrow (P_{SO}(TL \oplus V))_p$. By taking a double cover we have

$$(P_{Spin}L)_p \rightarrow (P_{Spin}(TL \oplus V))_p. \quad (3.6)$$

We put

$$P_x(V) := \frac{(P_{Spin}(TL \oplus V))_p \times (P_{Spin}(TL \oplus V))_q}{\{-1, +1\}}.$$

Then it is a double cover of $(P_{SO}(TL \oplus V))_p \times (P_{SO}(TL \oplus V))_q$. By using (3.6)

$$\tilde{\mathcal{I}}_x \cong \mathcal{I}_x \times_{(P_{SO}(TL \oplus V))_p \times (P_{SO}(TL \oplus V))_q} P_x(V)$$

for $(p, q) \in L(a)_{[3]}$. Note that this identification is independent of the choice of $I_y : V_y \cong \mathbb{R}^m$. This is because we use the same identification for the first factor and the second factor of the numerator.

We remark again that we are given a spin structure of the vector bundle $T\tilde{L} \oplus i_L^* V$. Therefore the unions of $(P_{Spin}TL \oplus V)_p$ (resp. $(P_{Spin}TL \oplus V)_q$) for p (resp. q) becomes a principal bundle over $L(a)_{[3]}$. We thus obtain a fiber bundle $\tilde{\mathcal{I}} \rightarrow L(a)_{[3]}$ whose fiber at x is $\tilde{\mathcal{I}}_x$.

We remark that \mathcal{P}_x^a is homotopy equivalent to the loop space of the oriented Lagrangian Grassmannian, $\Omega\mathcal{LGR}(n-d)$, where $d = \dim L(a)$. It is well know that

$$\mathcal{LGR}(n-d) = U(n-d)/SO(n-d).$$

In fact $U(n-d)$ acts transitively to the set of all the oriented Lagrangian linear subspaces of \mathbb{C}^{n-d} and the isotropy group of this action at \mathbb{R}^{n-d} is $SO(n-d)$. Therefore we have an exact sequence

$$\begin{aligned} 1 = \pi_2(U(n-d)) &\rightarrow \pi_2(\mathcal{LGR}(n-d)) \rightarrow \pi_1(SO(n-d)) \\ &\rightarrow \pi_1(U(n-d)) \rightarrow \pi_1(\mathcal{LGR}(n-d)) \rightarrow 1. \end{aligned}$$

We assumed (3.4), that is, $n-d \geq 2$. Therefore $\pi_1(SO(n-d)) = \mathbb{Z}_2$ and $\pi_1(U(n-d)) = \mathbb{Z}$. Therefore

$$\pi_0(\Omega\mathcal{LGR}(n-d)) = \mathbb{Z}, \quad \pi_1(\Omega\mathcal{LGR}(n-d)) = \mathbb{Z}_2.$$

Moreover the map

$$\pi_1(\Omega\mathcal{LGR}(n-d)) \rightarrow \pi_1(SO(n-d))$$

is an isomorphism. It implies the next lemma.

Lemma 3.8. *The double cover $\tilde{\mathcal{I}}_x \rightarrow \mathcal{I}_x$ is nontrivial. \diamond*

Using λ_x as in Definition 3.7, we define a Fredholm operator as follows. (We follow [FOOO2, Subsection 8.1.3] here.) We put:

$$\begin{aligned} Z_- &= \{z \in \mathbb{C} \mid |z| \leq 1\} \cup \{z \in \mathbb{C} \mid \operatorname{Re} z \geq 0, |\operatorname{Im} z| \leq 1\}, \\ Z_+ &= \{-x + \sqrt{-1}y \mid x, y \in \mathbb{R}, x + \sqrt{-1}y \in Z_-\}. \end{aligned} \quad (3.7)$$

Let k be a sufficiently large integer. (For example we may take $k = 100$.) We consider the set of locally L_k^2 maps $u : Z_- \rightarrow T_x X$ (resp. $u : Z_+ \rightarrow T_x X$) with the following properties.

- (1) $u(t + \sqrt{-1}) \in (di_L)(T_{i_{a,r}(x)}\tilde{L})$ for $t \in \mathbb{R}_{\geq 0}$. (resp. $u(t + \sqrt{-1}) \in (di_L)(T_{i_{a,r}(x)}\tilde{L})$ for $t \in \mathbb{R}_{\leq 0}$.)
- (2) $u(t - \sqrt{-1}) \in (di_L)(T_{i_{a,l}(x)}\tilde{L})$ for $t \in \mathbb{R}_{\geq 0}$. (resp. $u(t - \sqrt{-1}) \in (di_L)(T_{i_{a,l}(x)}\tilde{L})$ for $t \in \mathbb{R}_{\leq 0}$.)
- (3) $u(\exp(\pi\sqrt{-1}(3/2-t))) \in \lambda_a(x, t)$. (resp. $u(\exp(\pi\sqrt{-1}(t-1/2))) \in \lambda_a(x, t)$.)
- (4)

$$\sum_{\ell=0}^k \int_W e^{\delta|\operatorname{Re} z|} \|\nabla^\ell u\|^2 dz d\bar{z} < \infty. \quad (3.8)$$

Here $\delta > 0$ is a fixed small number. See Figure 1.

We consider the totality of such maps u and use the left hand side of (3.8) as its norm. We denote it by $L_k^2(Z_-; T_x X; \lambda_a; \delta)$. (resp. $L_k^2(Z_+; T_x X; \lambda_a; \delta)$.) This is a Hilbert space. We consider the set of all the locally L_{k-1}^2 maps $u : Z_- \rightarrow T_x X$ (resp. $u : Z_+ \rightarrow T_x X$) which satisfies (3.8) with k replaced by $k-1$ and denote it by $L_{k-1}^2(Z_-; T_x X; \delta)$. (resp. $L_{k-1}^2(Z_+; T_x X; \delta)$.) (In other words we do not require (1), (2), (3) for this function space.)

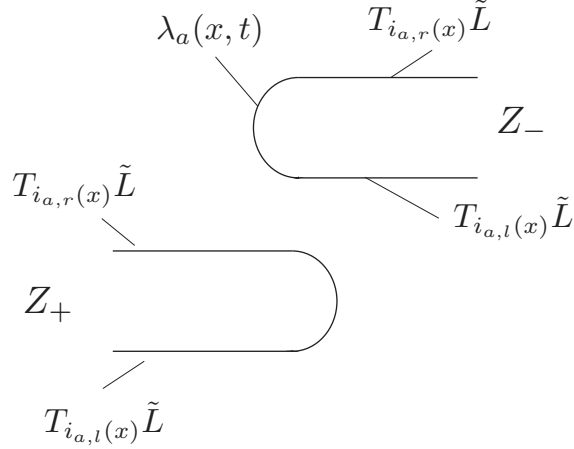
FIGURE 1. Domains Z_+ , Z_- .

We use the Cauchy-Riemann operator to define the operators $\bar{\partial}_{Z_-, \lambda_x}$, $\bar{\partial}_{Z_+, \lambda_x}$

$$\begin{aligned} \bar{\partial}_{Z_-, \lambda_x} : L_k^2(Z_-; T_x X; \lambda_a; \delta) &\rightarrow L_{k-1}^2(Z_-; T_x X; \delta), \\ \bar{\partial}_{Z_+, \lambda_x} : L_k^2(Z_+; T_x X; \lambda_a; \delta) &\rightarrow L_{k-1}^2(Z_+; T_x X; \delta). \end{aligned} \quad (3.9)$$

The next lemma is now standard.

Lemma 3.9. *The operators $\bar{\partial}_{Z_-, \lambda_x}$, $\bar{\partial}_{Z_+, \lambda_x}$ are Fredholm. \diamond*

By moving x and λ_x we obtain the family index bundles $\text{Ind}(\bar{\partial}_{Z_-, \lambda_x})$, $\text{Ind}(\bar{\partial}_{Z_+, \lambda_x})$ and their determinant real line bundles $\text{DetInd}(\bar{\partial}_{Z_-, \lambda_x})$, $\text{DetInd}(\bar{\partial}_{Z_+, \lambda_x})$. They are bundles over \mathcal{I} .

Lemma-Definition 3.10.

- (1) *The restriction of the pull back of $\text{DetInd}(\bar{\partial}_{Z_-, \lambda_x})$, $\text{DetInd}(\bar{\partial}_{Z_+, \lambda_x})$ to $\tilde{\mathcal{I}}_x$ is trivial.*
- (2) *Moreover we can define a real line bundles on $L(a)$ in a canonical way, which pulls back to $\text{DetInd}(\bar{\partial}_{Z_-, \lambda_x})$, $\text{DetInd}(\bar{\partial}_{Z_+, \lambda_x})$.*
- (3) *We denote by Θ_a^- , Θ_a^+ , the principal $O(1)$ bundles which correspond to the real line bundles on $L(a)$ in item (2).*
- (4) *There exists an isomorphism*

$$\Theta_a^- \otimes \Theta_a^+ \cong \text{Det}TL(a).$$

\diamond

Proof. This is [FOOO2, Proposition 8.8.1]. We refer [FOOO2, pages 721 and 722] for the proof of item (1).

We provide a bit more detail of the proof of item (2) than [FOOO2] here, since we use a certain part of the construction in the proof of Lemma 3.11. Recall $\pi_0(\mathcal{I}_x)$ corresponds one to one to integers k . Let $\mathcal{I}_{x, k}$ be the corresponding connected component. Its union for $x \in L(a)_{[3]}$ is denoted by \mathcal{I}_k . Its pull back to $\tilde{\mathcal{I}}$ is denoted by $\tilde{\mathcal{I}}_k$.

The double cover $\tilde{\mathcal{I}}_{x,k} \rightarrow \mathcal{I}_{x,k}$ is nontrivial by Lemma 3.8. Therefore $\pi_0(\tilde{\mathcal{I}}_{x,k}) = \pi_0(\mathcal{I}_{x,k})$ is trivial. We then have an exact sequence

$$\pi_1(\tilde{\mathcal{I}}_{x,k}) \rightarrow \pi_1(\tilde{\mathcal{I}}_k) \rightarrow \pi_1(L(a)_{[3]}) \rightarrow 1$$

Therefore $\pi_1(\tilde{\mathcal{I}}_k) \rightarrow \pi_1(L(a)_{[3]})$ is surjective. Thus item (1) implies that we can define a group homomorphism $\pi_1(L(a)_{[3]}) \rightarrow \mathbb{Z}_2$ which pulls back to the homomorphism $\pi_1(\tilde{\mathcal{I}}_k) \rightarrow \mathbb{Z}_2$ given by $\text{DetInd}(\bar{\partial}_{Z_-, \lambda_x}), \text{DetInd}(\bar{\partial}_{Z_+, \lambda_x})$. Thus we obtain real vector bundles on $L(a)_{[3]}$ which pull back to $\text{DetInd}(\bar{\partial}_{Z_-, \lambda_x})$ and $\text{DetInd}(\bar{\partial}_{Z_+, \lambda_x})$ on $\tilde{\mathcal{I}}_k$, respectively.

See the proof of [FOOO2, Proposition 8.8.1], for the proof of the fact that this line bundle is independent of k . Since any real line bundles on the 3-skeleton uniquely extend to the whole space, we obtain a real line bundles on $L(a)$.

We next discuss item (4). This is proved in [FOOO2, Subsection 8.8]. We sketch its proof below since we use a similar argument in the proof of Lemma 3.11. It suffices to show that the isomorphism for an arbitrary loop γ in $L(a)_{[3]}$. We choose a loop γ and fix a trivialization of V on γ .

We will prove the isomorphism of family indices

$$\text{Ind}(\bar{\partial}_{Z_-, \lambda_x}) \oplus \text{Ind}(\bar{\partial}_{Z_+, \lambda_x}) \oplus T_x L(a) \cong \text{Ind}(\bar{\partial}_{Z, \lambda_x^2}), \quad (3.10)$$

where the right hand side is defined as follows. We put

$$Z(R) = \{z \in \mathbb{C} \mid |z-R| \leq 1\} \cup \{z \in \mathbb{C} \mid |z+R| \leq 1\} \cup \{z \in \mathbb{C} \mid |\text{Im}z| \leq 1, |\text{Re}z| \leq R\}.$$

See Figure 2. We use λ_x on $\partial Z(R) \cap \partial\{z \in \mathbb{C} \mid |z-R| \leq 1\}$ and on $\partial Z(R) \cap \partial\{z \in \mathbb{C} \mid |z+R| \leq 1\}$ and $d_x i_{a,L}(T_{i_{a,L}(x)} \tilde{L})$ (resp. $d_x i_{a,r}(T_{i_{a,r}(x)} \tilde{L})$) on $\partial Z(R) \cap \{z \mid \text{Im}z = -1\}$ (resp. $\partial Z(R) \cap \{z \mid \text{Im}z = 1\}$) to define the boundary condition λ_x^2 on $\partial Z(R)$. We then obtain

$$\bar{\partial}_{Z(R), \lambda_x^2} : L_k^2(Z(R); T_x X; \lambda_x^2) \rightarrow L_{k-1}^2(Z(R); T_x X)$$

in the same way as $\bar{\partial}_{Z_-, \lambda_x}$. (Since $Z(R)$ is compact we do not use weighted Sobolev space but use usual Sobolev space.)

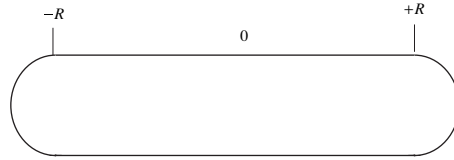

FIGURE 2. Domains $Z(R)$.

We glue two index problems $\bar{\partial}_{Z_-, \lambda_x}$ and $\bar{\partial}_{Z_+, \lambda_x}$ at their ends and the result is $\bar{\partial}_{Z(R), \lambda_x^2}$. Note that, however, there is a degeneration of the operators $\bar{\partial}_{Z_-, \lambda_x}$ and $\bar{\partial}_{Z_+, \lambda_x}$ at the end. The eigenspace of 0 of this degeneration is exactly $T_x L(a)$. (See Definition 3.6(1)(c).) Therefore the standard family index sum formula (See for example [Fu1, Theorem 4.9].) gives (3.10).

Now we consider the family of indices of $\bar{\partial}_{Z(R), \lambda_x^2}$, where we move x and λ_x^2 , and regard it as a bundle on $\tilde{\mathcal{I}}_k$. Then since we are working on $\tilde{\mathcal{I}}_k$ the boundary has a canonical spin structure as family on the boundary condition λ_x^2 . In fact, we fixed a trivialization of V . So the spin structure of $\lambda_x^2(t) \oplus V$ corresponds one to one to

the spin structure of $\lambda_x^2(t)$. Therefore the determinant line bundle of the family $\bar{\partial}_{Z(R), \lambda_x^2}$ on $\tilde{\mathcal{I}}_k$ is trivial. We thus proved item (4). \square

We use the next lemma in the later sections. We consider two V -relative spin structures σ_1 and σ_2 of L . Then the difference $\sigma_1 - \sigma_2$ is regarded as an element of $H^1(\tilde{L}; \mathbb{Z}_2)$. Using Lemma-Definition 3.10, we obtain a line bundle Θ_a^- for each of the V -relative spin structures σ_1 and σ_2 . In the next lemma we write them as Θ_{a, σ_1}^- and Θ_{a, σ_2}^- , respectively.

Lemma 3.11. ¹⁷ *The tensor product $\Theta_{a, \sigma_1}^- \otimes \Theta_{a, \sigma_2}^-$ is the principal $O(1)$ bundle corresponding to*

$$i_{a, l}^*(\sigma_1 - \sigma_2) - i_{a, r}^*(\sigma_1 - \sigma_2) \in H^1(L(a); \mathbb{Z}_2)$$

where $\sigma_1 - \sigma_2 \in H^1(\tilde{L}; \mathbb{Z}_2)$ is as above. \diamond

Proof. We consider a loop $\gamma : S^1 \rightarrow L(a)_{[3]}$ and fix a trivialization of V on γ . In the case when

$$(i_{a, l}^*(\sigma_1 - \sigma_2) - i_{a, r}^*(\sigma_1 - \sigma_2)) \cap [\gamma] = 0 \quad (3.11)$$

we will prove that $\Theta_{a, \sigma_1}^- \otimes \Theta_{a, \sigma_2}^-$ is trivial on γ . In the case when

$$(i_{a, l}^*(\sigma_1 - \sigma_2) - i_{a, r}^*(\sigma_1 - \sigma_2)) \cap [\gamma] \neq 0, \quad (3.12)$$

we will prove that $\Theta_{a, \sigma_1}^- \otimes \Theta_{a, \sigma_2}^-$ is nontrivial on γ .

Let $\tilde{\mathcal{I}}_k^{\sigma_1}$ (resp. $\tilde{\mathcal{I}}_k^{\sigma_2}$) be the space $\tilde{\mathcal{I}}_k$ we obtain as in the proof of Lemma-Definition 3.10 using relative spin structure σ_1 (resp. σ_2). As we proved during the proof of Lemma-Definition 3.10 (2) the loop γ lifts to $\tilde{\mathcal{I}}_k^{\sigma_1}$ (resp. $\tilde{\mathcal{I}}_k^{\sigma_2}$).

We take the lift $\tilde{\gamma}^{\sigma_1} : S^1 \rightarrow \tilde{\mathcal{I}}_k^{\sigma_1}$ (resp. $\tilde{\gamma}^{\sigma_2} : S^1 \rightarrow \tilde{\mathcal{I}}_k^{\sigma_2}$). We compose it with the projection to obtain $\gamma^{\sigma_1} : S^1 \rightarrow \mathcal{I}_k^{\sigma_1}$ (resp. $\gamma^{\sigma_2} : S^1 \rightarrow \mathcal{I}_k^{\sigma_2}$). (As we can show from the discussion below γ^{σ_1} is not homotopic to γ^{σ_2} if (3.12) holds.)

For each $s \in S^1$ the element $\gamma^{\sigma_1}(s)$ defines a path $\lambda_s^{\sigma_1}(\cdot) : [0, 1] \rightarrow \mathcal{LGR}_{\gamma(s)}$ satisfying Definition 3.7 (1) (a),(b),(c) for $x = \gamma(s)$. We obtain $\lambda_s^{\sigma_2}(\cdot)$ in the same way. We use them to obtain Fredholm operators $\bar{\partial}_{Z-, \lambda_s^{\sigma_1}}, \bar{\partial}_{Z+, \lambda_s^{\sigma_1}}, \bar{\partial}_{Z-, \lambda_s^{\sigma_2}}, \bar{\partial}_{Z+, \lambda_s^{\sigma_2}}$ by (3.9). It suffices to show that

$$\text{DetIndex}(\bar{\partial}_{Z-, \lambda_s^{\sigma_1}}) \otimes \text{DetIndex}(\bar{\partial}_{Z-, \lambda_s^{\sigma_2}}) \quad (3.13)$$

is a nontrivial real line bundle as a family index bundles over $S^1 = \gamma$, if and only if (3.12) holds.

By Lemma-Definition 3.10

$$\begin{aligned} & \text{DetIndex}(\bar{\partial}_{Z-, \lambda_s^{\sigma_1}}) \otimes \text{DetIndex}(\bar{\partial}_{Z+, \lambda_s^{\sigma_1}}) \\ & \cong \text{Det}TL(a) \cong \text{DetIndex}(\bar{\partial}_{Z-, \lambda_s^{\sigma_2}}) \otimes \text{DetIndex}(\bar{\partial}_{Z+, \lambda_s^{\sigma_2}}). \end{aligned}$$

Therefore (3.13) is isomorphic to

$$\text{DetIndex}(\bar{\partial}_{Z-, \lambda_s^{\sigma_1}}) \otimes \text{DetIndex}(\bar{\partial}_{Z+, \lambda_s^{\sigma_2}}) \otimes \text{Det}TL(a). \quad (3.14)$$

We define $\lambda_s^{\sigma_1, \sigma_2}(x) \subset T_x X$ for $z \in \partial Z(R)$ as follows.

We use $\lambda_s^{\sigma_1}$ on $\partial Z(R) \cap \partial\{z \in \mathbb{C} \mid |z+R| \leq 1\}$, $\lambda_s^{\sigma_2}$ on $\partial Z(R) \cap \partial\{z \in \mathbb{C} \mid |z-R| \leq 1\}$, and $d_{i_L}(T_{i_{a, l}(\gamma(s))} \tilde{L})$ (resp. $d_{i_r}(T_{i_{a, r}(\gamma(s))} \tilde{L})$) on $\partial Z(R) \cap \{z \mid \text{Im}z = -1\}$ (resp. $\partial Z(R) \cap \{z \mid \text{Im}z = 1\}$). We then obtain $\bar{\partial}_{Z(R), \lambda_s^{\sigma_1, \sigma_2}}$ in the same way as $\lambda_s^{\sigma_1, \sigma_2}$. See

¹⁷See also [FOOO7, Proposition 3.10].

FIGURE 3. Domains $Z(R)$.

Figure 3. In the same way as the proof of Lemma-Definition 3.10 (4), the bundle (3.13) is isomorphic to

$$\text{DetIndex}(\bar{\partial}_{Z(R), \lambda_s^{\sigma_1, \sigma_2}}). \quad (3.15)$$

Note that we consider the family of n -dimensional real vector spaces $\lambda_s^{\sigma_1, \sigma_2}(z)$ parametrized by $(s, z) \in S^1 \times \partial Z(R) \cong S^1 \times S^1$. (3.12) implies that this bundle has nontrivial second Stiefel-Whitney class. Therefore the example given in the proof of [FOOO2, Proposition 8.1.7] implies that the family index bundle (3.15) is nontrivial on S^1 .

(3.11) implies that the boundary condition corresponds to a trivial bundle. Therefore we can show that the family of index bundle (3.15) is trivial in this case.

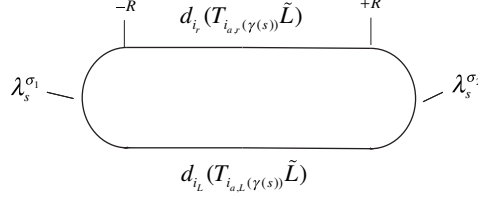
The proof of Lemma 3.11 is complete. \square

Example 3.12. Let L_0 be an embedded and spin Lagrangian submanifold of X , \tilde{L} a disjoint union of two copies of L_0 , and $i_L : \tilde{L} \rightarrow X$ the identity maps on each components. The fiber product $\tilde{L} \times_X \tilde{L}$ is disjoint union of 4 copies of L_0 , where two are diagonal components and two are switching components. We take two different spin structures σ_1 and σ_2 on L_0 and use them for the two connected components of \tilde{L} and obtain a relative spin structure.

Then Θ^- is the trivial bundle on the diagonal components and is the line bundle corresponding to $\sigma_1 - \sigma_2 \in H^1(L_0; \mathbb{Z}_2)$ on the switching components. \diamond

Let Θ be a principal $O(1)$ bundle on a manifold M . We denote by $\Omega(M; \Theta)$ the \mathbb{R} vector space of smooth differential forms on M with coefficient Θ , that is, the set of smooth sections of $\Omega^M \otimes \Theta$. Here Ω^M is the real vector bundle of differential forms on M and Θ is the real line bundle corresponding to the principal $O(1)$ bundle Θ .

Definition 3.13. Suppose $R = \mathbb{R}$ or \mathbb{C} . We put:

$$\begin{aligned} CF(L; \Lambda_0^R) &= \Omega(L(+), \Theta^-) \widehat{\otimes}_R \Lambda_0^R \\ &= (\Omega(\tilde{L}) \widehat{\otimes}_R \Lambda_0^R) \oplus \bigoplus_{a \in \mathcal{A}_L} (\Omega(L(a), \Theta_a^-) \widehat{\otimes}_R \Lambda_0^R). \end{aligned} \quad (3.16)$$

Here $\widehat{\otimes}_R$ is the T -adic completion of the algebraic tensor product.

We remark that $CF(L; \Lambda_0^R)$ is a completed free Λ_0^R module.

We also denote

$$CF(L; \mathbb{R}) = \Omega(L(+), \Theta^-) = \Omega(\tilde{L}) \oplus \bigoplus_{a \in \mathcal{A}_L} \Omega(L(a), \Theta_a^-). \quad (3.17)$$

\diamond

3.2. Moduli space of pseudo-holomorphic polygons. The purpose of this subsection is to prove the next theorem.

Theorem 3.14. *Let L be a relatively spin immersed Lagrangian submanifold of (X, ω) . We assume that L has clean self-intersection. Then we can define a structure of filtered A_∞ algebra on the completed free graded Λ_0^R module $CF(L; \Lambda_0^R)$.*

It is unital and is G -gapped for some discrete submonoid G . \diamond

Remark 3.15. Theorem 3.14 is proved by Akaho-Joyce in [AJ] except the following points. Those points are of technical nature.

- (1) We include the case of clean self-intersection. Akaho-Joyce [AJ] restrict themselves to the case of transversal self-intersection. This difference is not essential. In fact Lagrangian Floer theory in the Morse-Bott situation is fully worked out in [FOOO1]. I think [AJ] restricted themselves to the transversal case only for the sake of simplicity of notations. We include it, since we need to use the clean self-intersection case in Section 6.
- (2) We use the de Rham model to work out the transversality issue, while [AJ] used the singular homology. The author of this paper together with joint authors has completed detailed account explaining the way to use the de Rham model in the virtual fundamental chain technique after [AJ] was published. ([FOOO9], [FOOO10], [FOOO11], [FOOO13].) In his opinion using the de Rham model is the shortest way to work out the virtual fundamental chain technique in the chain level in detail and rigorously when we include Morse-Bott situation.
- (3) We prove (exact) unitality of the algebra. In fact using the de Rham model we can obtain an exact unit. (See [Fu9].) When using singular homology, we obtain a homotopy unit but it is hard to obtain an exact unit. (See [FOOO1, Section 3.3] and [FOOO2, Section 7.3].)

\diamond

Remark 3.16. The filtered A_∞ algebra $(CF(L; \Lambda_0^R), \{\mathfrak{m}_k\})$ in Theorem 3.14 depends on various choices but is independent of the choices up to homotopy equivalence. See Remark 3.43 and Section 14. (In Section 14 we will prove the case of filtered A_∞ category, which implies the case of filtered A_∞ algebra.) \diamond

The proof of Theorem 3.14 will be completed in Subsection 3.3. In this subsection, we describe the moduli spaces of pseudo-holomorphic polygons, which are used to define the structure operations \mathfrak{m}_k of our filtered A_∞ algebra.

Let L be as in Theorem 3.14 and $\vec{a} = (a_0, \dots, a_k)$, $a_i \in \mathcal{A}_L^+$. (Here \mathcal{A}_L^+ is as in Definition 3.2 (5).) We fix a compatible almost complex structure J_X on X .

Definition 3.17. Let $E \in \mathbb{R}_{\geq 0}$. We define the set $\widetilde{\mathcal{M}}(L; \vec{a}; E)$ as the totality of all the objects $(\Sigma; u; \vec{z}; \gamma)$ with the following properties.

- (1) The space Σ is a union of a disk plus a finite number of trees of sphere components attached to the interior of the disk. Σ is connected, simply connected and has at worst double points as singularities. (In particular $\partial\Sigma = S^1$.) (See Figure 4.)
- (2) The map $u : \Sigma \rightarrow X$ is J_X -holomorphic.
- (3) We put $\vec{z} = (z_0, \dots, z_k)$. Then, the points $z_i \in \partial\Sigma = S^1$ are mutually distinct. The $k+1$ tuple of points (z_0, \dots, z_k) respects the counter clockwise cyclic order of S^1 .

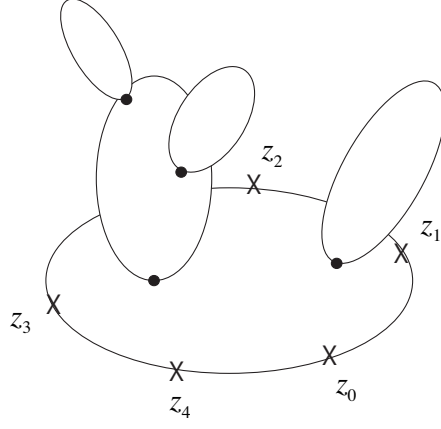
FIGURE 4. Domain Σ .

- (4) The map $\gamma : S^1 \setminus \{z_0, \dots, z_k\} \rightarrow \tilde{L}$ is smooth and satisfies

$$i_L(\gamma(z)) = u(z)$$

for $z \in S^1 \setminus \{z_0, \dots, z_k\}$.

- (5) For $i = 0, \dots, k$ we have

$$(\lim_{z \uparrow z_i} \gamma(z), \lim_{z \downarrow z_i} \gamma(z)) \in L(a_i).$$

Here $L(a_i)$ is as in (3.3). The limit in the left hand side is defined as follows. Let $x_m = e^{t_m \sqrt{-1}} \in S^1$, where t_m is an increasing sequence of real numbers converging to t with $e^{t \sqrt{-1}} = z_i$. We say $\lim_{z \uparrow z_i} \gamma(z) = y$ if $\lim_{m \rightarrow \infty} \gamma(x_m) = y$ for any such sequence x_m .

The definition of $\lim_{z \downarrow z_i} \gamma(z)$ is similar. (See Figure 5.)

- (6)

$$\int_{D^2} u^* \omega = E.$$

- (7) (Stability) The set of the maps $v : \Sigma \rightarrow \Sigma$ with the following properties is a finite set.

- (a) $u \circ v = u$.
- (b) v is biholomorphic.
- (c) $v(z_i) = z_i$.
- (d) $\gamma \circ v = \gamma$.¹⁸

We write $\text{Aut}(\Sigma; u; \vec{z}; \gamma)$ the finite group consisting of the maps v satisfying (a),(b),(c),(d) above. We call it the group of automorphisms of $(\Sigma; u; \vec{z}; \gamma)$. \diamond

Remark 3.18. Item (4) implies that γ extends continuously to z_i if $L(a_i)$ is the diagonal component and that γ does not extend continuously to z_i if $L(a_i)$ is a switching component. \diamond

¹⁸Actually this condition follows from (a).

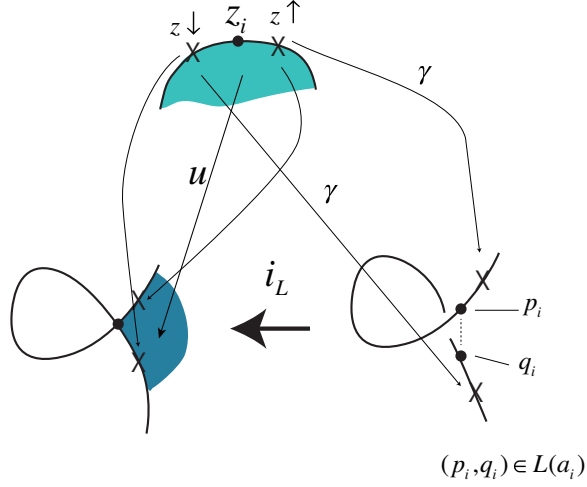
FIGURE 5. $\lim_{z \uparrow z_i} \gamma(z)$

Definition 3.19. Let $(\Sigma; u; \vec{z}; \gamma), (\Sigma'; u'; \vec{z}'; \gamma') \in \overset{\circ}{\mathcal{M}}(L; \vec{a}; E)$. We say that they are equivalent and write $(\Sigma; u; \vec{z}; \gamma) \sim (\Sigma'; u'; \vec{z}'; \gamma')$ if there exists a map $v : D^2 \rightarrow D^2$ such that:

- (1) The map v is biholomorphic.
- (2) $u = u' \circ v$.
- (3) $z'_i = v(z_i)$.
- (4) $\gamma = \gamma' \circ v$ on $\partial D^2 \setminus \{z_0, \dots, z_k\}$.

We denote by $\overset{\circ}{\mathcal{M}}(L; \vec{a}; E)$ the set of all the equivalence classes of this equivalence relation \sim .

We define *evaluation maps*

$$\text{ev} = (\text{ev}_0, \dots, \text{ev}_k) : \overset{\circ}{\mathcal{M}}(L; \vec{a}; E) \rightarrow \prod_{i=0}^k L(a_i) \quad (3.18)$$

by

$$\text{ev}_i(u; \vec{z}; \gamma) := (\lim_{z \uparrow z_i} \gamma(z), \lim_{z \downarrow z_i} \gamma(z)). \quad (3.19)$$

Here the right hand side is as in Definition 3.17 (4).

Gromov compactness implies that the set

$$G_0(L) = \{E \in \mathbb{R}_{\geq 0} \mid \exists \vec{a} \overset{\circ}{\mathcal{M}}(L; \vec{a}; E) \neq \emptyset\} \quad (3.20)$$

is discrete. We define $G(L)$ to be the monoid generated by $G_0(L)$. In other words, $G(L)$ is the set of all nonnegative numbers which are sums of finitely many elements in $G_0(L)$. The subset $G(L) \subset \mathbb{R}$ is discrete since $G_0(L)$ is discrete. \diamond

We next define a compactification of $\overset{\circ}{\mathcal{M}}(L; \vec{a}; E)$. We first describe a combinatorial or a topological structure of an element in the compactification by a tree with additional data. (This is a standard method used by various people in various related situations.)

Definition 3.20. A *stable decorated ribbon tree* with $k + 1$ exterior vertices and energy E , which we denote by $(\Gamma, E(\cdot), a(\cdot), v_0)$, is a connected tree Γ with additional data described below. Let $C_0(\Gamma)$ be the set of vertices and $C_1(\Gamma)$ the set of edges.

- (1) The set $C_0(\Gamma)$ is decomposed as $C_0(\Gamma) = C_0^{\text{int}}(\Gamma) \sqcup C_0^{\text{ext}}(\Gamma)$. We call an element of $C_0^{\text{int}}(\Gamma)$ (resp. $C_0^{\text{ext}}(\Gamma)$) an *interior vertex* (resp. an *exterior vertex*).
- (2) All the vertices in $C_0^{\text{ext}}(\Gamma)$ have exactly one edge containing it.
- (3) A ribbon structure of our tree Γ is given. In other words an embedding $\Gamma \rightarrow \mathbb{R}^2$ is given up to isotopy.
- (4) The set $C_0^{\text{ext}}(\Gamma)$ contains exactly $k + 1$ elements. The choice of 0-th vertex $v_0 \in C_0^{\text{ext}}(\Gamma)$ is given.
- (5) A map $E(\cdot) : C_0^{\text{int}}(\Gamma) \rightarrow \mathbb{R}_{\geq 0}$ is given and

$$E = \sum_{v \in C_0^{\text{int}}(\Gamma)} E(v).$$

- (6) A map $a(\cdot) : C_1(\Gamma) \rightarrow \mathcal{A}_L$ is given.
- (7) (Stability) For each $v \in C_0^{\text{int}}(\Gamma)$ one of the following holds.
 - (a) $E(v) > 0$.
 - (b) The number of edges containing v is not smaller than 3.
- (8) $E(v) \in G(L)$ for any $v \in C_0^{\text{int}}(\Gamma)$.

We denote by $\mathcal{TR}_{k+1,E}$ the set of all such $(\Gamma, E(\cdot), a(\cdot), v_0)$. We remark that we do not include the data (1)(3) in the notation $(\Gamma, E(\cdot), a(\cdot), v_0)$. However they are included as a part of the data which an element of $\mathcal{TR}_{k+1,E}$ comprises.

We remark that $\mathcal{TR}_{k+1,E} = \emptyset$ unless $E \in G(L)$.

Note that $C_0^{\text{ext}}(\Gamma)$ consists of $k + 1$ elements. We enumerate them as

$$v_0, v_1, \dots, v_k$$

so that v_0 is one determined by item (4), and the order respects the counter clockwise orientation of \mathbb{R}^2 (into which Γ is embedded by using ribbon structure). We call v_i the *i-th exterior vertex*. (See Figure 6.) \diamond

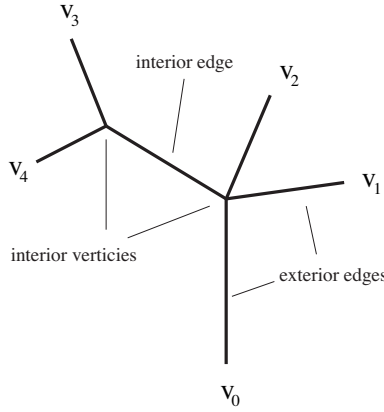

FIGURE 6. Tree Γ

Note that we have a decomposition

$$C_1(\Gamma) = C_1^{\text{int}}(\Gamma) \sqcup C_1^{\text{ext}}(\Gamma),$$

where $C_1^{\text{ext}}(\Gamma)$ is the set of $k + 1$ edges which contain one of the exterior vertices. We call an element of $C_1^{\text{ext}}(\Gamma)$ an *exterior edge* and an element of $C_1^{\text{int}}(\Gamma)$ an *interior edge*.

We next associate a fiber product of the spaces $\mathring{\mathcal{M}}(L; \vec{a}; E)$ to each element of $\mathcal{TR}_{k+1, E}$.

Definition 3.21. Let $\hat{\Gamma} = (\Gamma, E(\cdot), a(\cdot), v_0) \in \mathcal{TR}_{k+1, E}$.

Suppose $v \in C_0^{\text{int}}(\Gamma)$. There exists a unique edge $e_0(v)$ such that $e_0(v)$ lies in the same connected component as v_0 in $\Gamma \setminus v$. Thus, using the ribbon structure we enumerate the edges containing v as

$$e_0(v), e_1(v), \dots, e_{k_v}(v) \quad (3.21)$$

so that they respect the counter clockwise cyclic ordering. (See Figure 7.) We put

$$\vec{a}(v) = (a(e_0(v)), \dots, a(e_{k_v}(v))). \quad (3.22)$$

We take the direct product

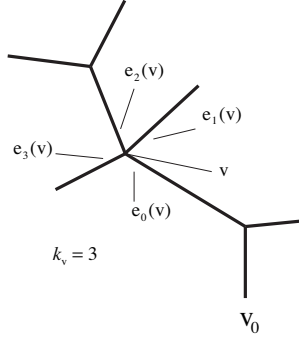

FIGURE 7. $e_i(v)$

$$\prod_{v \in C_0^{\text{int}}(\Gamma)} \mathring{\mathcal{M}}(L; \vec{a}(v); E(v)). \quad (3.23)$$

We will define a map

$$\mathcal{E}\mathcal{V} : \prod_{v \in C_0^{\text{int}}(\Gamma)} \mathring{\mathcal{M}}(L; \vec{a}(v); E(v)) \rightarrow \prod_{e \in C_1^{\text{int}}(\Gamma)} L(a(e)) \times L(a(e)) \quad (3.24)$$

as follows. Let $e \in C_1^{\text{int}}(\Gamma)$. Suppose $\partial(e) = \{v, v'\}$. If v lies in the same connected component as v_0 in $\Gamma \setminus \text{Int } e$ then we put $v_t(e) = v$. Otherwise v' lies in the same connected component as v_0 in $\Gamma \setminus \text{Int } e$. We put $v_t(e) = v'$ in the latter case.

We define $v_s(e)$ such that $\partial(e) = \{v_s(e), v_t(e)\}$. (See Figure 8.)

Now let $\vec{\mathbf{x}} = (\mathbf{x}_v : v \in C_0^{\text{int}}(\Gamma))$ be an element of (3.23). We will define

$$\mathcal{E}\mathcal{V}(\vec{\mathbf{x}}) = (\mathcal{E}\mathcal{V}_e(\vec{\mathbf{x}}) : e \in C_1^{\text{int}}(\Gamma)).$$

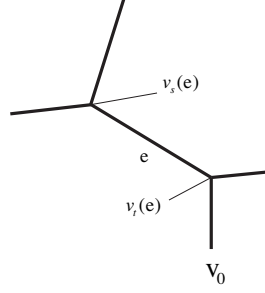
FIGURE 8. $v_s(e)$, $v_t(e)$

Here $\mathcal{E}\mathcal{V}_e(\vec{\mathbf{x}}) \in L(a(e)) \times L(a(e))$. Let $e \in C_1(\Gamma)$. Then there exists k_s and k_t such that

$$e = e_{k_s}(v_s(e)) = e_{k_t}(v_t(e)).$$

(Actually $k_s = 0$.) We define

$$\mathcal{E}\mathcal{V}_e(\vec{\mathbf{x}}) := (\text{ev}_{k_s}(\mathbf{x}_{v_s}), \text{ev}_{k_t}(\mathbf{x}_{v_t})), \quad (3.25)$$

where ev_{k_s} , ev_{k_t} are the evaluation maps (3.18).

Now we define

$$\mathring{\mathcal{M}}(L; \hat{\Gamma}) := \prod_{v \in C_0^{\text{int}}(\Gamma)} \mathring{\mathcal{M}}(L; \vec{a}(v); E(v)) \mathcal{E}\mathcal{V} \times \prod_{e \in C_1^{\text{int}}(\Gamma)} \Delta_{L(a(e))} \quad (3.26)$$

Here $\Delta_{L(a(e))} \cong L(a(e)) \subset L(a(e)) \times L(a(e))$ is the diagonal and the fiber product is taken over $\prod_{e \in C_1(\Gamma)} L(a(e)) \times L(a(e))$. See Figures 9 and 10.

Let e_i be the unique edge containing v_i . We then put

$$a_i(\hat{\Gamma}) := a(e_i), \quad \vec{a}(\hat{\Gamma}) := (a_0(\hat{\Gamma}), a_1(\hat{\Gamma}), \dots, a_k(\hat{\Gamma})). \quad (3.27)$$

We put $\mathcal{T}\mathcal{R}_{E, \vec{a}} = \{\hat{\Gamma} \in \mathcal{T}\mathcal{R}_{k+1, E} \mid \vec{a}(\hat{\Gamma}) = \vec{a}\}$ and denote

$$\mathcal{M}(L; \vec{a}; E) := \prod_{\hat{\Gamma} \in \mathcal{T}\mathcal{R}_{E, \vec{a}}} \mathring{\mathcal{M}}(L; \hat{\Gamma}). \quad (3.28)$$

Moreover we put:

$$\mathcal{M}_{k+1}(L; E) := \prod_{\vec{a} \in (\mathcal{A}_L)^{k+1}} \mathcal{M}(L; \vec{a}; E). \quad (3.29)$$

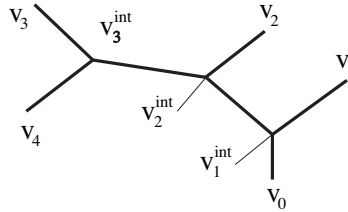
FIGURE 9. The graph Γ

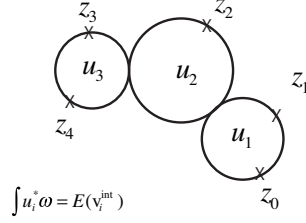
FIGURE 10. an element of $\mathring{\mathcal{M}}(L; \hat{\Gamma})$

Definition 3.22. Let $\vec{a} = (a_0, \dots, a_k) \in (\mathcal{A}_L)^{k+1}$. We put $L(\vec{a}) = L(a_0) \times \dots \times L(a_k)$. We define an *evaluation map*

$$\text{ev} = (\text{ev}_0, \dots, \text{ev}_k) : \mathcal{M}(L; \vec{a}; E) \rightarrow L(\vec{a}) \quad (3.30)$$

as follows. Let $\hat{\Gamma} \in \mathcal{T}\mathcal{R}_{E, \vec{a}}$, v_i its i -th exterior vertex and e_i the edge containing v_i . In other words e_i is the i -th exterior edge. Let v'_i be the other vertex of e_i . There exists j_i such that e_i is the j_i -th edge of v'_i . (Here we enumerate the edges of v'_i as in (3.21).) For $\vec{x} = (\mathbf{x}_v : v \in C_0^{\text{int}}(\Gamma))$ we put

$$\text{ev}_i(\vec{x}) := \text{ev}_{j_i}(\mathbf{x}_{v'_i}).$$

Using (3.30) we define

$$\mathcal{E}\mathcal{V} : \prod_{v \in C_0^{\text{int}}(\Gamma)} \mathcal{M}(L; \vec{a}(v); E(v)) \rightarrow \prod_{e \in C_1^{\text{int}}(\Gamma)} L(a(e)) \times L(a(e))$$

in the same way as (3.24). We put:

$$\mathcal{M}(L; \hat{\Gamma}) := \prod_{v \in C_0^{\text{int}}(\Gamma)} \mathcal{M}(L; \vec{a}(v); E(v)) \mathcal{E}\mathcal{V} \times \prod_{e \in C_1^{\text{int}}(\Gamma)} \Delta_{L(a(e))}. \quad (3.31)$$

This is a compactification of $\mathring{\mathcal{M}}(L; \hat{\Gamma})$. \diamond

We remark that we can also define $\mathcal{M}_{k+1}(L; E)$ or $\mathcal{M}(L; \vec{a}; E)$ as the set of the stable maps $(\Sigma, u, \vec{z}, \gamma)$ with certain properties similar to Definition 3.17, which we omit. (See [AJ, Definition 4.2].) Then we can define a stable map topology on it in the same way as [FOOO2, Definitions 7.1.39 and 7.1.42] and [FOOn, Definition 10.3]. (See also Subsection 12.2.)

Theorem 3.23. *The spaces $\mathcal{M}_{k+1}(L; E)$ and $\mathcal{M}(L; \vec{a}; E)$ are compact and Hausdorff. \diamond*

The proof is the same as the proof of [FOOn, Lemma 10.4 and Theorem 11.1], [FOOO2, Theorem 7.1.43] and is now standard.

Theorem 3.24. *The spaces $\mathcal{M}(L; \vec{a}; E)$ for various \vec{a} , E have Kuranishi structures with corners, which enjoy the following properties.*

- (1) *The codimension m normalized corner, which we denote by $S_m \mathcal{M}(L; \vec{a}; E)$, of $\mathcal{M}(L; \vec{a}; E)$ is identified with the disjoint union of $\mathcal{M}(L; \hat{\Gamma})$ where $\hat{\Gamma}$ is an element of $\mathcal{T}\mathcal{R}_{E, \vec{a}}$ such that $\#C_0^{\text{int}}(\Gamma) = m + 1$.*

- (2) The map (3.30) is the underlying continuous map of a strongly smooth map.¹⁹ Moreover ev_0 is weakly submersive.²⁰
- (3) The induced Kuranishi structure on $\mathcal{M}(L; \hat{\Gamma}) \subseteq S_m \mathcal{M}(L; \vec{a}; E)$ ²¹ is isomorphic to the fiber product Kuranishi structure (3.31).
- (4) The isomorphism in item (3) satisfies the corner compatibility conditions, Condition 3.27, below.
- (5) The Kuranishi structures are compatible with the forgetful maps of marked points corresponding to the diagonal component, in the sense of [Fu9, Definition 3.1].

◇

Remark 3.25. The notion of a normalized corner is defined in [FOOO11, FOOO13]. See also [Jo]. For example the normalized boundary of $[0, \infty)^2$ is the disjoint union of two copies of $[0, \infty)$. Note that the two elements 0 of the two copies of $[0, \infty)$ correspond to the same point $(0, 0)$ in $[0, \infty)^2$ but are different in the normalized corner (boundary). This is the point where the notion of a *normalized corner* (boundary) is different from the notion of a *corner* (boundary). See Figure 11. ◇

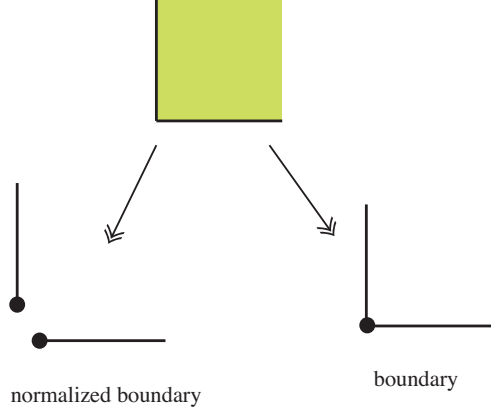

FIGURE 11. Normalized boundary

We describe the corner compatibility conditions. We need some digression and discuss graph insertion.

Definition 3.26. Let $\hat{\Gamma} = (\Gamma, E(\cdot), a(\cdot), v_0) \in \mathcal{TR}_{E, \vec{a}}$. We assume that for each $v \in C_0^{\text{int}}(\Gamma)$ we have an element $\hat{\Gamma}_v = (\Gamma_v, E_v(\cdot), a_v(\cdot), (v_v)_0) \in \mathcal{TR}_{E(v), \vec{a}(v)}$. Here $\vec{a}(v)$ is as in (3.22).

We define

$$\hat{\Gamma}^\bullet = \hat{\Gamma} \# (\hat{\Gamma}_v : v \in C_0^{\text{int}}(\Gamma)) = (\Gamma^\bullet, E^\bullet(\cdot), a^\bullet(\cdot), v_0^\bullet) \in \mathcal{TR}_{E, \vec{a}}$$

as follows.

¹⁹See [FOOO13, Definition 3.35 (4)].

²⁰See [FOOO13, Definition 3.35 (5)].

²¹See [FOOO13, Proposition 24.16].

- (1) We put the tree Γ_v at the position of the vertex v of Γ . We join i -th exterior edge of Γ_v with the i -th edge of Γ containing v . We perform this construction to all the interior vertices v of Γ . We thus obtain Γ^\bullet . (See Figure 12.)

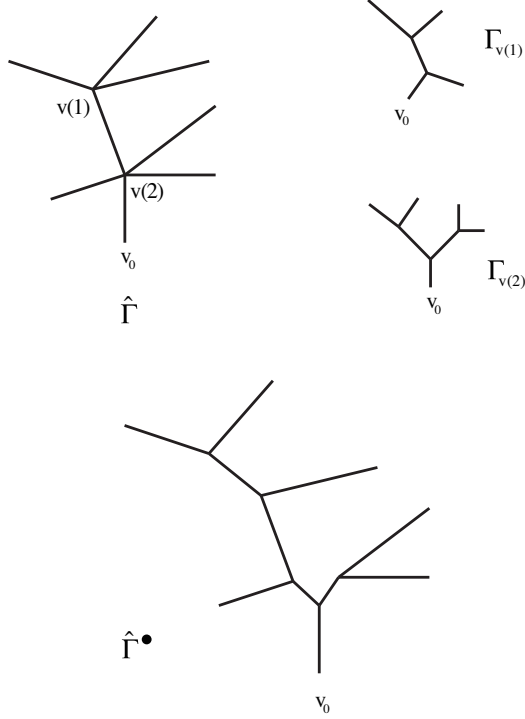
FIGURE 12. $\hat{\Gamma}^\bullet$

- (2) The decomposition $C_0(\Gamma) = C_0^{\text{int}}(\Gamma) \sqcup C_0^{\text{ext}}(\Gamma)$ induces $C_0(\Gamma^\bullet) = C_0^{\text{int}}(\Gamma^\bullet) \sqcup C_0^{\text{ext}}(\Gamma^\bullet)$ by:

$$C_0^{\text{int}}(\Gamma^\bullet) = \prod_{v \in C_0^{\text{int}}(\Gamma)} C_0^{\text{int}}(\Gamma_v). \quad (3.32)$$

- (3) In view of (3.32) $E_v(\cdot)$ and $a_v(\cdot)$ induce $E^\bullet(\cdot)$ and $a^\bullet(\cdot)$, respectively.
(4) Let e_0 be the 0-th exterior edge and v'_0 the vertex of e_0 such that $v'_0 \neq v_0$. The 0-th exterior vertex v_0^\bullet of $\hat{\Gamma}^\bullet$ is by definition the 0-th exterior vertex $(v_{v'_0})_0$ of $\hat{\Gamma}_{v'_0}$.

◇

Let $\vec{x} = (\mathbf{x}_v : v \in C_0^{\text{int}}(\Gamma^\bullet))$ be an element of $\mathcal{M}(L; \hat{\Gamma}^\bullet)$. (Here $\mathbf{x}_v \in \mathcal{M}(L; \vec{a}^\bullet(v); E^\bullet(v))$.) For $v \in C_0^{\text{int}}(\Gamma)$ we use (3.32) to obtain $\vec{x}(v)$ from \vec{x} . It is easy to see that $\vec{x}(v) \in \mathcal{M}(L; \hat{\Gamma}_v)$. Furthermore $(\mathbf{x}(v) : v \in C_0^{\text{int}}(\Gamma))$ is an element of $\mathcal{M}(L; \hat{\Gamma})$.

Suppose $\#C_0^{\text{int}}(\Gamma) = m + 1$, $\#C_0^{\text{int}}(\Gamma_v) = \ell_v + 1$ and $\ell = \sum_{v \in C_0^{\text{int}}(\Gamma)} \ell_v$. Then

$$\ell + m + 1 = \#C_0^{\text{int}}(\Gamma^\bullet).$$

Theorem 3.24 (1) then claims

$$\vec{x} \in \mathcal{M}(L; \hat{\Gamma}^\bullet) \subseteq S_{\ell+m}(\mathcal{M}(L; \vec{a}, E)), \quad (3.33)$$

$$\bar{\mathbf{x}}(\mathbf{v}) \in \mathcal{M}(L; \hat{\Gamma}_{\mathbf{v}}) \subseteq S_{\ell_{\mathbf{v}}}(\mathcal{M}(L; \bar{\mathbf{a}}_{\mathbf{v}}, E(\mathbf{v}))). \quad (3.34)$$

Note that $\mathcal{M}(L; \hat{\Gamma})$ is obtained as the fiber product of $\mathcal{M}(L; \bar{\mathbf{a}}_{\mathbf{v}}, E(\mathbf{v}))$. Therefore (3.34) implies

$$\bar{\mathbf{x}} = (\mathbf{x}(\mathbf{v}) : \mathbf{v} \in C_0^{\text{int}}(\Gamma)) \in S_{\ell}(\mathcal{M}(L; \hat{\Gamma})). \quad (3.35)$$

On the other hand, Theorem 3.24 (1) claims

$$\mathcal{M}(L; \hat{\Gamma}) \subseteq S_m(\mathcal{M}(L; \bar{\mathbf{a}}, E)). \quad (3.36)$$

Combining (3.35) and (3.36) we obtain:

$$\mathcal{M}(L; \hat{\Gamma}^{\bullet}) \subseteq S_{\ell}(S_m(\mathcal{M}(L; \bar{\mathbf{a}}, E))). \quad (3.37)$$

We have an $(\ell + m)!/\ell!m!$ fold covering map of spaces with Kuranishi structures,

$$S_{\ell}(S_m(\mathcal{M}(L; \bar{\mathbf{a}}, E))) \rightarrow S_{\ell+m}(\mathcal{M}(L; \bar{\mathbf{a}}, E)). \quad (3.38)$$

(See [FOOO11] [FOOO13, Proposition 24.16].) By restricting to $\mathcal{M}(L; \hat{\Gamma}^{\bullet}) \subseteq S_{\ell}(S_m(\mathcal{M}(L; \bar{\mathbf{a}}, E)))$ (See (3.37).) this map is a homeomorphism to its image. Now the corner compatibility condition is stated as follows.

Condition 3.27. (Corner compatibility condition) We consider two Kuranishi structures on $\mathcal{M}(L; \hat{\Gamma}^{\bullet})$. One (which we call the fiber product Kuranishi structure) is obtained as the fiber product (3.31). The other (which we call the induced Kuranishi structure) is induced from the Kuranishi structure on $\mathcal{M}(L; \bar{\mathbf{a}}, E)$ by the open inclusion (3.33). We consider two isomorphisms between them.

- (1) The isomorphism required in Theorem 3.24 (3).
- (2) Applying Theorem 3.24 (3) to each of $\hat{\Gamma}_{\mathbf{v}}$, the inclusion in (3.34) is extended to an isomorphism between the induced Kuranishi structure and the fiber product Kuranishi structure. It then induces an isomorphism between the induced Kuranishi structure and the fiber product Kuranishi structure on the space (3.37). By (3.38) (which is an isomorphism on $\mathcal{M}(L; \hat{\Gamma}^{\bullet})$) it induces an isomorphism between the induced Kuranishi structure and the fiber product Kuranishi structure on $\mathcal{M}(L; \hat{\Gamma}^{\bullet})$.

We require that the two isomorphisms (1)(2) above coincide with each other. \diamond

Remark 3.28. Condition 3.27 looks rather complicated. Actually, in our geometric situation, it is rather trivial that Condition 3.27 is satisfied. Corner compatibility conditions such as Condition 3.27 are spelled out in [FOOO11] [FOOO13, Chapters 16 and 21] for the purpose of axiomatizing the construction of a compatible system of perturbations of the compatible system of Kuranishi structures. In other words we spelled out the properties we need to construct a compatible system of perturbations in a way independent of the geometric origin of the system of Kuranishi structures. \diamond

In the case when L is an embedded Lagrangian submanifold, Theorem 3.24 is [FOOO2, Propositions 7.1.1 and 7.1.2].²² Its generalization is in [AJ] in the case when L has transversal self-intersection. In the general case we can use Morse-Bott gluing which can be worked out in the same way as [FOOO2, Section 7.1.3]. (See also [Fu4], [FOn].) In fact the analytic detail of [FOOO2, Section 7.1.3] is designed so that it works also in the Morse-Bott case in general. The detail of the

²²Note that item (4) is not stated in [FOOO2, Propositions 7.1.1 and 7.1.2]. However this compatibility is fairly obvious from the construction.

analysis to prove Theorem 3.24 is given also in [FOOO9, Parts 2 and 3] and in [FOOO12, FOOO14, FOOO15].

We next discuss the orientation. We first recall the definition of orientation local systems of spaces with Kuranishi structure. Let $\widehat{\mathcal{U}} = \{(U_p, E_p, s_p, \psi_p) \mid p \in X\}$ be a Kuranishi structure of X . (We use the definition of [FOOO10, Definition 3.8]. So it has a tangent bundle in the sense of [FOOO2, Definition A1.4].) We obtain a principal $O(1)$ bundle

$$O_p = \text{Det}TU_p \otimes \text{Det}TE_p$$

on U_p . By the condition of the coordinate change in [FOOO10, Definition 3.2 (8)], $O_q \cong \varphi_{pq}^* O_p$ and this isomorphism is compatible in the sense that the map

$$O_r \cong \varphi_{qr}^* O_q \cong \varphi_{qr}^* \varphi_{pq}^* O_p$$

coincides with

$$O_r \cong \varphi_{pr}^* O_p.$$

We call such collection of $\{O_p \mid p \in X\}$ together with isomorphisms $O_q \cong \varphi_{pq}^* O_p$ satisfying the above explained compatibility conditions, the *orientation local system* of our space with Kuranishi structure $(X, \widehat{\mathcal{U}})$ and write it as $O_{(X, \widehat{\mathcal{U}})}$. We write it also as O_X by an abuse of notation.

If we construct a compatible good coordinate system $\{(U_{\mathfrak{p}}, E_{\mathfrak{p}}, s_{\mathfrak{p}}, \psi_{\mathfrak{p}}) \mid \mathfrak{p} \in \mathfrak{P}\}$ then $\{O_p \mid p \in X\}$ induces a system of principal $O(1)$ bundles $\{O_{\mathfrak{p}} \mid \mathfrak{p} \in \mathfrak{P}\}$ which is compatible with the coordinate change in a similar sense as above. (Here $O_{\mathfrak{p}}$ is a principal $O(1)$ bundle on $U_{\mathfrak{p}}$.) We can use it to define and study integration along the fiber in a similar way as the case of manifolds. (See [FOOO10, FOOO13, Chapter 27].)

Suppose that $\mathfrak{f} = \{f_p \mid p \in X\}$ is a weakly submersive strongly smooth map $(X, \widehat{\mathcal{U}}) \rightarrow N$ to a smooth manifold N . If Θ is a principal $O(1)$ bundle on N we pull it back to each U_p to obtain $f_p^* \Theta$. They are compatible with the coordinate change in a similar sense as above. We denote the system $\{f_p^* \Theta \mid p \in X\}$ by $\mathfrak{f}^* \Theta$. We can define a tensor product of several systems in an obvious way.

An isomorphism between $\mathfrak{f}^* \Theta$ and O is a system of isomorphisms of real line bundles $f_p^* \Theta \cong O_p$ which commute with coordinate changes.

Let $\vec{a} = (a_0, \dots, a_k)$, $a_i \in \mathcal{A}_L^+$. We use the principal $O(1)$ bundles $\Theta_{a_i}^-$ and $\Theta_{a_i}^+$, which are defined in Lemma-Definition 3.10.

Proposition 3.29. *The V -relative spin structure of L canonically induces an isomorphism of principal $O(1)$ bundles*

$$O_{\mathcal{M}(L; \vec{a}; E)} \cong \bigotimes_{i=0}^k \text{ev}_i^* \Theta_{a_i}^-. \quad (3.39)$$

◇

Proof. This is a straightforward generalization of [FOOO2, Proposition 8.8.6]. We provide the proof below for completeness.

Let $\mathfrak{r} = (\Sigma; u; \vec{z}; \gamma)$ be an element of $\overset{\circ}{\mathcal{M}}(L; \vec{a}; E)$. It suffices to consider the case when $\Sigma = D^2$. We may also assume that the image of γ lies in $L_{[3]}$.

We put $\text{ev}_i(\mathfrak{r}) = (p_i, q_i) \in L(a_i)$ and $i_L(p_i) = i_L(q_i) = x_i$. We write $x_i = (p_i, q_i) \in L(a_i)$ by an abuse of notation. We fix a trivialization $V_{x_i} \cong \mathbb{R}^m$ and take an element $\lambda_{x_i} \in \mathcal{P}_{x_i}^{a_i}$ for each i . (See Definition 3.7.)

We show that those choices together with the V -relative spin structure of L determine an isomorphism of the principal $O(1)$ bundles of the left and right hand sides of (3.39) at \mathfrak{r} .

For each i we use λ_{x_i} to define an elliptic operator

$$\bar{\partial}_{Z_-, \lambda_{x_i}} : L_k^2(Z_-; T_{x_i}X; \lambda_{a_i}; \delta) \rightarrow L_{k-1}^2(Z_-; T_{x_i}X; \delta)$$

as in (3.9). We can glue it with the linearized operator of the defining equation of $\overset{\circ}{\mathcal{M}}(L; \vec{a}; E)$ at \mathfrak{r} to obtain an elliptic operator P on $\Sigma = D^2$ whose symbol is the same as one of the Cauchy-Riemann operator with u^*TX coefficient. Its boundary condition is given by concatenating the family $z \in \partial\Sigma \mapsto (di_L)(T_{\gamma(z)}\tilde{L})$ with λ_{x_i} 's. (See Figure 13.) We denote this family of Lagrangian subspaces (the boundary

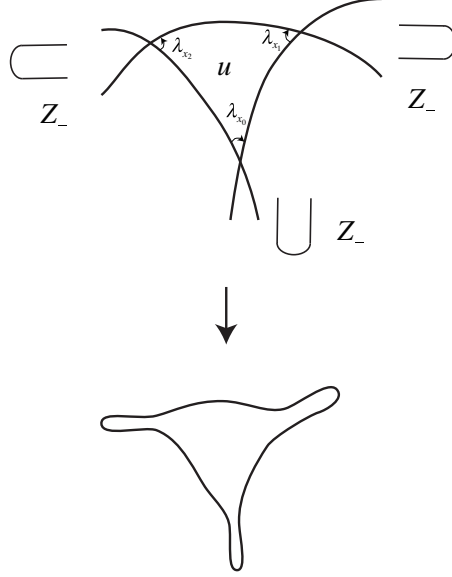

FIGURE 13. Family of Lagrangian subspaces λ

condition) by λ .

We claim there is a canonical orientation of the determinant line bundle of the index of P . We prove it below. Using the isomorphism $u^*TX \cong \mathbb{C}^n \times \Sigma$ (note that $\Sigma = D^2$), we may regard λ as an S^1 parametrized family of Lagrangian subspaces of \mathbb{C}^n . The trivialization of V and relative spin structure determine a trivialization of this family of subspaces as an abstract vector bundle. We thus have a trivial complex vector bundle $\xi_0 = \mathbb{C}^n \times \Sigma$ on $\Sigma = D^2$.

On the other hand, by an identification $\xi_{0, \mathbb{R}}|_{\partial\Sigma} = \mathbb{R}^n \times \partial\Sigma$ with λ , (which may not be consistent with the trivialization $\xi_0 = \mathbb{C}^n \times \Sigma$). This identification induces $\xi_0|_{\partial\Sigma} \cong u^*TX|_{\partial\Sigma}$. In the same way as the proof of [FOOO2, Theorem 8.1.1] we can show that the difference of the index of P and the Cauchy-Riemann operator of the bundle E with $\xi_{0, \mathbb{R}}$ boundary condition has a canonical orientation. (This is based on the fact that this difference can be identified with an index of a certain family of operators on $\mathbb{C}P^1$ with complex linear symbols.)

The index of the Cauchy-Riemann operator of the bundle E with $E_{\mathbb{R}}$ as a boundary condition is canonically identified with \mathbb{R}^n . Therefore the determinant bundle of the index bundle of P is canonically trivialized.

On the other hand, we find that

$$TU_{\mathfrak{r}} \ominus E_{\mathfrak{r}} \oplus \bigoplus_{i=0}^k \text{Index} \bar{\partial}_{Z_-, \lambda_{x_i}} \cong \text{Index} P \quad (3.40)$$

as a virtual vector space. (Here U_ξ is a Kuranishi neighborhood of ξ and E_ξ is an obstruction bundle.)

We remark (3.40) induces an isomorphism (3.39) at a point \mathfrak{r} . In fact $\text{Det Index } P$ is trivial. Therefore we obtain an isomorphism $\text{Det Index} \bar{\partial}_{Z_-, \lambda_{x_i}} \cong \Theta_{x_i}^-$ by Lemma-Definition 3.10 (3), and an isomorphism $\text{Det } TU_{\mathfrak{r}} \otimes \text{Det } E_{\mathfrak{r}}^* \cong \mathcal{O}_{\mathcal{M}(L; \vec{a}; E)}$ by definition. Thus we obtain (3.39).

We next explain the way to obtain a family of isomorphisms $V_{x_i} \cong \mathbb{R}^m$ and of λ_{x_i} and so that the above isomorphisms induce a global isomorphism (3.39).

In fact the independence of the choice of λ_{x_i} is the consequence of Lemma-Definition 3.10 (2).

Let us discuss the dependence of the identification $V_{x_i} \cong \mathbb{R}^m$. We first remark that to prove Proposition 3.29 it suffices to prove this isomorphism on each loop of the domain, since both sides are principal $O(1)$ bundles. Let $S^1 \rightarrow C^\infty((D^2, \partial D^2), (X, L))$ be a smooth map. It induces a map $(S^1 \times D^2, S^1 \times \partial D^2) \rightarrow (X, L)$. The pull back of V by this map is a trivial bundle since it is an oriented real bundle on $S^1 \times D^2$. Therefore we have a continuous family of isomorphisms $V_{x_i} \cong \mathbb{R}^m$ on this S^1 parametrized family.

The proof of Proposition 3.29 is complete. \square

3.3. The filtered A_∞ algebra associated to an immersed Lagrangian submanifold. We now use Theorem 3.24 to prove Theorem 3.14. We refer [FOOO10, FOOO13, Definition 9.1] for the definition of CF-perturbations on Kuranishi structures.

Proposition 3.30. *Let $E_0 > 0$. Then there exists a system of CF-perturbations $\widehat{\mathfrak{S}}$ on the moduli spaces $\mathcal{M}(L; \vec{a}; E)$ with Kuranishi structures which are outer collarings²³ of thickenings of the structures given in Theorem 3.24, for various \vec{a} , E with $E < E_0$. It enjoys the following properties. (See [FOOO10, FOOO13, Definition 5.3] for the definition of a thickening.)*

- (1) *Each of $\widehat{\mathfrak{S}}$ is transversal to zero.*
- (2) *The evaluation map ev_0 is strongly submersive with respect to this CF-perturbation. (See [FOOO10, FOOO13, Definition 9.2] for the definition of strong submersivity.)*
- (3) *They are compatible at the corners in the following sense. We consider the left hand side $\mathcal{M}(L; \widehat{\Gamma})$ of (3.31) and require that the following two CF-perturbations on it coincide each other.*
 - (a) *The space $\mathcal{M}(L; \widehat{\Gamma})$ is a stratum of $\mathcal{M}(L; \vec{a}; E)$ with respect to its corner structure stratification. (See [FOOO10, FOOO13, Definition*

²³See [FOOO13, Chapter 17] for the definition of an outer collaring (it was called τ -collaring in [FOOO11]).

4.15] for the definition of the corner structure stratification.) We restrict CF-perturbation $\widehat{\mathfrak{S}}$ on $\mathcal{M}(L; \vec{a}; E)$ to $\mathcal{M}(L; \widehat{\Gamma})$ and obtain a CF-perturbation on it.

(b) The right hand side of (3.31) is a fiber product of various connected components of $\mathcal{M}(L; \vec{a}; E)$. We take the restriction of $\widehat{\mathfrak{S}}$ to the moduli spaces appearing as the fiber product factors of the right hand side of (3.31) and take the fiber product CF-perturbation, in the sense of [FOOO10, FOOO13, Definition 10.13]. Since ev_0 is strongly submersive we can take the fiber product CF-perturbation. ([FOOO10, FOOO13, Lemma-Definition 10.12]).

(4) They are compatible with the forgetful map of the marked points which correspond to the diagonal component other than 0-th one. The precise definition of compatibility is written in [Fu9, Definition 5.1].

◇

Proof. The proof is mostly the same as the proof of [Fu9, Section 5], [FOOO10], [FOOO13, Chapter 12] and [FOOO11], [FOOO13, Chapter 17]. We explain only the points where the discussion is slightly different.

We first observe that it suffices to define a CF-perturbation of the space $\mathcal{M}(L; \vec{a}; E)$ such that a_i is not the diagonal component for $i \neq 0$. In fact then the CF-perturbation in the general case is automatically determined by item (4).

We then remark the following.

Lemma 3.31. *There exists k_0 (depending on E_0) such that the following holds. Let $\vec{a} = (a_0, \dots, a_k)$. Suppose $\mathcal{M}(L; \vec{a}; E) \neq \emptyset$, a_i is not the diagonal component for $i \neq 0$, and $E < E_0$ then $k \leq k_0$.* ◇

Proof. This is a direct consequence of Gromov compactness. □

Thus we need to construct CF-perturbations on only finitely many spaces with Kuranishi structures.

The rest of the proof is the same as [Fu9, Section 5], [FOOO10, FOOO11, FOOO13]. The construction is by induction on E . Suppose we have constructed CF-perturbations with the required properties for $\mathcal{M}(L; \vec{a}; E)$ with $E < E_1 < E_0$. We will construct one for $\mathcal{M}(L; \vec{a}; E_1)$. By the induction hypothesis Proposition 3.30 (3), the boundary and corners of $\mathcal{M}(L; \vec{a}; E_1)$ are fiber products of the moduli spaces for which CF-perturbations are already defined by the induction hypothesis. We take the fiber product of those CF-perturbations to obtain CF-perturbations of the boundary and corners of $\mathcal{M}(L; \vec{a}; E_1)$ that are compatible with each other. Therefore, by using the relative version of the existence theorem of CF-perturbations (See [FOOO11, Proposition 17.65 or 15.7] or [FOOO13, Proposition 17.81 or 15.7]), we can extend it to $\mathcal{M}(L; \vec{a}; E_1)$. The proof is now complete by induction. □

We use the CF-perturbations obtained in Proposition 3.30 to define the structure operations of our filtered A_∞ structure.

Definition 3.32.

(1) Let $E < E_0$, $E \in G(L)$. For $(E, k) \neq (0, 1)$ we define multi-linear maps

$$\mathfrak{m}_k^{E, \epsilon} : CF(L; \mathbb{R})^{\otimes k} \rightarrow CF(L; \mathbb{R})$$

by

$$\mathbf{m}_k^{E,\epsilon}(h_1, \dots, h_k) := (-1)^* \text{ev}_0!(\text{ev}_1^* h_1 \times \dots \times \text{ev}_k^* h_k; \widehat{\mathfrak{S}}^\epsilon). \quad (3.41)$$

Here $CF(L; \mathbb{R}) = \Omega(L; \Theta^-)$. (See Definition 3.13 (3.16).) Note that $h_1, \dots, h_k \in CF(L; \mathbb{R})$ and $\text{ev}_i^* h_i$ are the pull backs of differential forms with respect to the strongly smooth map ev_i . (See [FOOO10, FOOO13, Definition 7.70].) $\text{ev}_0!(*; \widehat{\mathcal{U}}^\epsilon)$ is the integration along the fiber of the differential form with respect to the CF-perturbation. (See [FOOO10, FOOO13, Definition 9.13]). It depends on a positive number ϵ . (See Remark 3.33 below.) Here we consider the moduli spaces $\mathcal{M}(L; \vec{a}; E)$ and their Kuranishi structures and the CF-perturbations obtained in Theorem 3.24 and Proposition 3.30 to define them.

The sign $*$ in (3.41) is $*$ = $\sum_{i=1}^k i(\deg h_i + 1) + 1$ when we take the convention of [FOOO13, Page 552]. (The same correction term also appears in [ST, Subsubsection 2.2.2].) (However in this paper we do not use this particular formula of $*$ as we will mention in Remark 17.2.)

We remark that by Lemma 3.34 below the right hand side of (3.41) is an element of $CF(L; \mathbb{R})$.

We also define

$$\mathbf{m}_1^0(h) := dh. \quad (3.42)$$

There is no sign when we use the convention of [FOOO13, Definition 21.29 (4)].

(2) We define

$$\mathbf{m}_k^{<E_0, \epsilon} : CF(L; \Lambda_0)^{\otimes k} \rightarrow CF(L; \Lambda_0)$$

by

$$\mathbf{m}_k^{<E_0, \epsilon} := \sum_{E < E_0, E \in G(L)} T^E \mathbf{m}_k^{E, \epsilon}. \quad (3.43)$$

◇

Remark 3.33. Here ϵ is a sufficiently small positive number. It is proved in [FOOO10], [FOOO13, Theorem 9.15] that the integration along the fiber $\text{ev}_0!(\dots; \widehat{\mathfrak{S}}^\epsilon)$ is independent of various choices such as partition of unity, if ϵ is sufficiently small. (The integration along the fiber depends on ϵ and the CF-perturbation.) How much ϵ should be small for this well-defined-ness to hold is also CF-perturbation dependent. Note that, however, for a fixed E_0 , we have only finitely many moduli spaces to perturb. Therefore we can take ϵ_0 , which is E_0 dependent, so that the integration along the fiber is well-defined if $\epsilon < \epsilon_0$ for those finitely many moduli spaces and their CF-perturbations. ◇

Lemma 3.34. *The right hand side of (3.41) is an element of $CF(L; \mathbb{R})$.* ◇

Proof. Note that we may decompose $\mathbf{m}_k^{E, \epsilon}$ to the sum

$$\mathbf{m}_k^{E, \epsilon} = \sum_{\vec{a}} \mathbf{m}_{\vec{a}}^{E, \epsilon} \quad (3.44)$$

where $\mathbf{m}_{\vec{a}}^{E, \epsilon}$ is defined by $\mathcal{M}(L; \vec{a}; E)$.

We may assume $h_i \in \Omega(L(a_i); \Theta_{a_i}^-)$. Then $\mathbf{m}_{\vec{a}}^{E, \epsilon}(h_1, \dots, h_k)$ is nonzero for $\vec{a} = (a_0, a_1, \dots, a_k)$ with $a_0 \in \mathcal{A}(L)$. We consider the following two cases separately.

Case 1: $L(a_0)$ is a switching component.

We define an involution $\tau : \tilde{L} \times_X \tilde{L} \rightarrow \tilde{L} \times_X \tilde{L}$ by $\tau(p, q) = (q, p)$. We take $a'_0 \in \mathcal{A}(L)$ such that $\tau(L(a_0)) = L(a'_0)$. By definition it is easy to see that $\tau^*(\Theta_{a'_0}^-) = \Theta_{a_0}^+$. Therefore by Lemma-Definition 3.10 we have

$$\tau^*(\Theta_{a'_0}^-) = \Theta_{a_0}^- \otimes \text{Det } TL(a_0). \quad (3.45)$$

Proposition 3.29 implies that for $h_0 \in \Omega(L(a_0); \Theta_{a_0}^-)$ we can define the integration

$$\int_{(\mathcal{M}(L; \vec{a}; E), \widehat{\mathfrak{S}}^\epsilon)} \text{ev}_1^* h_1 \times \cdots \times \text{ev}_k^* h_k \times \text{ev}_0^* h_0 \in \mathbb{R}.$$

In other words we may regard

$$\mathbf{m}_{\vec{a}}^{E, \epsilon}(h_1, \dots, h_k) \in \Omega(L(a_0); \Theta_{a_0}^- \otimes \text{Det } TL(a_0)).$$

Therefore by (3.45) we may regard:

$$\mathbf{m}_{\vec{a}}^{E, \epsilon}(h_1, \dots, h_k) \in \Omega(L(a'_0); \Theta_{a'_0}^-), \quad (3.46)$$

as required.

Case 2: $L(a_0)$ is the diagonal component.

In this case $L(a_0) \cong \tilde{L}$ is oriented. By definition $a'_0 = a_0$. Moreover $\Theta_{a_0}^-$ and $\Theta_{a_0}^+$ are both trivial bundles. We can prove (3.46) easily in this case, by using Proposition 3.29. \square

Proposition 3.35. $\mathbf{m}_k^{<E_0, \epsilon}$, $k = 0, 1, \dots$, defines a filtered A_∞ structure modulo T^{E_0} . Namely we have

$$0 \equiv \sum_{k_1+k_2=k+1} \sum_{i=0}^{k_1-1} (-1)^{*i} \mathbf{m}_{k_1}^{<E_0, \epsilon}(x_1, \dots, x_i, \mathbf{m}_{k_2}^{<E_0, \epsilon}(x_{i+1}, \dots, x_{i+k_2}), \dots, x_k) \quad \text{mod } T^{E_0} \quad (3.47)$$

for sufficiently small $\epsilon > 0$. Here $*i = \text{deg}' x_1 + \cdots + \text{deg}' x_i$.

Moreover $1 = [L(a_0)] \in CF(L(a_0), \mathbb{R})$ (the differential form (function) 1 on the diagonal component) is a unit. \diamond

Proof. The proof is now a routine using Proposition 3.30, Stokes' formula [FOOO10, FOOO13, Proposition 9.26] and the composition formula [FOOO10, FOOO13, Theorem 10.20] and proceed as follows.

It suffices to show

$$\sum_{E_1+E_2=E} \sum_{k_1+k_2=k+1} \sum_{i=1, \dots, k_1} (-1)^* \mathbf{m}_{k_1}^{E_1, \epsilon}(h_1, \dots, \mathbf{m}_{k_2}^{E_2, \epsilon}(h_{i+1}, \dots, h_{i+k_2}), \dots, h_k) = 0, \quad (3.48)$$

with $* = \text{deg}' h_1 + \cdots + \text{deg}' h_i$. We denote by $\text{ev}_0!(*; (\mathcal{M}, \widehat{\mathfrak{S}}^\epsilon))$ the integration along the fiber of the differential form defined by a CF-perturbation $\widehat{\mathfrak{S}}^\epsilon$ of the space \mathcal{M} with Kuranishi structure. Now by Stokes' theorem ([FOOO10, FOOO13, Proposition 9.26]) and the definition we have

$$\begin{aligned} (d \circ \mathbf{m}_{\vec{a}}^{E, \epsilon})(h_1, \dots, h_k) + \sum_{i=1}^k (-1)^* \mathbf{m}_{\vec{a}}^{E, \epsilon}(h_1, \dots, dh_i, \dots, h_k) \\ = \text{ev}_0!(\text{ev}_1^* h_1 \times \cdots \times \text{ev}_k^* h_k; (\partial \mathcal{M}(L; \vec{a}; E), \widehat{\mathfrak{S}}^\epsilon)) \end{aligned} \quad (3.49)$$

Here $*$ = $\deg' h_1 + \dots + \deg' h_{i-1} + 1$. Let $b \in \mathcal{A}(L)$ and $1 \leq i \leq j \leq k$. We define

$$\vec{a}(b, i, j, 1) := (a_0, \dots, a_i, b, a_{j+1}, \dots, a_k), \quad \vec{a}(b, i, j, 2) := (b, a_{i+1}, \dots, a_j).$$

Then by Theorem 3.24 (3) we have

$$\begin{aligned} & \partial \mathcal{M}(L; \vec{a}; E) \\ &= \coprod_{\substack{b, i, j \\ E_1 + E_2 = E, (*)}} \mathcal{M}(L; \vec{a}(b, i, j, 2); E_2)_{\text{ev}_0} \times_{\text{ev}_{i+1}} \mathcal{M}(L; \vec{a}(b, i, j, 1); E_1). \end{aligned} \quad (3.50)$$

Here the Condition $(*)$ in the notation of direct sum is

- (*1) $E_1 = 0$ and $(a_0, \dots, a_i, b, a_{j+1}, \dots, a_k) = (b, b)$ does not hold.
- (*2) $E_2 = 0$ and $(b, a_{i+1}, \dots, a_j) = (b, b)$ does not hold.

See Figure 14.

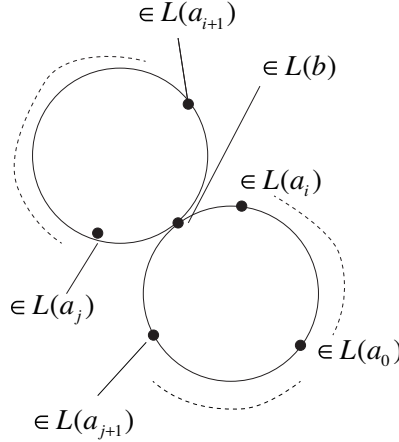

FIGURE 14. Boundary of $\mathcal{M}(L; \vec{a}; E)$

By Proposition 3.30 (3) our CF-perturbations are compatible with the isomorphism (3.50). Therefore, by the composition formula ([FOOO10, FOOO13, Theorem 10.20]), the right hand side of (3.49) is equal to the sum

$$\begin{aligned} & \sum_{\substack{b, i, j \\ E_1 + E_2 = E, E_1, E_2 > 0}} \text{ev}_0!(\text{ev}_1^* h_1 \times \dots \\ & \quad \times \text{ev}_{i+1}^* \text{ev}_0!(\text{ev}_1^* h_{i+1} \times \dots \text{ev}_{j-i}^* h_j); (\mathcal{M}(L; \vec{a}(b, i, j, 2); E_2), \widehat{\mathfrak{S}}^\epsilon)) \\ & \quad \times \text{ev}_{i+2}^* h_{j+1} \times \dots \text{ev}_{j-i}^* h_k; (\mathcal{M}(L; \vec{a}(b, i, j, 1); E_1), \widehat{\mathfrak{S}}^\epsilon)). \end{aligned}$$

By definition this sum is (3.65) minus left hand side of (3.49) up to sign. This proves (3.65) up to sign. See [FOOO1, Chapter 8] and [FOOO13] for the sign in the case of an embedded Lagrangian submanifold L . In the case L is immersed and has transversal self-intersection see [AJ]. The way to generalize them to the case of an immersed Lagrangian submanifold which has clean self-intersection is explained in Subsection 17.6 and in Appendix written by Kaoru Ono.

The unitality is a consequence of Proposition 3.30 (4). \square

Note that one of the reasons why we stop our construction at $E = E_0$ is the running out problem, which is explained in detail in [FOOO2, Subsection 7.2.3]. (See also [Fu9, Section 14], [FOOO11], [FOOO13].)

The other reason why we need to fix E_0 and stop the construction at $E = E_0$ appears in Remark 3.33. The well-defined-ness of the integration along the fiber (as well as Stokes' theorem and the composition formula) holds only for $\epsilon < \epsilon_0$, where ϵ is the parameter of our CF-perturbation, and ϵ_0 is dependent on moduli spaces (spaces with Kuranishi structures) which we work with.²⁴ As far as we consider the construction up to energy E_0 and $k < k_0$ (k is the number of input), we need to use only a finite number of moduli spaces so we can take the same ϵ_0 for all of them.

On the other hand, the CF-perturbation we obtain this way is actually E_0 dependent.

Note that we require the compatibility of CF-perturbations with forgetful maps of the marked points corresponding to the diagonal component. Therefore we only need finiteness of the number of input which does not correspond to the diagonal component. The number of such inputs can be estimated by the energy because of Lemma 3.31.

Even though we need to stop at $E = E_0$ and so can define only a filtered A_∞ structure modulo T^{E_0} , we can still use it to define a filtered A_∞ structure as follows. The method is the same as [FOOO2, Section 7.2], [Fu9, Section 14] and [FOOO11], [FOOO13]. (Our discussion here is slightly sketchy since it is the same as the papers quoted above. More detail is given in [AFOOO]).

We define:

Definition 3.36. ([Fu9, Definition 8.5]) We consider $t \in [0, 1]$ dependent families of operations

$$\mathfrak{m}_k^t : CF(L; \Lambda_0)^{\otimes k} \rightarrow CF(L; \Lambda_0), \quad \mathfrak{c}_k^t : CF(L; \Lambda_0)^{\otimes k} \rightarrow CF(L; \Lambda_0)$$

which are $G(L)$ -gapped. We say $(\{\mathfrak{m}_k^t\}, \{\mathfrak{c}_k^t\})$ is a *pseudo-isotopy* modulo T^E of G -gapped filtered A_∞ algebra structures modulo T^E on $CF(L)$ between $\{\mathfrak{m}_k^0\}$ and $\{\mathfrak{m}_k^1\}$ if the following holds:

- (1) The operations \mathfrak{m}_k^t and \mathfrak{c}_k^t are continuous in C^∞ topology. The map which sends t to \mathfrak{m}_k^t or \mathfrak{c}_k^t is smooth. Here we use operator topology with respect to the C^∞ topology for \mathfrak{m}_k^t or \mathfrak{c}_k^t to define this smoothness.
- (2) For each (but fixed) t , the set of operators $\{\mathfrak{m}_k^t\}$ defines a G -gapped filtered A_∞ algebra structures modulo T^E on $CF(L; \Lambda_0)$.

²⁴It might be possible to see carefully the moduli space itself and obtain a certain estimate of this number. However to include such explicit estimate to the whole story of virtual fundamental chain (such as CF-perturbation and de Rham theory) is rather cumbersome and so to use only the fact that there exists such ϵ_0 for each individual moduli space seems to be a better choice.

(3) For each $h_i \in CF(L; \Lambda_0)$

$$\begin{aligned}
& \frac{d}{dt} \mathbf{m}_k^t(h_1, \dots, h_k) \\
& + \sum_{k_1+k_2=k+1} \sum_{i=1}^{k-k_2+1} (-1)^* \mathbf{c}_{k_1}^t(h_1, \dots, \mathbf{m}_{k_2}^t(h_i, \dots), \dots, h_k) \\
& - \sum_{k_1+k_2=k+1} \sum_{i=1}^{k-k_2+1} \mathbf{m}_{k_1}^t(h_1, \dots, \mathbf{c}_{k_2}^t(h_i, \dots), \dots, h_k) \\
& \equiv 0 \pmod{T^E}.
\end{aligned} \tag{3.51}$$

Here $*$ = $\deg' h_1 + \dots + \deg' h_{i-1}$.

(4) $\mathbf{c}_k^t \equiv 0 \pmod{\Lambda_+}$.

◇

We put $G(L) = \{E_0, E_1, \dots, E_k, \dots\}$ with $0 = E_0 < E_1 < E_2 < \dots$. By Proposition 3.35 we obtain $\{\mathbf{m}_k^{<E_i, \epsilon}\}$ which defines a $G(L)$ -gapped filtered A_∞ algebra modulo E_i for each $i = 1, 2, \dots$.

We may regard $\{\mathbf{m}_k^{<E_{i+1}, \epsilon}\}$ as a $G(L)$ gapped filtered A_∞ algebra modulo E_i by forgetting the terms involving $T^{E_{i+1}}$. We write it $\{\mathbf{m}_k^{<E_{i+1}, \epsilon}|_{E_i}\}$.

Proposition 3.37. *There exists ϵ_i such that if $\epsilon < \epsilon_i$ then there exists $(\{\mathbf{m}_k^{t, i, \epsilon}\}, \{\mathbf{c}_k^{t, i, \epsilon}\})$ which is a pseudo-isotopy modulo T^{E_i} of $G(L)$ -gapped filtered A_∞ algebra structures modulo T^{E_i} on $CF(L)$ between $\{\mathbf{m}_k^{<E_i, \epsilon}\}$ and $\{\mathbf{m}_k^{<E_{i+1}, \epsilon}|_{E_i}\}$ ◇*

Proof. We remark that both $\{\mathbf{m}_k^{<E_i, \epsilon}\}$ and $\{\mathbf{m}_k^{<E_{i+1}, \epsilon}|_{E_i}\}$ are defined as in Definition 3.32. The only difference is we use different CF-perturbations to define them. We use homotopy between those two different CF-perturbations. We consider Kuranishi structures on $\mathcal{M}(L; \vec{a}; E) \times [0, 1]$ which is a direct product with one on $\mathcal{M}(L; \vec{a}; E)$ given in Theorem 3.24 and the trivial Kuranishi structure on $[0, 1]$.

Lemma 3.38. *There exists a system of CF-perturbations $\widehat{\mathfrak{S}}_{\text{para}}$ of outer collarings of thickenings of $\mathcal{M}(L; \vec{a}; E) \times [0, 1]$ for various \vec{a} and $E < E_1$ with the following properties.*

- (1) *Each of $\widehat{\mathfrak{S}}_{\text{para}}$ is transversal to zero.*
- (2) *$\text{ev}_0 \times \pi : \mathcal{M}(L; \vec{a}; E) \times [0, 1] \rightarrow L \times [0, 1]$ is strongly submersive with respect to this CF-perturbation.*
- (3) *They are compatible in a similar sense as Proposition 3.30 (3).*
- (4) *Its restriction to $\mathcal{M}(L; \vec{a}; E) \times \{0\}$ coincides with the CF-perturbation we used to define $\{\mathbf{m}_k^{<E_i, \epsilon}\}$. Its restriction to $\mathcal{M}(L; \vec{a}; E) \times \{1\}$ coincides with the CF-perturbation we used to define $\{\mathbf{m}_k^{<E_{i+1}, \epsilon}|_{E_i}\}$.*
- (5) *They are compatible with the forgetful maps of the marked points which corresponds to the diagonal component other than 0-th one. The precise definition of compatibility is written in [Fu9, Definition 5.1].*

◇

See [FOOO11, Section 21], [FOOO13, Chapter 21] for the precise meaning of the compatibility in item (3). The proof of Lemma 3.38 is mostly the same as Proposition 3.30 and is omitted. See [FOOO11, Section 21], [FOOO13, Chapter 21].

Remark 3.39. Note that $\mathbf{m}_k^{<E_i, \epsilon}$ is *different* from $\mathbf{m}_k^{<E_{i+1}, \epsilon}|_{E_i}$ even for sufficiently small ϵ . One of the reasons why it is difficult to take them to be the same is explained in [FOOO1, Subsection 7.2.3]. Another reason appears in Remark 3.33. It is an opinion of the author that it is safer (if not inevitable) to use “homotopy inductive limit” than working out infinitely many moduli spaces simultaneously and check that we can take the same ϵ independent of them.

Remark 3.40. We mention thickenings and outer collarings in Lemma 3.38. This is the way to construct a CF-perturbation with appropriate properties taken in [FOOO11, FOOO13]. As far as applications concern, a CF-perturbation constructed on an outer collaring of a thickening of the original Kuranishi structure can be used in the same way as a CF-perturbation constructed on the original Kuranishi structure. (See [FOOO11, FOOO13] for its reason.) \diamond

Now we put

$$\begin{aligned} & \mathbf{m}_{E,k}^{i,t,\epsilon}(h_1, \dots, h_k) + \mathbf{c}_{E,k}^{i,t,\epsilon}(h_1, \dots, h_k) \wedge dt \\ & := (\text{ev}_0 \times \pi)! (\text{ev}_1^* h_1 \times \dots \times \text{ev}_k^* h_k; \widehat{\mathfrak{S}}_{\text{para}}^\epsilon). \end{aligned} \quad (3.52)$$

Here we use the space $\mathcal{M}(L; \vec{a}; E) \times [0, 1]$ with a Kuranishi structure and its CF-perturbation to define the right hand side. The variable t is the coordinate of $[0, 1]$. Note that $\mathbf{m}_{E,k}^{i,t,\epsilon}(h_1, \dots, h_k)$ and $\mathbf{c}_{E,k}^{i,t,\epsilon}(h_1, \dots, h_k)$ are t -parametrized families of elements of $CF(L; \mathbb{R})$ which may be regarded as smooth forms on $\tilde{L} \times_X \tilde{L} \times [0, 1]$ that do not contain dt . (See [FOOO13, Section 22.4] and [ST, Subsection 4.1] for the sign.) We put

$$\mathbf{m}_k^{i,t,\epsilon} := \sum_{E < E_i} T^E \mathbf{m}_{E,k}^{i,t,\epsilon}, \quad \mathbf{c}_k^{i,t,\epsilon} := \sum_{E < E_i} T^E \mathbf{c}_{E,k}^{i,t,\epsilon}.$$

Using Lemma 3.38 in place of Proposition 3.30 we can apply Stokes’ formula and the composition formula in the same way as the proof of Proposition 3.35 and obtain (3.51). \square

Proposition 3.41. *There exists a positive number ϵ_i such that if $\epsilon, \epsilon' < \epsilon_i$ then there exists $(\{\mathbf{m}_k^{i,t,i,\epsilon}\}, \{\mathbf{c}_k^{i,t,i,\epsilon}\})$ which is a pseudo-isotopy modulo T^{E_i} of $G(L)$ -gapped filtered A_∞ algebra structures modulo T^{E_i} on $CF(L)$ between $\{\mathbf{m}_k^{<E_i, \epsilon}\}$ and $\{\mathbf{m}_k^{<E_i, \epsilon'}\}$. \diamond*

The proof is the same as the proof of Proposition 3.37 and so is omitted.

We also use the next algebraic result.

Lemma 3.42. *Let $E < E'$ and $\{\mathbf{m}_k^0\}$ (resp. $\{\mathbf{m}_k^1\}$) be G -gapped filtered A_∞ algebra modulo T^E (resp. $T^{E'}$) on $C(L; \Lambda_0)$. We regard $\{\mathbf{m}_k^1\}$ as a G -gapped filtered A_∞ algebra modulo T^E and denote it by $\{\mathbf{m}_k^1|_{T^E}\}$. Let $\{\mathbf{c}_k^t\}$ be a pseudo-isotopy modulo T^E of G -gapped filtered A_∞ algebra between $\{\mathbf{m}_k^0\}$ and $\{\mathbf{m}_k^1|_{T^E}\}$.*

Then there exists $\{\mathbf{m}_k^{0,+}\}$ and $\{\mathbf{c}_k^{t,+}\}$ such that:

- (1) $\{\mathbf{m}_k^{0,+}\}$ is a G -gapped filtered A_∞ algebra modulo $T^{E'}$.
- (2) If we regard $\{\mathbf{m}_k^{0,+}\}$ as a G -gapped filtered A_∞ algebra modulo T^E then it coincides with $\{\mathbf{m}_k^0\}$.
- (3) $(\{\mathbf{m}_k^{t,+}\}, \{\mathbf{c}_k^{t,+}\})$ is a pseudo-isotopy modulo $T^{E'}$ of G -gapped filtered A_∞ algebras between $\{\mathbf{m}_k^{0,+}\}$ and $\{\mathbf{m}_k^1\}$.

- (4) If we regard $\{\mathfrak{c}_k^{t,+}\}$ as a pseudo-isotopy modulo T^E of G -gapped filtered A_∞ algebras then it coincides with $\{\mathfrak{c}_k^t\}$.

◇

Proof. We may assume $G(L) \cap [E, E'] = \{E'\}$. We put $\{\mathfrak{c}_k^{t,+}\} := \{\mathfrak{c}_k^t\}$. Then we can solve differential equation (3.51) to obtain a coefficient of $T^{E'}$ of $\{\mathfrak{m}_k^{0+}\}$. See [FOOO2, Section 7-1], [Fu9, Section 14] and [FOOO11, FOOO13] for the proof of a similar but more difficult result. \square

We take ϵ_i which is smaller than the constants in Propositions 3.37 and 3.41. Then we use Propositions 3.37 and 3.41 and Lemma 3.42 inductively to find $\{\mathfrak{m}_k^{<E_i, j, \epsilon_i}\}$, $\{\mathfrak{m}_k^{<E_i, j, \epsilon_{i+1}}\}$, $(\{\mathfrak{m}_k^{t, i, j, \epsilon}\}, \{\mathfrak{c}_k^{t, i, j, \epsilon}\})$ ($\{\mathfrak{m}_k^{t, i, j, \epsilon}\}, \{\mathfrak{c}_k^{t, i, j, \epsilon}\}$) for $j > i$ with the following properties.

- (1) The operators $\{\mathfrak{m}_k^{<E_i, j, \epsilon_i}\}$, $\{\mathfrak{m}_k^{<E_i, j, \epsilon_{i+1}}\}$ define structures of $G(L)$ gapped filtered A_∞ algebras modulo T^{E_j} on $CF(L; \Lambda_0)$.
- (2) The pair $(\{\mathfrak{m}_k^{t, i, j, \epsilon}\}, \{\mathfrak{c}_k^{t, i, j, \epsilon}\})$ is a pseudo-isotopy modulo T^{E_j} of G -gapped filtered A_∞ algebras between $\{\mathfrak{m}_k^{<E_i, j, \epsilon_{i+1}}\}$ and $\{\mathfrak{m}_k^{<E_{i+1}, j, \epsilon_{i+1}}\}$.
- (3) The pair $(\{\mathfrak{m}_k^{t, i, j, \epsilon}\}, \{\mathfrak{c}_k^{t, i, j, \epsilon}\})$ is a pseudo-isotopy modulo T^{E_j} of G -gapped filtered A_∞ algebras between $\{\mathfrak{m}_k^{<E_i, j, \epsilon_i}\}$ and $\{\mathfrak{m}_k^{<E_i, j, \epsilon_{i+1}}\}$.
- (4) If $j' < j$ then the structures $\{\mathfrak{m}_k^{<E_i, j, \epsilon_i}\}$, $\{\mathfrak{m}_k^{<E_i, j, \epsilon_{i+1}}\}$, $(\{\mathfrak{m}_k^{t, i, j, \epsilon}\}, \{\mathfrak{c}_k^{t, i, j, \epsilon}\})$ ($\{\mathfrak{m}_k^{t, i, j, \epsilon}\}, \{\mathfrak{c}_k^{t, i, j, \epsilon}\}$) coincide with the structures $\{\mathfrak{m}_k^{<E_i, j', \epsilon_i}\}$, $\{\mathfrak{m}_k^{<E_i, j', \epsilon_{i+1}}\}$, $(\{\mathfrak{m}_k^{t, i, j', \epsilon}\}, \{\mathfrak{c}_k^{t, i, j', \epsilon}\})$ ($\{\mathfrak{m}_k^{t, i, j', \epsilon}\}, \{\mathfrak{c}_k^{t, i, j', \epsilon}\}$) as filtered A_∞ structures modulo $T^{E_{j'}}$ or as pseudo-isotopies modulo $T^{E_{j'}}$.
- (5) If $j = i$ then $\{\mathfrak{m}_k^{<E_i, i, \epsilon_i}\}$, $\{\mathfrak{m}_k^{<E_i, i, \epsilon_{i+1}}\}$, $(\{\mathfrak{m}_k^{t, i, i, \epsilon}\}, \{\mathfrak{c}_k^{t, i, i, \epsilon}\})$ ($\{\mathfrak{m}_k^{t, i, i, \epsilon}\}, \{\mathfrak{c}_k^{t, i, i, \epsilon}\}$) coincide with $\{\mathfrak{m}_k^{<E_i, i, \epsilon_i}\}$, $\{\mathfrak{m}_k^{<E_i, i, \epsilon_{i+1}}\}$, $(\{\mathfrak{m}_k^{t, i, i, \epsilon}\}, \{\mathfrak{c}_k^{t, i, i, \epsilon}\})$ ($\{\mathfrak{m}_k^{t, i, i, \epsilon}\}, \{\mathfrak{c}_k^{t, i, i, \epsilon}\}$), respectively. (Note that $(\{\mathfrak{m}_k^{t, i, i, \epsilon}\}, \{\mathfrak{c}_k^{t, i, i, \epsilon}\})$ is obtained by Proposition 3.37 and $(\{\mathfrak{m}_k^{t, i, i, \epsilon}\}, \{\mathfrak{c}_k^{t, i, i, \epsilon}\})$ is obtained by Proposition 3.41.

Now we put

$$\mathfrak{m}_k = \lim_{j \rightarrow \infty} \mathfrak{m}_k^{<E_i, j, \epsilon_i}$$

Note that the right hand side converges in T adic topology by item (4). This is the required filtered A_∞ structure. The proof of Theorem 3.14 is now complete. \square

Remark 3.43. The filtered A_∞ structure obtained by Theorem 3.14 is independent of the choices up to pseudo-isotopy. We can prove it as follows. We can prove that for each E_i the structure $\{\mathfrak{m}_k^{<E_i, j, \epsilon_i}\}$ is independent of the choices up to pseudo-isotopy modulo T^{E_i} in the same way as Proposition 3.37. We can next show that this pseudo-isotopy modulo T^{E_i} is independent of the choices up to pseudo-isotopy of pseudo-isotopies modulo T^{E_i} . We can use it in the same way as above to show the required independence of the filtered A_∞ structure up to pseudo-isotopy. See [FOOO11, FOOO13, Section 21.3]. We will discuss this point more in Section 14.

◇

Remark 3.44. Let h_1, h_2 be differential forms on a connected component $L(a)$ of $\tilde{L} \times_X \tilde{L}$. We can choose $\mathfrak{m}_{2, \beta_0}$ so that

$$\mathfrak{m}_{2, \beta_0}(h_1, h_2) = (-1)^{\deg h_1} h_1 \wedge h_2. \quad (3.53)$$

(Here we use the sign convention of [FOOO13, Definition 21.29 (5)].) In fact the right hand side is induced by the moduli space of constant maps to $L(a)$ with three marked points. This moduli space is transversal and we do *not* perturb it.

To define $\mathbf{m}_{k,\beta_0}(h_1, h_2)$ for $k \geq 3$ we use the moduli space of constant maps to $L(a)$ with more than three marked points, which may be obstructed. Such a moduli space may be nonempty after perturbation. In the situation when $L(a)$ is 0 dimensional (which was the situation of [AJ]), except the case of $\dim L = 1$ this moduli space has negative dimension and so we may assume \mathbf{m}_{k,β_0} for $k \geq 3$ to be zero. \diamond

3.4. Filtered A_∞ categories of immersed Lagrangian Floer theory.

Situation 3.45. Let (X, ω) be a symplectic manifold which is compact or convex at infinity. We take V a real oriented vector bundle on the 3-skeleton $X_{[3]}$. We consider a finite set

$$\mathbb{L} = \{(L_c, \sigma_c) \mid c \in \mathfrak{D}\}$$

of pairs $\mathcal{L}_c = (L_c, \sigma_c)$ of immersed Lagrangian submanifolds L_c and their V -relatively spin structure σ_c . We assume the next two conditions:

- (1) The self-intersection of each L_c is clean.
- (2) The submanifold L_c has clean intersection with $L_{c'}$ for any $c, c' \in \mathfrak{D}$.

We call such \mathbb{L} a *clean collection of V -relatively spin immersed Lagrangian submanifolds*. \diamond

The purpose of this subsection is to associate a filtered A_∞ category $\mathfrak{Fuk}((X, \omega); V; \mathbb{L})$ to a clean collection \mathbb{L} of V -relatively spin immersed Lagrangian submanifolds. The actual work to carry out for this purpose is in fact completed in the last subsection and we only need to rephrase the outcome of the last subsection.

Let $L_c = (\tilde{L}_c, i_{L_c})$, where $i_{L_c} : \tilde{L}_c \rightarrow X$ is a Lagrangian immersion. We consider the disjoint union

$$\tilde{L} = \bigcup_{c \in \mathfrak{D}} \tilde{L}_c.$$

and use i_{L_a} to obtain a Lagrangian immersion $i_L : \tilde{L} \rightarrow X$. We put $L = (\tilde{L}, i_L)$ and apply Theorem 3.14. For $c, c' \in \mathfrak{D}$, we decompose $\tilde{L}_c \times_X \tilde{L}_{c'}$ to connected components as

$$\tilde{L}_c \times_X \tilde{L}_{c'} = \begin{cases} \bigcup_{a \in \mathcal{A}_{c,c'}} L_{c,c'}(a) & \text{if } c \neq c' \\ \tilde{L}_c \cup \bigcup_{a \in \mathcal{A}_{c,c'}} \tilde{L}_{c,c'}(a) & \text{if } c = c'. \end{cases} \quad (3.54)$$

We then put

$$L(+)= \tilde{L} \times_X \tilde{L} = \bigcup_{c \in \mathfrak{D}} \tilde{L}_c \cup \bigcup_{\substack{c, c' \in \mathfrak{D} \\ a \in \mathcal{A}_{c,c'}}} L_{c,c'}(a). \quad (3.55)$$

By Lemma-Definition 3.10, we obtain a principal $O(1)$ bundle (\mathbb{Z}_2 local system) Θ^- on $\tilde{L} \times_X \tilde{L}$. We denote its restriction to $L_{c,c'}(a)$ by $\Theta_{c,c';a}^-$. We also remark that Θ^- is a trivial bundle on the diagonal component.

According to Definition 3.13 we have

$$CF(L) = \bigoplus_{c \in \mathfrak{D}} \Omega(\tilde{L}_c) \widehat{\otimes} \Lambda_0 \oplus \bigoplus_{\substack{c, c' \in \mathfrak{D} \\ a \in \mathcal{A}_{c,c'}}} \Omega(L_{c,c'}(a); \Theta_{c,c';a}^-) \widehat{\otimes} \Lambda_0. \quad (3.56)$$

Definition 3.46.

- (1) The set of objects $\mathfrak{D}\mathfrak{B}(\mathfrak{F}\mathfrak{u}\mathfrak{k}((X, \omega); V; \mathbb{L}))$ consists of the pairs (L_c, σ_c) for $c \in \mathfrak{D}$.
- (2) If $c, c' \in \mathfrak{D}$ with $c \neq c'$ then the module of morphisms from (L_c, σ_c) to $(L_{c'}, \sigma_{c'})$, which we denote by $\mathfrak{F}\mathfrak{u}\mathfrak{k}((X, \omega); V; \mathbb{L})((L_c, \sigma_c), (L_{c'}, \sigma_{c'}))$, is

$$\bigoplus_{a \in \mathcal{A}_{c,c'}} \Omega(L_{c,c'}(a); \Theta_{c,c';a}^-) \widehat{\otimes} \Lambda_0.$$

- (3) In case $c = c'$, the module of morphisms from (L_c, σ_c) to (L_c, σ_c) , which we denote by $\mathfrak{F}\mathfrak{u}\mathfrak{k}((X, \omega); V; \mathbb{L})((L_c, \sigma_c), (L_c, \sigma_c))$ is

$$\Omega(\widetilde{L}_c) \widehat{\otimes} \Lambda_0 \oplus \bigoplus_{a \in \mathcal{A}_{c,c}} \Omega(L_{c,c}(a); \Theta_{c,c;a}^-) \widehat{\otimes} \Lambda_0.$$

Hereafter we write $CF((L_c, \sigma_c), (L_{c'}, \sigma_{c'}))$ in place of $\mathfrak{F}\mathfrak{u}\mathfrak{k}((X, \omega); V; \mathbb{L})((L_c, \sigma_c), (L_{c'}, \sigma_{c'}))$.
 \diamond

In Theorem 3.14 we obtained the structure operation of our filtered A_∞ algebra $(\Omega(\widetilde{L}_c), \{\mathfrak{m}_k\})$ where

$$\mathfrak{m}_k : CF(L)^{\otimes k} \rightarrow CF(L). \quad (3.57)$$

Definition 3.47. Let $c_0, \dots, c_k \in \mathfrak{D}$ and (L_{c_i}, σ_{c_i}) , $i = 0, \dots, k$ be corresponding objects. We define the structure operations

$$\mathfrak{m}_k : \bigotimes_{i=1}^k CF((L_{c_{i-1}}, \sigma_{c_{i-1}}), (L_{c_i}, \sigma_{c_i})) \rightarrow CF((L_{c_0}, \sigma_{c_0}), (L_{c_k}, \sigma_{c_k})) \quad (3.58)$$

as the corresponding component of (3.57).
 \diamond

Remark 3.48.

- (1) In Definition 2.2 (2.4) we required that the map \mathfrak{m}_0 of filtered A_∞ category is

$$\mathfrak{m}_0 : \Lambda_0 \rightarrow CF((L_c, \sigma_c), (L_{c'}, \sigma_{c'}))$$

and is nonzero only when $c = c'$. We can check that our structure morphism is zero in case $k = 0$ and $c_0 \neq c_1$ as follows.

By definition \mathfrak{m}_0 is defined by using the moduli space of pseudo-holomorphic disks with one boundary marked point. It consists of (Σ, z_0, u, γ) where Σ is bordered Riemann surface with one boundary component and of genus 0, $z_0 \in \partial\Sigma$, $u : (\Sigma, \partial\Sigma) \rightarrow (X, L)$ and $\gamma : \partial\Sigma \setminus \{z_0\} \rightarrow \widetilde{L}$. We require $u = i \circ \gamma$ on $\partial\Sigma \setminus \{z_0\}$. (See Definition 3.17 (4).) Since $\partial\Sigma \setminus \{z_0\}$ is connected the image of γ is contained in one of the connected components of \widetilde{L} , say \widetilde{L}_c . In that case ev of this element goes to $\widetilde{L}_c \times_X \widetilde{L}_{c'}$. So $\mathfrak{m}_0(1)$ is contained in the subspace mentioned above.

- (2) It is also clear from the definition that the structure operation \mathfrak{m}_k of L is decomposed as (3.58). Namely the $CF((L_{c_0}, \sigma_{c_0}), (L_{c_k}, \sigma_{c_k}))$ component of $\mathfrak{m}_k(x_1, \dots, x_k)$ depends only on the component of $CF(L)^{\otimes k}$ such that $x_1 \in CF((L_{c_0}, \sigma_{c_0}), (L_{c_1}, \sigma_{c_1}))$, $x_i \in CF((L_{c_{i-1}}, \sigma_{c_{i-1}}), (L_{c_i}, \sigma_{c_i}))$ and $x_k \in CF((L_{c_{k-1}}, \sigma_{c_{k-1}}), (L_{c_k}, \sigma_{c_k}))$ for some c_1, \dots, c_{k-1} .

\diamond

Theorem 3.49. *Definitions 3.46 and 3.47 define a curved filtered A_∞ category. $1 \in \Omega(\widetilde{L}_c)$ becomes its unity.*
 \diamond

Proof. This is immediate from Theorem 3.14 and Definition 2.2. \square

Definition 3.50. Let \mathcal{C} be a filtered A_∞ category and c its object. Then $\mathcal{C}(c, c)$ together with restrictions of structure operations define a structure of a filtered A_∞ algebra. Let c, c' be two objects. The restriction of structure operations define a map

$$\mathfrak{n} : B\mathcal{C}(c, c)[1] \otimes \mathcal{C}(c, c') \otimes B\mathcal{C}(c', c')[1] \rightarrow \mathcal{C}(c, c'), \quad (3.59)$$

where $\mathcal{C}(c, c')$ is the space of morphisms and is a completed free Λ_0 module. We denote the restriction of \mathfrak{n} to $B_k\mathcal{C}(c, c)[1] \otimes \mathcal{C}(c, c') \otimes B_\ell\mathcal{C}(c', c')[1]$ by $\mathfrak{n}_{k,\ell}$, $k, \ell = 0, 1, 2, \dots$. They define a structure of filtered A_∞ bi-module on $\mathcal{C}(c, c')$ over $\mathcal{C}(c, c) \otimes \mathcal{C}(c', c')$ in the sense of [FOOO1, Definition 3.75]. (See also Subsection 5.1.) \diamond

In the case of a filtered A_∞ category, $\mathcal{C}(c, c)$ is nothing but the filtered A_∞ algebra associated to a single (immersed) Lagrangian submanifold (L_c, σ_c) . Moreover $\mathcal{C}(c, c')$ is nothing but the filtered A_∞ bi-module associated to a pair of (immersed) Lagrangian submanifolds $(L_c, \sigma_c), (L_{c'}, \sigma_{c'})$. Thus Theorem 3.49 reproduces many of the constructions in [FOOO1]. However by this trick to include the immersed case to reduce the construction of a filtered A_∞ category to one of a filtered A_∞ algebra, one aspect which we mention below is lost. Let $\varphi : X \rightarrow X$ be a Hamiltonian diffeomorphism. As we is proved in [FOOO1, Theorem 4.1.5] we have an homotopy equivalence

$$CF((L_c, \sigma_c), (L_{c'}, \sigma_{c'})) \otimes_{\Lambda_0} \Lambda \cong CF((L_c, \sigma_c), (\varphi(L_{c'}), \varphi(\sigma_{c'}))) \otimes_{\Lambda_0} \Lambda \quad (3.60)$$

of filtered A_∞ bi-module, in the case when L_c and $L_{c'}$ are embedded. See Section 15 Theorem 15.5 for the immersed case. (The proof of Theorem 15.5 is actually the same as the embedded case.) Note that here we move $L_{c'}$ by φ but do not move L_c . It is difficult to see what is the corresponding construction in the case of a single immersed Lagrangian submanifold other than the obvious one. Namely we move various connected components by different Hamiltonian diffeomorphisms. However it is rather hard to see in which sense filtered A_∞ algebra $CF(L)$ of an immersed Lagrangian submanifold (with many components) is invariant.²⁵ One big reason for it is in (3.60) we have to use Λ coefficient rather than Λ_0 coefficient. We will discuss related issue in Section 15 more. Note that (3.60) is the most important property of Lagrangian Floer homology for applications. In fact the motivation of Floer to define Lagrangian Floer homology is to study intersection of a pair of Lagrangian submanifolds and the most important property of Floer homology for that purpose is (3.60).

The invariance of Floer homology (of Λ coefficient) of a pair under the Hamiltonian diffeomorphisms in the sense of [FOOO1, Theorem 4.1.5] will be discussed in Subsection 15.5 in a slightly more sophisticated form.

Remark 3.51. In this subsection and in this paper, we take and fix a finite set of Lagrangian submanifolds and define our category by using those finitely many Lagrangian submanifolds only. It is more canonical to use all the Lagrangian submanifolds and construct a single big filtered A_∞ category. We do not try to do so in this paper since for the purpose of most of the applications choosing an appropriate finite set of Lagrangian submanifolds and using only those Lagrangian submanifolds are good enough and since it is simpler to write the detail in the case

²⁵Provably the unobstructed (immersed) Lagrangian cobordism is the correct formulation to work with. See [BC].

when we work on a finite set of Lagrangian submanifolds. See Subsection 18.1 for more discussion on this point. \diamond

3.5. Opposite A_∞ category and $\omega \mapsto -\omega$. In this subsection we explain how the A_∞ category $\mathfrak{Fut}((X, \omega); V; \mathbb{L})$ behaves when we replace the symplectic form ω by $-\omega$. We use this relationship when we study Lagrangian correspondences.

Let $\mathbb{L} = \{(L_c, \sigma_c) \mid c \in \mathfrak{D}\}$ be a clean collection of V -relatively spin immersed Lagrangian submanifolds as in Situation 3.45.

Lemma 3.52. *We can regard \mathbb{L} as a clean collection of V -relatively spin immersed Lagrangian submanifolds of $(X, -\omega)$.* \diamond

The proof is obvious.

Lemma 3.53. *There exists $V \oplus TX$ -relatively spin structure σ'_c of L_c such that $\mathbb{L}' = \{(L_c, \sigma'_c) \mid c \in \mathfrak{D}\}$ is a clean collection of $V \oplus TX$ -relatively spin immersed Lagrangian submanifolds of (X, ω) .* \diamond

Proof. We remark that $TX|_L = TL \oplus TL$. Therefore the lemma follows from the well known fact that for any oriented real vector bundle W there exists a canonical spin structure on the bundle $W \oplus W$. \square

From now on we frequently identify the set \mathbb{L} and \mathbb{L}' . Now the main result of this subsection is the following.

Theorem 3.54. *We may take the various choices made in the definitions so that we have the next isomorphism of filtered A_∞ categories:*

$$\mathfrak{Fut}((X, \omega); V; \mathbb{L}) \cong \mathfrak{Fut}((X, -\omega); V \oplus TX; \mathbb{L}')^{\text{op}}. \quad (3.61)$$

\diamond

Remark 3.55. See also [WW5, Remark 5.3.3]. \diamond

Proof. The proof is similar to the proof of [FOOO7, Theorem 1.3]. It is obvious that the set of objects and the modules of morphisms are the same. We can show that the local system Θ_- we use to define module of morphisms does not change when we replace background datum V by $V \oplus TX$. This is because $TX|_L$ is spin and its spin structure is canonical. We need to study a certain sign issue which will be discussed during the proof of Lemma 3.56 below.

Thus it remains to check that the structure operations coincide with each other. By the argument of Subsection 3.4 it suffices to consider the case when \mathbb{L} consists of a single V -relatively spin immersed Lagrangian submanifold (L, σ) .

We consider the moduli space $\overset{\circ}{\mathcal{M}}(L; \vec{a}; E)$ in Definition 3.17. To specify the almost complex structure and the symplectic form we denote this moduli space as $\overset{\circ}{\mathcal{M}}((X, \omega, J_X); L; \vec{a}; E)$. For $\vec{a} = (a_0, \dots, a_k)$, we put $\vec{a}^{\text{op}} = (a_k, \dots, a_0)$ and define a map

$$I : \overset{\circ}{\mathcal{M}}((X, \omega, J_X); L; \vec{a}; E) \rightarrow \overset{\circ}{\mathcal{M}}((X, -\omega, -J_X); L; \vec{a}^{\text{op}}; E)$$

as follows. Let $(\Sigma; u; \vec{z}; \gamma) \in \overset{\circ}{\mathcal{M}}((X, \omega, J_X); L; \vec{a}; E)$. For simplicity we assume $\Sigma = D^2$. Then we put

$$\vec{z}' := (\bar{z}_0, \bar{z}_k, \dots, \bar{z}_1)$$

where $\vec{z} = (z_0, \dots, x_k)$, and

$$u'(z) := u(\vec{z}), \quad \gamma'(z) := \gamma(\vec{z}).$$

It is easy to see that

$$I(D^2; u; \vec{z}; \gamma) := (D^2; u'; \vec{z}'; \gamma') \in \widetilde{\mathcal{M}}((X, -\omega, -J_X); L; \vec{a}^{\text{op}}; E).$$

It is easy to see that we can extend I to a homeomorphism

$$I : \mathcal{M}((X, \omega, J_X); L; \vec{a}; E) \rightarrow \mathcal{M}((X, -\omega, -J_X); L; \vec{a}^{\text{op}}; E). \quad (3.62)$$

Lemma 3.56. *The map (3.62) is a underlying continuous map of an isomorphism of Kuranishi structures.*

The next diagram commutes.

$$\begin{array}{ccc} \mathcal{M}((X, \omega, J_X); L; \vec{a}; E) & \xrightarrow{I} & \mathcal{M}((X, -\omega, -J_X); L; \vec{a}^{\text{op}}; E) \\ \text{ev} \downarrow & & \downarrow \text{ev} \\ L(+)^{k+1} & \longrightarrow & L(+)^{k+1} \end{array}$$

where the map in the second horizontal arrow is $(x_0, x_1, \dots, x_k) \mapsto (x_0, x_k, \dots, x_1)$.

◇

Proof. The commutativity of the diagram is obvious from the definition. The proof of the first half is the same as the proof of [FOOO7, Proposition 4.5]. □

We need to study the orientation carefully to complete the proof of Theorem 3.54.

We decompose

$$\mathcal{M}((X, \omega, J_X); L; \vec{a}; E) = \bigcup_d \mathcal{M}((X, \omega, J_X); L; \vec{a}; E; d)$$

where $\mathcal{M}((X, \omega, J_X); L; \vec{a}; E; d)$ is the compactification of the moduli space which consists of the elements $(D^2; \vec{z}; u, \gamma)$ with virtual dimension $d + \sum_{i=1}^k \dim L(a_i)$. We define $\mathcal{M}((X, -\omega, -J_X); L; \vec{a}^{\text{op}}; E; d)$ in the same way.

Let $h_0 \in \Omega^{d_0}(L(a_0); \Theta_{a_0}^-), \dots, h_k \in \Omega^{d_k}(L(a_k); \Theta_{a_k}^-)$. We take a CF-perturbation to integrate differential forms on the space $\mathcal{M}((X, \omega, J_X); L; \vec{a}; E; d)$ with Kuranishi structure. (See [FOOO10, Definition 10.22].) By Lemma 3.56 it induces a CF-perturbation on $\mathcal{M}((X, \omega, J_X); L; \vec{a}; E; d)$.

We compare the integrations:

$$\int_{\mathcal{M}((X, \omega, J_X); L; \vec{a}; E; d)} \text{ev}^*(h_0 \times h_1 \times \dots \times h_k) \quad (3.63)$$

and

$$\int_{\mathcal{M}((X, -\omega, -J_X); L; \vec{a}^{\text{op}}; E; d)} \text{ev}^*(h_0 \times h_k \times \dots \times h_1). \quad (3.64)$$

Here integrations are defined by using CF-perturbations. (See [FOOO10, Definition 10.22].)

We consider the case

$$d = \sum \deg h_i. \quad (3.65)$$

Lemma 3.57. *We use the V -relative spin structure to define the orientation of the moduli space which we use for integration. Then (3.63) = $(-1)^* \times$ (3.64) where*

$$* = 1 + \sum_{1 \leq i < j \leq k} \deg' h_i \deg' h_j + \epsilon.$$

Here $\epsilon = 0$ if and only if $d - (k - 2)$ is divisible by 4. Otherwise $\epsilon = 1$. \diamond

Proof. The proof is mostly the same as [FOOO7, Proposition 4.9]. The sign $\sum_{1 \leq i < j \leq k} \deg' h_i \deg' h_j$ is induced by the fact that we exchange the order of i -th and j -th marked points. Here \deg' rather than \deg appears since the moduli parameter which moves those marked points are exchanged also. The first term 1 appears since the moduli parameter to move 0-th marked point is reversed. See the proof of [FOOO7, Proposition 4.9] for the detail of the argument on those points. We finally explain the reason why ϵ appears. During the proof of Proposition 3.29 we use the fact that the index $\text{Index} P$ appearing (3.40) is isomorphic to a complex vector space. This is because P is an operator on S^2 whose symbol is the same as the Cauchy-Riemann operator. It implies that its (real) determinant bundle is trivial.

Since our isomorphism I in Lemma 3.56 sends a J_X -holomorphic map u to a $-J_X$ -holomorphic map \bar{u} , the map which is induced to $\text{Index} P$ by I is not complex linear. It is actually anti complex linear. Therefore it induces an orientation preserving map on $\text{Det} P$ if and only if the numerical index (the complex dimension) of P is even. Note that P is homotopic to the Cauchy-Riemann operator on S^2 of a bundle with Chern number m , where m is the half of the Maslov index. Therefore this map is orientation preserving if and only if the Maslov index $d - (k - 2)$ is divisible by 4. This is the reason why ϵ appears. (This point is also similar to the proof of [FOOO7, Theorem 4.6].)

The rest of the proof is entirely similar to the proof of [FOOO7, Proposition 4.9]. \square

We next show:

Lemma 3.58. *Suppose (3.65) holds. The orientation which we obtain when using $V \oplus TX$ -relative spin structure is different from one we obtain when using V -relative spin structure if and only if $(-1)^\epsilon = -1$. \diamond*

Proof. We consider a map $u : (D^2, \partial D^2) \rightarrow (X, L)$. It induces a trivialization of $u|_{\partial D^2}^*(TX)$ since D^2 is contractible. On the other hand since $TX|_L = TL \oplus TL$ we have another trivialization of $u|_{\partial D^2}^*(TX)$.

It is easy to see that these two trivializations are homotopic each other if and only if $(-1)^\epsilon = 1$.

We can use this fact to prove the lemma as follows. Let $\lambda : S^1 \rightarrow SO(n)$ be a loop representing the generator of $\pi_1(SO(n)) = \mathbb{Z}_2$. Since the map $\pi_1(SO(n)) \rightarrow \pi_1(U(n)) = \mathbb{Z}$ induced by the inclusion is trivial, we have a map $\lambda_+ : D^2 \rightarrow U(n)$ which coincides with λ on the boundary. We identify $\{0\} \times D^2 \times \mathbb{C}^n$ with $\{1\} \times D^2 \times \mathbb{C}^n$ by using λ_+ and obtain a rank n complex vector bundle E on $D^2 \times S^1$. By construction $E|_{\partial D^2 \times S^1}$ has a real n -dimensional subbundle which is obtained by gluing $\{0\} \times \partial D^2 \times \mathbb{R}^n$ with $\{1\} \times \partial D^2 \times \mathbb{R}^n$ using λ . We denote it by F . Note that the 2nd Stiefel-Whitney class of F is nonzero by the choice of λ .

Using the pair (E, F) we obtain an S^1 -parametrized family of Cauchy-Riemann operators with boundary condition. Namely for $t \in S^1$ we consider

$$\bar{\partial} : L_1^2(D^2; E|_{\{t\} \times D^2}, F|_{\{t\} \times S^1}) \rightarrow L^2(D^2; E|_{\{t\} \times D^2})$$

on $E|_{\{t\} \times D^2}$ with boundary condition determined by F and obtain family of index bundle that is a real vector bundle over S^1 . Using the fact that the 2nd Stiefel-Whitney class of F is nonzero the calculation in the proof of [FOOO2, Proposition 8.1.7] shows that this bundle is unoriented.

This implies that the two orientations obtained by different trivializations of $u|_{\partial D^2}^*(TX)$ are different. This implies Lemma 3.58. \square

Theorem 3.54 follows from Lemmata 3.57 and 3.58 and the definition of opposite category (Definition 2.30 especially its item (3)). \square

4. PRELIMINARY ON LAGRANGIAN CORRESPONDENCE.

The review of the theory of filtered A_∞ categories and the construction of the filtered A_∞ category associated to a symplectic manifold is completed in the previous sections. In this section, we start studying the relationship between Lagrangian correspondences and filtered A_∞ functors, which is the main subject of this paper. This section is rather formal. We introduce certain notations which we will use in later sections.

Definition-Lemma 4.1. Let L_1 (resp. L_{12}) be an immersed Lagrangian submanifold of (X_1, ω_1) (resp. $(X_1 \times X_2, -\pi_1^*(\omega_1) + \pi_2^*(\omega_2))$).

- (1) We say L_1 is transversal to L_{12} if the fiber product $\tilde{L}_1 \times_{X_1} \tilde{L}_{12}$ is transversal.
- (2) Assume L_1 is transversal to L_{12} . We put $\tilde{L}_2 = \tilde{L}_1 \times_{X_1} \tilde{L}_{12}$. The composition $i_{L_2} : \tilde{L}_2 \rightarrow X_1 \times X_2 \rightarrow X_2$ is a Lagrangian immersion.
- (3) We call $L_2 = (\tilde{L}_2, i_{L_2})$ the *geometric transformation* of L_1 by L_{12} .

\diamond

Proof. We prove item (2). Let $x = (y, (p, q)) \in \tilde{L}_2$ and $V \in \text{Ker}(d_x i_{L_2})$. Then $V = (w, v)$ where $w \in T_y \tilde{L}_1, v \in T_p \tilde{L}_{12}$. $(d_y i_{L_1})(w) = (d_p i_{L_{12}})(v)$ and $(d_p i_{L_{12}})(v) \in TX_1 \oplus 0$. Since $\tilde{L}_1 \times_{X_1} \tilde{L}_{12}$ is transversal there exists $v' \in T_p \tilde{L}_{12}$ such that $\omega((d_p i_{L_{12}})(v), (d_p i_{L_{12}})(v')) \neq 0$. Since $(d_p i_{L_{12}})(v) \in TX_1 \oplus 0$ this implies

$$\omega((d_p i_{L_{12}})(v), (d_p i_{L_{12}})(v')) \neq 0.$$

This contradicts the assumption that L_{12} is an immersed Lagrangian submanifold. We have proved that L_2 is an immersed submanifold.

Let $(v_1, w_1), (v_2, w_2) \in T_x \tilde{L}_2$ where $v_i \in T_y \tilde{L}_1, w_i \in T_{(p,q)} \tilde{L}_{12}$. Then $(d_x i_{L_2})(v_i) = (\pi_1(d_{(p,q)} i_{L_{12}}))(w_i)$. Hence $\omega_1(w_1, w_2) = 0$. Since $\omega(w_1, w_2) = 0$ it follows that $\omega_2(w_1, w_2) = 0$. We proved that L_2 is an immersed Lagrangian submanifold. \square

It is not in general correct that the geometric transformation of an embedded Lagrangian submanifold by an embedded Lagrangian correspondence has clean self-intersection.

Example 4.2. Let $X = (-1, 1) \times S^1$, $L_1 = \{0\} \times S^1$. We take a symplectic diffeomorphism φ which is a composition of $(s, t) \rightarrow (s, t + 1/2)$ and a C^1 small Hamiltonian diffeomorphism. (Here we identify $[0, 1]/0 \sim 1 = S^1$.) We can choose φ such that $L_1 \cap \varphi(L_1)$ is not clean. Let $L_{12} \subset -X_1 \times X_1$ be the disjoint union of

the diagonal and the graph of φ . The geometric transformation of L_1 by L_{12} is not clean. \diamond

Definition 4.3. Let $L_1 \subset X_1$ and $L_{12} \subset X_{12}$ be immersed Lagrangian submanifolds. We say L_1 has *clean transformation* by L_{12} if:

- (1) The fiber product $\tilde{L}_1 \times_{X_1} \tilde{L}_{12}$ is transversal.
- (2) The geometric transformation L_2 has clean self-intersection.

\diamond

Lemma 4.4. *Suppose L_1 has clean transformation by L_{12} and let L_2 be its geometric transformation.*

- (1) *If L_1 and L_{12} are oriented so is L_2 .*
- (2) *If L_1 (resp. L_{12}) has V_1 -relative spin structure (resp. $\pi_1^*(TX_1 \oplus V_1) \oplus \pi_2^*(V_2)$ -relative spin structure), then L_2 has V_2 -relative spin structure.*

\diamond

Proof. Let $x = (y, z) \in \tilde{L}_2$. Then there exists a canonical isomorphism of vector spaces

$$T_x L_2 \oplus T_y X_1 \cong T_y L_1 \oplus T_z L_{12}. \quad (4.1)$$

This implies (1).

To prove (2) we first remark the following. Suppose we have a transversal fiber product $\mathcal{X} \times_{\mathcal{Y}} \mathcal{Z}$. Then we can choose smooth triangulations of \mathcal{X} , \mathcal{Y} , \mathcal{Z} , $\mathcal{X} \times_{\mathcal{Y}} \mathcal{Z}$ such that

- (1) The maps $\mathcal{X} \rightarrow \mathcal{Y}$ and $\mathcal{Z} \rightarrow \mathcal{Y}$ send 2 skeletons $\mathcal{X}_{[2]}$, $\mathcal{Z}_{[2]}$ to the 2-skeleton.
- (2) The 2-skeleton of $\mathcal{X} \times_{\mathcal{Y}} \mathcal{Z}$ is contained in $\mathcal{X}_{[2]} \times_{\mathcal{Y}_{[2]}} \mathcal{Z}_{[2]}$.

To find such a triangulation we first take a triangulation of $\mathcal{X} \times_{\mathcal{Y}} \mathcal{Z}$. We then can take enough many vertices of \mathcal{X} , \mathcal{Y} , \mathcal{Z} such that $\mathcal{X}_{[0]} \times_{\mathcal{Y}_{[0]}} \mathcal{Z}_{[0]}$ contains the 0 skeleton of $\mathcal{X} \times_{\mathcal{Y}} \mathcal{Z}$. We can then take $\mathcal{X}_{[1]}$, $\mathcal{Y}_{[1]}$, $\mathcal{Z}_{[1]}$ (subdividing 0 skeleton if necessary), such that $\mathcal{X}_{[1]} \times_{\mathcal{Y}_{[1]}} \mathcal{Z}_{[1]}$ contains the 1 skeleton of the fiber product. We then can find a required triangulation.

On the other hand, the trivialization on 2 skeleton $(L_{12})_{[2]}$ of $\pi_1^*(TX_1 \oplus V_1) \oplus \pi_2^*(V_2) \oplus TL_{12}$ (that is nothing but the $\pi_1^*(TX_1 \oplus V_1) \oplus \pi_2^*(V_2)$ -relative spin structure) and the trivialization on 2 skeleton $(L_1)_{[2]}$ of $TL_1 \oplus i_{L_1}^* V_1$ induce a trivialization of

$$T_y X_1 \oplus (V_1)_y \oplus (V_2)_z \oplus T_z L_{12} \oplus T_y L_1 \oplus (V_1)_y$$

on the fiber product $(L_1)_{[2]} \times_{(X_1)_{[2]}} (L_{12})_{[2]}$. In view of (4.1) it induces a trivialization of

$$T_x L_2 \oplus T_y X_1 \oplus T_y X_1 \oplus (V_1)_y \oplus (V_1)_y \oplus (V_2)_z \quad (4.2)$$

on $(L_2)_{[2]}$. (Note that we use our choice of triangulation and item (2) here.)

We remark that if E is an oriented vector bundle then $E \oplus E$ is spin. In fact

$$\sum_k w_k(E \oplus E) = \left(\sum_k w_k(E \oplus E) \right)^2.$$

Hence $w_2(E \oplus E) = w_1(E) \cup w_1(E) = 0$ since E is oriented.

Therefore the existence of a trivialization of (4.2) on 2 skeleton $(L_2)_{[2]}$ implies the existence of a trivialization of

$$TL_2 \oplus V_2$$

on $(L_2)_{[2]}$. (Note that the trivialization and the spin structure are identical notions on the 2 skeleton.) Therefore L_2 is V_2 -relatively spin as required. \square

Remark 4.5. The proof of Lemma 4.4 gives some particular relative spin structure of L_2 . However in this paper we use the existence of relative spin structure of L_2 only. We make the choice of its relative spin structure later during the proof of Theorem 5.25. (Lemma 6.7.) This relative spin structure seems to be related to one obtained from the proof of Lemma 4.4. We however do not try to clarify the relationship between those two relative spin structures in this paper. \diamond

The next lemma will be used in later sections.

Lemma 4.6. *Let L_1, L_{12} be immersed submanifolds of X_1 and $-X_1 \times X_2$ respectively.²⁶*

We assume that $L_1 = (\tilde{L}_1, i_{L_1})$ has clean transformation by $L_{12} = (\tilde{L}_{12}, i_{L_{12}})$ and denote by $L_2 = (\tilde{L}_2, i_{L_2})$ the geometric transformation. Then

$$(\tilde{L}_1 \times \tilde{L}_2) \times_{X_1 \times X_2} (\tilde{L}_{12}) \quad (4.3)$$

is diffeomorphic to

$$\tilde{L}_2 \times_{X_2} \tilde{L}_2. \quad (4.4)$$

\diamond

Proof. (4.3) is the left hand side of

$$(\tilde{L}_1 \times (\tilde{L}_1 \times_{X_1} \tilde{L}_{12})) \times_{X_1 \times X_2} \tilde{L}_{12} = (\tilde{L}_1 \times_{X_1} \tilde{L}_{12}) \times_{X_2} (\tilde{L}_1 \times_{X_1} \tilde{L}_{12}). \quad (4.5)$$

On the other hand, (4.4) is the right hand side of (4.5). Note that the equality (4.5) is given by

$$((x_1, (x_2, y_1)), y_2) \mapsto ((x_2, y_1), (x_1, y_2)).$$

\square

We can generalize the definitions and lemmas of this section to the case when we have three symplectic manifolds, as follows.

Definition-Lemma 4.7. Let (X_i, ω_i) be a compact symplectic manifolds and V_i its background datum, for $i = 1, 2, 3$. Let L_{12}, L_{23} be Lagrangian submanifolds of $-X_1 \times X_2, -X_2 \times X_3$, respectively.

- (1) If the fiber product $\tilde{L}_{13} = \tilde{L}_{12} \times_{X_2} \tilde{L}_{23}$ is transversal then the map $\tilde{L}_{13} \rightarrow -X_1 \times X_3$ induced by $\tilde{L}_{13} \rightarrow -X_1 \times X_2 \times -X_2 \times X_3 \rightarrow -X_1 \times X_3$ is a Lagrangian immersion. We assume that L_{13} is self clean.

In such situation, we call L_{13} the *geometric composition* of L_{12} and L_{23} .

- (2) If L_{12} and L_{23} are oriented then so is the geometric composition L_{13} .
- (3) If L_{12} has $\pi_1^*(TX_1 \oplus V_1) \oplus \pi_2^*(V_2)$ -relative spin structure and L_{23} has $\pi_1^*(TX_2 \oplus V_2) \oplus \pi_2^*(V_3)$ -relative spin structure, then the geometric composition L_{13} has $\pi_1^*(TX_1 \oplus V_1) \oplus \pi_2^*(V_3)$ -relative spin structure.

\diamond

Proof. The case when X_1 is a point is proved already. The proof of the general case is the same and so is omitted. \square

²⁶See Notation 3.1 for $-X_1 \times X_2$.

5. THE KÜNNETH BI-FUNCTOR IN LAGRANGIAN FLOER THEORY.

5.1. Algebraic framework of A_∞ bi-functors and tri-functors. To define the notion of filtered A_∞ bi-functor we recall the following. Let (B_1, Δ_1) , (B_2, Δ_2) be graded coalgebras. We define graded coalgebra structure

$$\Delta : B_1 \otimes B_2 \rightarrow (B_1 \otimes B_2) \otimes (B_1 \otimes B_2)$$

of $B_1 \otimes B_2$ by the next formula.

$$\Delta(x \otimes y) = \mathcal{S}(\Delta_1(x) \otimes \Delta_2(y)) \quad (5.1)$$

where

$$\mathcal{S}((x_1 \otimes x_2) \otimes (y_1 \otimes y_2)) = (-1)^{\deg' y_1 \deg' x_2} ((x_1 \otimes y_1) \otimes (x_2 \otimes y_2)).$$

The case of completed tensor product of formal coalgebra is the same. Note that in Definition 5.1 etc. we use the shifted degree. So we used \deg' in the above formula instead of \deg .

Definition 5.1. Let $\mathcal{C}_1, \mathcal{C}_2, \mathcal{C}_3$ be non-unital curved filtered A_∞ categories. A filtered A_∞ bi-functor $\mathcal{F} : \mathcal{C}_1 \times \mathcal{C}_2 \rightarrow \mathcal{C}_3$ consists of \mathcal{F}_{ob} and \mathcal{F}_{k_1, k_2} ($k_1, k_2 = 0, 1, 2, 3, \dots$) of degree 0 with the following properties (1)(2)(3)(4).

- (1) $\mathcal{F}_{ob} : \mathfrak{OB}(\mathcal{C}_1) \times \mathfrak{OB}(\mathcal{C}_2) \rightarrow \mathfrak{OB}(\mathcal{C}_3)$ is a map between sets of objects.
- (2) For each $c_{1,1}, c_{1,2} \in \mathfrak{OB}(\mathcal{C}_1)$ and $c_{2,1}, c_{2,2} \in \mathfrak{OB}(\mathcal{C}_2)$, the bi-functor \mathcal{F}_{k_1, k_2} associates a Λ_0 linear map

$$\begin{aligned} \mathcal{F}_{k_1, k_2}(c_{1,1}, c_{1,2}; c_{2,1}, c_{2,2}) : B_{k_1} \mathcal{C}_1[1](c_{1,1}, c_{1,2}) \widehat{\otimes} B_{k_2} \mathcal{C}_2[1](c_{2,1}, c_{2,2}) \\ \rightarrow \mathcal{C}_3[1](\mathcal{F}_{ob}(c_{1,1}, c_{2,1}), \mathcal{F}_{ob}(c_{1,2}, c_{2,2})). \end{aligned}$$

- (3) We require $\mathcal{F}_{k_1, k_2}(c_{1,1}, c_{1,2}; c_{2,1}, c_{2,2})$ to preserve the filtration in a similar sense as Definition 2.2 (2).

Note that the symbol $\mathcal{C}_1 \times \mathcal{C}_2$ is used here. However we do not define the product $\mathcal{C}_1 \times \mathcal{C}_2$ of two A_∞ categories in this paper. In other words, $\mathcal{C}_1 \times \mathcal{C}_2$ is simply a notation.

To describe the most important condition we introduce certain notations.

Let $\Delta_i : B\mathcal{C}_i[1](c_{i,1}, c_{i,2}) \rightarrow B\mathcal{C}_i[1](c_{i,1}, c_{i,2}) \widehat{\otimes} B\mathcal{C}_i[1](c_{i,1}, c_{i,2})$ be the formal coalgebra structure for $i = 1, 2, 3$. We define the formal coalgebra structure Δ on the completed tensor product $B\mathcal{C}_1[1](c_{1,1}, c_{1,2}) \widehat{\otimes} B\mathcal{C}_2[1](c_{2,1}, c_{2,2})$ by (5.1).

The system of maps $\{\mathcal{F}_{k_1, k_2}\}$ induces uniquely a formal coalgebra homomorphism

$$\begin{aligned} \widehat{\mathcal{F}}(c_{1,1}, c_{1,2}; c_{2,1}, c_{2,2}) : B\mathcal{C}_1[1](c_{1,1}, c_{1,2}) \widehat{\otimes} B\mathcal{C}_2[1](c_{2,1}, c_{2,2}) \\ \rightarrow B\mathcal{C}_3[1](\mathcal{F}_{ob}(c_{1,1}, c_{2,1}), \mathcal{F}_{ob}(c_{1,2}, c_{2,2})). \end{aligned}$$

Note that the structure operations of \mathcal{C}_i induce a coderivation $\hat{d}_i : B\mathcal{C}_i[1](c_{i,1}, c_{i,2}) \rightarrow B\mathcal{C}_i[1](c_{i,1}, c_{i,2})$.

- (4) We regard $\widehat{\mathcal{F}}(c_{1,1}, c_{1,2}; c_{2,1}, c_{2,2})$ as a chain map. Namely we require:

$$\hat{d}_3 \circ \widehat{\mathcal{F}}(c_{1,1}, c_{1,2}; c_{2,1}, c_{2,2}) = \widehat{\mathcal{F}}(c_{1,1}, c_{1,2}; c_{2,1}, c_{2,2}) \circ (\hat{d}_1 \widehat{\otimes} \text{id} + \text{id} \widehat{\otimes} \hat{d}_2) \quad (5.2)$$

where $\widehat{\otimes}$ is as in Definition 2.1 (6). \diamond

Definition 5.2. Let $\mathcal{C}_1, \mathcal{C}_2, \mathcal{C}_3$ be non-unital curved filtered A_∞ categories and $\mathcal{F} : \mathcal{C}_1 \times \mathcal{C}_2 \rightarrow \mathcal{C}_3$ a filtered A_∞ bi-functor.

- (1) We say \mathcal{F} is *strict* if $\mathcal{F}_{0,0} = 0$.

- (2) Suppose $\mathcal{C}_1, \mathcal{C}_2, \mathcal{C}_3$ are G -gapped. We say \mathcal{F} is G -gapped if \mathcal{F}_{k_1, k_2} are all G -gapped.
- (3) Suppose $\mathcal{C}_1, \mathcal{C}_2, \mathcal{C}_3$ are unital. We say \mathcal{F} is *unital* if the following holds.
- (a) $\mathcal{F}_{1,0}(\mathbf{e}_{c_1} \otimes 1) = \mathcal{F}_{0,1}(1 \otimes \mathbf{e}_{c_2}) = \mathbf{e}_{\mathcal{F}_{ob}(c_1, c_2)}$.
- (b)
- $$\mathcal{F}_{k_1 + \ell_1 + 1, k_2}(x_1^1, \dots, x_{k_1}^1, \mathbf{e}_{c_1}, y_1^1, \dots, y_{\ell_1}^1; x_1^2, \dots, x_{k_2}^2) = 0$$
- for $k_1 + k_2 + \ell_1 > 0$.
- (c)
- $$\mathcal{F}_{k_1, k_2 + \ell_2 + 1}(x_1^1, \dots, x_{k_1}^1; x_1^2, \dots, x_{k_2}^2, \mathbf{e}_{c_2}, y_1^1, \dots, y_{\ell_2}^1) = 0$$
- for $k_1 + k_2 + \ell_2 > 0$.

◇

Example 5.3. Suppose $\mathcal{C}_1, \mathcal{C}_2$ have only one object. We also assume that they are strict. Then we may regard them as filtered A_∞ algebras, which we denote by $(C_1, \{\mathbf{m}_k\}), (C_2, \{\mathbf{m}_k\})$. We call a strict filtered A_∞ bi-functor

$$\mathcal{F} : (C_1^{\text{op}}, \{\mathbf{m}_k\}) \times (C_2, \{\mathbf{m}_k\}) \rightarrow \mathcal{CH}$$

a *filtered A_∞ bi-module* over $(C_1, \{\mathbf{m}_k\})$ - $(C_2, \{\mathbf{m}_k\})$. We also say left C_1 and right C_2 filtered A_∞ bi-module.

The notion of filtered A_∞ bi-module is introduced in [FOOO1, Definition 3.7.5]. Below we will check that Definition 5.1 coincides with the definition in [FOOO1] in this case.

Since $\mathcal{C}_1, \mathcal{C}_2$ have unique objects, \mathcal{F}_{ob} determines a chain complex, which we write (D, d) . (Here d is the boundary operator of this chain complex.) \mathcal{F}_{k_1, k_2} becomes a map

$$\mathcal{F}_{k_1, k_2} : B_{k_1}C_1[1] \otimes B_{k_2}C_2[1] \rightarrow \text{Hom}(D, D)[1].$$

of degree one. We will define

$$\mathbf{n}_{k_1, k_2} : B_{k_1}C_1[1] \otimes D \otimes B_{k_2}C_2[1] \rightarrow D.$$

We first define $\text{OP} : B_kC_1[1] \rightarrow B_kC_1[1]$ by

$$\text{OP}(\mathbf{x}) = (-1)^{\epsilon(\mathbf{x})} \mathbf{x}^{\text{op}}, \quad (5.3)$$

where $\epsilon(\mathbf{x})$ and \mathbf{x}^{op} are (2.15), (2.16), respectively. We remark

$$\mathbf{m}_k^{\text{op}}(\mathbf{x}) = -\mathbf{m}_k(\text{OP}(\mathbf{x})). \quad (5.4)$$

We now put

$$\mathbf{n}_{k_1, k_2}(\mathbf{x}; y; \mathbf{z}) := (-1)^{\text{deg}' y \text{deg}' \mathbf{z}} (\mathcal{F}_{k_1, k_2}(\text{OP}(\mathbf{x}); \mathbf{z}))(y) \quad (5.5)$$

for $(k_1, k_2) \neq (0, 0)$ (Note that $\text{deg}'(x_1 \otimes \dots \otimes x_k) = k + \sum \text{deg } x_i$.) and

$$\mathbf{n}_{0,0}(y) := (-1)^{\text{deg } y} dy. \quad (5.6)$$

We call \mathbf{n}_{k_1, k_2} the structure operations of filtered A_∞ bi-module. (Compare Definition 3.50.)

We will prove that Definition 5.1 (4) becomes the following equality.

$$\begin{aligned} 0 &= \sum (-1)^{\text{deg}' \mathbf{x}_{c_x}^{(2;1)}} \mathbf{n}(\mathbf{x}_{c_x}^{(2;1)}; \mathbf{n}(\mathbf{x}_{c_x}^{(2;2)}; y; \mathbf{z}_{c_z}^{(2;1)}); \mathbf{z}_{c_z}^{(2;2)}) \\ &\quad + \mathbf{n}(\hat{d}_1(\mathbf{x}); y; \mathbf{z}) + (-1)^{\text{deg}' \mathbf{x} + \text{deg } y} \mathbf{n}(\mathbf{x}; y; \hat{d}_2(\mathbf{z})). \end{aligned} \quad (5.7)$$

The notation is as follows. The symbol \hat{d}_1 (resp. \hat{d}_2) is the coderivation induced by the A_∞ operations on C_1 (resp. C_2). We put

$$\Delta_1(\mathbf{x}) = \sum_{c_x} \mathbf{x}_{c_x}^{(2;1)} \otimes \mathbf{x}_{c_x}^{(2;2)}, \quad \Delta_2(\mathbf{z}) = \sum_{c_z} \mathbf{z}_{c_z}^{(2;1)} \otimes \mathbf{z}_{c_z}^{(2;2)}.$$

The formula (5.7) is the defining relation of a filtered A_∞ bi-module in [FOOO1, Definition 3.7.5]. We also call it the A_∞ relation.

Remark 5.4. In [FOOO1, Definition 3.7.5] the sign in the third term of right hand side is $(-1)^{\deg' \mathbf{z} + \deg' y}$. So it is slightly different. In [FOOO1] the bi-module is written $D(1)$. Here we use the notation D for a bi-module. So the definitions of this paper and of [FOOO1] are consistent. We discuss this point more in Remarks 5.5 and 5.7.

Let us prove that Definition 5.1 (4) implies (5.7). (The main part of the proof is the check of the sign.)

Definition 5.1 (4) becomes the following identity in $Hom(D, D)[1]$.

$$\begin{aligned} & \sum (-1)^{\deg' \mathbf{x}_{c_x}^{(2;2)} \deg' \mathbf{z}_{c_z}^{(2;1)}} \mathbf{m}_2(\mathcal{F}(\mathbf{x}_{c_x}^{(2;1)}, \mathbf{z}_{c_z}^{(2;1)}), \mathcal{F}(\mathbf{x}_{c_x}^{(2;2)}, \mathbf{z}_{c_z}^{(2;2)})) \\ & + \mathbf{m}_1(\mathcal{F}(\mathbf{x}, \mathbf{z})) = \mathcal{F}(\hat{d}_1(\mathbf{x}), \mathbf{z}) + (-1)^{\deg' \mathbf{x}} \mathcal{F}(\mathbf{x}, \hat{d}_2(\mathbf{z})). \end{aligned} \quad (5.8)$$

Here $\mathbf{m}_1, \mathbf{m}_2$ in the left hand side are the structure operations of $\mathcal{CH}[1]$. They are related to the composition and the differential by (2.18).

We plug in $y \in D$ in the first term of the left hand side and obtain

$$\begin{aligned} & \sum (-1)^{*1} \mathcal{F}(\mathbf{x}_{c_x}^{(2;2)}, \mathbf{z}_{c_z}^{(2;2)})(\mathcal{F}(\mathbf{x}_{c_x}^{(2;1)}, \mathbf{z}_{c_z}^{(2;1)})(y)) \\ & = \sum (-1)^{*2} \mathbf{n}(\text{OP}(\mathbf{x}_{c_x}^{(2;2)}); \mathbf{n}(\text{OP}(\mathbf{x}_{c_x}^{(2;1)}); y; \mathbf{z}_{c_z}^{(2;1)}); \mathbf{z}_{c_z}^{(2;2)}). \end{aligned} \quad (5.9)$$

Here

$$\begin{aligned} *1 & = (\deg' \mathbf{x}_{c_x}^{(2;2)} + \deg' \mathbf{z}_{c_z}^{(2;2)})(\deg' \mathbf{x}_{c_x}^{(2;1)} + \deg' \mathbf{z}_{c_z}^{(2;1)} + 1) + \deg' \mathbf{x}_{c_x}^{(2;2)} \deg' \mathbf{z}_{c_z}^{(2;1)} \\ *2 & = *1 + \deg' \mathbf{z}_{c_z}^{(2;1)} \deg' y + \deg' \mathbf{z}_{c_z}^{(2;2)}(\deg' \mathbf{x}_{c_x}^{(2;1)} + \deg' y + \deg' \mathbf{z}_{c_z}^{(2;1)} + 1) \\ & = \deg' \mathbf{x}_{c_x}^{(2;1)} \deg' \mathbf{x}_{c_x}^{(2;2)} + \deg' \mathbf{x}_{c_x}^{(2;2)} + \deg' y(\deg' \mathbf{z}_{c_z}^{(2;1)} + \deg' \mathbf{z}_{c_z}^{(2;2)}). \end{aligned}$$

Note that in the sum (5.9) the case $(\mathbf{x}_{c_x}^{(2;1)}, \mathbf{z}_{c_z}^{(2;1)}) = 1 \otimes 1 \in B_0 C_1[1] \otimes B_0 C_2[1]$ or $(\mathbf{x}_{c_x}^{(2;2)}, \mathbf{z}_{c_z}^{(2;2)}) = 1 \otimes 1 \in B_0 C_1[1] \otimes B_0 C_2[1]$ are included only for the first term of (5.6). The contribution of the second term of (5.6) in those cases actually coincide with the second term of the left hand side of (5.8). Therefore the left hand side of (5.8) coincides with (5.9) including those cases.

We replace \mathbf{x} by $\text{OP}(\mathbf{x})$ in (5.8). We remark that

$$\text{OP}(\Delta_1(\mathbf{x})) = \sum (-1)^{\deg' \mathbf{x}_{c_x}^{(2;1)} \deg' \mathbf{x}_{c_x}^{(2;2)}} \text{OP}(\mathbf{x}_{c_x}^{(2;2)}) \otimes \text{OP}(\mathbf{x}_{c_x}^{(2;1)}).$$

Therefore (5.8) and (5.9) becomes

$$\begin{aligned} & \sum (-1)^{*3} \mathbf{n}(\mathbf{x}_{c_x}^{(2;1)}; \mathbf{n}(\mathbf{x}_{c_x}^{(2;2)}; y; \mathbf{z}_{c_z}^{(2;1)}); \mathbf{z}_{c_z}^{(2;2)}) \\ & = (\mathcal{F}(\hat{d}_1(\text{OP}(\mathbf{x})), \mathbf{z}))(y) + (-1)^{\deg' \mathbf{x}} (\mathcal{F}(\text{OP}(\mathbf{x}), \hat{d}_2(\mathbf{z})))(y). \end{aligned} \quad (5.10)$$

where

$$*3 = \deg' \mathbf{x}_{c_x}^{(2;1)} + \deg' y(\deg' \mathbf{z}_{c_z}^{(2;1)} + \deg' \mathbf{z}_{c_z}^{(2;2)}) = \deg' \mathbf{x}_{c_x}^{(2;1)} + \deg' y \deg' \mathbf{z}.$$

Using (5.4) we can calculate the right hand side of (5.10) to obtain

$$-(-1)^{*_4} \mathbf{n}(\hat{d}_1(\mathbf{x}); y; \mathbf{z}) + (-1)^{*_5} \mathbf{n}(\mathbf{x}; y; \hat{d}_2(\mathbf{z})),$$

where $*_4 = \deg' \mathbf{z} \deg' y$ and $*_5 = \deg' \mathbf{x} + (\deg' \mathbf{z} + 1) \deg' y = \deg' \mathbf{x} + \deg' \mathbf{z} \deg' y + \deg' y + 1$. Therefore (5.10) becomes (5.7), as required. \diamond

Note that the order of $\mathcal{F}(\mathbf{x}_{c_x}^{(2;1)}, \mathbf{z}_{c_z}^{(2;1)})$ and $\mathcal{F}(\mathbf{x}_{c_x}^{(2;2)}, \mathbf{z}_{c_z}^{(2;2)})$ appearing in (5.8) is reversed in (5.9). This is because it is defined so in (2.18). The sign $(-1)^{\deg x(\deg y + 1)} = (-1)^{\deg' x \deg' y + \deg' y}$ there is actually the Koszul sign, that is, associated to the exchange of the symbols $\mathbf{m}_2, x, y \mapsto y, \circ, x$. This is an intuitive reason why rather complicate sign calculation in Example 5.3 works.

Remark 5.5. If $D(1)$ has a structure of A_∞ bi-module \mathbf{n} then its degree shift D has a A_∞ bi-module \mathbf{n}' defined by

$$\mathbf{n}'(\mathbf{x}, ys, \mathbf{z}) = (-1)^{\deg' \mathbf{z}} \mathbf{n}'(\mathbf{x}, y, \mathbf{z})s. \quad (5.11)$$

Here ys is an element $y \in D(1)$ regarded as an element of D .

Example 5.6. To any filtered A_∞ category \mathcal{C} we can associate a filtered A_∞ bi-module $\mathcal{C}(1)$ as follows. We put $\mathcal{C}(1)^d(c_1, c_2) = \mathcal{C}^{d+1}(c_1, c_2)$. We define structure operation \mathbf{n} by

$$\mathbf{n}(\mathbf{x}, y, \mathbf{z}) = \mathbf{m}(\mathbf{x}, y, \mathbf{z}).$$

It is easy to see that this satisfies the A_∞ relation.

In view of Remark 5.5 it induces a structure of filtered A_∞ bi-module on \mathcal{C} (without degree shift) by

$$\mathbf{n}'(\mathbf{x}, y, \mathbf{z}) = (-1)^{\deg' \mathbf{z}} \mathbf{m}(\mathbf{x}, y, \mathbf{z}).$$

In case \mathcal{C} is strict, the operator \mathbf{n}' induces a strict filtered A_∞ -bi-functor

$$\mathcal{F} : \mathcal{C}^{\text{op}} \times \mathcal{C} \rightarrow \mathcal{CH}$$

as follows. We put $\mathcal{F}_{ob}(c_1, c_2) = \mathcal{C}(c_1, c_2)$. We define a map

$$\mathcal{F}'_{k_1, k_2} : B_{k_1} \mathcal{C}[1](c_0, c_1) \hat{\otimes} B_{k_2} \mathcal{C}[1](c_2, c_3) \rightarrow \text{Hom}(\mathcal{C}(c_1, c_2), \mathcal{C}(c_0, c_3))[1]$$

by

$$(\mathcal{F}'_{k_1, k_2}(\mathbf{x}; \mathbf{z}))(y) = (-1)^* \mathbf{m}_{k_1+k_2+1}(\mathbf{x}, y, \mathbf{z}). \quad (5.12)$$

where $*$ = $\deg y \deg' \mathbf{z}$. (Here $\deg y$ appears instead of $\deg' y$ because of the sign in (5.11).) We then compose it with OP, and obtain the required map:

$$\mathcal{F}_{k_1, k_2} : B_{k_1} \mathcal{C}^{\text{op}}[1](c_1, c_0) \hat{\otimes} B_{k_2} \mathcal{C}[1](c_2, c_3) \rightarrow \text{Hom}(\mathcal{C}(c_1, c_2), \mathcal{C}(c_0, c_3)).$$

This construction is an analogue of the fact that an arbitrary algebra is a bi-module over itself. \diamond

Remark 5.7. A reason why we shifted the degree in [FOOO1] is Example 5.6. Namely we can put $\mathbf{m} = \mathbf{n}$ if we shift the degree. The reason why we do not shift the degree of bi-module will be clear in Section 10. There we will regard a left- \mathcal{C}_1 and right- \mathcal{C}_2 bi-module as a ‘morphism’ from \mathcal{C}_1 to \mathcal{C}_2 . In that case the bi-module in Example 5.6 plays the role of the identity morphism. However if we shift the degree then it will not behave as the identity morphism. Until Section 10 we will use the convention of [FOOO1], that is, we shift the degree of bi-module. In the way explained in (5.11) we can go from one to the other.

We next generalize the story of [FOOO1, Subsubsection 5.2.2.1] to our category case.

Lemma 5.8. *Let $\mathcal{C}_1, \mathcal{C}_2, \mathcal{C}_3$ be non-unital curved filtered A_∞ categories and $\mathcal{C}_1^s, \mathcal{C}_2^s, \mathcal{C}_3^s$ their associated strict categories.*

Then any filtered A_∞ bi-functor $\mathcal{F} : \mathcal{C}_1 \times \mathcal{C}_2 \rightarrow \mathcal{C}_3$ induces a strict filtered A_∞ bi-functor $\mathcal{F}^s : \mathcal{C}_1^s \times \mathcal{C}_2^s \rightarrow \mathcal{C}_3^s$. If \mathcal{F} is unital or G -gapped, then so is \mathcal{F}^s . \diamond

Proof. Let $c_i \in \mathfrak{DB}(\mathcal{C}_i)$, $(c_i, b_i) \in \mathfrak{DB}(\mathcal{C}_i')$ for $i = 1, 2$. We put

$$b_3 = \sum_{k_1=0}^{\infty} \sum_{k_2=0}^{\infty} \mathcal{F}_{k_1, k_2}(b_1^{k_1}, b_2^{k_2}). \quad (5.13)$$

We put $e^b = \sum_{k=0}^{\infty} b^k$ then

$$e^{b_3} = \widehat{\mathcal{F}}(e^{b_1}, e^{b_2}).$$

Since b_i are bounding cochains for $i = 1, 2$ we have $\hat{d}_1(e^{b_1}) = \hat{d}_2(e^{b_2}) = 0$. (See [FOOO1, Lemma 3.6.36].) Therefore Definition 5.1 (4) implies $\hat{d}_1(e^{b_3}) = 0$. In other words b_3 is a bounding cochain. We define

$$\mathcal{F}_{ob}^s((c_1, b_1), (c_2, b_2)) = (c_3, b_3). \quad (5.14)$$

Let $\mathbf{x}_i \in B_{k_i} \mathcal{C}_i[1](c_i^1, c_i^2) \cong B_{k_i} \mathcal{C}_i'[1]((c_i^1, b_i^1), (c_i^2, b_i^2))$, $i = 1, 2$. We will define $\mathcal{F}_{k_1, k_2}^s(\mathbf{x}_1, \mathbf{x}_2)$. For this purpose we define

$$\mathfrak{t}^{b_i} : B \mathcal{C}_i[1](c_i^1, c_i^2) \rightarrow B \mathcal{C}_i[1](c_i^1, c_i^2)$$

for $i = 1, 2, 3$ as follows. Let

$$\mathbf{x}_i = x_{i,1} \otimes \cdots \otimes x_{i,k_i}$$

where $x_{i,j} \in \mathcal{C}_i[1](c_{i,j-1}, c_{i,j})$, $c_{i,j} \in \mathfrak{DB}(\mathcal{C}_i)$, with $c_{i,0} = c_i^1$, $c_{i,k_i} = c_i^2$. We define

$$\mathfrak{t}^{b_i}(\mathbf{x}_i) = e^{b_{i,0}} \otimes x_{i,1} \otimes e^{b_{i,1}} \otimes \cdots \otimes e^{b_{i,k_i-1}} \otimes x_{i,k_i} \otimes e^{b_{i,k_i}}. \quad (5.15)$$

Sublemma 5.9. (1) \mathfrak{t}^{b_i} is a Λ_0 module isomorphism.

(2) $\Delta_i \circ \mathfrak{t}^{b_i} = (\mathfrak{t}^{b_1} \otimes \mathfrak{t}^{b_2}) \circ \Delta_i$.

(3) $\hat{d}_i^{b_i} \circ \mathfrak{t}^{b_i} = \mathfrak{t}^{b_i} \circ \hat{d}_i$. Here $\hat{d}_i^{b_i}$ is a coderivation induced from \mathfrak{m}^{b_i} .

\diamond

The proof is the same as the proof of [FOOO1, Lemma 5.2.12] and so is omitted. By Sublemma 5.9 (1) there exists uniquely a Λ_0 module homomorphism

$$\begin{aligned} \widehat{\mathcal{F}}^s((c_1^1, b_1^1), (c_2^1, b_2^1); (c_2^2, b_2^2), (c_1^2, b_1^2)) : B \mathcal{C}_1[1](c_1^1, c_2^1) \hat{\otimes} B \mathcal{C}_2[1](c_2^2, c_1^2) \\ \rightarrow B \mathcal{C}_3[1]((c_1^3, b_1^3), (c_2^3, b_2^3)) \end{aligned}$$

(where $(c_i^3, b_i^3) = \mathcal{F}_{ob}^s((c_i^1, b_i^1), (c_i^2, b_i^2))$) such that

$$\mathfrak{t}^{b_3} \circ \widehat{\mathcal{F}}^s = \widehat{\mathcal{F}} \circ (\mathfrak{t}^{b_1} \otimes \mathfrak{t}^{b_2}). \quad (5.16)$$

Here and hereafter we write $\widehat{\mathcal{F}}^s$ in place of $\widehat{\mathcal{F}}^s((c_1^1, b_1^1), (c_2^1, b_2^1); (c_2^2, b_2^2), (c_1^2, b_1^2))$, for simplicity. Sublemma 5.9 (3) implies

$$\hat{d}^{b_3} \circ \widehat{\mathcal{F}}^s = \widehat{\mathcal{F}}^s \circ (\hat{d}^{b_1} \hat{\otimes} \text{id} + \text{id} \hat{\otimes} \hat{d}^{b_2}). \quad (5.17)$$

Sublemma 5.9 (2) implies

$$\Delta_3 \circ \widehat{\mathcal{F}}^s = \widehat{\mathcal{F}}^s \circ (\Delta_1 \hat{\otimes} \text{id} + \text{id} \hat{\otimes} \Delta_2). \quad (5.18)$$

(5.18) implies that $\widehat{\mathcal{F}}^s$ is induced by \mathcal{F}_{k_1, k_2}^s . In fact \mathcal{F}_{k_1, k_2}^s is a composition of the restriction of $\widehat{\mathcal{F}}^s$ to $B_{k_1}\mathcal{C}_1[1](c_1^1, c_2^1) \widehat{\otimes} B_{k_2}\mathcal{C}_2[1](c_1^2, c_2^2)$ and the projection $B\mathcal{C}_3[1]((c_1^3, b_1^3), (c_2^3, b_2^3)) \rightarrow \mathcal{C}_3[1]((c_1^3, b_1^3), (c_2^3, b_2^3))$.

Then (5.17) implies that it satisfies the required property, Definition 5.1 (4).

To show that \mathcal{F}^s is strict, we observe

$$\widehat{\mathcal{F}} \circ (\mathfrak{t}^{b_1}(1) \otimes \mathfrak{t}^{b_2}(1)) = \widehat{\mathcal{F}}(e^{b_1}, e^{b_2}) = e^{b_3} = \mathfrak{t}^{b_3}(1).$$

Namely $\widehat{\mathcal{F}}^s(1) = 1$. This implies $\mathcal{F}_{0,0}^s(1) = 0$. \square

In the case when \mathcal{C} is curved we can not define the filtered A_∞ bi-functor in Example 5.6. However we can still use the language of filtered A_∞ bi-module to define a similar object.

Let $\mathcal{C}_1, \mathcal{C}_2$ be non-unital curved filtered A_∞ categories. We define the notion of a left- \mathcal{C}_1 and right- \mathcal{C}_2 bi-module as follows.

Definition 5.10. A left- \mathcal{C}_1 and right- \mathcal{C}_2 filtered A_∞ bi-module, is $\mathcal{D} = (\{D_{c_1, c_2}\}, \{\mathfrak{n}_{c'_1, c_1, c_2, c'_2}\})$, where:

- (1) The object $\{D_{c_1, c_2}\}$ assigns a completed free graded Λ_0 module D_{c_1, c_2} to each $c_1 \in \mathfrak{D}\mathfrak{B}(\mathcal{C}_1)$, $c_2 \in \mathfrak{D}\mathfrak{B}(\mathcal{C}_2)$.
- (2) To each $c_1, c'_1 \in \mathfrak{D}\mathfrak{B}(\mathcal{C}_1)$, $c_2, c'_2 \in \mathfrak{D}\mathfrak{B}(\mathcal{C}_2)$ we are given a Λ_0 module homomorphism

$$\mathfrak{n}_{c'_1, c_1, c_2, c'_2} : B\mathcal{C}_1[1](c'_1, c_1) \widehat{\otimes} D_{c_1, c_2} \widehat{\otimes} B\mathcal{C}_2[1](c_2, c'_2) \rightarrow D_{c'_1, c'_2},$$

of degree +1 which preserves the energy filtration.

- (3) The following A_∞ relation is satisfied.

$$\begin{aligned} 0 = & \sum_{a_1} \sum_{a_2} (-1)^{*_1} \mathfrak{n}(\mathbf{x}_{1:a_1}, \mathfrak{n}(\mathbf{x}_{2:a_1}, z, \mathbf{y}_{1:a_2}), \mathbf{y}_{2:a_2}) \\ & + \mathfrak{n}(\hat{d}_1(\mathbf{x}), z, \mathbf{y}) + (-1)^{*_2} \mathfrak{n}(\mathbf{x}, z, \hat{d}_2(\mathbf{y})). \end{aligned} \quad (5.19)$$

Here $*_1 = \deg' \mathbf{x}_{1:a_1}$, $*_2 = \deg' \mathbf{x} + \deg' z$. The notations are as follows. $\mathbf{x} \in B\mathcal{C}_1[1](c'_1, c_1)$, $y \in D_{c_1, c_2}$, $\mathbf{z} \in B\mathcal{C}_2[1](c_2, c'_2)$. $\Delta \mathbf{x} = \sum_{a_1} \mathbf{x}_{1:a_1} \otimes \mathbf{x}_{2:a_1}$. $\Delta \mathbf{y} = \sum_{a_2} \mathbf{y}_{1:a_2} \otimes \mathbf{y}_{2:a_2}$. The symbol \hat{d}_i denotes the coderivation induced by the structure operations of \mathcal{C}_i and is defined in (2.6).

A filtered A_∞ bi-module over G -gapped unital curved filtered A_∞ category is said to be G -gapped if all the structure operations are G -gapped. It is said to be *unital* if the following holds:

- (1) The equality

$$\mathfrak{n}_{1,0}(\mathbf{e}_1, y) = (-1)^{\deg y} \mathfrak{n}_{1,0}(y, \mathbf{e}_2) = y.$$

Here \mathbf{e}_i is the unit of \mathcal{C}_i .

- (2) If \mathbf{x} or \mathbf{z} contains the unit then $\mathfrak{n}(\mathbf{x}; y; \mathbf{z}) = 0$ except the cases appearing in item (1).

\diamond

We define

$$\begin{aligned} \hat{\mathfrak{n}}_{c'_1, c'_2} : & \bigoplus_{c_1, c_2} B\mathcal{C}_1[1](c'_1, c_1) \widehat{\otimes} D_{c_1, c_2} \widehat{\otimes} B\mathcal{C}_2[1](c_2, c'_2) \\ & \rightarrow \bigoplus_{c_1, c_2} B\mathcal{C}_1[1](c'_1, c_1) \widehat{\otimes} D_{c'_1, c'_2} \widehat{\otimes} B\mathcal{C}_2[1](c_2, c'_2), \end{aligned}$$

by

$$\begin{aligned} \widehat{\mathbf{n}}_{c'_1, c'_2}(\mathbf{x}, z, \mathbf{y}) &= \sum_{a_1} \sum_{a_2} (-1)^{*1} \mathbf{x}_{1:a_1} \otimes \mathbf{n}(\mathbf{x}_{2:a_1} z, \mathbf{y}_{1:a_2}) \otimes \mathbf{y}_{2:a_2} \\ &\quad + \widehat{d}_1(\mathbf{x}) \otimes z \otimes \mathbf{y} + (-1)^{*2} \mathbf{x} \otimes z \otimes \widehat{d}_2(\mathbf{y}) \end{aligned} \quad (5.20)$$

where the notations are as in (5.19). Then the formula (5.19) is equivalent to

$$\widehat{\mathbf{n}}_{c'_1, c'_2} \circ \widehat{\mathbf{n}}_{c'_1, c'_2} = 0. \quad (5.21)$$

Definition 5.11. Let $\mathcal{D}^{(i)} = (\{D_{c_1, c_2}^{(i)}\}, \{\mathbf{n}_{c'_1, c_1, c_2, c'_2}^{(i)}\})$ be a left- \mathcal{C}_1 and right- \mathcal{C}_2 filtered A_∞ bi-module, for $i = 1, 2$. A pre-bi-module homomorphism of degree d from $\mathcal{D}^{(1)}$ to $\mathcal{D}^{(2)}$ is $\mathbf{f} = \{\mathbf{f}_{c'_1, c_1, c_2, c'_2}\}$ where:

(*) To each $c_1, c'_1 \in \mathfrak{D}\mathfrak{B}(\mathcal{C}_1)$, $c_2, c'_2 \in \mathfrak{D}\mathfrak{B}(\mathcal{C}_2)$ we are given a Λ_0 module homomorphism

$$\mathbf{f}_{c'_1, c_1, c_2, c'_2} : B\mathcal{C}_1[1](c'_1, c_1) \widehat{\otimes} D_{c_1, c_2}^{(1)} \widehat{\otimes} B\mathcal{C}_2[1](c_2, c'_2) \rightarrow D_{c'_1, c'_2}^{(2)},$$

of degree d which preserves the energy filtration.

Let

$$\begin{aligned} \widehat{\mathbf{f}}_{c'_1, c'_2} &: \bigoplus_{c_1, c_2} B\mathcal{C}_1[1](c'_1, c_1) \widehat{\otimes} D_{c_1, c_2}^{(1)} \widehat{\otimes} B\mathcal{C}_2[1](c_2, c'_2) \\ &\rightarrow \bigoplus_{c_1, c_2} B\mathcal{C}_1[1](c'_1, c_1) \widehat{\otimes} D_{c_1, c_2}^{(2)} \widehat{\otimes} B\mathcal{C}_2[1](c_2, c'_2), \end{aligned} \quad (5.22)$$

be the formal bi-comodule homomorphism induced from $\mathbf{f}_{c'_1, c_1, c_2, c'_2}$. More explicitly the map (5.22) is defined by

$$\widehat{\mathbf{f}}_{c'_1, c'_2}(\mathbf{x}, z, \mathbf{y}) := \sum_{a_1} \sum_{a_2} (-1)^{*} \mathbf{x}_{1:a_1} \otimes \mathbf{f}(\mathbf{x}_{2:a_1} z, \mathbf{y}_{1:a_2}) \otimes \mathbf{y}_{2:a_2},$$

where $* = \deg \mathbf{f} \deg' \mathbf{x}_{1:a_1} = \mathfrak{d}\mathbf{e}\mathbf{g}' \mathbf{f} \deg' \mathbf{x}_{1:a_1}$. (Note that $\mathfrak{d}\mathbf{e}\mathbf{g}' \mathbf{f} = \deg \mathbf{f}$. See Definition 2.15.)

We define a pre-bi-module homomorphism $d(\mathbf{f})$ of degree $\deg \mathbf{f} + 1$, so that

$$\widehat{d(\mathbf{f})} := \widehat{\mathbf{n}} \circ \widehat{\mathbf{f}} - (-1)^{\deg \widehat{\mathbf{f}}} \widehat{\mathbf{f}} \circ \widehat{\mathbf{n}} \quad (5.23)$$

holds.

We say a pre-bi-module homomorphism \mathbf{f} is a bi-module homomorphism if its degree is 0 and if $d(\mathbf{f}) = 0$.

When $\mathbf{g} = \{\mathbf{g}_{c'_1, c_1, c_2, c'_2}\}$ is another pre-bimodule homomorphism, we define $\mathbf{g} \circ \mathbf{f}$ so that

$$\widehat{\mathbf{g} \circ \mathbf{f}} = \widehat{\mathbf{g}} \circ \widehat{\mathbf{f}}.$$

◇

Note that $d(\mathbf{f}) = 0$ is equivalent to

$$\begin{aligned} &\sum_{a_1} \sum_{a_2} \mathbf{n}(\mathbf{x}_{1:a_1}, \mathbf{f}(\mathbf{x}_{2:a_1}, z, \mathbf{y}_{1:a_2}), \mathbf{y}_{2:a_2}) \\ &= \mathbf{f}(\widehat{d}_1(\mathbf{x}), z, \mathbf{y}) + (-1)^{\deg' \mathbf{x} + \deg z} \mathbf{f}(\mathbf{x}, z, \widehat{d}_2(\mathbf{y})) \\ &\quad + \sum_{a_1} \sum_{a_2} (-1)^{\deg' \mathbf{x}_{1:a_1}} \mathbf{f}(\mathbf{x}_{1:a_1}, \mathbf{n}(\mathbf{x}_{2:a_1}, z, \mathbf{y}_{1:a_2}), \mathbf{y}_{2:a_2}). \end{aligned} \quad (5.24)$$

Definition 5.12. We define a DG-category $BIMOD(\mathcal{C}_1, \mathcal{C}_2)$ as follows:

- (1) Its object is a left- \mathcal{C}_1 , right- \mathcal{C}_2 filtered bi-module.

- (2) For two objects \mathcal{D}_1 and \mathcal{D}_2 a morphism from \mathcal{D}_1 to \mathcal{D}_2 is a pre-filtered A_∞ -bimodule homomorphism. We write it as $\mathcal{B}LMOD(\mathcal{D}_1, \mathcal{D}_2)$.
- (3) The composition and the differential of $\mathcal{B}LMOD(\mathcal{C}_1, \mathcal{C}_2)$ are defined as in Definition 5.11.

◇

It is obvious from definition that $\mathcal{B}LMOD(\mathcal{C}_1, \mathcal{C}_2)$ is a DG-category.

Definition 5.13. In Definitions 5.10, 5.11, we can define G -gapped-ness and/or unitality of bi-module and/or bi-module homomorphism in an obvious way if \mathcal{C}_i is G -gapped and/or unital for $i = 1, 2$. ◇

We next explain the relation between a filtered A_∞ bi-module and a bi-functor. We need a digression for this purpose.

Definition 5.14. Let $\mathcal{C}_1, \mathcal{C}_2, \mathcal{C}_3$ be strict non-unital curved filtered A_∞ categories. We will define bijections between the following three objects.

- (1) A filtered A_∞ bi-functor $\mathcal{F} : \mathcal{C}_1 \times \mathcal{C}_2 \rightarrow \mathcal{C}_3$.
- (2) A filtered A_∞ bi-functor $\mathcal{F} : \mathcal{C}_2 \times \mathcal{C}_1 \rightarrow \mathcal{C}_3$.
- (3) A filtered A_∞ functor: $\mathcal{G} : \mathcal{C}_1 \rightarrow \mathcal{F}UNC(\mathcal{C}_2, \mathcal{C}_3)$.

The bijection between (1) and (2) is constructed by using the isomorphism

$$\begin{aligned} \mathcal{S} : B_{k_1} \mathcal{C}_1[1]((c_{1,1}, c_{1,2}) \hat{\otimes} B_{k_2} \mathcal{C}_2[1]((c_{2,1}, c_{2,2})) \\ \rightarrow B_{k_2} \mathcal{C}_2[1]((c_{2,1}, c_{2,2}) \hat{\otimes} B_{k_1} \mathcal{C}_1[1]((c_{1,1}, c_{1,2})), \end{aligned}$$

which is $\mathcal{S}(\mathbf{x} \otimes \mathbf{y}) = (-1)^{\deg' \mathbf{x} \deg' \mathbf{y}} \mathbf{y} \otimes \mathbf{x}$.

We next construct bijection between (1) and (3).

Suppose \mathcal{F} is given as in (1). Let $c_1 \in \mathfrak{D}\mathfrak{B}(\mathcal{C}_1)$. We first construct $\mathcal{G}_{ob}(c_1)$ which is a filtered A_∞ functor: $\mathcal{C}_2 \rightarrow \mathcal{C}_3$. Let $c_2 \in \mathfrak{D}\mathfrak{B}(\mathcal{C}_2)$. Then we put

$$(\mathcal{G}_{ob}(c_1))_{ob}(c_2) = \mathcal{F}_{ob}(c_1, c_2) \in \mathfrak{D}\mathfrak{B}(\mathcal{C}_3).$$

Let $c_{2,1}, c_{2,2} \in \mathfrak{D}\mathfrak{B}(\mathcal{C}_2)$. We define

$$(\mathcal{G}_{ob}(c_1))_{k_2}(c_{2,1}, c_{2,2}) : B_{k_2} \mathcal{C}_2[1](c_{2,1}, c_{2,2}) \rightarrow \mathcal{C}_3[1](\mathcal{F}_{ob}(c_1, c_{2,1}), \mathcal{F}_{ob}(c_1, c_{2,2}))$$

by

$$(\mathcal{G}_{ob}(c_1))_{k_2}(c_{2,1}, c_{2,2})(\mathbf{y}) = \mathcal{F}(c_1, c_1; c_{2,1}, c_{2,2})_{0, k_2}(1, \mathbf{y})$$

where

$$1 \in B_0 \mathcal{C}_1[1](c_1, c_1) = \Lambda_0, \quad \mathbf{y} \in B_{k_2} \mathcal{C}_2[1](c_{2,1}, c_{2,2}).$$

We thus defined $\mathcal{G}_{ob}(c_1)$, which is a filtered A_∞ functor: $\mathcal{C}_2 \rightarrow \mathcal{C}_3$.

Let $c_{1,1}, c_{1,2} \in \mathfrak{D}\mathfrak{B}(\mathcal{C}_1)$ and $\mathbf{x} \in B_{k_1} \mathcal{C}_1[1](c_{1,1}, c_{1,2})$.

We will construct $\mathcal{G}_{k_1}(c_{1,1}, c_{1,2})(\mathbf{x})$, which is a pre-natural transformation from $\mathcal{G}_{ob}(c_{1,1})$ to $\mathcal{G}_{ob}(c_{1,2})$.

Let $c_{2,1}, c_{2,2} \in \mathfrak{D}\mathfrak{B}(\mathcal{C}_2)$ and $\mathbf{y} \in B_{k_2} \mathcal{C}_2[1](c_{2,1}, c_{2,2})$. Then

$$\begin{aligned} (\mathcal{G}_{k_1}(c_{1,1}, c_{1,2})(\mathbf{x}))_{k_2}(c_{2,1}, c_{2,2}) : B_{k_2} \mathcal{C}_2[1](c_{2,1}, c_{2,2}) \\ \rightarrow \mathcal{C}_3[1](\mathcal{F}_{ob}(c_{1,1}, c_{2,1}), \mathcal{F}_{ob}(c_{1,2}, c_{2,2})) \end{aligned}$$

is defined by

$$(\mathcal{G}_{k_1}(c_{1,1}, c_{1,2})(\mathbf{x}))_{k_2}(c_{2,1}, c_{2,2})(\mathbf{y}) = \mathcal{F}_{k_1, k_2}(c_{1,1}, c_{1,2}; c_{2,1}, c_{2,2})(\mathbf{x}, \mathbf{y}).$$

It is straightforward to check that \mathcal{G} is a filtered A_∞ functor.

The construction from (3) to (1) can be done by doing the same construction in the opposite direction. ◇

Example 5.15. Let $\mathcal{F} : \mathcal{C}^{\text{op}} \times \mathcal{C} \rightarrow \mathcal{CH}$ be the filtered A_∞ bi-functor in Example 5.6. Then by Definition 5.14 we obtain a filtered A_∞ functor $\mathcal{C} \rightarrow \text{FUNC}(\mathcal{C}^{\text{op}}, \mathcal{CH})$. This is nothing but the A_∞ Yoneda functor. \diamond

Lemma 5.16. *In the situation of Definition 5.14, there exists an equivalence of A_∞ categories*

$$\text{FUNC}(\mathcal{C}_1, \text{FUNC}(\mathcal{C}_2, \mathcal{C}_3)) \rightarrow \text{FUNC}(\mathcal{C}_2, \text{FUNC}(\mathcal{C}_1, \mathcal{C}_3)).$$

\diamond

Proof. The proof is similar to the above construction and is a straightforward calculation. \square

Using Lemma 5.16 and Definition 5.14, we obtain a filtered A_∞ category so that its object is a filtered A_∞ bi-functor: $\mathcal{C}_1 \times \mathcal{C}_2 \rightarrow \mathcal{C}_3$. This filtered A_∞ category is equivalent to $\text{FUNC}(\mathcal{C}_1, \text{FUNC}(\mathcal{C}_2, \mathcal{C}_3))$ by definition. We denote this filtered A_∞ category by $\text{BIFUNC}(\mathcal{C}_1 \times \mathcal{C}_2, \mathcal{C}_3)$. A morphism between two filtered A_∞ bi-functors in this category is called a pre-natural transformation. It is called a natural transformation if its \mathbf{m}_1 derivative is zero.

Note that during the discussion of Definition 5.14-Lemma 5.16 we required the filtered A_∞ categories to be strict.

Lemma 5.17. *In the situation of Definitions 5.10, 5.11 we assume \mathcal{C}_i is strict for $i = 1, 2$. Then there exists an equivalence of DG-categories*

$$\text{BIFUNC}(\mathcal{C}_1^{\text{op}} \times \mathcal{C}_2, \mathcal{CH}) \cong \text{BIMOD}(\mathcal{C}_1, \mathcal{C}_2).$$

\diamond

Proof. In the same way as Example 5.3 we can find a bijection between the sets of bi-modules and of bi-functors appearing as objects of the above two categories. The fact that morphisms and structure operations coincide can be proved by a similar straightforward calculations. \square

Remark 5.18. Note that in the case when $\mathcal{C}_1, \mathcal{C}_2$ are curved the author does not know the way to define a filtered A_∞ category $\text{BIFUNC}(\mathcal{C}_1 \times \mathcal{C}_2, \mathcal{C}_3)$. Only in the case when $\mathcal{C}_3 = \mathcal{CH}$ we can use the notion of bi-module to define DG-category equivalent to $\text{BIFUNC}(\mathcal{C}_1 \times \mathcal{C}_2, \mathcal{CH})$ for curved categories $\mathcal{C}_1, \mathcal{C}_2$. The functor category in the curved case is defined in [DL], which may be adapted to the bi-functor case.

The next lemma is an analogue of Lemma 5.8.

Lemma 5.19. *Let $\mathcal{C}_1, \mathcal{C}_2$ be non-unital curved filtered A_∞ categories and $\mathcal{C}_1^s, \mathcal{C}_2^s$ their associated strict categories.*

Then a left- \mathcal{C}_1 and right- \mathcal{C}_2 filtered A_∞ bi-module $\mathcal{D} = (\{D_{c_1, c_2}\}, \{\mathbf{n}_{c'_1, c_1, c_2, c'_2}\})$ induces a left- \mathcal{C}_1^s and right- \mathcal{C}_2^s filtered A_∞ bi-functor \mathcal{D}^s . If \mathcal{D} is unital or G -gapped, then so is \mathcal{D}^s .

If $\mathcal{D}_1, \mathcal{D}_2$ are left- \mathcal{C}_1 and right- \mathcal{C}_2 filtered A_∞ bi-modules and \mathfrak{f} is a pre-filtered A_∞ bi-module homomorphism from \mathcal{D}_1 to \mathcal{D}_2 . Then we can associate a pre-filtered bi-module homomorphism \mathfrak{f}^s from \mathcal{D}_1^s to \mathcal{D}_2^s . It induces a DG-functor from $\text{BIMOD}(\mathcal{C}_1, \mathcal{C}_2)$ to $\text{BIMOD}(\mathcal{C}_1^s, \mathcal{C}_2^s)$. \diamond

Proof. The proof is the same as the proof of Lemma 5.8. In fact we can take:

$$D_{(c_1, b_1), (c_2, b_2)}^s := D_{c_1, c_2},$$

and

$$\mathfrak{n}^s(x_1, \dots, x_k; z; y_1, \dots, y_\ell) := \mathfrak{n}(e^b, x_1, e^b, \dots, e^b, x_k, e^b; z; e^b, y_1, e^b, \dots, e^b, y_\ell, e^b).$$

The proof of the statement on pre-filtered A_∞ bi-module homomorphism can be proved in the same way as [FOOO1, Subsection 5.2.2.3] \square

We next discuss a composition of A_∞ (bi)-functors and pullback of bi-module by A_∞ (bi)-functors. To discuss them systematically we introduce the notion of a multi- A_∞ functor.

Definition 5.20. Let m be a positive integer and let \mathcal{C}_i , $i = 1, \dots, m$ and \mathcal{C}' be non-unital curved filtered A_∞ categories. A *filtered A_∞ multi-functor* $\mathcal{F} : \mathcal{C}_1 \times \dots \times \mathcal{C}_m \rightarrow \mathcal{C}'$ consists of \mathcal{F}_{ob} and $\mathcal{F}_{k_1, \dots, k_m}$ ($k_i = 0, 1, 2, 3, \dots$) of degree 0 such that:

- (1) A map: $\mathcal{F}_{ob} : \prod_{i=1}^m \mathfrak{OB}(\mathcal{C}_i) \rightarrow \mathfrak{OB}(\mathcal{C}')$ is given.
- (2) Let $c_{i,1}, c_{i,2} \in \mathfrak{OB}(\mathcal{C}_i)$ ($i = 1, \dots, m$). We put $\vec{c}_j = (c_{1,j}, \dots, c_{m,j})$, for $j = 1, 2$. $\mathcal{F}_{k_1, \dots, k_m}$ associates a Λ_0 linear map

$$\mathcal{F}_{k_1, \dots, k_m}(\vec{c}_1; \vec{c}_2) : \bigotimes_{i=1}^m B_{k_i} \mathcal{C}_i[1](c_{i,1}, c_{i,2}) \rightarrow \mathcal{C}'[1](\mathcal{F}_{ob}(\vec{c}_1), \mathcal{F}_{ob}(\vec{c}_2))$$

of degree 0.

- (3) We require that $\mathcal{F}_{k_1, \dots, k_m}(\vec{c}_1; \vec{c}_2)$ preserves the filtration in a similar sense as Definition 2.2 (2).

$\{\mathcal{F}_{k_1, \dots, k_m}\}$ induces uniquely a formal coalgebra homomorphism

$$\widehat{\mathcal{F}}(\vec{c}_1; \vec{c}_2) : \bigotimes_{i=1}^3 B_{\mathcal{C}_i}[1](c_{i,1}, c_{i,2}) \rightarrow B_{\mathcal{C}'}[1](\mathcal{F}_{ob}(\vec{c}_1), \mathcal{F}_{ob}(\vec{c}_2)).$$

Note that the structure operations of \mathcal{C}_i induces a coderivation $\hat{d}_i : B_{\mathcal{C}_i}[1](c_{i,1}, c_{i,2}) \rightarrow B_{\mathcal{C}_i}[1](c_{i,1}, c_{i,2})$.

- (4) The homomorphism $\widehat{\mathcal{F}}(\vec{c}_1; \vec{c}_2)$ is a cochain map.

The unitality, strictness, G -gapped-ness of multi-functor are defined in the same way.

In the case when $m = 3$ the multi-functor is called the tri-functor. \diamond

Lemma 5.21. *A filtered A_∞ multi-functor \mathcal{F} induces a strict filtered A_∞ multi-functor \mathcal{F}^s among the associated strict categories. The unitality and/or G -gapped-ness is preserved. \diamond*

The proof is the same as Lemma 5.8 and is omitted.

Let $\mathcal{C}_1, \dots, \mathcal{C}_m$ and $\mathcal{C}'_1, \dots, \mathcal{C}'_{m'}$ be non-unital filtered A_∞ categories and $\mathcal{F} : \mathcal{C}_1 \times \dots \times \mathcal{C}_m \rightarrow \mathcal{C}'_k$ and $\mathcal{G} : \mathcal{C}'_1 \times \dots \times \mathcal{C}'_\ell \rightarrow \mathcal{C}''$ be A_∞ multi-functors. We define its *composition*

$$\mathcal{G} \circ \mathcal{F} : \mathcal{C}'_1 \times \dots \times \mathcal{C}'_{k-1} \times \mathcal{C}_1 \times \dots \times \mathcal{C}_m \times \mathcal{C}'_{k+1} \times \dots \times \mathcal{C}'_\ell \rightarrow \mathcal{C}''$$

by

$$\begin{aligned} & (\mathcal{G} \circ \mathcal{F})(\mathbf{x}_1 \otimes \dots \otimes \mathbf{x}_{k-1} \otimes \mathbf{y}_1 \otimes \dots \otimes \mathbf{y}_m \otimes \mathbf{x}_{k+1} \otimes \dots \otimes \mathbf{x}_\ell) \\ &= \mathcal{G}(\mathbf{x}_1 \otimes \dots \otimes \mathbf{x}_{k-1} \otimes \mathcal{F}(\mathbf{y}_1 \otimes \dots \otimes \mathbf{y}_m) \otimes \mathbf{x}_{k+1} \otimes \dots \otimes \mathbf{x}_\ell). \end{aligned} \quad (5.25)$$

It is easy to check that (5.25) defines a multi-functor.

Lemma 5.22. *Suppose $\mathcal{C}_1, \dots, \mathcal{C}_m$ and \mathcal{C}' are strict. Then, we can define a filtered A_∞ categories $MULFUNC(\mathcal{C}_1 \times \dots \times \mathcal{C}_m, \mathcal{C}')$ such that:*

- (1) *Its object is a filtered A_∞ multi-functor $\mathcal{F} : \mathcal{C}_1 \times \dots \times \mathcal{C}_m \rightarrow \mathcal{C}'$.*
- (2) *There exists a filtered A_∞ bi-functor*

$$\begin{aligned} & MULFUNC(\mathcal{C}_1 \times \dots \times \mathcal{C}_m, \mathcal{C}'') \times MULFUNC(\mathcal{C}'_1 \times \dots \times \mathcal{C}'_{m'}, \mathcal{C}_k) \\ & \rightarrow MULFUNC(\mathcal{C}_1 \times \dots \times \mathcal{C}_{k-1} \times \mathcal{C}'_1 \times \dots \times \mathcal{C}'_{m'} \times \mathcal{C}_{k+1} \times \dots \times \mathcal{C}_m, \mathcal{C}'') \end{aligned}$$

such that $(\mathcal{F}, \mathcal{G}) \mapsto \mathcal{G} \circ \mathcal{F}$ is its object part.

◇

The proof of (1) is straightforward. (2) is a straightforward generalization of Theorem 10.1.

Now it is rather obvious how to define the notion of multi-module over (curved) filtered A_∞ categories and define the notion of a pull back of a multi-module structure by multi-functor. We explain it below since we will use it.

Definition 5.23. Let $\mathcal{C}_{l,1}, \dots, \mathcal{C}_{l,m}$ and $\mathcal{C}_{r,1}, \dots, \mathcal{C}_{r,m'}$ be non-unital filtered A_∞ categories. A left- $\mathcal{C}_{l,1}, \dots, \mathcal{C}_{l,m}$ and right- $\mathcal{C}_{r,1}, \dots, \mathcal{C}_{r,m'}$ filtered A_∞ multi-module, is $(\{D_{\vec{c}_l, \vec{c}_r}\}, \{\mathfrak{n}_{\vec{c}_l, \vec{c}_l, \vec{c}_r, \vec{c}_r}\})$, where:

- (1) To each $\vec{c}_l \in \prod_{i=1}^{m_l} \mathfrak{D}\mathfrak{B}(\mathcal{C}_{j,l})$, $\vec{c}_r \in \prod_{i=1}^{m_r} \mathfrak{D}\mathfrak{B}(\mathcal{C}_{j,r})$, a graded completed free Λ_0 module $D_{\vec{c}_l, \vec{c}_r}$ is assigned.
- (2) To each $\vec{c}_l, \vec{c}'_l \in \prod_{i=1}^{m_l} \mathfrak{D}\mathfrak{B}(\mathcal{C}_{j,l})$, $\vec{c}_r, \vec{c}'_r \in \prod_{i=1}^{m_r} \mathfrak{D}\mathfrak{B}(\mathcal{C}_{j,r})$ we are given a Λ_0 module homomorphism

$$\mathfrak{n}_{\vec{c}_l, \vec{c}'_l, \vec{c}_r, \vec{c}'_r} : \bigotimes_{j=1}^{m_l} B\mathcal{C}_1(c'_{j,l}, c_{j,l}) \widehat{\otimes} D_{\vec{c}_l, \vec{c}_r} \widehat{\otimes} \bigotimes_{j=1}^{m_r} B\mathcal{C}_r(c_{j,r}, c'_{j,r}) \rightarrow D_{\vec{c}'_l, \vec{c}'_r},$$

of degree +1 which preserves the energy filtration.

The unitality and/or gapped-ness of multi-module over unital and/or gapped categories are defined in an obvious way.

When $\mathcal{D}^\ell = (\{D_{\vec{c}_l, \vec{c}_r}^\ell\}, \{\mathfrak{n}_{\vec{c}_l, \vec{c}_l, \vec{c}_r, \vec{c}_r}^\ell\})$ is a left- $\mathcal{C}_{l,1}, \dots, \mathcal{C}_{l,m}$ and right- $\mathcal{C}_{r,1}, \dots, \mathcal{C}_{r,m'}$ filtered A_∞ multi-module for $\ell = 1, 2$, a multi-module pre-homomorphism from \mathcal{D}^1 to \mathcal{D}^2 of degree d is $\mathfrak{f} = \{\mathfrak{f}_{\vec{c}_l, \vec{c}_r}\}$ where the map $\mathfrak{f}_{\vec{c}_l, \vec{c}_r}$,

$$\mathfrak{f}_{\vec{c}_l, \vec{c}'_l, \vec{c}_r, \vec{c}'_r} : \bigotimes_{j=1}^{m_l} B\mathcal{C}_1(c'_{j,l}, c_{j,l}) \widehat{\otimes} D_{\vec{c}_l, \vec{c}_r}^1 \widehat{\otimes} \bigotimes_{j=1}^{m_r} B\mathcal{C}_r(c_{j,r}, c'_{j,r}) \rightarrow D_{\vec{c}'_l, \vec{c}'_r}^2,$$

is a degree d Λ_0 module homomorphism which preserves filtration.

The maps \mathfrak{f} induces a formal bi-comodule homomorphism

$$\begin{aligned} \widehat{\mathfrak{f}}_{\vec{c}_l, \vec{c}_r} & : \bigoplus_{c'_{j,l}, c'_{j,r}} \bigotimes_{j=1}^{m_l} B\mathcal{C}_1(c'_{j,l}, c_{j,l}) \widehat{\otimes} D_{\vec{c}_l, \vec{c}_r}^1 \bigotimes_{j=1}^{m_r} B\mathcal{C}_r(c'_{j,r}, c_{j,r}) \\ & \rightarrow \bigotimes_{j=1}^{m_l} B\mathcal{C}_1(c'_{j,l}, c_{j,l}) \widehat{\otimes} D_{\vec{c}_l, \vec{c}_r}^2 \bigotimes_{j=1}^{m_r} B\mathcal{C}_r(c'_{j,r}, c_{j,r}), \end{aligned}$$

in the same way as Definition 5.20 (1).

We define $d\mathfrak{f} = \{(d\mathfrak{f})_{\vec{c}_l, \vec{c}_r}\}$ by

$$(d\mathfrak{f})_{\vec{c}_l, \vec{c}_r} = \widehat{\mathfrak{n}}_{\vec{c}_l, \vec{c}_r}^2 \circ \widehat{\mathfrak{f}}_{\vec{c}_l, \vec{c}_r} - (-1)^{\deg \widehat{\mathfrak{f}}_{\vec{c}_l, \vec{c}_r}} \widehat{\mathfrak{n}}_{\vec{c}_l, \vec{c}_r}^1 \circ \widehat{\mathfrak{f}}_{\vec{c}_l, \vec{c}_r}.$$

Here $\hat{n}_{\vec{c}_l, \vec{c}_r}^\ell$ is the boundary operator induced from the structure operations of \mathcal{D}^ℓ as in item (3) above.

When \mathfrak{f} (resp. \mathfrak{g}) is a multi-module pre-homomorphism from \mathcal{D}^1 to \mathcal{D}^2 (resp. \mathcal{D}^2 to \mathcal{D}^3), we define a multi-module pre-homomorphism $\mathfrak{f} \circ \mathfrak{g}$ from \mathcal{D}^1 to \mathcal{D}^3 by $\widehat{\mathfrak{f} \circ \mathfrak{g}} = \widehat{\mathfrak{f}} \circ \widehat{\mathfrak{g}}$.

Thus we obtain the following filtered DG-category.

- (1) Its object is a left- $\mathcal{C}_{l,1}, \dots, \mathcal{C}_{l,m}$ and right- $\mathcal{C}_{r,1}, \dots, \mathcal{C}_{r,m'}$ filtered A_∞ multi-module.
- (2) The module of morphisms is the set of multi-module pre-homomorphisms.
- (3) The differential d and composition \circ is defined as above.

The unitality and/or gapped-ness of a multi-module homomorphism is defined in an obvious way. \diamond

To a left- $\mathcal{C}_{l,1}, \dots, \mathcal{C}_{l,m}$ and right- $\mathcal{C}_{r,1}, \dots, \mathcal{C}_{r,m'}$ filtered A_∞ multi-module \mathcal{D} we can associate a left- $\mathcal{C}_{l,1}^s, \dots, \mathcal{C}_{l,m}^s$ and right- $\mathcal{C}_{r,1}^s, \dots, \mathcal{C}_{r,m'}^s$ filtered A_∞ multi-module \mathcal{D}^s in the same way as Lemma 5.21.

If $\mathcal{C}_{l,1}, \dots, \mathcal{C}_{l,m}$ and $\mathcal{C}_{r,1}, \dots, \mathcal{C}_{r,m'}$ are strict then there exists a bijection between the set of all the left- $\mathcal{C}_{l,1}, \dots, \mathcal{C}_{l,m}$ and right- $\mathcal{C}_{r,1}, \dots, \mathcal{C}_{r,m'}$ filtered A_∞ multi-modules \mathcal{D} and the set of all the filtered A_∞ multi-functors

$$\mathcal{F} : \mathcal{C}_{l,1}^{\text{op}} \times \dots \times \mathcal{C}_{l,m}^{\text{op}} \times \mathcal{C}_{r,1} \times \dots \times \mathcal{C}_{r,m'} \rightarrow \mathcal{CH}.$$

Moreover the set of multi-module homomorphisms can be identified with the set of natural transformations in the category defined in Lemma 5.22.

Let $\mathcal{C}_{l,1}, \dots, \mathcal{C}_{l,m}$, $\mathcal{C}_{r,1}, \dots, \mathcal{C}_{r,m_r}$ and $\mathcal{C}'_{1,l}, \dots, \mathcal{C}'_{1,m'}$ be non-unial curved filtered A_∞ categories and $\mathcal{F} : \mathcal{C}_1 \times \dots \times \mathcal{C}_m \rightarrow \mathcal{C}'_k$ be a multi-functor. Let \mathcal{D} be a left $\mathcal{C}'_{1,l}, \dots, \mathcal{C}'_{1,m'}$ and right $\mathcal{C}_{r,1}, \dots, \mathcal{C}_{r,m_r}$ multi-module. Then we can pull back \mathcal{D} by \mathcal{F} and obtain a left $\mathcal{C}'_{1,l}, \dots, \mathcal{C}'_{1,k-1}, \mathcal{C}_{l,1}, \dots, \mathcal{C}_{l,m}$, $\mathcal{C}'_{1,k+1}, \dots, \mathcal{C}'_{1,m'}$ and right $\mathcal{C}_{r,1}, \dots, \mathcal{C}_{r,m_r}$ bi-module, which we denote $\mathcal{F}^* \mathcal{D}$. We can perform a similar construction for A_∞ categories which act from right. This construction commutes with the process to associate \mathcal{D}^s to \mathcal{D} .

In the strict case, the above construction coincides with the composition of multi-functors via the identification between a multi-functor to \mathcal{CH} and a multi-module.

5.2. A geometric realization of an A_∞ tri-module 1.

Situation 5.24. Let $(X_1, \omega_1), (X_2, \omega_2)$ be symplectic manifolds and V_i an oriented real vector bundle on the 3-skeleton $(X_i)_{[3]}$ of X_i , for $i = 1, 2$. (Namely V_i is a background datum in the sense of Definition 3.4.)

We consider a clean collection \mathbb{L}_1 (resp. \mathbb{L}_2) of V_1 (resp. V_2) relatively spin oriented and immersed Lagrangian submanifolds of X_i . (See Situation 3.45.)

We also take a finite set \mathbb{L}_{12} of $\pi_1^*(V_1 \oplus TX_1) \oplus \pi_2^*V_2$ relatively spin oriented and immersed Lagrangian submanifolds of $-X_1 \times X_2$ that have clean intersection.

We also assume that $L_1 \times L_2$ has clean intersection with L_{12} when $L_i \in \mathbb{L}_i$, $L_{12} \in \mathbb{L}_{12}$. \diamond

In this subsection and the next we will prove the following theorem.

Theorem 5.25. *There exists a left- $\mathfrak{Fuk}(X_1, V_1, \mathbb{L}_1)$, $\mathfrak{Fuk}(-X_1 \times X_2, \pi_1^*(V_1 \oplus TX_1) \oplus \pi_2^*V_2, \mathbb{L}_{12})$ and right- $\mathfrak{Fuk}(X_2, V_2, \mathbb{L}_2)$ filtered A_∞ tri-module $\mathcal{CF}(\mathbb{L}_1, \mathbb{L}_{12}; \mathbb{L}_2)$. It is unital and gapped.*

We call it the correspondence tri-module. \diamond

Remark 5.26. We consider associated tri-module²⁷ (see Lemma 5.19) over strict categories $\mathfrak{Futst}(X_1, V_1, \mathbb{L}_1)$, $\mathfrak{Futst}(-X_1 \times X_2, \pi_1^*(V_1 \oplus TX_1) \oplus \pi_2^*V_2, \mathbb{L}_{12})$, $\mathfrak{Futst}(X_1, V_1, \mathbb{L}_1)$. Then for objects (L_1, b_1) , (L_{12}, b_{12}) , (L_2, b_2) of those categories, the tri-module of Theorem 5.25 induces a chain complex

$$CF((L_1, b_1), (L_{12}, b_{12}); (L_2, b_2)).$$

Its cohomology is isomorphic to the Floer cohomology of $HF((L_{12}, b_{12}); (L_1 \times L_2, b_1 \times b_2))$. This fact will be proved in Section 16. (See Theorem 16.17.) The product $b_1 \times b_2$ of bounding cochains is defined in Proposition 16.11. \diamond

Proof. The proof of Theorem 5.25 occupies this and the next subsections. In the same way as Subsection 3.5, it suffices to consider the case when \mathbb{L}_1 , \mathbb{L}_2 , \mathbb{L}_{12} consist of single immersed Lagrangian submanifolds L_1 , L_2 and L_{12} , respectively, and construct structure operations:

$$\mathfrak{n} : BCF[1](L_1) \otimes_{\Lambda_0} BCF[1](L_{12}) \otimes D[1] \otimes_{\Lambda_0} BCF[1](L_2) \rightarrow D[1] \quad (5.26)$$

for a certain graded completed free Λ_0 module D , such that they satisfy A_∞ relation.²⁸

The construction of \mathfrak{n} uses certain compactified moduli spaces $\mathcal{M}_{\text{QT}}(\vec{a}_1, \vec{a}_{12}, \vec{a}_2; a_-, a_+; E)$ of pseudo-holomorphic quilts, which will be defined in Definition 5.40. We will define it in three steps.

We first define $\overset{\circ}{\mathcal{M}}_{\text{QT}}(\vec{a}_1, \vec{a}_{12}, \vec{a}_2; a_-, a_+; E)$ in Definition 5.27. This moduli space is the set of pseudo-holomorphic quilts which do not contain disk bubbles and are not split into several quilts. (See Figure 15.) It contains objects with sphere bubbles.

We then include objects with disk bubbles and define $\overset{\circ}{\mathcal{M}}_{\text{QT}}(\vec{a}_1, \vec{a}_{12}, \vec{a}_2; a_-, a_+; E)$ in Definition 5.37.

Finally we include the process where a sequence of a pseudo-holomorphic quilts splits into several pseudo-holomorphic quilts in the limit and define $\mathcal{M}_{\text{QT}}(\vec{a}_1, \vec{a}_{12}, \vec{a}_2; a_-, a_+; E)$ in Definition 5.40. The detail will follow.

We decompose the fiber products into connected components

$$L_i(+) = \tilde{L}_i \times_{X_i} \tilde{L}_i = \tilde{L}_i \sqcup \coprod_{a \in \mathcal{A}_{L_i}} L_i(a)$$

for $i = 1, 2$, and

$$L_{12}(+) = \tilde{L}_{12} \times_{X_1 \times X_2} \tilde{L}_{12} = \tilde{L}_{12} \sqcup \coprod_{a \in \mathcal{A}_{L_{12}}} L_{12}(a).$$

See Definition 3.2 (5). We also decompose

$$R = (\tilde{L}_1 \times \tilde{L}_2) \times_{X_1 \times X_2} \tilde{L}_{12} = \coprod_{a \in \mathcal{A}_R} R(a).$$

Let $\vec{a}_j = (a_{j,1}, \dots, a_{j,k_j}) \in (\mathcal{A}_{L_j}^+)^{k_j}$, $\vec{a}_{12} = (a_{12,1}, \dots, a_{12,k}) \in (\mathcal{A}_{L_{12}}^+)^k$, $a_+, a_- \in \mathcal{A}_R$ and $E \in \mathbb{R}_{\geq 0}$. (Here $\mathcal{A}_{L_{12}}^+ := \mathcal{A}_{L_{12}} \cup \{o\}$ and o is the index of the diagonal component.) Below we identify $\mathbb{R} \times \mathbb{R} \cong \mathbb{C}$ by $(s, t) \mapsto s + \sqrt{-1}t$.

²⁷An A_∞ tri-module is a special case of a multi-module (Definition 5.23), that is a multi-module over three A_∞ categories.

²⁸Here we shifted the degree of elements of D . This is because it is more consistent with the discussion of sign in Section 17.

Definition 5.27. We consider $(\Sigma; \vec{z}_1, \vec{z}_{12}, \vec{z}_2; u_1, u_2; \gamma_1, \gamma_{12}, \gamma_2)$ with the following properties. (See Figure 15.)

- (1) The space Σ is a bordered Riemann surface with $\Sigma \supseteq ([-1, 1] \times \mathbb{R})$. The closure of $\Sigma \setminus ([-1, 1] \times \mathbb{R})$ is a finite union of (maximal) trees of spheres. We call its connected component a *tree of sphere components*. We require that a tree of sphere components intersects with $[-1, 1] \times \mathbb{R}$ at one point, which we call its *root*. All the roots are points of $((-1, 0) \cup (0, 1)) \times \mathbb{R}$.²⁹
- (2) Let Ω_1 (resp. Ω_2) be the union of $[-1, 0] \times \mathbb{R}$ (resp. $[0, +1] \times \mathbb{R}$) and the trees of sphere components rooted on it.

We require the maps $u_1 : \Omega_1 \rightarrow (X_1, J_1)$ and $u_2 : \Omega_2 \rightarrow (X_2, J_2)$ to be pseudo-holomorphic.

- (3) We put $\vec{z}_i = (z_{i,1}, \dots, z_{i,k_i})$ ($i = 1, 2$). Then $z_{1,j} \in \{-1\} \times \mathbb{R}$, $z_{2,j} \in \{1\} \times \mathbb{R}$. $\vec{z}_{12} = (z_{12,1}, \dots, z_{12,k})$, $z_{12,j} \in \{0\} \times \mathbb{R}$.

If $j_1 < j_2$ then $\text{Im}z_{1,j_1} > \text{Im}z_{1,j_2}$, $\text{Im}z_{12,j_1} > \text{Im}z_{12,j_2}$ and $\text{Im}z_{2,j_1} < \text{Im}z_{2,j_2}$. See Remark 5.30 for this enumeration.

We put $|\vec{z}_i| = \{z_{i,1}, \dots, z_{i,k_i}\}$. $|\vec{z}_{12}|$ is defined in the same way.

- (4) The maps $\gamma_1 : (\{-1\} \times \mathbb{R}) \setminus |\vec{z}_1| \rightarrow \tilde{L}_1$, $\gamma_2 : (\{1\} \times \mathbb{R}) \setminus |\vec{z}_2| \rightarrow \tilde{L}_2$, $\gamma_{12} : (\{0\} \times \mathbb{R}) \setminus |\vec{z}_{12}| \rightarrow \tilde{L}_{12}$ are smooth and satisfy

$$\begin{aligned} i_{L_1}(\gamma_1(z)) &= u_1(z) & \text{if } z \in (\{-1\} \times \mathbb{R}) \setminus |\vec{z}_1|, \\ i_{L_2}(\gamma_2(z)) &= u_2(z) & \text{if } z \in (\{1\} \times \mathbb{R}) \setminus |\vec{z}_2|, \\ i_{L_{12}}(\gamma_{12}(z)) &= (u_1(z), u_2(z)) & \text{if } z \in (\{0\} \times \mathbb{R}) \setminus |\vec{z}_{12}|. \end{aligned} \quad (5.27)$$

- (5) At $\vec{z}_1, \vec{z}_2, \vec{z}_{12}$, the maps $\gamma_1, \gamma_2, \gamma_{12}$ satisfy the switching condition, Condition 5.28, below.
- (6) When $z \in [-1, 1] \times \mathbb{R}$, $\text{Im}z \rightarrow \pm\infty$, the maps $u_1(z)$ and $u_2(z)$ satisfy the asymptotic boundary condition Condition 5.29 below.
- (7) The stability condition, Condition 5.31 below, is satisfied.
- (8)

$$\int_{\Omega_1} u_1^* \omega_1 + \int_{\Omega_2} u_2^* \omega_2 = E.$$

In Definition 5.32, we will define an equivalence relation \sim among the objects $(\Sigma; \vec{z}_1, \vec{z}_{12}, \vec{z}_2; u_1, u_2; \gamma_1, \gamma_{12}, \gamma_2)$ satisfying (1)-(8). We denote by $\overset{\circ}{\mathcal{M}}_{\text{QT}}(\vec{a}_1, \vec{a}_{12}, \vec{a}_2; a_-, a_+; E)$ the set of all the equivalence classes of this equivalence relation. \diamond

We next describe three of the conditions in Definition 5.27. We put

$$\partial_1 \Sigma = \{-1\} \times \mathbb{R}, \quad \partial_2 \Sigma = \{1\} \times \mathbb{R}, \quad \partial_{12} \Sigma = \{0\} \times \mathbb{R}. \quad (5.28)$$

We call the line $\{0\} \times \mathbb{R}$ the *seam*. We define the limit

$$p = \lim_{z \in \partial_1 \Sigma, z \downarrow z_{1,j}} \gamma_1(z)$$

as follows. If $z_n, z \in (\{-1\} \times \mathbb{R}) \setminus |\vec{z}_1|$, $\text{Im}z_n > \text{Im}z_{1,j}$ and $\lim_{n \rightarrow \infty} z_n = z_{1,j}$ then $p = \lim_{n \rightarrow \infty} \gamma_1(z_n)$. The notations $\lim_{z \in \partial_1 \Sigma, z \uparrow z_{1,j}}$ etc. are defined in the same way.

The two switching conditions below are analogues of the switching conditions which appeared in the immersed Lagrangian Floer theory. See Definition 3.17 (5) and Figure 5.

Condition 5.28. (Switching condition 1)

²⁹We require that the root is not on $\{0, \pm 1\} \times \mathbb{R}$.

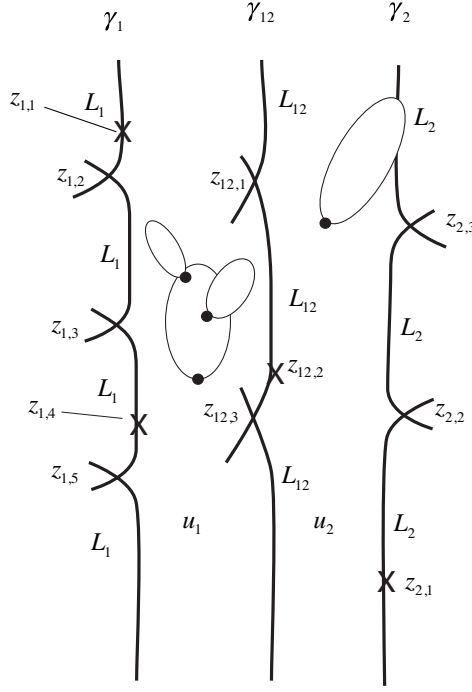
FIGURE 15. An element $\overset{\circ}{\mathcal{M}}_{\text{QT}}(\vec{a}_1, \vec{a}_{12}, \vec{a}_2; a_-, a_+; E)$ (1) For each j

$$\left(\lim_{z \in \partial_1 \Sigma, z \downarrow z_{1,j}} \gamma_1(z), \lim_{z \in \partial_1 \Sigma, z \uparrow z_{1,j}} \gamma_1(z) \right) \in L_1(a_{1,j}).$$

(2) For each j

$$\left(\lim_{z \in \partial_2 \Sigma, z \uparrow z_{2,j}} \gamma_2(z), \lim_{z \in \partial_2 \Sigma, z \downarrow z_{2,j}} \gamma_2(z) \right) \in L_2(a_{2,j}).$$

(3) For each j

$$\left(\lim_{z \in \partial_{12} \Sigma, z \downarrow z_{12,j}} \gamma_{12}(z), \lim_{z \in \partial_{12} \Sigma, z \uparrow z_{12,j}} \gamma_{12}(z) \right) \in L_{12}(a_{12,j}).$$

◇

Condition 5.29. (Switching condition 2)(1) There exists $(p_{+\infty,1}, p_{+\infty,2}) \in R(a_+)$ such that

$$\lim_{\tau \rightarrow +\infty} (\gamma_1(-1 + \tau\sqrt{-1}), \gamma_2(+1 + \tau\sqrt{-1})) = p_{+\infty,1}, \quad \lim_{\tau \rightarrow +\infty} \gamma_{12}(\tau\sqrt{-1}) = p_{+\infty,2}.$$

(2) There exists $(p_{-\infty,1}, p_{-\infty,2}) \in R(a_-)$ such that

$$\lim_{\tau \rightarrow -\infty} (\gamma_1(-1 - \tau\sqrt{-1}), \gamma_2(+1 + \tau\sqrt{-1})) = p_{-\infty,1}, \quad \lim_{\tau \rightarrow -\infty} \gamma_{12}(\tau\sqrt{-1}) = p_{-\infty,2}.$$

See Figure 16. ◇

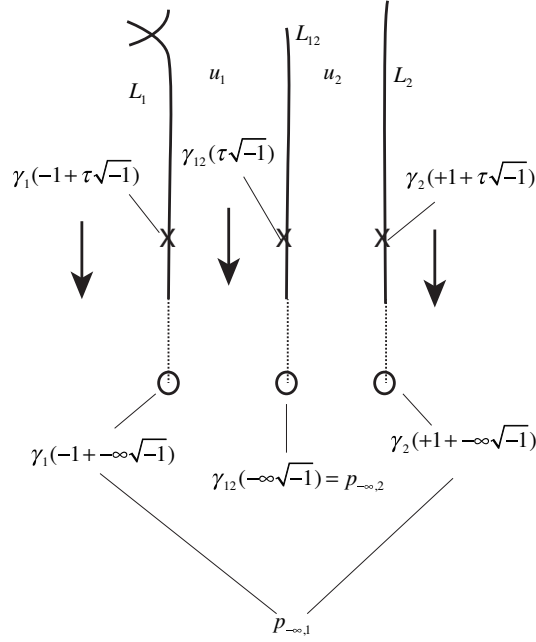

FIGURE 16. Switching condition 2

Remark 5.30. Note that we enumerate the marked points on γ_1 , γ_{12} downward and the marked points on γ_2 upward. This is related to the fact that we are constructing *left* $\mathfrak{Fut}(X_1, V_1, \mathbb{L}_1)$, $\mathfrak{Fut}(-X_1 \times X_2, \pi_1^*(V_1 \oplus TX_1) \oplus \pi_2^*V_2, \mathbb{L}_{12})$ and *right* $\mathfrak{Fut}(X_2, V_2, \mathbb{L}_2)$ filtered A_∞ tri-module. (We also remark the input D corresponds to the end $\tau \rightarrow -\infty$.)

In fact, we write the structure operation of this filtered A_∞ tri-module as

$$\mathbf{n}(x_1, \dots, x_{k_1}; y_1, \dots, y_{k_{12}}; z; w_1, \dots, w_{k_2}).$$

Here x_i corresponds to the evaluation map at the i -th marked point of γ_1 , y_i corresponds to the evaluation map at the i -th marked point of γ_{12} , w_i corresponds to the evaluation map at the i -th marked point of γ_2 . Thus the way we enumerate the marked points is consistent with the way we write the structure operation. \diamond

Condition 5.31. (Stability condition) The set of all the maps $v : \Sigma \rightarrow \Sigma$ satisfying the next conditions is finite.

- (1) The map v is a homeomorphism and is biholomorphic on each of the irreducible components.
- (2) $u_1 \circ v = u_1$, $u_2 \circ v = u_2$.

\diamond

Definition 5.32. We define *evaluation maps*:

$$\begin{aligned} \text{ev} &= (\text{ev}^1, \text{ev}^{12}, \text{ev}^2) = ((\text{ev}_1^1, \dots, \text{ev}_{k_1}^1), (\text{ev}_1^{12}, \dots, \text{ev}_{k_{12}}^{12}), (\text{ev}_1^2, \dots, \text{ev}_{k_2}^2)) \\ &: \overset{\circ\circ}{\mathcal{M}}_{\text{QT}}(\vec{a}_1, \vec{a}_{12}, \vec{a}_2; a_-, a_+; E) \rightarrow \prod_{j=1}^{k_1} L_1(a_{1,j}) \times \prod_{j=1}^{k_{12}} L_{12}(a_{12,j}) \times \prod_{j=1}^{k_2} L_2(a_{2,j}) \end{aligned}$$

and

$$\text{ev}_\infty = (\text{ev}_{\infty,-}, \text{ev}_{\infty,+}) : \overset{\circ}{\mathcal{M}}_{\text{QT}}(\vec{a}_1, \vec{a}_{12}, \vec{a}_2; a_-, a_+; E) \rightarrow R(a_-) \times R(a_+)$$

as follows.

- (1) We use Condition 5.28 (1) to define

$$\begin{aligned} & \text{ev}_j^1(\Sigma; \vec{z}_1, \vec{z}_{12}, \vec{z}_2; u_1, u_2; \gamma_1, \gamma_{12}, \gamma_2) \\ &= \left(\lim_{z \in \partial_1 \Sigma, z \downarrow z_{1,j}} \gamma_1(z), \lim_{z \in \partial_1 \Sigma, z \uparrow z_{1,j}} \gamma_1(z) \right) \in L_1(a_{1,j}). \end{aligned}$$

- (2) We use Condition 5.28 (3) to define

$$\begin{aligned} & \text{ev}_j^{12}(\Sigma; \vec{z}_1, \vec{z}_{12}, \vec{z}_2; u_1, u_2; \gamma_1, \gamma_{12}, \gamma_2) \\ &= \left(\lim_{z \in \partial_{12} \Sigma, z \downarrow z_{12,j}} \gamma_{12}(z), \lim_{z \in \partial_{12} \Sigma, z \uparrow z_{12,j}} \gamma_{12}(z) \right) \in L_{12}(a_{12,j}). \end{aligned}$$

- (3) The evaluation map ev_j^2 is defined in the same way by using Condition 5.28 (2).

- (4) We use Condition 5.29 (1) to define

$$\begin{aligned} & \text{ev}_{\infty,+}(\Sigma; \vec{z}_1, \vec{z}_{12}, \vec{z}_2; u_1, u_2; \gamma_1, \gamma_{12}, \gamma_2) \\ &= \lim_{\tau \rightarrow +\infty} ((\gamma_1(-1 + \tau\sqrt{-1}), \gamma_2(+1 + \tau\sqrt{-1})), \gamma_{12}(\tau\sqrt{-1})). \end{aligned}$$

The definition of $\text{ev}_{\infty,-}$ is similar. We call them *evaluation maps at infinity*.

◇

Definition 5.33. We say $(\Sigma; \vec{z}_1, \vec{z}_{12}, \vec{z}_2; u_1, u_2; \gamma_1, \gamma_{12}, \gamma_2)$ as in Definition 5.27 is *equivalent* to $(\Sigma'; \vec{z}'_1, \vec{z}'_{12}, \vec{z}'_2; u'_1, u'_2; \gamma'_1, \gamma'_{12}, \gamma'_2)$ if there exist $v : \Sigma \rightarrow \Sigma'$ satisfying the next conditions.

- (1) The map v is a homeomorphism and is biholomorphic on each connected component.
- (2) We require $v(\Omega_1) = \Omega'_1$, $v(\Omega_2) = \Omega'_2$. Here Ω'_1 is the union of $[-1, 0] \times \mathbb{R} \subset \Sigma'$ and the trees of sphere components rooted on it. Ω'_2 is defined in the same way.
- (3) $u'_1 \circ v = u_1$, $u'_2 \circ v = u_2$.
- (4) $v(z_{i,j}) = z'_{i,j}$, $v(z_{12,j}) = z'_{12,j}$, where $i = 1, 2$.
- (5) $\gamma'_1 \circ v = \gamma_1$, $\gamma'_2 \circ v = \gamma_2$, $\gamma'_{12} \circ v = \gamma_{12}$.

◇

Remark 5.34. In Floer theory, the moduli space which is used to define the boundary operator is the quotient space by \mathbb{R} action. (This \mathbb{R} action is induced by the translation of the \mathbb{R} direction, which is the second factor of $[-1, 1] \times \mathbb{R}$ in our situation.) The process to take the set of equivalence classes of the equivalence relation in Definition 5.33 includes the process to take the quotient by this \mathbb{R} action. In other words the object $\mathfrak{r} = (\Sigma; \vec{z}_1, \vec{z}_{12}, \vec{z}_2; u_1, u_2; \gamma_1, \gamma_{12}, \gamma_2)$ and $\tau\mathfrak{r}$ which is obtained from \mathfrak{r} by shifting everything by $\tau \in \mathbb{R}$ are equivalent in the sense of Definition 5.33.

There is no mathematical difference between the way we take here and the usual way to take quotient by \mathbb{R} action. They are slightly different ways to describe the same mathematical contents. ◇

In our situation Condition 5.29 is a consequence of the other conditions. More precisely we have the following.

Lemma 5.35. *Let $(\Sigma; \vec{z}_1, \vec{z}_{12}, \vec{z}_2; u_1, u_2; \gamma_1, \gamma_2, \gamma_{12})$ be an object which satisfies conditions of Definition 5.27 except possibly (6), for some $\vec{a}_1, \vec{a}_2, \vec{a}, E$. (Note that a_{\pm} appears only in (6).) Then there exists a_-, a_+ such that (6)=Condition 5.29 is satisfied.*

Moreover there exists $C_k, c_k > 0$ such that

$$\|\nabla^k u_1(z)\| \leq C_k e^{-c_k |\operatorname{Im} z|}, \quad \|\nabla^k u_2(z)\| \leq C_k e^{-c_k |\operatorname{Im} z|}. \quad (5.29)$$

◇

Proof. We use (t, τ) as a coordinate of $[0, 1] \times [\tau_0, \infty)$ and the point $(t, \tau) \in [0, 1] \times [\tau_0, \infty)$ is identified with $z = t + \sqrt{-1}\tau \in \mathbb{C}$.

We may assume that there is no tree of sphere components whose root is a point z with $\tau > \tau_0$. We may also assume that $\operatorname{Im} z_{i,j}, \operatorname{Im} z_{12,j} < -\tau_0$. We define $u : [0, 1] \times [\tau_0, \infty) \rightarrow (X_1, -J_1) \times (X_2, J_2)$ by

$$u(z) = (u_1(\bar{z}), u_2(z)).$$

The map u is pseudo-holomorphic and

$$u(\{+1\} \times [\tau_0, \infty)) \subset L_1 \times L_2, \quad u(\{0\} \times [\tau_0, \infty)) \subset L_{12}.$$

Moreover

$$\int_{[0,1] \times [\tau_0, \infty)} u^*(-\pi_1^*(\omega_1) + \pi_2^*(\omega_2)) < \infty.$$

Since L_{12} and $L_1 \times L_2$ have clean intersection (see Situation 5.24), there exists $p_{+\infty} = (p_{+\infty,1}, p_{+\infty,2}) \in L_{12} \cap (L_1 \times L_2)$ such that

$$d(u(z), p_{+\infty}) < C e^{-C |\operatorname{Im} z|}, \quad \|\nabla^k u(z)\| \leq C_k e^{-c_k |\operatorname{Im} z|}$$

on $[0, 1] \times (\tau_0, \infty)$. (See [FOOO12, Lemmas 2.4 and 2.5] for example.) We can discuss in the same way for $\tau < -\tau_0$. \square

We will next discuss the compactification of $\overset{\circ}{\mathcal{M}}_{\text{QT}}(\vec{a}_1, \vec{a}_{12}, \vec{a}_2; a_-, a_+; E)$. Note that we already included objects with sphere bubbles in $\overset{\circ}{\mathcal{M}}_{\text{QT}}(\vec{a}_1, \vec{a}_{12}, \vec{a}_2; a_-, a_+; E)$. We need to include disk bubbles and the process where elements split into several pieces in the second factor of $[-1, 1] \times \mathbb{R}$. Note that disk bubbles may occur at the boundaries $\partial_1 \Omega, \partial_2 \Omega$ or the seam $\partial_{12} \Omega$, where pseudo-holomorphic disks in $X_1, X_2, -X_1 \times X_2$ with boundary in L_1, L_2, L_{12} can bubble, respectively. The moduli spaces of such pseudo-holomorphic disks are described by the moduli spaces we introduced in Subsection 3.2 and hence the moduli space of objects with disk bubbles is obtained by an appropriate fiber product. We will describe it below.

Definition 5.36. Let $\mathcal{M}(L; \vec{a}; E)$ be the moduli space introduced in (3.28). For the sake of simplicity of notations we use the next (slight abuse of) notations. Let $\vec{a} = (a, a)$ ($a \in \mathcal{A}_L$). We include $\mathcal{M}(L; \vec{a}; 0) = \mathcal{M}(L; (a, a); 0)$ and define it to be a single point consisting of a constant map to $L(a)$. In fact this element is unstable. However we include it as an exception here. See Remark 5.39.

Let $\vec{a}^{i,(j)} = (a_0^{i,(j)}, \dots, a_{m_{i,(j)}}^{i,(j)}) \in (\mathcal{A}_{L_i}^+)^{m_{i,(j)}+1}$ for $i = 1, 2, j = 1, \dots, k_i$ and $\vec{a}^{12,(j)} = (a_0^{12,(j)}, \dots, a_{m_{12,(j)}}^{12,(j)}) \in (\mathcal{A}_{L_{12}}^+)^{m_{12,(j)}+1}$ for $j = 1, \dots, k_{12}$. Here $m_{i,(j)}$ and $m_{12,(j)}$ are nonnegative integers.

We put

$$\begin{aligned}\bar{a}'_i &= (a'_{i,1}, \dots, a'_{i,k_i}) = (a_0^{i,(1)}, \dots, a_0^{i,(k_i)}) \in (\mathcal{A}_{L_i}^+)^{k_i}, \quad i = 1, 2 \\ \bar{a}'_{12} &= (a'_{12,1}, \dots, a'_{12,k_{12}}) = (a_0^{12,(1)}, \dots, a_0^{12,(k_{12})}) \in (\mathcal{A}_{L_{12}}^+)^{k_{12}}.\end{aligned}$$

We define

$$\#_j \bar{a}^{i,(j)} := (a_1^{i,(1)}, \dots, a_{m_i,(1)}^{i,(j)}, a_1^{i,(2)}, \dots, a_{m_i,(2)}^{i,(j)}, \dots, a_1^{i,(k_i)}, \dots, a_{m_i,(k_i)}^{i,(k_i)}) \in (\mathcal{A}_{L_i}^+)^{m_i}$$

where $i = 1, 2$ and $m_i = \sum_j m_{i,(j)}$. We moreover put

$$\#_j \bar{a}^{12,(j)} := (a_1^{12,(1)}, \dots, a_{m_{12},(1)}^{12,(j)}, \dots, a_1^{12,(k_{12})}, \dots, a_{m_{12},(k_{12})}^{12,(k_{12})}) \in (\mathcal{A}_{L_{12}}^+)^{m_{12}}$$

where $m_{12} = \sum_j m_{12,(j)}$. (See Figure 17.) \diamond

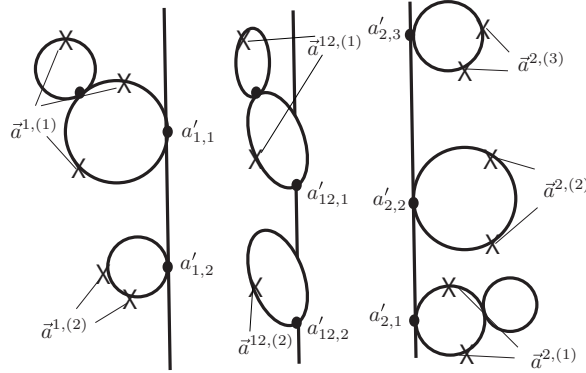

FIGURE 17. Domain of an element of $\overset{\circ}{\mathcal{M}}_{\text{QT}}(\bar{a}_1, \bar{a}_{12}, \bar{a}_2; a_-, a_+; E)$

Definition 5.37. We define the set $\overset{\circ}{\mathcal{M}}_{\text{QT}}(\bar{a}_1, \bar{a}_{12}, \bar{a}_2; a_-, a_+; E)$ as the union of the fiber products

$$\begin{aligned}\overset{\circ}{\mathcal{M}}_{\text{QT}}(\bar{a}'_1, \bar{a}'_{12}, \bar{a}'_2; a_-, a_+; E') &\times_{\text{ev}_0, \dots, \text{ev}_0} \prod_{j=1}^{k_1} \mathcal{M}(L_1; \bar{a}^{1,(j)}; E_{1,j}) \\ &\times_{\text{ev}_0, \dots, \text{ev}_0} \prod_{j=1}^{k_{12}} \mathcal{M}'(L_{12}; \bar{a}^{12,(j)}; E_{12,j}) \\ &\times_{\text{ev}_0, \dots, \text{ev}_0} \prod_{j=1}^{k_2} \mathcal{M}(L_2; \bar{a}^{2,(j)}; E_{2,j}),\end{aligned} \quad (5.30)$$

where $\#_j \bar{a}^{1,(j)} = \bar{a}_1$, $\#_j \bar{a}^{12,(j)} = \bar{a}_{12}$, $\#_j \bar{a}^{2,(j)} = \bar{a}_2$, $E' + \sum_j E_{1,j} + \sum_j E_{12,j} + \sum_j E_{2,j} = E$. \diamond

We remark that in the first line of (5.30) the fiber product is taken over $\prod_{j=1}^{k_1} L_1(a_0^{1,(j)})$ by the evaluation maps $\text{ev}_j^1 : \overset{\circ}{\mathcal{M}}_{\text{QT}}(\bar{a}'_1, \bar{a}'_{12}, \bar{a}'_2; a_-, a_+; E') \rightarrow L_1(a_0^{1,(j)})$ and $\text{ev}_0 : \mathcal{M}(L_1; \bar{a}^{1,(j)}; E_{1,j}) \rightarrow L_1(a_0^{1,(j)})$. The fiber product in the second line is taken over $\prod_{j=1}^{k_{12}} L_{12}(a_0^{12,(j)})$ by the evaluation maps $\text{ev}_j^{12} : \overset{\circ}{\mathcal{M}}(\bar{a}'_1, \bar{a}'_{12}, \bar{a}'_2; a_-, a_+; E') \rightarrow$

$L_{12}(a_0^{12,(j)})$ and $\text{ev}_0 : \mathcal{M}'(L_{12}; \vec{a}^{12,(j)}; E_{12,j}) \rightarrow L_{12}(a_0^{12,(j)})$. The fiber product in the third line is taken in a similar way.

Remark 5.38. In the formula (5.30) we used a compactification $\mathcal{M}'(L_{12}; \vec{a}^{12,(j)}; E_{12,j})$ of the space $\overset{\circ\circ}{\mathcal{M}}(L_{12}; \vec{a}^{12,(j)}; E_{12,j})$. Here $\overset{\circ\circ}{\mathcal{M}}(L_{12}; \vec{a}^{12,(j)}; E_{12,j})$ is the moduli space of pseudo-holomorphic disks whose source curve is D^2 without any disk or sphere bubbles. This compactification is similar to the stable map compactification $\mathcal{M}(L_{12}; \vec{a}^{12,(j)}; E_{12,j})$ which we defined in Subsection 3.2 but is slightly different from it. It is necessary to use different compactification for our space $\mathcal{M}_{\text{QT}}(\vec{a}_1, \vec{a}_{12}, \vec{a}_2; a_-, a_+; E)$ to carry a Kuranishi structure. We will explain this point in detail in Section 12. \diamond

Remark 5.39. As we mentioned before we include the case when $\mathcal{M}(L_1; \vec{a}^{1,(j)}; E_{1,j}) = \mathcal{M}(L_1; (a, a); 0)$. This moduli space consists of one point and is a constant map to a point in $L_1(a)$. Note that this element actually is not a stable map since its automorphism group is \mathbb{R} . This case corresponds to the case when the corresponding marked point is on the line $\{-1\} \times \mathbb{R}$ (and not on the disk bubble) and is mapped to an element of $L_1(a)$. We include this case in (5.30) and etc. for the sake of simplicity of notation. When we regard this element as a ‘stable map’ we shrink this disk and regard the ‘root’ as a marked point. (See Figure 18.) We consider the case when $\mathcal{M}'(L_{12}; (a, a); 0)$ (resp. $\mathcal{M}(L_2; (a, a); 0)$) appears in the second (resp. third) line of (5.30) in the same way. \diamond

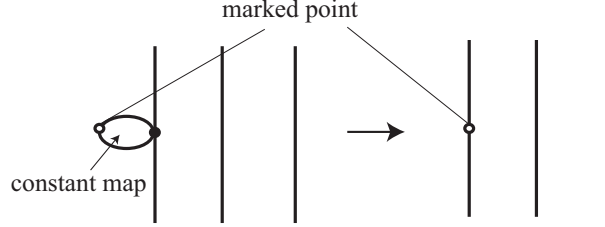

FIGURE 18. Shrink an element of $\mathcal{M}(L_2; (a, a); 0)$

We have thus included the objects with disk bubbles. We finally define our compactification as follows.

Definition 5.40. We define the set $\mathcal{M}_{\text{QT}}(\vec{a}_1, \vec{a}_{12}, \vec{a}_2; a_-, a_+; E)$ as the union of the fiber products

$$\begin{aligned}
& \overset{\circ}{\mathcal{M}}_{\text{QT}}(\vec{a}_{1,0}, \vec{a}_{12,0}, \vec{a}_{2,0}; a_0, a_1; E_1) \\
& \times_{R(a_1)} \overset{\circ}{\mathcal{M}}_{\text{QT}}(\vec{a}_{1,1}, \vec{a}_{12,1}, \vec{a}_{2,1}; a_1, a_2; E_2) \\
& \times_{R(a_2)} \cdots \\
& \cdots \\
& \times_{R(a_{\ell-1})} \overset{\circ}{\mathcal{M}}_{\text{QT}}(\vec{a}_{1,\ell}, \vec{a}_{12,\ell}, \vec{a}_{2,\ell}; a_{\ell-1}, a_\ell; E_\ell).
\end{aligned} \tag{5.31}$$

Here $\vec{a}_1 = \vec{a}_{1,0}, \vec{a}_{1,1} \dots \vec{a}_{1,\ell}$, $\vec{a}_{12} = \vec{a}_{12,0}, \vec{a}_{12,1} \dots \vec{a}_{12,\ell}$, $\vec{a}_2 = \vec{a}_{2,\ell}, \vec{a}_{2,\ell-1} \dots \vec{a}_{2,0}$, $E_1 + \dots + E_\ell = E$ and

$$a_- = a_0, a_1, \dots, a_{\ell-1}, a_\ell = a_+ \in \mathcal{A}_R.$$

We use the maps $\text{ev}_\infty = (\text{ev}_{\infty,-}, \text{ev}_{\infty,+})$ to define the fiber product. \diamond

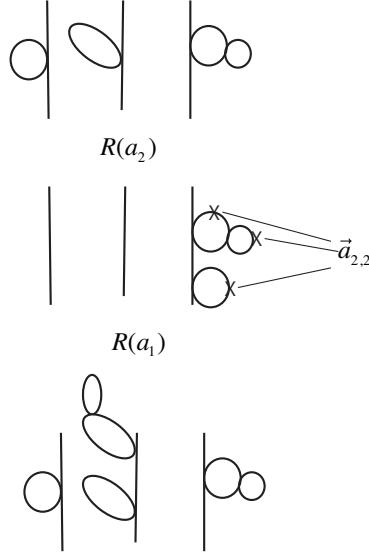

FIGURE 19. Fiber product (5.31)

Definition 5.41. We define the *evaluation maps*:

$$\begin{aligned} \text{ev} &= (\text{ev}^1, \text{ev}^{12}, \text{ev}^2) = ((\text{ev}_1^1, \dots, \text{ev}_{k_1}^1), (\text{ev}_1^{12}, \dots, \text{ev}_{k_{12}}^{12}), (\text{ev}_1^2, \dots, \text{ev}_{k_2}^2)) \\ &: \mathcal{M}_{\text{QT}}(\vec{a}_1, \vec{a}_{12}, \vec{a}_2; a_-, a_+; E) \rightarrow \prod_{j=1}^{k_1} L_1(a_{1,j}) \times \prod_{j=1}^{k_{12}} L_{12}(a_{12,j}) \times \prod_{j=1}^{k_2} L_2(a_{2,j}) \end{aligned}$$

and

$$\text{ev}_\infty = (\text{ev}_{\infty,-}, \text{ev}_{\infty,+}) : \mathcal{M}_{\text{QT}}(\vec{a}_1, \vec{a}_{12}, \vec{a}_2; a_-, a_+; E) \rightarrow R(a_-) \times R(a_+).$$

in the same way as Definition 5.32. \diamond

Proposition 5.42. We can define a topology on $\mathcal{M}_{\text{QT}}(\vec{a}_1, \vec{a}_{12}, \vec{a}_2; a_-, a_+; E)$ by which this space is compact and Hausdorff. \diamond

The topology we use is the stable map topology which is similar to [FOOO2, Definitions 7.1.39 and 7.1.42] and [FOn, Definition 10.3]. The proof of the proposition is similar to one in [FOn, Definition 10.3]. The only new point is the way how we handle disk bubbles on the seam $\{0\} \times \mathbb{R}$ and more importantly the sphere bubbles on such disk bubbles. This is the point related to Remark 5.38. We will discuss this point in detail in Section 12.

Theorem 5.43. The space $\mathcal{M}_{\text{QT}}(\vec{a}_1, \vec{a}_{12}, \vec{a}_2; a_-, a_+; E)$ has a Kuranishi structure with corners with the following properties.

- (1) We denote the codimension d normalized corner of the space with Kuranishi structure, $\mathcal{M}_{\text{QT}}(\vec{a}_1, \vec{a}_{12}, \vec{a}_2; a_-, a_+; E)$, by $S_d \mathcal{M}_{\text{QT}}(\vec{a}_1, \vec{a}_{12}, \vec{a}_2; a_-, a_+; E)$. Then

it is a union of the fiber products

$$\begin{aligned} S_{d_1} \overset{\circ}{\mathcal{M}}_{\text{QT}}(\vec{a}_{1,0}, \vec{a}_{12,0}, \vec{a}_{2,0}; a_0, a_1; E_1) \times_{R(a_1)} S_{d_2} \overset{\circ}{\mathcal{M}}_{\text{QT}}(\vec{a}_{1,1}, \vec{a}_{12,1}, \vec{a}_{2,1}; a_1, a_2; E_2) \\ \times_{R(a_2)} \cdots \\ \cdots \\ \times_{R(a_{\ell-1})} S_{d_\ell} \overset{\circ}{\mathcal{M}}_{\text{QT}}(\vec{a}_{1,\ell}, \vec{a}_{12,\ell}, \vec{a}_{2,\ell}; a_{\ell-1}, a_\ell; E_\ell) \end{aligned}$$

of the form (5.31), where $d_1 + \cdots + d_\ell + \ell - 1 \geq d$

- (2) The codimension d_j normalized corner $S_{d_j} \overset{\circ}{\mathcal{M}}_{\text{QT}}(\vec{a}_{1,j}, \vec{a}_{12,j}, \vec{a}_{2,j}; a_j, a_{j+1}; E)$ is the union of the closure of subsets

$$\begin{aligned} \overset{\circ}{\mathcal{M}}_{\text{QT}}(\vec{a}'_1, \vec{a}'_{12}, \vec{a}'_2; a_-, a_+; E') \times_{\text{ev}_0, \dots, \text{ev}_0} \prod_{j=1}^{k_1} S_{d'_{1,\ell_j}} \mathcal{M}(L_1; \vec{a}_{1,j}; E_{1,j}) \\ \times_{\text{ev}_0, \dots, \text{ev}_0} \prod_{j=1}^{k_{12}} S_{d'_{12,\ell_j}} \mathcal{M}'(L_{12}; \vec{a}_{12,j}; E_{12,j}) \\ \times_{\text{ev}_0, \dots, \text{ev}_0} \prod_{j=1}^{k_2} S_{d'_{2,\ell_j}} \mathcal{M}(L_2; \vec{a}_{2,j}; E_{2,j}), \end{aligned}$$

of (5.30) such that there are $k'_1 + k'_2 + k'_3 + 1$ factors other than those of the form of one of $\mathcal{M}(L_1; (a, a); 0)$, $\mathcal{M}(L_{12}; (a, a); 0)$, $\mathcal{M}(L_2; (a, a); 0)$ and

$$d_j = k'_1 + k'_2 + k'_3 + \sum_{j=1}^{k_1} d'_{1,\ell_j} + \sum_{j=1}^{k_{12}} d'_{12,\ell_j} + \sum_{j=1}^{k_2} d'_{2,\ell_j}.$$

- (3) The evaluation maps defined in (5.32) are the underlying continuous maps of strongly smooth maps.
- (4) The evaluation maps defined in (5.41) are the underlying continuous maps of strongly smooth maps. $\text{ev}_{\infty,+}$ is weakly submersive also.
- (5) The fiber product description (5.30) and (5.31) are compatible with the Kuranishi structures. Namely there exists an isomorphism between Kuranishi structures on $\mathcal{M}_{\text{QT}}(\vec{a}_1, \vec{a}_{12}, \vec{a}_2; a_-, a_+; E)$ with ones obtained as the fiber product Kuranishi structures of (5.30) or (5.31). Here on the spaces appearing in the second, third and fourth factors of (5.30) we take the Kuranishi structures given in Theorem 3.24.
- (6) The isomorphisms of the Kuranishi structures in item (5) satisfies corner compatibility conditions which are similar to Condition 3.27.
- (7) Given relative spin structures of L_1 , L_{12} , L_2 (with background data V_1 , $\pi_1^*(V_1 \oplus TX_1) \oplus \pi_2^*(V_2)$, V_2 , respectively) we can define a principal $O(1)$ bundle $\Theta_{12,a}^-$ on $R(a)$ such that the orientation bundle of $\mathcal{M}_{\text{QT}}(\vec{a}_1, \vec{a}_{12}, \vec{a}_2; a_-, a_+; E)$ is canonically isomorphic to the tensor product of the pull backs of $\Theta_{\alpha_1,i}^-$, Θ_{12,α_i}^- , $\Theta_{\alpha_\pm}^-$. The isomorphism is compatible with the description of the boundary which is a part of item (1).³⁰

³⁰In the case of moduli space of holomorphic disks a precise meaning of compatibility at boundary with orientation is written as [FOOO13, Condition 21.6 (IX)], when L is embedded. There is an explicit correction term of sign in [FOOO13, Condition 21.6 (IX)] which coincides with one in [FOOO2] and [ST]. However the discussion of this paper is not affected by the explicit form of correction terms. See Remark 17.2. In the case L is immersed with self-transversal intersection,

◇

Most of the proof of Theorem 5.43 is the same as the proof of Theorem 3.24 and is now becoming a routine, in the study of pseudo-holomorphic curves based on the virtual fundamental chain technique. (See [FOOO15].) The only point we need a discussion other than those in Theorem 5.43 is the way how we handle the point mentioned in Remark 5.38. We will discuss it in Section 12.

See Subsections 17.2, 17.6 and Appedix for item (7).

We finally mention the gapped-ness, which is related to Gromov-compactness. We define:

$$G_0(L_1, L_{12}, L_2) := \{E \in \mathbb{R}_{\leq 0} \mid \overset{\circ}{\mathcal{M}}_{\text{QT}}(\vec{a}_1, \vec{a}_{12}, \vec{a}_2; a_-, a_+; E) \text{ is nonempty for some } \vec{a}_1, \vec{a}_{12}, \vec{a}_2; a_-, a_+ \}. \quad (5.32)$$

Gromov compactness implies that $G_0(L_1, L_{12}, L_2)$ is a discrete subset of $\mathbb{R}_{\geq 0}$. Let $G_0(L_1)$, $G_0(L_{12})$, $G_0(L_2)$ be as in (3.20).

Definition 5.44. We define $G(L_1, L_{12}, L_2)$ to be the discrete submonoid generated by the union of $G_0(L_1, L_{12}, L_2)$, $G_0(L_1)$, $G_0(L_{12})$, $G_0(L_2)$. ◇

The next lemma is obvious.

Lemma 5.45. *The set $G(L_1, L_{12}, L_2)$ is a discrete submonoid. If the moduli space $\mathcal{M}(\vec{a}_1, \vec{a}_{12}, \vec{a}_2; a_-, a_+; E)$ is non-empty then $E \in G(L_1, L_{12}, L_2)$.* ◇

The filtered A_∞ tri-module in Theorem 5.25 will be $G(L_1, L_{12}, L_2)$ -gapped.

5.3. A geometric realization of an A_∞ tri-module 2. Using the system of Kuranishi structures given in Theorem 5.43 we can define a system of CF-perturbations. We will state it as Proposition 5.48 below. We first describe the situation we work with precisely.

Lemma 5.46. *The conclusions of Theorem 3.24 and Proposition 3.30 still hold when we replace the compactification $\mathcal{M}(L_{12}; \vec{a}_{12}; E_{12})$ by the other compactification $\mathcal{M}'(L_{12}; \vec{a}_{12}; E_{12})$.* ◇

The proof is the same as the proof of Theorem 3.24 and Proposition 3.30 once the definition of $\mathcal{M}'(L_{12}; \vec{a}_{12}; E_{12})$ is understood. See Theorem 12.24.

Situation 5.47. Let $E_0 > 0$. We are given a system of CF-perturbations of $\mathcal{M}(L_1; \vec{a}_1; E_1)$, $\mathcal{M}(L_2; \vec{a}_2; E_2)$, $\mathcal{M}'(L_{12}; \vec{a}_{12}; E_{12})$ for $E_1, E_2, E_{12} < E_0$ so that they satisfy the conclusions of Theorem 3.24 and Proposition 3.30. ◇

Proposition 5.48. *Let $E_0 > 0$. There exists a system of CF-perturbations $\widehat{\mathfrak{S}}$ on the moduli spaces $\mathcal{M}(\vec{a}_1, \vec{a}_{12}, \vec{a}_2; a_-, a_+; E)$ with Kuranishi structures which are outer collarings of thickenings of those given in Theorem 5.43. It enjoys the following properties.*

- (1) *The CF-perturbations $\widehat{\mathfrak{S}}$ are transversal to zero.*
- (2) *The evaluation map ev_0 is strongly submersive with respect to this CF-perturbation. (See [FOOO10, Definition 9.2] for the definition of strong submersivity.)*

it is given in [AJ, (73)]. The way to generalize it to the self-clean case is in Subsection 17.6 and in the Appendix written by Kaoru Ono. In the way we explain in Section 17, the case of the moduli space of quilt etc. can be reduced to the case of disks.

- (3) They are compatible with the fiber product description of their corners given in Theorem 5.43. Here we use CF-perturbations in Situation 5.47 on those factors in the same sense as Proposition 3.30.
- (4) They are compatible with the forgetful maps of the marked points which corresponds to the diagonal component other than 0-th one. The precise definition of compatibility is written in [Fu9, Definition 5.1].

◇

Proof. The proof is by the general theory of Kuranishi structures, such as those developed in [FOOO10, FOOO11, FOOO13]. See [Fu9] for item (4). \square

Definition 5.49.

- (1) We put

$$\overline{D} = CF(L_1, L_{12}, L_2; \mathbb{R}) \cong \Omega((\tilde{L}_1 \times \tilde{L}_2) \times_{X_1 \times X_2} \tilde{L}_{12}; \Theta^-), \quad (5.33)$$

where Θ^- is a \mathbb{Z}_2 local system defined on the fiber product $(\tilde{L}_1 \times \tilde{L}_2) \times_{X_1 \times X_2} \tilde{L}_{12}$ by Theorem 5.43 (7), and

$$D = CF(L_1, L_{12}, L_2; \Lambda_0) = \overline{D} \widehat{\otimes}_{\mathbb{R}} \Lambda_0.$$

Then D is a cochain complex with differential $\delta = d$.

- (2) We will define the structure operations

$$\mathbf{n}_{k_1, k_{12}, k_2}^{E, \epsilon} : B_{k_1} CF(L_1; \mathbb{R})[1] \otimes B_{k_{12}} CF(L_{12}; \mathbb{R})[1] \otimes \overline{D}[1] \otimes B_{k_2} CF(L_2; \mathbb{R})[1] \rightarrow \overline{D}[1]$$

as follows. Let $\mathbf{x} = x_1 \otimes \cdots \otimes x_{k_1} \in B_{k_1} CF(L_1; \mathbb{R})[1]$, $\mathbf{y} = y_{12} \otimes \cdots \otimes y_{k_{12}} \in B_{k_{12}} CF(L_{12}; \mathbb{R})[1]$ and $\mathbf{z} = z_1 \otimes \cdots \otimes z_{k_2} \in B_{k_2} CF(L_2; \mathbb{R})[1]$, and $w \in D$. Then

$$\begin{aligned} \mathbf{n}_{k_1, k_{12}, k_2}^{E, \epsilon}(\mathbf{x}, \mathbf{y}, w, \mathbf{z}) &:= \text{ev}_{\infty, +}! \left(\text{ev}_{1,1}^* x_1 \wedge \cdots \wedge \text{ev}_{1, k_1}^* x_{k_1} \wedge \right. \\ &\quad \left. \wedge \text{ev}_{12,1}^* y_1 \wedge \cdots \wedge \text{ev}_{12, k_{12}}^* y_{k_{12}} \right. \\ &\quad \left. \wedge w \wedge \text{ev}_{2,1}^* z_1 \wedge \cdots \wedge \text{ev}_{2, k_2}^* z_{k_2}; \widehat{\mathfrak{S}}^\epsilon \right). \end{aligned} \quad (5.34)$$

Here we use the integration along the fiber on the union of the moduli spaces $\mathcal{M}(\vec{a}_1, \vec{a}_{12}, \vec{a}_2; a_-, a_+; E)$ with Kuranishi structures and its CF-perturbations $\widehat{\mathfrak{S}}$ in Proposition 5.48 to define the right hand side. (See [FOOO13, Definition 7.79].)³¹

- (3) We finally put

$$\mathbf{n}_{k_1, k_{12}, k_2}^{< E_0, \epsilon} = \sum_{E < E_0, E \in G(L_1, L_{12}, L_2)} T^E \mathbf{n}_{k_1, k_{12}, k_2}^{E, \epsilon}. \quad (5.35)$$

This is a map

$$\mathbf{n}_{k_1, k_{12}, k_2}^{< E_0, \epsilon} : B_{k_1} CF(L_1)[1] \otimes B_{k_{12}} CF(L_{12})[1] \otimes D[1] \otimes B_{k_2} CF(L_2)[1] \rightarrow D[1].$$

◇

³¹We remark that δ is the boundary operator of D . The case $k_1, k_2, k_{12} = 0$, $E \neq 0$, the map $\mathbf{n}_{0,0,0}^{E, \epsilon}$ may be nonzero and is a deformation of the boundary operator of D obtained by using moduli spaces $\mathcal{M}(\emptyset, \emptyset, \emptyset; a_-, a_+; E)$.

Remark 5.50. We remark that we need a certain sign $(-1)^*$ in (5.34). We will prove in Section 17 that there *exists* a choice of the sign so that A_∞ relation (5.36) holds with sign. The sign $*$ is in principle calculable from the discussion of Section 17 and the sign given in [FOOO2, FOOO13, AJ], Subsection 17.6 and Appendix. Since all we need to prove the main results of this paper are *existence* of sign $*$ and not its explicit formula we do not try to calculate it. We do not repeat this remark in several other places.

Proposition 5.51. $\mathfrak{n}_{k_1, k_{12}, k_2}^{<E_0, \epsilon}$ defines a filtered A_∞ tri-module modulo T^{E_0} . Namely it satisfies the congruence:

$$\begin{aligned}
0 \equiv & \sum_{c_1, c_{12}, c_2} (-1)^{*1} \mathfrak{n}^{<E_0, \epsilon}(\mathbf{x}_{c_1;1}, \mathbf{y}_{c_{12};1}, \\
& \mathfrak{n}^{<E_0, \epsilon}(\mathbf{x}_{c_1;2}, \mathbf{y}_{c_{12};2}, w, \mathbf{z}_{c_2;1}), \mathbf{z}_{c_2;2}) \\
& + (-1)^{*2} \mathfrak{n}^{<E_0, \epsilon}(\widehat{d}\mathbf{x}, \mathbf{y}, w, \mathbf{z}) \\
& + (-1)^{*3} \mathfrak{n}^{<E_0, \epsilon}(\mathbf{x}, \widehat{d}\mathbf{y}, w, \mathbf{z}) \\
& + (-1)^{*4} \mathfrak{n}^{<E_0, \epsilon}(\mathbf{x}, \mathbf{y}, w, \widehat{d}\mathbf{z}) \\
& + (-1)^{*5} \delta \mathfrak{n}^{<E_0, \epsilon}(\mathbf{x}, \mathbf{y}, w, \mathbf{z}) \\
& + (-1)^{*6} \mathfrak{n}^{<E_0, \epsilon}(\mathbf{x}, \mathbf{y}, \delta w, \mathbf{z}) \pmod{T^{E_0}}.
\end{aligned} \tag{5.36}$$

This filtered A_∞ tri-module modulo T^{E_0} is unital. \diamond

The notations in (5.36) is as follows. We define $\mathbf{x}_{c_1;1}, \mathbf{x}_{c_1;2}$ by $\Delta(\mathbf{x}) = \sum_{c_1} \mathbf{x}_{c_1;1} \otimes \mathbf{x}_{c_1;2}$. Here c_1 runs over a certain index set depending on \mathbf{x} . The definitions of $\mathbf{y}_{c_{12};1}, \mathbf{y}_{c_{12};2}, \mathbf{z}_{c_2;1}, \mathbf{z}_{c_2;2}$ are similar. The symbol \widehat{d} in the second (resp. third, fourth) term of (5.36) is the derivation induced on $BCF[1](L_1)$ (resp. $BCF[1](L_{12}), BCF[1](L_2)$) by its filtered A_∞ structure modulo T^{E_0} . δ is the operator induced from the de Rham differential in the same way as (3.42). We omit the indices k_i etc. of the operator \mathfrak{n} since they are automatically determined by the variables plugged in. The signs $*_i$ ($i = 1, \dots, 6$) are determined by Koszul rule. We explain Koszul rule in detail in Subsection 17.1

Proof. The proof is a routine using Theorem 5.43, Proposition 5.48, Stokes' formula and the composition formula and proceeds as follows.

By Stokes' formula ([FOOO13, Theorem 8.11]) we have

$$\begin{aligned}
& (-1)^{*5} \delta \mathfrak{n}^{<E, \epsilon}(\mathbf{x}, \mathbf{y}, w, \mathbf{z}) + (-1)^{*7} \mathfrak{n}^{<E, \epsilon}(\delta(\mathbf{x}, \mathbf{y}, w, \mathbf{z})) \\
= & \sum_{E < E_0} T^E \text{ev}_{\infty, +!} (ev_{1,1}^* x_1 \wedge \cdots \wedge ev_{1,k_1}^* x_{k_1} \wedge \\
& \wedge ev_{12,1}^* y_1 \wedge \cdots \wedge ev_{12,k_{12}}^* y_{k_{12}} \wedge w \\
& \wedge ev_{2,1}^* z_1 \wedge \cdots \wedge ev_{2,k_2}^* z_{k_2} \\
& : (\partial \mathcal{M}_{\text{QT}}(\vec{a}_1, \vec{a}_{12}, \vec{a}_2; a_-, a_+; E), \widehat{\mathfrak{S}}^\epsilon)).
\end{aligned} \tag{5.37}$$

We include the symbol $\partial \mathcal{M}_{\text{QT}}(\vec{a}_1, \vec{a}_{12}, \vec{a}_2; a_-, a_+; E)$ in the right hand side to clarify the fact that we use this space to define the integration along the fiber. (We used $\mathcal{M}_{\text{QT}}(\vec{a}_1, \vec{a}_{12}, \vec{a}_2; a_-, a_+; E)$ in (5.34).) There is actually a sign in the right hand side of (5.37). We will explain it in Subsection 17.2.

By Theorem 5.43 and (5.30) the normalized boundary $\partial\mathcal{M}_{\text{QT}}(\vec{a}_1, \vec{a}_{12}, \vec{a}_2; a_-, a_+; E)$ is the union of the following four types of fiber products.

The first type is:

$$\mathcal{M}_{\text{QT}}(\vec{a}_{1,0}, \vec{a}_{12,0}, \vec{a}_{2,0}; a_-, a; E_1) \times_{R(a)} \mathcal{M}_{\text{QT}}(\vec{a}_{1,1}, \vec{a}_{12,1}, \vec{a}_{2,1}; a, a_+; E_2), \quad (5.38)$$

where $\vec{a}_{1,0} \sqcup \vec{a}_{1,1} = \vec{a}_1$, $\vec{a}_{12,0} \sqcup \vec{a}_{12,1} = \vec{a}_{12}$, $\vec{a}_{2,0} \sqcup \vec{a}_{2,1} = \vec{a}_2$, $E_1 + E_2 = E$. See Figure 20.



FIGURE 20. Fiber product (5.38)



FIGURE 21. Fiber product (5.39)

The second type is:

$$\mathcal{M}(L_1; \vec{a}_1''; E_2) \times_{\text{ev}_0} \mathcal{M}_{\text{QT}}(\vec{a}_1', \vec{a}_{12}, \vec{a}_2; a_-, a_+; E_1). \quad (5.39)$$

Here $\vec{a}_1' = (a_{1,1}, \dots, a_{1,i-1}, b, a_{1,j+1}, \dots, a_{1,k_1})$, $\vec{a}_1'' = (b, a_{1,i}, \dots, a_{1,j})$ for some $1 \leq i \leq j \leq k_1$ and $b \in \mathcal{A}_{L_1}$. See Figure 21.

The third type is:

$$\mathcal{M}'(L_{12}; \vec{a}_{12}''; E_2) \times_{\text{ev}_0} \mathcal{M}_{\text{QT}}(\vec{a}_1, \vec{a}_{12}', \vec{a}_2; a_-, a_+; E_1). \quad (5.40)$$

Here $\vec{a}_{12}' = (a_{12,1}, \dots, a_{12,i-1}, b, a_{12,j+1}, \dots, a_{12,k_{12}})$, $\vec{a}_{12}'' = (b, a_{12,i}, \dots, a_{12,j})$ for some $1 \leq i \leq j \leq k_{12}$ and $b \in \mathcal{A}_{L_{12}}$. See Figure 22.



FIGURE 22. Fiber product (5.40)



FIGURE 23. Fiber product (5.41)

The fourth type is:

$$\mathcal{M}(L_1; \vec{a}_2''; E_2) \times_{\text{ev}_0} \mathcal{M}_{\text{QT}}(\vec{a}_1, \vec{a}_{12}, \vec{a}_2'; a_-, a_+; E_1). \quad (5.41)$$

Here $\vec{a}_2' = (a_{2,1}, \dots, a_{2,i-1}, b, a_{2,j+1}, \dots, a_{2,k_2})$, $\vec{a}_2'' = (b, a_{2,i}, \dots, a_{2,j})$ for some $1 \leq i \leq j \leq k_2$ and $b \in \mathcal{A}_{L_2}$. See Figure 23.

By the composition formula [FOOO13, Theorem 10.21], the integration along the fiber appearing in (5.37) on the spaces (5.38) (resp. (5.39), (5.40), (5.41)) becomes the formula

$$\sum_{c_1, c_{12}, c_2} (-1)^{*1} \mathbf{n}^{<E_0, \epsilon}(\mathbf{x}_{c_1;1}, \mathbf{y}_{c_{12};1}, \mathbf{n}^{<E_0, \epsilon}(\mathbf{x}_{c_1;2}, \mathbf{y}_{c_{12};2}, w, \mathbf{z}_{c_2;1}), \mathbf{z}_{c_2;2}),$$

(resp. the formula $(-1)^{*2} \mathbf{n}^{<E_0, \epsilon}(\widehat{d}\mathbf{x}, \mathbf{y}, w, \mathbf{z})$, $(-1)^{*3} \mathbf{n}^{<E_0, \epsilon}(\mathbf{x}, \widehat{d}\mathbf{y}, w, \mathbf{z})$, and the formula $(-1)^{*4} \mathbf{n}^{<E_0, \epsilon}(\mathbf{x}, \mathbf{y}, w, \widehat{d}\mathbf{z})$). This implies (5.36). \square

Thus we defined a filtered A_∞ tri-module modulo T^{E_0} . The rest of the proof of Theorem 5.25 is the same as the last step of the proof of Theorem 3.14. We first define the notion of a pseudo-isotopy of A_∞ tri-modules modulo T^{E_0} in a similar way as Definition 3.36. (See Subsubsection 14.4.1.) We next show that for $E < E'$ the A_∞ tri-module modulo $T^{E'}$ we constructed in Proposition 5.51 regarded as A_∞ tri-module modulo T^E is pseudo-isotopic to the A_∞ tri-module modulo T^E we constructed in Proposition 5.51. We then prove a similar algebraic lemma as Lemma 3.57. Using it we complete the proof of Theorem 5.25 in the same way as the last step of the proof of Theorem 3.14. Since this argument is now a routine we omit the detail. \square

6. UNOBSTRUCTEDNESS IS PRESERVED BY AN UNOBSTRUCTED LAGRANGIAN CORRESPONDENCE.

In this section we prove Theorem 1.5.

Situation 6.1. Suppose we are in Situation 5.24.

Moreover we assume that, for $L_1 \in \mathbb{L}_1$ and $L_{12} \in \mathbb{L}_{12}$, L_1 has clean transformation by L_{12} . Let $(L_1, \sigma_1) \in \mathbb{L}_1$ and $(L_{12}, \sigma_{12}) \in \mathbb{L}_{12}$. We consider the geometric transformation $(L_2, \sigma_2) = L_1 \times_{X_1} L_{12}$ as in Definition 4.3, where the relative spin structure σ_2 is given later in Definition 6.8. We assume (L_2, σ_2) is contained in \mathbb{L}_2 . \diamond

Situation 6.2. In Situation 6.1, we consider the filtered A_∞ tri-module $\mathcal{C}\mathcal{F}(\mathbb{L}_1, \mathbb{L}_{12}; \mathbb{L}_2)$ in Theorem 5.25.

We assume that $(L_1, \sigma_1) \in \mathbb{L}_1$ and $(L_{12}, \sigma_{12}) \in \mathbb{L}_{12}$ are unobstructed and take their bounding cochains $b_1 \in CF(L_1)$, $b_{12} \in CF(L_{12})$. \diamond

The main result of this section is as follows.

Theorem 6.3. *In Situation 6.2, we can choose a relative spin structure σ_2 such that (L_2, σ_2) is unobstructed. Moreover there exists a canonical choice of the gauge equivalence class of the bounding cochain b_2 . The gauge equivalence class of b_2 depends only on those of b_1 and b_{12} . \diamond*

As we mentioned in Remark 1.6 (3), the bounding cochain b_2 had been conjectured to be defined as the virtual fundamental chain of a certain moduli space (the moduli space of Figure 8 bubbles). The author was trying to understand how we can use such a bounding cochain to generalize the argument by Lekili-Lipyanskiy beyond the monotone case using the Y -diagram. Then he found that for this purpose we need an equality that a certain element of the de Rham complex of a Lagrangian

submanifold becomes a cycle with respect to the deformed Floer boundary operator via b_1, b_{12}, b_2 . The equality needed is (6.2). In fact the homomorphism (7.12) becomes a cochain map because of (6.2). As we will explain in Subsection 18.2, the heuristic argument shows that the bounding cochain obtained as the virtual fundamental chain of the moduli space of Figure 8 bubbles, after an appropriate gauge transformation, satisfies (6.2). The author then found that the equality (6.2) is strong enough to characterize b_2 (for given b_1, b_{12}) and also (6.2) implies that b_2 is actually a bounding cochain. Moreover as we will see in Proposition 6.6, we can solve (6.2) uniquely. Thus we can use the algebraic equation (6.2) in place of studying the moduli spaces, to obtain the required bounding cochain.

Thus replacing the study of difficult moduli spaces by a simple algebraic lemma (Proposition 6.6) is the key new idea of this paper.

6.1. Right filtered A_∞ modules and cyclic elements. The main idea of the proof of Theorem 6.3 is the same as [Fu10, Section 3] and is based on [Fu10, Proposition 3.5]. We repeat the argument here for the completeness sake and also here we work over \mathbb{R} , while in [Fu10] we worked over \mathbb{Z}_2 .

Definition 6.4. Let $(C, \{\mathfrak{m}_k\})$ be a non-unital curved and filtered A_∞ algebra.

- (1) A *filtered right A_∞ module* over $(C, \{\mathfrak{m}_k\})$ is a left Λ_0 and right $(C, \{\mathfrak{m}_k\})$ filtered A_∞ bi-module in the sense of Definition 5.10.
- (2) We say a filtered right A_∞ module is *G -gapped* if its structure operations are all G -gapped.

◇

More explicitly a right filtered A_∞ module over $(C, \{\mathfrak{m}_k\})$ is $(D, \{\mathfrak{n}_k \mid k = 0, 1, 2, \dots\})$ where:

- (1) D is a completed free Λ_0 module.
- (2) The operation \mathfrak{n}_k is a Λ_0 moduli homomorphism

$$\mathfrak{n}_k : D[1] \widehat{\otimes}_{\Lambda_0} C^{\otimes k}[1] \rightarrow D[1],$$

of degree 1 which preserves filtration in the same sense as Definition 2.2 (2).³²

- (3) The following holds for any $k, y \in D, x_1, \dots, x_k \in C$.

$$\begin{aligned} 0 = & \sum_{k_1+k_2=k} \mathfrak{n}_{k_1}(\mathfrak{n}_{k_2}(y; x_1, \dots, x_{k_2}); x_{k_2+1}, \dots, x_k) \\ & + \sum_{k_1+k_2=k+1} \sum_{i=0}^{k_2} (-1)^* \mathfrak{n}_{k_1}(y; \dots, \mathfrak{m}_{k_1}(x_{i+1}, \dots, x_{i+k_1}), \dots, x_k), \end{aligned} \tag{6.1}$$

where $*$ = $\deg' y + \sum_{j=1}^{i-1} \deg' x_j$.

Definition 6.5. Let $(C, \{\mathfrak{m}_k\})$ be a G -gapped filtered A_∞ algebra and $(D, \{\mathfrak{n}_k\})$ a G -gapped right filtered A_∞ module over $(C, \{\mathfrak{m}_k\})$.

We say an element $\mathbf{1} \in D$ of degree 0 a *cyclic element*³³ if the following holds

³²Here we shift the degree of elements of bi-module.

³³The word cyclic element seems to be a standard one for an object satisfying a condition such as (1). We remark that the notion of cyclic element has no relation to the cyclic symmetry of the filtered A_∞ algebra associated to a Lagrangian submanifold.

- (1) The map $C \rightarrow D$ which sends x to $\mathbf{n}_1(\mathbf{1}; x)$ is a Λ_0^R module isomorphism $C \rightarrow D$.³⁴
- (2) $\mathbf{n}_0(\mathbf{1}) \equiv 0 \pmod{\Lambda_+^R}$.

◇

Proposition 6.6. *Let $(C, \{\mathbf{m}_k\})$ be a G -gapped filtered A_∞ algebra and $(D, \{\mathbf{n}_k\})$ a G -gapped right filtered A_∞ module over $(C, \{\mathbf{m}_k\})$. Suppose $\mathbf{1} \in D$ is a cyclic element, which is G -gapped.*

Then there exists a unique G -gapped bounding cochain b of $(C, \{\mathbf{m}_k\})$ such that

$$\mathbf{n}_0^b(\mathbf{1}) = 0, \quad (6.2)$$

where we defined \mathbf{n}_0^b by

$$\mathbf{n}_0^b(y) = \sum_{k=0}^{\infty} \mathbf{n}_k(y; b, \dots, b). \quad (6.3)$$

◇

Proof. We first prove the uniqueness. Let $G = \{\lambda_i \mid i = 0, 1, 2, \dots\}$ where $0 = \lambda_0 < \lambda_1 < \lambda_2 < \dots$. We put

$$\begin{aligned} \mathbf{1} &= \sum_{i=0}^{\infty} T^{\lambda_i} \mathbf{1}_i, & b &= \sum_{i=1}^{\infty} T^{\lambda_i} b_i \\ \mathbf{m}_k &= \sum_{i=0}^{\infty} T^{\lambda_i} \mathbf{m}_{k,i}, & \mathbf{n}_k &= \sum_{i=0}^{\infty} T^{\lambda_i} \mathbf{n}_{k,i}. \end{aligned}$$

according to the definition of G -gapped-ness. (Note that the coefficient of T^{λ_0} ($\lambda_0 = 0$) of b is 0 since $b \in C \otimes \Lambda_{+,G}$.)

We calculate the coefficient of T^{λ_n} of the equation (6.2) and obtain

$$\mathbf{n}_{1,0}(\mathbf{1}_0; b_n) + \sum \mathbf{n}_{k,m}(\mathbf{1}_{n_0}; b_{n_1}, \dots, b_{n_k}) = 0. \quad (6.4)$$

Here the second term is the sum over all $k, m, n_0, n_1, \dots, n_k$ such that

$$\lambda_n = \lambda_m + \lambda_{n_0} + \sum_{i=1}^k \lambda_{n_i} \quad (6.5)$$

except the case $k = 1, m = 0, n_0 = 0, n_1 = n$. (The case which we exclude here corresponds to the first term.) Note that if $k, m, n_0, n_1, \dots, n_k$ satisfy (6.5) then $n_i \leq n$ for $i = 0, \dots, k$. Moreover $n_i < n$ unless $k = 1, m = 0, n_0 = 0, n_1 = n$.

Therefore we can solve (6.4) and obtain b_n uniquely by induction on n . (Here we use Definition 6.5 (1).)

Thus we proved that there exists a unique G -gapped element $b \in C \otimes_{\Lambda_0^R} \Lambda_+^R$ satisfying (6.2).

It remains to prove that this element b satisfies the Maurer-Cartan equation (2.11). We will prove

$$\sum_{k=0}^{\infty} \mathbf{m}_k(b, \dots, b) \equiv 0 \pmod{T^{\lambda_c}} \quad (6.6)$$

by induction on $c \in \mathbb{Z}_+$. We assume (6.6) for $c \leq n - 1$ and will prove the case $c = n$ below.

³⁴Since $\deg' \mathbf{1} = -1$, $\deg' x = \deg' \mathbf{n}_1(\mathbf{1}; x)$.

We remark that the assumption implies that we have $\mathbf{n}_{0,0} \circ \mathbf{n}_{0,0} = 0$. Using (6.1) and Definition 6.5 (2) we have

$$\mathbf{n}_0(\mathbf{n}_{1,0}(\mathbf{1}_0; x)) - \mathbf{n}_{1,0}(\mathbf{1}_0; \mathbf{m}_{1,0}(x)) = 0 \quad (6.7)$$

for $x \in \bar{C}$.

We next consider $\mathbf{n}_0(\mathbf{n}_{1,0}(\mathbf{1}_0; b_n))$. Using (6.4) we find

$$\mathbf{n}_0(\mathbf{n}_{1,0}(\mathbf{1}_0; b_n)) = - \sum \mathbf{n}_0(\mathbf{n}_{k,m}(\mathbf{1}_{n_0}; b_{n_1}, \dots, b_{n_k})).$$

We calculate the right hand side using (6.1) to obtain:

$$\begin{aligned} & \sum \mathbf{n}_{k_1, m_1}(\mathbf{n}_{k_2, m_2}(\mathbf{1}_{n_0}; b_{n_1}, \dots, b_{n_{k_2}}), \dots, b_{n_k}) \\ & - \sum \mathbf{n}_{k_1, m_1}(\mathbf{1}_{n_0}; b_{n_1}, \dots, \mathbf{m}_{k_2, m_2}(b_{n_{i+1}}, \dots, b_{n_{i+k_2}}), \dots, b_{n_k}) \\ & - \sum \mathbf{n}_{k, m}(\mathbf{1}_{n_0}; b_{n_1}, \dots, \mathbf{m}_{1,0}(b_{n_j}), \dots, b_{n_k}). \end{aligned} \quad (6.8)$$

Here the sum in the first line is taken over $k_1, k_2, m_1, m_2, n_0, \dots, n_k$ such that $k_1 + k_2 = k$ and $\lambda_n = \lambda_{m_1} + \lambda_{m_2} + \lambda_{n_0} + \sum_{i=1}^k \lambda_{n_i}$, except $k_1 = 0, m_1 = 0$.

The sum in the second line is taken over $k_1, k_2, m_1, m_2, n_0, \dots, n_k$ such that $k_1 + k_2 = k + 1$ and $\lambda_n = \lambda_{m_1} + \lambda_{m_2} + \lambda_{n_0} + \sum_{i=1}^k \lambda_{n_i}$, except $m_2 = 0, k_2 = 1$. (The excluded case corresponds to the third line.)

The sum in the third line is taken over k, m, j, n_0, \dots, n_k such that $j = 1, \dots, k$ and $\lambda_n = \lambda_m + \lambda_{n_0} + \sum_{i=1}^k \lambda_{n_i}$, except $n_0 = 0, k = 1, m = 0$. We exclude this case since it is excluded in the second term of (6.4).

Note that the first line of (6.8) vanishes because of the equality (6.2).

By using the induction hypothesis (6.6) for $c \leq n - 1$, the sum of the second and third lines cancel each other except the sum

$$- \sum \mathbf{n}_{0,1}(\mathbf{1}_0; \mathbf{m}_{k,m}(b_{n_1}, \dots, b_{n_k}))$$

which is taken over k, m, n_1, \dots, n_k such that $\lambda_n = \lambda_m + \sum_{i=1}^k \lambda_{n_i}$. (In fact this sum could be canceled with $\mathbf{n}_{0,1}(\mathbf{1}_0; \mathbf{m}_{0,1}(b_n))$. However this is the case excluded in the third line.)

Thus we have

$$\mathbf{n}_{1,0}(\mathbf{1}_0; \mathbf{m}_{1,0}(b_n)) = \mathbf{n}_{1,0}(\mathbf{n}_{1,0}(\mathbf{1}_0; b_n)) = - \sum \mathbf{n}_{0,1}(\mathbf{1}_0; \mathbf{m}_{k,m}(b_{n_1}, \dots, b_{n_k})).$$

Using Definition 6.5 (1) it implies

$$\mathbf{m}_{1,0}(b_n) + \sum \mathbf{m}_{k,m}(b_{n_1}, \dots, b_{n_k}) = 0.$$

It implies (6.6) for $c = n$. The proof of Proposition 6.6 is now complete. \square

6.2. A geometric realization of a cyclic element. In this section we use Proposition 6.6 to prove the existence part of Theorem 6.3.

Suppose we are in Situation 6.1. By definition (see (5.33)) :

$$CF((L_1, \sigma_1), (L_{12}, \sigma_{12}), (L_2, \sigma_2)) \cong \Omega((\tilde{L}_1 \times \tilde{L}_2) \times_{X_1 \times X_2} \tilde{L}_{12}; \Theta^-) \widehat{\otimes} \Lambda_0. \quad (6.9)$$

Lemma 6.7. *There exists a unique relative spin structure σ_2 such that principal $O(1)$ bundle Θ^- in (6.9) is trivial on \tilde{L}_2 . \diamond*

Proof. We have

$$(\tilde{L}_1 \times \tilde{L}_2) \times_{X_1 \times X_2} \tilde{L}_{12} \cong (\tilde{L}_1 \times_{X_1} \tilde{L}_{12}) \times_{X_2} \tilde{L}_2 = \tilde{L}_2 \times_{X_2} \tilde{L}_2.$$

(Lemma 4.6.) Therefore the lemma follows from Lemma 3.11 and Lemma 4.4. \square

Definition 6.8. Let σ_2 be as in Lemma 6.7. We call (L_2, σ_2) the *geometric transformation* of (L_1, σ_1) by (L_{12}, σ_{12}) . \diamond

Definition 6.9. In the situation of Definition 6.8, let b_1 , (resp. b_{12}) be a bounding cochain of $CF(L_1, \sigma_1)$ (resp. $CF(L_{12}, \sigma_{12})$). We define

$$\mathbf{n}_k^{b_1, b_{12}} : CF[1](L_1; L_{12}; L_2) \otimes BCF[1](L_2, \sigma_2)^{\otimes k} \rightarrow CF[1](L_1; L_{12}; L_2)$$

by

$$\mathbf{n}_k^{b_1, b_{12}}(y; x_1, \dots, x_k) = \sum_{k_1=0}^{\infty} \sum_{k_{12}=0}^{\infty} \mathbf{n}_{k_1, k_{12}, k}(b_1, \dots, b_1; b_{12}, \dots, b_{12}; y; x_1, \dots, x_k).$$

The operation \mathbf{n} in the right hand is defined by Theorem 5.25. \diamond

Now we have the following:

Lemma 6.10. *In the situation of Definition 6.9, the operations $\mathbf{n}_k^{b_1, b_{12}}$, $k = 0, 1, 2, \dots$ define a structure of right filtered A_∞ module on $CF(L_1; L_{12}; L_2)$ over $CF(L_2, \sigma_2)$.* \diamond

The proof is a straightforward calculation and so is omitted.

In the simplest case $k = 0$, Lemma 6.10 becomes

$$\mathbf{n}_0^{b_1, b_{12}}(\mathbf{n}_0^{b_1, b_{12}}(h)) + \mathbf{n}_1^{b_1, b_{12}}(h; \mathbf{m}_0(1)) = 0. \quad (6.10)$$

In a geometric language its proof is roughly as follows. We assume for simplicity that all the switching components of L_2 are zero dimensional. Let $(p_i, q_i, r_i) \in L_1 \times_{X_1} L_{12} \times_{L_2} L_2$ be in the switching component $R(a_i)$ for $i = 1, 2$. We consider the case $h = [p_1, q_1, r_1]$ and study

$$\langle \mathbf{n}_0^{b_1, b_{12}}(\mathbf{n}_0^{b_1, b_{12}}([p_1, q_1, r_1])), [p_2, q_2, r_2] \rangle.$$

As usual in various Floer theories we consider the one dimensional moduli space $\mathcal{M}(a_1, a_2; E)$. Its boundary contains the union of

$$\mathcal{M}(a_1, a; E_1) \times \mathcal{M}(a, a_2; E_2)$$

for various a and E_1, E_2 with $E_1 + E_2 = E$. The count of such boundary becomes:

$$\langle \mathbf{n}_0(\mathbf{n}_0([p_1, q_1, r_1])), [p_2, q_2, r_2] \rangle.$$

(Here \mathbf{n}_0 is the boundary operator and we do not include bounding cochains b_1, b_{12} .) As usual in the Lagrangian Floer theory, the one dimensional moduli space $\mathcal{M}(a_1, a_2; E)$ has other boundaries, which corresponds to various disk bubbles. There are three kinds of disk bubbles, that are those on L_1, L_{12}, L_2 . By including bounding cochains b_1 and b_{12} the effect of disk bubbles on L_1, L_{12} are cancelled. Therefore only the disk bubble at L_2 remains. It gives the term $\mathbf{n}_1^{b_1, b_{12}}(h; \mathbf{m}_0(1))$. Thus (6.10) follows. Using the algebraic formalism we have developed so far we can convert this geometric argument to algebraic ones, which is the calculation to prove Lemma 6.10.

Remark 6.11. In Lemma 6.10 we do not need to assume that (L_2, σ_2) is a geometric transform of (L_1, σ_1) by (L_{12}, σ_{12}) . \diamond

Proposition 6.12. *Let (L_2, σ_2) be the geometric transformation of (L_1, σ_1) by (L_{12}, σ_{12}) . Then we can choose our tri-module structure so that*

$$1 \in \Omega^0((\tilde{L}_1 \times \tilde{L}_2) \times_{X_1 \times X_2} \tilde{L}_{12}; \mathbb{R}) \subset CF((L_1, \sigma), (L_{12}, \sigma_{12}), (L_2, \sigma_2))$$

is a cyclic element of $(CF((L_1, \sigma), (L_{12}, \sigma_{12}), (L_2, \sigma_2)), \{\mathbf{n}_k^{b_1, b_{12}}\})$. \diamond

Here $\mathbf{1}$ is the zero form (function) 1 on the diagonal component $\tilde{L}_2 \subset (\tilde{L}_1 \times_{X_1} \tilde{L}_{12}) \times_{X_2} \tilde{L}_2$.

Proof. Definition 6.5 (2) is the consequence of the fact that $d\mathbf{1} = 0$ and $\mathbf{n}_0^{b_1, b_{12}} \equiv \pm d \pmod{T^\epsilon}$.

We remark that $\mathbf{n}_1^{b_1, b_{12}} \equiv \mathbf{n}_{0,0,1} \pmod{T^\epsilon}$. We also remark that modulo T^ϵ , $\mathbf{n}_{0,0,1}$ is defined as the smooth correspondence via the moduli space $\mathcal{M}(\emptyset, \emptyset, a; o, b; 0)$ of energy zero. Namely

$$\mathbf{n}_{0,0,1}(h) \equiv \text{ev}_{\infty,+}!(\text{ev}_{\infty,-}^*(h); \widehat{\mathfrak{S}}^\epsilon; \mathcal{M}(\emptyset, \emptyset, a; o, b; 0)) \pmod{T^\epsilon}. \quad (6.11)$$

The notations are as follows. In the notation $\mathcal{M}(\emptyset, \emptyset, a; o, b; 0)$, the symbol \emptyset in the first component (resp. second component) indicates that we do not put marked points on the line $\text{Re } z = -1$ (resp. $\text{Re } z = 0$). The symbol a in the third component means that we put one marked point on $\text{Re } z = 1$ and require that this point goes to $L(a)$ in the sense of Condition 5.28. The symbol o in the fourth component means that we use the diagonal component \tilde{L}_2 for the boundary condition (switching condition 2, Condition 5.29) when $\text{Im } z \rightarrow -\infty$. The symbol b in the fourth component means that we use the component $L_2(b)$ for the boundary condition (switching condition 2, Condition 5.29) when $\text{Im } z \rightarrow +\infty$. The symbol 0 in the fifth component means that we consider the pseudo-holomorphic curve with 0 energy. (It is nothing but a constant map.)

In (6.11), the maps $\text{ev}_{\infty,+}$ and $\text{ev}_{\infty,-}$ are evaluation maps defined on $\mathcal{M}(\emptyset, \emptyset, a; o, b; 0)$ as in Definition 5.41. We pull back the differential form h on \tilde{L}_2 by $\text{ev}_{\infty,-}$ and obtain a differential form on $\mathcal{M}(\emptyset, \emptyset, a; o, b; 0)$, a space with Kuranishi structure. (See [FOOO13, Definition 7.7.1].) The symbol $\widehat{\mathfrak{S}}^\epsilon$ denotes the CF-perturbation defined on $\mathcal{M}(\emptyset, \emptyset, a; o, b; 0)$ by Proposition 5.48. We use it to define the integration along the fiber $\text{ev}_{\infty,+}!$ via the strongly submersive map $\text{ev}_{\infty,+}$.

See Figure 24.

Lemma 6.13. *$\mathcal{M}(\emptyset, \emptyset, a; o, b; 0)$ is an empty set if $a \neq b$. If $a = b$ the space $\mathcal{M}(\emptyset, \emptyset, a; o, b; 0)$ is diffeomorphic to $L_2(a)$ and evaluation map ev_2 is a diffeomorphism. Moreover the moduli space $\mathcal{M}(\emptyset, \emptyset, a; o, b; 0)$ is transversal. \diamond*

Proof. Since $\mathcal{M}(\emptyset, \emptyset, a; o, b; 0)$ consists of constant maps the lemma is obvious except the statement about transversality. See Figure 25 below in the case when $a = b$ is not diagonal component.

We show that $\mathcal{M}(\emptyset, \emptyset, a; o, a; 0)$ is transversal. We remark that this moduli space is identified with a connected component of the moduli space of pseudo-holomorphic strip between $\tilde{L}_1 \times \tilde{L}_2$ and \tilde{L}_{12} . Using the assumption that $\tilde{L}_1 \times \tilde{L}_2$ is of clean intersection with \tilde{L}_{12} , it is standard that this moduli space is transversal. (In fact the moduli space of pseudo-holomorphic strips with 0 energy which bounds L and L' is transversal if L and L' are of clean intersection.) \square

Definition 6.5 (1) is an immediate consequence of Lemma 6.13. The proof of Proposition 6.12 is complete. \square

Theorem 6.3 follows immediately from Propositions 6.13 and 6.6. \square

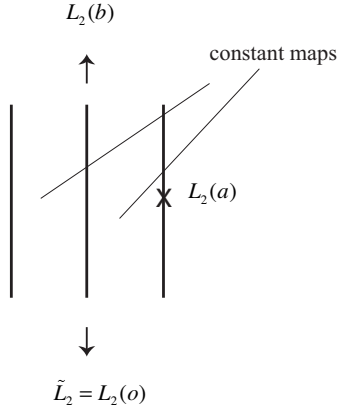

FIGURE 24. An element of $\mathcal{M}(\emptyset, \emptyset, a; o, b; 0)$

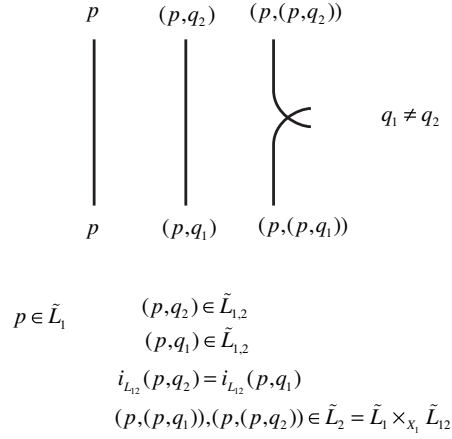

FIGURE 25. An element of $\mathcal{M}(\emptyset, \emptyset, a; o, a; 0)$, $a \neq o$

Definition 6.14. In the situation of Theorem 6.3, we call (L_2, σ_2, b_2) the *geometric transformation* of (L_1, σ_1, b_1) by $(L_{12}, \sigma_{12}, b_{12})$. \diamond

6.3. Well-defined-ness of bounding cochains up to gauge equivalence. In this subsection we prove that when we change the bounding cochains b_1, b_{12} by gauge equivalences the bounding cochain b_2 in Definition 6.14 changes by a gauge equivalence. Here we discuss only an algebraic part. Namely we fix the tri-module in Theorem 5.25. The independence of b_2 of the construction of the tri-module in Theorem 5.25 will be proved in Section 14, Theorem 14.6. The statement we prove is the next proposition.

Situation 6.15. Let C_1, C_{12}, C_2 be curved filtered A_∞ algebras and Let (D, \mathbf{n}) be a left C_1, C_{12} and right C_2 tri-module. Let $\mathbf{1} \in D$ be an element such that:

- (1) The map $C_2 \rightarrow D$ which sends x to $\mathbf{n}_1(\mathbf{1}; x)$ is an Λ_0^R module isomorphism $C_2 \rightarrow D$.
- (2) $\mathbf{n}_0(\mathbf{1}) \equiv 0 \pmod{\Lambda_+^R}$.

\diamond

A pair of bounding cochains b_1 and b_{12} of C_1, C_{12} defines a right filtered A_∞ module structure on D over C_2 by the next formula.

$$\mathbf{n}^{b_1, b_{12}}(y; x_1, \dots, x_k) = \sum_{k_1, k_{12}} \mathbf{n}_{k_1, k_{12}, k}(b_1^{k_1}, b_{12}^{k_{12}}; y; x_1, \dots, x_k) \quad (6.12)$$

$\mathbf{1}$ is its cyclic element. Therefore by Proposition 6.6 there exists a unique bounding cochain b_2 such that

$$\sum_k \mathbf{n}^{b_1, b_{12}}(\mathbf{1}; b_2^k) = 0.$$

We write $b_2 = B(b_1, b_{12})$.

Proposition 6.16. If b_1, b_{12} are gauge equivalent to b'_1, b'_{12} , then $B(b_1, b_{12})$ is gauge equivalent to $B(b'_1, b'_{12})$. \diamond

Proof. We recall the definition of gauge equivalence in [FOOO1, Section 4.3]. For a completed free Λ_0 module C , we define $Poly([0, 1], C)$ to be the set of all formal sums

$$\sum_{i=1}^{\infty} x_i(s)T^{\lambda_i} + \left(\sum_{i=1}^{\infty} y_i(s)T^{\lambda_i} \right) ds \quad (6.13)$$

where x_i, y_i are polynomials (with variable s) with coefficients in \overline{C} and $\lambda_i \in \mathbb{R}_{\geq 0}$ with $\lim_{i \rightarrow \infty} \lambda_i = +\infty$. s and ds are formal variables.

For $s_0 \in \mathbb{R}$, we define $\text{Ev}_{s_0} : Poly([0, 1], C) \rightarrow C$ by sending the element (6.13) to

$$\sum_i x_i(s_0)T^{\lambda_i} \in C.$$

In [FOOO1, Definition 4.2.9], we defined filtered A_∞ structures on $Poly([0, 1], C_1)$, $Poly([0, 1], C_{12})$, $Poly([0, 1], C_2)$.

During the proof of [FOOO1, Theorem 5.2.3] it is proved that if D is a filtered A_∞ bi-module over C_1, C_2 then $Poly([0, 1], D)$ is a filtered A_∞ bi-module over $Poly([0, 1], C_1), Poly([0, 1], C_2)$. We can prove the same statement for tri-module in the same way. Thus in our situation $Poly([0, 1], D)$ is a filtered A_∞ tri-module over $Poly([0, 1], C_1), Poly([0, 1], C_{12}), Poly([0, 1], C_2)$.

Moreover Ev_{s_0} defines a filtered A_∞ algebra homomorphism or a filtered A_∞ tri-module homomorphism.

The cyclic element $\mathbf{1} \in D$ may be regarded as an element of $Poly([0, 1], D)$.

By assumption that b_1 (resp. b_{12}) is gauge equivalent to b'_1 (resp. b'_{12}), there exists a bounding cochain \mathbf{b}_1 (resp. \mathbf{b}_{12}) of $Poly([0, 1], C_1)$ (resp. $Poly([0, 1], C_{12})$) such that:

$$\begin{aligned} \text{Ev}_0(\mathbf{b}_1) &= b_1, & \text{Ev}_1(\mathbf{b}_1) &= b'_1, \\ \text{Ev}_0(\mathbf{b}_{12}) &= b_{12}, & \text{Ev}_1(\mathbf{b}_{12}) &= b'_{12}. \end{aligned}$$

Using \mathbf{b}_1 and \mathbf{b}_{12} in the same way as (6.12) we can define a structure of right filtered A_∞ module $\{\mathbf{n}_k^{b_1, b_{12}}\}$ on $Poly([0, 1], D)$ over $Poly([0, 1], C_2)$.

It is easy to see that $\mathbf{1} \in Poly([0, 1], D)$ is a cyclic element of $\{\mathbf{n}_k^{b_1, b_{12}}\}$. Therefore by Proposition 6.6 there exists a bounding cochain \mathbf{b}_2 of $Poly([0, 1], C_2)$ such that

$$\sum_k \mathbf{n}_k^{b_1, b_{12}}(\mathbf{1}; \mathbf{b}_2^k) = 0.$$

It follows that

$$\sum_k \mathbf{n}_k^{b_1, b_{12}}(\mathbf{1}; \text{Ev}_0(\mathbf{b}_2)^k) = 0.$$

Therefore the uniqueness part of Proposition 6.6 implies $\text{Ev}_0(\mathbf{b}_2) = b_2$. In the same way we can show $\text{Ev}_1(\mathbf{b}_2) = b'_2$. Thus b_2 is gauge equivalent to b'_2 as required. \square

7. REPRESENTABILITY OF CORRESPONDENCE FUNCTOR

7.1. Statement. Suppose we are in Situation 6.1. We consider the correspondence tri-module $\mathcal{C}\mathcal{F}(\mathbb{L}_1, \mathbb{L}_{12}; \mathbb{L}_2)$ which is a left $\mathfrak{F}\mathfrak{u}\mathfrak{k}(X_1, V_1, \mathbb{L}_1) \times \mathfrak{F}\mathfrak{u}\mathfrak{k}(-X_1 \times X_2, \pi_1^*(V_1 \oplus TX_1) \oplus \pi_2^*V_2, \mathbb{L}_{12})$ and right $\mathfrak{F}\mathfrak{u}\mathfrak{k}(X_2, V_2, \mathbb{L}_2)$ tri-module and which we obtained in Theorem 5.25.

Notation 7.1. Here and hereafter we denote

$$\mathfrak{F}\mathfrak{u}\mathfrak{k}(-X_1 \times X_2) = \mathfrak{F}\mathfrak{u}\mathfrak{k}((X_1, -\omega_1) \times (X_2, \omega_2), \pi_1^*(V_1 \oplus TX_1) \oplus \pi_2^*(V_2), \mathbb{L}_{12})$$

and

$$\mathfrak{Fuk}(X_1) = \mathfrak{Fuk}((X_1, \omega_1), V_1, \mathbb{L}_1), \quad \mathfrak{Fuk}(X_2) = \mathfrak{Fuk}((X_2, \omega_2), V_2, \mathbb{L}_2),$$

for simplicity of notations. We also denote by $\mathfrak{Fukst}(-X_1 \times X_2)$, $\mathfrak{Fukst}(X_1)$, $\mathfrak{Fukst}(X_2)$, their associated strict categories. (Definition 2.5 (8).) \diamond

By the tri-module analogue of Lemma 5.19, the tri-module $\mathcal{CF}(\mathbb{L}_1, \mathbb{L}_{12}; \mathbb{L}_2)$ induces a left- $\mathfrak{Fukst}(X_1)$, $\mathfrak{Fukst}(-X_1 \times X_2)$ and right- $\mathfrak{Fukst}(X_2)$ filtered A_∞ tri-module $\mathcal{CF}^s(\mathbb{L}_1, \mathbb{L}_{12}; \mathbb{L}_2)$.

It can be regarded as a tri-functor

$$\mathfrak{Fukst}(X_1)^{\text{op}} \times \mathfrak{Fukst}(-X_1 \times X_2)^{\text{op}} \times \mathfrak{Fukst}(X_2) \rightarrow \mathcal{CH}.$$

By taking opposite functor and using Definition 5.14 and Lemma 5.22 we obtain³⁵

$$\begin{aligned} \widehat{\mathcal{MWW}} : \mathfrak{Fukst}(-X_1 \times X_2) &\rightarrow \mathcal{FUNK}(\mathfrak{Fukst}(X_1), \\ &\mathcal{FUNK}(\mathfrak{Fukst}(X_2)^{\text{op}}, \mathcal{CH}^{\text{op}})). \end{aligned} \quad (7.1)$$

Definition 7.2. Let

$$(L_{12}, b_{12}, \sigma_{12}) = \mathcal{L}_{12} \in \mathfrak{DB}(\mathfrak{Fukst}(X_{12})), \quad (L_1, b_1, \sigma_1) = \mathcal{L}_1 \in \mathfrak{DB}(\mathfrak{Fukst}(X_1)).$$

By (7.1) we obtain a strict and unital filtered A_∞ functor: $\mathfrak{Fukst}(X_2)^{\text{op}} \rightarrow \mathcal{CH}^{\text{op}}$. We denote this functor by $\widehat{\mathcal{W}}_{\mathcal{L}_{12}}(\mathcal{L}_1)$, where W stands for Wehrheim-Woodward. We call $\widehat{\mathcal{W}}_{\mathcal{L}_{12}}$ the *correspondence functor* associated to \mathcal{L}_{12} . \diamond

Let $\mathcal{L}_2 = (L_2, \sigma_2, b_2) \in \mathfrak{DB}(\mathfrak{Fukst}(X_2))$ be the geometric transformation of \mathcal{L}_1 by \mathcal{L}_{12} in the sense of Definition 6.14.

We defined

$$\mathfrak{Dp}\mathfrak{N}\mathfrak{on}^{\text{op}} : \mathfrak{Fukst}(X_2) \rightarrow \mathcal{FUNK}(\mathfrak{Fukst}(X_2)^{\text{op}}, \mathcal{CH}^{\text{op}}) \quad (7.2)$$

in Subsection 2.5. The main result of this section is the following:

Theorem 7.3. \mathcal{L}_2 represents $\widehat{\mathcal{W}}_{\mathcal{L}_{12}}(\mathcal{L}_1)$ up to homotopy equivalence. \diamond

We will prove Theorem 7.3 in the next subsection. Corollary 7.4 below says that for each pair (L_{12}, b_{12}) of a Lagrangian submanifold of $-X_1 \times X_2$ and its bounding cochain, we can associate a filtered A_∞ functor $\mathfrak{Fukst}(X_1) \rightarrow \mathfrak{Fukst}(X_2)$ in a canonical way.

Corollary 7.4. *There exists a strict and unital filtered A_∞ functor*

$$\mathcal{MWW} : \mathfrak{Fukst}(-X_1 \times X_2) \rightarrow \mathcal{FUNK}(\mathfrak{Fukst}(X_1), \mathfrak{Fukst}(X_2)), \quad (7.3)$$

such that its composition with

$$\begin{aligned} \mathfrak{Dp}\mathfrak{N}\mathfrak{on}_*^{\text{op}} : \mathcal{FUNK}(\mathfrak{Fukst}(X_1), \mathfrak{Fukst}(X_2)) \\ \rightarrow \mathcal{FUNK}(\mathfrak{Fukst}(X_1), \mathcal{FUNK}(\mathfrak{Fukst}(X_2)^{\text{op}}, \mathcal{CH}^{\text{op}})) \end{aligned}$$

is homotopy equivalent to the functor $\widehat{\mathcal{MWW}}$ in (7.1). Here $\mathfrak{Dp}\mathfrak{N}\mathfrak{on}_*^{\text{op}}$ is induced by the functor $\mathfrak{Dp}\mathfrak{N}\mathfrak{on}^{\text{op}}$ in (7.2). \diamond

³⁵MWW stands for Ma'u-Wehrheim-Woodward. As we mentioned in the introduction Ma'u-Wehrheim-Woodward proved Corollary 7.4 in the case all the Lagrangian submanifolds involved are embedded and monotone.

Proof. A_∞ -Yoneda lemma (Theorem 2.44) implies that there exists a homotopy inverse

$$(\mathfrak{Op}\mathfrak{Yon}^{\text{op}})^{-1} : \mathfrak{Rep}(\mathfrak{Fukst}(X_2)^{\text{op}}, \mathcal{CH}^{\text{op}}) \rightarrow \mathfrak{Fukst}(X_2)$$

to the Yoneda functor \mathfrak{Yon} . (Here \mathfrak{Rep} denotes the full subcategory consisting of objects which are homotopy equivalent to one in the image of Yoneda functor. See Definition 2.42.)³⁶ It induces

$$\begin{aligned} ((\mathfrak{Op}\mathfrak{Yon}^{\text{op}})^{-1})_* : \mathcal{FUNC}(\mathfrak{Fukst}(X_1), \mathfrak{Rep}(\mathfrak{Fukst}(X_2)^{\text{op}}, \mathcal{CH}^{\text{op}})) \\ \rightarrow \mathcal{FUNC}(\mathfrak{Fukst}(X_1), \mathfrak{Fukst}(X_2)). \end{aligned}$$

On the other hand, Theorem 7.3 implies that the filtered A_∞ functors $\widehat{\mathcal{MWW}}$ factor through

$$\mathfrak{Fukst}(-X_1 \times X_2) \rightarrow \mathfrak{Rep}(\mathfrak{Fukst}(X_1), \mathfrak{Fukst}(X_2)). \quad (7.4)$$

We compose (7.4) with $((\mathfrak{Op}\mathfrak{Yon}^{\text{op}})^{-1})_*$ to obtain required filtered A_∞ functor \mathcal{MWW} . \square

Definition 7.5. We call the filtered A_∞ functor \mathcal{MWW} in Corollary 7.4 the *correspondence bi-functor*, when we regard it as a bi-functor

$$\mathfrak{Fukst}(-X_1 \times X_2) \times \mathfrak{Fukst}(X_1) \rightarrow \mathfrak{Fukst}(X_2).$$

\diamond

For a given unobstructed Lagrangian correspondence \mathcal{L}_{12} , the correspondence bi-functor induces a filtered A_∞ functor

$$\mathcal{W}_{\mathcal{L}_{12}} : \mathfrak{Fukst}(X_1) \rightarrow \mathfrak{Fukst}(X_2). \quad (7.5)$$

We call it the *correspondence functor* associated to the unobstructed immersed Lagrangian correspondence \mathcal{L}_{12} .

7.2. Proof. In this subsection we prove Theorem 7.3.

Proof. To prove Theorem 7.3 it suffices to show the next proposition.

Proposition 7.6. *There exists a natural transformation \mathcal{F} from $\mathfrak{Op}\mathfrak{Yon}_{ob}^{\text{op}}(\mathcal{L}_2)$ to $\widehat{\mathcal{W}}_{\mathcal{L}_{12}}(\mathcal{L}_1)$ which has a homotopy inverse.* \diamond

Proof. We remark

$$\mathcal{FUNC}(\mathfrak{Fukst}(X_2)^{\text{op}}, \mathcal{CH}^{\text{op}}) \cong \mathcal{FUNC}(\mathfrak{Fukst}(X_2), \mathcal{CH}^{\text{op}}).$$

We regard $\mathfrak{Op}\mathfrak{Yon}_{ob}^{\text{op}}(\mathcal{L}_2)$ and $\widehat{\mathcal{W}}_{\mathcal{L}_{12}}(\mathcal{L}_1)$ the objects of the right hand side.

Let $\mathfrak{c}, \mathfrak{c}_0, \dots, \mathfrak{c}_k$ be objects of $\mathfrak{Fukst}(X_2)$. We recall that the functor $\mathfrak{Op}\mathfrak{Yon}_{ob}(\mathcal{L}_2)$ for objects is defined by

$$\mathfrak{c} \mapsto CF(\mathcal{L}_2, \mathfrak{c}). \quad (7.6)$$

The morphisms part of $\mathfrak{Op}\mathfrak{Yon}_{ob}^{\text{op}}(\mathcal{L}_2)$ is a map

$$CF(\mathcal{L}_2, \mathfrak{c}_0) \otimes B_k \mathfrak{Fukst}(X_2)[1](\mathfrak{c}_0, \mathfrak{c}_k) \rightarrow CF(\mathcal{L}_2, \mathfrak{c}_k)$$

defined by

$$z \otimes (y_1, \dots, y_k) \mapsto \mathfrak{m}(z, y_1, \dots, y_k) \in CF(\mathcal{L}_2, \mathfrak{c}_k). \quad (7.7)$$

³⁶The filtered A_∞ category, functor, tri-module etc. which are defined by using the moduli space of pseudo-holomorphic curves are always gapped because of Gromov compactness.

Here $z \in CF(\mathcal{L}_2, \mathbf{c}_0)$, $y_i \in CF(\mathbf{c}_{i-1}, \mathbf{c}_i)$, and \mathbf{m} is the structure operation of the filtered A_∞ category $\widehat{\mathfrak{Futst}}(X_2)$. (We remark that \mathbf{m} already includes the deformation by the bounding cochain.) The Bar complex $B_k \dots$ of an A_∞ category is defined in (2.3).

On the other hand, the object part of $\widehat{\mathcal{W}}_{\mathcal{L}_{12}}(\mathcal{L}_1)$ is

$$\mathbf{c} \mapsto CF(L_1, L_{12}; \mathbf{c}). \quad (7.8)$$

Here, when the Lagrangian submanifold which is a part of the data in \mathbf{c} is L'_2 then we put

$$CF(L_1, L_{12}; \mathbf{c}) := CF(L_1, L_{12}; L'_2), \quad (7.9)$$

where the right hand side is defined in Definition 5.49 (1).

The morphism part of $\widehat{\mathcal{W}}_{\mathcal{L}_{12}}(\mathcal{L}_1)$ is a map

$$CF(L_1, L_{12}; \mathbf{c}_0) \otimes B_k \widehat{\mathfrak{Futst}}(X_2)[1](\mathbf{c}_0, \mathbf{c}_k) \rightarrow CF(L_1, L_{12}; \mathbf{c}_k)$$

and is defined by:

$$w \otimes (y_1, \dots, y_k) \mapsto \mathbf{n}(w; y_1, \dots, y_k) \in CF(L_1, L_{12}; \mathbf{c}_k). \quad (7.10)$$

Here $w \in CF(L_1, L_{12}; \mathbf{c}_0)$, $y_i \in CF(\mathbf{c}_{i-1}, \mathbf{c}_i)$, and \mathbf{n} is a filtered A_∞ right module structure on $CF(L_1, L_{12}; \mathbf{c}_k)$.³⁷ Note that using the notation $\mathbf{n}^{b_1, b_{12}}$ appearing in Lemma 6.10, \mathbf{n} is defined by

$$\mathbf{n}(w; y_1, \dots, y_k) = \mathbf{n}^{b_1, b_{12}}(w; e^{b_{2,0}} y_1 e^{b_{2,1}} \dots e^{b_{2,k-1}} y_k e^{b_{2,k}}), \quad (7.11)$$

where $b_{2,i}$ are bounding cochains for $i = 1, 2$. Here we denote an object \mathbf{c}_i as a pair $(\mathcal{L}_{2,i}, b_{2,i})$ of $\mathcal{L}_{2,i} \in \mathbb{L}_2$ and its bounding cochain and $b_{2,i}$. Thus $b_{2,i}$ is a bounding cochain which is a part of data consisting \mathbf{c}_i . The symbol e^b is defined by

$$e^b = \sum_{k=0}^{\infty} \underbrace{b \otimes \dots \otimes b}_{k \text{ times}}.$$

The operation (7.10) is a map

$$CF(L_1, L_{12}; \mathbf{c}_0) \otimes B_k \widehat{\mathfrak{Futst}}(X_2)[1](\mathbf{c}_0, \mathbf{c}_k) \rightarrow CF(L_1, L_{12}; \mathbf{c}_k).$$

See Figure 26.

Now the object part $\mathcal{T}_{ob}(\mathbf{c}) : CF(L_1, L_{12}; \mathbf{c}) \rightarrow CF(\mathcal{L}_2, \mathbf{c})$ of \mathcal{T} is defined by

$$\mathcal{T}_{ob}(\mathbf{c})(z) = \mathbf{n}(\mathbf{1}; z), \quad (7.12)$$

where \mathbf{n} is as in (7.11) and $\mathbf{1} \in CF(L_1, L_{12}; L_2)$ is the cyclic element in Proposition 6.12.

The morphism part

$$\mathcal{T}_k(\mathbf{c}_0, \mathbf{c}_k) : CF(L_1, L_{12}; \mathbf{c}_0) \otimes B_k \widehat{\mathfrak{Futst}}[1](X_2)(\mathbf{c}_0, \mathbf{c}_k) \rightarrow CF(\mathcal{L}_2, \mathbf{c}_k)$$

is defined by

$$\mathcal{T}_k(\mathbf{c})(z; y_1, \dots, y_k) = \mathbf{n}(\mathbf{1}; z, y_1, \dots, y_k). \quad (7.13)$$

See Figure 27.

Lemma 7.7. *The maps \mathcal{T} is a natural transformation. (Namely its boundary in the functor category is 0.) In other words it is a filtered right A_∞ module homomorphism. \diamond*

³⁷We remark that we take an opposite functor while defining $\widehat{\mathcal{MWW}}$.

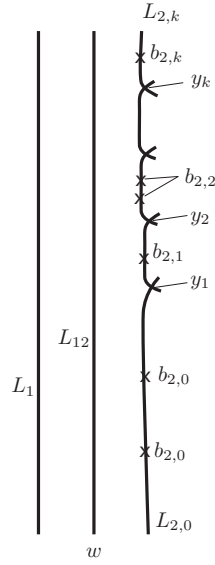

FIGURE 26. $\mathfrak{n}(w; y_1, \dots, y_k)$

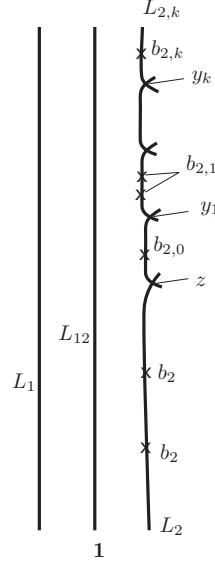

FIGURE 27. $\mathcal{T}_k(\mathfrak{c}_0, \mathfrak{c}_k)(z; y_1, \dots, y_k)$

Proof. (6.2) implies that (7.13) is a chain map. Then the lemma follows from A_∞ formula of \mathfrak{n} . (See (5.7). The element \mathfrak{x} there is empty here (that is, $1 \in B_0CF(L_1, L_1)$)). \square

Lemma 7.8. $\mathcal{T}_{ob}(\mathfrak{c}) : CF(L_1, L_{12}; \mathfrak{c}) \rightarrow CF(L_2, \mathfrak{c})$ is an isomorphism of Λ_0 modules. \diamond

Proof. Since $\mathbf{1}$ is cyclic, the definition implies that $\mathcal{T}_{ob}(\mathfrak{c}) \bmod \Lambda_+$ is an isomorphism. The lemma then follows easily. \square

Now Proposition 7.2 follows from the next Lemma 7.9. \square

Lemma 7.9. Let $\mathcal{C}_1, \mathcal{C}_2$ be unital and strict filtered A_∞ categories and \mathcal{F}, \mathcal{G} unital and strict filtered A_∞ functors from \mathcal{C}_1 to \mathcal{C}_2 .

Let \mathcal{T} be a natural transformation from \mathcal{F} to \mathcal{G} . We assume that, for each object c of \mathcal{C}_1 , $\mathcal{T}_c \in \mathcal{C}_2(\mathcal{F}(c), \mathcal{G}(c))$ is a homotopy equivalence.

Then \mathcal{T} is a homotopy equivalence in the functor category. (See Definition 2.24.) \diamond

This lemma seems to be well-known. For the sake of completeness we will prove it below.

Proof. For simplicity of sign we consider the case when the degree of \mathcal{T} is 0. (We use only such cases.) We use the notation of Proposition 7.9. We will construct natural transformations $\mathcal{S} : \mathcal{G} \rightarrow \mathcal{F}$ of degree 0 and $\mathcal{H} : \mathcal{F} \rightarrow \mathcal{F}$ of degree -1 such that $\mathfrak{M}_1(\mathcal{H}) = \mathfrak{M}_2(\mathcal{S}, \mathcal{T}) - \mathcal{ID}_{\mathcal{F}}$, where $\mathcal{ID}_{\mathcal{F}} : \mathcal{F} \rightarrow \mathcal{F}$ is the identity natural transformation. (Here \mathfrak{M}_k is the structure operation of the functor category.)

We use the induction on the number filtration and will construct

$$\begin{aligned} \mathcal{S}_k &: B_k \mathcal{C}_1[1](c, c') \rightarrow \mathcal{C}_2(\mathcal{G}_0(c), \mathcal{F}(c')), \\ \mathcal{H}_k &: B_k \mathcal{C}_1[1](c, c') \rightarrow \mathcal{C}_2(\mathcal{F}_0(c), \mathcal{F}(c')) \end{aligned}$$

by induction on k so that they satisfy the following conditions (7.14), (7.15) and (7.16). Suppose \mathcal{S}_i is defined for $i \leq k$ and \mathcal{H}_i is defined for $i \leq k$. We define

$$\begin{aligned}\widehat{\mathcal{S}}_{(k)} &: B\mathcal{C}_1[1](c, c') \rightarrow B\mathcal{C}_2[1](\mathcal{G}_0(c), \mathcal{F}(c')), \\ \widehat{\mathcal{H}}_{(k)} &: B\mathcal{C}_1[1](c, c') \rightarrow B\mathcal{C}_2[1](\mathcal{F}_0(c), \mathcal{F}(c')),\end{aligned}$$

by

$$\begin{aligned}\widehat{\mathcal{S}}_{(k)}(\mathbf{x}) &= \sum_c \widehat{\mathcal{G}}(\mathbf{x}_{c;1}) \otimes \mathcal{S}_{\leq k}(\mathbf{x}_{c;2}) \otimes \widehat{\mathcal{F}}(\mathbf{x}_{c;3}) \\ \widehat{\mathcal{H}}_{(k)}(\mathbf{x}) &= \sum_c (-1)^{\deg' \mathbf{x}_{c;1}} \widehat{\mathcal{F}}(\mathbf{x}_{c;1}) \otimes \mathcal{H}_{\leq k}(\mathbf{x}_{c;2}) \otimes \widehat{\mathcal{F}}(\mathbf{x}_{c;3})\end{aligned}$$

where $((\Delta \otimes \text{id}) \circ \Delta)(\mathbf{x}) = \sum_c \mathbf{x}_{c;1} \otimes \mathbf{x}_{c;2} \otimes \mathbf{x}_{c;3}$. Here we define $\mathcal{S}_{\leq k}$ such that it is \mathcal{S}_i on $B_i\mathcal{C}_1(c, c')$ with $i \leq k$ and is zero otherwise. $\mathcal{H}_{\leq k}$ is defined in a similar way.

We require:

$$\mathbf{m}(\widehat{\mathcal{S}}_{\leq k}(\mathbf{x})) - \widehat{\mathcal{S}}_{\leq k}(\hat{d}\mathbf{x}) = 0, \quad \text{for } \mathbf{x} \in B_i\mathcal{C}_1[1](c, c') \text{ with } i \leq k. \quad (7.14)$$

We also require

$$\begin{aligned}\sum_c \mathbf{m}(\widehat{\mathcal{F}}(\mathbf{x}_{c;1}) \otimes \mathcal{T}_{\leq k}(\mathbf{x}_{c;2}) \otimes \widehat{\mathcal{G}}(\mathbf{x}_{c;3}) \otimes \mathcal{S}_{\leq k}(\mathbf{x}_{c;4}) \otimes \widehat{\mathcal{F}}(\mathbf{x}_{c;5})) \\ = \mathbf{m}(\widehat{\mathcal{H}}_{\leq k}(\mathbf{x})) + \widehat{\mathcal{H}}_{\leq k}(\hat{d}\mathbf{x})\end{aligned} \quad (7.15)$$

for $\mathbf{x} \in B_i\mathcal{C}_1(c, c')$ with $0 < i \leq k$. Here

$$((\Delta \otimes \text{id} \otimes \text{id} \otimes \text{id}) \circ (\Delta \otimes \text{id} \otimes \text{id}) \circ (\Delta \otimes \text{id}) \circ \Delta)(\mathbf{x}) = \sum_c \mathbf{x}_{c;1} \otimes \mathbf{x}_{c;2} \otimes \mathbf{x}_{c;3} \otimes \mathbf{x}_{c;4} \otimes \mathbf{x}_{c;5}.$$

Moreover we require

$$\mathbf{m}_2(\mathcal{T}_0(c) \otimes \mathcal{S}_{\leq 0}(c)) = \mathbf{e}_{\mathcal{F}_{ob}(c), \mathcal{F}_{ob}(c)} + \mathbf{m}_1(\mathcal{H}_0(c)). \quad (7.16)$$

Let us start the construction of \mathcal{S}_k and \mathcal{H}_k by induction.

We first consider the case $k = 0$. By assumption $\mathcal{T}_0(c) \in \mathcal{C}_2(\mathcal{F}(c), \mathcal{G}(c))$ is a homotopy equivalence. Therefore there exists $\mathcal{S}_0(c) \in \mathcal{C}_2(\mathcal{G}(c), \mathcal{F}(c))$ and $\mathcal{H}_0(c) \in \mathcal{C}_2(\mathcal{F}(c), \mathcal{F}(c))$ such that

$$\begin{aligned}\mathbf{m}_1(\mathcal{S}_0(c)) &= 0, \\ \mathbf{m}_2(\mathcal{T}_0(c), \mathcal{S}_0(c)) &= \mathbf{e}_{\mathcal{F}_{ob}(c), \mathcal{F}_{ob}(c)} + \mathbf{m}_1(\mathcal{H}_0(c))\end{aligned}$$

We thus obtain required $\mathcal{S}_0(c)$ and $\mathcal{H}_0(c)$.

Suppose we have obtained \mathcal{S}_i and \mathcal{H}_i for $i \leq k$ such that (7.14) and (7.15) are satisfied. We will construct \mathcal{S}_{k+1} and \mathcal{H}_{k+1} .

Let $\mathbf{x} \in B_{k+1}\mathcal{C}_1(c, c')$. We put

$$O(\mathbf{x}) = \mathbf{m}(\widehat{\mathcal{S}}_{(k)}(\mathbf{x})) - \widehat{\mathcal{S}}_{(k)}(\hat{d}\mathbf{x}) \in \mathcal{C}_2(\mathcal{G}(c), \mathcal{F}(c')).$$

Using (7.14) we can easily check that

$$\mathbf{m}_1(O(\mathbf{x})) + O(\hat{d}_1\mathbf{x}) = 0. \quad (7.17)$$

Here \hat{d}_1 is the coderivation induced by \mathbf{m}_1 . In fact (7.17) follows from $\mathfrak{M}_1(\mathfrak{M}_1(\mathcal{S}_{(k)})) = 0$ and (7.14).

On the other hand we use $\mathfrak{M}_1(\mathfrak{M}_2(\mathcal{T}, \mathcal{S}_{(k)})) = \mathfrak{M}_2(\mathcal{T}, \mathfrak{M}_1(\mathcal{S}_{(k)}))$ together with (7.15), (7.16), and obtain

$$\mathbf{m}_2(\mathcal{T}_0(c), O(\mathbf{x})) = \mathbf{m}_1(B(\mathbf{x})) + B(\hat{d}_1\mathbf{x}), \quad (7.18)$$

where

$$B(\mathbf{x}) = - \sum_c \mathbf{m}(\widehat{\mathcal{F}}(\mathbf{x}_{c;1}) \otimes \mathcal{T}(\mathbf{x}_{c;2}) \otimes \widehat{\mathcal{G}}(\mathbf{x}_{c;3}) \otimes \mathcal{S}_{\leq k}(\mathbf{x}_{c;4}) \otimes \widehat{\mathcal{F}}(\mathbf{x}_{c;5})).$$

(7.17), (7.18) together with the fact that $x \mapsto \mathbf{m}_2(\mathcal{T}_0(c), x)$ is a chain homotopy equivalence : $\mathcal{C}_2(c, c') \rightarrow \mathcal{C}_2(c, c)$ imply that there exists

$$\mathcal{S}'_{k+1} : B_{k+1}\mathcal{C}_1[1](c, c') \rightarrow \mathcal{C}_2(\mathcal{G}_0(c), \mathcal{F}(c'))$$

such that when we use this \mathcal{S}'_{k+1} for \mathcal{S}_{k+1} to define $\mathcal{S}'_{\leq k+1}$ then (7.14) for $k+1$ replaced by k holds. We also use 0 for \mathcal{H}_{k+1} to define $\mathcal{H}'_{(k+1)}$. We then consider

$$\begin{aligned} E_{(k+1)}(\mathbf{x}) &= \sum_c \mathbf{m}(\widehat{\mathcal{F}}(\mathbf{x}_{c;1}) \otimes \mathcal{T}_{\leq k+1}(\mathbf{x}_{c;2}) \otimes \widehat{\mathcal{G}}(\mathbf{x}_{c;3}) \otimes \mathcal{S}'_{\leq k+1}(\mathbf{x}_{c;4}) \otimes \widehat{\mathcal{F}}(\mathbf{x}_{c;5})) \\ &\quad - \mathbf{m}(\widehat{\mathcal{H}}'_{\leq k+1}(\mathbf{x})) - \widehat{\mathcal{H}}'_{\leq k+1}(\widehat{d}\mathbf{x}) \end{aligned}$$

By induction hypothesis $E_{(k+1)}(\mathbf{x}) = 0$ for $\mathbf{x} \in B_i\mathcal{C}_1(c, c')$ with $0 < i \leq k$. We use it and (7.16) to obtain

$$\mathbf{m}_1(E_{(k+1)}(\mathbf{x})) - E_{(k+1)}(\widehat{d}\mathbf{x}) = 0. \quad (7.19)$$

by an easy calculation. Then we again use the fact $x \mapsto \mathbf{m}_2(\mathcal{T}_0(c), x)$ is a chain homotopy equivalence : $\mathcal{C}_2(c, c') \rightarrow \mathcal{C}_2(c, c)$ to obtain $\text{Corr} : B_{k+1}\mathcal{C}_1(c, c') \rightarrow \mathcal{C}_2(\mathcal{G}_0(c), \mathcal{F}(c'))$ and $\mathcal{H}_{k+1} : B_{k+1}\mathcal{C}_1(c, c') \rightarrow \mathcal{C}_2(\mathcal{F}_0(c), \mathcal{F}(c'))$ such that

$$\begin{aligned} E_{(k+1)}(\mathbf{x}) + \mathbf{m}_2(\mathcal{T}_0(c), \text{Corr}(\mathbf{x})) &= \mathbf{m}(\mathcal{H}_{k+1}(\mathbf{x})) + \mathcal{H}_{k+1}(\widehat{d}_1\mathbf{x}), \\ \mathbf{m}_1(\text{Corr}(\mathbf{x})) - \text{Corr}(\widehat{d}_1\mathbf{x}) &= 0. \end{aligned} \quad (7.20)$$

Then $\mathcal{S}_{k+1} = \mathcal{S}'_{k+1} + E_{(k+1)}$ and the above \mathcal{H}_{k+1} satisfy (7.14) and (7.15) with k replaced by $k+1$.

We thus obtained a natural transformation $\mathcal{S} : \mathcal{G} \rightarrow \mathcal{F}$ such that $\mathfrak{M}_2(\mathcal{T}, \mathcal{S})$ is homotopic to the identity natural transformation $\mathcal{F} \rightarrow \mathcal{F}$.

In the same way we can find $\mathcal{S}' : \mathcal{G} \rightarrow \mathcal{F}$ such that $\mathfrak{M}_2(\mathcal{S}', \mathcal{T})$ is homotopic to the identity natural transformation $\mathcal{G} \rightarrow \mathcal{G}$. Using associativity of \mathfrak{M}_2 up to homotopy, it implies that \mathcal{S}' is homotopic to \mathcal{S} . Therefore \mathcal{S}' is a homotopy inverse to \mathcal{T} . The proof of Lemma 7.9 is now complete. \square

The proof of Theorem 7.3 is complete. \square

8. COMPOSITIONS OF LAGRANGIAN CORRESPONDENCES

8.1. Unobstructed-ness of composed correspondences. The main result of this subsection is Theorem 8.2 below.

Situation 8.1. Suppose that $\mathbb{L}_1, \mathbb{L}_2$ and \mathbb{L}_{12} are as in Situation 6.1. We also assume that $\mathbb{L}_2, \mathbb{L}_3$ and \mathbb{L}_{23} are as in Situation 6.1,

For $(L_{12}, \sigma_{12}) \in \mathbb{L}_{12}$, and $(L_{23}, \sigma_{23}) \in \mathbb{L}_{23}$, we assume that $\pi_{X_2} \circ i_{L_{12}} : \tilde{L}_{12} \rightarrow X_2$ is transversal to $\pi_{X_2} \circ i_{L_{23}} : \tilde{L}_{23} \rightarrow X_2$ and put:

$$\tilde{L}_{13} = \tilde{L}_{12} \times_{X_2} \tilde{L}_{23}. \quad (8.1)$$

\diamond

Together with $\tilde{L}_{13} \rightarrow -X_1 \times X_3$ it becomes an immersed Lagrangian submanifold L_{13} of $-X_1 \times X_3$. We assume that L_{13} has clean self-intersection. We remark that L_{13} is $(\pi_1^*(V_1 \oplus TX_1) \times \pi_3^*(V_3))$ -relatively spin by Definition-Lemma 4.7.

Theorem 8.2. *There exists a $(\pi_1^*(V_1 \oplus TX_1) \times \pi_3^*(V_3))$ -relatively spin structure σ_{13} of L_{13} with the following properties. Suppose that b_{12} and b_{23} are bounding cochains of (L_{12}, σ_{12}) and (L_{23}, σ_{23}) , respectively. Then there exists a bounding cochain b_{13} of (L_{13}, σ_{13}) . Moreover there is a canonical way to determine b_{13} from b_{12} and b_{23} up to gauge equivalence. \diamond*

We can enhance the map $(L_{12}, b_{12}), (L_{23}, b_{23}) \mapsto (L_{13}, b_{13})$ to an A_∞ functor as in Theorem 8.5 below.

Situation 8.3.

- (1) Suppose that $\mathbb{L}_1, \mathbb{L}_2, \mathbb{L}_3$ and $\mathbb{L}_{12}, \mathbb{L}_{23}$ are as in Situation 8.1.
We also assume $\mathbb{L}_1, \mathbb{L}_3$ and \mathbb{L}_{13} are as in Situation 6.1.
- (2) Moreover we assume the following. Let $(L_{12}, \sigma_{12}) \in \mathbb{L}_{12}, (L_{23}, \sigma_{23}, b_{23}) \in \mathbb{L}_{23}$. The fiber product L_{13} as in (8.1) together with σ_{13} in Theorem 8.2 gives a pair (L_{13}, σ_{13}) . We require that (L_{13}, σ_{13}) is an element of \mathbb{L}_{13} .

\diamond

Notation 8.4.

- (1) In Situation 8.3 we write

$$(L_{13}, \sigma_{13}) = (L_{23}, \sigma_{23}) \circ (L_{12}, \sigma_{12}) \quad (8.2)$$

and call (L_{13}, σ_{13}) the *geometric composition* of (L_{23}, σ_{23}) and (L_{12}, σ_{12}) .

- (2) Suppose that b_{12} and b_{23} are bounding cochains of (L_{12}, σ_{12}) and (L_{23}, σ_{23}) , respectively. Then by Theorem 8.2 we obtain a bounding cochain b_{13} of (L_{13}, σ_{13}) . We put:

$$(L_{13}, \sigma_{13}, b_{13}) = (L_{23}, \sigma_{23}, b_{23}) \circ (L_{12}, \sigma_{12}, b_{12}) \quad (8.3)$$

- (3) Let $\mathfrak{Fut}(-X_1 \times X_2), \mathfrak{Fut}(-X_2 \times X_3), \mathfrak{Fut}(-X_1 \times X_3)$ be the filtered A_∞ categories obtained in Theorem 3.14, the set of whose objects are $\mathbb{L}_{12}, \mathbb{L}_{23}, \mathbb{L}_{13}$, respectively.

We denote by $\mathfrak{Futst}(-X_1 \times X_2), \mathfrak{Futst}(-X_2 \times X_3), \mathfrak{Futst}(-X_1 \times X_3)$ the associated strict categories.

\diamond

Theorem 8.5. *In Situation 8.3, there exists a strict, unital and gapped filtered A_∞ bi-functor*

$$\mathbf{Comp} : \mathfrak{Futst}(-X_1 \times X_2) \times \mathfrak{Futst}(-X_2 \times X_3) \rightarrow \mathfrak{Futst}(-X_1 \times X_3) \quad (8.4)$$

such that its object part \mathbf{Comp}_{ob} is the map given by (8.3). \diamond

Remark 8.6. In the case when all the Lagrangian submanifolds involved are embedded and monotone, Theorem 8.5 was proved by Ma'u-Wehrheim-Woodwards in [MWW].

Proof. The proofs of both Theorems 8.2 and 8.5 are similar to the proof of Theorem 6.3, Corollary 7.4 and use tri-module and Proposition 6.6. Namely we use the next result.

Proposition 8.7. *In Situation 8.3 there exists a left- $\mathfrak{Fut}(-X_1 \times X_3)$ and right- $\mathfrak{Fut}(-X_1 \times X_2), \mathfrak{Fut}(-X_2 \times X_3)$ filtered A_∞ tri-module $\mathcal{CF}(\mathbb{L}_{13}; \mathbb{L}_{12}, \mathbb{L}_{23})$. \diamond*

The proof is similar to the proof of Theorem 5.25 and is given in the next subsection. We remark however that ‘left’ and ‘right’ appear in the opposite way in Proposition 8.7 compared to Theorem 5.25. The reason will become clear when we discuss the Y -diagram in Section 9.

We now prove Theorem 8.2 assuming Proposition 8.7. Suppose we are in the situation of Theorem 8.2. We define L_{13} as in (8.1). For each relative spin structure σ_{13} of L_{13} the tri-module in Proposition 8.7 associates a Λ_0 module

$$CF((L_{13}, \sigma_{13}); (L_{12}, \sigma_{12}), (L_{23}, \sigma_{23})).$$

We denote it by $CF(L_{13}; L_{12}, L_{23})$ for simplicity.

Lemma 8.8. *There exists a unique choice of σ_{13} such that $CF(L_{13}; L_{12}, L_{23})$ is isomorphic to*

$$\Omega(\tilde{L}_{13} \times_{X_1 \times X_3} \tilde{L}_{13}; \mathbb{R}) \widehat{\otimes}_{\mathbb{R}} \Lambda_0$$

on the diagonal component \tilde{L}_{13} . \diamond

The proof is given at the end of Subsection 8.2.

We define

$$\mathbf{n}_k : CF(L_{13})^{\otimes k} \otimes CF(L_{13}; L_{12}, L_{23}) \rightarrow CF(L_{13}; L_{12}, L_{23})$$

by

$$\begin{aligned} & \mathbf{n}_k(x_1, \dots, x_k; y) \\ &= \sum_{k_{12}=0}^{\infty} \sum_{k_{23}=0}^{\infty} \mathbf{n}_{k; k_{12}, k_{23}}(x_1, \dots, x_k; y; b_{12}, \dots, b_{12}; b_{23}, \dots, b_{23}), \end{aligned} \quad (8.5)$$

where $\mathbf{n}_{k, k_{12}, k_{23}}$ is a structure operation of the tri-module of Proposition 8.7.

Lemma 8.9. $\{\mathbf{n}_k \mid k = 0, 1, 2, \dots\}$ *defines a structure of left filtered A_∞ module on $CF(L_{13}; L_{12}, L_{23})$ over the filtered A_∞ algebra $CF(L_{13})$. \diamond*

The proof is a straightforward calculation using Proposition 8.7.

We remark that we can define the notion of a cyclic element for a left filtered A_∞ module and Proposition 6.6 holds in the case of left filtered A_∞ modules. In fact a left \mathcal{C} module D becomes a right \mathcal{C}^{op} module, and the Maurer-Cartan equation of \mathcal{C}^{op} is the same as that of \mathcal{C} .

Lemma 8.10. *We may take our tri-module structure so that the element*

$$\mathbf{1} \in \Omega^0(\tilde{L}_{13}) \subset \Omega(\tilde{L}_{13} \times_{X_1 \times X_3} \tilde{L}_{13}; \mathbb{R}) \widehat{\otimes}_{\mathbb{R}} \Lambda_0 \cong CF(L_{13}; L_{12}, L_{23})$$

is a cyclic element of the left filtered A_∞ module $CF(L_{13}; L_{12}, L_{23})$ in Lemma 8.9. \diamond

The proof is given at the end of Subsection 8.2.

Now we use Proposition 6.6 to find uniquely a bounding cochain b_{13} of L_{13} such that

$$\mathbf{n}^{b_{13}}(\mathbf{1}) = 0. \quad (8.6)$$

By using Proposition 6.16 we can show that gauge equivalence class of the bounding cochain b_{13} depends only on those of b_{12} and b_{23} , when the filtered A_∞ tri-module $\mathcal{CF}(\mathbb{L}_{13}; \mathbb{L}_{12}, \mathbb{L}_{23})$ is given. The independence of the choices to define $\mathcal{CF}(\mathbb{L}_{13}; \mathbb{L}_{12}, \mathbb{L}_{23})$ is Theorem 14.31 in Section 14.

We have proved Theorem 8.2 assuming several results postponed to later subsections. \square

We turn to the proof of Theorem 8.5. The proof is similar to Section 7. By Proposition 8.7 we obtain a strict and unital filtered A_∞ bi-functor

$$\mathcal{F}^{\text{bi}} : \mathfrak{F}\mathfrak{u}\mathfrak{k}\mathfrak{st}(-X_1 \times X_2) \times \mathfrak{F}\mathfrak{u}\mathfrak{k}\mathfrak{st}(-X_2 \times X_3) \rightarrow \mathcal{F}\mathcal{U}\mathcal{N}\mathcal{C}(\mathfrak{F}\mathfrak{u}\mathfrak{k}\mathfrak{st}(-X_1 \times X_3)^{\text{op}}, \mathcal{C}\mathcal{H}).$$

Let $\mathcal{L}_{12} = (L_{12}, \sigma_{12}, b_{12})$, $\mathcal{L}_{23} = (L_{23}, \sigma_{23}, b_{23})$ be objects of $\mathfrak{F}\mathfrak{u}\mathfrak{k}\mathfrak{st}(-X_1 \times X_2)$ and $\mathfrak{F}\mathfrak{u}\mathfrak{k}\mathfrak{st}(-X_2 \times X_3)$ respectively. By Lemma 8.8 and (8.6) we obtain $\mathcal{L}_{13} = (L_{12}, \sigma_{13}, b_{13})$ which is an object of $\mathfrak{F}\mathfrak{u}\mathfrak{k}\mathfrak{st}(-X_1 \times X_3)$.

Let \mathcal{C} be a strict filtered A_∞ category. Then there exists a filtered A_∞ functor $\mathfrak{Y}\mathfrak{o}\mathfrak{n} : \mathcal{C} \rightarrow \mathcal{F}\mathcal{U}\mathcal{N}\mathcal{C}(\mathcal{C}^{\text{op}}, \mathcal{C}\mathcal{H}) \cong \mathcal{B}\mathcal{I}\mathcal{M}\mathcal{O}\mathcal{D}(\mathcal{C}, \Lambda_0)$, from \mathcal{C} to the category of left- \mathcal{C} modules such that its object part is $c \mapsto (b \mapsto \mathcal{C}(b, c))$.

Proposition 8.11. $\mathcal{F}_{ob}^{\text{bi}}(\mathcal{L}_{12}, \mathcal{L}_{23})$ is homotopy equivalent to $(\mathfrak{Y}\mathfrak{o}\mathfrak{n})_{ob}(\mathcal{L}_{13})$ as filtered A_∞ functors : $\mathfrak{F}\mathfrak{u}\mathfrak{k}\mathfrak{st}(-X_1 \times X_3) \rightarrow \mathcal{C}\mathcal{H}$. \diamond

Proof. The proof is similar to the proof of Theorem 7.3. We repeat the proof for completeness.

We denote by

$$\mathcal{F}^{\text{tri}} : \mathfrak{F}\mathfrak{u}\mathfrak{k}\mathfrak{st}(-X_1 \times X_3)^{\text{op}} \times \mathfrak{F}\mathfrak{u}\mathfrak{k}\mathfrak{st}(-X_1 \times X_2) \times \mathfrak{F}\mathfrak{u}\mathfrak{k}\mathfrak{st}(-X_2 \times X_3) \rightarrow \mathcal{C}\mathcal{H}$$

the strict tri-functor associated to \mathcal{F}^{bi} .

Let $\mathcal{L}_{13}^{(i)}$ $i = 0, \dots, m$ be objects of $\mathfrak{F}\mathfrak{u}\mathfrak{k}\mathfrak{st}(-X_1 \times X_3)$. We define

$$\mathcal{T}_m : \bigotimes_{i=1}^m CF(\mathcal{L}_{13}^{(i-1)}, \mathcal{L}_{13}^{(i)}) \otimes CF(\mathcal{L}_{13}^{(m)}, \mathcal{L}_{13}) \rightarrow CF(\mathcal{L}_{13}^{(0)}; \mathcal{L}_{12}, \mathcal{L}_{23})$$

by the next formula:

$$\mathcal{T}_m(x_1, \dots, x_m; y) = \mathcal{F}_{0,0,m+1}^{\text{tri}}(x_1, \dots, x_m; y; \emptyset, \emptyset; \mathbf{1}). \quad (8.7)$$

Note that

$$x_1 \otimes \dots \otimes x_m \otimes y \in B_{m+1}\mathfrak{F}\mathfrak{u}\mathfrak{k}\mathfrak{st}(-X_1 \times X_3)(\mathcal{L}_{13}, \mathcal{L}_{13}^{(m)}) \quad (8.8)$$

and $\mathbf{1} \in CF(\mathcal{L}_{13}; \mathcal{L}_{12}, \mathcal{L}_{23})$. So the right hand side of (8.7) is defined by Proposition 8.7.

Lemma 8.12. (8.7) defines a natural transformation $\mathcal{T} = \{\mathcal{T}_m \mid m = 0, 1, 2, \dots\}$ from $\mathcal{F}_{ob}^{\text{bi}}(\mathcal{L}_{12}, \mathcal{L}_{23})$ to $\mathfrak{Y}\mathfrak{o}\mathfrak{n}(\mathcal{L}_{13})$. \diamond

Proof. Using the fact that $\mathbf{1}$ is a cycle in $CF(\mathcal{L}_{13}; \mathcal{L}_{12}, \mathcal{L}_{23})$ the lemma is an immediate consequence of Proposition 8.7. \square

Lemma 8.13.

$$\mathcal{T}_0 : CF(\mathcal{L}_{13}^{(0)}, \mathcal{L}_{13}) \rightarrow CF(\mathcal{L}_{13}^{(0)}; \mathcal{L}_{12}, \mathcal{L}_{23})$$

is an isomorphism of Λ_0 module. \diamond

Proof. Using the fact that $\mathbf{1}$ is a cyclic element, we can easily show that \mathcal{T}_0 becomes an isomorphism modulo Λ_+ . Therefore \mathcal{T}_0 itself is also an isomorphism. (We used G -gapped-ness here. In fact we construct the inverse by induction on energy filtration. This induction works when the set of exponents of T appearing in the operations is discrete.) \square

By Lemmas 8.12 and 8.13, we can use Lemma 7.9 to show that \mathcal{T} is a homotopy equivalence. The proof of Proposition 8.11 is complete.

Using Proposition 8.11 and A_∞ Yoneda lemma, we can prove Theorem 8.5 in the same way as Corollary 7.4. \square

8.2. Construction of a tri-module. In this subsection, we prove Proposition 8.7 and complete the proof of Theorems 8.2, 8.5. The proof of Proposition 8.7 is based on a moduli space of pseudo-holomorphic maps from a cylinder, which we describe below.

By the same trick as Subsection 3.4, it suffices to consider the case when $\mathbb{L}_{12}, \mathbb{L}_{23}, \mathbb{L}_{13}$ consist of single elements $\mathcal{L}_{12} = (L_{12}, \sigma_{12}), \mathcal{L}_{23} = (L_{23}, \sigma_{23}), \mathcal{L}_{13} = (L_{13}, \sigma_{13})$, respectively. We consider the cylinder

$$W = S^1 \times \mathbb{R} = [0, 3]/\sim \times \mathbb{R}. \quad (8.9)$$

Here \sim identifies $0 \in [0, 3]$ with $3 \in [0, 3]$. We define W_1, W_2, W_3 by

$$W_1 = [0, 1] \times \mathbb{R} \subset W, \quad W_2 = [1, 2] \times \mathbb{R} \subset W, \quad W_3 = [2, 3] \times \mathbb{R} \subset W \quad (8.10)$$

and also put

$$S_{(i-1)i} = \{i\} \times \mathbb{R} = W_{i-1} \cap W_i \quad i = 1, 2, 3. \quad (8.11)$$

(Here $S_{01} = S_{31}, W_0 = W_3$ by convention.) Note that $\partial W_1 = S_{31} \cup S_{12}$ etc. See Figure 28. We call S_{12}, S_{23}, S_{31} the *seams*. We decompose

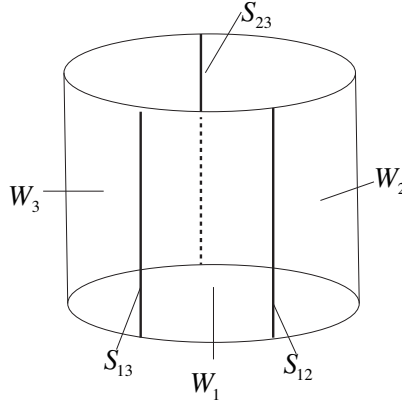

FIGURE 28. Quilted drum W

$$\begin{aligned} \tilde{L}_{12} \times_{X_1 \times X_2} \tilde{L}_{12} &= \bigcup_{a \in \mathcal{A}_{12}} L_{12}(a) \\ \tilde{L}_{23} \times_{X_2 \times X_3} \tilde{L}_{23} &= \bigcup_{a \in \mathcal{A}_{23}} L_{23}(a) \\ \tilde{L}_{13} \times_{X_1 \times X_3} \tilde{L}_{13} &= \bigcup_{a \in \mathcal{A}_{13}} L_{13}(a) \\ (\tilde{L}_{12} \times \tilde{L}_{23} \times \tilde{L}_{13}) \times_{X_1^2 \times X_2^2 \times X_3^2} \Delta &= \bigcup_{a \in \mathcal{A}_{123}} R_{123}(a) \end{aligned} \quad (8.12)$$

where Δ in the fourth line is the diagonal $X_1 \times X_2 \times X_3 \subset X_1^2 \times X_2^2 \times X_3^2$. (See Definition 3.2 (5).³⁸) Let $\vec{a}_{ii'} = (a_{ii',1}, \dots, a_{ii',k_{ii'}}) \in (\mathcal{A}_{ii'})^{k_{ii'}}$ for $ii' = 12, 23, 13$. We call W the *quilted drum*.

³⁸In (8.12) \mathcal{A}_{12} etc. contains the index of the diagonal component. So it corresponds to \mathcal{A}_L^+ in Definition 3.2 (5).

We define the moduli space $\overset{\circ}{\mathcal{M}}_{\text{DR}}(\vec{a}_{12}, \vec{a}_{23}, \vec{a}_{13}; a_-, a_+; E)$ for $a_-, a_+ \in \mathcal{A}_{123}$, $E \in [0, \infty)$ as follows.

Remark 8.14. In the case when X_1 is a point this moduli space is mostly the same as the one we used in Subsection 5.2. In this paper the role of Lagrangian submanifolds of X_i and of $-X_i \times X_j$ are much different. The former gives an object of a filtered A_∞ category $\mathfrak{F}\mathfrak{u}\mathfrak{k}(X_i)$, the latter gives a filtered A_∞ functor $\mathfrak{F}\mathfrak{u}\mathfrak{k}(X_i) \rightarrow \mathfrak{F}\mathfrak{u}\mathfrak{k}(X_j)$. By this reason we use different names and notations to those moduli spaces. \diamond

Definition 8.15. We consider $(\Sigma; \vec{z}_{12}, \vec{z}_{23}, \vec{z}_{13}; u_1, u_2, u_3; \gamma_1, \gamma_2, \gamma_3)$ with the following properties. (See Figure 29.)

- (1) The space Σ is a bordered Riemann surface which is a union of W and trees of sphere components attached to W . The roots of the trees of sphere components are not on the seams S_{12}, S_{23}, S_{13} .
- (2) We denote by Σ_1 the union of W_1 together with trees of sphere components rooted on W_1 . We define Σ_2, Σ_3 in the same way.

The map $u_i : \Sigma_i \rightarrow X_i$ is $-J_{X_i}$ holomorphic for $i = 1, 2, 3$.³⁹

- (3) $\vec{z}_{ii'} = (z_{ii',1}, \dots, z_{ii',k_{ii'}})$ ($ii' = 12, 23, 13$) and $z_{ii',j} \in S_{ii'}$. We put $|\vec{z}_{ii'}| = \{z_{ii',1}, \dots, z_{ii',k_{ii'}}\}$.
- (4) The maps $\gamma_{ii'} : S_{ii'} \setminus |\vec{z}_{ii'}| \rightarrow \tilde{L}_{ii'}$ are smooth and satisfies:

$$i_{L_{ii'}}(\gamma_{ii'}(z)) = (u_i(z), u_{i'}(z)). \quad (8.13)$$

When we identify $S_{ii'} \cong \mathbb{R}$ we require $z_{i,i';j} < z_{i,i';j'}$ for $j < j'$ and $(i, i') = (1, 2)$ or $(2, 3)$ and $z_{13;j} > z_{13;j'}$ for $j < j'$.⁴⁰

- (5) At $\vec{z}_{ii'}$, the map $\gamma_{ii'}$ satisfies the switching condition:

$$\left(\lim_{z \in S_{ii'} \uparrow z_{ii',j}} \gamma_{ii'}(z), \lim_{z \in S_{ii'} \downarrow z_{ii',j}} \gamma_{ii'}(z) \right) \in L_{ii'}(a_{ii',j}) \quad (8.14)$$

for $(i, i') = (1, 2), (2, 3)$ and

$$\left(\lim_{z \in S_{ii'} \downarrow z_{ii',j}} \gamma_{ii'}(z), \lim_{z \in S_{ii'} \uparrow z_{ii',j}} \gamma_{ii'}(z) \right) \in L_{ii'}(a_{ii',j}) \quad (8.15)$$

for $(i, i') = (1, 3)$. Here we identify $S_{ii'} \cong \mathbb{R}$ and then \uparrow, \downarrow have obvious meaning.

- (6) When $z \in S^1 \times \mathbb{R}$ with $\pi_2(z) \rightarrow \pm\infty$, the maps $u_1(z), u_2(z), u_3(z)$ satisfy the asymptotic boundary condition Condition 8.17 below. (Here $\pi_2 : S^1 \times \mathbb{R} \rightarrow \mathbb{R}$ is the projection to the second factor.)
- (7) The stability condition, Definition 8.18 (2) below, is satisfied.
- (8)

$$\int_{\Omega_1} u_1^* \omega_1 + \int_{\Omega_2} u_2^* \omega_2 + \int_{\Omega_3} u_3^* \omega_3 = -E.$$

We remark that the left hand side is non-positive since u_i is $-J_{X_i}$ holomorphic.

³⁹The reason we consider $-J_{X_i}$ holomorphic maps and not J_{X_i} holomorphic maps will be explained in Remark 9.4.

⁴⁰See Remark 8.16 for this enumeration.

In Definition 8.18 (3), we will define an equivalence relation \sim between objects $(\Sigma; \vec{z}_{12}, \vec{z}_{23}, \vec{z}_{13}; u_1, u_2, u_3; \gamma_1, \gamma_2, \gamma_3)$ which satisfy Conditions (1)-(8). We denote by $\mathcal{M}_{\text{DR}}^{\circ}(\vec{a}_{12}, \vec{a}_{23}, \vec{a}_{13}; a_-, a_+; E)$ the set of all the equivalence classes of this equivalence relation. \diamond

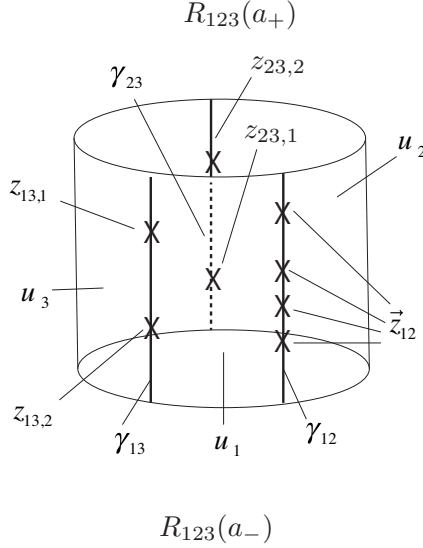

FIGURE 29. An element of $\mathcal{M}_{\text{DR}}^{\circ}(\vec{a}_{12}, \vec{a}_{23}, \vec{a}_{13}; a_-, a_+; E)$

Remark 8.16. We enumerate $z_{12,j}$ and $z_{23,j}$ upward and $z_{13,j}$ downward. Therefore we obtain a left- $\mathfrak{Fuk}(-X_1 \times X_3)$ and right- $\mathfrak{Fuk}(-X_1 \times X_2)$, $\mathfrak{Fuk}(-X_2 \times X_3)$ filtered A_{∞} tri-module by the same reason as explained in Remark 5.30. \diamond

Condition 8.17. The asymptotic boundary condition for $\pi_2(z) \rightarrow -\infty$ is as follows.

- (1) We require the limit $\lim_{\tau \rightarrow -\infty} u_1(t, \tau)$ exists and is independent of $t \in [0, 1]$. We write this limit $\lim_{\pi_2(z) \rightarrow -\infty} u_1(z)$.

We require $\lim_{\pi_2(z) \rightarrow -\infty} u_2(z)$, $\lim_{\pi_2(z) \rightarrow -\infty} u_3(z)$ exist in a similar sense.

- (2)

$$\left(\lim_{\pi_2(z) \rightarrow -\infty} u_1(z), \lim_{\pi_2(z) \rightarrow -\infty} u_2(z), \lim_{\pi_2(z) \rightarrow -\infty} u_3(z) \right) \in R_{123}(a_-).$$

The asymptotic boundary condition for $\pi_2(z) \rightarrow +\infty$ is defined in the same way using $R_{123}(a_+)$. \diamond

Definition 8.18. Let

$$\mathfrak{r} = (\Sigma; \vec{z}_{12}, \vec{z}_{23}, \vec{z}_{13}; u_1, u_2, u_3; \gamma_1, \gamma_2, \gamma_3)$$

$$\mathfrak{r}' = (\Sigma'; \vec{z}'_{12}, \vec{z}'_{23}, \vec{z}'_{13}; u'_1, u'_2, u'_3; \gamma'_1, \gamma'_2, \gamma'_3)$$

be objects satisfying Definition 8.15 (1)-(6).

- (1) An isomorphism from \mathfrak{r} to \mathfrak{r}' is a map $v: \Sigma \rightarrow \Sigma'$ such that:
- (a) It is biholomorphic.

- (b) It sends Σ_i to Σ'_i .
 - (c) It sends $\vec{z}_{ii'}$ to $\vec{z}'_{ii'}$.
 - (d) $u'_i \circ v = u_i$, $\gamma'_{ii'} \circ v = \gamma_{ii}$.
- (2) \mathfrak{r} is said to be *stable* if the set of all isomorphisms from \mathfrak{r} to \mathfrak{r} is finite.
- (3) We say \mathfrak{r} is *equivalent* to \mathfrak{r}' if there exists an isomorphism from \mathfrak{r} to \mathfrak{r}' .

◇

We define evaluation maps

$$\begin{aligned} \text{ev}_{ii'} &= (\text{ev}_{ii',1}, \dots, \text{ev}_{ii',k_{ii'}}) \\ &: \overset{\circ}{\mathcal{M}}_{\text{DR}}(\vec{a}_{12}, \vec{a}_{23}, \vec{a}_{13}; a_-, a_+; E) \rightarrow \prod_{j=1}^{k_{ii'}} L_{ii',k} \end{aligned} \quad (8.16)$$

by the left hand side of (8.14).

We also define

$$\begin{aligned} \text{ev}_\infty &= (\text{ev}_{\infty,+}, \text{ev}_{\infty,-}) : \overset{\circ}{\mathcal{M}}_{\text{DR}}(\vec{a}_{12}, \vec{a}_{23}, \vec{a}_{13}; a_-, a_+; E) \\ &\rightarrow R_{123}(a_+) \times R_{123}(a_-) \end{aligned} \quad (8.17)$$

by the left hand side of Condition 8.17 (2).

Proposition 8.19. *We can define a topology on $\overset{\circ}{\mathcal{M}}_{\text{DR}}(\vec{a}_{12}, \vec{a}_{23}, \vec{a}_{13}; a_-, a_+; E)$ such that it has a compactification $\mathcal{M}_{\text{DR}}(\vec{a}_{12}, \vec{a}_{23}, \vec{a}_{13}; a_-, a_+; E)$, which is a compact metrizable space. They have Kuranishi structures with corners and enjoy the following properties.*

- (1) *The normalized boundary of $\mathcal{M}_{\text{DR}}(\vec{a}_{12}, \vec{a}_{23}, \vec{a}_{13}; a_-, a_+; E)$ is a disjoint union of 2 types of fiber products which we describe below.*
- (2) *The evaluation maps (8.16) and (8.17) extend to strongly smooth maps with respect to this Kuranishi structure. $\text{ev}_{\infty,+}$ is weakly submersive. The extension is compatible with the description of the boundary in item (1).*
- (3) *The orientation bundle of $\mathcal{M}_{\text{DR}}(\vec{a}_{12}, \vec{a}_{23}, \vec{a}_{13}; a_-, a_+; E)$ is isomorphic to the tensor product of the pull backs of Θ^- by the evaluation maps (8.16) and (8.17). For the component $R_{123}(a_+)$ we take Θ^+ in place of Θ^- .*
- (4) *It is compatible with the forgetful map of the marked points corresponding to the diagonal components in the sense of [Fu9, Definition 3.1].*

◇

We describe the boundary components.

- (I) The first type of boundary corresponds to the bubble at one of the Lagrangian boundary conditions L_{12} , L_{23} , L_{13} . We describe the case of L_{12} . Let $b \in \mathcal{A}_{L_{12}}$ and $i \leq j$. We put $\vec{a}_{12}^1 = (a_{12,0}, \dots, a_{12,i}, a_{12,j+1}, \dots, a_{12,k_{12}})$, $\vec{a}_{12}^2 = (b, a_{12,i+1}, \dots, a_{12,j})$. This boundary corresponds to the fiber product:

$$\mathcal{M}_{\text{DR}}(\vec{a}_{12}^1, \vec{a}_{23}, \vec{a}_{13}; a_-, a_+; E_1) \times_{L_{12}(b)} \mathcal{M}'(L_{12}; \vec{a}_{12}^2; E_2). \quad (8.18)$$

Here $E_1 + E_2 = E$. We remark that we use the compactification \mathcal{M}' in the second factor. (See Remark 5.38 and Section 12 for this compactification.)

The bubble at L_{23} and L_{13} are described by the following fiber products:

$$\mathcal{M}_{\text{DR}}(\vec{a}_{12}, \vec{a}_{23}^1, \vec{a}_{13}; a_-, a_+; E_1) \times_{L_{12}(b)} \mathcal{M}'(L_{23}; \vec{a}_{23}^2; E_2), \quad (8.19)$$

$$\mathcal{M}_{\text{DR}}(\vec{a}_{12}, \vec{a}_{23}, \vec{a}_{13}^1; a_-, a_+; E_1) \times_{L_{12}(b)} \mathcal{M}'(L_{13}; \vec{a}_{13}^2; E_2). \quad (8.20)$$

Here \vec{a}_{23}^1 , \vec{a}_{23}^2 and \vec{a}_{13}^1 , \vec{a}_{13}^2 are defined in the same way as \vec{a}_{12}^1 , \vec{a}_{12}^2 .

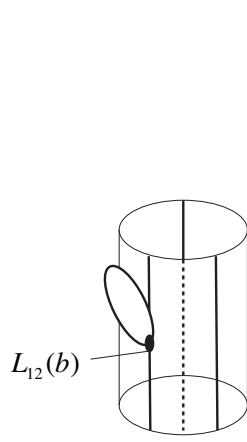
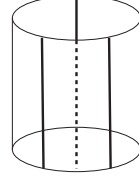

FIGURE 30. An element of (8.18)



$R_{123}(a)$

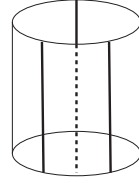

FIGURE 31. An element of (8.21)

- (II) The second type of boundary corresponds to the limit where the domain will split into two parts along the second factor of $S^1 \times \mathbb{R}$. It is described by the fiber product below. Let $j_{ii'} \in \{0, \dots, k_{ii'}\}$. We put $\vec{a}_{ii'}^1 = (a_{ii',1}, \dots, a_{ii',j_{ii'}})$, $\vec{a}_{ii'}^2 = (a_{ii',j_{ii'}+1}, \dots, a_{ii',k_{ii'}})$ if $ii' = 12$ or 23 and $\vec{a}_{ii'}^2 = (a_{ii',1}, \dots, a_{ii',j_{ii'}})$, $\vec{a}_{ii'}^1 = (a_{ii',j_{ii'}+1}, \dots, a_{ii',k_{ii'}})$ if $ii' = 13$. Note in case $j_{ii'} = 0$ (resp. $j_{ii'} = k_{ii'}$), $\vec{a}_{ii'}^1 = \emptyset$ (resp. $\vec{a}_{ii'}^2 = \emptyset$).

$$\mathcal{M}_{\text{DR}}(\vec{a}_{12}^1, \vec{a}_{23}^1, \vec{a}_{13}^1; a_-, a; E_1) \times_{L_{123}(a)} \mathcal{M}_{\text{DR}}(\vec{a}_{12}^2, \vec{a}_{23}^2, \vec{a}_{13}^2; a, a_+; E_2) \quad (8.21)$$

where $E_1 + E_2 = E$ and $a \in \mathcal{A}_{123}$.

We will discuss the orientation in Subsection 17.3. The proof of the other parts of Proposition 8.19 is similar to the proof of Theorem 5.43 and is now a routine. So we only explain (8.18)-(8.20).

We required that u_i is $-J_{X_i}$ holomorphic. Therefore we may regard (u_1, u_2) in a neighborhood of γ_{12} as a pseudo-holomorphic map from $(-\epsilon, 0] \times \mathbb{R}$ to $-X_1 \times X_2$, by $(t, \tau) \mapsto (u_1(t, \tau), u_2(-t, \tau))$ where $t = 0$ is S_{12} . See Figure 32. Therefore when a bubble on γ_{12} occurs it corresponds to a disk bubble as in Figure 33. Note that the marked points on γ_{12} is enumerated upward. Therefore the marked points on the boundary of the bubble is enumerated according to the counter clockwise orientation. (See Figure 33.) This implies that we can describe such a bubble as in (8.18). The explanation of (8.19) is similar.

Let us discuss (8.20). Note that the domain Ω_1 (resp. Ω_3) lies right hand side (resp. left hand side) of the seam γ_{13} . Therefore, (u_1, u_3) in a neighborhood of γ_{13} can be regarded as a pseudo-holomorphic map from $[0, \epsilon) \times \mathbb{R}$ to $-X_1 \times X_3$ by $(t, \tau) \mapsto (u_1(-t, \tau), u_3(t, \tau))$ where $t = 0$ is S_{13} . See Figure 34. Note that the marked points on γ_{13} are enumerated downward. Therefore the marked points on the boundary of the bubble are enumerated according to the counter clockwise

orientation. (See Figure 35.) This implies that we can describe such a bubble as in (8.20).

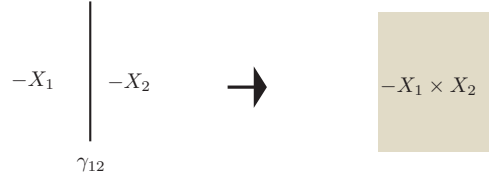

FIGURE 32. Folding the pseudo-holomorphic map near the seam 1

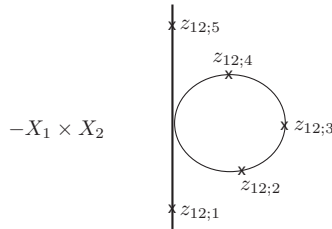

FIGURE 33. Bubble on the seam 1

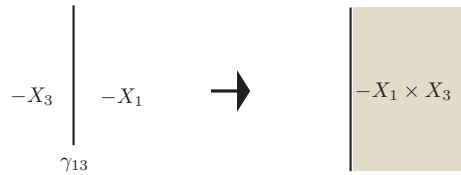

FIGURE 34. Folding the pseudo-holomorphic map near the seam 2

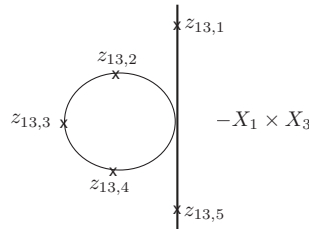

FIGURE 35. Bubble on the seam 2

Proposition 8.20. *For each E_0 there exists a system of CF-perturbations $\widehat{\mathfrak{S}}$ on the spaces $\mathcal{M}(\vec{a}_{12}, \vec{a}_{23}, \vec{a}_{13}; a_-, a_+; E)$ with Kuranishi structures, which are outer collarings of thickenings of those in Proposition 8.19, for $E < E_0$ and such that the following holds.*

- (1) *The CF-perturbations $\widehat{\mathfrak{S}}$ are transversal to 0.*

- (2) The evaluation maps $\text{ev}_{\infty,+}$, $\text{ev}_{\infty,-}$ are strongly submersive with respect to these CF-perturbations.⁴¹
- (3) The CF-perturbations are compatible with the description of the boundary. Namely the restrictions of the CF-perturbations on the boundaries coincide with the fiber product CF-perturbations in the sense of [FOOO10, FOOO13, Lemma-Definition 10.6].
- (4) The CF-perturbations are compatible with the forgetful maps of the boundary marked points corresponding to the diagonal component in the same sense as [Fu9, Definition 5.1].

◇

The proof is the same as Proposition 5.48 and is now a routine. We omit it.

We now use Propositions 8.19 and 8.20 to define a filtered A_∞ tri-module modulo T^{E_0} as follows. We put

$$CF(L_{13}; L_{12}, L_{23}) = \bigoplus_{a \in \mathcal{A}_{123}} \Omega(R(a)) \widehat{\otimes} \Lambda_0. \quad (8.22)$$

We next define structure operations

$$\begin{aligned} \mathbf{n}_{k_{12}, k_{23}, k_{13}}^{<E_0, \epsilon} : CF(L_{13})^{\otimes k_{13}} \otimes CF(L_{13}; L_{12}, L_{23}) \\ \otimes CF(L_{12})^{\otimes k_{12}} \otimes CF(L_{23})^{\otimes k_{23}} \rightarrow CF(L_{12}, L_{23}, L_{13}). \end{aligned}$$

Let $\mathbf{h}_{ii'} = (h_{ii',1} \otimes \cdots \otimes h_{ii',k_{ii'}}) \in CF(L_{ii'})^{\otimes k_{ii'}}$. We consider the case $h_{ii',j}$ is a differential form and is in $\Omega(L_{ii'}(a_{ii',j}))$. (See Definition 3.46.) Let $h_{-\infty} \in \Omega(R(a_-))$.

We define $\Omega(R(a_+))$ component of $\mathbf{n}_{k_{12}, k_{23}, k_{13}}^{\text{tri}, E, \epsilon}$ by

$$\text{ev}_{\infty,+}! \left(\text{ev}_{13}^* \mathbf{h}_{13} \wedge \text{ev}_{\infty,-}^* h_{-\infty} \wedge \text{ev}_{12}^* \mathbf{h}_{12} \wedge \text{ev}_{23}^* \mathbf{h}_{23}; \widehat{\mathfrak{S}}^\epsilon \right). \quad (8.23)$$

Here we use the space $\mathcal{M}(\vec{a}_{12}, \vec{a}_{23}, \vec{a}_{13}; a_-, a_+; E)$ and its CF perturbation $\widehat{\mathfrak{S}}$ to define the integration along the fiber in (8.23). We now put

$$\mathbf{n}_{k_{13}, k_{12}, k_{23}}^{<E_0, \epsilon} := \sum_{E < E_0} T^E \mathbf{n}_{k_{13}, k_{12}, k_{23}}^{E, \epsilon}.$$

Lemma 8.21. $\mathbf{n}_{k_{13}, k_{12}, k_{23}}^{<E_0, \epsilon}$ defines a filtered A_∞ tri-module modulo T^{E_0} . Namely it satisfies

$$\begin{aligned} 0 \equiv & \sum_{c_{13}, c_{12}, c_{23}} (-1)^{*1} \mathbf{n}_{k_{c_{12};1}, k_{c_{23};1}, k_{c_{13};1}}^{<E_0, \epsilon} (\mathbf{z}_{c_{13};1}; \\ & \mathbf{n}_{k_{c_{12};2}, k_{c_{23};2}, k_{c_{13};2}}^{<E_0, \epsilon} (\mathbf{z}_{c_{13};2}; w; \mathbf{x}_{c_{12};1}, \mathbf{y}_{c_{23};1}); \mathbf{x}_{c_{12};2}, \mathbf{y}_{c_{23};2}) \\ & + (-1)^{*2} \mathbf{n}_{*,*,*}^{<E_0, \epsilon} (\mathbf{z}; w; \widehat{d\mathbf{x}}, \mathbf{y}) \\ & + (-1)^{*3} \mathbf{n}_{*,*,*}^{<E_0, \epsilon} (\mathbf{z}; w; \mathbf{x}, \widehat{d\mathbf{y}}) \\ & + (-1)^{*4} \mathbf{n}_{*,*,*}^{<E_0, \epsilon} (\widehat{d\mathbf{z}}; w; \mathbf{x}, \mathbf{y}) \\ & + (-1)^{*5} \delta(\mathbf{n}_{k_{12}, k_{23}, k_{13}}^{<E_0, \epsilon} (\mathbf{z}; w; \mathbf{x}, \mathbf{y})) \\ & + (-1)^{*6} \mathbf{n}_{k_{12}, k_{23}, k_{13}}^{<E_0, \epsilon} (\mathbf{z}; \delta w; \mathbf{x}, \mathbf{y}) \pmod{T^{E_0}}. \end{aligned} \quad (8.24)$$

⁴¹We do not require that the map $(\text{ev}_{\infty,+}, \text{ev}_{\infty,-})$ is strongly submersive.

Here $\Delta \mathbf{x} = \sum_{c_{12}} \mathbf{x}_{c_{12};1} \otimes \mathbf{x}_{c_{12};2}$. We define $\mathbf{y}_{c_{23};1}$, $\mathbf{y}_{c_{23};2}$, $\mathbf{z}_{c_{13};1}$, $\mathbf{z}_{c_{13};2}$ in the same way. The signs are by Koszul rule. δ is the operator induced from the de Rham differential in the same way as (3.41), (3.42). \diamond

Proof. The proof is similar to the proof of Proposition 5.48 and is now a routine. By Stokes' theorem (See [FOOO10, FOOO13, Proposition 9.26].) the sum of fifth and six terms is obtained by a similar formula as (8.23) but using the integration along the fiber on the boundary $\partial \mathcal{M}(\vec{a}_{12}, \vec{a}_{23}, \vec{a}_{13}; a_-, a_+; E)$. This boundary is described by (8.18)-(8.21). By using the composition formula ([FOOO10, FOOO13, Theorem 10.20]) we find that (8.18), (8.19), (8.20) and (8.21) correspond to 2nd, 3rd, 4th and first term of (8.24) respectively. \square

The rest of the proof of Proposition 8.7 is the same as the last step of the proof of Theorem 5.25. Namely we show that $\mathfrak{n}^{<E', \epsilon}$ is homotopic to $\mathfrak{n}^{<E, \epsilon}$ modulo T^E if $E < E'$ and also $\mathfrak{n}^{<E, \epsilon}$ is homotopic to $\mathfrak{n}^{<E, \epsilon'}$. We use this fact and homological algebra to find required filtered A_∞ tri-module. \square

Proof of Lemma 8.8. The proof is the same as the proof of Lemma 6.7. We first observe

$$(\tilde{L}_{12} \times \tilde{L}_{23} \times \tilde{L}_{13}) \times_{X_1^2 \times X_2^2 \times X_3^2} \Delta \cong \tilde{L}_{13} \times_{X_1 \times X_3} \tilde{L}_{13}. \quad (8.25)$$

Therefore $CF(\mathcal{L}_{12}, \mathcal{L}_{23}, \mathcal{L}_{13})$ is $\Omega(\tilde{L}_{13} \times_{X_1 \times X_3} \tilde{L}_{13}, \Theta) \widehat{\otimes} \Lambda_0$ with some local system Θ . By using Lemma 3.11 we can uniquely choose relative spin structure σ_{13} so that Θ is trivial. \square

Proof of Proposition 8.10. The proof is the same as Proposition 6.12. It suffices to show that \mathfrak{n}_0 is congruent to the identity map modulo Λ_+ . By definition \mathfrak{n}_0 is congruent to the map determined by the moduli space $\mathcal{M}(\emptyset, \emptyset, a_{13}; o, a_{13}; 0)$. Here o denotes the diagonal component and we use the diffeomorphism (8.25) to identify \mathcal{A}_{123} with $\mathcal{A}_{L_{13}}$. (Here \mathcal{A}_{123} (resp. $\mathcal{A}_{L_{13}}$) is the set of connected components of the left hand side (resp. right hand side) of (8.25).) Using the fact that $\mathcal{M}(\emptyset, \emptyset, a_{13}; o, a_{13}; 0)$ consists of constant maps, we can easily show that it induces the identity map. \square

9. COMPATIBILITY OF COMPOSITIONS

9.1. Statement.

Theorem 9.1. *Suppose we are in Situation 8.3. Let $\mathcal{L}_{12} \in \mathfrak{DB}(\mathfrak{Fufst}(-X_1 \times X_2))$, $\mathcal{L}_{23} \in \mathfrak{DB}(\mathfrak{Fufst}(-X_2 \times X_3))$. We put*

$$\mathcal{L}_{13} = \mathcal{L}_{23} \circ \mathcal{L}_{12} = \mathbf{Comp}_{ob}(\mathcal{L}_{12}, \mathcal{L}_{23}).$$

Then the correspondence functor $\mathcal{W}_{\mathcal{L}_{13}}$ associated to \mathcal{L}_{13} is homotopy equivalent to the composition $\mathcal{W}_{\mathcal{L}_{23}} \circ \mathcal{W}_{\mathcal{L}_{12}}$ of the correspondence functors associated to \mathcal{L}_{12} and \mathcal{L}_{23} respectively. Namely

$$\mathcal{W}_{\mathcal{L}_{23} \circ \mathcal{L}_{12}} \sim \mathcal{W}_{\mathcal{L}_{23}} \circ \mathcal{W}_{\mathcal{L}_{12}} \quad (9.1)$$

\diamond

Note that

$$\begin{aligned} \mathcal{W}_{\mathcal{L}_{12}} &: \mathfrak{Fufst}(X_1; \mathbb{L}_1) \rightarrow \mathfrak{Fufst}(X_2; \mathbb{L}_2), \\ \mathcal{W}_{\mathcal{L}_{23}} &: \mathfrak{Fufst}(X_2; \mathbb{L}_2) \rightarrow \mathfrak{Fufst}(X_3; \mathbb{L}_3), \\ \mathcal{W}_{\mathcal{L}_{13}} &: \mathfrak{Fufst}(X_1; \mathbb{L}_1) \rightarrow \mathfrak{Fufst}(X_3; \mathbb{L}_3). \end{aligned}$$

(9.1) is a homotopy equivalence as strict, unital and gapped filtered A_∞ functors from $\mathfrak{F}\mathfrak{u}\mathfrak{t}\mathfrak{st}(X_1; \mathbb{L}_1)$ to $\mathfrak{F}\mathfrak{u}\mathfrak{t}\mathfrak{st}(X_3; \mathbb{L}_3)$.

In this section we prove the following weaker version of Theorem 9.1.

Proposition 9.2. *Suppose we are in the situation of Theorem 9.1. Let $\mathcal{L}_1 = (L_1, \sigma_1, b_1)$ be an object of $\mathfrak{F}\mathfrak{u}\mathfrak{t}\mathfrak{st}(X_1; \mathbb{L}_1)$. We put*

$$\begin{aligned} (\mathcal{W}_{\mathcal{L}_{23} \circ \mathcal{L}_{12}})_{ob}(\mathcal{L}_1) &= \mathcal{L}_3^{(1)} = (L_3^{(1)}, \sigma_3^{(1)}, b_3^{(1)}) \\ (\mathcal{W}_{\mathcal{L}_{13}})_{ob}(\mathcal{L}_1) &= \mathcal{L}_3^{(2)} = (L_3^{(2)}, \sigma_3^{(2)}, b_3^{(2)}). \end{aligned}$$

Then we have the following:

- (1) $(L_3^{(1)}, \sigma_3^{(1)}) = (L_3^{(2)}, \sigma_3^{(2)})$. Here the equality is as submanifolds equipped with relative spin structures.
- (2) $b_3^{(1)}$ is gauge equivalent to $b_3^{(2)}$ in the sense of [FOOO1, Definition 4.3.1].

◇

Proposition 9.2 is the object part of Theorem 9.1. The morphism part will be proved in the next section. Proposition 9.2 (1) is proved in Subsection 17.4.

9.2. Lekili-Lipyanskiy's Y-diagram. The proofs of Theorem 9.1 and Proposition 9.2 are based on moduli spaces of configurations introduced by Lekili-Lipyanskiy in [LL], which they called a Y -diagram. In this subsection we define and study the moduli space of Y -diagrams.

We consider the domain $\mathcal{Y} = \mathcal{Y}_1 \cup \mathcal{Y}_2 \cup \mathcal{Y}_3 \subset \mathbb{C}$ as in Figure 36. The boundary

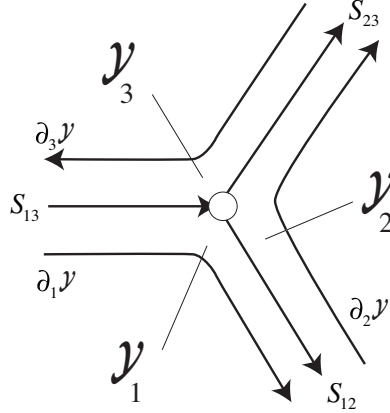

FIGURE 36. Domain \mathcal{Y}

$\partial\mathcal{Y}$ has three connected components $\partial_i\mathcal{Y} = \partial\mathcal{Y} \cap \partial\mathcal{Y}_i$ ($i = 1, 2, 3$), which are diffeomorphic to \mathbb{R} . We choose the diffeomorphism so that the direction of the arrow in Figure 36 coincides with the positive direction of \mathbb{R} .

The closure of the domain \mathcal{Y} minus a point $S_{12} \cap S_{23} \cap S_{13}$ has 4 ends. We identify the end which is the neighborhood of the white circle in Figure 36 with $S^1 \times (-\infty, 0]$. We take a diffeomorphism

$$\phi_{123} : S^1 \times (-\infty, 0] \rightarrow \mathcal{Y}.$$

to an open subset such that:

Condition 9.3.

- (1) ϕ_{123} is an anti-biholomorphic diffeomorphism to its image, which is a neighborhood of the point $S_{12} \cap S_{23} \cap S_{13}$ minus $S_{12} \cap S_{23} \cap S_{13}$.
- (2) We identify $S^1 \times (-\infty, 0] \subset S^1 \times (-\infty, \infty) = W$, where W is as in (8.9). Then we require

$$W_i \cap (S^1 \times (-\infty, 0]) = \phi_{123}^{-1}(\mathcal{Y}_i)$$

for $i = 1, 2, 3$.

◇

Remark 9.4. We emphasize that ϕ_{123} is an *anti*-biholomorphic map. In fact $\phi_{123}(t, \tau) = e^{2\pi(\tau+it)}$ and the complex structure of the domain is $j(\partial/\partial t) = \partial/\partial \tau$. We will identify the image of ϕ_{123} as a part of the domain of the pseudo-holomorphic drum appearing in Section 8. Then a J_{X_i} holomorphic map on W_i will become $-J_{X_i}$ holomorphic from an open set of the drum. This is the reason why we required that the map u_i is $-J_{X_i}$ holomorphic in Definition 8.15 (2).

The other three ends intersect with \mathcal{Y}_1 and \mathcal{Y}_2 (resp. \mathcal{Y}_2 and \mathcal{Y}_3 , \mathcal{Y}_1 and \mathcal{Y}_3). We take a diffeomorphism

$$\phi_{ii'} : [-1, 1] \times (-\infty, 0] \rightarrow \mathcal{Y}.$$

to an open subset for $(ii') = (12), (23)$, or (13) such that:

Condition 9.5.

- (1) The map $\phi_{ii'}$ is biholomorphic.
- (2) We require $[-1, 0] \times (-\infty, 0] = \phi_{ii'}^{-1}(\mathcal{Y}_i)$, $[0, 1] \times (-\infty, 0] = \phi_{ii'}^{-1}(\mathcal{Y}_{i'})$ for $(ii') = (12)$ or (23) . We also require $[-1, 0] \times [0, +\infty) = \phi_{13}^{-1}(\mathcal{Y}_i)$, $[0, 1] \times [0, +\infty) = \phi_{13}^{-1}(\mathcal{Y}_i)$ for $i = 1, 3$.

◇

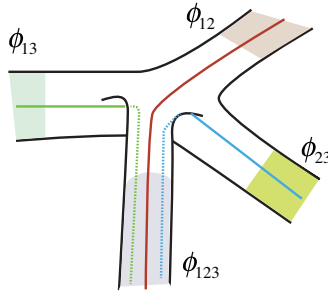

FIGURE 37. $\phi_{123}, \phi_{ii'}$

We next put

$$S_{ii'} = \mathcal{Y}_i \cap \mathcal{Y}_{i'} \tag{9.2}$$

for $(ii') = (12), (23)$, or (13) . $S_{ii'}$ is diffeomorphic to \mathbb{R} . We call $S_{ii'}$ a *seam* and the point $S_{12} \cap S_{23} \cap S_{13}$ the *hole*. We take a diffeomorphism between the seams and \mathbb{R} as follows.

- (so1) Suppose that $(ii') = (12), (23)$. Then for $-\tau$ which is sufficiently negative the point of $S_{ii'}$ corresponding to $-\tau$ lies in the image of $\phi_{ii'}$.
- (so2) Suppose that $(ii') = (13)$. Then for τ which is sufficiently positive the point of S_{13} corresponding to τ lies in the image of ϕ_{13} .

See the arrows in Figure 36 which show the orientation of the seams. Note that this orientation coincides with the way we enumerate the marked points on the seams in the case of pseudo-holomorphic drums.

We orient the boundary of \mathcal{Y} by the usual counter clock-wise orientation of a boundary of a domain of \mathbb{C} . (See the arrows in Figure 36.) Then on the images of $\phi_{ii'}$, the orientation of the boundary and the seams coincide with the way we enumerate the marked points in Definition 5.27 (3).

We decompose fiber products to connected components:

$$\tilde{L}_{ii'} \times_{X_i \times X_{i'}} \tilde{L}_{ii'} = \bigcup_{a \in \mathcal{A}_{L_{ii'}}} L_{ii'}(a) \quad (9.3)$$

$$\tilde{L}_i \times_{X_i} \tilde{L}_i = \bigcup_{a \in \mathcal{A}_{L_i}} L_i(a) \quad (9.4)$$

$$\tilde{L}_i \times_{X_i} \tilde{L}_{ii'} \times_{X_{i'}} \tilde{L}_{i'} = \bigcup_{a \in \mathcal{A}_{R_{ii'}}} R_{ii'}(a) \quad (9.5)$$

$$(L_{12} \times L_{23} \times L_{13}) \times_{(X_1 \times X_2 \times X_3)^2} \Delta = \bigcup_{a \in \mathcal{A}_{123}} R_{123}(a) \quad (9.6)$$

where Δ is the diagonal in $(X_1 \times X_2 \times X_3)^2$. See Definition 3.2 (5).

Let $\vec{a}_{ii'} = (a_{ii',1}, \dots, a_{ii',k_{ii'}}) \in (\mathcal{A}_{L_{ii'}})^{k_{ii'}}$, $\vec{a}_i = (a_{i,1}, \dots, a_{i,k_i}) \in (\mathcal{A}_{L_i})^{k_i}$, $a_{\infty,123} \in \mathcal{A}_{123}$. Let $\vec{a}_{\infty} = (a_{\infty,12}, a_{\infty,23}, a_{\infty,13})$ with $a_{\infty,ii'} \in \mathcal{A}_{R_{ii'}}$.

We next define the set $\mathcal{M}_{\mathcal{Y}}(\vec{a}_{12}, \vec{a}_{23}, \vec{a}_{13}; \vec{a}_1, \vec{a}_2, \vec{a}_3; a_{\infty,123}, \vec{a}_{\infty}; E)$.

Definition 9.6. We consider

$$(\Sigma; \vec{z}_1, \vec{z}_2, \vec{z}_3; \vec{z}_{12}, \vec{z}_{23}, \vec{z}_{13}; u_1, u_2, u_3; \gamma_1, \gamma_2, \gamma_3; \gamma_{12}, \gamma_{23}, \gamma_{13})$$

with the following properties. (See Figure 38.)

- (1) The space Σ is a bordered Riemann surface which is a union of \mathcal{Y} and trees of sphere components attached to \mathcal{Y} . The roots of the trees of sphere components are neither on S_{12}, S_{23}, S_{13} nor on $\partial\mathcal{Y}$.
- (2) We denote by Σ_1 the union of \mathcal{Y}_1 and the trees of sphere components rooted on \mathcal{Y}_1 . We define Σ_2, Σ_3 in the same way. The map $u_i : \Sigma_i \rightarrow X_i$ is J_{X_i} holomorphic for $i = 1, 2, 3$.
- (3) $\vec{z}_i = (z_{i,1}, \dots, z_{i,k_i})$ ($i = 1, 2, 3$) and $z_{i,j} \in \partial_i\mathcal{Y}$. We require $z_{i,j} < z_{i,j'}$ for $j < j'$, where we identify $\partial_i\mathcal{Y} \cong \mathbb{R}$ using the counter clockwise orientation.
- (4) $\vec{z}_{ii'} = (z_{ii',1}, \dots, z_{ii',k_{ii'}})$ ($ii' = 12, 23, 13$) and $z_{ii',j} \in S_{ii'}$. We require $z_{ii',j} < z_{ii',j'}$ for $j < j'$, where we identify $S_{ii'} \cong \mathbb{R}$ as in (so1),(so2). We put $|\vec{z}_{ii'}| = \{z_{ii',1}, \dots, z_{ii',k_{ii'}}\}$.
- (5) The maps $\gamma_i : \partial\Sigma \cap \mathcal{Y}_i \setminus |\vec{z}_i| \rightarrow \tilde{L}_i$ are smooth and satisfy

$$i_{L_i}(\gamma_i(z)) = u_i(z). \quad (9.7)$$

- (6) The maps $\gamma_{ii'} : S_{ii'} \setminus |\vec{z}_{ii'}| \rightarrow \tilde{L}_{ii'}$, $(ii') = (12), (23), (13)$, are smooth and satisfy

$$i_{L_{ii'}}(\gamma_{ii'}(z)) = (u_i(z), u_{i'}(z)). \quad (9.8)$$

(7) On \vec{z}_i , the map γ_i satisfies the switching condition:

$$\left(\lim_{z \in S_i \uparrow \vec{z}_{i,j}} \gamma_i(z), \lim_{z \in \partial \Sigma \cap \mathcal{Y}_i \downarrow \vec{z}_{i,j}} \gamma_i(z) \right) \in L_i(a_{i,j}) \quad (9.9)$$

Here we identify $\partial \Sigma \cap \mathcal{Y}_i \cong \mathbb{R}$ by the counter clockwise orientation and then \uparrow, \downarrow have obvious meaning similar to Definition 3.17 (5).

(8) On $\vec{z}_{ii'}$, the map $\gamma_{ii'}$ satisfies the switching condition:

$$\left(\lim_{z \in S_{ii'} \uparrow \vec{z}_{ii',j}} \gamma_{ii'}(z), \lim_{z \in S_{ii'} \downarrow \vec{z}_{ii',j}} \gamma_{ii'}(z) \right) \in L_{ii'}(a_{ii',j}) \quad (9.10)$$

Here we identify $S_{ii'} \cong \mathbb{R}$ by (so1),(so2) and then \uparrow, \downarrow have obvious meaning similar to Definition 3.17 (5).

(9) On the image of $\phi_{ii'}$, the map $\gamma_{ii'}$ satisfies the asymptotic boundary condition:

$$\begin{cases} \lim_{\tau \rightarrow +\infty} ((\gamma_i(-\tau), \gamma_{i'}(\tau), \gamma_{ii'}(-\tau)) \in R_{ii'}(a_{\infty,ii'}) & \text{if } (ii') = (12) \text{ or } (23), \\ \lim_{\tau \rightarrow +\infty} ((\gamma_1(\tau), \gamma_3(-\tau), \gamma_{13}(\tau)) \in R_{13}(a_{\infty,13}). \end{cases} \quad (9.11)$$

(10) On the image of ϕ_{123} , the map $\gamma_{ii'}$ satisfies the asymptotic boundary condition:

$$\lim_{\tau \rightarrow +\infty} (\gamma_{12}(-\tau), \gamma_{23}(-\tau), \gamma_{13}(\tau)) \in R_{123}(a_{\infty,123}). \quad (9.12)$$

(11) The stability condition, Definition 9.7 (2) below, is satisfied.

(12)

$$\int_{\Sigma_1} u_1^*(\omega_1) + \int_{\Sigma_2} u_2^*(\omega_2) + \int_{\Sigma_3} u_3^*(\omega_3) = E.$$

In Definition 9.7 (3), we will define an equivalence relation \sim among the objects $(\Sigma; \vec{z}_{12}, \vec{z}_{23}, \vec{z}_{13}; u_1, u_2, u_3; \gamma_1, \gamma_2, \gamma_3; \gamma_{12}, \gamma_{23}, \gamma_{13})$ satisfying (1)-(12). We denote by $\overset{\circ}{\mathcal{M}}_Y(\vec{a}_{12}, \vec{a}_{23}, \vec{a}_{13}; \vec{a}_1, \vec{a}_2, \vec{a}_3; a_{\infty,-}, \vec{a}_{\infty,+}; E)$ the set of all the equivalence classes of this equivalence relation. \diamond

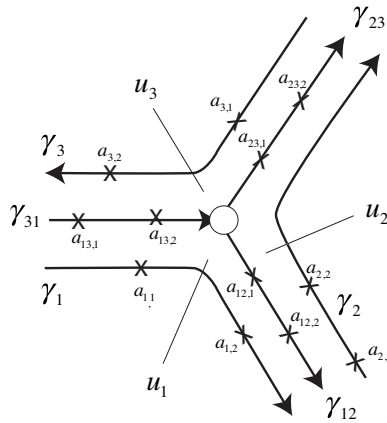

FIGURE 38. An element of $\overset{\circ}{\mathcal{M}}_Y(\vec{a}_{12}, \vec{a}_{23}, \vec{a}_{13}; \vec{a}_1, \vec{a}_2, \vec{a}_3, a_{\infty,-}, \vec{a}_{\infty,+}; E)$

Definition 9.7. Let

$$\begin{aligned}\mathfrak{r} &= (\Sigma; \vec{z}_1, \vec{z}_2, \vec{z}_3; \vec{z}_{12}, \vec{z}_{23}, \vec{z}_{13}; u_1, u_2, u_3; \gamma_1, \gamma_2, \gamma_3; \gamma_{12}, \gamma_{23}, \gamma_{13}) \\ \mathfrak{r}' &= (\Sigma'; \vec{z}'_1, \vec{z}'_2, \vec{z}'_3; \vec{z}'_{12}, \vec{z}'_{23}, \vec{z}'_{13}; u'_1, u'_2, u'_3; \gamma'_1, \gamma'_2, \gamma'_3; \gamma'_{12}, \gamma'_{23}, \gamma'_{13})\end{aligned}$$

be objects satisfying Definition 9.6 (1)-(10) and (12).

- (1) An isomorphism from \mathfrak{r} to \mathfrak{r}' is a map $v : \Sigma \rightarrow \Sigma'$ such that:
 - (a) It is biholomorphic.
 - (b) It sends Σ_i to Σ'_i .
 - (c) It sends \vec{z}_i to \vec{z}'_i and $\vec{z}_{ii'}$ to $\vec{z}'_{ii'}$.
 - (d) $u'_i \circ v = u_i$, $\gamma'_i \circ v = \gamma_i$, $\gamma'_{ii'} \circ v = \gamma_{ii'}$.
- (2) \mathfrak{r} is said to be *stable* if the set of all isomorphisms from \mathfrak{r} to \mathfrak{r} is finite.
- (3) We say \mathfrak{r} is *equivalent* to \mathfrak{r}' if there exists an isomorphism from \mathfrak{r} to \mathfrak{r}' .

◇

We define the evaluation maps

$$\begin{aligned}\text{ev}_i &= (\text{ev}_{i,1}, \dots, \text{ev}_{i,k_i}) \\ &: \overset{\circ}{\mathcal{M}}_Y(\vec{a}_{12}, \vec{a}_{23}, \vec{a}_{13}; \vec{a}_1, \vec{a}_2, \vec{a}_3, a_{\infty,123}, \vec{a}_{\infty}; E) \rightarrow \prod_{j=1}^{k_i} L_i(a_{i,k})\end{aligned}\quad (9.13)$$

and

$$\begin{aligned}\text{ev}_{ii'} &= (\text{ev}_{ii',1}, \dots, \text{ev}_{ii',k_{ii'}}) \\ &: \overset{\circ}{\mathcal{M}}_Y(\vec{a}_{12}, \vec{a}_{23}, \vec{a}_{13}; \vec{a}_1, \vec{a}_2, \vec{a}_3, a_{\infty,123}, \vec{a}_{\infty}; E) \rightarrow \prod_{j=1}^{k_{ii'}} L_{ii'}(a_{ii',k})\end{aligned}\quad (9.14)$$

by the left hand sides of (9.9) and (9.10), respectively.

We also define

$$\begin{aligned}\widehat{\text{ev}}_{\infty} &= (\text{ev}_{\infty,123}, \text{ev}_{\infty}) = (\text{ev}_{\infty,123}, (\text{ev}_{\infty,12}, \text{ev}_{\infty,23}, \text{ev}_{\infty,13})) \\ &: \overset{\circ}{\mathcal{M}}_Y(\vec{a}_{12}, \vec{a}_{23}, \vec{a}_{31}; \vec{a}_1, \vec{a}_2, \vec{a}_3, a_{\infty,123}, \vec{a}_{\infty}; E) \\ &\rightarrow R(a_{\infty,123}) \times L_{12}(a_{\infty,12}) \times L_{23}(a_{\infty,23}) \times L_{13}(a_{\infty,13})\end{aligned}\quad (9.15)$$

by using the left hand side of (9.11) and (9.12).

Proposition 9.8. *We can define a topology, stable map topology, on the moduli space $\overset{\circ}{\mathcal{M}}_Y(\vec{a}_{12}, \vec{a}_{23}, \vec{a}_{13}; \vec{a}_1, \vec{a}_2, \vec{a}_3, a_{\infty,123}, \vec{a}_{\infty}; E)$ such that it has a compactification $\mathcal{M}_Y(\vec{a}_{12}, \vec{a}_{23}, \vec{a}_{13}; \vec{a}_1, \vec{a}_2, \vec{a}_3, a_{\infty,123}, \vec{a}_{\infty}; E)$, which is a compact metrizable space. They have Kuranishi structures with corners which enjoy the following properties.*

- (1) *The normalized boundary of $\mathcal{M}_Y(\vec{a}_{12}, \vec{a}_{23}, \vec{a}_{13}; \vec{a}_1, \vec{a}_2, \vec{a}_3, a_{\infty,123}, \vec{a}_{\infty}; E)$ is a disjoint union of 4 types of fiber products which we describe below.*
- (2) *The evaluation maps (9.13), (9.14) and (9.15) extend to strongly smooth maps with respect to this Kuranishi structure. The map ev_{∞} in (9.15) is weakly submersive. The extension is compatible with the description of the boundary in item (1).*
- (3) *The orientation local system of $\mathcal{M}_Y(\vec{a}_{12}, \vec{a}_{23}, \vec{a}_{13}; \vec{a}_1, \vec{a}_2, \vec{a}_3, a_{\infty,123}, \vec{a}_{\infty}; E)$ is isomorphic to the tensor product of the pull backs of Θ^- by the evaluation maps (9.13), (9.14) and (9.15). For the component $L_{13}(a_{13})$ we take Θ^+ in place of Θ^- .*

- (4) *The Kuranishi structures are compatible with the forgetful maps of the marked points corresponding to the diagonal components.*

◇

We now describe the boundary components.

- (I) The first type of boundary corresponds to a bubble at one of the Lagrangian boundary conditions L_{12} , L_{23} , L_{13} . We describe the case of L_{12} . Let $b \in \mathcal{A}_{L_{12}}$ and $i \leq j$. We put $\vec{a}_{12}^1 = (a_{12,0}, \dots, a_{12,i}, b, a_{12,j+1}, \dots, a_{12,k_{12}})$, $\vec{a}_{12}^2 = (b, a_{12,i+1}, \dots, a_{12,j})$. This boundary corresponds to the fiber product

$$\mathcal{M}_Y(\vec{a}_{12}^1, \vec{a}_{23}, \vec{a}_{31}; \vec{a}_1, \vec{a}_2, \vec{a}_3; a_{\infty,123}, \vec{a}_\infty; E_1) \times_{L_{12}(b)} \mathcal{M}'(L_{12}; \vec{a}_{12}^2; E_2) \quad (9.16)$$

Here $E_1 + E_2 = E$. We remark that we use the compactification \mathcal{M}' in the second factor. The compactification \mathcal{M}' is discussed in Remark 5.38 and Section 12. See Figure 39.

The bubble at L_{23} and L_{13} are described by the following fiber products.

$$\mathcal{M}_Y(\vec{a}_{12}, \vec{a}_{23}^1, \vec{a}_{31}; \vec{a}_1, \vec{a}_2, \vec{a}_3; a_{\infty,123}, \vec{a}_\infty; E_1) \times_{L_{23}(b)} \mathcal{M}'(L_{23}; \vec{a}_{23}^2; E_2) \quad (9.17)$$

$$\mathcal{M}_Y(\vec{a}_{12}, \vec{a}_{23}, \vec{a}_{13}^1; \vec{a}_1, \vec{a}_2, \vec{a}_3; a_{\infty,123}, \vec{a}_\infty; E_1) \times_{L_{13}(b)} \mathcal{M}'(L_{13}; \vec{a}_{13}^2; E_2) \quad (9.18)$$

Here \vec{a}_{23}^1 , \vec{a}_{23}^2 and \vec{a}_{13}^1 , \vec{a}_{13}^2 are defined in the same way as \vec{a}_{12}^1 , \vec{a}_{12}^2 .

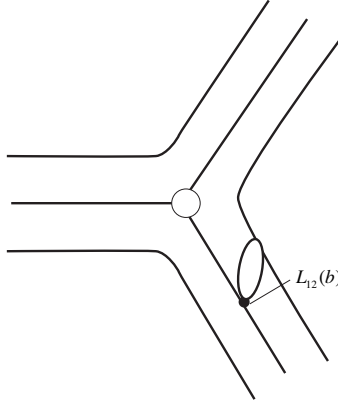

FIGURE 39. Boundary of type (I)

- (II) The second type of boundary corresponds to a bubble at one of the Lagrangian boundary conditions L_1 , L_2 , L_3 . We describe the case of L_1 . Let $b \in \mathcal{A}_{L_1}$ and $i \leq j$. We put $\vec{a}_1^1 = (a_{1,0}, \dots, a_{1,i}, b, a_{1,j+1}, \dots, a_{1,k_1})$, $\vec{a}_1^2 = (b, a_{1,i+1}, \dots, a_{1,j})$. This boundary corresponds to the fiber product

$$\mathcal{M}_Y(\vec{a}_{12}, \vec{a}_{23}, \vec{a}_{13}; \vec{a}_1^1, \vec{a}_2, \vec{a}_3; a_{\infty,123}, \vec{a}_\infty; E_1) \times_{L_1(b)} \mathcal{M}(L_1; \vec{a}_1^2; E_2) \quad (9.19)$$

Here $E_1 + E_2 = E$. See Figure 40

The bubble at L_2 and L_3 are described by the following fiber products.

$$\mathcal{M}_Y(\vec{a}_{12}, \vec{a}_{23}, \vec{a}_{13}; \vec{a}_1, \vec{a}_2^1, \vec{a}_3; a_{\infty,123}, \vec{a}_\infty; E_1) \times_{L_2(b)} \mathcal{M}(L_2; \vec{a}_2^2; E_2) \quad (9.20)$$

$$\mathcal{M}_Y(\vec{a}_{12}, \vec{a}_{23}, \vec{a}_{13}; \vec{a}_1, \vec{a}_2, \vec{a}_3^1; a_{\infty,123}, \vec{a}_\infty; E_1) \times_{L_3(b)} \mathcal{M}(L_3; \vec{a}_3^2; E_2) \quad (9.21)$$

Here \vec{a}_2^1 , \vec{a}_2^2 and \vec{a}_3^1 , \vec{a}_3^2 are defined in the same way as \vec{a}_1^1 , \vec{a}_1^2 .

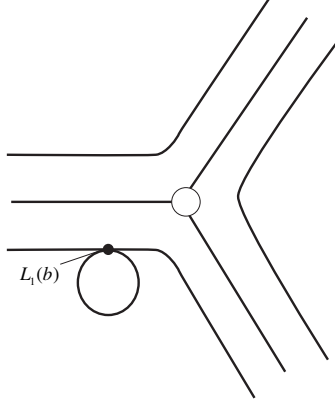

FIGURE 40. Boundary of type (II)

- (III) The third type of boundary corresponds to the limit where the domain will split into two parts on the image of ϕ_{123} . It is described by the fiber product below. Let $j_{ii'} \in \{0, \dots, k_{ii'}\}$. We put $\vec{a}_{ii'}^1 = (a_{ii',1}, \dots, a_{ii',j_{ii'}})$, $\vec{a}_{ii'}^2 = (a_{ii',j_{ii'}+1}, \dots, a_{ii',k_{ii'}})$ for $(ii') = (12)$ or (13) . We also put $\vec{a}_{13}^2 = (a_{13,1}, \dots, a_{13,j_{13}})$, $\vec{a}_{13}^1 = (a_{13,j_{13}+1}, \dots, a_{13,k_{13}})$.

Note that in case $j_{ii'} = 0$ (resp. $j_{ii'} = k_{ii'}$), $\vec{a}_{ii'}^1 = \emptyset$ (resp. $\vec{a}_{ii'}^2 = \emptyset$) for $(ii') = (12)$ or (13) . (The case of $(ii') = (13)$ is similar.)

$$\begin{aligned} & \mathcal{M}_Y(\vec{a}_{12}^2, \vec{a}_{23}^2, \vec{a}_{13}^2; \vec{a}_1, \vec{a}_2, \vec{a}_3; a, \vec{a}_\infty; E_2) \\ & \times_{R_{123}(a)} \mathcal{M}_{\text{DR}}(\vec{a}_{12}^1, \vec{a}_{23}^1, \vec{a}_{13}^1; a_{\infty,123}, a; E_1) \end{aligned} \tag{9.22}$$

where $E_1 + E_2 = E$ and $a \in \mathcal{A}_{123}$. See Figure 41.

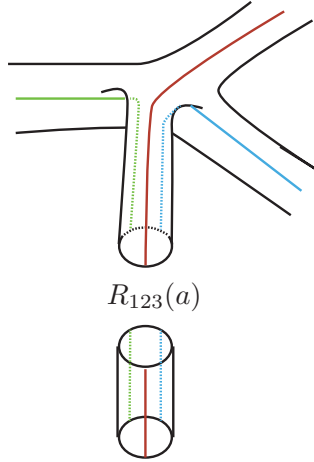

FIGURE 41. Boundary of type (III)

- (IV) The fourth type of boundary corresponds to the limit where the domain will split into two parts on the image of $\phi_{ii'}$. It is described by the fiber product below. We consider the case of ϕ_{12} . Let $j \in \{0, \dots, k_{12}\}$,

$j_1 \in \{0, \dots, k_1\}$, $j_2 \in \{0, \dots, k_2\}$. We put $\vec{a}_{12}^1 = (a_{12,1}, \dots, a_{12,j_{12}})$, $\vec{a}_{12}^2 = (a_{12,j_{12}+1}, \dots, a_{12,k_{12}})$. $\vec{a}_i^1 = (a_{i,1}, \dots, a_{i,j_i})$, $\vec{a}_i^2 = (a_{i,j_i+1}, \dots, a_{i,k_i})$ for $i = 1, 2$.

$$\begin{aligned} & \mathcal{M}_{\text{QT}}(\vec{a}_{12}^1, \vec{a}_1^1, \vec{a}_2^1; a_{\infty,12}, a; E_1) \\ & \times_{L_{12}(a)} \mathcal{M}_{\text{Y}}(\vec{a}_{12}^2, \vec{a}_{23}, \vec{a}_{13}; \vec{a}_1^2, \vec{a}_2^2, \vec{a}_3; (a, a_{\infty,13}, a_{\infty,31}), a_{\infty,123}; E_2) \end{aligned} \quad (9.23)$$

where $E_1 + E_2 = E$ and $a \in \mathcal{A}_{L_{12}}$. See Figure 42.

The cases of ϕ_{23} and ϕ_{13} are described by the next fiber products.

$$\begin{aligned} & \mathcal{M}_{\text{QT}}(\vec{a}_{23}^1, \vec{a}_2^1, \vec{a}_3^1; a_{\infty,23}, a; E_1) \\ & \times_{L_{12}(a)} \mathcal{M}_{\text{Y}}(\vec{a}_{12}, \vec{a}_{23}^2, \vec{a}_{13}; \vec{a}_1, \vec{a}_2^2, \vec{a}_3^2; a_{\infty,123}, (a_{\infty,12}, a, a_{\infty,13}); E_2), \end{aligned} \quad (9.24)$$

$$\begin{aligned} & \mathcal{M}_{\text{Y}}(\vec{a}_{12}, \vec{a}_{23}, \vec{a}_{13}; \vec{a}_1^2, \vec{a}_2, \vec{a}_3^2; a_{\infty,123}, (a_{\infty,12}, a_{\infty,23}, a); E_2) \\ & \times_{L_{13}(a)} \mathcal{M}_{\text{QT}}(\vec{a}_{13}^1, \vec{a}_1^1, \vec{a}_3^1; a_{\infty,23}, a; E_1). \end{aligned} \quad (9.25)$$

Note that \vec{a}_{23}^1 and \vec{a}_{23}^2 is defined in the same way as \vec{a}_{12}^1 and \vec{a}_{12}^2 . We define $\vec{a}_{13}^2 = (a_{13,1}, \dots, a_{13,j_{13}})$, $\vec{a}_{13}^1 = (a_{13,j_{13}+1}, \dots, a_{13,k_{13}})$.

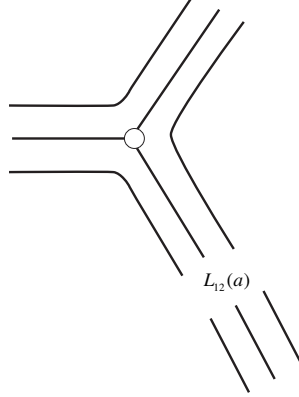

FIGURE 42. Boundary of type (IV)

We will show item (3) of Proposition 9.8 in Subsection 17.4. We observe that the four types of the boundaries are described by the fiber products explained above. In the case of boundaries of types (I)(II)(IV), we only need to check that the order of the marked points in the moduli space of Y-diagrams coincides with those of previously defined moduli spaces. We remark that the boundary of types (IV) with $(ii') = (13)$ the map ϕ_{13} identifies the domain of Y-diagram with $[-1, 1] \times [0, \infty)$, and for other (ii') the map $\phi_{ii'}$ identifies the domain of Y-diagram with $[-1, 1] \times (-\infty, 0]$. (See Condition 9.5 (2).) Taking this fact into account the above mentioned coincidence of the order of marked points is correct in this case also.

In the case of boundaries of type (III), we also remark that the map ϕ_{123} is anti-holomorphic. So the J_{X_i} holomorphic map on the intersection of Ω_i with the image of ϕ_{123} will become a $-J_{X_i}$ holomorphic map on an open subset of the drum appearing in Section 8.

Once we observe these points, the proof of Proposition 9.8 is now a routine.

Proposition 9.9. *For each E_0 there exists a system of CF-perturbations $\widehat{\mathfrak{S}}$ on $\mathcal{M}_Y(\vec{a}_{12}, \vec{a}_{23}, \vec{a}_{13}; \vec{a}_1, \vec{a}_2, \vec{a}_3, a_{\infty, -}, \vec{a}_{\infty, +}; E)$ (with respect to Kuranishi structures which are outer collarings of thickenings of those in Proposition 9.8) for $E < E_0$ such that the following holds.*

- (1) *They are transversal to 0.*
- (2) *The evaluation map ev_{∞} is strongly submersive with respect to this CF-perturbation.*
- (3) *The CF-perturbations are compatible with the description of the boundary. Namely the restriction of the CF-perturbation on the boundary coincides with the fiber product CF-perturbation in the sense of [FOOO10, FOOO13, Lemma-Definition 10.6].*
- (4) *The CF-perturbations are compatible with the forgetful maps of the boundary marked points corresponding to the diagonal component, in the sense of [Fu9, Theorem 5.1].*

◇

The proof is the same as Proposition 5.48 and is now a routine. We omit it.

The next step is to rewrite a geometric result Proposition 9.8 to an algebraic one. This is a process we have done in Sections 3.3, 5.2 and 7.2 as well as several other references especially in [FOOO13, Part II] and proceed as follows. We regard the evaluation map ev_{13} as an ‘output’ and other evaluation maps as ‘input’s. In other words we take differential forms on the targets of the evaluation maps other than ev_{13} , we then pull them back to the moduli space in Proposition 9.8 and use the CF-perturbation of Proposition 9.9 to push it out to the target of the evaluation map ev_{13} . We thus obtain a map between de Rham complexes. It will be the Y-diagram transformation below.

$$\begin{aligned}
& \mathcal{Y} \mathcal{F}_{k_{12}, k_{23}, k_{13}; k_1, k_2, k_3}^{E, \epsilon} \\
& : CF(L_{13}; L_{12}, L_{23}) \otimes \\
& \quad \otimes B_{k_{12}} CF[1](L_{12}) \otimes B_{k_{23}} CF[1](L_{23}) \otimes B_{k_{13}} CF[1](L_{13}) \\
& \quad \otimes CF(L_1, L_{12}; L_2) \otimes CF(L_2, L_{23}; L_3) \\
& \quad \otimes B_{k_1} CF[1](L_1) \otimes B_{k_2} CF[1](L_2) \otimes B_{k_3} CF[1](L_3) \rightarrow CF(L_1, L_{13}; L_3).
\end{aligned} \tag{9.26}$$

See (9.28). Note that we can find the domain and codomain of the map (9.26) by inspecting the targets of the evaluation maps of various kinds.

To obtain the basic property of the map (9.26) we use Stokes’ theorem and the composition formula as follows. We consider the commutator of the map (9.26) and the de Rham differential. Stokes’ theorem implies that the commutator is equal to the map obtained from the boundary of the moduli spaces of Proposition 9.8 in the same way as we obtain the map (9.26). We have described the boundary of the moduli space in Proposition 9.8 and found that the boundary consists of four types of fiber products. Actually each of types (I), (II), (IV) is a union of three kinds of boundaries. In the case of type (I) it is a union of components corresponding to three kinds of disk bubbles, that are, those at L_{12} , L_{23} , and L_{13} . In the case of type (II) it is a union of components corresponding to three kinds of disk bubbles, that are those at L_1 , L_2 , and L_3 . In the case of type (IV) it is a union three different ends, where strips escape at the image of ϕ_{12}, ϕ_{23} , or ϕ_{13} . Thus the formula (9.30) contains ten terms corresponding to those different kinds of boundaries.

Note that each boundary component is described as the fiber product of a moduli space of Proposition 9.8 (whose energy is not greater than E) and another moduli space. In the case of type (I) the another moduli space is one we used to define the filtered A_∞ category associated to L_{ij} . In the case of type (II) the another moduli space is one we used to define the filtered A_∞ category associated to L_i . In the case of type (III) the another moduli space is the moduli space of pseudo-holomorphic drums. In the case of type (IV) the another moduli space is one we used to define the filtered A_∞ tri-module associated to L_i, L_{ij}, L_j .

Therefore by the composition formula ([FOOO13, Theorem 10.21]), the terms corresponding to those 4 types of boundary components are obtained as compositions of the map (9.26) (whose energy is smaller than E) and one of the following: A map induced from the structure operations of the filtered A_∞ category associated to L_{ij} : A map induced from the structure operations of the filtered A_∞ category associated to L_i : A map induced from the structure operations of the filtered tri-module $\mathcal{CF}(\mathbb{L}_{13}; \mathbb{L}_{12}, \mathbb{L}_{23})$: A map induced from the structure operations of the filtered tri-module $\mathcal{CF}(\mathbb{L}_i, \mathbb{L}_{ij}; \mathbb{L}_j)$.

The formula we obtain in this way is (9.30) in Proposition 9.11.

This process to go from geometry to algebra is straightforward and is now becoming a routine. Since the formula is long (contains many terms) let us first describe it in a simple case and explain how it will be used in this simple case.

We assume that L_1, L_3, L_{ij} are embedded and monotone. Suppose that L_2 is a union of embedded monotone Lagrangian submanifolds $L_2^i, i = 0, \dots, k$ which intersects transversally each other. We consider the case when there is no marked points which maps to L_1, L_3 or L_{ij} . We use the cyclic element $\mathbf{1}_{123}$ (that is the function 1 on the diagonal component) and insert it at the hole in the middle of the Y-diagram. The map (9.26) in this case becomes

$$\begin{aligned} CF(L_1, L_{12}; L_2^0) \otimes \bigotimes_{i=1}^k CF[1](L_2^{i-1}, L_2^i) \\ \otimes CF(L_2^k, L_{23}; L_3) \rightarrow CF(L_1, L_{13}; L_3). \end{aligned} \quad (9.27)$$

We recall that the tri-module $CF(L_i, L_{ij}; L_j)$ is used to define the filtered A_∞ functor $\mathcal{W}_{\mathcal{L}_{ij}}$ via Yoneda functor. In the simplified case we are discussing, we fix L_{ij} and put no marked points on the seam. So it is actually a bi-module. Thus the right hand side of (9.27) corresponds to the filtered A_∞ functor $\mathcal{W}_{\mathcal{L}_{13}}$.

The direct sum of the left hand side of (9.27) for various L_2^0, \dots, L_2^k becomes the derived tensor product

$$\mathbf{ten}(CF(L_1, L_{12}; L_2^*), CF(L_2^*, L_{23}; L_3)).$$

See Lemma-Definition 10.6. As we will discuss in Subsection 10.1 (Proposition 10.10) the derived tensor product of filtered A_∞ bi-module corresponds to the composition of the corresponding filtered A_∞ functors. Thus the left hand side of (9.27) corresponds to the composition $\mathcal{W}_{\mathcal{L}_{23}} \circ \mathcal{W}_{\mathcal{L}_{12}}$.

We will show that by taking the direct sum over various L_2^0, \dots, L_2^k the map (9.27) becomes a chain homotopy equivalence and will use it to show (9.1).

Actually we need to include bounding cochains. We also need to show that the map (9.27) becomes a left- $\mathfrak{Fukst}(X_1)$ and right- $\mathfrak{Fukst}(X_3)$ bi-module homomorphism. Moreover we need to show the functoriality when we have several components of L_{ij} and morphisms (an element of Floer's chain complex) from L_{ij} to L'_{ij} .

To work these out we need (9.26) and its basic property Proposition 9.11 in its full generality. (This part of the proof is carried out in Subsection 10.4 after preparing various algebraic results.)

We go back to the general case and explain the way to define operations (9.26) using Propositions 9.9 and 9.8

Let $h_{\infty,123} \in \Omega(R(a_{\infty,123}))$, $h_{ii',j} \in \Omega(L_{ii'}(a_{ii',j}))$, $\mathbf{h}_{ii'} = (h_{ii',1}, \dots, h_{ii',k_{ii'}})$ ($ii' = 12, 23$ or 13), $h_{\infty,ii'} \in \Omega(L_{ii'}(a_{\infty,ii'}))$ ($ii' = 12$ or 23), $h_{i,j} \in \Omega(L_i(a_{i,j}))$, $\mathbf{h}_i = (h_{i,1}, \dots, h_{i,k_i})$ ($i = 1, 2$ or 3). Then the $\Omega(a_{\infty,13})$ component of

$$\mathcal{Y} \mathcal{T}_{k_{12}, k_{23}, k_{13}; k_1, k_2, k_3}^{E, \epsilon}(h_{\infty,123}; \mathbf{h}_{12}, \mathbf{h}_{23}, \mathbf{h}_{13}; h_{\infty,12}, h_{\infty,23}; \mathbf{h}_1, \mathbf{h}_2, \mathbf{h}_3)$$

is by definition

$$\begin{aligned} & \text{ev}_{\infty,13}!(\text{ev}_{\infty,123}^* h_{\infty,123} \wedge \text{ev}_{12}^* \mathbf{h}_{12} \wedge \text{ev}_{23}^* \mathbf{h}_{23} \wedge \text{ev}_{13}^* \mathbf{h}_{13} \\ & \quad \wedge \text{ev}_{\infty,12}^* h_{\infty,12} \wedge \text{ev}_{\infty,23}^* h_{\infty,23} \\ & \quad \wedge \text{ev}_1^* \mathbf{h}_1 \wedge \text{ev}_2^* \mathbf{h}_2 \wedge \text{ev}_3^* \mathbf{h}_3; \widehat{\mathfrak{S}}^\epsilon). \end{aligned} \quad (9.28)$$

Here the integration along the fiber appearing in (9.28) is taken on the moduli space $\mathcal{M}_Y(\vec{a}_{12}, \vec{a}_{23}, \vec{a}_{13}; \vec{a}_1, \vec{a}_2, \vec{a}_3, a_{\infty,123}, \vec{a}_\infty; E)$ using the CF-perturbation $\widehat{\mathfrak{S}}^\epsilon$.⁴² We then put

$$\mathcal{Y} \mathcal{T}_{k_{12}, k_{23}, k_{13}; k_1, k_2, k_3}^{<E_0, \epsilon} := \sum_{E < E_0} T^E \mathcal{Y} \mathcal{T}_{k_{12}, k_{23}, k_{13}; k_1, k_2, k_3}^{E, \epsilon}. \quad (9.29)$$

We call $\mathcal{Y} \mathcal{T}_{k_{12}, k_{23}, k_{13}; k_1, k_2, k_3}^{<E_0, \epsilon}$ the *Y diagram transformation*.

We usually omit the indices $k_{12}, k_{23}, k_{13}; k_1, k_2, k_3$ above since it is determined automatically from the input.

Remark 9.10. The order how the variables appears in (9.28) does not coincide with the order of the tensor factors in (9.26). The former coincides with

$$\begin{aligned} & CF(L_{13}; L_{12}, L_{23}) \otimes BCF[1](L_{12}) \otimes BCF[1](L_{23}) \otimes BCF[1](L_{13}) \\ & \otimes CF(L_1, L_{12}; L_2) \otimes CF(L_2, L_{23}; L_3) \otimes BCF[1](L_1) \otimes BCF[1](L_2) \otimes BCF[1](L_3). \end{aligned}$$

The formula looks easier to read when written in this order. The order of the tensor factors of (9.28) is one the Y-diagram transformation will be applied in Subsection 10.4.

⁴²The sign is discussed in Subsection 17.4.

Proposition 9.11. *The Y diagram transformation $\mathcal{Y} \mathcal{T}^{<E_0, \epsilon}_{k_{12}, k_{23}, k_{13}; k_1, k_2, k_3}$ satisfies the following congruence.*

$$\begin{aligned}
& (-1)^{*1} \mathcal{Y} \mathcal{T}^{<E_0, \epsilon}(h_{\infty, 123}; \hat{d}(\mathbf{h}_{12}), \mathbf{h}_{23}, \mathbf{h}_{13}; h_{\infty, 12}, h_{\infty, 23}; \mathbf{h}_1, \mathbf{h}_2, \mathbf{h}_3) \\
& + (-1)^{*2} \mathcal{Y} \mathcal{T}^{<E_0, \epsilon}(h_{\infty, 123}; \mathbf{h}_{12}, \hat{d}(\mathbf{h}_{23}), \mathbf{h}_{13}; h_{\infty, 12}, h_{\infty, 23}; \mathbf{h}_1, \mathbf{h}_2, \mathbf{h}_3) \\
& + (-1)^{*3} \mathcal{Y} \mathcal{T}^{<E_0, \epsilon}(h_{\infty, 123}; \mathbf{h}_{12}, \mathbf{h}_{23}, \hat{d}(\mathbf{h}_{13}); h_{\infty, 12}, h_{\infty, 23}; \mathbf{h}_1, \mathbf{h}_2, \mathbf{h}_3) \\
& + (-1)^{*4} \mathcal{Y} \mathcal{T}^{<E_0, \epsilon}(h_{\infty, 123}; \mathbf{h}_{12}, \mathbf{h}_{23}, \mathbf{h}_{13}; h_{\infty, 12}, h_{\infty, 23}; \hat{d}(\mathbf{h}_1), \mathbf{h}_2, \mathbf{h}_3) \\
& + (-1)^{*5} \mathcal{Y} \mathcal{T}^{<E_0, \epsilon}(h_{\infty, 123}; \mathbf{h}_{12}, \mathbf{h}_{23}, \mathbf{h}_{13}; h_{\infty, 12}, h_{\infty, 23}; \mathbf{h}_1, \hat{d}(\mathbf{h}_2), \mathbf{h}_3) \\
& + (-1)^{*6} \mathcal{Y} \mathcal{T}^{<E_0, \epsilon}(h_{\infty, 123}; \mathbf{h}_{12}, \mathbf{h}_{23}, \mathbf{h}_{13}; h_{\infty, 12}, h_{\infty, 23}; \mathbf{h}_1, \mathbf{h}_2, \hat{d}(\mathbf{h}_3)) \\
& + \sum_{c_{12}, c_{23}, c_{13}} (-1)^{*7} \mathcal{Y} \mathcal{T}^{<E_0, \epsilon}(\mathbf{n}^{<E_0, \epsilon}(\mathbf{h}_{13}^{c_{13}; 2}; h_{\infty, 123}; \mathbf{h}_{12}^{c_{12}; 1}, \mathbf{h}_{23}^{c_{23}; 1}) \\
& \quad ; \mathbf{h}_{12}^{c_{12}; 2}, \mathbf{h}_{23}^{c_{23}; 2}, \mathbf{h}_{13}^{c_{13}; 1}; h_{\infty, 12}, h_{\infty, 23}; \mathbf{h}_1, \mathbf{h}_2, \mathbf{h}_3) \\
& + \sum_{c_1, c_2, c_{12}} (-1)^{*8} \mathcal{Y} \mathcal{T}^{<E_0, \epsilon}(h_{\infty, 123}; \mathbf{h}_{12}^{c_{12}; 1}, \mathbf{h}_{23}, \mathbf{h}_{13} \\
& \quad ; \mathbf{n}^{<E_0, \epsilon}(\mathbf{h}_1^{c_1; 1}, \mathbf{h}_{12}^{c_{12}; 2}; h_{\infty, 12}; \mathbf{h}_2^{c_2; 1}), \\
& \quad h_{\infty, 23}; \mathbf{h}_1^{c_1; 2}, \mathbf{h}_2^{c_2; 2}, \mathbf{h}_3) \\
& + \sum_{c_2, c_3, c_{23}} (-1)^{*9} \mathcal{Y} \mathcal{T}^{<E_0, \epsilon}(h_{\infty, 123}; \mathbf{h}_{12}, \mathbf{h}_{23}^{c_{23}; 1}, \mathbf{h}_{13}; h_{\infty, 12}, \\
& \quad ; \mathbf{n}^{<E_0, \epsilon}(\mathbf{h}_2^{c_2; 1}, \mathbf{h}_{23}^{c_{23}; 2}; h_{\infty, 23}; \mathbf{h}_3^{c_3; 1}); \mathbf{h}_1, \mathbf{h}_2^{c_2; 2}, \mathbf{h}_3^{c_3; 2}) \\
& - \sum_{c_1, c_3, c_{13}} (-1)^{*10} \mathbf{n}^{<E_0, \epsilon}(\mathbf{h}_1^{c_1; 1}, \mathbf{h}_{13}^{c_{13}; 1}; \\
& \quad \mathcal{Y} \mathcal{T}^{<E_0, \epsilon}(h_{\infty, 123}; \mathbf{h}_{12}, \mathbf{h}_{23}, \mathbf{h}_{13}^{c_{13}; 2} \\
& \quad ; h_{\infty, 12}, h_{\infty, 23}; \mathbf{h}_1^{c_1; 2}, \mathbf{h}_2, \mathbf{h}_3^{c_3; 2}); \mathbf{h}_3^{c_3; 1}) \\
& \equiv 0 \pmod{T^{E_0}}.
\end{aligned} \tag{9.30}$$

Here $\Delta(\mathbf{h}_i) = \sum_{c_i} \mathbf{h}_i^{c_i; 1} \otimes \mathbf{h}_i^{c_i; 2}$, $\Delta(\mathbf{h}_{i i'}) = \sum_{c_{i i'}} \mathbf{h}_{i i'}^{c_{i i'}; 1} \otimes \mathbf{h}_{i i'}^{c_{i i'}; 2}$ and all the signs are by Koszul rule.⁴³ \diamond

Proof. The proof uses Propositions 9.8 and 9.9 together with Stokes' theorem ([FOOO10, FOOO13, Proposition 9.26]) and the composition formula ([FOOO10, FOOO13, Theorem 10.20]). It goes in the same way as the proofs of other similar statements we proved before. In fact the first three terms correspond to the boundary of type (I) and the fiber products (9.16), (9.17), (9.18), respectively. The operator \hat{d} in the first three terms are induced by the structure operations of $\mathfrak{Fut}(-X_i \times X'_i)$.

The 4-th, 5-th and 6-th terms correspond to the boundary of type (II) and the fiber products (9.19), (9.20) and (9.21), respectively. The operator \hat{d} in the 4-th, 5-th and 6-th terms are induced by the structure operations of $\mathfrak{Fut}(\mathbb{L}_i)$.

⁴³See Subsection 17.1 for the way the Koszul rule determines the sign.

The 7-th term corresponds to the boundary of type (III) and the fiber product (9.23). Note that the structure map \mathbf{n} appearing in the 7-th term is one of the tri-module $\mathcal{CF}(\mathbb{L}_{13}; \mathbb{L}_{12}, \mathbb{L}_{23})$.

The 8-th, 9-th and 10-th terms correspond to the boundary of type (IV) and the fiber products (9.23), (9.24), and (9.25), respectively. The structure map \mathbf{n} appearing in the 8-th, 9-th and 10-th terms is structure operation of the tri-module $\mathcal{CF}(\mathbb{L}_i, \mathbb{L}_{ij}; \mathbb{L}_j)$.

The sign will be discussed in Subsection 17.4. \square

In the same way as Definition 2.5 (8), we can modify our operations and change the congruence in (9.30) to the equality. Namely we have:

Proposition 9.12. *There exists a map*

$$\begin{aligned} \mathcal{Y}\mathcal{T} : & CF(L_{12}, L_{23}, L_{13}) \otimes BCF[1](L_{12}) \otimes BCF[1](L_{23}) \otimes BCF[1](L_{13}) \\ & \otimes CF(L_1, L_{12}, L_2) \otimes CF(L_2, L_{23}, L_3) \\ & \otimes BCF[1](L_1) \otimes BCF[1](L_2) \otimes BCF[1](L_3) \rightarrow CF(L_1, L_{13}, L_3) \end{aligned} \quad (9.31)$$

such that if we replace $\mathcal{Y}\mathcal{T}^{<E_0, \epsilon}$ by $\mathcal{Y}\mathcal{T}$ the formula (9.30) holds as an exact equality. Namely

$$\begin{aligned} & (-1)^{*1} \mathcal{Y}\mathcal{T}(h_{\infty, 123}; \hat{d}(\mathbf{h}_{12}), \mathbf{h}_{23}, \mathbf{h}_{13}; h_{\infty, 12}, h_{\infty, 23}; \mathbf{h}_1, \mathbf{h}_2, \mathbf{h}_3) \\ & + (-1)^{*2} \mathcal{Y}\mathcal{T}(h_{\infty, 123}; \mathbf{h}_{12}, \hat{d}(\mathbf{h}_{23}), \mathbf{h}_{13}; h_{\infty, 12}, h_{\infty, 23}; \mathbf{h}_1, \mathbf{h}_2, \mathbf{h}_3) \\ & + (-1)^{*3} \mathcal{Y}\mathcal{T}(h_{\infty, 123}; \mathbf{h}_{12}, \mathbf{h}_{23}, \hat{d}(\mathbf{h}_{13}); h_{\infty, 12}, h_{\infty, 23}; \mathbf{h}_1, \mathbf{h}_2, \mathbf{h}_3) \\ & + (-1)^{*4} \mathcal{Y}\mathcal{T}(h_{\infty, 123}; \mathbf{h}_{12}, \mathbf{h}_{23}, \mathbf{h}_{13}; h_{\infty, 12}, h_{\infty, 23}; \hat{d}(\mathbf{h}_1), \mathbf{h}_2, \mathbf{h}_3) \\ & + (-1)^{*5} \mathcal{Y}\mathcal{T}(h_{\infty, 123}; \mathbf{h}_{12}, \mathbf{h}_{23}, \mathbf{h}_{13}; h_{\infty, 12}, h_{\infty, 23}; \mathbf{h}_1, \hat{d}(\mathbf{h}_2), \mathbf{h}_3) \\ & + (-1)^{*6} \mathcal{Y}\mathcal{T}(h_{\infty, 123}; \mathbf{h}_{12}, \mathbf{h}_{23}, \mathbf{h}_{13}; h_{\infty, 12}, h_{\infty, 23}; \mathbf{h}_1, \mathbf{h}_2, \hat{d}(\mathbf{h}_3)) \\ & + \sum_{c_{12}, c_{23}, c_{13}} (-1)^{*7} \mathcal{Y}\mathcal{T}(\mathbf{n}(\mathbf{h}_{13}^{c_{13}; 2}; h_{\infty, 123}; \mathbf{h}_{12}^{c_{12}; 1}, \mathbf{h}_{23}^{c_{23}; 1}) \\ & \quad ; \mathbf{h}_{12}^{c_{12}; 2}, \mathbf{h}_{23}^{c_{23}; 2}, \mathbf{h}_{13}^{c_{13}; 1}; h_{\infty, 12}, h_{\infty, 23}; ; \mathbf{h}_1, \mathbf{h}_2, \mathbf{h}_3) \\ & + \sum_{c_1, c_2, c_{12}} (-1)^{*8} \mathcal{Y}\mathcal{T}(h_{\infty, 123}; \mathbf{h}_{12}^{c_{12}; 1}, \mathbf{h}_{23}, \mathbf{h}_{13} \\ & \quad ; \mathbf{n}(\mathbf{h}_1^{c_1; 1}, \mathbf{h}_{12}^{c_{12}; 2}; h_{\infty, 12}; \mathbf{h}_2^{c_2; 1}), \\ & \quad h_{\infty, 23}; \mathbf{h}_1^{c_1; 2}, \mathbf{h}_2^{c_2; 2}, \mathbf{h}_3) \\ & + \sum_{c_2, c_3, c_{23}} (-1)^{*9} \mathcal{Y}\mathcal{T}(h_{\infty, 123}; \mathbf{h}_{12}, \mathbf{h}_{23}^{c_{23}; 1}, \mathbf{h}_{13}; h_{\infty, 12}, \\ & \quad ; \mathbf{n}(\mathbf{h}_2^{c_2; 1}, \mathbf{h}_{23}^{c_{23}; 2}; h_{\infty, 23}; \mathbf{h}_3^{c_3; 1}); \mathbf{h}_1, \mathbf{h}_2^{c_2; 2}, \mathbf{h}_3^{c_3; 2}) \\ & - \sum_{c_1, c_3, c_{13}} (-1)^{*10} \mathbf{n}(\mathbf{h}_1^{c_1; 1}, \mathbf{h}_{13}^{c_{13}; 1}; \\ & \quad \mathcal{Y}\mathcal{T}(h_{\infty, 123}; \mathbf{h}_{12}, \mathbf{h}_{23}, \mathbf{h}_{13}^{c_{13}; 2} \\ & \quad ; h_{\infty, 12}, h_{\infty, 23}; \mathbf{h}_1^{c_1; 2}, \mathbf{h}_2, \mathbf{h}_3^{c_3; 2}); \mathbf{h}_3^{c_3; 1}) \\ & = 0. \end{aligned} \quad (9.32)$$

Moreover $\mathcal{Y}\mathcal{T} \equiv \mathcal{Y}\mathcal{T}^{<E_0, \epsilon} \pmod{T^{E_0}}$. \diamond

We call $\mathcal{Y}\mathcal{T}$, the *Y diagram transformation* also. .

9.3. Proof of Proposition 9.2 (2). In this subsection we prove Proposition 9.2 (2).

Let $\mathcal{L}_{12} = (L_{12}, \sigma_{12}, b_{12})$ (resp. $\mathcal{L}_{23} = (L_{23}, \sigma_{23}, b_{23})$) be an object of $\mathfrak{Fust}(-X_1 \times X_2)$ (resp. $\mathfrak{Fust}(-X_2 \times X_3)$). Let $\mathcal{L}_{13} = (L_{13}, \sigma_{13}, b_{13})$ be the geometric composition $\mathcal{L}_{23} \circ \mathcal{L}_{12}$.

Let $\mathcal{L}_1 = (L_1, \sigma_1, b_1)$ and we put

$$\mathcal{L}_2 = (L_2, \sigma_2, b_2) = \mathcal{W}_{\mathcal{L}_{12}}(\mathcal{L}_1), \quad \mathcal{L}_3^{(1)} = (L_3, \sigma_3, b_3^{(1)}) = \mathcal{W}_{\mathcal{L}_{23}}(\mathcal{L}_2)$$

and

$$\mathcal{L}_3^{(2)} = (L_3, \sigma_3, b_3^{(2)}) = \mathcal{W}_{\mathcal{L}_{13}}(\mathcal{L}_1).$$

We remark that the underlying Lagrangian submanifold of $\mathcal{L}_3^{(1)}$ is equal to the underlying Lagrangian submanifold of $\mathcal{L}_3^{(2)}$. This is obvious since

$$L_2 \times_{X_2} L_{23} = L_1 \times_{X_1} L_{12} \times_{X_2} L_{23} = L_1 \times_{X_1} L_{13}.$$

The coincidence of the relative spin structure is the main part of Proposition 9.2 (1) which we will prove in Subsection 17.4. We will prove in this subsection the next proposition.

Proposition 9.13. *The bounding cochain $b_3^{(1)}$ is gauge equivalent to $b_3^{(2)}$ in the sense of [FOOO1, Definition 4.3.1]. \diamond*

Proof. We use the next algebraic lemma to prove Proposition 9.13.

Lemma 9.14. *Let $(D, \{\mathbf{n}_k\})$ be a G -gapped right filtered A_∞ module over $(C, \{\mathbf{m}_k\})$. Let $\mathbf{1}^{(1)}, \mathbf{1}^{(2)}$ be cyclic elements of D and $b^{(1)}, b^{(2)}$ bounding cochains of C such that*

$$\sum_{k=0}^{\infty} \mathbf{n}_k(\mathbf{1}^{(i)}; b^{(i)}, \dots, b^{(i)}) = 0. \quad (9.33)$$

We also assume

$$\mathbf{1}^{(1)} \equiv \mathbf{1}^{(2)} \pmod{\Lambda_+}. \quad (9.34)$$

Then $b^{(1)}$ is gauge equivalent to $b^{(2)}$. \diamond

Proof. We use a certain result and notations of [FOOO1] in the proof. Let \mathfrak{C} be a model of $[0, 1] \times C$ in the sense of [FOOO1, Definition 4.2.1]. Let \mathfrak{D} be a model of $[0, 1] \times D$ in the sense of [FOOO1, Definition 5.2.21], which is a right \mathfrak{C} module. Such \mathfrak{C} and \mathfrak{D} exists by [FOOO1, Lemma 4.2.13 and Theorem 5.2.23]. Since $\text{Eval}_0 \oplus \text{Eval}_1 : \mathfrak{D} \rightarrow D \oplus D$ is surjective (see [FOOO1, Definition 5.2.23]), we have $\Delta \mathbf{1} \in \mathfrak{D}$ such that

$$(\text{Eval}_0)(\Delta \mathbf{1}) = 0, \quad (\text{Eval}_1)(\Delta \mathbf{1}) = \mathbf{1}^{(2)} - \mathbf{1}^{(1)}.$$

Using (9.34) we may choose $\Delta \mathbf{1}$ such that

$$\Delta \mathbf{1} \equiv 0 \pmod{\Lambda_+}. \quad (9.35)$$

We put

$$\hat{\mathbf{1}} = \text{Incl}(\mathbf{1}^{(1)}) + \Delta \mathbf{1}.$$

(9.35) implies that $\hat{\mathbf{1}}$ is a cyclic element of the right \mathfrak{C} module \mathfrak{D} . Therefore by Proposition 6.6 there exists a bounding cochain \hat{b} of \mathfrak{c} such that

$$\sum_{k=0}^{\infty} \mathbf{n}_k(\hat{\mathbf{1}}; \hat{b}, \dots, \hat{b}) = 0.$$

We remark that

$$(\text{Eval}_0)(\hat{\mathbf{1}}) = \mathbf{1}^{(1)}, \quad (\text{Eval}_1)(\hat{\mathbf{1}}) = \mathbf{1}^{(2)}.$$

Therefore using the uniqueness part of Proposition 6.6 we find that

$$(\text{Eval}_0)(\hat{b}) = b^{(1)}, \quad (\text{Eval}_1)(\hat{b}) = b^{(2)}.$$

Hence $b^{(1)}$ is gauge equivalent to $b^{(2)}$, as required. □

We go back to our geometric situation and use Y diagram transformation $\mathcal{Y}\mathcal{T}$ to define a map

$$\mathcal{M}\mathcal{Y} : CF(L_1; L_{12}; L_2) \otimes CF(L_2; L_{23}; L_3) \rightarrow CF(L_1; L_{13}; L_3) \quad (9.36)$$

by

$$\begin{aligned} & \mathcal{M}\mathcal{Y}(h_{\infty,+12}, h_{\infty,+23}) \\ &= \mathcal{Y}\mathcal{T}(\mathbf{1}_{123}; e^{b_{12}}, e^{b_{23}}, e^{b_{13}}; h_{\infty,+12}, h_{\infty,+23}; e^{b_1}, e^{b_3}, e^{b_3^{(1)}}). \end{aligned} \quad (9.37)$$

Here $\mathbf{1}_{123} \in CF(L_{12}; L_{23}; L_{13})$ is the cyclic element we used in Lemma 8.10. (See Figure 43.) In other words it is the function 1 on the diagonal component of

$$(\tilde{L}_{12} \times \tilde{L}_{23} \times \tilde{L}_{13}) \times_{(X_1 \times X_2 \times X_3)^2} \Delta \cong \tilde{L}_{13} \times_{X_1 \times X_3} \tilde{L}_{13}.$$

Note that $CF(L_i, L_{ii'}, L_{i'})$ for $ii' = 12, 23$ or 13 is a filtered A_∞ tri-module over

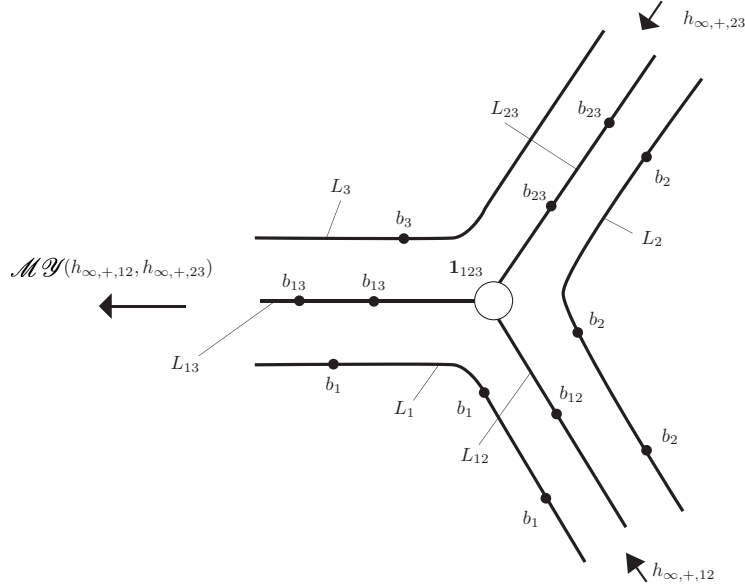

FIGURE 43. The map $\mathcal{M}\mathcal{Y}$.

$CF(L_i), CF(L_{ii'}), CF(L_{i'})$. Therefore bounding cochains of $CF(L_i), CF(L_{ii'})$,

$CF(L_{i'})$ deform their ‘boundary operators’ to obtain a boundary operator. Namely if $b_i, b_{ii'}, b_{i'}$ are bounding cochains of $CF(L_i), CF(L_{ii'}), CF(L_{i'})$ we put

$$d^{b_i; b_{ii'}; b_{i'}}(x) = \mathbf{n}(e^{b_i}, e^{b_{ii'}}; x; e^{b_{i'}}) \quad (9.38)$$

where \mathbf{n} is the structure operations of the tri-module in Theorem 5.25.

Lemma 9.15. *The map $\mathcal{M}\mathcal{Y}$ in (9.36) is a chain map with respect to the boundary operators $d^{b_1; b_{12}; b_2}, d^{b_2; b_{23}; b_3^{(1)}}, d^{b_1; b_{13}; b_3^{(1)}}$. \diamond*

Proof. We put $h_{\infty, 123} = \mathbf{1}_{123}$, $\mathbf{h}_{12} = e^{b_{12}}$, $\mathbf{h}_{23} = e^{b_{23}}$, $\mathbf{h}_{13} = e^{b_{13}}$, $\mathbf{h}_1 = e^{b_1}$, $\mathbf{h}_2 = e^{b_2}$, $\mathbf{h}_3 = e^{b_3^{(1)}}$ and apply Proposition 9.12. The first 6 terms of (9.31) vanish because $\mathbf{h}_{ii'}$ \mathbf{h}_i are exponentials of the bounding cochains. The 7th term vanishes because $\mathbf{1}_{123}$ is a cycle with respect to the differential of $CF(L_{13}; L_{12}, L_{23})$ twisted by b_{12}, b_{23}, b_{13} . In fact this is the definition of b_{13} . (See (8.6).) The 8th, 9th, 10th terms give the elements $\mathcal{Y}\mathcal{T}(d^{b_1; b_{12}; b_2}(h_{\infty, 12}), h_{\infty, 23}), \mathcal{Y}\mathcal{T}(h_{\infty, 12}, d^{b_1; b_{23}; b_3^{(1)}}(h_{\infty, 23}))$, and $d^{b_1; b_{13}; b_3^{(1)}}(\mathcal{Y}\mathcal{T}(h_{\infty, 12}, h_{\infty, 23}))$ respectively. The lemma follows. \square

For $ii' = 12, 23$ or 13 we denote by $\mathbf{1}_{ii'}$ the function 1 on the diagonal component of $\tilde{L}_i \times_{X_i \times X_{i'}} L_{i'}$.

Lemma 9.16.

$$\mathcal{Y}\mathcal{T}(\mathbf{1}_{12}, \mathbf{1}_{23}) \equiv \mathbf{1}_{13} \pmod{\Lambda_+}.$$

\diamond

Proof. The operation $\mathcal{Y}\mathcal{T}$ are defined modulo Λ_+ by the integration along the fiber of the moduli space $\mathcal{M}_Y(\vec{a}_{12}, \vec{a}_{23}, \vec{a}_{13}; \vec{a}_1, \vec{a}_2, \vec{a}_3, a_{\infty, 123}, \vec{a}_\infty; 0)$, which consists of constant maps. Using this fact and the definitions we can prove the lemma easily in the same way as Proposition 6.12. \square

We recall that on $CF(L_1, L_{13}; L_3)$ we have a structure of right $CF(L_3)$ module \mathbf{n}_k . In fact we put

$$\mathbf{n}_k(y; x_1, \dots, x_k) = \mathbf{n}(e^{b_1}; e^{b_{13}}; y; x_1, \dots, x_k).$$

(See Lemma 6.10.)

By the definition of $b_3^{(2)}$ we have

$$\sum_{k=0}^{\infty} \mathbf{n}_k(\mathbf{1}_{13}; b_3^{(2)}, \dots, b_3^{(2)}) = 0. \quad (9.39)$$

We put

$$\mathbf{1}'_{13} = \mathcal{Y}\mathcal{T}(\mathbf{1}_{12}, \mathbf{1}_{23}).$$

Then by Lemma 9.15 we have

$$\sum_{k=0}^{\infty} \mathbf{n}_k(\mathbf{1}'_{13}; b_3^{(1)}, \dots, b_3^{(1)}) = 0. \quad (9.40)$$

By (9.39), (9.40) and Lemma 9.16 we can apply Lemma 9.14 to conclude that $b_3^{(1)}$ is gauge equivalent to $b_3^{(2)}$. The proof of Proposition 9.2 (2) is complete. \square

10. THE COMPATIBILITY AS 2-FUNCTORS

10.1. **The composition of A_∞ functors defines a bi-functor.** To obtain a more functorial version of Theorem 9.1 we need the following algebraic result.

Theorem 10.1. *Let \mathcal{C}_i be a unital, strict and gapped filtered A_∞ category for $i = 1, 2, 3$. Then, there exists a filtered A_∞ bi-functor*

$$\mathbf{Comp} : \mathcal{F}UNC(\mathcal{C}_1, \mathcal{C}_2) \times \mathcal{F}UNC(\mathcal{C}_2, \mathcal{C}_3) \rightarrow \mathcal{F}UNC(\mathcal{C}_1, \mathcal{C}_3) \quad (10.1)$$

such that

$$\mathbf{Comp}_{ob}(\mathcal{F}_{12}, \mathcal{F}_{23}) = \mathcal{F}_{23} \circ \mathcal{F}_{12}.$$

◇

We fix a discrete monoid $G \subset \mathbb{R}_{\geq 0}$. Here and hereafter the objects $\mathcal{F}UNC(\mathcal{C}_1, \mathcal{C}_2)$ are strict, unital and G -gapped filtered A_∞ functors.

Remark 10.2. Theorem 10.1 could be a part of the construction of an (A_∞) 2-category whose object is a filtered A_∞ category. See Subsection 10.6. ◇

The unfiltered version of this statement is in [Ly]. We prove it here since we need the construction of the functor \mathbf{Comp} for our application to geometry in Subsections 10.2 and 10.5. Our proof below is different from the proof in [Ly].

Proof. Let $\mathcal{C}_1, \mathcal{C}_2$ be unital, strict and gapped filtered A_∞ categories.

Lemma-Definition 10.3. *There exists a filtered A_∞ functor*

$$\mathfrak{Yon} : \mathcal{F}UNC(\mathcal{C}_1, \mathcal{C}_2) \rightarrow \mathcal{B}I\mathcal{M}O\mathcal{D}(\mathcal{C}_1, \mathcal{C}_2)^{\text{op}}$$

which is a homotopy equivalence to its image. We call this functor the relative Yoneda functor. ◇

Proof. The functor \mathfrak{OpYon} (for \mathcal{C}_2) and the isomorphism in Lemma 2.33 induces

$$\mathcal{F}UNC(\mathcal{C}_1, \mathcal{C}_2) \cong \mathcal{F}UNC(\mathcal{C}_1^{\text{op}}, \mathcal{C}_2^{\text{op}})^{\text{op}} \rightarrow \mathcal{F}UNC(\mathcal{C}_1^{\text{op}}, \mathcal{F}UNC(\mathcal{C}_2, \mathcal{C}\mathcal{H}))^{\text{op}}.$$

On the other hand, in Definition 5.14 we defined an isomorphism

$$\mathcal{F}UNC(\mathcal{C}_1^{\text{op}}, \mathcal{F}UNC(\mathcal{C}_2, \mathcal{C}\mathcal{H})) \cong \mathcal{B}I\mathcal{M}O\mathcal{D}(\mathcal{C}_1; \mathcal{C}_2).$$

The lemma follows. \square

Let us describe the functor \mathfrak{Yon} more explicitly below. Let $\mathfrak{F} : \mathcal{C}_1 \rightarrow \mathcal{C}_2$ be an object of $\mathcal{F}UNC(\mathcal{C}_1, \mathcal{C}_2)$. We first define left- \mathcal{C}_1 and right- \mathcal{C}_2 bi-module $\mathfrak{Yon}_{ob}(\mathfrak{F})$. Let c_i be an object of \mathcal{C}_i for $i = 1, 2$. We put

$$D_{c_1, c_2} = \mathcal{C}_2(\mathfrak{F}_{ob}(c_1), c_2).$$

Let $\mathbf{x} \in B\mathcal{C}_1(c'_1, c_1)$, $z \in D_{c_1, c_2}$, $\mathbf{y} \in B\mathcal{C}_2(c_2, c'_2)$. We define $\mathfrak{n}(\mathbf{x}, z, \mathbf{y}) \in D_{c'_1, c'_2} = \mathcal{C}_2(\mathfrak{F}_{ob}(c'_1), c'_2)$ by

$$\mathfrak{n}(\mathbf{x}, z, \mathbf{y}) = (-1)^{\text{deg}' \mathbf{y}} \mathfrak{m}(\widehat{\mathfrak{F}}(\mathbf{x}), z, \mathbf{y}). \quad (10.2)$$

Remark 10.4. In the definition of relative Yoneda functor we use \mathfrak{OpYon} which is defined by using opposite category \mathcal{C}^{op} . Moreover we use the isomorphism $\mathcal{F}UNC(\mathcal{C}_1, \mathcal{C}_2) \cong \mathcal{F}UNC(\mathcal{C}_1^{\text{op}}, \mathcal{C}_2^{\text{op}})^{\text{op}}$. Since we take the operation taking opposite twice \mathbf{x} in the left hand side becomes \mathbf{x} in the right hand side. The $+1$ in Definition 2.30 (3) cancels with the minus sign in Definition 2.18.

A rather complicated process to define \mathfrak{OpYon} becomes a simple and natural formula (10.2), when we write it explicitly.

The languages of functors and of bi-modules are mostly equivalent when the target is \mathcal{CH} . However the identification includes the process taking opposite. \diamond

We will check (5.19). Let $\Delta \mathbf{x} = \sum_{a_1} \mathbf{x}_{a_1;1} \otimes \mathbf{x}_{a_1;2}$, $\Delta \mathbf{y} = \sum_{a_2} \mathbf{y}_{a_2;1} \otimes \mathbf{y}_{a_2;2}$. By definition we have

$$\begin{aligned} & \sum_{a_1} \sum_{a_2} (-1)^{*2} \mathbf{n}(\mathbf{x}_{a_1;1}, \mathbf{n}(\mathbf{x}_{a_1;2}, z, \mathbf{y}_{a_2;1}), \mathbf{y}_{a_2;2}) \\ &= \sum_{a_1} \sum_{a_2} (-1)^{*3} \mathbf{m}(\widehat{\mathfrak{F}}(\mathbf{x}_{a_1;1}), \mathbf{m}(\widehat{\mathfrak{F}}(\mathbf{x}_{a_2;1}), z, \mathbf{y}_{a_2;1}), \mathbf{y}_{a_2;2}), \end{aligned} \quad (10.3)$$

where $*_2 = \deg' \mathbf{x}_{a_1;1}$ and $*_3 = \deg' \mathbf{x}_{a_2;1} + \deg' \mathbf{y}$.

Moreover:

$$\mathbf{n}(\hat{d}(\mathbf{x}), z, \mathbf{y}) = (-1)^{\deg' \mathbf{y}} \mathbf{m}(\widehat{\mathfrak{F}}(\hat{d}\mathbf{x}), z, \mathbf{y}) = (-1)^{\deg' \mathbf{y}} \mathbf{m}(\hat{d}(\widehat{\mathfrak{F}}(\mathbf{x})), z, \mathbf{y}). \quad (10.4)$$

Here the second equality follows from the fact that $\widehat{\mathfrak{F}}$ is a filtered A_∞ functor. Furthermore

$$(-1)^{\deg' \mathbf{x} + \deg z} \mathbf{n}(\mathbf{x}, z, \hat{d}(\mathbf{y})) = \sum_{a_1} (-1)^{*4} \mathbf{m}(\widehat{\mathfrak{F}}(\mathbf{x}), z, \hat{d}(\mathbf{y})), \quad (10.5)$$

where $*_4 = \deg' \mathbf{x} + \deg z + \deg' \mathbf{y}$.

Formulas (10.3), (10.4), (10.5) and the A_∞ formula for \mathbf{m} imply (5.19) with sign modified (See Remark 10.5), using the fact that $\widehat{\mathfrak{F}}$ is a cohomomorphism. Thus D_{c_1, c_2} equipped with this bi-module structure is $\mathfrak{R}\mathfrak{Y}\mathfrak{on}_{\text{ob}}(\mathcal{F})(c_1, c_2)$.

Remark 10.5. In this and the next sections we use the sign convention of filtered A_∞ modules (multi-modules) so that the degree of elements of modules are not shifted. In other words, in (10.5), $\deg z$ appears in place of $\deg' z$. The sign $(-1)^{\deg' \mathbf{y}}$ in (10.2) appears by this reason. See Remark 5.5.

A natural transformation \mathcal{T} from $\widehat{\mathfrak{F}}$ to \mathfrak{G} gives

$$\mathcal{T}_0(c_1) \in \mathcal{C}_2(\mathfrak{F}_{\text{ob}}(c_1), \mathfrak{G}_{\text{ob}}(c_1)).$$

It induces a cochain map $\mathcal{C}_2(\mathfrak{G}_{\text{ob}}(c_1), c_2) \rightarrow \mathcal{C}_2(\mathfrak{F}_{\text{ob}}(c_1), c_2)$. This is a part of a bi-module homomorphism from $\mathfrak{R}\mathfrak{Y}\mathfrak{on}_{\text{ob}}(\mathfrak{G})$ to $\mathfrak{R}\mathfrak{Y}\mathfrak{on}_{\text{ob}}(\widehat{\mathfrak{F}})$. The direction of the arrows are opposite. This is the reason why the opposite category appears in Lemma-Definition 10.3.

The next lemma-definition and Propositions 10.10 and 10.23 are closely related to the work [To] by Toën.

Lemma-Definition 10.6. *Let $\mathcal{C}_1, \mathcal{C}_2, \mathcal{C}_3$ be filtered A_∞ categories. There exists a filtered A_∞ bi-functor*

$$\text{ten} : \mathcal{B}\mathcal{I}\mathcal{M}\mathcal{O}\mathcal{D}(\mathcal{C}_1, \mathcal{C}_2) \times \mathcal{B}\mathcal{I}\mathcal{M}\mathcal{O}\mathcal{D}(\mathcal{C}_2, \mathcal{C}_3) \rightarrow \mathcal{B}\mathcal{I}\mathcal{M}\mathcal{O}\mathcal{D}(\mathcal{C}_1, \mathcal{C}_3).$$

We call it the derived tensor product functor. \diamond

Proof. Let $\mathfrak{D}^{12} = (\{D_{c_1, c_2}^{12}\}, \{\mathbf{n}_{c'_1, c_1, c_2, c'_2}^{12}\})$ be an object of $\mathcal{B}\mathcal{I}\mathcal{M}\mathcal{O}\mathcal{D}(\mathcal{C}_1, \mathcal{C}_2)$ and $\mathfrak{D}^{23} = (\{D_{c_2, c_3}^{23}\}, \{\mathbf{n}_{c'_2, c_2, c_3, c'_3}^{23}\})$ be an object of $\mathcal{B}\mathcal{I}\mathcal{M}\mathcal{O}\mathcal{D}(\mathcal{C}_2, \mathcal{C}_3)$. We will define an object $\mathfrak{D}^{13} = (\{D_{c_1, c_3}^{13}\}, \{\mathbf{n}_{c'_1, c_1, c_3, c'_3}^{13}\})$ of $\mathcal{B}\mathcal{I}\mathcal{M}\mathcal{O}\mathcal{D}(\mathcal{C}_1, \mathcal{C}_3)$.

Let $c_1, c'_1 \in \mathfrak{D}\mathfrak{B}(\mathcal{C}_1)$, $c_3, c'_3 \in \mathfrak{D}\mathfrak{B}(\mathcal{C}_3)$. We put

$$D_{c_1, c_3}^{13} = \bigoplus_{c_2, c'_2} \widehat{D}_{c_1, c_2}^{12} \widehat{\otimes} B\mathcal{C}_2[1](c_2, c'_2) \widehat{\otimes} D_{c'_2, c_3}^{23}. \quad (10.6)$$

We remark that $B\mathcal{C}_2[1](c_2, c'_2)$ contains $1 \in B_0\mathcal{C}_2[1](c_2, c_2) \cong \Lambda_0$ when $c_2 = c'_2$.

Let $\mathbf{x} \in B\mathcal{C}_1[1](c'_1, c_1)$, $\mathbf{y} \in B\mathcal{C}_3[1](c_3, c'_3)$ and

$$z = u \otimes \mathbf{v} \otimes w \in D_{c_1, c_2}^{12} \widehat{\otimes} B\mathcal{C}_2[1](c_2, c'_2) \widehat{\otimes} D_{c'_2, c_3}^{23} \subseteq D_{c_1, c_3}^{13}.$$

We define $\mathbf{n}_{c'_1, c_1, c_3, c'_3}^{13} : B\mathcal{C}_1[1](c'_1, c_1) \widehat{\otimes} D_{c_1, c_3}^{13} \otimes B\mathcal{C}_3[1](c_3, c'_3) \rightarrow D_{c'_1, c'_3}^{13}$ by

$$\mathbf{n}_{c'_1, c_1, c_3, c'_3}^{13}(\mathbf{x}, z, \mathbf{y}) := \begin{cases} \sum_a \mathbf{n}^{12}(\mathbf{x}, u, \mathbf{v}_{a;1}) \otimes \mathbf{v}_{a;2} \otimes w & \text{if } \mathbf{y} = 1 \in B_0\mathcal{C}_3(c_3, c'_3) \\ \sum_a (-1)^* u \otimes \mathbf{v}_{1;a} \otimes \mathbf{n}^{23}(\mathbf{v}_{a;2}, w, \mathbf{y}) & \text{if } \mathbf{x} = 1 \in B_0\mathcal{C}_1(c_1, c'_1) \\ \sum_a \mathbf{n}^{12}(u, \mathbf{v}_{a;1}) \otimes \mathbf{v}_{a;2} \\ \quad + \sum_a (-1)^* u \otimes \mathbf{v}_{a;1} \otimes \mathbf{n}^{23}(\mathbf{v}_{a;2}, w) \\ \quad + (-1)^{\deg u} u \otimes \hat{d}(\mathbf{v}) \otimes w & \text{if } \mathbf{x} = \mathbf{y} = 1 \\ 0 & \text{otherwise,} \end{cases} \quad (10.7)$$

where $*$ = $\deg u + \deg' \mathbf{v}_{a;1}$ and $\Delta \mathbf{v} = \sum_a \mathbf{v}_{a;1} \otimes \mathbf{v}_{a;2}$. It is straightforward to check (5.19) with sign modified. (See Remark 10.7.) We thus defined \mathbf{ten}_{ob} .

Remark 10.7. We remark that in the second, fourth and fifth lines of the right hand side we used $\deg u$ and not $\deg' u$. \diamond

Remark 10.8. Note that in the case of $\mathfrak{D}^{13} = \mathbf{ten}(\mathfrak{D}^{12}, \mathfrak{D}^{23})$, the ‘left multiplication’ and the ‘right multiplication’ exactly commute. This is the reason why we take 0 in the fourth case of (10.7). In fact $\mathbf{n}_{1,1}$ in the bi-module structure is a chain homotopy between $\mathbf{n}_{0,1}(\mathbf{n}_{1,0}(x, z), y)$ and $(-1)^{\deg' x} \mathbf{n}_{1,0}(x, \mathbf{n}_{0,1}(z, y))$. \diamond

We next define the morphism part of the bi-functor \mathbf{ten} .

Let $\mathfrak{D}^{(j),12} = (\{D_{c_1, c_2}^{(j),12}\}, \{\mathbf{n}_{c'_1, c_1, c_2, c'_2}^{12}\})$ be an object of $\mathcal{B}LMOD(\mathcal{C}_1, \mathcal{C}_2)$ for $j = 1, 2$ and $\mathfrak{D}^{(j),23} = (\{D_{c_2, c_3}^{(j),23}\}, \{\mathbf{n}_{c'_2, c_2, c_3, c'_3}^{23}\})$ an object of $\mathcal{B}LMOD(\mathcal{C}_2, \mathcal{C}_3)$ for $j = 1, 2$. A pre-bi-module homomorphism $\mathfrak{f}^{12} : \mathfrak{D}^{(1),12} \rightarrow \mathfrak{D}^{(2),12}$ (resp. $\mathfrak{f}^{23} : \mathfrak{D}^{(1),23} \rightarrow \mathfrak{D}^{(2),23}$) consists of

$$\mathfrak{f}_{k_1, k_2}^{12} : B_{k_1}\mathcal{C}_1[1](c_1, c'_1) \otimes D_{c'_1, c'_2}^{(1),12} \otimes B_{k_2}\mathcal{C}_2[1](c'_2, c_2) \rightarrow D_{c_1, c_2}^{(2),12},$$

(resp.

$$\mathfrak{f}_{k_2, k_3}^{23} : B_{k_2}\mathcal{C}_2[1](c_2, c'_2) \otimes D_{c'_2, c'_3}^{(1),23} \otimes B_{k_3}\mathcal{C}_3[1](c'_3, c_3) \rightarrow D_{c_2, c_3}^{(2),23}.)$$

See Definition 5.11. We define its tensor product $\mathfrak{f}^{12} \otimes \mathfrak{f}^{23} = \mathfrak{f}^{13}$ as follows. We define $D_{c_1, c_3}^{(j),13}$ in the same way as (10.6). \mathfrak{f}^{13} consists of the maps

$$\mathfrak{f}_{k_1, k_3}^{13} : B_{k_1}\mathcal{C}_1[1](c_1, c'_1) \otimes D_{c'_1, c'_3}^{(1),13} \otimes B_{k_3}\mathcal{C}_3[1](c'_3, c_3) \rightarrow D_{c_2, c_3}^{(2),13},$$

which we define by the next formula. Let $\mathbf{x} \in B\mathcal{C}_1[1](c'_1, c_1)$, $\mathbf{y} \in B\mathcal{C}_3[1](c_3, c'_3)$ and

$$z = u \otimes \mathbf{v} \otimes w \in D_{c_1, c_2}^{(1),12} \widehat{\otimes} B\mathcal{C}_2[1](c_2, c'_2) \widehat{\otimes} D_{c'_2, c_3}^{23} \subseteq D_{c_1, c_3}^{(1),13}.$$

We put

$$\begin{aligned} \mathfrak{f}_{k_1, k_3}^{13}(\mathbf{x}, z, \mathbf{y}) &= \sum_a (-1)^{\deg \mathfrak{f}_{*, k_3}^{23} (\deg' \mathbf{x} + \deg u + \deg' \mathbf{v}_{a;1} + \deg' \mathbf{v}_{a;2})} \\ &\quad \mathfrak{f}_{k_1, *}^{12}(\mathbf{x}, u, \mathbf{v}_{a;1}) \otimes \mathbf{v}_{a;2} \otimes \mathfrak{f}_{*, k_3}^{23}(\mathbf{v}_{a;3}, w, \mathbf{y}). \end{aligned} \quad (10.8)$$

Here $(1 \otimes \Delta) \circ \Delta \mathbf{v} = \sum_a \mathbf{v}_{a;1} \otimes \mathbf{v}_{a;2} \otimes \mathbf{v}_{a;3}$. We can easily show that \mathfrak{f}^{13} gives a chain map

$$\begin{aligned} \mathcal{B}LMOD(\mathcal{C}_1, \mathcal{C}_2)(\mathfrak{D}^{(1),12}, \mathfrak{D}^{(2),12}) \otimes \mathcal{B}LMOD(\mathcal{C}_2, \mathcal{C}_3)(\mathfrak{D}^{(1),23}, \mathfrak{D}^{(2),23}) \\ \rightarrow \mathcal{B}LMOD(\mathcal{C}_1, \mathcal{C}_3)(\mathfrak{D}^{(1),13}, \mathfrak{D}^{(2),13}) \end{aligned}$$

Moreover this map $(\mathfrak{f}^{12}, \mathfrak{f}^{23}) \mapsto \mathfrak{f}^{12} \otimes \mathfrak{f}^{23} = \mathfrak{f}^{13}$ is compatible with composition. Namely

$$\begin{aligned} (\mathfrak{f}^{(1),12} \circ \mathfrak{f}^{(2),12}) \otimes_s (\mathfrak{f}^{(1),23} \circ \mathfrak{f}^{(2),23}) \\ = (-1)^{\deg \mathfrak{f}^{(1),23} \deg \mathfrak{f}^{(2),12}} (\mathfrak{f}^{(1),12} \otimes_s \mathfrak{f}^{(1),23}) \circ (\mathfrak{f}^{(2),12} \otimes_s \mathfrak{f}^{(2),23}). \end{aligned}$$

See (2.14) for \otimes_s .

Therefore by putting other operations to be zero we obtain a required bi-functor. The proof of Lemma-Definition 10.6 is complete. \square

The derived tensor product functor induces

$$\mathcal{B}LMOD(\mathcal{C}_1, \mathcal{C}_2)^{\text{op}} \times \mathcal{B}LMOD(\mathcal{C}_2, \mathcal{C}_3)^{\text{op}} \rightarrow \mathcal{B}LMOD(\mathcal{C}_1, \mathcal{C}_3)^{\text{op}},$$

which we denote also by \mathbf{ten} .

Remark 10.9. The proof shows that \mathbf{ten} is actually a bi-DG-functor between DG-categories. \diamond

The proof of the next proposition is the most nontrivial part of the proof of Theorem 10.1.

Proposition 10.10. *We assume that $\mathcal{C}_1, \mathcal{C}_2, \mathcal{C}_3$ are unital, strict and gapped. Let $\mathcal{F}_{12} : \mathcal{C}_1 \rightarrow \mathcal{C}_2$ and $\mathcal{F}_{23} : \mathcal{C}_2 \rightarrow \mathcal{C}_3$ be filtered A_∞ functors.*

Then the object $\mathbf{ten}_{ob}(\mathfrak{R}\mathfrak{Y}on_{ob}(\mathfrak{F}_{12}), \mathfrak{R}\mathfrak{Y}on_{ob}(\mathfrak{F}_{23}))$ of $\mathcal{B}LMOD(\mathcal{C}_1, \mathcal{C}_3)^{\text{op}}$ is homotopy equivalent to $\mathfrak{R}\mathfrak{Y}on_{ob}(\mathfrak{F}_{23} \circ \mathfrak{F}_{12})$. \diamond

The proof is given in Subsection 10.5.

Remark 10.11. Suppose that $\mathcal{C}_1, \mathcal{C}_2$ and \mathcal{C}_3 are associative rings with unity. They can be regarded as unital A_∞ categories. Let $\mathcal{F}_{12} : \mathcal{C}_1 \rightarrow \mathcal{C}_2$ and $\mathcal{F}_{23} : \mathcal{C}_2 \rightarrow \mathcal{C}_3$ be unital ring homomorphisms which are special cases of A_∞ functors.

The bi-module associated to \mathcal{F}_{12} is \mathcal{C}_2 which is regarded as a right \mathcal{C}_2 module by right multiplication and a left \mathcal{C}_1 module by $x \cdot y = \mathcal{F}_{12}(x)y$. We write this bi-module as ${}_{\mathcal{C}_1}(\mathcal{C}_2)_{\mathcal{C}_2}$. In the same way \mathcal{F}_{23} corresponds to ${}_{\mathcal{C}_2}(\mathcal{C}_3)_{\mathcal{C}_3}$.

Their tensor product is

$${}_{\mathcal{C}_1}(\mathcal{C}_2)_{\mathcal{C}_2} \otimes_{\mathcal{C}_2} {}_{\mathcal{C}_2}(\mathcal{C}_3)_{\mathcal{C}_3} = {}_{\mathcal{C}_1}(\mathcal{C}_3)_{\mathcal{C}_3}.$$

Here the left \mathcal{C}_1 module structure is induced by $\mathcal{F}_{23} \circ \mathcal{F}_{12}$. This is Proposition 10.10 in this case. \diamond

Now we are in the position to complete the proof of Theorem 10.1. We consider the bi-functor

$$\mathbf{ten} \circ (\mathfrak{R}\mathfrak{Y}\mathfrak{on} \times \mathfrak{R}\mathfrak{Y}\mathfrak{on}) : \mathcal{F}\mathcal{U}\mathcal{N}\mathcal{C}(\mathcal{C}_1, \mathcal{C}_2) \times \mathcal{F}\mathcal{U}\mathcal{N}\mathcal{C}(\mathcal{C}_2, \mathcal{C}_3) \rightarrow \mathcal{B}\mathcal{I}\mathcal{M}\mathcal{O}\mathcal{D}(\mathcal{C}_1, \mathcal{C}_3)^{\text{op}}.$$

We consider the full subcategory $\mathfrak{R}\mathfrak{ep}(\mathcal{C}_1, \mathcal{C}_3)$ of $\mathcal{B}\mathcal{I}\mathcal{M}\mathcal{O}\mathcal{D}(\mathcal{C}_1, \mathcal{C}_3)^{\text{op}}$ whose object is homotopy equivalent to an image of $\mathfrak{R}\mathfrak{Y}\mathfrak{on} : \mathcal{F}\mathcal{U}\mathcal{N}\mathcal{C}(\mathcal{C}_1, \mathcal{C}_3) \rightarrow \mathcal{B}\mathcal{I}\mathcal{M}\mathcal{O}\mathcal{D}(\mathcal{C}_1, \mathcal{C}_3)^{\text{op}}$. Proposition 10.10 implies that the image of $\mathbf{ten} \circ (\mathfrak{R}\mathfrak{Y}\mathfrak{on} \times \mathfrak{R}\mathfrak{Y}\mathfrak{on})$ is contained in this full subcategory.

Moreover by Lemma-Definition 10.3 and Theorem 2.28, there exists a filtered A_∞ functor $\mathfrak{R}\mathfrak{ep}(\mathcal{C}_1, \mathcal{C}_3) \rightarrow \mathcal{F}\mathcal{U}\mathcal{N}\mathcal{C}(\mathcal{C}_1, \mathcal{C}_3)$ which is a homotopy inverse to $\mathfrak{R}\mathfrak{Y}\mathfrak{on}$. Therefore there exists a filtered A_∞ functor $\mathbf{Comp} : \mathcal{F}\mathcal{U}\mathcal{N}\mathcal{C}(\mathcal{C}_1, \mathcal{C}_2) \times \mathcal{F}\mathcal{U}\mathcal{N}\mathcal{C}(\mathcal{C}_2, \mathcal{C}_3) \rightarrow \mathcal{F}\mathcal{U}\mathcal{N}\mathcal{C}(\mathcal{C}_1, \mathcal{C}_3)$ such that the next diagram commutes up to homotopy equivalence.

$$\begin{array}{ccc} \mathcal{F}\mathcal{U}\mathcal{N}\mathcal{C}(\mathcal{C}_1, \mathcal{C}_2) \times \mathcal{F}\mathcal{U}\mathcal{N}\mathcal{C}(\mathcal{C}_2, \mathcal{C}_3) & \longrightarrow & \mathcal{F}\mathcal{U}\mathcal{N}\mathcal{C}(\mathcal{C}_1, \mathcal{C}_3) \\ \downarrow & & \downarrow \\ \mathcal{B}\mathcal{I}\mathcal{M}\mathcal{O}\mathcal{D}(\mathcal{C}_1, \mathcal{C}_2)^{\text{op}} \times \mathcal{B}\mathcal{I}\mathcal{M}\mathcal{O}\mathcal{D}(\mathcal{C}_2, \mathcal{C}_3)^{\text{op}} & \longrightarrow & \mathcal{B}\mathcal{I}\mathcal{M}\mathcal{O}\mathcal{D}(\mathcal{C}_1, \mathcal{C}_3)^{\text{op}} \end{array} \quad (10.9)$$

This is the required functor. \square

Remark 10.12. The construction of the composition functor we gave in this subsection is rather indirect. In other words, we did not provide an explicit formula how the pre-natural transformations are sent by this functor. This is because an explicit homotopy inverse to the Yoneda functor is not given. We can certainly find some formula by following the proof. In fact the Yoneda functor is explicitly given in [Fu7] and the proof of Theorem 2.28 in [Fu7] is by induction each of whose steps is in principle can be made explicit. However the explicit formula which we may obtain in that way seems to be very complicated and is not practical to use it. \diamond

10.2. Proof of Theorem 9.1. In this section we prove Theorem 9.1. Before starting the proof we twist the (category version of the) map $\mathcal{Y}\mathcal{T}$ in Proposition 9.12 by bounding cochains. We denote by $\mathcal{L}_i, \mathcal{L}_{ii'}$ or $\mathcal{L}_i^{(j)}, \mathcal{L}_{ii'}^{(j)}$ objects of $\mathfrak{F}\mathfrak{u}\mathfrak{k}\mathfrak{st}(X_i), \mathfrak{F}\mathfrak{u}\mathfrak{k}\mathfrak{st}(-X_i \times X_{i'})$. We recall

$$B_k CF[1](\mathcal{L}_i, \mathcal{L}'_i) = \bigoplus_{\mathcal{L}_i = \mathcal{L}_i^{(0)}, \dots, \mathcal{L}_i^{(k)} = \mathcal{L}'_i} \bigotimes_{j=1}^k CF(\mathcal{L}_i^{(j-1)}, \mathcal{L}_i^{(j)})[1]$$

and $BCF[1](\mathcal{L}_i, \mathcal{L}'_i)$ is their completed direct sum over k . We define $B_k CF[1](\mathcal{L}_{ii'}, \mathcal{L}'_{ii'})$, $BCF[1](\mathcal{L}_{ii'}, \mathcal{L}'_{ii'})$ in the same way.

We define a map $\mathfrak{t}_{\bar{b}} : \bigotimes_{j=1}^k CF(\mathcal{L}_i^{(j-1)}, \mathcal{L}_i^{(j)})[1] \rightarrow BCF[1](\mathcal{L}_i, \mathcal{L}'_i)$ by

$$\mathfrak{t}_{\bar{b}}(x_1, \dots, x_k) := e^{b_0} x_1 e^{b_1} x_2 \dots x_{k-1} e^{b_{k-1}} x_k e^{b_k}.$$

(See (5.15).) It induces $\mathfrak{t}_{\bar{b}} : BCF[1](\mathcal{L}_i, \mathcal{L}'_i) \rightarrow BCF[1](\mathcal{L}_i, \mathcal{L}'_i)$. We define $\mathfrak{t}_{\bar{b}} : BCF[1](\mathcal{L}_{ii'}, \mathcal{L}'_{ii'}) \rightarrow BCF[1](\mathcal{L}_{ii'}, \mathcal{L}'_{ii'})$ in the same way.

We now define the map

$$\begin{aligned} \mathcal{Y}\mathcal{T}^{\bar{b}} : & BCF[1](\mathcal{L}_1, \mathcal{L}'_1) \otimes BCF[1](\mathcal{L}_{12}, \mathcal{L}'_{12}) \otimes BCF[1](\mathcal{L}_{23}, \mathcal{L}'_{23}) \\ & \otimes CF(\mathcal{L}'_1, \mathcal{L}'_{12}; \mathcal{L}'_2) \otimes BCF[1](\mathcal{L}'_2, \mathcal{L}_2) \\ & \otimes CF(\mathcal{L}_2, \mathcal{L}'_{23}; \mathcal{L}'_3) \otimes BCF[1](\mathcal{L}'_3, \mathcal{L}_3) \\ & \otimes BCF[1](\mathcal{L}'_{13}, \mathcal{L}_{13}) \otimes CF(\mathcal{L}_{13}; \mathcal{L}_{12}, \mathcal{L}_{23}) \rightarrow CF(\mathcal{L}_1, \mathcal{L}_{13}; \mathcal{L}_3) \end{aligned} \quad (10.10)$$

by composing $\mathfrak{t}_{\bar{v}}$ with $\mathcal{Y}\mathcal{T}$. (We do not apply $\mathfrak{t}_{\bar{v}}$ to $CF(\mathcal{L}'_1, \mathcal{L}'_{12}; \mathcal{L}'_2)$, $CF(\mathcal{L}_2, \mathcal{L}'_{23}; \mathcal{L}'_3)$, $CF(\mathcal{L}_1, \mathcal{L}_{13}; \mathcal{L}_3)$ factors.)

Lemma 10.13. (9.32) holds when we replace $\mathcal{Y}\mathcal{T}$, \hat{d} , \mathfrak{n} by $\mathcal{Y}\mathcal{T}^{\bar{b}}$, \hat{d}^b , \mathfrak{n}^b , respectively. Here \hat{d}^b , \mathfrak{n}^b are defined by $\mathfrak{t}_{\bar{v}} \circ \hat{d}^b = \hat{d} \circ \mathfrak{t}_{\bar{v}}$, $\mathfrak{t}_{\bar{v}} \circ \mathfrak{n}^b = \mathfrak{n} \circ \mathfrak{t}_{\bar{v}}$.

This is immediate from Proposition 9.12.

Proof of Theorem 9.1. Let \mathcal{L}_{12} , \mathcal{L}_{23} be as in Theorem 9.1 and $\mathcal{L}_{13} = \mathcal{L}_{23} \circ \mathcal{L}_{12}$. We apply the relative Yoneda functor $\mathfrak{R}\mathfrak{Y}\mathfrak{on}_{\text{ob}}$ to $\mathcal{W}_{\mathcal{L}_{13}}$. By definition we obtain $\mathcal{CF}(\mathbb{L}_1, \mathbb{L}_{13}; \mathbb{L}_3)$. We fixed $\mathcal{L}_{13} \in \mathbb{L}_{13}$ so we regard $\mathcal{CF}(\mathbb{L}_1, \mathbb{L}_{13}; \mathbb{L}_3)$ as a left- $\mathfrak{F}\mathfrak{u}\mathfrak{k}\mathfrak{st}(X_1)$ and right- $\mathfrak{F}\mathfrak{u}\mathfrak{k}\mathfrak{st}(X_3)$ bi-module. It assigns

$$\mathcal{W}^{(1)}(\mathcal{L}_1, \mathcal{L}_3) = CF(\mathcal{L}_1, \mathcal{L}_{13}; \mathcal{L}_3). \quad (10.11)$$

to $\mathcal{L}_i \in \mathfrak{Ob}(\mathfrak{F}\mathfrak{u}\mathfrak{k}\mathfrak{st}(X_i))$ for $i = 1, 3$.

We apply the relative Yoneda functor $\mathfrak{R}\mathfrak{Y}\mathfrak{on}_{\text{ob}}$ to $\mathcal{W}_{\mathcal{L}_{12}}$ and $\mathcal{W}_{\mathcal{L}_{23}}$. We then obtain $\mathcal{CF}(\mathbb{L}_1, \mathbb{L}_{12}; \mathbb{L}_2)$ and $\mathcal{CF}(\mathbb{L}_2, \mathbb{L}_{23}; \mathbb{L}_3)$, respectively. We fix \mathcal{L}_{12} and \mathcal{L}_{23} and regard them as left- $\mathfrak{F}\mathfrak{u}\mathfrak{k}\mathfrak{st}(X_1)$ and right- $\mathfrak{F}\mathfrak{u}\mathfrak{k}\mathfrak{st}(X_2)$ and left- $\mathfrak{F}\mathfrak{u}\mathfrak{k}\mathfrak{st}(X_2)$ and right- $\mathfrak{F}\mathfrak{u}\mathfrak{k}\mathfrak{st}(X_3)$ modules respectively. We consider $\mathcal{W}_{\mathcal{L}_{23}} \circ \mathcal{W}_{\mathcal{L}_{12}}$ and apply the relative Yoneda functor $\mathfrak{R}\mathfrak{Y}\mathfrak{on}_{\text{ob}}$ to it. Then by Proposition 10.10 we obtain

$$\text{ten}(\mathcal{CF}(\mathbb{L}_1, \mathbb{L}_{12}; \mathbb{L}_2), \mathcal{CF}(\mathbb{L}_2, \mathbb{L}_{23}; \mathbb{L}_3)).$$

We regard it as a left- $\mathfrak{F}\mathfrak{u}\mathfrak{k}\mathfrak{st}(X_1)$ and right- $\mathfrak{F}\mathfrak{u}\mathfrak{k}\mathfrak{st}(X_3)$ bi-module. To $\mathcal{L}_i \in \mathfrak{Ob}(\mathfrak{F}\mathfrak{u}\mathfrak{k}\mathfrak{st}(X_i))$ for $i = 1, 3$ it assigns:

$$\begin{aligned} & \mathcal{W}^{(2)}(\mathcal{L}_1, \mathcal{L}_3) \\ &= \bigoplus_{\mathcal{L}_2, \mathcal{L}'_2} CF(\mathcal{L}_1, \mathcal{L}_{12}; \mathcal{L}_2) \otimes BCF[1](\mathcal{L}_2, \mathcal{L}'_2) \otimes CF(\mathcal{L}'_2, \mathcal{L}_{23}; \mathcal{L}_3). \end{aligned} \quad (10.12)$$

The pre-bi-module homomorphism we look for is a system of maps

$$BCF[1](\mathcal{L}_1, \mathcal{L}'_1) \otimes \mathcal{W}^{(2)}(\mathcal{L}'_1, \mathcal{L}'_3) \otimes BCF[1](\mathcal{L}'_3, \mathcal{L}_3) \rightarrow \mathcal{W}^{(1)}(\mathcal{L}_1, \mathcal{L}_3). \quad (10.13)$$

Namely

$$\begin{aligned} \mathcal{T} : & BCF[1](\mathcal{L}_1, \mathcal{L}'_1) \otimes CF(\mathcal{L}'_1, \mathcal{L}_{12}; \mathcal{L}_2) \otimes BCF[1](\mathcal{L}_2, \mathcal{L}'_2) \\ & \otimes CF(\mathcal{L}'_2, \mathcal{L}_{23}; \mathcal{L}'_3) \otimes BCF[1](\mathcal{L}'_3, \mathcal{L}_3) \rightarrow CF(\mathcal{L}_1, \mathcal{L}_{13}; \mathcal{L}_3). \end{aligned}$$

We define

$$\begin{aligned} & \mathcal{T}(\mathbf{h}_1, h_{\infty, +, 12}, \mathbf{h}_2, h_{\infty, +, 23}, \mathbf{h}_3) \\ &= (-1)^* \mathcal{Y}\mathcal{T}^{\bar{b}}(\mathbf{1}_{123}; \emptyset_{12}, \emptyset_{23}, \emptyset_{13}; h_{\infty, +, 12}, h_{\infty, +, 23}; \mathbf{h}_1, \mathbf{h}_2, \mathbf{h}_3). \end{aligned} \quad (10.14)$$

Here $\emptyset_{ii'} = 1 \in B_0 CF(\mathcal{L}_{ii'})$ and $\mathbf{1}_{123} \in CF(\mathcal{L}_{12}, \mathcal{L}_{23}; \mathcal{L}_{13})$ is the cyclic element. The sign $(-1)^*$ is determined by the Koszul rule. We count the way exchanging the order of the variables using the shifted degree deg' for elements of $BCF[1](\mathcal{L}'_i, \mathcal{L}_i)$ (or $BCF[1](\mathcal{L}_i, \mathcal{L}_i)$) and deg for elements of $CF(\mathcal{L}'_1, \mathcal{L}_{12}; \mathcal{L}_2)$ etc. Then we put the sign according to whether the total count is even or odd.

Remark 10.14. The sign in (10.13) is also by Koszul rule. However it is different from the one we describe above. Namely deg' is used also for elements of tri-modules, $CF(\mathcal{L}'_1, \mathcal{L}_{12}; \mathcal{L}_2)$ etc. We change the sign of the maps in the same way as (5.11) (See also (10.2).) to go from one to the other. \diamond

The condition that \mathcal{T} is a bi-module homomorphism is a consequence of Lemma 10.13 and the fact that $\mathbf{1}_{123}$ becomes a cycle (after twisting the boundary operator by the bounding cochains b_{12}, b_{23}, b_{13}).

We continue the proof of Theorem 9.1 and prove that \mathcal{T} is a homotopy equivalence. In view of Lemma 7.9 the next step is to prove that the chain map

$$\mathcal{T}_{0,0;\mathcal{L}_1,\mathcal{L}_3} : \mathcal{W}^{(2)}(\mathcal{L}_1, \mathcal{L}_3) \rightarrow \mathcal{W}^{(1)}(\mathcal{L}_1, \mathcal{L}_3) \quad (10.15)$$

is a chain homotopy equivalence for arbitrary $\mathcal{L}_1, \mathcal{L}_3$. By Proposition 10.10 the derived tensor product (10.12) is chain homotopy equivalent to

$$CF(\mathcal{W}_{\mathcal{L}_{23}}(\mathcal{W}_{\mathcal{L}_{12}}(\mathcal{L}_1)), \mathcal{L}_3) \cong CF(\mathcal{W}_{\mathcal{L}_{12}}(\mathcal{L}_1), \mathcal{L}_{23}; \mathcal{L}_3) \quad (10.16)$$

In fact the chain homotopy equivalence from (10.16) to (10.12) is given by

$$x \mapsto \mathbf{1}_{12} \otimes x, \quad (10.17)$$

for $x \in CF(\mathcal{W}_{\mathcal{L}_{23}}(\mathcal{W}_{\mathcal{L}_{12}}(\mathcal{L}_1)), \mathcal{L}_3)$. Here $\mathbf{1}_{12} \in CF(\mathcal{L}_1, \mathcal{L}_{12}; \mathcal{W}_{\mathcal{L}_{12}}(\mathcal{L}_1))$ is the cyclic element which becomes the unity in $CF(\mathcal{W}_{\mathcal{L}_{12}}(\mathcal{L}_1))$ by the isomorphism

$$CF(\mathcal{L}_1, \mathcal{L}_{12}; \mathcal{W}_{\mathcal{L}_{12}}(\mathcal{L}_1)) \cong CF(\mathcal{W}_{\mathcal{L}_{12}}(\mathcal{L}_1)).$$

Note that if we regard x as an element of the right hand side of (10.16) then $\mathbf{1}_{12} \otimes x$ is an element of

$$CF(\mathcal{L}_1, \mathcal{L}_{12}; \mathcal{W}_{\mathcal{L}_{12}}(\mathcal{L}_1)) \otimes CF(\mathcal{W}_{\mathcal{L}_{12}}(\mathcal{L}_1), \mathcal{L}_{23}; \mathcal{L}_3),$$

which is contained in (10.12) as the case $\mathcal{L}_2 = \mathcal{L}'_2 = \mathcal{W}_{\mathcal{L}_{12}}(\mathcal{L}_1)$.

The map (10.17) is identified with the map $\mathcal{S}_{12;0,0}$ in (10.40), which we will use to prove Proposition 10.10.

Thus to prove that (10.15) is a chain homotopy equivalence it suffices to show that the composition

$$CF(\mathcal{W}_{\mathcal{L}_{12}}(\mathcal{L}_1), \mathcal{L}_{12}; \mathcal{L}_3) \rightarrow \mathcal{W}^{(2)}(\mathcal{L}_1, \mathcal{L}_3) \rightarrow \mathcal{W}^{(1)}(\mathcal{L}_1, \mathcal{L}_3) \quad (10.18)$$

is a chain homotopy equivalence. By definition (10.18) is the map

$$\begin{aligned} h_{\infty,+;23} &\mapsto \mathcal{T}(\emptyset_1, \mathbf{1}_{12}, \emptyset_2, h_{\infty,+;23}, \emptyset_3) \\ &= \mathcal{Y} \mathcal{S}^{\bar{b}}(\mathbf{1}_{123}; \emptyset_{12}, \emptyset_{23}, \emptyset_{13}; \mathbf{1}_{12}, h_{\infty,+;23}; \emptyset_1, \emptyset_2, \emptyset_3). \end{aligned} \quad (10.19)$$

Here $\emptyset_i = 1 \in B_0 CF(\mathcal{L}_i)$, for $i = 1, 2, 3$.

Lemma 10.15.

(1)

$$\begin{aligned} CF(\mathcal{W}_{\mathcal{L}_{12}}(\mathcal{L}_1), \mathcal{L}_{23}; \mathcal{L}_3) &\cong \mathcal{W}^{(1)}(\mathcal{L}_1, \mathcal{L}_3) \\ &\cong \Omega(L_1 \times_{X_1} L_{12} \times_{X_2} L_{23} \times_{X_3} L_3, \Theta_-) \widehat{\otimes} \Lambda_0. \end{aligned}$$

(2) The map (10.19) is congruent to the identity map modulo Λ_+ via the isomorphism of item (1).

◇

Proof. (1) is immediate from the definition. (2) then follows from the fact that energy 0 part of the map $\mathcal{F} \mathcal{Y}^{\bar{b}}$ is defined by the moduli space of constant maps. □

To complete the proof of Theorem 9.1 we need to discuss the following point. Note that while we proved Proposition 9.2 we showed that the two bounding cochains, written as $b_3^{(1)}$ and $b_3^{(2)}$ there, are gauge equivalent. However they are not necessary equal. In the above argument we used $b_3^{(2)}$. In fact $CF(\mathcal{L}_2, \mathcal{L}_{23}; \mathcal{L}_3)$ using $b_3^{(2)}$ gives $\mathcal{W}_{\mathcal{L}_{23}} : \mathfrak{F}\mathfrak{u}\mathfrak{k}\mathfrak{st}(X_2) \rightarrow \mathfrak{F}\mathfrak{u}\mathfrak{k}\mathfrak{st}(X_3)$.

On the other hand, $CF(\mathcal{L}_1, \mathcal{L}_{13}; \mathcal{L}_3)$ with $b_3^{(1)}$ gives $\mathcal{W}_{\mathcal{L}_{13}} : \mathfrak{F}\mathfrak{u}\mathfrak{k}\mathfrak{st}(X_1) \rightarrow \mathfrak{F}\mathfrak{u}\mathfrak{k}\mathfrak{st}(X_3)$. Therefore to complete the proof of Theorem 9.1 we need to compare $CF(\mathcal{L}_1, \mathcal{L}_{13}; \mathcal{L}_3)$ with two different choices of bounding cochains and show that they are homotopy equivalent as left- $\mathfrak{F}\mathfrak{u}\mathfrak{k}\mathfrak{st}(X_1)$ and right- $\mathfrak{F}\mathfrak{u}\mathfrak{k}\mathfrak{st}(X_3)$ bi-modules. We can prove it in the same way as the proof of Proposition 9.2 as follows.

We consider $\text{Poly}(CF(\mathcal{L}_1, \mathcal{L}_{13}; \mathcal{L}_3))$ which is a left- $\mathfrak{F}\mathfrak{u}\mathfrak{k}\mathfrak{st}(X_1)$ and right- $\text{Poly}(\mathfrak{F}\mathfrak{u}\mathfrak{k}\mathfrak{st}(X_3))$ bi-module. (See [FOOO1, Subsection 5.2.3] and the proof of Proposition 6.16.) Here $\text{Poly}(\mathfrak{F}\mathfrak{u}\mathfrak{k}\mathfrak{st}(X_3))$ is an A_∞ category obtained from $\mathfrak{F}\mathfrak{u}\mathfrak{k}\mathfrak{st}(X_3)$ replacing the morphism modules $CF(\mathcal{L}_3, \mathcal{L}'_3)$ by $\text{Poly}(CF(\mathcal{L}_3, \mathcal{L}'_3))$.

The A_∞ category $\text{Poly}(\mathfrak{F}\mathfrak{u}\mathfrak{k}\mathfrak{st}(X_3))$ is curved. Note that each objects of $\mathfrak{F}\mathfrak{u}\mathfrak{k}\mathfrak{st}(X_3)$ which is in the image of the functors $\mathcal{W}_{\mathcal{L}_{23}} \circ \mathcal{W}_{\mathcal{L}_{12}}$ (resp. $\mathcal{W}_{\mathcal{L}_{13}}$) comes with a choice of bounding cochains $b_3^{(2)}$ (resp. $b_3^{(1)}$). We can lift those choices to a bounding cochain \hat{b} such that $\text{Eval}_{s=0}(\hat{b}) = b_3^{(1)}$ and $\text{Eval}_{s=1}(\hat{b}) = b_3^{(2)}$. (See the proof of Lemma 9.14.) We use \hat{b} to eliminate curvature and obtain an object of associated strict category of $\text{Poly}(\mathfrak{F}\mathfrak{u}\mathfrak{k}\mathfrak{st}(X_3))$, which we denote by $\text{Poly}_{st}(\mathfrak{F}\mathfrak{u}\mathfrak{k}\mathfrak{st}(X_3))$.

By the proof of Proposition 9.2 there exists a commutative diagram of A_∞ functors:

$$\begin{array}{ccc}
\mathfrak{F}\mathfrak{u}\mathfrak{k}\mathfrak{st}(X_1) & \longrightarrow & \mathcal{F}\mathcal{U}\mathcal{N}\mathcal{C}(\mathfrak{F}\mathfrak{u}\mathfrak{k}\mathfrak{st}(X_3)^{\text{op}}, \mathcal{C}\mathcal{H}) \\
= \downarrow & & \downarrow \text{Eval}_{s=0}^* \\
\mathfrak{F}\mathfrak{u}\mathfrak{k}\mathfrak{st}(X_1) & \longrightarrow & \mathcal{F}\mathcal{U}\mathcal{N}\mathcal{C}(\text{Poly}_{st}(\mathfrak{F}\mathfrak{u}\mathfrak{k}\mathfrak{st}(X_3))^{\text{op}}, \mathcal{C}\mathcal{H}) \\
= \uparrow & & \uparrow \text{Eval}_{s=1}^* \\
\mathfrak{F}\mathfrak{u}\mathfrak{k}\mathfrak{st}(X_1) & \longrightarrow & \mathcal{F}\mathcal{U}\mathcal{N}\mathcal{C}(\mathfrak{F}\mathfrak{u}\mathfrak{k}\mathfrak{st}(X_3)^{\text{op}}, \mathcal{C}\mathcal{H})
\end{array} \tag{10.20}$$

Here the first horizontal arrow is obtained by using $b_3^{(1)}$ and the third horizontal arrow is obtained by using $b_3^{(2)}$. Since the right vertical arrows are homotopy equivalences, we obtained the required homotopy equivalence.

The proof of Theorem 9.1 is complete. \square

10.3. The compatibility as bi-functors. We can strengthen Theorem 9.1 as follows.

Theorem 10.16. *The next diagram commutes up to homotopy equivalence of unital, strict and gapped filtered A_∞ bi-functors.*

$$\begin{array}{ccc}
\mathfrak{F}\mathfrak{u}\mathfrak{k}\mathfrak{st}(-X_1 \times X_2) \times \mathfrak{F}\mathfrak{u}\mathfrak{k}\mathfrak{st}(-X_2 \times X_3) & \longrightarrow & \mathfrak{F}\mathfrak{u}\mathfrak{k}\mathfrak{st}(-X_1 \times X_3) \\
\downarrow & & \downarrow \\
\mathcal{F}\mathcal{U}\mathcal{N}\mathcal{C}(\mathfrak{F}\mathfrak{u}\mathfrak{k}\mathfrak{st}(X_1), \mathfrak{F}\mathfrak{u}\mathfrak{k}\mathfrak{st}(X_2)) & & \mathcal{F}\mathcal{U}\mathcal{N}\mathcal{C}(\mathfrak{F}\mathfrak{u}\mathfrak{k}\mathfrak{st}(X_1), \mathfrak{F}\mathfrak{u}\mathfrak{k}\mathfrak{st}(X_3)) \\
\times \mathcal{F}\mathcal{U}\mathcal{N}\mathcal{C}(\mathfrak{F}\mathfrak{u}\mathfrak{k}\mathfrak{st}(X_2), \mathfrak{F}\mathfrak{u}\mathfrak{k}\mathfrak{st}(X_3)) & \longrightarrow &
\end{array}$$

Here the first horizontal arrow is (8.4) and the second horizontal arrow is (10.1) in the case of $\mathcal{C}_i = \mathfrak{F}\mathfrak{u}\mathfrak{k}\mathfrak{st}(X_i)$. The vertical arrows are correspondence bi-functors. \diamond

The proof will be given in Subsection 10.4.

Remark 10.17. Theorem 10.16 enhances Theorem 9.1 and Theorem 9.1 enhances Proposition 9.2. Below we explain the difference between those three statements. Theorem 10.16 is a coincidence between two bi-functors

$$\mathfrak{Fukst}(-X_1 \times X_2) \times \mathfrak{Fukst}(-X_2 \times X_3) \rightarrow \mathcal{FUN}\mathcal{C}(\mathfrak{Fukst}(X_1), \mathfrak{Fukst}(X_3)). \quad (10.21)$$

We first fix an object \mathcal{L}_{12} (resp. \mathcal{L}_{23}) of $\mathfrak{Fukst}(-X_1 \times X_2)$ (resp. $\mathfrak{Fukst}(-X_2 \times X_3)$). Then the two bi-functors (10.21) give two objects of $\mathcal{FUN}\mathcal{C}(\mathfrak{Fukst}(X_1), \mathfrak{Fukst}(X_3))$. The coincidence of those two objects, which are the functors : $\mathfrak{Fukst}(X_1) \rightarrow \mathfrak{Fukst}(X_3)$, is Theorem 9.1. Note that a functor : $\mathfrak{Fukst}(X_1) \rightarrow \mathfrak{Fukst}(X_3)$ gives a set theoretical map : $\mathfrak{OB}(\mathfrak{Fukst}(X_1)) \rightarrow \mathfrak{OB}(\mathfrak{Fukst}(X_3))$. The coincidence of two such set theoretical maps is Proposition 9.2.

Theorem 9.1 contains the coincidence of the morphism parts of the functors : $\mathfrak{Fukst}(X_1) \rightarrow \mathfrak{Fukst}(X_3)$. To prove Theorem 9.1 we proved that (10.15) is homotopy equivalence of left- $\mathfrak{Fukst}(X_1)$ and right- $\mathfrak{Fukst}(X_3)$ bi-modules.

Theorem 10.16 includes statements on the coincidence of the way the morphisms of $\mathfrak{Fukst}(-X_1 \times X_2)$ and of $\mathfrak{Fukst}(-X_2 \times X_3)$ are mapped by (10.21). In the homology level it implies the following. Suppose $\mathcal{L}_{12}, \mathcal{L}'_{12}$ (resp. $\mathcal{L}_{23}, \mathcal{L}'_{23}$) are objects of $\mathfrak{Fukst}(-X_1 \times X_2)$ (resp. $\mathfrak{Fukst}(-X_2 \times X_3)$) and $\mathcal{L}_1, \mathcal{L}'_1$ are objects of $\mathfrak{Fukst}(X_1)$.

(10.21) defines a homomorphism

$$HF(\mathcal{L}_{12}, \mathcal{L}'_{12}) \otimes HF(\mathcal{L}_{23}, \mathcal{L}'_{23}) \rightarrow Hom(HF(\mathcal{L}_1, \mathcal{L}'_1), HF(\mathcal{L}_3, \mathcal{L}'_3)). \quad (10.22)$$

Here \mathcal{L}_3 (resp. \mathcal{L}'_3) is obtained by transforming \mathcal{L}_1 (resp. \mathcal{L}'_1) via the composition of \mathcal{L}_{12} and \mathcal{L}_{23} (resp. \mathcal{L}'_{12} and \mathcal{L}'_{23}). Theorem 10.16 implies that the homomorphisms (10.22) obtained by the following two different ways coincide.

The first way to obtain (10.22) is the following. Let \mathcal{L}_{13} (resp. \mathcal{L}'_{13}) be the composition of \mathcal{L}_{12} (resp. \mathcal{L}'_{12}) and \mathcal{L}_{23} (resp. \mathcal{L}'_{23}). Then the composition bi-functor induces a homomorphism

$$HF(\mathcal{L}_{12}, \mathcal{L}'_{12}) \otimes HF(\mathcal{L}_{23}, \mathcal{L}'_{23}) \rightarrow HF(\mathcal{L}_{13}, \mathcal{L}'_{13}). \quad (10.23)$$

On the other hand by (7.3) we have

$$HF(\mathcal{L}_{13}, \mathcal{L}'_{13}) \rightarrow Hom(HF(\mathcal{L}_1, \mathcal{L}'_1), HF(\mathcal{L}_3, \mathcal{L}'_3)). \quad (10.24)$$

The composition of (10.23) and (10.24) defines a homomorphism (10.22).

The second way to obtain (10.22) is the following. We have the following homomorphisms from (7.3)

$$\begin{aligned} HF(\mathcal{L}_{12}, \mathcal{L}'_{12}) &\rightarrow Hom(HF(\mathcal{L}_1, \mathcal{L}'_1), HF(\mathcal{L}_2, \mathcal{L}'_2)), \\ HF(\mathcal{L}_{23}, \mathcal{L}'_{23}) &\rightarrow Hom(HF(\mathcal{L}_2, \mathcal{L}'_2), HF(\mathcal{L}_3, \mathcal{L}'_3)). \end{aligned} \quad (10.25)$$

Here \mathcal{L}_{12} (resp. \mathcal{L}'_{12}) transforms \mathcal{L}_1 (resp. \mathcal{L}'_1) to \mathcal{L}_2 (resp. \mathcal{L}'_2). On the other hand, the composition of homomorphisms define a homomorphism

$$\begin{aligned} Hom(HF(\mathcal{L}_1, \mathcal{L}'_1), HF(\mathcal{L}_2, \mathcal{L}'_2)) \otimes Hom(HF(\mathcal{L}_2, \mathcal{L}'_2), HF(\mathcal{L}_3, \mathcal{L}'_3)) \\ \rightarrow Hom(HF(\mathcal{L}_1, \mathcal{L}'_1), HF(\mathcal{L}_3, \mathcal{L}'_3)). \end{aligned} \quad (10.26)$$

The composition of (10.25) and (10.26) is the second way to obtain (10.22). \diamond

To prove Theorem 10.16 we need more homological algebra. In Subsection 10.1 we used the derived tensor product to define the composition bi-functor of functor categories. In this subsection we define the derived Hom functor.

Definition 10.18. Let \mathcal{C} and $\mathcal{C}_{(i)}$, $i = 1, 2$ be strict, unital and gapped filtered A_∞ categories and \mathfrak{D}_1 a left- $\mathcal{C}, \mathcal{C}_{(1)}$ right- $\mathcal{C}_{(2)}$ tri-module. For $c \in \mathfrak{D}\mathfrak{B}(\mathcal{C})$ we define a left- $\mathcal{C}_{(1)}$ right- $\mathcal{C}_{(2)}$ bi-module $\mathfrak{D}|_c$ as follows.

(1) If $c_i \in \mathfrak{D}\mathfrak{B}(\mathcal{C}_{(i)})$ then

$$\mathfrak{D}|_c(c_1, c_2) = \mathfrak{D}(c, c_1; c_2).$$

(2) For $\mathbf{x} \in B_{k_1} \mathcal{C}_{(1)}[1](c_1, c'_1)$, $\mathbf{y} \in B_{k_2} \mathcal{C}_{(2)}[1](c'_2, c_2)$ and $v \in \mathfrak{D}|_c(c'_1, c'_2) = \mathfrak{D}(c, c'_1; c'_2)$ we define

$$\mathbf{n}_{k_1, k_2}(\mathbf{x}; v; \mathbf{y}) \in \mathfrak{D}|_c(c_1, c_2) = \mathfrak{D}(c, c_1; c_2)$$

by the tri-module structure on \mathfrak{D} . This is the structure operation \mathbf{n}_{k_1, k_2} of $\mathfrak{D}|_c$.

◇

Definition 10.19. Let \mathcal{C} and $\mathcal{C}_{(i)}$, $i = 1, 2, 3, 4$ be strict filtered A_∞ categories and \mathfrak{D}_1 (resp. \mathfrak{D}_2) be a left- $\mathcal{C}, \mathcal{C}_{(1)}$ right- $\mathcal{C}_{(2)}$ (resp. left- $\mathcal{C}, \mathcal{C}_{(3)}$ right- $\mathcal{C}_{(4)}$) filtered A_∞ tri-module.

Let $c_i \in \mathfrak{D}\mathfrak{B}(\mathcal{C}_{(i)})$. We define $\mathfrak{H}\mathfrak{om}_{\mathcal{C}}(\mathfrak{D}_1, \mathfrak{D}_2)(c_2, c_3; c_1, c_4)$ as the set of objects $\mathfrak{f} = (\mathfrak{f}_{k_2; c, c'})_{c, c' \in \mathfrak{D}\mathfrak{B}(\mathcal{C}); k=0,1,2, \dots}$ such that

$$\mathfrak{f}_{k; c, c'} : B_k \mathcal{C}[1](c, c') \otimes \mathfrak{D}_1|_{c'}(c_1, c_2) \rightarrow \mathfrak{D}_2|_c(c_3, c_4)$$

is a filtered Λ_0 module homomorphism. ◇

Remark 10.20. We remark that $\mathfrak{H}\mathfrak{om}_{\mathcal{C}}(\mathfrak{D}_1, \mathfrak{D}_2)(c_2, c_3; c_1, c_4)$ is the direct product:

$$\prod_{c, c'} \text{Hom}(B_k \mathcal{C}[1](c, c') \otimes \mathfrak{D}_1|_{c'}(c_1, c_2), \mathfrak{D}_2|_c(c_3, c_4)).$$

In the definition of derived tensor product we used direct *sum*. See (10.6). ◇

Lemma-Definition 10.21. *There exists a left- $\mathcal{C}_{(2), \mathcal{C}_{(3)}$ right- $\mathcal{C}_{(1), \mathcal{C}_{(4)}}$ multi-module $\mathfrak{H}\mathfrak{om}_{\mathcal{C}}(\mathfrak{D}_1, \mathfrak{D}_2)$ so that*

$$(c_2, c_3; c_1, c_4) \mapsto \mathfrak{H}\mathfrak{om}_{\mathcal{C}}(\mathfrak{D}_1, \mathfrak{D}_2)(c_2, c_3; c_1, c_4)$$

in Definition 10.19 is its object part. (We define the boundary operator of the right hand side during the proof.)

We write it $\mathfrak{H}\mathfrak{om}_{\mathcal{C}}(\mathfrak{D}_1, \mathfrak{D}_2)$ and call it the left \mathcal{C} hom-module. ◇

Proof. Let $\mathbf{x}_{(1)} \in B_{k_1} \mathcal{C}_{(1)}[1](c_1, c'_1)$, $\mathbf{y}_{(2)} \in B_{k_2} \mathcal{C}_{(2)}[1](c'_2, c_2)$, $\mathbf{x}_{(3)} \in B_{k_3} \mathcal{C}_{(3)}[1](c_3, c'_3)$, $\mathbf{y}_{(4)} \in B_{k_4} \mathcal{C}_{(4)}[1](c_4, c'_4)$, and $\mathfrak{f} \in \mathfrak{H}\mathfrak{om}_{\mathcal{C}}(\mathfrak{D}_1, \mathfrak{D}_2)(c_2, c_3; c_1, c_4)$.

We define

$$\mathbf{n}_{k_1, k_2, k_3, k_4}(\mathbf{y}_{(2)}, \mathbf{x}_{(3)}, \mathfrak{f}, \mathbf{x}_{(1)}, \mathbf{y}_{(4)}) = \mathfrak{g} \in \mathfrak{H}\mathfrak{om}_{\mathcal{C}}(\mathfrak{D}_1, \mathfrak{D}_2)(c'_2, c_3; c'_1, c_4),$$

as follows. We put $\mathfrak{g} = 0$ if $k_1 + k_2 \neq 0$ and $k_3 + k_4 \neq 0$.

If $k_3 + k_4 = 0$ and $k_1 + k_2 \neq 0$ we define

$$\begin{aligned} \mathbf{n}_{k_1, k_2, 0, 0}(\mathbf{y}_{(2)}, \mathfrak{f}, \mathbf{x}_{(1)})(\mathbf{z}, v) &= \mathfrak{g}_{k; c_2, c'_2}(\mathbf{z}, v) \\ &:= - \sum_c (-1)^* \mathfrak{f}(\mathbf{z}_{c; 1}, \mathbf{n}(\mathbf{z}_{c; 2}, \mathbf{x}_{(1)}, v, \mathbf{y}_{(2)})), \end{aligned} \quad (10.27)$$

with

$$* = \deg' \mathbf{z}_{c; 1} + \deg' \mathfrak{f} + \deg' \mathbf{y}_{(2)} (\deg' \mathfrak{f} + \deg' v + \deg' \mathbf{x} + \deg' \mathbf{z}) + \deg' \mathbf{x}_{(1)} \deg' \mathbf{z}.$$

Here $v \in D_1(c', c'_2, c_3; c'_1, c_4)$, $\mathbf{z} \in B_k \mathcal{C}[1](c, c')$, $\Delta \mathbf{z} = \sum_c \mathbf{z}_{c;1} \otimes \mathbf{z}_{c;2}$ and \mathbf{n} is the structure operation of \mathfrak{D}_1 .

If $k_3 + k_4 \neq 0$ and $k_1 + k_2 = 0$ we define

$$\begin{aligned} \mathbf{n}_{0,0,k_3,k_4}(\mathbf{x}_{(3)}, \mathbf{f}, \mathbf{y}_{(4)})(\mathbf{z}, v) &= \mathfrak{g}_{k;c_2,c'_2}(\mathbf{z}; v) \\ &:= \sum_c (-1)^* \mathbf{n}'(\mathbf{z}_{c;1}, \mathbf{x}_{(3)}, \mathbf{f}(\mathbf{z}_{c;2}, v), \mathbf{y}_{(4)}), \end{aligned} \quad (10.28)$$

with

$$* = \deg \mathbf{y}_{(4)}(\deg' \mathbf{z} + \deg v) + \deg' \mathbf{x}_{(3)} \deg' \mathbf{z}_{c;1} + \deg \mathbf{f} \deg' \mathbf{z}_{c;1}.$$

Here v , \mathbf{z} , $\mathbf{z}_{c;1}$, $\mathbf{z}_{c;2}$ are as above and \mathbf{n}' is the structure operation of \mathfrak{D}_{32} .

If $k_1 = k_2 = k_3 = k_4 = 0$ we put

$$\begin{aligned} \mathbf{n}_{0,0}(1, \mathbf{f}, 1)(\mathbf{z}; v) &= \mathfrak{g}_{k_2;c_2,c'_2}(\mathbf{z}; v) \\ &= \sum_c \mathbf{n}'(\mathbf{z}_{c;1}, \mathbf{f}(\mathbf{z}_{c;2}, v)) - (-1)^{\deg \mathbf{f} + \deg' \mathbf{z}_{c;1}} \sum_c \mathbf{f}(\mathbf{z}_{c;1}, \mathbf{n}(\mathbf{z}_{c;2}, v)) \\ &\quad - (-1)^{\deg \mathbf{f}} \mathbf{f}(\hat{d}\mathbf{z}, v). \end{aligned} \quad (10.29)$$

Note that all the signs in (10.27), (10.28) and (10.29) are by Koszul rule.

We can check A_∞ relation as follows. (Since the signs are by Koszul rule, the fact that the equality holds *with signs* is in fact automatic.) Let \hat{d} be a map from

$$\begin{aligned} &\bigoplus_{c'_2, c'_1, c, c'} B\mathcal{C}_{(2)}[1](c_2, c'_2) \\ &\quad \otimes \text{Hom}(B\mathcal{C}[1](c, c') \otimes \mathfrak{D}_1(c', c'_2, c_3; c_1, c_4), \mathfrak{D}_2(c, c_2, c_3; c'_1, c_4)) \\ &\quad \otimes B\mathcal{C}_{(1)}[1](c'_1, c_1) \end{aligned}$$

to itself which is the coderivation induced by the structure operations. We will prove:

$$(\mathbf{n} \circ \hat{d})(\mathbf{y}, \mathbf{f}, \mathbf{x})(\mathbf{z}; v) = 0. \quad (10.30)$$

Suppose $k_1 = k_2 = k_3 = k_4 = 0$ for simplicity. We have

$$\begin{aligned}
& (\mathbf{n}' \circ \hat{d})(\mathbf{f})(\mathbf{z}, v) \\
&= \sum_c (-1)^{\deg' \mathbf{z}_{c;1} (\deg \mathbf{f} + 1)} \mathbf{n}'(\mathbf{z}_{c;1}, \mathbf{n}(\mathbf{f})(\mathbf{z}_{c;2}, v)) \\
&\quad + \sum_c (-1)^{\deg' \mathbf{z}_{c;1} + \deg \mathbf{f}} \mathbf{n}(\mathbf{f})(\mathbf{z}_{c;1}, \mathbf{n}(\mathbf{z}_{c;2}, v)) \\
&\quad + (-1)^{\deg \mathbf{f}} \mathbf{n}(\mathbf{f})(\hat{d}\mathbf{z}, v) \\
&= \sum_c (-1)^{\deg' \mathbf{z}_{c;1} + \deg \mathbf{f} (\deg' \mathbf{z}_{c;1} + \deg' \mathbf{z}_{c;2})} \mathbf{n}'(\mathbf{z}_{c;1}, \mathbf{n}'(\mathbf{z}_{c;2}, \mathbf{f}(\mathbf{z}_{c;3}, v))) \\
&\quad + \sum_c (-1)^{\deg \mathbf{f} + 1 + \deg' \mathbf{z}_{c;2} + \deg' \mathbf{z}_{c;1} (\deg \mathbf{f} + 1)} \mathbf{n}'(\mathbf{z}_{c;1}, \mathbf{f}(\mathbf{z}_{c;2}, \mathbf{n}(\mathbf{z}_{c;3}, v))) \\
&\quad + \sum_c (-1)^{\deg' \mathbf{z}_{c;1} (\deg \mathbf{f} + 1) + (\deg \mathbf{f} + 1)} \mathbf{n}'(\mathbf{z}_{c;1}, \mathbf{f}(\hat{d}\mathbf{z}_{c;2}, v)) \\
&\quad + \sum_c (-1)^{\deg' \mathbf{z}_{c;1} + \deg' \mathbf{z}_{c;2} + \deg \mathbf{f} + \deg' \mathbf{z}_{c;1} \deg \mathbf{f}} \mathbf{n}'(\mathbf{z}_{c;1}, \mathbf{f}(\mathbf{z}_{c;2}, \mathbf{n}(\mathbf{z}_{c;3}, v))) \\
&\quad + \sum_c (-1)^{\deg' \mathbf{z}_{c;2} + 1} \mathbf{f}(\mathbf{z}_{c;1}, \mathbf{n}(\mathbf{z}_{c;2}, \mathbf{n}(\mathbf{z}_{c;3}, v))) \\
&\quad + \sum_c (-1)^{1 + \deg' \mathbf{z}_{c;1}} \mathbf{f}(\hat{d}\mathbf{z}_{c;1}, \mathbf{n}(\mathbf{z}_{c;2}, v)) \\
&\quad + \sum_c (-1)^{\deg \mathbf{f} + \deg \mathbf{f} \deg' \mathbf{z}_{c;1} + \deg' \mathbf{z}_{c;1}} \mathbf{n}'(\mathbf{z}_{c;1}, \mathbf{f}(\hat{d}\mathbf{z}_{c;2}, v)) \\
&\quad + \sum_c (-1)^{\deg \mathbf{f} + \deg \mathbf{f} (\deg' \mathbf{z}_{c;1} + 1)} \mathbf{n}'(\hat{d}\mathbf{z}_{c;1}, \mathbf{f}(\mathbf{z}_{c;2}, v)) \\
&\quad + \sum_c (-1)^1 \mathbf{f}(\mathbf{z}_{c;1}, \mathbf{n}(\hat{d}\mathbf{z}_{c;2}, v)) \\
&\quad + \sum_c (-1)^{1 + \deg' \mathbf{z}_{c;1} + 1} \mathbf{f}(\hat{d}\mathbf{z}_{c;1}, \mathbf{n}(\mathbf{z}_{c;2}, v)).
\end{aligned}$$

The 1st and 8th terms of the right hand side cancel by the A_∞ relation of \mathbf{n}' . The 2nd and 4th terms cancel. The 3rd and 7th terms cancel. The 5th and 9th terms cancel by the A_∞ relation of \mathbf{n} . The 6th and 10th terms cancel. Thus we checked (10.30) in the case $k_1 = k_2 = k_3 = k_4 = 0$. The other cases are similar. \square

Lemma-Definition 10.22. *There exists a filtered A_∞ bi-functor*

$$\text{MUMOD}(\mathcal{C}, \mathcal{C}_{(1)}; \mathcal{C}_{(2)}) \times \text{MUMOD}(\mathcal{C}, \mathcal{C}_{(3)}; \mathcal{C}_{(4)}) \rightarrow \text{MUMOD}(\mathcal{C}_{(2)}, \mathcal{C}_{(3)}; \mathcal{C}_{(1)}, \mathcal{C}_{(4)})$$

which is given by Lemma-Definition 10.21 for the object part.

We call this bi-functor the derived hom-functor and write its as $\mathfrak{H}\text{om}$. \diamond

Proof. Let \mathcal{C} and $\mathcal{C}_{(i)}$, $i = 1, 2, 3, 4$ be strict filtered A_∞ categories and $\mathfrak{D}_1, \mathfrak{D}'_1$ (resp. $\mathfrak{D}_2, \mathfrak{D}'_2$) be left- $\mathcal{C}, \mathcal{C}_{(1)}$ right- $\mathcal{C}_{(2)}$ (resp. left- $\mathcal{C}, \mathcal{C}_{(3)}$ right- $\mathcal{C}_{(4)}$) filtered A_∞ tri-module.

Suppose $\mathfrak{F}_1 : \mathfrak{D}'_1 \rightarrow \mathfrak{D}_1$ and $\mathfrak{F}_2 : \mathfrak{D}_2 \rightarrow \mathfrak{D}'_2$ are tri-module homomorphisms. We will define

$$(\mathfrak{F}_1^*, \mathfrak{F}_2^*) : \mathfrak{H}\text{om}_{\mathcal{C}_2}(\mathfrak{D}_1, \mathfrak{D}_2) \rightarrow \mathfrak{H}\text{om}_{\mathcal{C}_2}(\mathfrak{D}'_1, \mathfrak{D}'_2). \quad (10.31)$$

Let $\widehat{\mathbf{f}} = (\mathbf{f}^{c_1, c_2, c_3, c_4})_{c_i \in \mathfrak{D}\mathfrak{b}(\mathcal{C}_{(i)})}; \mathfrak{H}\mathfrak{om}_{\mathcal{C}}(\mathfrak{D}_1, \mathfrak{D}_2)$. Here $\mathbf{f}^{c_1, c_2, c_3, c_4} = (\mathbf{f}_{c, c'}^{c_1, c_2, c_3, c_4})_{c, c' \in \mathfrak{D}\mathfrak{b}(\mathcal{C})}$ and

$$\mathbf{f}_{c, c'}^{c_1, c_2, c_3, c_4} : B\mathcal{C}[1](c, c') \otimes \mathfrak{D}_1|_{c'}(c_2, c_3; c_1, c_4) \rightarrow \mathfrak{D}_2|_{c'}(c_2, c_3; c_1, c_4).$$

We define $\widehat{\mathbf{g}} = (\mathfrak{F}_1^*, \mathfrak{F}_{2*})(\widehat{\mathbf{f}})$ as follows. $\widehat{\mathbf{g}} = (\mathbf{g}^{c_1, c_2, c_3, c_4})_{c_i \in \mathfrak{D}\mathfrak{b}(\mathcal{C}_{(i)})}; \mathfrak{g}^{c_1, c_2, c_3, c_4} = (\mathbf{g}_{c, c'}^{c_1, c_2, c_3, c_4}; c, c' \in \mathfrak{D}\mathfrak{b}(\mathcal{C}))$, and $\mathbf{g}_{c, c'}^{c_1, c_2, c_3, c_4} : B\mathcal{C}(c, c') \otimes \mathfrak{D}'_1|_{c'}(c_1, c_2; c_3, c_4) \rightarrow \mathfrak{D}'_2|_c(c_1, c_2; c_3, c_4)$ is

$$\mathbf{g}_{c, c'}^{c_1, c_2, c_3, c_4}(\mathbf{z}, v) := \sum_c (-1)^{\deg \mathbf{f} \deg' \mathbf{z}_{c:1}} \mathfrak{F}_2(\mathbf{z}_{c:1}, \mathbf{f}(\mathbf{z}_{2:1}, \mathfrak{F}_1(\mathbf{z}_{c:3}, v))). \quad (10.32)$$

Here $v \in \mathfrak{D}'_1|_c(c_1, c_2; c_3, c_4)$, $\mathbf{z} \in B\mathcal{C}(c, c')$ and $((\Delta \otimes 1) \circ \Delta)(\mathbf{y}) = \sum_c \mathbf{z}_{c:1} \otimes \mathbf{z}_{c:2} \otimes \mathbf{z}_{c:3}$.

It is straightforward to check that $(\mathfrak{F}_1^*, \mathfrak{F}_{2*})$ is a chain map and multi-module homomorphism. More over if $\mathfrak{F}_1 \circ \mathfrak{G}_1 = \mathfrak{H}_1$, $\mathfrak{G}_2 \circ \mathfrak{F}_2 = \mathfrak{H}_2$ then

$$(\mathfrak{H}_1^*, \mathfrak{H}_{2*}) = (\mathfrak{G}_1^*, \mathfrak{G}_{2*}) \circ (\mathfrak{F}_1^*, \mathfrak{F}_{2*})$$

Thus we obtain a required bi-functor. (It is actually a DG-functor.) \square

The next proposition is a Hom version of Proposition 10.10.

Proposition 10.23. *Let \mathcal{C} , $\mathcal{C}_{(i)}$, $i = 1, 2, 3$ be strict unital and gapped filtered A_∞ categories, and $\mathcal{F} : \mathcal{C}_{(1)} \rightarrow \mathcal{C}$ and $\mathcal{G} : \mathcal{C} \times \mathcal{C}_{(2)} \rightarrow \mathcal{C}_{(3)}$ strict, unital and gapped filtered A_∞ (bi-) functors.*

We consider

$$\mathfrak{Y}\mathfrak{on} \circ \mathcal{F} : \mathcal{C}_{(1)} \rightarrow \mathcal{F}\mathcal{U}\mathcal{N}\mathcal{C}(\mathcal{C}^{\text{op}}, \mathcal{C}\mathcal{H})$$

and regard it as a bi-functor

$$\mathcal{C}^{\text{op}} \times \mathcal{C}_{(1)} \rightarrow \mathcal{C}\mathcal{H}.$$

It can be regarded as a left- \mathcal{C} , right- $\mathcal{C}_{(1)}$, bi-module, which we denote by $\mathfrak{D}_{(1)}$.

We apply (bi-module analogue of) the relative Yoneda functor to \mathcal{G} to obtain $\mathfrak{H}\mathfrak{Y}\mathfrak{on}_{\text{ob}}(\mathcal{G})$, which becomes a left- $\mathcal{C}, \mathcal{C}_{(2)}$ right $\mathcal{C}_{(3)}$ tri-module, which we denote by $\mathfrak{D}_{(2)}$.

We next consider the composition $\mathcal{G} \circ \mathcal{F} : \mathcal{C}_{(1)} \times \mathcal{C}_{(2)} \rightarrow \mathcal{C}_{(3)}$ and apply (the bi-module analogue of) the relative Yoneda functor. We obtain a left- $\mathcal{C}_{(1)}$, $\mathcal{C}_{(2)}$ right- $\mathcal{C}_{(3)}$ bi-module and denote it by $\mathfrak{D}_{(3)}$

Now we claim that $\mathfrak{D}_{(3)}$ is homotopy equivalent to $\mathfrak{H}\mathfrak{om}_{\mathcal{C}}(\mathfrak{D}_{(1)}, \mathfrak{D}_{(2)})$ as a left- $\mathcal{C}_{(1)}, \mathcal{C}_{(2)}$ right- $\mathcal{C}_{(3)}$ tri-module.

Here the left $\mathcal{C}_{(1)}$ module structure on $\mathfrak{H}\mathfrak{om}_{\mathcal{C}}(\mathfrak{D}_{(1)}, \mathfrak{D}_{(2)})$ is induced from the right $\mathcal{C}_{(1)}$ module structure on $\mathfrak{D}_{(1)}$. (We do not use left \mathcal{C} module structure on $\mathfrak{D}_{(2)}$ to define this left $\mathcal{C}_{(1)}$ module structure.) \diamond

We remark that by definition $\mathfrak{D}_{(3)}$ is induced from $\mathfrak{D}_{(2)}$ by \mathcal{F} . The proof will be given in Subsection 10.5.

Remark 10.24. We consider the case when \mathcal{C} and $\mathcal{C}_{(1)}$ are unital associative algebras, $\mathcal{C}_{(2)}$ is trivial, and \mathcal{F} is a unital ring homomorphism. We use the notation of Remark 10.11. Then $\mathfrak{D}_{(1)}$ is the bi-module ${}_{\mathcal{C}}\mathcal{C}_{\mathcal{C}_{(1)}}$ and $\mathfrak{D}_{(2)}$ is given by a left \mathcal{C} right $\mathcal{C}_{(3)}$ bimodule ${}_{\mathcal{C}}D_{\mathcal{C}_{(3)}}$.

Therefore $\mathfrak{H}\mathfrak{om}_{\mathcal{C}}(\mathfrak{D}_{(1)}, \mathfrak{D}_{(2)})$ is $\text{Hom}_{\mathcal{C}}({}_{\mathcal{C}}\mathcal{C}_{\mathcal{C}_{(1)}}, {}_{\mathcal{C}}D_{\mathcal{C}_{(3)}})$. The map sending φ to $\varphi(\mathbf{e})$ gives an isomorphism between $\text{Hom}_{\mathcal{C}}({}_{\mathcal{C}}\mathcal{C}_{\mathcal{C}_{(1)}}, {}_{\mathcal{C}}D_{\mathcal{C}_{(3)}})$ and ${}_{\mathcal{C}_{(1)}}D_{\mathcal{C}_{(3)}}$ as left $\mathcal{C}_{(1)}$ right $\mathcal{C}_{(3)}$ modules. Note that the left $\mathcal{C}_{(1)}$ action on ${}_{\mathcal{C}_{(1)}}D_{\mathcal{C}_{(3)}}$ is defined by $\mathcal{F} : \mathcal{C}_{(1)} \rightarrow \mathcal{C}$ and the left action of \mathcal{C} .

The bi-module $\mathcal{C}_{(1)}D_{\mathcal{C}_{(3)}}$ corresponds to the composition $\mathcal{G} \circ \mathcal{F}$. We thus checked Proposition 10.23 in this case. \diamond

10.4. Proof of Theorem 10.16.

Proof of Theorem 10.16. We first consider the composition:

$$\begin{aligned} & \mathfrak{F}\mathfrak{u}\mathfrak{k}\mathfrak{s}\mathfrak{t}(-X_1 \times X_2) \times \mathfrak{F}\mathfrak{u}\mathfrak{k}\mathfrak{s}\mathfrak{t}(-X_2 \times X_3) \\ & \rightarrow \mathcal{F}\mathcal{U}\mathcal{N}\mathcal{C}(\mathfrak{F}\mathfrak{u}\mathfrak{k}\mathfrak{s}\mathfrak{t}(X_1), \mathfrak{F}\mathfrak{u}\mathfrak{k}\mathfrak{s}\mathfrak{t}(X_2)) \times \mathcal{F}\mathcal{U}\mathcal{N}\mathcal{C}(\mathfrak{F}\mathfrak{u}\mathfrak{k}\mathfrak{s}\mathfrak{t}(X_2), \mathfrak{F}\mathfrak{u}\mathfrak{k}\mathfrak{s}\mathfrak{t}(X_3)) \\ & \rightarrow \mathcal{F}\mathcal{U}\mathcal{N}\mathcal{C}(\mathfrak{F}\mathfrak{u}\mathfrak{k}\mathfrak{s}\mathfrak{t}(X_1), \mathfrak{F}\mathfrak{u}\mathfrak{k}\mathfrak{s}\mathfrak{t}(X_3)) \end{aligned} \quad (10.33)$$

and compose it with the relative Yoneda functor. By the commutativity of Diagram (10.9) (Propositions 10.10) the composition (10.33) is homotopy equivalent to

$$\begin{aligned} & \mathfrak{F}\mathfrak{u}\mathfrak{k}\mathfrak{s}\mathfrak{t}(-X_1 \times X_2) \times \mathfrak{F}\mathfrak{u}\mathfrak{k}\mathfrak{s}\mathfrak{t}(-X_2 \times X_3) \\ & \rightarrow \mathcal{B}\mathcal{L}\mathcal{M}\mathcal{O}\mathcal{D}(\mathfrak{F}\mathfrak{u}\mathfrak{k}\mathfrak{s}\mathfrak{t}(X_1), \mathfrak{F}\mathfrak{u}\mathfrak{k}\mathfrak{s}\mathfrak{t}(X_2))^{\text{op}} \\ & \quad \times \mathcal{B}\mathcal{L}\mathcal{M}\mathcal{O}\mathcal{D}(\mathfrak{F}\mathfrak{u}\mathfrak{k}\mathfrak{s}\mathfrak{t}(X_2), \mathfrak{F}\mathfrak{u}\mathfrak{k}\mathfrak{s}\mathfrak{t}(X_3))^{\text{op}} \\ & \rightarrow \mathcal{B}\mathcal{L}\mathcal{M}\mathcal{O}\mathcal{D}(\mathfrak{F}\mathfrak{u}\mathfrak{k}\mathfrak{s}\mathfrak{t}(X_1), \mathfrak{F}\mathfrak{u}\mathfrak{k}\mathfrak{s}\mathfrak{t}(X_3))^{\text{op}}, \end{aligned} \quad (10.34)$$

where the first functor is the composition of the correspondence bi-functor and the relative Yoneda functor and the second functor is the derived tensor product. Let \mathcal{L}_{12} (resp. \mathcal{L}_{23}) be an object of $\mathfrak{F}\mathfrak{u}\mathfrak{k}\mathfrak{s}\mathfrak{t}(-X_1 \times X_2)$ (resp. $\mathfrak{F}\mathfrak{u}\mathfrak{k}\mathfrak{s}\mathfrak{t}(-X_2 \times X_3)$). By the definition of the correspondence bi-functor the first functor is as follows.

Let \mathcal{L}_i be an object of $\mathfrak{F}\mathfrak{u}\mathfrak{k}\mathfrak{s}\mathfrak{t}(X_i)$ for $i = 1, 2, 3$. Then \mathcal{L}_{12} (resp. \mathcal{L}_{23}) is sent to the left- $\mathfrak{F}\mathfrak{u}\mathfrak{k}\mathfrak{s}\mathfrak{t}(X_1)$ right- $\mathfrak{F}\mathfrak{u}\mathfrak{k}\mathfrak{s}\mathfrak{t}(X_2)$ bi-module $\mathcal{C}\mathcal{F}(\mathbb{L}_1, \mathbb{L}_{12}; \mathbb{L}_2)$ (resp. left- $\mathfrak{F}\mathfrak{u}\mathfrak{k}\mathfrak{s}\mathfrak{t}(X_2)$ right- $\mathfrak{F}\mathfrak{u}\mathfrak{k}\mathfrak{s}\mathfrak{t}(X_3)$ bi-module $\mathcal{C}\mathcal{F}(\mathbb{L}_2, \mathbb{L}_{23}; \mathbb{L}_3)$), which sends \mathcal{L}_1 and \mathcal{L}_2 (resp. \mathcal{L}_2 and \mathcal{L}_3) to $CF(\mathcal{L}_1, \mathcal{L}_{12}; \mathcal{L}_2)$ (resp. $CF(\mathcal{L}_2, \mathcal{L}_{23}; \mathcal{L}_3)$). This is the object part of the functor. The morphism part is determined by the left- $\mathfrak{F}\mathfrak{u}\mathfrak{k}\mathfrak{s}\mathfrak{t}(-X_1 \times X_2)$ module structure of $\mathcal{C}\mathcal{F}(\mathbb{L}_1, \mathbb{L}_{12}; \mathbb{L}_2)$ (resp. the left- $\mathfrak{F}\mathfrak{u}\mathfrak{k}\mathfrak{s}\mathfrak{t}(-X_2 \times X_3)$ module structure of $\mathcal{C}\mathcal{F}(\mathbb{L}_2, \mathbb{L}_{23}; \mathbb{L}_3)$).

Therefore by the definition of the derived tensor product, the composition (10.34) sends the pairs $(\mathcal{L}_1, \mathcal{L}_3)$, $(\mathcal{L}_{12}, \mathcal{L}_{23})$ to

$$\begin{aligned} D_1(\mathcal{L}_1, \mathcal{L}_{12}, \mathcal{L}_{23}; \mathcal{L}_3) &= \bigoplus_{\mathcal{L}_2, \mathcal{L}'_2} CF(\mathcal{L}_1, \mathcal{L}_{12}; \mathcal{L}_2) \otimes BCF[1](\mathcal{L}_2, \mathcal{L}'_2) \\ & \quad \otimes CF(\mathcal{L}'_2, \mathcal{L}_{23}; \mathcal{L}_3). \end{aligned} \quad (10.35)$$

We consider (10.35) for various $\mathcal{L}_1, \mathcal{L}_3, \mathcal{L}_{12}, \mathcal{L}_{23}$ and obtain the object part of the composition (10.34). The morphism part is determined by the left $\mathfrak{F}\mathfrak{u}\mathfrak{k}\mathfrak{s}\mathfrak{t}(-X_1 \times X_2)$, $\mathfrak{F}\mathfrak{u}\mathfrak{k}\mathfrak{s}\mathfrak{t}(-X_2 \times X_3)$, $\mathfrak{F}\mathfrak{u}\mathfrak{k}\mathfrak{s}\mathfrak{t}(X_1)$, right $\mathfrak{F}\mathfrak{u}\mathfrak{k}\mathfrak{s}\mathfrak{t}(X_3)$ quatro-module structure of (10.35).

We thus described the bi-functor (10.33) composed with the relative Yoneda functor.

We next study the composition:

$$\begin{aligned} & \mathfrak{F}\mathfrak{u}\mathfrak{k}\mathfrak{s}\mathfrak{t}(-X_1 \times X_2) \times \mathfrak{F}\mathfrak{u}\mathfrak{k}\mathfrak{s}\mathfrak{t}(-X_2 \times X_3) \\ & \rightarrow \mathfrak{F}\mathfrak{u}\mathfrak{k}\mathfrak{s}\mathfrak{t}(-X_1 \times X_3) \\ & \rightarrow \mathcal{F}\mathcal{U}\mathcal{N}\mathcal{C}(\mathfrak{F}\mathfrak{u}\mathfrak{k}\mathfrak{s}\mathfrak{t}(X_1), \mathfrak{F}\mathfrak{u}\mathfrak{k}\mathfrak{s}\mathfrak{t}(X_3)) \\ & \rightarrow \mathcal{B}\mathcal{L}\mathcal{M}\mathcal{O}\mathcal{D}(\mathfrak{F}\mathfrak{u}\mathfrak{k}\mathfrak{s}\mathfrak{t}(X_1); \mathfrak{F}\mathfrak{u}\mathfrak{k}\mathfrak{s}\mathfrak{t}(X_3))^{\text{op}}. \end{aligned} \quad (10.36)$$

By definition, the first functor composed with

$$\begin{aligned} \mathfrak{Y}\mathfrak{o}\mathfrak{n} : \mathfrak{F}\mathfrak{u}\mathfrak{k}\mathfrak{s}\mathfrak{t}(-X_1 \times X_3) & \rightarrow \mathcal{F}\mathcal{U}\mathcal{N}\mathcal{C}(\mathfrak{F}\mathfrak{u}\mathfrak{k}\mathfrak{s}\mathfrak{t}(-X_1 \times X_3)^{\text{op}}, \mathcal{C}\mathcal{H}) \\ & \cong \mathcal{B}\mathcal{L}\mathcal{M}\mathcal{O}\mathcal{D}(\mathfrak{F}\mathfrak{u}\mathfrak{k}\mathfrak{s}\mathfrak{t}(-X_1 \times X_3), *)^{\text{op}} \end{aligned}$$

is given by the left- $\mathfrak{F}\mathfrak{u}\mathfrak{k}\mathfrak{st}(-X_1 \times X_3)$ right- $\mathfrak{F}\mathfrak{u}\mathfrak{k}\mathfrak{st}(-X_1 \times X_2)$, $\mathfrak{F}\mathfrak{u}\mathfrak{k}\mathfrak{st}(-X_2 \times X_3)$ tri-module $\mathcal{C}\mathcal{F}(\mathbb{L}_{13}; \mathbb{L}_{12}, \mathbb{L}_{23})$. (See Proposition 8.11.)

We consider the composition of the second and third functors in (10.36) and apply (the object part of) the relative Yoneda functor $\mathfrak{Y}\mathfrak{o}\mathfrak{n}\mathfrak{R}_{\mathfrak{o}\mathfrak{b}}$. We then obtain a left- $\mathfrak{F}\mathfrak{u}\mathfrak{k}\mathfrak{st}(-X_1 \times X_3)$, $\mathfrak{F}\mathfrak{u}\mathfrak{k}\mathfrak{st}(X_1)$ right- $\mathfrak{F}\mathfrak{u}\mathfrak{k}\mathfrak{st}(X_3)$ tri-module $\mathcal{C}\mathcal{F}(\mathbb{L}_1, \mathbb{L}_{13}; \mathbb{L}_3)$. (See Lemma-Definition 10.3.) Here left $\mathfrak{F}\mathfrak{u}\mathfrak{k}\mathfrak{st}(-X_1 \times X_2)$, $\mathfrak{F}\mathfrak{u}\mathfrak{k}\mathfrak{st}(-X_2 \times X_3)$ module structure on $\mathcal{C}\mathcal{F}(\mathbb{L}_1, \mathbb{L}_{13}; \mathbb{L}_3)$ is induced by its left $\mathfrak{F}\mathfrak{u}\mathfrak{k}\mathfrak{st}(-X_1 \times X_3)$ module structure via the bi-functor $\mathfrak{F}\mathfrak{u}\mathfrak{k}\mathfrak{st}(-X_1 \times X_2) \times \mathfrak{F}\mathfrak{u}\mathfrak{k}\mathfrak{st}(-X_2 \times X_3) \rightarrow \mathfrak{F}\mathfrak{u}\mathfrak{k}\mathfrak{st}(-X_1 \times X_3)$.

We next use Proposition 10.23. We put

$$\begin{aligned}\mathcal{C}_{(1)} &= \mathfrak{F}\mathfrak{u}\mathfrak{k}\mathfrak{st}(-X_1 \times X_2) \times \mathfrak{F}\mathfrak{u}\mathfrak{k}\mathfrak{st}(-X_2 \times X_3) \\ \mathcal{C}_{(2)} &= \mathfrak{F}\mathfrak{u}\mathfrak{k}\mathfrak{st}(X_1) \\ \mathcal{C}_{(3)} &= \mathfrak{F}\mathfrak{u}\mathfrak{k}\mathfrak{st}(X_3) \\ \mathcal{C} &= \mathfrak{F}\mathfrak{u}\mathfrak{k}\mathfrak{st}(-X_1 \times X_3).\end{aligned}$$

Then

$$\begin{aligned}\mathfrak{D}_{(1)} &= \mathcal{C}\mathcal{F}(\mathbb{L}_{13}; \mathbb{L}_{12}, \mathbb{L}_{23}) \\ \mathfrak{D}_{(2)} &= \mathcal{C}\mathcal{F}(\mathbb{L}_1, \mathbb{L}_{13}; \mathbb{L}_3).\end{aligned}$$

$\mathfrak{D}_{(3)}$ is the pull-back of $\mathfrak{D}_{(2)}$ by $\mathbf{comp} : \mathfrak{F}\mathfrak{u}\mathfrak{k}\mathfrak{st}(-X_1 \times X_2) \times \mathfrak{F}\mathfrak{u}\mathfrak{k}\mathfrak{st}(-X_2 \times X_3) \rightarrow \mathfrak{F}\mathfrak{u}\mathfrak{k}\mathfrak{st}(-X_1 \times X_3)$

Proposition 10.23 then implies that $\mathfrak{D}_{(3)}$ is homotopy equivalent to

$$\mathfrak{H}\mathfrak{o}\mathfrak{m}_{\mathfrak{F}\mathfrak{u}\mathfrak{k}\mathfrak{st}(-X_1 \times X_3)}(\mathcal{C}\mathcal{F}(\mathbb{L}_{13}; \mathbb{L}_{12}, \mathbb{L}_{23}), \mathcal{C}\mathcal{F}(\mathbb{L}_1, \mathbb{L}_{13}; \mathbb{L}_3)) \quad (10.37)$$

as left- $\mathfrak{F}\mathfrak{u}\mathfrak{k}\mathfrak{st}(-X_1 \times X_2)$, $\mathfrak{F}\mathfrak{u}\mathfrak{k}\mathfrak{st}(-X_2 \times X_3)$, $\mathfrak{F}\mathfrak{u}\mathfrak{k}\mathfrak{st}(X_1)$ and right- $\mathfrak{F}\mathfrak{u}\mathfrak{k}\mathfrak{st}(X_2)$ quatromodule.⁴⁴ Note that the quatromodule (10.37) associates

$$\begin{aligned}D_2(\mathcal{L}_1, \mathcal{L}_{12}, \mathcal{L}_{23}; \mathcal{L}_3) \\ = \prod_{\mathcal{L}'_{13}, \mathcal{L}'_{13}} \mathit{Hom}(BCF[1](\mathcal{L}_{13}, \mathcal{L}'_{13}) \\ \otimes CF(\mathcal{L}'_{13}; \mathcal{L}_{12}, \mathcal{L}_{23}), CF(\mathcal{L}_1, \mathcal{L}_{13}; \mathcal{L}_3)).\end{aligned} \quad (10.38)$$

to $\mathcal{L}_{12}, \mathcal{L}_{23}, \mathcal{L}_1, \mathcal{L}_3$

We thus described two compositions:

$$\mathfrak{F}\mathfrak{u}\mathfrak{k}\mathfrak{st}(-X_1 \times X_2) \times \mathfrak{F}\mathfrak{u}\mathfrak{k}\mathfrak{st}(-X_2 \times X_3) \rightarrow \mathit{BLMOD}(\mathfrak{F}\mathfrak{u}\mathfrak{k}\mathfrak{st}(X_1), \mathfrak{F}\mathfrak{u}\mathfrak{k}\mathfrak{st}(X_3))^{\mathfrak{op}},$$

which are (10.35) and (10.38) together with their quatromodule structures. Theorem 10.16 claims that they are homotopy equivalent as quatromodules. To prove it we will construct a quatromodule homomorphism from (10.35) to (10.38).

By definition such a quatromodule homomorphism is a map

$$\begin{aligned}\bigoplus_{\mathcal{L}'_1, \mathcal{L}'_3, \mathcal{L}'_{12}, \mathcal{L}'_{23}} BCF[1](\mathcal{L}_1, \mathcal{L}'_1) \otimes BCF[1](\mathcal{L}_{12}, \mathcal{L}'_{12}) \otimes BCF[1](\mathcal{L}_{23}, \mathcal{L}'_{23}) \\ \otimes D_1(\mathcal{L}'_1, \mathcal{L}'_{12}, \mathcal{L}'_{23}; \mathcal{L}'_3) \otimes BCF[1](\mathcal{L}'_3, \mathcal{L}_3) \rightarrow D_2(\mathcal{L}_1, \mathcal{L}_{12}, \mathcal{L}_{23}; \mathcal{L}_3).\end{aligned}$$

⁴⁴Actually we use the variant of Proposition 10.23 where $\mathcal{F} : \mathcal{C}_{(1)} \rightarrow \mathcal{C}$ is replaced by a bi-functor. The proof of the variant is the same as the proof of Proposition 10.23.

Therefore it can be regarded as a homomorphism from

$$\begin{aligned} & BCF[1](\mathcal{L}_1, \mathcal{L}'_1) \otimes BCF[1](\mathcal{L}_{12}, \mathcal{L}'_{12}) \otimes BCF[1](\mathcal{L}_{23}, \mathcal{L}'_{23}) \\ & \otimes CF(\mathcal{L}'_1, \mathcal{L}'_{12}; \mathcal{L}_2) \otimes BCF[1](\mathcal{L}_2, \mathcal{L}'_2) \otimes CF(\mathcal{L}'_2, \mathcal{L}'_{23}; \mathcal{L}'_3) \otimes BCF[1](\mathcal{L}'_3, \mathcal{L}_3) \\ & \otimes BCF[1](\mathcal{L}_{13}, \mathcal{L}'_{13}) \otimes CF(\mathcal{L}'_{13}; \mathcal{L}_{12}, \mathcal{L}_{23}) \end{aligned}$$

to $CF(\mathcal{L}_1, \mathcal{L}_{13}; \mathcal{L}_3)$. The Y -diagram transformation $\mathscr{Y} \mathscr{T}^{\bar{b}}$ in (10.10) is such a homomorphism and therefore defines a pre-quatromodule homomorphism. The condition that it becomes a quatromodule homomorphism is exactly the formula (9.31), which we proved in Lemma 10.13.

To prove that this quatromodule homomorphism is a homotopy equivalence it suffices to show that the chain maps, which are parts of this quatromodule homomorphism, are chain homotopy equivalences. (Proposition 7.9.) The chain map induced by $\mathscr{Y} \mathscr{T}^{\bar{b}}$ is nothing but the chain homotopy equivalence (10.18) which we produced during the proof of Theorem 9.1 in Subsection 10.2.

We can study the difference between two bounding cochains $b_3^{(1)}$ and $b_3^{(2)}$ in the same way as the last step of the proof of Theorem 9.1 by enhancing Diagram (10.20) so that it includes left- $\mathfrak{F}\mathfrak{u}\mathfrak{t}\mathfrak{st}(-X_1 \times X_2)$, $\mathfrak{F}\mathfrak{u}\mathfrak{t}\mathfrak{st}(-X_2 \times X_3)$ structure.

The proof of Theorem 10.16 is now complete. \square

Remark 10.25. To prove the commutativity of the diagram in Theorem 10.16 for the object part, it suffices to show that $D_1 = CF(\mathcal{L}_1; \mathcal{L}_{12}; \mathcal{L}_2) \otimes BCF[1](\mathcal{L}_2) \otimes CF(\mathcal{L}_2; \mathcal{L}_{23}; \mathcal{L}_3)$ is homotopy equivalent to $D'_2 := CF(\mathcal{L}_1, \mathcal{L}_{13}; \mathcal{L}_3)$ as left- $\mathfrak{F}\mathfrak{u}\mathfrak{t}\mathfrak{st}(X_1)$ right- $\mathfrak{F}\mathfrak{u}\mathfrak{t}\mathfrak{st}(X_3)$ bi-modules.

To prove the commutativity of the morphism part we need to include the compatibility of the homotopy equivalence with the left $\mathfrak{F}\mathfrak{u}\mathfrak{t}\mathfrak{st}(-X_1 \times X_2) \times \mathfrak{F}\mathfrak{u}\mathfrak{t}\mathfrak{st}(-X_2 \times X_3)$ bi-module structures, as we have done above.

10.5. Proof of Propositions 10.10 and 10.23. In this subsection we prove Propositions 10.10 and 10.23. We need certain calculations of the sign for the proof. Note that in this paper the sign is almost always by the Koszul rule and by this reason the cancellation with the sign is mostly automatic. A certain nontrivial sign issue appears in this subsection by the following reason. We need to regard a filtered A_∞ category \mathcal{C} itself as a left- \mathcal{C} right- \mathcal{C} bi-module. In such a case an element v of $\mathcal{C}(c, c')$ as an element of bi-module appears with sign $(-1)^{\deg v}$ in the A_∞ formula. In the case v is regarded as an element of a morphism complex of an A_∞ category, it appears with sign $(-1)^{\deg v+1}$ in the A_∞ formula.

By several maps, which we will define in this subsection, an element of $\mathcal{C}(c, c')$ as an element of a bi-module in the domain becomes an element of the morphism complex in the co-domain or vice versa. This process shifts the degree. It is not obvious to understand the way how this process affects the sign, since the Koszul rule does not tell it to us. By this reason, we need to add a certain correction term to the usual Koszul sign. The author is unable to provide the general principle on the way how the correction terms are determined. Instead he puts the correction terms ‘by hand’ (See for example (10.55).) and check that the sign works by a calculation.⁴⁵

⁴⁵Actually a similar problem occurs during the proof of Yoneda’s lemma.

Fortunately this happens only in the purely algebraic situation so that we do *not* need to understand the geometric origin of the correction terms. In fact Propositions 10.10 and 10.23 are algebraic statements and hold independent of the origin of A_∞ categories and functors in their statements. For the construction of various operations using moduli spaces, the fundamental formulas among those operations are always with Koszul sign. We will use this fact in Section 17.

Proof of Proposition 10.10. Let $\mathcal{F}_{i(i+1)} : \mathcal{C}_i \rightarrow \mathcal{C}_{i+1}$ be a filtered A_∞ functor, for $i = 1, 2$. Let $c_1 \in \mathfrak{OB}(\mathcal{C}_1)$, $c_3 \in \mathfrak{OB}(\mathcal{C}_3)$. We put

$$\begin{aligned} D^1(c_1, c_3) &:= \mathcal{C}_3((\mathcal{F}_{23})_{ob}((\mathcal{F}_{12})_{ob}(c_1)), c_3), \\ D^2(c_1, c_3) &:= \bigoplus_{c_2, c'_2} \mathcal{C}_2((\mathcal{F}_{12})_{ob}(c_1), c_2) \widehat{\otimes} B\mathcal{C}_2(c_2, c'_2) \widehat{\otimes} \mathcal{C}_3((\mathcal{F}_{23})_{ob}(c'_2), c_3). \end{aligned} \quad (10.39)$$

Note that D^1 is the object part of the bi-module $\mathfrak{M}\mathfrak{O}\mathfrak{n}_{ob}(\mathfrak{F}_{23} \circ \mathfrak{F}_{12})$ and D^2 is the object part of the bi-module $\mathfrak{t}\mathfrak{e}\mathfrak{n}_{ob}(\mathfrak{M}\mathfrak{O}\mathfrak{n}_{ob}(\mathfrak{F}_{12}), \mathfrak{M}\mathfrak{O}\mathfrak{n}_{ob}(\mathfrak{F}_{23}))$.

We define $\mathcal{I}_{12;0,0} : D^1(c_1, c_3) \rightarrow D^2(c_1, c_3)$ by

$$\mathcal{I}_{12;0,0}(z) = \mathbf{e}_{(\mathcal{F}_{12})_{ob}(c_1)} \otimes 1 \otimes z. \quad (10.40)$$

Here the symbol $\mathbf{e}_{(\mathcal{F}_{12})_{ob}(c_1)}$ is the unity of the object $(\mathcal{F}_{12})_{ob}(c_1)$ and the symbol 1 is an element of $B_0\mathcal{C}_2((\mathcal{F}_{12})_{ob}(c_1), (\mathcal{F}_{12})_{ob}(c_1))$, which is isomorphic to Λ_0 . Hereafter we omit 1 from the notation. It is obvious that $\mathcal{I}_{12;0,0}$ is a chain map.

We also define $\mathcal{I}_{21} : D^2(c_1, c_3) \rightarrow D^1(c_1, c_3)$ by

$$\mathcal{I}_{21}(x, \mathbf{y}, z) = (-1)^{\deg x} \mathbf{m}_*(\widehat{\mathfrak{F}}_{23}(x, \mathbf{y}), z). \quad (10.41)$$

Here \mathbf{m} is the structure operation of \mathcal{C}_3 .

Let \mathbf{n} is the $(0, 0)$ part of the left- \mathcal{C}_1 right- \mathcal{C}_3 bi-module structure of $D^2(c_1, c_3)$. Here we use the sign convention so that degree of elements of bi-module is *not* shifted. Namely

$$\begin{aligned} \mathbf{n}(x \otimes \mathbf{y} \otimes z) &= \sum_c (-1)^{\deg' \mathbf{y}_{1;c}} \mathbf{m}(x, \mathbf{y}_{1;c}) \otimes \mathbf{y}_{2;c} \otimes z \\ &\quad + \sum_c (-1)^{\deg x + \deg' \mathbf{y}_{1;c}} x \otimes \mathbf{y}_{1;c} \otimes \mathbf{m}(\widehat{\mathfrak{F}}_{23}(\mathbf{y}_{2;c}), z) \\ &\quad + (-1)^{\deg x} x \otimes \hat{d}(\mathbf{y}) \otimes z. \end{aligned} \quad (10.42)$$

This is a special case of (10.7). We will check that $\mathcal{I}_{21;0,0}$ is a chain map. We calculate

$$\begin{aligned} &(\mathcal{I}_{21} \circ \mathbf{n})(x, \mathbf{y}, z) \\ &= \sum_c (-1)^{\deg' \mathbf{y}_{c;1}} \mathcal{I}_{21}(\mathbf{m}(x, \mathbf{y}_{c;1}), \mathbf{y}_{c;2}, z) \\ &\quad + (-1)^{\deg x} \mathcal{I}_{21}(x, \hat{d}\mathbf{y}, z) + \sum_c (-1)^{\deg x + \deg' \mathbf{y}_{c;1}} \mathcal{I}_{21}(x, \mathbf{y}_{c;1}, \mathbf{m}(\widehat{\mathfrak{F}}_{23}(\mathbf{y}_{c;2}), z)) \\ &= \sum_c (-1)^{\deg x + 1} \mathbf{m}(\widehat{\mathfrak{F}}_{23}(\mathbf{m}(x, \mathbf{y}_{c;1}), \mathbf{y}_{c;2}), z) \\ &\quad + \mathbf{m}(\widehat{\mathfrak{F}}_{23}(x, \hat{d}\mathbf{y}), z) + (-1)^{\deg' \mathbf{y}_{c;1}} \sum_c \mathbf{m}(\widehat{\mathfrak{F}}_{23}(x, \mathbf{y}_{c;1}), \mathbf{m}(\widehat{\mathfrak{F}}_{23}(\mathbf{y}_{c;2}), z)). \end{aligned}$$

By A_∞ relation this coincides with

$$(\mathbf{n} \circ \mathcal{I}_{21})(x, \mathbf{y}, z) = (-1)^{\deg x} \mathbf{m}(\widehat{\mathfrak{F}}_{23}(x, \mathbf{y}), z).$$

Lemma 10.26. $\mathcal{I}_{12;0,0}$ becomes a $(0,0)$ part of a filtered bi-module homomorphism. \diamond

Proof. We first define

$$\mathcal{I}_{12;k_1,k_3} : B_{k_1}\mathcal{C}_1[1](c_1, c'_1) \widehat{\otimes} D^1(c'_1, c'_3) \widehat{\otimes} B_{k_3}\mathcal{C}_3[1](c'_3, c_3) \rightarrow D^2(c_1, c_3)$$

as follows. If $k_3 \neq 0$ then $\mathcal{I}_{12;k_1,k_3} = 0$. If $k_3 = 0$ we put:

$$\mathcal{I}_{12;k_1,0}(\mathbf{x}, z) = \mathbf{e}_{(\mathcal{F}_{12})_{ob}(c_1)} \otimes \widehat{\mathcal{F}}_{12}(\mathbf{x}) \otimes z.$$

We will prove that they define an A_∞ bi-module homomorphism. Let

$$\begin{aligned} \widehat{\mathcal{I}}_{12} : \bigoplus_{c'_1, c'_3} B\mathcal{C}_1[1](c_1, c'_1) \widehat{\otimes} D^1(c'_1, c_3) \widehat{\otimes} B\mathcal{C}_3[1](c'_3, c_3) \\ \rightarrow \bigoplus_{c'_1, c'_3} B\mathcal{C}_1[1](c_1, c'_1) \widehat{\otimes} D^2(c'_1, c_3) \widehat{\otimes} B\mathcal{C}_3[1](c'_3, c_3) \end{aligned}$$

be the formal bi-comodule homomorphism induced by $\mathcal{I}_{12;k_1,0}$ ($k_1 = 0, 1, 2, \dots$). Let \hat{d} be the boundary operator on $\bigoplus_{c'_1, c'_3} B\mathcal{C}_1[1](c_1, c'_1) \widehat{\otimes} D^i(c'_1, c'_3) \widehat{\otimes} B\mathcal{C}_3[1](c'_3, c_3)$ induced by the bi-module structure and

$$\mathbf{n} : B\mathcal{C}_1[1](c_1, c'_1) \widehat{\otimes} D^i(c'_1, c'_3) \widehat{\otimes} B\mathcal{C}_3[1](c'_3, c_3) \rightarrow D^i(c'_1, c_3)$$

which is the structure operation of the bi-module structure as in (10.7). Let $\mathbf{x} \in B\mathcal{C}_1[1](c_1, c'_1)$, $z \in \mathcal{D}^1(c'_1, c'_3)$, $\mathbf{w} \in B_{k_3}\mathcal{C}_3[1](c'_3, c_3)$. We calculate

$$\begin{aligned} (\mathbf{n} \circ \widehat{\mathcal{I}}_{12})(\mathbf{x}, z, \mathbf{w}) &= \sum_c \mathbf{n} \left(\widehat{\mathcal{F}}_{12}(\mathbf{x}_{c;1}) \otimes (\mathbf{e} \otimes \widehat{\mathcal{F}}_{12}(\mathbf{x}_{c;2}) \otimes z) \otimes \mathbf{w} \right) \\ &= \begin{cases} \sum_c (-1)^{\deg' \mathbf{x}_{c;1}} \mathbf{e} \otimes \widehat{\mathcal{F}}_{12}(\mathbf{x}_{c;1}) \otimes \mathbf{m}((\widehat{\mathcal{F}}_{23} \circ \widehat{\mathcal{F}}_{12})(\mathbf{x}_{c;2}), z, \mathbf{w}) & \text{if } k_3 \neq 0 \\ \sum_c (-1)^{\deg' \mathbf{x}_{c;1}} \mathbf{e} \otimes \widehat{\mathcal{F}}_{12}(\mathbf{x}_{c;1}) \otimes \mathbf{m}((\widehat{\mathcal{F}}_{23} \circ \widehat{\mathcal{F}}_{12})(\mathbf{x}_{c;2}), z) \\ \quad + \mathbf{e} \otimes \hat{d}(\widehat{\mathcal{F}}_{12}(\mathbf{x})) \otimes z & \text{if } k_3 = 0. \end{cases} \end{aligned}$$

Note that in the case when $k_3 \neq 0$ the formula (10.7) implies that the summand in the second line vanishes unless $\mathbf{x}_{c;1} = 1$. In the case when $k_3 \neq 0$ and $\mathbf{x}_{c;1} = 1$, it becomes the sum in the third line.

In the case when $k_3 = 0$ after a certain cancellation, there remains another term, that is, the fifth line.

Remark 10.27. Note that $\deg' \mathbf{e} = -1$. However as we remarked in Remark 10.7 here the sign $\deg \mathbf{e} = 0$ is used. \diamond

On the other hand,

$$\begin{aligned} &\hat{d}(\mathbf{x} \otimes z \otimes \mathbf{w}) \\ &= \hat{d}(\mathbf{x}) \otimes z \otimes \mathbf{w} + (-1)^{\deg' \mathbf{x} + \deg z} \mathbf{x} \otimes z \otimes \hat{d}(\mathbf{w}) \\ &\quad + \sum_{c_1, c_2} (-1)^{\deg' \mathbf{x}_{c_1;1}} \mathbf{x}_{c_1;1} \otimes \mathbf{m}((\widehat{\mathcal{F}}_{23} \circ \widehat{\mathcal{F}}_{12})(\mathbf{x}_{c_1;2}), z, \mathbf{w}_{c_2;1}) \otimes \mathbf{w}_{c_2;2} \end{aligned} \tag{10.43}$$

Therefore if $k_3 \neq 0$ we have

$$\begin{aligned} &(\mathcal{I}_{12} \circ \hat{d})(\mathbf{x}, z, \mathbf{w}) \\ &= \sum_c (-1)^{\deg' \mathbf{x}_{c;1}} \mathbf{e} \otimes \widehat{\mathcal{F}}_{12}(\mathbf{x}_{c;1}) \otimes \mathbf{m}((\widehat{\mathcal{F}}_{23} \circ \widehat{\mathcal{F}}_{12})(\mathbf{x}_{c;2}), z, \mathbf{w}). \end{aligned} \tag{10.44}$$

If $k_3 = 0$ we have

$$\begin{aligned}
& (\mathcal{I}_{12} \circ \hat{d})(\mathbf{x}, z) \\
&= \sum_c (-1)^{\deg' \mathbf{x}_{c_1+1}} \mathbf{e} \otimes \widehat{\mathcal{F}}_{12}(\mathbf{x}_{c;1}) \otimes \mathbf{m}((\widehat{\mathcal{F}}_{23} \circ \widehat{\mathcal{F}}_{12})(\mathbf{x}_{c;2}), z) \\
&\quad + \mathbf{e} \otimes \hat{d}(\mathcal{F}_{12}(\mathbf{x})) \otimes z.
\end{aligned} \tag{10.45}$$

Therefore \mathcal{I}_{12} is a filtered A_∞ bi-module homomorphism. \square

Lemma 10.28.

- (1) The composition $\mathcal{I}_{21} \circ \mathcal{I}_{12,00}$ is equal to the identity.
- (2) The composition $\mathcal{I}_{12,00} \circ \mathcal{I}_{21}$ is chain homotopic to the identity.

\diamond

Proof. (1) follows by an easy and straightforward calculation. We will prove (2). Let $x \in \mathcal{C}_2((\mathcal{F}_{12})_{ob}(c_1), c_2)$, $\mathbf{y} \in B\mathcal{C}_2[1](c_2, c'_2)$, $z \in \mathcal{C}_3((\mathcal{F}_{23})_{ob}(c'_2), c_3)$. We observe

$$(\mathcal{I}_{12,00} \circ \mathcal{I}_{21})(x, \mathbf{y}, z) = (-1)^{\deg x} \mathbf{e} \otimes \mathbf{m}_*(\widehat{\mathfrak{F}}_{23}(x, \mathbf{y}), z). \tag{10.46}$$

We define

$$\mathfrak{H}(x, \mathbf{y}, z) := (-1)^{\deg' x} \mathbf{e} \otimes (x \otimes \mathbf{y}) \otimes z. \tag{10.47}$$

Let \mathbf{n} be as in (10.42). We calculate

$$\begin{aligned}
& (\mathbf{n} \circ \mathfrak{H})(x, \mathbf{y}, z) \\
&= (-1)^{\deg' x} \mathbf{n}(\mathbf{e} \otimes (x \otimes \mathbf{y}) \otimes z) \\
&= x \otimes \mathbf{y} \otimes z + (-1)^{\deg' x} \sum_c \mathbf{e} \otimes (\mathbf{m}(x \otimes \mathbf{y}_{c;1}) \otimes \mathbf{y}_{c;2}) \otimes z \\
&\quad + \mathbf{e} \otimes (x \otimes \hat{d}\mathbf{y}) \otimes z \\
&\quad + \sum_c (-1)^{\deg' \mathbf{y}_{c;1}} \mathbf{e} \otimes (x \otimes \mathbf{y}_{c;1}) \otimes \mathbf{m}(\widehat{\mathfrak{F}}_{23}(\mathbf{y}_{c;2}), z) \\
&\quad - (-1)^{\deg x} \mathbf{e} \otimes \mathbf{m}(\widehat{\mathfrak{F}}_{23}(x, \mathbf{y}), z).
\end{aligned} \tag{10.48}$$

On the other hand

$$\begin{aligned}
& (\mathfrak{H} \circ \mathbf{n})(x, \mathbf{y}, z) = \sum_c (-1)^{\deg' \mathbf{y}_{c;1}} \mathfrak{H}(\mathbf{m}(x, \mathbf{y}_{c;1}) \otimes \mathbf{y}_{c;2} \otimes z) \\
&\quad + (-1)^{\deg x} \mathfrak{H}(x, \hat{d}\mathbf{y}, z) \\
&\quad + \sum_c (-1)^{\deg x + \deg' \mathbf{y}_{c;1}} \mathfrak{H}(x, \mathbf{y}_{c;1}, \mathbf{m}(\mathbf{y}_{c;2}, z)) \\
&= \sum_c (-1)^{\deg' x+1} \mathbf{e} \otimes (\mathbf{m}(x \otimes \mathbf{y}_{c;1}) \otimes \mathbf{y}_{c;2}) \otimes z \\
&\quad - \mathbf{e} \otimes (x \otimes \hat{d}(\mathbf{y})) \otimes z \\
&\quad + \sum_c (-1)^{\deg' \mathbf{y}_{c;1}+1} \mathbf{e} \otimes (x \otimes \mathbf{y}_{c;1}) \otimes \mathbf{m}(\widehat{\mathfrak{F}}_{23}(\mathbf{y}_{c;2}), z).
\end{aligned} \tag{10.49}$$

Therefore

$$(\mathbf{n} \circ \mathfrak{H} + \mathfrak{H} \circ \mathbf{n})(x, \mathbf{y}, z) = x \otimes \mathbf{y} \otimes z - (-1)^{\deg x} \mathbf{e} \otimes \mathbf{m}(\widehat{\mathfrak{F}}_{23}(x, \mathbf{y}), z),$$

as required. \square

Lemmas 10.26 and 10.28 together with Proposition 7.9 imply that \mathcal{S}_{12} is a homotopy equivalence. Proposition 10.10 follows. \square

Proof of Proposition 10.23. We use the notation of Proposition 10.23.

Let $c_i \in \mathfrak{D}\mathfrak{B}(\mathcal{C}_i)$, $c, c' \in \mathfrak{D}\mathfrak{B}(\mathcal{C})$. By definition we have:

$$\begin{aligned}\mathfrak{D}_{(1)}(c; c_1) &= \mathcal{C}(c, (\mathcal{F})_{ob}(c_1)), \\ \mathfrak{D}_{(2)}(c, c_2; c_3) &= \mathcal{C}_{(3)}((\mathcal{G})_{ob}(c, c_2); c_3), \\ \mathfrak{D}_{(3)}(c_1, c_2; c_3) &= \mathcal{C}_{(3)}((\mathcal{G}_{ob}(\mathcal{F}_{ob}(c_1), c_2); c_3)).\end{aligned}$$

We put

$$\begin{aligned}D^1(c_1, c_2; c_3) &= \mathfrak{D}_{(3)}(c_1, c_2; c_3) = \mathcal{C}_{(3)}((\mathcal{G}_{ob}(\mathcal{F}_{ob}(c_1), c_2); c_3), \\ D^2(c_1, c_2; c_3) & \\ &= \prod_{c, c', k} Hom(B_k \mathcal{C}[1](c, c') \widehat{\otimes} \mathfrak{D}_{(1)}(c'; c_1), \mathfrak{D}_{(2)}(c, c_2; c_3)).\end{aligned}\tag{10.50}$$

Note that D^1 is the object part of the tri-module associated to $\mathcal{G} \circ \mathcal{F}$ and D^2 is the object part of the tri-module $(\mathfrak{H}om)_{\mathcal{C}}(\mathfrak{D}_{(1)}, \mathfrak{D}_{(2)})$.

Note that the left module structure \mathbf{n} of $\mathfrak{D}_{(1)}$ coincides with the A_∞ operation \mathbf{m} of \mathcal{C} . We define

$$\mathcal{S}_{12;0,0,0} : D^1(c_1, c_2; c_3) \rightarrow D^2(c_1, c_2; c_3), \quad \mathcal{S}_{21} : D^2(c_1, c_2; c_3) \rightarrow D^1(c_1, c_2; c_3)$$

as follows. Let $u \in D^1(c_1, c_2; c_3)$, $\mathbf{z} \in B\mathcal{C}(c, c')$, $v \in \mathfrak{D}_{(1)}(c'; c_1)$. We put

$$\mathcal{S}_{12;0,0,0}(u)(\mathbf{z}; v) = (-1)^{(\deg u + 1)(\deg v + \deg' \mathbf{z})} \mathbf{n}(\mathbf{z} \otimes v; u)\tag{10.51}$$

Here \mathbf{n} is the left \mathcal{C} module structure on $\mathfrak{D}_{(2)}$. Note that the sign is different from Koszul sign and contains the correction term $\deg v + \deg' \mathbf{z}$. We will check that $\mathcal{S}_{12;0,0,0}$ is a chain map. We have

$$\mathcal{S}_{12;0,0,0}(\mathbf{n}(u))(\mathbf{z}; v) = (-1)^{*1} \mathbf{n}(\mathbf{z}; v; \mathbf{n}(u)).\tag{10.52}$$

where

$$*1 = (\deg u + 1 + 1)(\deg v + \deg' \mathbf{z}) = \deg u(\deg' \mathbf{z} + \deg v).$$

On the other hand,

$$\begin{aligned}& \mathbf{n}(\mathcal{S}_{12;0,0,0}(u))(\mathbf{z}; v) \\ &= \sum_c (-1)^{\deg u \deg' \mathbf{z}_{c;1}} \mathbf{n}(\mathbf{z}_{c;1}; \mathcal{S}_{12;0,0,0}(u)(\mathbf{z}_{c;2}; v)) \\ & \quad + \sum_c (-1)^{\deg u + \deg' \mathbf{z}_{c;1} + 1} \mathcal{S}_{12;0,0,0}(u)(\mathbf{z}_{c;1}, \mathbf{n}(\mathbf{z}_{c;2}, v)) \\ & \quad + (-1)^{\deg u + 1} \mathcal{S}_{12;0,0,0}(u)(\hat{d}\mathbf{z}, v) \\ &= \sum_c (-1)^{*2} \sum_c \mathbf{n}(\mathbf{z}_{c;1}, \mathbf{n}(\mathbf{z}_{c;2} \otimes v; u)) \\ & \quad + \sum_c (-1)^{*3} \mathbf{n}(\mathbf{z}_{c;1} \otimes \mathbf{m}(\mathbf{z}_{c;2}; v); u) \\ & \quad + (-1)^{*4} \mathbf{n}(\hat{d}\mathbf{z} \otimes v; u)\end{aligned}\tag{10.53}$$

where

$$\begin{aligned}
*_2 &= \deg u \deg' \mathbf{z}_{c;1} + \deg u(\deg' \mathbf{z}_{c;2} + \deg v) + \deg v + \deg' \mathbf{z}_{c;2} \\
&= \deg u(\deg' \mathbf{z} + \deg v) + \deg' \mathbf{z}_{c;2} + \deg v, \\
*_3 &= \deg u + \deg' \mathbf{z}_{c;1} + 1 + \deg u(\deg' \mathbf{z}_{c;1} + \deg' \mathbf{z}_{c;2} + \deg v + 1) \\
&\quad + \deg' \mathbf{z}_{c;1} + \deg' \mathbf{z}_{c;2} + \deg v + 1 \\
&= \deg u(\deg v + \deg' \mathbf{z}) + \deg v + \deg' \mathbf{z}_{c;2}, \\
*_4 &= \deg u + 1 + \deg u(\deg' \mathbf{z} + \deg v + 1) + \deg' \mathbf{z} + \deg v + 1 \\
&= \deg u(\deg' \mathbf{z} + \deg v) + \deg' \mathbf{z} + \deg v.
\end{aligned}$$

Thus (10.52) = (10.53) is a consequence of the A_∞ relation. We remark that in the A_∞ relation of \mathbf{n} , the degree of v should be counted as $\deg' v$ (and not as $\deg v$), since v here appears as an element of the morphism complex of A_∞ category (and not as an element of a bi-module). We also remark that the operator \mathbf{m} appearing in the second term of the right hand side of (10.53) coincides with \mathbf{n} in this case.

Let $\varphi = (\varphi_{c;c',k}) \in D^2(c_1, c_2; c_3)$. We put

$$\mathcal{I}_{21}(\varphi) := \varphi_{c_1, c_2; c_3}(\mathbf{e}_{\mathcal{F}_{ob}(c_1)}). \quad (10.54)$$

Here $\mathbf{e}_{\mathcal{F}_{ob}(c_1)} \in \mathcal{C}_2(\mathcal{F}_{ob}(c_1), \mathcal{F}_{ob}(c_1))$ is the unity. It is obvious that \mathcal{I}_{21} is a chain map.

Lemma 10.29. $\mathcal{I}_{12;0,0,0}$ becomes a $(0,0)$ part of a filtered left $\mathcal{C}_{(1)}$ bi-module homomorphism. \diamond

Proof. Let $\mathbf{x} \in B_{k_1} \mathcal{C}_{(1)}[1](c'_1, c_1)$, $u \in D^1(c_1, c_2; c_3)$, $\mathbf{z} \in B\mathcal{C}(c, c')$, and $v \in \mathfrak{D}_{(1)}(c'; \mathcal{F}_{ob}(c_1)) = \mathcal{C}(c', \mathcal{F}_{ob}(c_1))$. We put

$$\begin{aligned}
&\mathcal{I}_{12;k_1,0,0}(\mathbf{x}; u)(\mathbf{z}; v) \\
&:= (-1)^{(\deg' \mathbf{x} + \deg u + 1)(\deg' \mathbf{z} + \deg v)} \mathbf{n}(\mathbf{z} \otimes v \otimes \mathbf{x}; u).
\end{aligned} \quad (10.55)$$

We show that this defines a left \mathcal{C}_1 module homomorphism.

We remark that the left \mathcal{C}_1 module structure on D^2 is induced only from the right- \mathcal{C}_1 module structure on $\mathfrak{D}_{(1)}$. Namely

$$\mathbf{n}(\mathbf{x}, \varphi)(\mathbf{z}; v) = \sum_c (-1)^{\deg \varphi + \deg' \mathbf{z}_{c;1} + 1 + \deg' \mathbf{x}(\deg \varphi + \deg' \mathbf{z} + \deg v)} \varphi(\mathbf{z}_{c;1}, \mathbf{n}(\mathbf{z}_{c;2}, v, \mathbf{x})).$$

See (10.27). This is the case when $\mathbf{x} \notin B_0 \mathcal{C}_1[1](c_1, c_2)$. When $\mathbf{x} = 1$ we have

$$\begin{aligned}
(\mathbf{n}(\varphi))(\mathbf{z}; v) &= \sum_c (-1)^{1 + \deg' \mathbf{z}_{c;1} + \deg \varphi} \varphi(\mathbf{z}_{c;1}, \mathbf{n}(\mathbf{z}_{c;2}, v)) \\
&\quad + \sum_c (-1)^{\deg \varphi} \deg' \mathbf{z}_{c;1} \mathbf{n}(\mathbf{z}_{c;1}, \varphi(\mathbf{z}_{c;2}, v)) + (-1)^{\deg \varphi + 1} \varphi(\hat{d}\mathbf{z}, v).
\end{aligned}$$

See (10.29). On the other hand, the left \mathcal{C}_1 module structure on D^1 is induced from the left \mathcal{C} module structure on $\mathfrak{D}_{(1)}$ via \mathcal{F} .

We also remark that $\mathbf{m}(\mathbf{z}, v, \hat{\mathcal{F}}(\mathbf{x})) = (-1)^{\deg' \mathbf{x}} \mathbf{n}(\mathbf{z}; v; \mathbf{x})$.

We now calculate

$$\begin{aligned}
& \mathcal{I}_{12}(\hat{\mathbf{n}}(\mathbf{x}; u))(\mathbf{z}; v) \\
&= \sum_a (-1)^{\deg' \mathbf{x}_{a:1}} \mathcal{I}_{12}(\mathbf{x}_{a:1}; \mathbf{n}(\mathbf{x}_{a:2}; u))(\mathbf{z}; v) + \mathcal{I}_{12}(\hat{d}\mathbf{x}; u)(\mathbf{z}; v) \\
&= \sum_a (-1)^{*1} \mathbf{n}(\mathbf{z} \otimes v \otimes \widehat{\mathcal{F}}(\mathbf{x}_{a:1}); \mathbf{n}(\widehat{\mathcal{F}}(\mathbf{x}_{a:2}); u)) \\
&\quad + (-1)^{*2} \mathbf{n}(\mathbf{z} \otimes v \otimes \hat{d}\widehat{\mathcal{F}}(\mathbf{x}); u),
\end{aligned} \tag{10.56}$$

with

$$\begin{aligned}
*1 &= \deg' \mathbf{x}_{a:1} + (\deg' \mathbf{x} + \deg u)(\deg' \mathbf{z} + \deg v), \\
*2 &= (\deg' \mathbf{x} + \deg u)(\deg' \mathbf{z} + \deg v).
\end{aligned}$$

Here $\Delta \mathbf{x} = \sum_a \mathbf{x}_{a:1} \otimes \mathbf{x}_{a:2}$. On the other hand,

$$\begin{aligned}
& (\mathbf{n}(\widehat{\mathcal{I}}_{12}(\mathbf{x}; u)))(\mathbf{z}; v) \\
&= \sum_a \mathbf{n}(\mathbf{x}_{a:1}; \mathcal{I}_{12}(\mathbf{x}_{a:2}; u))(\mathbf{z}; v) \\
&= \sum_{a,c} (-1)^{*3} \mathcal{I}_{12}(\mathbf{x}_{a:2}; u)(\mathbf{z}_{c:1}; \mathbf{n}(\mathbf{z}_{c:2}; v; \mathbf{x}_{a:1})) \\
&\quad + \sum_c (-1)^{*4} \mathbf{n}(\mathbf{z}_{c:1}; \mathcal{I}_{12}(\mathbf{x}; u)(\mathbf{z}_{c:2}; v)) \\
&\quad + (-1)^{*5} \mathcal{I}_{12}(\mathbf{x}; u)(\hat{d}\mathbf{z}; v) \\
&= \sum_{a,c} (-1)^{*6} \mathbf{n}(\mathbf{z}_{c:1} \otimes \mathbf{m}(\mathbf{z}_{c:2}; v; \widehat{\mathcal{F}}(\mathbf{x}_{a:1})) \otimes \mathbf{x}_{a:2}; u) \\
&\quad + \sum_c (-1)^{*7} \mathbf{n}(\mathbf{z}_{c:1}; \mathbf{n}(\mathbf{z}_{c:2}; v; \mathbf{x}; u)) \\
&\quad + (-1)^{*8} \mathbf{n}(\hat{d}\mathbf{z} \otimes v \otimes \mathbf{x}; u)
\end{aligned} \tag{10.57}$$

with

$$\begin{aligned}
*3 &= \deg' \mathbf{x}_{a:1}(\deg' \mathbf{x}_{a:2} + \deg u + \deg' \mathbf{z} + \deg v) + 1 + \deg' \mathbf{x}_{a:2} + \deg u + \deg' \mathbf{z}_{c:1}, \\
*4 &= \deg' \mathbf{z}_{c:1}(\deg' \mathbf{x} + \deg u), \\
*5 &= \deg' \mathbf{x} + \deg u + 1,
\end{aligned}$$

and⁴⁶

$$\begin{aligned}
*6 &= (\deg' \mathbf{x} + \deg u)(\deg' \mathbf{z} + \deg v) + \deg' \mathbf{z}_{c:2} + \deg v, \\
*7 &= (\deg' \mathbf{x} + \deg u)(\deg' \mathbf{z} + \deg v) + \deg' \mathbf{z}_{c:2} + \deg v, \\
*8 &= (\deg' \mathbf{x} + \deg u)(\deg' \mathbf{z} + \deg v) + \deg' \mathbf{z} + \deg v.
\end{aligned}$$

Therefore the A_∞ relation implies (10.56) = (10.57). We remark again that in the A_∞ relation of \mathbf{n} , the degree of v should be counted as $\deg' v$ (and not $\deg v$).

The proof that $\mathcal{I}_{12;0,0;0}$ extends to a tri-module homomorphism is similar. \square

Lemma 10.30.

- (1) The composition $\mathcal{I}_{21} \circ \mathcal{I}_{12,00}$ is equal to the identity.
- (2) The composition $\mathcal{I}_{12,00} \circ \mathcal{I}_{21}$ is chain homotopic to the identity.

⁴⁶We remark that during the calculation of the sign $*6$ we use the fact that the operator \mathbf{n} appearing in the third line is related to the operator \mathbf{m} in the sixth line by (10.2).

◇

Proof. (1) is easy to show. We prove (2). We remark that

$$(\mathcal{I}_{12,00} \circ \mathcal{I}_{21})(\varphi)(\mathbf{z}; v) = (-1)^{(\deg \varphi + 1)(\deg' \mathbf{z} + \deg v)} \mathbf{n}(\mathbf{z} \otimes v; \varphi(\mathbf{e})),$$

where the notations are as above.

We define $\mathfrak{H} : D^2(c_1, c_2; c_3) \rightarrow D^2(c_1, c_2; c_3)$ by the next formula.

$$\mathfrak{H}(\varphi)(\mathbf{z}; v) := (-1)^{\deg \varphi + \deg v + \deg' \mathbf{z} + 1} \varphi(\mathbf{z} \otimes v; \mathbf{e}). \quad (10.58)$$

Let \mathbf{n} be the structure operations of $\mathfrak{D}_{(1)}$, $\mathfrak{D}_{(2)}$, which induce a boundary operator δ on $D^2(c_1, c_2; c_3)$. See Lemma-Definition 10.21. We calculate:

$$\begin{aligned} (\delta(\mathfrak{H}(\varphi)))(\mathbf{z}; v) &= \sum_c (-1)^{\deg' \mathbf{z}_{c;1}(1 + \deg \varphi)} \mathbf{n}(\mathbf{z}_{c;1}, \mathfrak{H}(\varphi)(\mathbf{z}_{c;2}; v)) \\ &\quad + \sum_c (-1)^{\deg \varphi + \deg' \mathbf{z}_{c;1}} \mathfrak{H}(\varphi)(\mathbf{z}_{c;1}; \mathbf{n}(\mathbf{z}_{c;2}; v)) \\ &\quad + (-1)^{\deg \varphi} \mathfrak{H}(\varphi)(\hat{d}\mathbf{z}; v) \\ &= \sum_c (-1)^{*1} \mathbf{n}(\mathbf{z}_{c;1}; \varphi(\mathbf{z}_{c;2} \otimes v; \mathbf{e})) \\ &\quad + \sum_c (-1)^{*2} \varphi(\mathbf{z}_{c;1} \otimes \mathbf{n}(\mathbf{z}_{c;2}; v); \mathbf{e}) \\ &\quad + (-1)^{*3} \varphi(\hat{d}\mathbf{z} \otimes v; \mathbf{e}), \end{aligned}$$

with

$$\begin{aligned} *1 &= \deg' \mathbf{z}_{c;1}(1 + \deg \varphi) + \deg \varphi + \deg' \mathbf{z}_{c;2} + \deg v + 1, \\ *2 &= \deg \varphi + \deg' \mathbf{z}_{c;1} + \deg \varphi + \deg' \mathbf{z} + \deg v, \\ *3 &= \deg' \mathbf{z} + \deg v. \end{aligned}$$

Here $\Delta(\mathbf{z}) = \sum_c \mathbf{z}_{c;1} \otimes \mathbf{z}_{c;2}$. On the other hand

$$\begin{aligned} &(\mathfrak{H}(\delta(\varphi)))(\mathbf{z}; v) \\ &= (-1)^{\deg \varphi + \deg' \mathbf{z} + \deg v} (\delta\varphi)(\mathbf{z} \otimes v; \mathbf{e}) \\ &= (-1)^{*4} \mathbf{n}(\mathbf{z} \otimes v; \varphi(\mathbf{e})) \\ &\quad + (-1)^{*5} \sum_c \mathbf{n}(\mathbf{z}_{c;1}; \varphi(\mathbf{z}_{c;2} \otimes v; \mathbf{e})) \\ &\quad + (-1)^{*6} \varphi(\mathbf{z} \otimes v) \\ &\quad + \sum_c (-1)^{*7} \varphi(\mathbf{z}_{c;1}; \mathbf{n}(\mathbf{z}_{c;2}; v); \mathbf{e}) \\ &\quad + (-1)^{*8} \varphi(\hat{d}\mathbf{z} \otimes v; \mathbf{e}), \end{aligned}$$

with

$$\begin{aligned} *4 &= \deg \varphi + \deg' \mathbf{z} + \deg v + \deg \varphi(\deg' \mathbf{z} + \deg v + 1) \\ &= (\deg \varphi + 1)(\deg' \mathbf{z} + \deg v), \\ *5 &= \deg \varphi + \deg' \mathbf{z} + \deg v + \deg \varphi \deg' \mathbf{z}_{c;1} = *1 + 1, \\ *6 &= 1, \\ *7 &= \deg \varphi + \deg' \mathbf{z} + \deg v + \deg' \mathbf{z}_{c;1} + 1 + \deg \varphi = *2 + 1, \\ *8 &= \deg \varphi + \deg' \mathbf{z} + \deg v + 1 + \deg \varphi = *3 + 1. \end{aligned}$$

Therefore \mathfrak{H} is the chain homotopy we look for. \square

Proposition 10.23 follows from Lemmas 10.29, 10.30 and Proposition 7.9. \square

10.6. A note on 2-categories of A_∞ categories. We remark that the diagram

$$\begin{array}{ccc} \mathit{BIMOD}(\mathcal{C}_1; \mathcal{C}_2) & \longrightarrow & \mathit{BIMOD}(\mathcal{C}_1; \mathcal{C}_2) \\ \times \mathit{BIMOD}(\mathcal{C}_2; \mathcal{C}_3) \times \mathit{BIMOD}(\mathcal{C}_3; \mathcal{C}_4) & & \times \mathit{BIMOD}(\mathcal{C}_2; \mathcal{C}_4) \\ \downarrow & & \downarrow \\ \mathit{BIMOD}(\mathcal{C}_1; \mathcal{C}_3) \times \mathit{BIMOD}(\mathcal{C}_3; \mathcal{C}_4) & \longrightarrow & \mathit{BIMOD}(\mathcal{C}_1; \mathcal{C}_4) \end{array} \quad (10.59)$$

strictly commutes. Here the arrows are the derived tensor product functor ten . The same holds if we replace $\mathit{BIMOD}(*; *)$ by $\mathit{BIMOD}(*; *)^{\text{op}}$. This implies that the diagram:

$$\begin{array}{ccc} \mathit{FUNC}(\mathcal{C}_1, \mathcal{C}_2) & \longrightarrow & \mathit{FUNC}(\mathcal{C}_1, \mathcal{C}_2) \\ \times \mathit{FUNC}(\mathcal{C}_2, \mathcal{C}_3) \times \mathit{FUNC}(\mathcal{C}_3, \mathcal{C}_4) & & \times \mathit{FUNC}(\mathcal{C}_2, \mathcal{C}_4) \\ \downarrow & & \downarrow \\ \mathit{FUNC}(\mathcal{C}_1, \mathcal{C}_3) \times \mathit{FUNC}(\mathcal{C}_3, \mathcal{C}_4) & \longrightarrow & \mathit{FUNC}(\mathcal{C}_1, \mathcal{C}_4) \end{array} \quad (10.60)$$

commutes up to homotopy equivalence. Here the arrows are the composition functors comp . Since we take homotopy inverses to relative Yoneda functors to obtain comp from ten , the Diagram (10.60) does not commute strictly. Using the version of Whitehead theorem with the notion ‘homotopic’ rather than ‘homotopy equivalent’ (See Section 13), the ‘set of choices of homotopy inverse’ seems to be ‘contractible’. So we might be able to prove the associativity of comp in a certain A_∞ sense. That might give a definition of A_∞ category of A_∞ categories. The author does not try to work it out here. Instead he points out the following.

Let \mathcal{A} be a set whose elements are strict, unital and gapped filtered A_∞ categories. We construct a DG-2-category $\mathfrak{C}(\mathcal{A})$ whose object set is \mathcal{A} and morphism category from $\mathcal{C}_1 \in \mathcal{A}$ to $\mathcal{C}_2 \in \mathcal{A}$ is a full subcategory $\mathfrak{C}(\mathcal{C}_1, \mathcal{C}_2)$ of $\mathit{BIMOD}(\mathcal{C}_1; \mathcal{C}_2)^{\text{op}}$ such that the object set of $\mathfrak{C}(\mathcal{C}_1, \mathcal{C}_2)$ consists of the bi-modules which are homotopy equivalent to an element of the image of the relative Yoneda functor $\mathfrak{R}\mathfrak{Y}\mathfrak{on}_{\text{ob}} : \mathfrak{D}\mathfrak{B}(\mathit{FUNC}(\mathcal{C}_1, \mathcal{C}_2)) \rightarrow \mathfrak{D}\mathfrak{B}(\mathit{BIMOD}(\mathcal{C}_1, \mathcal{C}_2)^{\text{op}})$.

The composition bi-functor of $\mathfrak{C}(\mathcal{A})$ is ten .

By the strict commutativity of (10.59) the composition bi-functors of $\mathfrak{C}(\mathcal{A})$ are strictly associative as DG-tri-functors.

Lemma-Definition 10.3 implies that $\mathit{FUNC}(\mathcal{C}_1, \mathcal{C}_2)$ is homotopy equivalent to $\mathfrak{C}(\mathcal{C}_1, \mathcal{C}_2)$. Moreover this homotopy equivalence intertwines composition bi-functors of $\mathfrak{C}(\mathcal{A})$ with the composition bi-functors of $\mathit{FUNC}(\mathcal{C}_1, \mathcal{C}_2)$ up to homotopy equivalence.

It is an opinion of the author that we can use $\mathfrak{C}(\mathcal{A})$ as the ‘2-category of A_∞ categories’ for most of the purposes.

11. ASSOCIATIVITY OF COMPOSITIONS

11.1. Statement of the result of Section 11. In this section we prove the associativity of the composition functor defined in Theorem 8.5.

Situation 11.1. Let (X_i, ω_i, V_i) be a symplectic manifold (X_i, ω_i) equipped with a background datum V_i . Let $\mathbb{L}_{i(i+1)}$ for $i = 1, 2, 3$ be a finite set of $\pi_1^*(V_i \oplus TX_i) \oplus \pi_2^*(V_{i+1})$ relatively spin Lagrangian submanifolds of $-X_i \times X_{i+1}$. Let $\mathbb{L}_{i(i+2)}$,

$i = 1, 2$ be a finite set of $\pi_1^*(V_i \oplus TX_{i+1}) \oplus \pi_2^*(V_{i+2})$ relatively spin Lagrangian submanifolds of $-X_i \times X_{i+2}$. Let \mathbb{L}_{14} be a finite set of $\pi_1^*(V_1 \oplus TX_1) \oplus \pi_2^*(V_4)$ relatively spin Lagrangian submanifolds of $-X_1 \times X_4$.

We assume:

- (1) For $i = 1, 2, 3$ and for any element $L_{i(i+1)}$ of $\mathbb{L}_{i(i+1)}$ and $L_{(i+1)(i+2)}$ of $\mathbb{L}_{(i+1)(i+2)}$, we assume that the fiber product $L_{i(i+1)} \times_{X_{i+1}} L_{(i+1)(i+2)}$ is transversal. We also assume that its immersion to $X_{i(i+2)}$ has clean self-intersection.
- (2) For $i = 1, 2, 3$, the geometric composition of an element of $\mathbb{L}_{i(i+1)}$ and of $\mathbb{L}_{(i+1)(i+2)}$ is contained in $\mathbb{L}_{i(i+2)}$.
- (3) We assume the same condition as item (1) for the pairs $(\mathbb{L}_{12}, \mathbb{L}_{24}), (\mathbb{L}_{13}, \mathbb{L}_{34})$.
- (4) The geometric composition of an element of \mathbb{L}_{12} and of \mathbb{L}_{24} is contained in \mathbb{L}_{14} . The geometric composition of an element of \mathbb{L}_{13} and of \mathbb{L}_{34} is contained in \mathbb{L}_{14} .

For $1 \leq i < i' \leq 4$, let $\mathfrak{F}\mathfrak{u}\mathfrak{t}(-X_i \times X_{i'})$ be the filtered A_∞ category defined in Theorem 3.49 whose objects is an element of $\mathbb{L}_{ii'}$ and $\mathfrak{F}\mathfrak{u}\mathfrak{st}(-X_i \times X_{i'})$ the strict category associated to $\mathfrak{F}\mathfrak{u}\mathfrak{t}(-X_i \times X_{i'})$. \diamond

Theorem 11.2. *Suppose we are in Situation 11.1. The next diagram commutes up to homotopy equivalence.*

$$\begin{array}{ccc}
\mathfrak{F}\mathfrak{u}\mathfrak{st}(-X_1 \times X_2) \times \mathfrak{F}\mathfrak{u}\mathfrak{st}(-X_2 \times X_3) & \longrightarrow & \mathfrak{F}\mathfrak{u}\mathfrak{st}(-X_1 \times X_3) \\
\times \mathfrak{F}\mathfrak{u}\mathfrak{st}(-X_3 \times X_4) & & \times \mathfrak{F}\mathfrak{u}\mathfrak{st}(-X_3 \times X_4) \\
\downarrow & & \downarrow \\
\mathfrak{F}\mathfrak{u}\mathfrak{st}(-X_1 \times X_2) \times \mathfrak{F}\mathfrak{u}\mathfrak{st}(-X_2 \times X_4) & \longrightarrow & \mathfrak{F}\mathfrak{u}\mathfrak{st}(-X_1 \times X_4)
\end{array} \tag{11.1}$$

where all the arrows are defined by the composition functor in Theorem 8.5. The homotopy equivalence is one of unital, strict and gapped filtered A_∞ tri-functors. \diamond

The proof of Theorem 11.2 occupies the rest of this section. The proof is completed in Subsection 11.4. The argument of Subsection 11.4 is similar to Subsection 10.4. The commutativity of (11.1) is homotopy equivalence between two tri-functors. Using relative Yoneda embedding, it is equivalent to homotopy equivalence between certain two quatro-modules. For the proof we will construct a quatro-module homomorphism between them. The quatro-module homomorphism which we call Double-pants transformation is defined by using a moduli space of objects which we call Double-pants. Double-pants in this section plays the role Y-diagram played in Section 10.

11.2. Opposite bi-modules and Opposite drums. For the proof of Theorem 11.2 we need a certain digression.

Definition 11.3. Let \mathcal{C}_i be a filtered A_∞ category for $i = 1, 2$ and $\mathfrak{D} = (D, \mathfrak{n})$ a left- \mathcal{C}_1 , right- \mathcal{C}_2 bi-module.

We define the *opposite bi-module* $\mathfrak{D}^{\text{op}} = (D^{\text{op}}, \mathfrak{n}^{\text{op}})$, which is a left- $\mathcal{C}_2^{\text{op}}$, right- $\mathcal{C}_1^{\text{op}}$ module by the next formula. Let $\mathbf{x} \in B\mathcal{C}_2^{\text{op}}(c_2, c'_2)$, $\mathbf{z} \in B\mathcal{C}_1^{\text{op}}(c'_1, c_1)$, $y \in \mathfrak{D}^{\text{op}}(c'_2, c'_1) := D(c'_1, c'_2)$.

$$\mathfrak{n}^{\text{op}}(\mathbf{x}; y; \mathbf{z}) = (-1)^* \mathfrak{n}(\mathbf{z}^{\text{op}}; y; \mathbf{x}^{\text{op}}) \tag{11.2}$$

Here the sign $*$ is by Kuszul rule $+1$. (See Definition 2.30.) We remark there are two convention of the degree of bi-module, one is shifting the degree of an

element of D the other is not shifting the degree of an element of D . We put $*$ = $\epsilon(\mathbf{x}) + \deg' \mathbf{x} \deg' \mathbf{z} + \deg' y(\deg' \mathbf{x} + \deg' \mathbf{z}) + 1$ when we take the first convention and $*$ = $\epsilon(\mathbf{x}) + \deg' \mathbf{x} \deg' \mathbf{z} + \deg y(\deg' \mathbf{x} + \deg' \mathbf{z}) + 1$ when we take the second convention. \diamond

It is easy to check (11.2) satisfies the A_∞ relation.

Example 11.4. In Subection 2.5 we defined the Yoneda functor $\mathfrak{Yon} : \mathcal{C} \rightarrow \mathcal{F}UNC(\mathcal{C}^{\text{op}}, \mathcal{CH})$ and the opposite Yoneda functor $\mathfrak{OpYon} : \mathcal{C}^{\text{op}} \rightarrow \mathcal{F}UNC(\mathcal{C}, \mathcal{CH})$. These two functors define left- \mathcal{C} , right- \mathcal{C} bi-module structures on $\mathcal{C}(c, c')$. It is easy to check that they are opposite bi-modules each other. \diamond

We next define the opposite drum.

Definition 11.5. Suppose we are in the situation of Definition 8.15. We consider $(\Sigma; \vec{z}_{12}, \vec{z}_{23}, \vec{z}_{13}; u_1, u_2, u_3; \gamma_1, \gamma_2, \gamma_3)$ such that they enjoy the same properties as Definition 8.15 except the following:

- (i) u_1 is a map from W_2 and u_2 is a map from W_1 .
- (ii) We enumerate $\vec{z}_{12}, \vec{z}_{23}$ downward and \vec{z}_{13} upward.

We denote by $\mathcal{M}_{\text{DR}}^{\text{op}}(\vec{a}_{12}, \vec{a}_{23}, \vec{a}_{13}; a_-, a_+; E)$ the set of isomorphism classes of such objects. We call an element of $\mathcal{M}_{\text{DR}}^{\text{op}}(\vec{a}_{12}, \vec{a}_{23}, \vec{a}_{13}; a_-, a_+; E)$ or its compactification an *opposite pseudo-holomorphic drum*. \diamond

Proposition 11.6. $\mathcal{M}_{\text{DR}}^{\text{op}}(\vec{a}_{12}, \vec{a}_{23}, \vec{a}_{13}; a_-, a_+; E)$ has a compactification, abbreviated by $\mathcal{M}_{\text{DR}}^{\text{op}}(\vec{a}_{12}, \vec{a}_{23}, \vec{a}_{13}; a_-, a_+; E)$, which is compact and Hausdorff. The compactifications have a system Kuranishi structures and CF-perturbations. They induce a left $\mathfrak{Futst}(-X_1 \times X_2)$, $\mathfrak{Futst}(-X_2 \times X_3)$ and right $\mathfrak{Futst}(-X_1 \times X_3)$ tri-module. \diamond

The proof is the same as the argument of Subsection 8.2. For example Figures 32 and 33 are replaced by the next Figures 44 and 45.

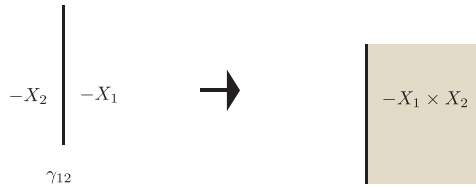

FIGURE 44. Opposite version of Figure 32

We denote the tri-module obtained in Proposition 11.6 by $\mathcal{CF}^{\text{op}}(\mathbb{L}_{12}, \mathbb{L}_{23}; \mathbb{L}_{13})$.

We recall that in Section 8 we defined the left- $\mathfrak{Fut}(-X_1 \times X_3)$ right- $\mathfrak{Fut}(-X_1 \times X_2)$, $\mathfrak{Fut}(-X_2 \times X_3)$ tri-module $\mathcal{CF}(\mathbb{L}_{13}; \mathbb{L}_{12}, \mathbb{L}_{23})$

Lemma 11.7. $\mathcal{CF}^{\text{op}}(\mathbb{L}_{12}, \mathbb{L}_{23}; \mathbb{L}_{13})$ is the opposite module to $\mathcal{CF}(\mathbb{L}_{13}; \mathbb{L}_{12}, \mathbb{L}_{23})$. \diamond

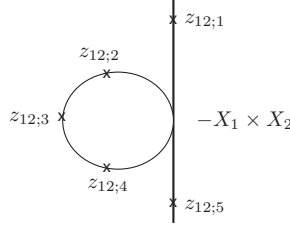

FIGURE 45. Opposite version of Figure 33

Proof. We define

$$\mathfrak{J} : \mathcal{M}_{\text{DR}}^{\circ\circ\text{op}}(\vec{a}_{12}, \vec{a}_{23}, \vec{a}_{13}; a_-, a_+; E) \rightarrow \mathcal{M}_{\text{DR}}^{\circ\circ}(\vec{a}_{12}, \vec{a}_{23}, \vec{a}_{13}; a_-, a_+; E)$$

as follows. We take $F : S^1 \times \mathbb{R} \rightarrow S^1 \times \mathbb{R}$ by

$$F(t, \tau) = (1 - t, 1 - \tau).$$

This is a bi-holomorphic map. In view of (8.10) this operation exchanges the domains W_1 and W_2 . Moreover it revert the direction of the orientation of the seams. Thus composing F with the maps in the moduli space, we obtain a bijection \mathfrak{J} . It is easy to see that the compactification is preserved. We can take the Kuranishi structures and CF-perturbations so that they are preserved by \mathfrak{J} . We remark that the map \mathfrak{J} reverse the enumeration of the marked points on the seams. This means that the operators obtained from these two moduli spaces are related by the operation taking the opposite category. Therefore, in view of Example 11.4, the lemma holds up to sign. In Subsection 17.3 we define orientation of the moduli spaces of the drums and opposite drums via appropriate doubling constructions. Therefore Theorem 3.54 implies that the sign becomes one of the opposite module. \square

In Section 8 we defined the functor

$$\text{comp} : \mathfrak{Fut}(-X_1 \times X_2) \times \mathfrak{Fut}(-X_2 \times X_3) \rightarrow \mathfrak{Fut}(-X_1 \times X_3) \tag{11.3}$$

so that the composition

$$\mathfrak{Yon} \circ \text{comp} : \mathfrak{Fut}(-X_1 \times X_2) \times \mathfrak{Fut}(-X_2 \times X_3) \rightarrow \text{FUNC}(\mathfrak{Fut}(-X_1 \times X_3)^{\text{op}}, \mathcal{CH})$$

is the tri-module $\mathcal{CF}(\mathbb{L}_{13}; \mathbb{L}_{12}, \mathbb{L}_{23})$.

On the other hand, the tri-module analogue of Lemma-Definition 10.3 defines:

$$\mathfrak{Yon} : \text{FUNC}(\mathcal{C}_1 \times \mathcal{C}_2, \mathcal{C}_3) \rightarrow \text{TRIMOD}(\mathcal{C}_1, \mathcal{C}_2; \mathcal{C}_3)^{\text{op}}.$$

Corollary 11.8. $\mathcal{CF}^{\text{op}}(\mathbb{L}_{12}, \mathbb{L}_{23}; \mathbb{L}_{13})$ is homotopy equivalent to the tri-module obtained by applying $\mathfrak{Yon}_{\text{ob}}$ to (11.3). \diamond

This is a consequence of Lemma 11.7 and Example 11.5.

11.3. Double pants diagrams. In this subsection we work in Situation 11.1. The proof of Theorem 11.2 is based on a study of a moduli space of pseudo-holomorphic maps from a space divided into pieces, which we explain now. We consider the non-compact Riemann surface W of genus zero with 4 ends and its division $W = \bigcup_{i=1}^4 W_i$ as in Figure 46 below.

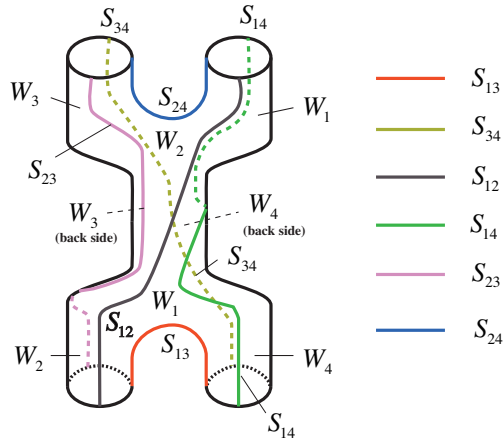
FIGURE 46. Domain W

The domain W is biholomorphic to S^2 minus 4 points. It is divided into 4 domains W_i , $i = 1, 2, 3, 4$. The intersection $S_{ii'} = W_i \cap W_{i'}$ is an arc for $ii' = 12, 13, 14, 23, 24, 34$, which we call a *seam*. We call four points where three of the seams intersect the *holes*.

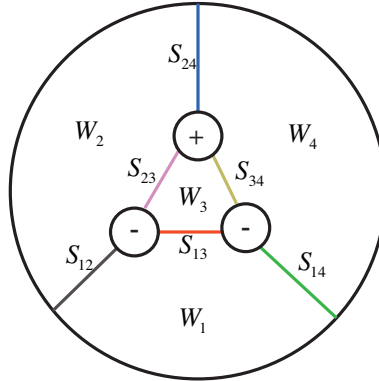
FIGURE 47. Domain W (alternative view)

We consider the domain W minus holes and remove a relatively compact set from it. Then the complement is biholomorphic to the disjoint union of the two copies of $(-\infty, 0] \times S^1$ and the two copies of $[0, \infty) \times S^1$. Each of those connected components are divided into three pieces by seams. In other words, each of them intersects with three of W_i 's among four, as is shown in Figures 48 and 49. We take and fix a bi-holomorphic map between each of those ends and $(-\infty, 0] \times S^1$ or $[0, \infty) \times S^1$.

We take the orientation of the seams $S_{ii'}$ as follows.

- (seo1) For $ii' = 12, 23, 34$ we orient the seams so that it goes from the positive end to the negative end.
- (seo2) For $ii' = 14$ we orient the seam so that it goes from the negative end to the positive end.

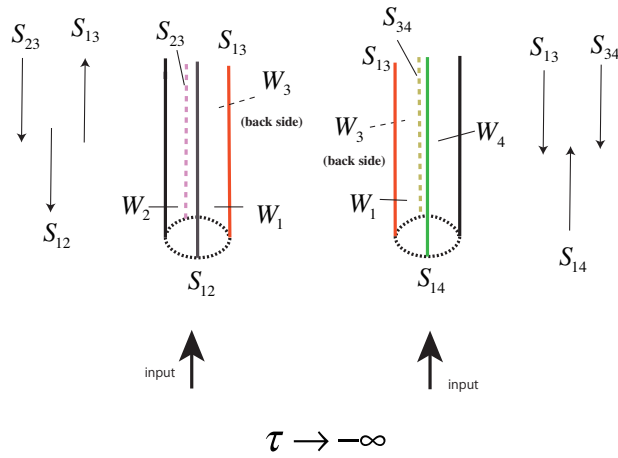

FIGURE 48. Negative ends of the domain W

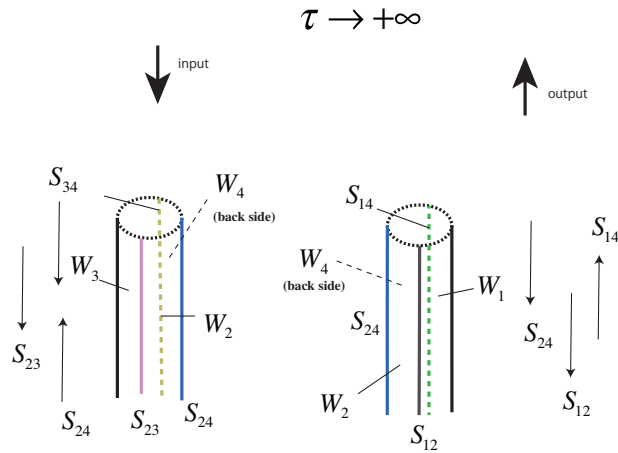

FIGURE 49. Positive ends of the domain W

(seo3) For $ii' = 13$ we orient the seam so that it goes from the end written in the left hand side of Figure 48 to the end written in the right hand side of Figure 48. For $ii' = 24$ we orient the seam so that it goes from the end written in the right hand side of Figure 49 to the end written in the left hand side of Figure 49.

See Figures 48 and 49 for this orientation.

We observe that Figure 48 coincides with the negative end of the opposite drum used to define $\mathcal{CF}^{\text{op}}(\mathbb{L}_{12}, \mathbb{L}_{23}; \mathbb{L}_{13})$ and $\mathcal{CF}^{\text{op}}(\mathbb{L}_{13}, \mathbb{L}_{34}; \mathbb{L}_{14})$. The right figure in Figure 49 coincides with the *positive* end of the opposite drum used to define

$\mathcal{CF}^{\text{op}}(\mathbb{L}_{12}, \mathbb{L}_{24}; \mathbb{L}_{14})$. In the left side of the Figure 49 the positive end is actually an input. So we rotate the figure by 180 degree so that it becomes the negative end. Then it coincides with the negative end of the *drum*⁴⁷ used to define $\mathcal{CF}(\mathbb{L}_{24}; \mathbb{L}_{23}, \mathbb{L}_{34})$.

We decompose the fiber product to the connected components as:

$$\tilde{L}_{ii'} \times_{X_i \times X_{i'}} \tilde{L}_{ii'} = \bigcup_{a \in \mathcal{A}_{L_{ii'}}} L_{ii'}(a) \quad (11.4)$$

Situation 11.1 (2) implies that the fiber product in the left hand side is clean. Note that one of the components of (11.4) is the diagonal component.

For $i, i', i'' \in \{1, 2, 3, 4\}$ with $i < i' < i''$ we decompose

$$(L_{ii'} \times L_{i'i''} \times L_{ii''}) \times_{(X_i \times X_{i'} \times X_{i'')^2} \Delta} = \bigcup_{a \in \mathcal{A}_{i'i''}} R_{ii'i''}(a) \quad (11.5)$$

where Δ is the diagonal in $(X_i \times X_{i'} \times X_{i'')^2$. This is the decomposition to the connected components. Situation 11.1 (4) implies that the fiber product in the left hand side is clean.

Let $\vec{a}_{ii'} = (a_{ii',1}, \dots, a_{ii',k_{ii'}}) \in (\mathcal{A}_{L_{ii'}})^{k_{ii'}}$, $\vec{a}_i = (a_{i,1}, \dots, a_{i,k_i}) \in (\mathcal{A}_{L_i})^{k_i}$, $a_{ii'i''} \in \mathcal{A}_{ii'i''}$.

In the next definition we define $\overset{\circ}{\mathcal{M}}_{\text{DP}}((\vec{a}_{ii'})_{ii'}; (a_{ii'i''})_{ii'i''}; E)$.

Definition 11.9. We consider $(\Sigma; (\vec{z}_{ii'})_{1 \leq i < i' \leq 4}; (u_i; i = 1, 2, 3, 4); (\gamma_{ii'})_{1 \leq i < i' \leq 4})$ with the following properties.

- (1) The bordered nodal curve Σ is a union of W and trees of sphere components attached to W . The roots of the trees of sphere components are not on $\bigcup_{i,i'} S_{ii'}$.
- (2) For $i = 1, 2, 3, 4$, we denote by Σ_i the union of W_i together with the trees of sphere components rooted on W_i . The map $u_i : \Sigma_i \rightarrow X_i$ is J_{X_i} holomorphic for $i = 1, 2, 3, 4$.
- (3) $\vec{z}_{ii'} = (z_{ii',1}, \dots, z_{ii',k_{ii'}})$ and $z_{ii',j} \in S_{ii'}$. We require $z_{ii',j} < z_{ii',j'}$ for $j < j'$, where we identify $S_{ii'} \cong \mathbb{R}$ by using the orientation defined in (seo1),(seo2),(seo3). We put $|\vec{z}_{ii'}| = \{z_{ii',1}, \dots, z_{ii',k_{ii'}}\}$.
- (4) The map $\gamma_{ii'} : S_{ii'} \setminus |\vec{z}_{ii'}| \rightarrow \tilde{L}_{ii'}$ is smooth and satisfies

$$i_{L_{ii'}}(\gamma_{ii'}(z)) = (u_i(z), u_{i'}(z)). \quad (11.6)$$

- (5) At $\vec{z}_{ii'}$, the map $\gamma_{ii'}$ satisfies the switching condition:

$$\left(\lim_{z \in S_{ii'} \uparrow z_{ii',j}} \gamma_{ii'}(z), \lim_{z \in S_{ii'} \downarrow z_{ii',j}} \gamma_{ii'}(z) \right) \in L_{ii'}(a_{ii',j}) \quad (11.7)$$

Here we identify $S_{ii'} \cong \mathbb{R}$ and then \uparrow, \downarrow have obvious meaning (See Definition 3.17 (5)) by using the orientation of $S_{ii'}$.

- (6) At the negative end of W , the following asymptotic boundary condition is satisfied.

$$\lim_{\tau \rightarrow -\infty} (\gamma_{12}(\tau), \gamma_{23}(\tau), \gamma_{13}(-\tau)) \in R_{123}(a_{123}). \quad (11.8)$$

$$\lim_{\tau \rightarrow -\infty} (\gamma_{13}(\tau), \gamma_{34}(\tau), \gamma_{14}(-\tau)) \in R_{134}(a_{134}). \quad (11.9)$$

⁴⁷We emphasise that this is not the opposite drum.

- (7) At the positive end of W the following asymptotic boundary condition is satisfied.

$$\lim_{\tau \rightarrow +\infty} (\gamma_{23}(\tau), \gamma_{34}(\tau), \gamma_{14}(-\tau)) \in R_{234}(a_{134}). \quad (11.10)$$

$$\lim_{\tau \rightarrow +\infty} (\gamma_{12}(\tau), \gamma_{24}(\tau), \gamma_{24}(-\tau)) \in R_{124}(a_{124}). \quad (11.11)$$

- (8) The stability condition, which is defined in the same way as Definition 9.7 (2), is satisfied.
- (9)

$$\sum_{i=1}^4 \int_{\Sigma_i} u_i^* \omega_i = E.$$

In the same way as Definition 9.7 (3), we define an equivalence relation \sim among the objects $(\Sigma; (\bar{z}_{ii'})_{1 \leq i < i' \leq 4}; (u_i)_{i=1,2,3,4}; (\gamma_{ii'})_{1 \leq i < i' \leq 4})$ satisfying (1)-(9). We denote by $\overset{\circ}{\mathcal{M}}_{\text{DP}}((\bar{a}_{ii'})_{ii'}; (a_{ii'i''})_{ii'i''}; E)$ the set of all the equivalence classes of this equivalence relation.

We define evaluation maps:

$$\text{ev}_{ii',j} : \overset{\circ}{\mathcal{M}}_{\text{DP}}((\bar{a}_{ii'})_{ii'}; (a_{ii'i''})_{ii'i''}; E) \rightarrow L_{ii'}(a_{ii',j}) \quad (11.12)$$

by using (11.7). We define evaluation maps

$$\text{ev}_{ii'i''} : \overset{\circ}{\mathcal{M}}_{\text{DP}}((\bar{a}_{ii'})_{ii'}; (a_{ii'i''})_{ii'i''}; E) \rightarrow R_{ii'i''}(a_{ii'i''}) \quad (11.13)$$

by using one of (11.8)-(11.11).

Proposition 11.10. *We can define a topology on $\overset{\circ}{\mathcal{M}}_{\text{DP}}((\bar{a}_{ii'})_{ii'}; (a_{ii'i''})_{ii'i''}; E)$ such that it has a compactification $\mathcal{M}_{\text{DP}}((\bar{a}_{ii'})_{ii'}; (a_{ii'i''})_{ii'i''}; E)$, which is a compact metrizable space. They have Kuranishi structures with corners which enjoy the following properties.*

- (1) *The normalized boundary of $\mathcal{M}_{\text{DP}}((\bar{a}_{ii'})_{ii'}; (a_{ii'i''})_{ii'i''}; E)$ is a disjoint union of 2 types of fiber products, which we describe below.*
- (2) *The evaluation maps (11.12) and (11.13) extend to strongly smooth maps with respect to this Kuranishi structure. (11.13) is weakly submersive. The extension is compatible with the description of the boundary in item (1).*
- (3) *The orientation local system of $\mathcal{M}_{\text{DP}}((\bar{a}_{ii'})_{ii'}; (a_{ii'i''})_{ii'i''}; E)$ is isomorphic to the tensor product of the pull backs of Θ^- by the evaluation maps (11.12) and (11.13). For the component $R_{124}(a_{124})$ we take Θ^+ in place of Θ^- .*
- (4) *The Kuranishi structure is compatible with the forgetful map of the marked points corresponding to the diagonal components.*

◇

We describe the boundary components.

- (I) The first type of boundary corresponds to the bubble at one of the Lagrangian boundary conditions $L_{ii'}$. We describe the case of L_{12} . Let $b \in \mathcal{A}_{L_{12}}$ and $i \leq j$. We put $\bar{a}_{12}^1 = (a_{12,0}, \dots, a_{12,i}, b, a_{12,j+1}, \dots, a_{12,k_{12}})$, $\bar{a}_{12}^2 = (b, a_{12,i+1}, \dots, a_{12,j})$. We put $\bar{a}'_{12} = \bar{a}_{12}^1$, $\bar{a}'_{ii'} = \bar{a}_{ii'}$ for $ii' \neq 12$. This boundary corresponds to the fiber product

$$\mathcal{M}_{\text{DP}}((\bar{a}'_{ii'})_{ii'}; (a_{ii'i''})_{ii'i''}; E_1) \times_{L_{12}(b)} \mathcal{M}'(L_{12}; \bar{a}_{12}^2; E_2). \quad (11.14)$$

Here $E_1 + E_2 = E$. We remark that we use the compactification \mathcal{M}' in the second factor, which is a moduli space of pseudo-holomorphic disks. (See Remark 5.38 and Section 12.) See Figure 50.

The bubble at $L_{ii'}$ for $ii' \neq 12$ can be described in the same way.

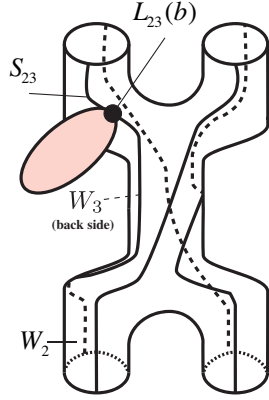

FIGURE 50. Bubble of Type I

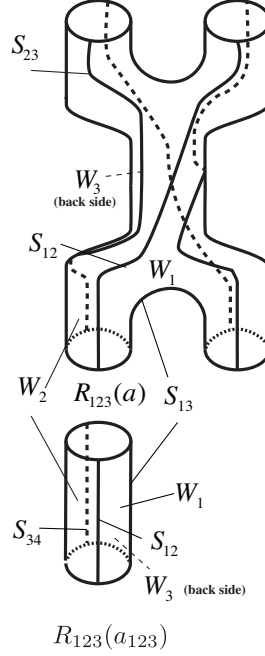

FIGURE 51. Bubble of Type II

- (II) The second type of boundary corresponds to the limit where the domain will be divided into two parts at the ends. There are 4 ends of our domain. We first consider the case of the ends in the left hand side of Figure 48.

Let $j_{ii'} \in \{0, \dots, k_{ii'}\}$ for $ii' = 12, 23$ or 13 . We put $\vec{a}_{ii'}^1 = (a_{ii',1}, \dots, a_{ii',j_{ii'}})$, $\vec{a}_{ii'}^2 = (a_{ii',j_{ii'}+1}, \dots, a_{ii',k_{ii'}})$ for $ii' = 12$ or 23 . We put $\vec{a}_{ii'}^2 = (a_{ii',1}, \dots, a_{ii',j_{ii'}})$, $\vec{a}_{ii'}^1 = (a_{ii',j_{ii'}+1}, \dots, a_{ii',k_{ii'}})$ for $ii' = 13$. We then put $\vec{a}'_{ii'} = \vec{a}_{ii'}^2$ for $ii' = 12, 23$ or 13 and $\vec{a}'_{ii'} = \vec{a}_{ii'}^1$ otherwise.

Let $a \in \mathcal{A}_{123}$. We put $a'_{123} = a$ and $a'_{ii'i''} = a_{ii'i''}$ for $ii'i'' \neq 123$.

Now this boundary is described by the next fiber product.

$$\mathcal{M}_{\text{DP}}((\vec{a}_{ii'}^1)_{ii'}; (a'_{ii'i''})_{ii'i''}; E_1) \times_{R_{123}(a)} \mathcal{M}_{\text{DR}}^{\text{op}}((\vec{a}'_{ii'})_{ii'=12,23,13}; a_{123}, a; E_2) \quad (11.15)$$

where $E_1 + E_2 = E$ and $a \in \mathcal{A}_{L_{12}}$. See Figure 51. Note that $\mathcal{M}_{\text{DR}}^{\text{op}}((\vec{a}'_{ii'})_{i,i'}; a, a_{123}; E_2)$ is the moduli space of opposite pseudo-holomorphic drums as in Definition 11.5.

In the case of the end in the right hand side of Figure 48, the end is described by the fiber product

$$\mathcal{M}_{\text{DP}}((\vec{a}_{ii'}^1)_{ii'}; (a'_{ii'i''})_{ii'i''}; E_1) \times_{R_{134}(a)} \mathcal{M}_{\text{DR}}^{\text{op}}((\vec{a}'_{ii'})_{ii'=13,34,14}; a_{134}, a; E_2). \quad (11.16)$$

Here $\vec{a}_{ii'}^1, \vec{a}'_{ii'i''}$ and $\vec{a}'_{ii'}$ are defined in a way similar to the first case.

In the case of the end in the left hand side of Figure 49, the end is described by the fiber product

$$\mathcal{M}_{\text{DP}}((\vec{a}_{ii'}^1)_{ii'}; (a'_{ii'i''})_{ii'i''}; E_1) \times_{R_{234}(a)} \mathcal{M}_{\text{DR}}((\vec{a}'_{ii'})_{ii'=23,34,24}; a_{234}, a; E_2). \quad (11.17)$$

Here $\vec{a}_{ii'}^1, \vec{a}'_{ii'i''}$ and $\vec{a}'_{ii'}$ are defined in a way similar to the first case. We remark that the second factor is the moduli space of pseudo-holomorphic drums⁴⁸ as in Definition 8.15. The reason why pseudo-holomorphic drums appear here is explained right after the orientation of seams (seo1), (seo2), (seo3) are defined.

In the case of the end in the right hand side of Figure 49, the end is described by the fiber product

$$\mathcal{M}_{\text{DR}}^{\text{op}}((\vec{a}'_{ii'})_{ii'=12,24,14}; a, a_{124}; E_2) \times_{R_{124}(a)} \mathcal{M}_{\text{DP}}((\vec{a}_{ii'}^1)_{ii'}; (a'_{ii'i''})_{ii'i''}; E_1). \quad (11.18)$$

Here the moduli space of opposite pseudo-holomorphic drums appears. Moreover it appears as the first factor. The reason is in the case of this end, $R_{124}(a)$ corresponds to the output of the second factor.

The proof of Proposition 11.10 is similar to various other propositions we discussed before in this and other papers and so is omitted. (See Subsection 17.5 for the proof of Proposition 11.10 (3).)

Proposition 11.11. *For each E_0 there exists a system of CF-perturbations $\widehat{\mathfrak{S}}$ on $\mathcal{M}_{\text{DP}}((\vec{a}_{ii'}^1)_{ii'}; (a'_{ii'i''})_{ii'i''}; E)$ (with respect to Kuranishi structures which are outer collarings of thickenings of those in Proposition 11.10) for $E < E_0$ such that the following holds.*

- (1) *They are transversal to 0.*
- (2) *The evaluation map (11.13) is strongly submersive⁴⁹ with respect to this CF-perturbation.*
- (3) *The CF-perturbations are compatible with the description of the boundary. Namely restriction of the CF-perturbation on the boundary coincides with the fiber product CF-perturbation in the sense of [FOOO10, FOOO13, Lemma-Definition 10.6].*
- (4) *The CF-perturbations are compatible with the forgetful maps of the boundary marked points corresponding to the diagonal component, in the sense of [Fu9, Theorem 5.1].*

◇

The proof is similar to the other similar statements we discussed already and is now a routine. We omit it.

We now use Propositions 11.10 and 11.11 to produce certain operations in a similar way as previous sections.

We need certain notations. For $1 \leq i < i' \leq 4$ and $1 \leq j \leq k_{ii'}$ let $h_{ii',j} \in \Omega(L_{ii'}(a_{ii',j}); \Theta^-)$. We put

$$\mathbf{h}_{ii'} = (h_{ii',1}, \dots, h_{ii',k_{ii'}}) \in B_{k_{ii'}} CF[1](\mathcal{L}_{ii'}; \mathcal{L}'_{ii'}). \quad (11.19)$$

For $ii'i'' = 123$ or 134 let

$$h_{ii'i''} \in \Omega(R_{ii'i''}(a_{ii'i''}); \Theta^-) \subseteq CF^{\text{op}}(\mathcal{L}_{ii'}, \mathcal{L}_{ii'i''}; \mathcal{L}_{ii'i''}). \quad (11.20)$$

⁴⁸not opposite drum

⁴⁹See [FOOO10, FOOO13, Definition 9.2] for its definition.

and for $ii'i'' = 234$, let

$$h_{234} \in \Omega(R_{234}(a_{234}); \Theta^-) \subseteq CF(\mathcal{L}_{24}; \mathcal{L}_{23}, \mathcal{L}_{34}). \quad (11.21)$$

Definition 11.12. We define

$$\mathcal{D}\mathcal{P}\mathcal{T}^{E,\epsilon}((\mathbf{h}_{ii'})_{i,i'}; h_{123}, h_{134}, h_{234}) \in \Omega(R_{124}(a_{124}); \Theta^-)$$

by the next formula:

$$\text{ev}_{124}! \left(\prod_{i < i'} \text{ev}^* \mathbf{h}_{ii'} \wedge \prod_{ii'i''=123,134,234} \text{ev}_{ii'i''}^* h_{ii'i''}; \widehat{\mathfrak{S}}^\epsilon \right). \quad (11.22)$$

Here we use the moduli space $\mathcal{M}((\vec{a}_{ii'})_{ii'}; (a_{ii'i''})_{ii'i''}; E)$ and its CF-perturbation $\widehat{\mathfrak{S}}^\epsilon$ to define (11.22). There is actually a sign in the right hand side. We will explain it in Subsection 17.5.

We extend $\mathcal{D}\mathcal{P}\mathcal{T}^{E,\epsilon}$ by Λ_0 linearity and use it to define

$$\begin{aligned} \mathcal{D}\mathcal{P}\mathcal{T}^{<E_0,\epsilon} : \prod_{i < i'} BCF[1](\mathcal{L}_{ii'}; \mathcal{L}'_{ii'}) \otimes CF^{\text{op}}(\mathcal{L}'_{12}, \mathcal{L}'_{23}; \mathcal{L}_{13}) \\ \otimes CF^{\text{op}}(\mathcal{L}'_{13}, \mathcal{L}'_{34}; \mathcal{L}_{14}) \otimes CF(\mathcal{L}'_{24}; \mathcal{L}_{23}, \mathcal{L}_{34}) \\ \rightarrow CF^{\text{op}}(\mathcal{L}_{12}, \mathcal{L}_{24}; \mathcal{L}'_{14}) \end{aligned} \quad (11.23)$$

by the next formula:

$$\mathcal{D}\mathcal{P}\mathcal{T}^{<E_0,\epsilon} = \sum_{E < E_0} T^E \mathcal{D}\mathcal{P}\mathcal{T}^{E,\epsilon}.$$

We call $\mathcal{D}\mathcal{P}\mathcal{T}^{<E_0,\epsilon}$ the *double pants transformation*. \diamond

We next state the main property of the double pants transformation. We need some notations. Let $h_{ii'i''} \in CF^{\text{op}}(\mathcal{L}_{ii'}; \mathcal{L}_{i'i''}; \mathcal{L}_{ii''})$ for $ii'i'' = 123$ or 134 , $h_{234} \in CF(\mathcal{L}_{24}; \mathcal{L}_{23}; \mathcal{L}_{34})$ and $\mathbf{h}_{ii'} = (h_{ii',1}, \dots, h_{ii',k_{ii'}}) \in B_{k_{ii'}} CF[1](\mathcal{L}_{ii'}; \mathcal{L}'_{ii'})$. We put

$$\Delta \mathbf{h}_{ii'} = \sum_c \mathbf{h}_{ii'}^{c:1} \otimes \mathbf{h}_{ii'}^{c:2}.$$

For $\rho = jj'j'' = 123, 134$ or 234 we define $\mathbf{h}_{ii'}^{\rho,c}$ as follows. Let W_ρ be one of the four ends corresponding to $\rho = jj'j''$.

- (1) $\mathbf{h}_{ii'}^{\rho,c} = \mathbf{h}_{ii'}^{c:1}$ and $\mathbf{h}_{ii'}^{\rho,c'} = \mathbf{h}_{ii'}^{c:2}$ if $S_{ii'}$ does not intersect with W_ρ .
- (2) $\mathbf{h}_{ii'}^{\rho,c} = \mathbf{h}_{ii'}^{c:1}$ and $\mathbf{h}_{ii'}^{\rho,c'} = \mathbf{h}_{ii'}^{c:2}$ if $S_{ii'} \cap W_\rho \neq \emptyset$ and W_ρ lies at the $-\infty$ side with respect to the orientation of the seam $S_{ii'}$.
- (3) $\mathbf{h}_{ii'}^{\rho,c} = \mathbf{h}_{ii'}^{c(\rho):2}$ and $\mathbf{h}_{ii'}^{\rho,c'} = \mathbf{h}_{ii'}^{c:1}$ if $S_{ii'} \cap W_\rho \neq \emptyset$ and W_ρ lies at the $+\infty$ side with respect to the orientation of the seam $S_{ii'}$.

In case $\rho = jj'j'' = 124$ we define $\mathbf{h}_{ii'}^{\rho,c}$ by exchanging the conditions (2) and (3).

We also put

$$\hat{d}_{jj'}(\mathbf{h}_{ii'})_{ii'} = (\mathbf{h}_{ii'}^*)_{ii'}$$

where $\mathbf{h}_{ii'}^* = \mathbf{h}_{ii'}$ for $ii' \neq jj'$ and $\mathbf{h}_{jj'}^* = \hat{d}\mathbf{h}_{jj'}$. We then put

$$\hat{d}(\mathbf{h}_{ii'})_{ii'} = \sum_{jj'} \hat{d}_{jj'}(\mathbf{h}_{ii'})_{ii'}.$$

Proposition 11.13. *The double pants transformation $\mathcal{D}\mathcal{P}\mathcal{T}^{<E_0,\epsilon}$ satisfies the next congruence modulo T^{E_0} .*

$$\begin{aligned}
& \mathcal{D}\mathcal{P}\mathcal{T}^{<E_0,\epsilon}(\hat{d}((\mathbf{h}_{ii'})_{ii'}); h_{123}, h_{134}, h_{234}) \\
& + \sum_{c(12),c(23),c(13)} \mathcal{D}\mathcal{P}\mathcal{T}^{<E_0,\epsilon} \left((\mathbf{h}_{ii'}^{123,c(ii')})_{ii'} \right. \\
& \quad \left. ; \mathbf{n}^{\text{op}}(\mathbf{h}_{12}^{123,c(12);'}, \mathbf{h}_{23}^{123,c(23);'}, h_{123}; \mathbf{h}_{13}^{123,c(13);'}, h_{134}, h_{234}) \right) \\
& + \sum_{c(13),c(34),c(14)} \mathcal{D}\mathcal{P}\mathcal{T}^{<E_0,\epsilon} \left((\mathbf{h}_{ii'}^{134,c(ii')})_{ii'} \right. \\
& \quad \left. ; h_{123}, \mathbf{n}^{\text{op}}(\mathbf{h}_{13}^{134,c(13);'}, \mathbf{h}_{34}^{134,c(34);'}, h_{134}; \mathbf{h}_{14}^{134,c(34);'}, h_{234}) \right) \quad (11.24) \\
& + \sum_{c(23),c(34),c(24)} \mathcal{D}\mathcal{P}\mathcal{T}^{<E_0,\epsilon} \left((\mathbf{h}_{ii'}^{234,c(ii')})_{ii'} ; h_{123}, h_{134}, \right. \\
& \quad \left. \mathbf{n}(\mathbf{h}_{24}^{234;'}, h_{234}; \mathbf{h}_{23}^{234;'}, \mathbf{h}_{34}^{234;'}) \right) \\
& - \sum_{c(12),c(24),c(14)} \mathbf{n}^{\text{op}}(\mathbf{h}_{12}^{124,c(12)}, \mathbf{h}_{24}^{124,c(24)}; \\
& \quad \mathcal{D}\mathcal{P}\mathcal{T}^{<E_0,\epsilon}((\mathbf{h}_{ii'}^{124,c(ii')})_{ii'}; h_{123}, h_{134}, h_{234}); \mathbf{h}_{14}^{124,c(14);'}) \\
& \equiv 0 \pmod{T^{E_0}}.
\end{aligned}$$

Here \mathbf{n} is the structure operation defined by the moduli space of pseudo-holomorphic drums in Section 8 and \mathbf{n}^{op} is the structure operation defined by the moduli space of opposite pseudo-holomorphic drums in Definition 11.6. The signs (which we omit from the above formula) are by Koszul rule. \diamond

Proof. Using Propositions 11.10, 11.11, Stokes' formula ([FOOO10, FOOO13, Proposition 9.26]), and the composition formula ([FOOO10, FOOO13, Theorem 10.20]), the proof goes in the same way as the proof of Proposition 3.35. In fact the first term of (11.24) corresponds to the end of Type I (Figure 50) and the second-fifth terms of (11.24) corresponds to the end of Type II (Figure 51).

In fact, Type I ends are described by the fiber products of the moduli spaces of double pants diagrams and of pseudo-homomorphic polygons. Type II ends are described by the fiber products of the moduli spaces of double pants diagrams and of (opposite) pseudo-homomorphic drums. \square

We can use Proposition 11.13 to prove the next lemma in the same way as we used Propositions 3.30, 3.41 in Subsection 3.3.

Lemma 11.14. *We can define $\mathcal{D}\mathcal{P}\mathcal{T}$ which is congruent to $\mathcal{D}\mathcal{P}\mathcal{T}^{<E_0,\epsilon}$ modulo T^{E_0} and which satisfies the same formula as (11.24) except the congruence is replaced by the equality. \diamond*

We call $\mathcal{D}\mathcal{P}\mathcal{T}$ in Lemma 11.14 also a double pants transformation. We next twist the $\mathcal{D}\mathcal{P}\mathcal{T}$ by bounding cochains. Let $b_{ii'}$ be bounding cochains of $\mathcal{L}_{ii'}$. We define

$$\mathfrak{t}^{\vec{b}} : \prod_{i < i'} BCF[1](\mathcal{L}_{ii'}) \rightarrow \prod_{i < i'} BCF[1](\mathcal{L}_{ii'})$$

by the same formula as (5.15). We then put

$$\mathcal{D}\mathcal{P}\mathcal{T}^{\vec{b}} = \mathcal{D}\mathcal{P}\mathcal{T} \circ (\mathfrak{t}^{\vec{b}} \otimes \text{id}). \quad (11.25)$$

Lemma 11.15. $\mathcal{D}\mathcal{P}\mathcal{T}^{\vec{b}}$ satisfies the same formula as (11.24) except we twist \hat{d} and \mathfrak{n} by \vec{b} and the congruence is replaced by the equality. \diamond

The proof is easy and so is omitted.

11.4. Proof of the associativity. Now we use the double pants transformation to prove Theorem 11.2. The proof is similar to the arguments of Sections 9 and 10.

We first prove the next proposition, which is similar to Proposition 9.2.

Proposition 11.16. *In Situation 11.1, let $\mathcal{L}_{12} = (L_{12}, \sigma_{12}, b_{12})$ (resp. $\mathcal{L}_{23} = (L_{23}, \sigma_{23}, b_{23})$, $\mathcal{L}_{34} = (L_{34}, \sigma_{34}, b_{34})$) be an object of $\mathfrak{Futst}(-X_1 \times X_2)$ (resp. $\mathfrak{Futst}(-X_2 \times X_3)$, $\mathfrak{Futst}(-X_3 \times X_4)$). We put*

$$\begin{aligned}\mathcal{L}_{13} &= (L_{13}, \sigma_{13}, b_{13}) = \mathfrak{Comp}(\mathcal{L}_{12}, \mathcal{L}_{23}) \\ \mathcal{L}_{14}^{(1)} &= (L_{14}^{(1)}, \sigma_{14}^{(1)}, b_{14}^{(1)}) = \mathfrak{Comp}(\mathcal{L}_{13}, \mathcal{L}_{34}),\end{aligned}$$

and

$$\begin{aligned}\mathcal{L}_{24} &= (L_{24}, \sigma_{24}, b_{24}) = \mathfrak{Comp}(\mathcal{L}_{23}, \mathcal{L}_{34}) \\ \mathcal{L}_{14}^{(2)} &= (L_{14}^{(2)}, \sigma_{14}^{(2)}, b_{14}^{(2)}) = \mathfrak{Comp}(\mathcal{L}_{12}, \mathcal{L}_{24}),\end{aligned}$$

Then we have the following:

- (1) $(L_{14}^{(1)}, \sigma_{14}^{(1)}) = (L_{14}^{(2)}, \sigma_{14}^{(2)})$. Here the equality is as submanifolds equipped with relative spin structures.
- (2) $b_{14}^{(1)}$ is gauge equivalent to $b_{14}^{(2)}$ in the sense of [FOOO1, Definition 4.3.1].

\diamond

Proof. (1) is proved in the same way as Proposition 9.2 (1), which is proved in Subsection 17.4. We prove (2) below.

We put $\mathbf{h}_{ii'} = e^{b_{ii'}}$ for $1 \leq i < i' \leq 4$ with $ii' \neq 14$ and $\mathbf{h}_{14} = e^{b_{14}^{(1)}}$. Let $\mathbf{h}_{ii'i''} = \mathbf{1}_{ii'i''}$ for $ii'i'' = 123, 134, 234$. Here $\mathbf{1}_{ii'i''}$ is the function 1 on the diagonal component, which is diffeomorphic to $\tilde{L}_{ii''}$. We define

$$\mathbf{1}_{124}^{(1)} = \mathcal{D}\mathcal{P}\mathcal{T}^{\vec{b}}((\mathbf{h}_{ii'})_{ii'}; h_{123}, h_{134}, h_{234}).$$

We consider the filtered A_∞ tri-module $\mathcal{CF}(\mathbb{L}_{14}; \mathbb{L}_{12}, \mathbb{L}_{24})$ and twist it by the bounding cochains b_{12}, b_{24} . We then obtain a left filtered A_∞ module $\mathcal{CF}(\mathbb{L}_{14}; \mathbb{L}_{12}, \mathbb{L}_{24})$ over $\mathfrak{Futst}(-X_1 \times X_4)$. By Lemma 11.15 we have

$$\mathfrak{n}(e^{b_{14}^{(1)}}; \mathbf{1}_{124}^{(1)}) = 0. \quad (11.26)$$

Let $\mathbf{1}_{124}^{(2)}$ be the function $1 \in CF(L_{14}; L_{12}, L_{24})$ on the diagonal component, which is diffeomorphic to \tilde{L}_{14} . By definition (See Formulas (8.6) and (6.3).) we have

$$\mathfrak{n}(e^{b_{14}^{(2)}}; \mathbf{1}_{124}^{(2)}) = 0. \quad (11.27)$$

By the definition of $\mathcal{D}\mathcal{P}\mathcal{T}^{\vec{b}}$ and $\mathbf{1}_{124}^{(1)}$ we find that

$$\mathbf{1}_{124}^{(1)} \equiv \mathbf{1}_{124}^{(2)} \pmod{\Lambda_+}. \quad (11.28)$$

Using (11.26), (11.27), (11.28), we can apply (the left module analogue of) Lemma 9.14 to conclude that $b_{14}^{(1)}$ is gauge equivalent to $b_{14}^{(2)}$. \square

Proof of Theorem 11.2. We first study the composition:

$$\begin{aligned} & \mathfrak{F}\mathfrak{u}\mathfrak{k}\mathfrak{st}(-X_1 \times X_2) \times \mathfrak{F}\mathfrak{u}\mathfrak{k}\mathfrak{st}(-X_2 \times X_3) \times \mathfrak{F}\mathfrak{u}\mathfrak{k}\mathfrak{st}(-X_3 \times X_4) \\ & \rightarrow \mathfrak{F}\mathfrak{u}\mathfrak{k}\mathfrak{st}(-X_1 \times X_3) \times \mathfrak{F}\mathfrak{u}\mathfrak{k}\mathfrak{st}(-X_3 \times X_4) \rightarrow \mathfrak{F}\mathfrak{u}\mathfrak{k}\mathfrak{st}(-X_1 \times X_4). \end{aligned} \quad (11.29)$$

We apply the object part of the relative Yoneda functor to

$$\mathfrak{F}\mathfrak{u}\mathfrak{k}\mathfrak{st}(-X_1 \times X_2) \times \mathfrak{F}\mathfrak{u}\mathfrak{k}\mathfrak{st}(-X_2 \times X_3) \rightarrow \mathfrak{F}\mathfrak{u}\mathfrak{k}\mathfrak{st}(-X_1 \times X_3). \quad (11.30)$$

We then obtain the filtered A_∞ tri-module $\mathcal{C}\mathcal{F}^{\text{op}}(\mathbb{L}_{12}, \mathbb{L}_{23}; \mathbb{L}_{13})$ by Corollary 11.8.

On the other hand, applying the object part of the relative Yoneda functor to the composition

$$\mathfrak{F}\mathfrak{u}\mathfrak{k}\mathfrak{st}(-X_1 \times X_3) \times \mathfrak{F}\mathfrak{u}\mathfrak{k}\mathfrak{st}(-X_3 \times X_4) \rightarrow \mathfrak{F}\mathfrak{u}\mathfrak{k}\mathfrak{st}(-X_1 \times X_4)$$

we obtain the filtered A_∞ tri-module $\mathcal{C}\mathcal{F}^{\text{op}}(\mathbb{L}_{13}, \mathbb{L}_{34}; \mathbb{L}_{14})$ by Corollary 11.8.

Therefore, by Proposition 10.10, applying the relative Yoneda functor to the composition (11.29) gives the derived tensor product:

$$D_1 = \mathbf{ten}(\mathcal{C}\mathcal{F}^{\text{op}}(\mathbb{L}_{12}, \mathbb{L}_{23}; \mathbb{L}_{13}), \mathcal{C}\mathcal{F}^{\text{op}}(\mathbb{L}_{13}, \mathbb{L}_{34}; \mathbb{L}_{14})) \quad (11.31)$$

over $\mathfrak{F}\mathfrak{u}\mathfrak{k}\mathfrak{st}(-X_1 \times X_3)$. The quatromodule structure on D_1 is defined in the same way as one in the derived tensor product. (See Lemma-Definition 10.6.) Here the quatromodule structure is left- $\mathfrak{F}\mathfrak{u}\mathfrak{k}\mathfrak{st}(-X_1 \times X_2)$, $\mathfrak{F}\mathfrak{u}\mathfrak{k}\mathfrak{st}(-X_2 \times X_3)$, $\mathfrak{F}\mathfrak{u}\mathfrak{k}\mathfrak{st}(-X_3 \times X_4)$ and right $\mathfrak{F}\mathfrak{u}\mathfrak{k}\mathfrak{st}(-X_1 \times X_4)$ module structure.

We next consider the composition:

$$\begin{aligned} & \mathfrak{F}\mathfrak{u}\mathfrak{k}\mathfrak{st}(-X_1 \times X_2) \times \mathfrak{F}\mathfrak{u}\mathfrak{k}\mathfrak{st}(-X_2 \times X_3) \times \mathfrak{F}\mathfrak{u}\mathfrak{k}\mathfrak{st}(-X_3 \times X_4) \\ & \rightarrow \mathfrak{F}\mathfrak{u}\mathfrak{k}\mathfrak{st}(-X_1 \times X_2) \times \mathfrak{F}\mathfrak{u}\mathfrak{k}\mathfrak{st}(-X_2 \times X_4) \rightarrow \mathfrak{F}\mathfrak{u}\mathfrak{k}\mathfrak{st}(-X_1 \times X_4). \end{aligned} \quad (11.32)$$

By definition (See Proposition 8.11.) the composition functor

$$\mathfrak{F}\mathfrak{u}\mathfrak{k}\mathfrak{st}(-X_2 \times X_3) \times \mathfrak{F}\mathfrak{u}\mathfrak{k}\mathfrak{st}(-X_3 \times X_4) \rightarrow \mathfrak{F}\mathfrak{u}\mathfrak{k}\mathfrak{st}(-X_2 \times X_4)$$

composed with the Yoneda functor

$$\mathfrak{Y}\mathfrak{o}\mathfrak{n} : \mathfrak{F}\mathfrak{u}\mathfrak{k}\mathfrak{st}(-X_2 \times X_4) \rightarrow \mathcal{F}\mathcal{U}\mathcal{N}\mathcal{C}(\mathfrak{F}\mathfrak{u}\mathfrak{k}\mathfrak{st}(-X_2 \times X_4)^{\text{op}}; \mathcal{C}\mathcal{H})$$

gives a left- $\mathfrak{F}\mathfrak{u}\mathfrak{k}\mathfrak{st}(-X_2 \times X_4)$, right- $\mathfrak{F}\mathfrak{u}\mathfrak{k}\mathfrak{st}(-X_2 \times X_3)$, $\mathfrak{F}\mathfrak{u}\mathfrak{k}\mathfrak{st}(-X_3 \times X_4)$ tri-module $\mathcal{C}\mathcal{F}(\mathbb{L}_{24}; \mathbb{L}_{23}, \mathbb{L}_{34})$. On the other hand, applying the relative Yoneda functor to

$$\mathfrak{F}\mathfrak{u}\mathfrak{k}\mathfrak{st}(-X_1 \times X_2) \times \mathfrak{F}\mathfrak{u}\mathfrak{k}\mathfrak{st}(-X_2 \times X_4) \rightarrow \mathfrak{F}\mathfrak{u}\mathfrak{k}\mathfrak{st}(-X_1 \times X_4)$$

gives the left- $\mathfrak{F}\mathfrak{u}\mathfrak{k}\mathfrak{st}(-X_1 \times X_2)$, $\mathfrak{F}\mathfrak{u}\mathfrak{k}\mathfrak{st}(-X_2 \times X_4)$ right- $\mathfrak{F}\mathfrak{u}\mathfrak{k}\mathfrak{st}(-X_1 \times X_4)$ tri-module $\mathcal{C}\mathcal{F}^{\text{op}}(\mathbb{L}_{12}, \mathbb{L}_{24}; \mathbb{L}_{14})$.

Therefore we can apply Proposition 10.23 by putting

$$\begin{aligned} \mathcal{C}_{(1)} &= \mathfrak{F}\mathfrak{u}\mathfrak{k}\mathfrak{st}(-X_2 \times X_3) \times \mathfrak{F}\mathfrak{u}\mathfrak{k}\mathfrak{st}(-X_3 \times X_4), \\ \mathcal{C}_{(2)} &= \mathfrak{F}\mathfrak{u}\mathfrak{k}\mathfrak{st}(-X_1 \times X_2), \\ \mathcal{C}_{(3)} &= \mathfrak{F}\mathfrak{u}\mathfrak{k}\mathfrak{st}(-X_1 \times X_4), \\ \mathcal{C} &= \mathfrak{F}\mathfrak{u}\mathfrak{k}\mathfrak{st}(-X_2 \times X_4), \\ \mathfrak{D}_{(1)} &= \mathcal{C}\mathcal{F}^{\text{op}}(\mathbb{L}_{12}, \mathbb{L}_{24}; \mathbb{L}_{14}), \\ \mathfrak{D}_{(2)} &= \mathcal{C}\mathcal{F}(\mathbb{L}_{24}; \mathbb{L}_{23}, \mathbb{L}_{34}), \end{aligned}$$

to find that applying relative Yoneda functor to the map (11.32) gives a left- $\mathfrak{F}\mathfrak{u}\mathfrak{k}\mathfrak{st}(-X_1 \times X_2)$, $\mathfrak{F}\mathfrak{u}\mathfrak{k}\mathfrak{st}(-X_2 \times X_3)$, $\mathfrak{F}\mathfrak{u}\mathfrak{k}\mathfrak{st}(-X_3 \times X_4)$ and right $\mathfrak{F}\mathfrak{u}\mathfrak{k}\mathfrak{st}(-X_1 \times X_4)$ quatromodule

$$D_2 = \mathfrak{H}\mathfrak{o}\mathfrak{m}_{\mathfrak{F}\mathfrak{u}\mathfrak{k}\mathfrak{st}(-X_2 \times X_4)}(\mathcal{C}\mathcal{F}(\mathbb{L}_{24}; \mathbb{L}_{23}, \mathbb{L}_{34}), \mathcal{C}\mathcal{F}^{\text{op}}(\mathbb{L}_{12}, \mathbb{L}_{24}; \mathbb{L}_{14})), \quad (11.33)$$

Now a quatro-module homomorphism from D_1 to D_2 is a map from

$$\begin{aligned} & BCF[1](\mathcal{L}_{12}, \mathcal{L}'_{12}) \otimes BCF[1](\mathcal{L}_{23}, \mathcal{L}'_{23}) \otimes BCF[1](\mathcal{L}_{34}, \mathcal{L}'_{34}) \\ & \otimes CF^{\text{op}}(\mathcal{L}'_{12}, \mathcal{L}'_{23}; \mathcal{L}_{13}) \otimes BCF[1](\mathcal{L}_{13}, \mathcal{L}'_{13}) \otimes CF^{\text{op}}(\mathcal{L}'_{13}, \mathcal{L}'_{34}; \mathcal{L}_{14}) \\ & \otimes CF(\mathcal{L}_{24}; \mathcal{L}'_{23}, \mathcal{L}'_{34}) \otimes BCF[1](\mathcal{L}_{24}, \mathcal{L}'_{24}) \otimes CF(\mathcal{L}_{14}, \mathcal{L}'_{14}) \end{aligned} \quad (11.34)$$

to $CF^{\text{op}}(\mathcal{L}_{12}, \mathcal{L}_{24}; \mathcal{L}'_{14})$.

The double pants transformation $\mathcal{D}\mathcal{P}\mathcal{T}^{\vec{b}}$ is such a map. Note that in (11.23) $\mathcal{L}'_{24}; \mathcal{L}_{23}, \mathcal{L}_{34}$ appears in $CF(\dots)$ and all similar triple appears in $CF^{\text{op}}(\dots)$. This coincides with (11.34). The main property of double pants transformation, that is, Lemma 11.15, implies that $\mathcal{D}\mathcal{P}\mathcal{T}^{\vec{b}}$ gives a quatro-module homomorphism.

Thus we obtained a natural transformation from (11.29) to (11.32). The fact that it induces an isomorphism for objects can be proved in the same way as the last part of the proof of Theorem 10.16 (Subsection 10.4). We can combine it with the argument of the proof of Proposition 11.16 to complete the proof of Theorem 11.2 in the same way as the last step of the proof of Theorem 9.1 (Subsection 10.2). \square

12. TWO DIFFERENT WAYS TO COMPACTIFY THE MODULI SPACE OF PSEUDO-HOLOMORPHIC DISKS IN THE DIRECT PRODUCT

12.1. The reason why we need a different compactification. Let (L_{12}, σ_{12}) be a $\pi_1^*(V_1 \oplus TX_1) \oplus \pi_2^*(V_2)$ relatively spin Lagrangian submanifold of $-X_1 \times X_2$. (Here V_i is a vector bundle on $(X_i)_{[3]}$ for $i = 1, 2$.) Let us consider the set $\mathring{\mathcal{M}}(L_{12}; \vec{a}_{12}; E)$, which we defined in Definition 3.19.

Definition 12.1. The subset $\mathring{\mathring{\mathcal{M}}}(L_{12}; \vec{a}_{12}; E)$ of $\mathring{\mathcal{M}}(L_{12}; \vec{a}_{12}; E)$ consists of the equivalence classes $[(\Sigma; u; \vec{z}; \gamma)]$ such that Σ is a disk. In other words it consists of the stable maps with no sphere or disk bubbles. \diamond

In Section 3 (3.29), we compactified $\mathring{\mathcal{M}}(L_{12}; \vec{a}_{12}; E)$ to $\mathcal{M}(L_{12}; \vec{a}_{12}; E)$. In Definition 5.37 we did not use this compactification but mentioned that we use a slightly different compactification $\mathcal{M}'(L_{12}; \vec{a}_{12}; E)$ to define the partial compactification $\mathring{\mathcal{M}}(\vec{a}_1, \vec{a}_{12}, \vec{a}_2; a_-, a_+; E)$ of $\mathring{\mathring{\mathcal{M}}}(\vec{a}_1, \vec{a}_{12}, \vec{a}_2; a_-, a_+; E)$. See Remark 5.38. In this section we define this compactification $\mathcal{M}'(L_{12}; \vec{a}_{12}; E)$ and its Kuranishi structure.

We first explain the reason why we need to use different compactification from $\mathcal{M}(L_{12}; \vec{a}_{12}; E)$. Actually the space $\mathcal{M}(\vec{a}_1, \vec{a}_{12}, \vec{a}_2; a_-, a_+; E)$ will not carry Kuranishi structure if we use the compactification $\mathcal{M}(L_{12}; \vec{a}_{12}; E)$ in (5.30). We explain its reason in the following example.

Example 12.2. We consider a neighborhood of an element (ξ, η) of the fiber product. We define ξ, η below. Let

$$\xi = ([-1, 1] \times \mathbb{R}; \emptyset; (0, 0), \emptyset; u_1, u_2; \gamma_1, \gamma_{12}, \gamma_2) \in \mathring{\mathring{\mathcal{M}}}(\emptyset, (a_{12}), \emptyset; a_-, a_+; E_1).$$

In other words we consider the case when the source curve Σ is $[-1, 1] \times \mathbb{R}$ and has no sphere bubble, and consider only one (boundary) marked point $(0, 0)$ which is $(0, 0) \in \{0\} \times \mathbb{R}$. See Figure 52. We also consider

$$\eta = (\Sigma; u_3; (1); \gamma_3) \in \mathring{\mathcal{M}}(L_{12}; (a_{12}); E_2). \quad (12.1)$$

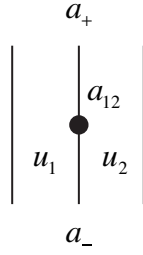

FIGURE 52. Element ξ

Here Σ is the union of D^2 and S^2 glued at $0 \in D^2$ and $[\infty] \in S^2 = \mathbb{C} \cup \{\infty\}$, $u_3 : \Sigma \rightarrow -X_1 \times X_2$ is a pseudo-holomorphic map such that $u_3(\partial\Sigma_3) \subset L_{12}$ and $1 \in \partial\Sigma$ is a boundary marked point. See Figure 53. We assume $(u_1, u_2)(0, 0) = u_3(1)$ and

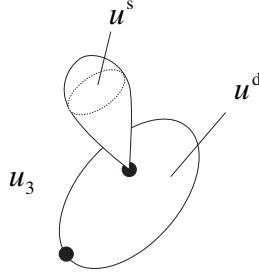

FIGURE 53. Element η

regard the pair (ξ, η) as an element of the fiber product

$$\overset{\circ}{\mathcal{M}}(\emptyset, (a_{12}), \emptyset; a_-, a_+; E_1) \times_{L_{12}(a_{12})} \mathcal{M}(L_{12}; (a_{12}); E_2). \quad (12.2)$$

This fiber product is similar to (5.30) but we use $\mathcal{M}(L_{12}; (a_{12}); E_2)$ in place of $\mathcal{M}'(L_{12}; (a_{12}); E_2)$. We assume $E = E_1 + E_2$. See Figure 54.

Let us consider a neighborhood of this element in the compactified moduli space. For simplicity we assume that the element (ξ, η) is Fredholm regular in the fiber

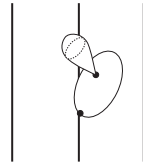

FIGURE 54. Element (ξ, η)

product. We put $u^d = u_3|_{D^2}$ and $u^s = u_3|_{S^2}$. We denote by V^{quilt} , V^d , V^s the parameter to deform ξ , u^d , u^s , respectively. We have two kinds of extra parameters which resolve the singular point. One is $[0, \epsilon]$ which parametrizes the way to resolve the boundary node and the other is D_ϵ^2 which parametrizes the way to resolve the

interior node. Therefore we might imagine that the gluing analysis implies that the neighborhood of (ξ, η) in $\mathcal{M}(\emptyset, \emptyset, \emptyset; a_-, a_+; E)$ is parametrized by

$$V^{\text{quilt}} \times_{L_{12}(a_{12})} V^s \times_{X_1 \times X_2} V^d \times [0, \epsilon) \times D_\epsilon^2. \quad (12.3)$$

However (12.3) does *not* parametrize a neighborhood of (ξ, η) correctly. To see this we examine the process of gluing more carefully. Actually it suffices to see the pre-gluing, which is the process to obtain approximate solution of the non-linear Cauchy-Riemann equation by using partition of unity. (The process to modify it to obtain an actual solution is the same as other well-established cases.)

The maps u^d and u^s are maps to the direct product $-X_1 \times X_2$. So we write $u^d = (u_1^d, u_2^d)$ and $u^s = (u_1^s, u_2^s)$.

We first glue (u_1, u_2) with u^d . This gluing is parametrized by the parameter $\rho \in [0, \epsilon)$ with $\rho \neq 0$. We put $\bar{u}_1(s, t) = u_1(-s, t)$ and regard (\bar{u}_1, u_2) as a map from a neighborhood of $(0, 0)$ in $[0, 1] \times \mathbb{R}$ to $-X_1 \times X_2$ and glue it with u^d . We obtain a map $(\bar{u}_1, u_2) \#_\rho u^d$ from $[0, 1] \times \mathbb{R}$ to $-X_1 \times X_2$.

We then regard $(\bar{u}_1, u_2) \#_\rho u^d$ as a pair of maps (u'_1, u'_2) where $u'_1 : [0, 1] \times \mathbb{R} \rightarrow X_1$, $u'_2 : [0, 1] \times \mathbb{R} \rightarrow X_2$ such that $(u'_1(0, t), u'_2(0, t)) \in L_{12}$. By an abuse of notation we may regard the pair (u'_1, u'_2) as $(u_1 \#_\rho u_1^d, u_2 \#_\rho u_2^d)$. See Figure 55.

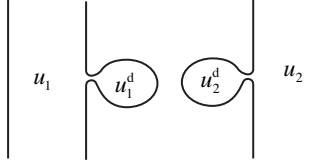

FIGURE 55. $(u_1 \#_\rho u_1^d, u_2 \#_\rho u_2^d)$

We next glue u^s to this pair $(u_1 \#_\rho u_1^d, u_2 \#_\rho u_2^d)$. This gluing is parametrized by the parameter $\theta \in D_\epsilon^2$. We assume $\theta \neq 0$. We observe that the marked point $0 \in D^2$ at which we glue the sphere bubble becomes a pair of points $(-c(\rho), 0) \in [-1, 0] \times \mathbb{R}$ and $(c(\rho), 0) \in [0, 1] \times \mathbb{R}$ after the first gluing. Therefore when we glue u^s we glue $\bar{u}_1^s : S^2 \rightarrow X_1$ to $u_1 \#_\rho u_1^d$ at the point $(-c(\rho), 0)$ and glue $u_2^s : S^2 \rightarrow X_2$ to $u_2 \#_\rho u_2^d$ at the point $(0, c(\rho))$. (Here \bar{u}_1^s is obtained from u_1^s by using anti-holomorphic involution of the source.) We thus can write the element obtained by the gluing as $(u_1 \#_\rho u_1^d \#_\theta \bar{u}_1^s, u_2 \#_\rho u_2^d \#_\theta u_2^s)$. See Figure 56. In this way we obtain a family of

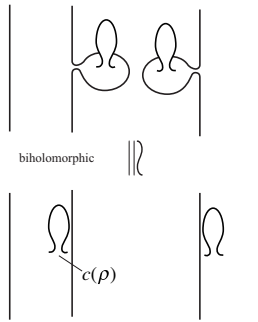

FIGURE 56. $(u_1 \#_\rho u_1^d \#_\theta \bar{u}_1^s, u_2 \#_\rho u_2^d \#_\theta u_2^s)$

approximate solutions parametrized by (12.3).

Now the issue is that this family does not have correct dimension. In fact it has two more parameters than the correct parameter. Let us elaborate on this point below.

Let $v : S^2 \rightarrow S^2$ be a biholomorphic map which preserves $\infty \in \mathbb{C} \cup \{\infty\} \cong S^2$. We remark that $u_2^s \circ v$ and u_2^s are the same element of the moduli space of pseudo-holomorphic spheres with one marked point in X_1 . However $(u_1^s, u_2^s \circ v)$ is a different element from (u_1^s, u_2^s) in the moduli space of pseudo-holomorphic spheres with one marked point in $-X_1 \times X_2$. Thus $(u_1 \#_\rho u_1^d \#_\theta \bar{u}_1^s, u_2 \#_\rho u_2^d \#_\theta u_2^s \circ v)$ may become the same element as $(u_1 \#_\rho u_1^d \#_\theta \bar{u}_1^s, u_2 \#_\rho u_2^d \#_\theta u_2^s)$ but $(u_1, u_2 \circ v) \neq (u_1, u_2)$.

Another point is that, using the notation $(u_1 \#_\rho u_1^d \#_\theta \bar{u}_1^s, u_2 \#_\rho u_2^d \#_\theta u_2^s)$, we can glue \bar{u}_1^s and u_2^s by different gluing parameter at interior nodes. Namely we have a family of elements of our moduli space $(u_1 \#_\rho u_1^d \#_{\theta_1} \bar{u}_1^s, u_2 \#_\rho u_2^d \#_{\theta_2} u_2^s)$ where $\theta_1 \neq \theta_2$ may occur.

In fact a part of the freedom to reparametrize the first (but not the second) factor by v corresponds to the freedom to choose $\theta_1 \neq \theta_2$. We will elaborate on this point. We identify $(S^2, \infty) = (\mathbb{C} \cup \{\infty\}, \infty)$. For $\mathfrak{z} \in \mathbb{C}$ in a neighborhood of 1 we define $v_{\mathfrak{z}} : (\mathbb{C} \cup \{\infty\}, \infty) \rightarrow (\mathbb{C} \cup \{\infty\}, \infty)$ by $v_{\mathfrak{z}}(z) = \mathfrak{z}z$. Then the element

$$(u_1 \#_\rho u_1^d \#_{\mathfrak{z}\theta_1} \bar{u}_1^s, u_2 \#_\rho u_2^d \#_{\theta_2} u_2^s \circ v_{\mathfrak{z}})$$

represents the same element as

$$(u_1 \#_\rho u_1^d \#_{\theta_1} \bar{u}_1^s, u_2 \#_\rho u_2^d \#_{\theta_2} u_2^s).$$

See Remark 12.3 below. We now observe that the real dimension of the group of automorphisms of $(\mathbb{C} \cup \{\infty\}, \infty)$ is 4. On the other hand the extra parameter by allowing $\theta_1 \neq \theta_2$ is 2. Thus we can conclude the dimension of (12.3) is 2 plus the correct dimension of our moduli space.

In other words, we can not define Kuranishi structure of our compactification if we use $\mathcal{M}(L_{12}; \bar{a}_{12}; E)$ in place of $\mathcal{M}'(L_{12}; \bar{a}_{12}; E)$ in (5.30). \diamond

Remark 12.3. To elaborate on the fact

$$(u_1 \#_\rho u_1^d \#_{\mathfrak{z}\theta_1} \bar{u}_1^s, u_2 \#_\rho u_2^d \#_{\theta_2} u_2^s \circ v_{\mathfrak{z}}) \sim (u_1 \#_\rho u_1^d \#_{\theta_1} \bar{u}_1^s, u_2 \#_\rho u_2^d \#_{\theta_2} u_2^s)$$

we consider the case when $\theta_1 = \theta_2 = 0$, that is

$$(u_1 \#_\rho u_1^d \#_0 \bar{u}_1^s, u_2 \#_\rho u_2^d \#_0 u_2^s \circ v_{\mathfrak{z}}) \sim (u_1 \#_\rho u_1^d \#_0 \bar{u}_1^s, u_2 \#_\rho u_2^d \#_0 u_2^s) \quad (12.4)$$

In this case the domain of those elements are drawn as in Figure 57 below. There

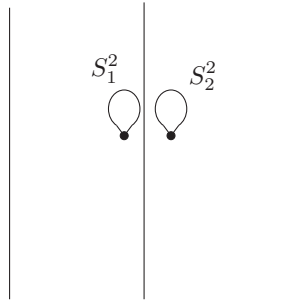

FIGURE 57. The domain in the case when $\theta_1 = \theta_2 = 0$

are two sphere bubbles on the domain. We denote by S_1^2 and S_2^2 the sphere bubbles which lie in the left and right of the seam, respectively. The maps on S_1^2 and S_2^2 are \bar{u}_1^s and u_2^s for the right hand side of (12.4). In the case of left hand side of (12.4) the maps on S_1^2 and S_2^2 are \bar{u}_1^s and $u_2^s \circ v_3$, respectively. We define \hat{v}_3 to be an isomorphism from the configuration as in Figure 57 to itself so that \hat{v}_3 is the identity map outside S_2^2 and is v_3 on S_2^2 . Then it is easy to see that

$$(u_1 \#_\rho u_1^d \#_0 \bar{u}_1^s, u_2 \#_\rho u_2^d \#_0 u_2^s) \circ \hat{v}_3 = (u_1 \#_\rho u_1^d \#_0 \bar{u}_1^s, u_2 \#_\rho u_2^d \#_0 u_2^s \circ v_3).$$

This implies the equivalence (12.4).

We can choose the various additional data which we use to perform the gluing process so that the equivalence in the case $\theta_i = 0$ can be extended to the case $\theta_i \neq 0$. (We omit the detail of this part since the rigorous proof is not necessary for the proof of our results. The discussion here is a motivation to introduce new compactification.)

We also observe the following. We take the limit as ρ goes to 0 in (12.4). The domain depicted by Figure 57 converges to the domain depicted by Figure 54. The automorphisms \hat{v}_3 however cannot be extended to this limit. In fact in the domain of Figure 54 two sphere bubbles become the one sphere bubble and so we are not allowed to take two different biholomorphic maps on the sphere bubble. Therefore ‘the limit’ of left and right hand sides (as ρ goes to 0) are not equivalent. By this reason, it seems likely that it is impossible to define an appropriate topology which is Hausdorff, if we use $\mathcal{M}(L_{12}; \vec{a}_{12,j}; E_{12,j})$ in place of $\mathcal{M}'(L_{12}; \vec{a}_{12,j}; E_{12,j})$ in Theorem 5.43 (2).

Remark 12.4. A similar problem already appeared in [FOOO7]. (See the proof of [FOOO7, Lemma 6.62].) In [FOOO7, Lemma 6.62] we compared two moduli spaces. One is the space of pseudo-holomorphic maps u from a disk to $-X \times X$ so that $u(\partial D^2)$ lies in the diagonal. The other is the space of pseudo-holomorphic maps u' from a sphere to X . We can use reflexion principle to identify those two moduli spaces. When we consider their stable map compactifications the identification does not extend. To explain this fact, we consider the case when u is a map from D^2 with a sphere bubble to $-X \times X$ so that $u(\partial D^2)$ lies in the diagonal. Suppose that u is (\bar{u}_1^s, u_2^s) on the bubble. Then the corresponding element u' is a map from S^2 with two sphere bubbles and the maps on those sphere bubbles are u_1 and u_2 respectively. (See Figure 58.) When we replace u_2 by $u_2 \circ v_3$ the object in the compactification of the moduli space of disks changes. However the corresponding objects in the the compactification of the moduli space of spheres are equivalent. This is similar to the situation of Example 12.2 and Remark 12.3.

In [FOOO7] the problem is slightly less serious since there we need to show two well-defined numbers to coincide. So we can use the fact that the problem occurs only in codimension ≥ 2 strata and use dimension counting argument. Here we need to work out the chain level argument. So we describe the different compactification $\mathcal{M}'(L_{12}; \vec{a}; E)$ in detail in this section. \diamond

Remark 12.5. We remark that the problem of different reparametrizations applied to the first and the second factors in the bubble, which we described in Example 12.2, does *not* occur for the disk bubble but occurs only for the sphere bubble. Let us elaborate on this point below.

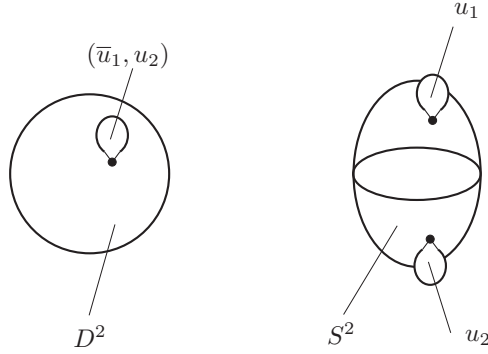

FIGURE 58. Reflexion principle at infinity

Let us consider the same ξ as Example 12.2. We replace η as in (12.1) by

$$\eta = (D^2; u_3; (1); \gamma_3) \in \overset{\circ}{\mathcal{M}}(L_{12}; (a_{12}); E_2).$$

Namely we assume the source curve of η is a disk. The group of automorphisms of the pair $(D^2, 1)$ of a disk with one boundary marked point $1 \in \partial D^2$ is identified with the group of affine transformations $z \mapsto \varphi_{a,b}(z) = az + b$ with $a \in \mathbb{R}_+$ and $b \in \mathbb{R}$. Here we identify $D^2 \setminus \{1\}$ with the upper half plane $\{z \in \mathbb{C} \mid \text{Im}z \geq 0\}$.

Let $u^d = (u_1^d, u_2^d)$ be a representative of an element of $\overset{\circ}{\mathcal{M}}(L_{12}; (a_{12}); E_2)$, where $u_1^d : D^2 \rightarrow X_1$ and $u_2^d : D^2 \rightarrow X_2$.

Note that in this case $(u_1^d, u_2^d \circ \varphi_{a,b})$ does not represent an element of $\overset{\circ}{\mathcal{M}}(L_{12}; (a_{12}); E_2)$ in general, since this element may not satisfy the boundary condition. \diamond

Remark 12.6. The compactification $\mathcal{M}'_{\ell, \ell_1, \ell_2}(L_{12}; \vec{a}; E)$ which we will define in the next subsection, is ‘smaller’ than $\mathcal{M}_{\ell, \ell_1, \ell_2}(L_{12}; \vec{a}; E)$. An intuitive reason why we need smaller compactification lies in the fact that $\overset{\circ\circ}{\mathcal{M}}_{\text{QT}}(L_1, L_{12}, L_2; p, q)$ is also ‘smaller’ than $\overset{\circ\circ}{\mathcal{M}}(L_{12}, L_1 \times L_2; p, q)$. In fact we can define

$$\text{forget}_{\text{QT}} : \overset{\circ\circ}{\mathcal{M}}(L_{12}, L_1 \times L_2; p, q) \rightarrow \overset{\circ\circ}{\mathcal{M}}_{\text{QT}}(L_1, L_{12}, L_2; p, q)$$

Here $p = (p_1, p_2) \in (L_1 \times L_2) \cap L_{12}$, $q = (q_1, q_2) \in (L_1 \times L_2) \cap L_{12}$.

The space $\overset{\circ\circ}{\mathcal{M}}(L_{12}, L_1 \times L_2; p, q)$ is a partially compactified moduli space of pseudo-holomorphic strips. Its element is an equivalence class of $(\Sigma; u)$ where Σ is a strip $[0, 1] \times \mathbb{R}$ with trees of sphere bubbles and $u : \Sigma \rightarrow -X_1 \times X_2$ is a pseudo-holomorphic map. We require that $u|_{\{0\} \times \mathbb{R}}$ (resp. $u|_{\{1\} \times \mathbb{R}}$) lifts to a map to \tilde{L}_{12} (resp. to $\tilde{L}_1 \times \tilde{L}_2$) and u is asymptotic to p (resp. q) when the \mathbb{R} -factor of the domain goes to $-\infty$ (resp. $+\infty$).

The space $\overset{\circ\circ}{\mathcal{M}}_{\text{QT}}(L_1, L_{12}, L_2; p, q)$ is a partially compactified moduli space of pseudo-holomorphic quilt. Its element is an equivalence class of $(\Sigma'; u_1, u_2)$. Here Σ' is $[-1, 1] \times \mathbb{R}$ with trees of sphere bubbles, which is decomposed to $\Sigma'_1 \cup \Sigma'_2$ such that Σ'_1 (resp. Σ'_2) is $[-1, 0] \times \mathbb{R}$ (resp. $[0, 1] \times \mathbb{R}$) together with sphere bubbles. $u_i : \Sigma'_i \rightarrow X_i$ is a pseudo-holomorphic map. We require that $u_1|_{\{-1\} \times \mathbb{R}}$ (resp. $u_2|_{\{1\} \times \mathbb{R}}$) lifts to a map to \tilde{L}_1 (resp. \tilde{L}_2). We also require a matching condition,

that is, the map $\tau \mapsto (u_1(0, \tau), u_2(0, \tau))$ lifts to a map to \tilde{L}_{12} . Furthermore we require asymptotic boundary condition given by p, q .

We define $\mathbf{forget}_{\text{QT}}$ as follows. Let $(\Sigma; u)$ represent an element of $\overset{\circ\circ}{\mathcal{M}}(L_{12}, L_1 \times L_2; p, q)$. We write $u = (u_1, u_2)$ where u_i is a map to X_i . We consider $(\Sigma; u_1)$ and shrink all the unstable sphere components of Σ on which u_1 is constant to obtain Σ'_1 . Using the map $(t, \tau) \mapsto (-t, \tau)$ (which is a map $[-1, 0] \times \mathbb{R} \rightarrow [0, 1] \times \mathbb{R}$), we obtain Σ'_1 from Σ'_1 . The map u_1 induces a map $u'_1 : \Sigma'_1 \rightarrow X_1$. In a similar (and simpler) way we obtain Σ'_2 and $u'_2 : \Sigma'_2 \rightarrow X_2$. We glue Σ'_1 and Σ'_2 on the line $\{0\} \times \mathbb{R}$ to obtain Σ' . It is easy to see that $(\Sigma'; u'_1, u'_2)$ represents an element of $\overset{\circ\circ}{\mathcal{M}}_{\text{QT}}(L_1, L_{12}, L_2; p, q)$.

Using Lemma-Definition 14.33, we can extend the map $\mathbf{forget}_{\text{QT}}$ so that it includes the case when the objects have disk bubbles.

The map Dob in Formula (17.9) is an inverse of $\mathbf{forget}_{\text{QT}}$ on certain open dense subsets.

12.2. The definition of the compactification $\mathcal{M}'(L_{12}; \vec{a}; E)$. Based on the observation in the previous subsection, we now define the compactification $\mathcal{M}'(L_{12}; \vec{a}; E)$. For later use we include the case when we have interior marked points and define $\mathcal{M}'_{\ell, \ell_1, \ell_2}(L_{12}; \vec{a}; E)$.

Definition 12.7. We consider objects

$$(((\Sigma_1, \vec{z}_1, \vec{z}_1^{\text{int}}, \vec{w}_1^{\text{int}}), u_1), ((\Sigma_2, \vec{z}_2, \vec{z}_2^{\text{int}}, \vec{w}_2^{\text{int}}), u_2), \mathcal{S}, \gamma)$$

with the following properties.

- (1) The space Σ_i ($i = 1, 2$) is a bordered curve of genus zero with one boundary component. $\vec{z}_i = (z_{i,0}, \dots, z_{i,k})$ are mutually distinct boundary marked points of Σ_i such that the enumeration of the marked points respects orientation of the boundary. $\vec{z}_i^{\text{int}} = (z_{i,0}^{\text{int}}, \dots, z_{i,\ell}^{\text{int}})$ and $\vec{w}_i^{\text{int}} = (w_{i,1}, \dots, w_{i,\ell_i})$ are mutually distinct interior marked points on Σ_i . Marked points are not nodal points.
- (2) The maps $u_1 : \Sigma_1 \rightarrow -X_1$, $u_2 : \Sigma_2 \rightarrow X_2$ are pseudo-holomorphic. (We do not assume that $(((\Sigma_i, \vec{z}_i, \vec{z}_i^{\text{int}}, \vec{w}_i^{\text{int}}), u_i)$ is stable. The stability condition we assume is Definition 12.10 below.)
- (3) We shrink all the unstable sphere components of $(\Sigma_i, \vec{z}_i, \vec{z}_i^{\text{int}})$, (that is, the sphere components which have less than 3 nodal or marked points in \vec{z}_i^{int}). We denote by $(\Sigma_i^0, \vec{z}_i, \vec{z}_i^{\text{int}})$ the marked bordered nodal curve obtained by this shrinking. (We use the same symbols $\vec{z}_i, \vec{z}_i^{\text{int}}$ for marked points by an abuse of notation.) (We remark that we forget \vec{w}_i^{int} when we define Σ_i^0 .) Then, $\mathcal{S} : \Sigma_1^0 \rightarrow \Sigma_2^0$ is a biholomorphic map such that $\mathcal{S}(z_{1,j}) = z_{2,j}$, $\mathcal{S}(z_{1,j}^{\text{int}}) = z_{2,j}^{\text{int}}$. (See Figure 59.)
- (4) The map $\gamma : \partial\Sigma_1 \setminus \vec{z}_1 \rightarrow \tilde{L}_{12}$ is continuous and satisfies:

$$i_{L_{12}}(\gamma(z)) = (u_1(z), u_2(\mathcal{S}(z))). \quad (12.5)$$

(Note that (12.5) implies $(u_1(z), u_2(\mathcal{S}(z))) \in L_{12}$ for $z \in \partial\Sigma_1$.) (We also remark $\partial\Sigma_1 = \partial\Sigma_1^0$.)

- (5) We require the switching condition, Condition 12.8, below.
- (6) We require the stability condition, Definition 12.10, below.

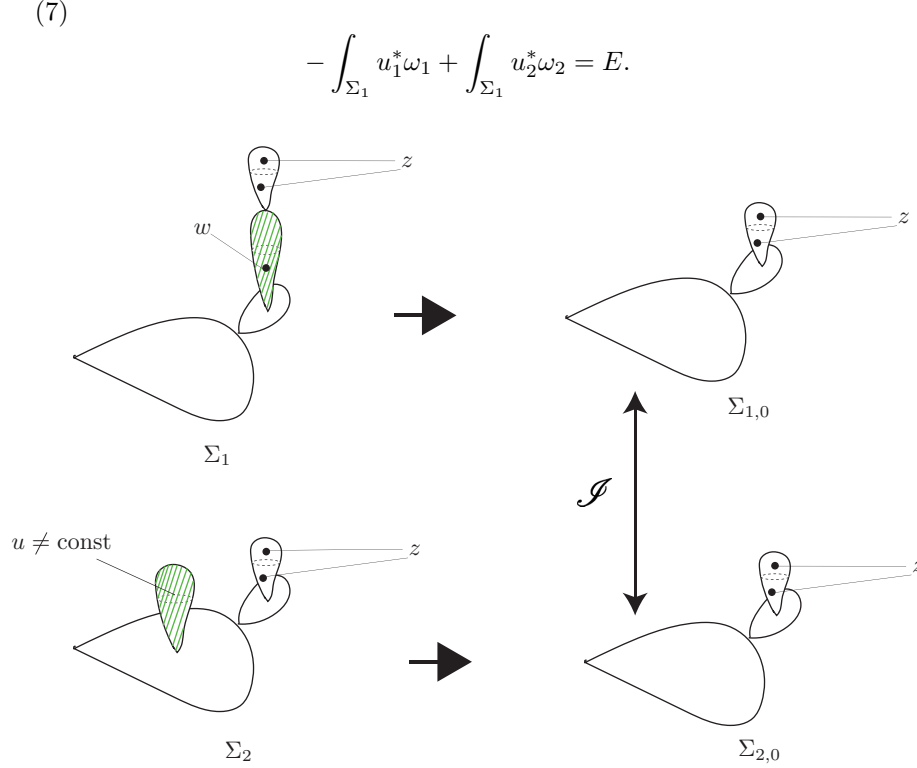

FIGURE 59. Source curve of an element of $\mathcal{M}'_{\ell, \ell_1, \ell_2}(L_{12}; \vec{a}; E)$.

We call $z_{i,j}^{\text{int}}$ an *interior marked point of first kind* and $w_{i,j}^{\text{int}}$ an *interior marked point of second kind*.

We denote by $\mathcal{M}'_{\ell, \ell_1, \ell_2}(L_{12}; \vec{a}; E)$ the set of the equivalence classes of such objects with respect to the equivalence relation \sim defined in Definition 12.9. \diamond

Condition 12.8. For each j

$$\left(\lim_{z \in \partial \Sigma_1, z \uparrow z_{1,j}} \gamma(z), \lim_{z \in \partial_1 \Sigma, z \downarrow z_{1,j}} \gamma(z) \right) \in L_{12}(a_{1,j}).$$

\diamond

Definition 12.9. Let $\xi = (((\Sigma_1, \vec{z}_1, \vec{z}_1^{\text{int}}, \vec{w}_1^{\text{int}}), u_1), ((\Sigma_2, \vec{z}_2, \vec{z}_2^{\text{int}}, \vec{w}_2^{\text{int}}), u_2), \mathcal{I}, \gamma)$ and $\xi' = (((\Sigma'_1, \vec{z}'_1, \vec{z}'_1{}^{\text{int}}, \vec{w}'_1{}^{\text{int}}), u'_1), ((\Sigma'_2, \vec{z}'_2, \vec{z}'_2{}^{\text{int}}, \vec{w}'_2{}^{\text{int}}), u'_2), \mathcal{I}', \gamma')$ be objects satisfying (1)-(5) of Definition 12.7.

A *weak isomorphism* from ξ to ξ' is a pair of maps (ψ_1, ψ_2) with the following properties.

- (1) The map $\psi_i : \Sigma_i \rightarrow \Sigma'_i$ is biholomorphic.
- (2) $\psi_i(z_{i,j}) = z'_{i,j}$.
- (3) There exist permutations $\sigma : \{1, \dots, \ell\} \rightarrow \{1, \dots, \ell\}$, $\sigma_i : \{1, \dots, \ell_i\} \rightarrow \{1, \dots, \ell_i\}$ such that $\psi_i(z_{i,j}^{\text{int}}) = z'_{i, \sigma(j)}{}^{\text{int}}$, and that $\psi_i(w_{i,j}^{\text{int}}) = w'_{i, \sigma_i(j)}{}^{\text{int}}$, for $i = 1, 2$.
- (4) $u'_i \circ \psi_i = u_i$ for $i = 1, 2$.

(5) Note that (1)-(3) above implies that ψ_i induces a map $\bar{\psi}_i : \Sigma_i^0 \rightarrow \Sigma_i'^0$. We require: $\mathcal{S}' \circ \bar{\psi}_1 = \bar{\psi}_2 \circ \mathcal{S}$ on Σ_1^0 .

A weak isomorphism (ψ_1, ψ_2) is said to be an *isomorphism* if σ and σ_i in item (3) are the identity maps.

We say ξ is *equivalent* to ξ' and write $\xi \sim \xi'$ if there exists an isomorphism from ξ to ξ' . \diamond

Definition 12.10. An object ξ satisfying (1)-(5) of Definition 12.7 is said to be *stable* if the set of isomorphisms from ξ to ξ is finite.

We say ξ is *source stable* if the set of (ψ_1, ψ_2) which satisfies (1), (2), (3), (5) of Definition 12.9 (but not necessary (4)), is finite. \diamond

Remark 12.11. We consider $(((\Sigma_1, \bar{z}_1, \bar{z}_1^{\text{int}}, \bar{w}_1^{\text{int}}), u_1), ((\Sigma_2, \bar{z}_2, \bar{z}_2^{\text{int}}, \bar{w}_2^{\text{int}}), u_2), \mathcal{S}, \gamma)$ such that there exists an unstable disk component $\Sigma_1(a)$ of Σ_1 on which u_1 is constant. Such an object can still be stable in the sense of Definition 12.10. In fact if u_2 is non-constant on $\Sigma_2(a) = \mathcal{S}(\Sigma_1(a))$ then by condition Definition 12.10 (4) there is no continuous family of automorphisms supported on this component. \diamond

Example 12.12. We consider the situation of Example 12.2. The element η corresponds in our compactification to an element η' from the domain as in Figure 60. $\Sigma_{1,0} \cong \Sigma_{2,0}$ is a disk in this case and \mathcal{S} is the identity map. u_1, u_2 are defined on the sphere bubbles rooted on $\Sigma_{1,0}, \Sigma_{2,0}$, respectively. By the definition of our equivalence relation the object is equivalent if we replace u_2 by $u_2 \circ v$. Here $v : S^2 \rightarrow S^2$ is a biholomorphic map which preserves the point 0 where sphere bubble is attached. Therefore the problem mentioned in Example 12.2 disappears.

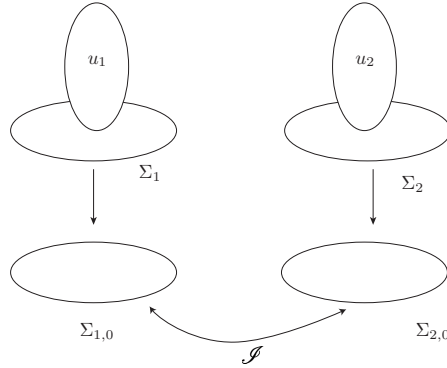

FIGURE 60. Element η' .

Let

$$\mathbf{i} = (\mathbf{i}_0, \mathbf{i}_1, \mathbf{i}_2), \quad \mathbf{i}_0 : \{1, \dots, \ell\} \rightarrow \{1, \dots, \ell'\}, \quad \mathbf{i}_i : \{1, \dots, \ell_i\} \rightarrow \{1, \dots, \ell'_i\} \quad (12.6)$$

be a triple of injective maps. It induces a forgetful map

$$\mathbf{i}^* : \mathcal{M}'_{\ell', \ell'_1, \ell'_2}(L_{12}; \bar{a}; E) \rightarrow \mathcal{M}'_{\ell, \ell_1, \ell_2}(L_{12}; \bar{a}; E), \quad (12.7)$$

as follows.

Let $(((\Sigma_1, \bar{z}_1, \bar{z}_1^{\text{int}}, \bar{w}_1^{\text{int}}), u_1), ((\Sigma_2, \bar{z}_2, \bar{z}_2^{\text{int}}, \bar{w}_2^{\text{int}}), u_2), \mathcal{S}, \gamma) \in \mathcal{M}'_{\ell'}(L_{12}; \bar{a}; E)$. We put

$$z_{i,j}^{\text{int}'} = z_{i, \mathbf{i}(j)}^{\text{int}}, \quad w_{i,j}^{\text{int}'} = w_{i, \mathbf{i}(j)}^{\text{int}}$$

We consider $\xi = (((\Sigma_1, \vec{z}_1, \vec{z}_1^{\text{int}'}, \vec{w}_1^{\text{int}'}, u_1), ((\Sigma_2, \vec{z}_2, \vec{z}_2^{\text{int}'}, \vec{w}_2^{\text{int}'}, u_2), \mathcal{S}, \gamma)$. We shrink components such that there are infinitely many automorphisms supported on it and obtain $\xi' = (((\Sigma'_1, \vec{z}'_1, \vec{z}'_1{}^{\text{int}'}, \vec{w}'_1{}^{\text{int}'}, u_1), ((\Sigma'_2, \vec{z}'_2, \vec{z}'_2{}^{\text{int}'}, \vec{w}'_2{}^{\text{int}'}, u_2), \mathcal{S}', \gamma')$. We define

$$i^*(\xi) = \xi'.$$

Definition 12.13. Let $\xi = (((\Sigma_1, \vec{z}_1, \vec{z}_1^{\text{int}}, \vec{w}_1^{\text{int}}, u_1), ((\Sigma_2, \vec{z}_2, \vec{z}_2^{\text{int}}, \vec{w}_2^{\text{int}}, u_2), \mathcal{S}, \gamma)$ be an element of $\mathcal{M}'_{\ell, \ell_1, \ell_2}(L_{12}; \vec{a}; E)$.

We say an element $\xi' = (((\Sigma'_1, \vec{z}'_1, \vec{z}'_1{}^{\text{int}'}, \vec{w}'_1{}^{\text{int}'}, u'_1), ((\Sigma'_2, \vec{z}'_2, \vec{z}'_2{}^{\text{int}'}, \vec{w}'_2{}^{\text{int}'}, u'_2), \mathcal{S}', \gamma')$ of $\mathcal{M}'_{\ell, \ell_1, \ell_2}(L_{12}; \vec{a}; E)$ is a *source stabilization* of ξ if the following holds.

- (1) There exists i as in (12.6) such that $i^*(\xi') = \xi$.
- (2) For any isomorphism $(\psi_1, \psi_2) : \xi \rightarrow \xi$ there exists an weak isomorphism $(\psi'_1, \psi'_2) : \xi' \rightarrow \xi'$ such that the next diagram commutes.

$$\begin{array}{ccc} \Sigma'_i & \xrightarrow{\psi'_i} & \Sigma'_i \\ \downarrow & & \downarrow \\ \Sigma_i & \xrightarrow{\psi_i} & \Sigma_i \end{array} \quad (12.8)$$

where the vertical arrows are the maps shrinking unstable sphere components.

- (3) The element ξ' is source stable.

We call an interior marked point of ξ an *added marked point* if it does not correspond to a marked point of ξ' . (There are $\ell - \ell' + \ell_i - \ell'_i$ added marked points on each Σ_i ($i = 1, 2$).) \diamond

We next define a topology, *stable map topology*, on $\mathcal{M}'_{\ell}(L_{12}; \vec{a}; E)$, in a similar way as [FOn, Definition 10.3], as follows.

We first consider the case of elements

$$\xi = (((\Sigma_1, \vec{z}_1, \vec{z}_1^{\text{int}}, \vec{w}_1^{\text{int}}, u_1), ((\Sigma_2, \vec{z}_2, \vec{z}_2^{\text{int}}, \vec{w}_2^{\text{int}}, u_2), \mathcal{S}, \gamma)$$

and

$$\begin{aligned} \xi(k) = & (((\Sigma_1(k), \vec{z}_1(k), \vec{z}_1^{\text{int}}(k), \vec{w}_1^{\text{int}}(k), u_1(k)), \\ & ((\Sigma_2(k), \vec{z}_2(k), \vec{z}_2^{\text{int}}(k), \vec{w}_2^{\text{int}}(k), u_2(k)), \mathcal{S}(k), \gamma(k)) \end{aligned}$$

of $\mathcal{M}'_{\ell}(L_{12}; \vec{a}; E)$ such that ξ and $\xi(k)$ are all source stable. In such case we define:

Definition 12.14. We say

$$\lims_{k \rightarrow \infty} \xi(k) = \xi$$

if the following holds.

- (1) $(\Sigma_i(k), \vec{z}_i(k), \vec{z}_i^{\text{int}}(k), \vec{w}_i^{\text{int}}(k))$ converges to $(\Sigma_i, \vec{z}_i, \vec{z}_i^{\text{int}}, \vec{w}_i^{\text{int}})$ as $k \rightarrow \infty$ in the moduli space of bordered marked nodal curves, for $i = 1, 2$.
- (2) Let $\mathfrak{N}_i(\epsilon)$ be the ϵ neighborhood of the set of the nodal points of Σ_i . Using a universal family of nodal marked bordered curves together with item (1) we take a smooth embedding

$$\mathfrak{J}_{i,k} : \Sigma_i \setminus \mathfrak{N}_i(\epsilon) \rightarrow \Sigma_i(k),$$

such that it converges to the identity map as k goes to infinity. (Here we regard $\Sigma_i(k)$ as a subset of the total space of the universal family.)

Moreover:

- (a) $\mathfrak{J}_{i,k}(z_{i,j}) = z_{i,j}(k)$.

$$(b) \mathcal{J}_{i,k}(z_{i,j}^{\text{int}}) = z_{i,j}^{\text{int}}(k).$$

$$(c) \mathcal{J}_{i,k}(w_{i,j}^{\text{int}}) = w_{i,j}^{\text{int}}(k).$$

(3) For any small $\epsilon > 0$ we have

$$\lim_{k \rightarrow \infty} \sup \{d(u_i(k)(\mathcal{J}_{i,k}(z)), u_i(z)) \mid z \in \Sigma_i \setminus \mathfrak{N}_i(\epsilon)\} = 0.$$

(4) There exist $\epsilon_k \rightarrow 0$, $\delta_k \rightarrow 0$ such that for each connected component $S_{i,a}(k)$ of $\Sigma_i(k) \setminus \mathcal{J}_{i,k}(\Sigma_i \setminus \mathfrak{N}_i(\epsilon_k))$ we have

$$\text{Diam } S_{i,a}(k) \leq \delta_k.$$

(5) We may choose $\mathfrak{N}_i(\epsilon_k)$ and $\epsilon_k \rightarrow 0$ with the following property. Let $\overline{\mathfrak{N}}_i(\epsilon_k)$ be the image of $\mathfrak{N}_i(\epsilon_k)$ in Σ_i^0 . Then

$$\mathcal{J}(\overline{\mathfrak{N}}_1(\epsilon_k) \cap \Sigma_1^0) \subseteq \overline{\mathfrak{N}}_2(\epsilon_k) \cap \Sigma_2^0.$$

Now we require

$$\lim_{k \rightarrow \infty} \sup \{d(\mathcal{J}(k)(\mathcal{J}_{1,k}(z)), \mathcal{J}_{2,k}(\mathcal{J}(z))) \mid z \in \Sigma_1 \setminus \mathfrak{N}_1(\epsilon_k)\} = 0.$$

◇

Remark 12.15. We require C^0 convergence in item (3). Since the maps are pseudo-holomorphic, it implies C^n convergence for any n .

Definition 12.16. Let $\xi, \xi(k) \in \mathcal{M}'_{\ell, \ell_1, \ell_2}(L_{12}; \vec{a}; E)$. We say

$$\lim_{k \rightarrow \infty} \xi(k) = \xi$$

if there exists ℓ', ℓ'_1, ℓ'_2 , \mathbf{i} as in (12.6) and $\xi^+, \xi(k)^+ \in \mathcal{M}'_{\ell', \ell'_1, \ell'_2}(L_{12}; \vec{a}; E)$ such that:

- (1) $\mathbf{i}^*(\xi^+) = \xi$, $\mathbf{i}^*(\xi(k)^+) = \xi(k)$. Moreover ξ^+ , $\xi(k)^+$ are source stabilizations of ξ , $\xi(k)$, respectively.
- (2) $\lim_{k \rightarrow \infty} \xi^+(k) = \xi^+$.

◇

We will use the next lemma to show that Definition 12.16 determines a topology. (See Lemma 12.19.) Lemma 12.17 is also used during the construction of the Kuranishi structure, in Subsection 12.3.

Lemma 12.17. *Let $\xi \in \mathcal{M}'_{\ell, \ell_1, \ell_2}(L_{12}; \vec{a}; E)$, $\xi^{(1)} \in \mathcal{M}'_{\ell^{(1)}, \ell_1^{(1)}, \ell_2^{(1)}}(L_{12}; \vec{a}; E)$, $\xi^{(2)} \in \mathcal{M}'_{\ell^{(2)}, \ell_1^{(2)}, \ell_2^{(2)}}(L_{12}; \vec{a}; E)$. Suppose that $\mathbf{i}_{(1)}^* \xi^{(1)} = \mathbf{i}_{(2)}^* \xi^{(2)} = \xi$ for some forgetful maps $\mathbf{i}_{(1)}$, $\mathbf{i}_{(2)}$.*

We assume that $\xi^{(1)}$, $\xi^{(2)}$ are source stable. Let $\xi^{(2)}(k)$ be a sequence of source stable objects such that $\lim_{k \rightarrow \infty} \xi^{(2)}(k) = \xi^{(2)}$.

Then there exists a sequence of elements $\xi^{(1)}(k)$ which are source stable and such that

$$\mathbf{i}_{(1)}^*(\xi^{(1)}(k)) = \mathbf{i}_{(2)}^*\xi^{(2)}(k)$$

and

$$\lim_{k \rightarrow \infty} \xi^{(1)}(k) = \xi^{(1)}.$$

◇

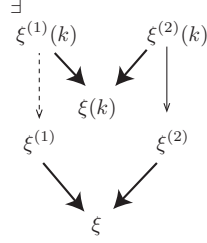

FIGURE 61. $\xi^{(i)}$ and $\xi^{(i)}(k)$ in Lemma 12.17

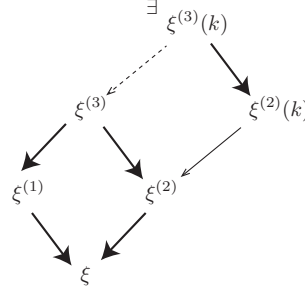

FIGURE 62. $\xi^{(i)}$ and $\xi^{(i)}(k)$ in the claim

Proof. We claim that there exist $\xi^{(3)}, \xi^{(3)}(k)$ such that

$$\lim_{k \rightarrow \infty} \xi^{(3)}(k) = \xi^{(3)}$$

and $i_{(32)}^* \xi^{(3)} = \xi^{(2)}$, $i_{(31)}^* \xi^{(3)} = \xi^{(1)}$, $i_{(32)}^* \xi^{(3)}(k) = \xi^{(2)}(k)$. Here $i_{(32)}^*, i_{(31)}^*$ are appropriate forgetful maps. (During the proof of this claim we do not use the assumption that $\xi^{(1)}$ is source stable.)

The proof of this claim is by an induction on the number of added marked points of $\xi^{(1)}$. We put

$$\xi^{(i)} = (((\Sigma_1^{(i)}, \bar{z}_1^{(i)}, \bar{z}_1^{(i), \text{int}}, \bar{w}_1^{(i), \text{int}}, u_1^{(i)}), ((\Sigma_2^{(i)}, \bar{z}_2^{(i)}, \bar{z}_2^{(i), \text{int}}, \bar{w}_2^{(i), \text{int}}, u_2), \mathcal{S}^{(i)}, \gamma^{(i)}),$$

for $i = 1, 2$ and

$$\begin{aligned} \xi^{(2)}(k) &= (((\Sigma_1^{(2)}(k), \bar{z}_1^{(2)}(k), \bar{z}_1^{(2), \text{int}}(k), \bar{w}_1^{(2), \text{int}}(k), u_1^{(2)}(k)), \\ &\quad ((\Sigma_2^{(2)}(k), \bar{z}_2^{(i)}(k), \bar{z}_2^{(i), \text{int}}(k), \bar{w}_2^{(2), \text{int}}(k), u_2(k)), \mathcal{S}^{(2)}(k), \gamma^{(2)}(k)), \\ \xi &= (((\Sigma_1, \bar{z}_1, \bar{z}_1^{\text{int}}, u_1), ((\Sigma_2, \bar{z}_2, \bar{z}_2^{\text{int}}, \bar{w}_2^{\text{int}}, u_2), \mathcal{S}, \gamma). \end{aligned}$$

Suppose the number of added marked point is one. We consider the case when the added marked point is of type 2 and is $w_1^{(1), \text{int}}$ in Σ_1 . (The other cases are similar and so are omitted.)

Note that there are holomorphic maps $\pi_j^{(i)} : \Sigma_j^{(i)} \rightarrow \Sigma_j$, which shrink certain irreducible components.

Case 1: We assume that the irreducible component containing $w_1^{(1), \text{int}}$ is not shrunk by $\pi_1^{(1)} : \Sigma_1^{(1)} \rightarrow \Sigma_1$.

Case 1-1: Suppose $\pi_1^{(1)}(w_1^{(1), \text{int}})$ is not in the image of a nodal or a marked point of $\Sigma_1^{(2)}$. There exists a point \hat{w} in $\Sigma_1^{(2)}$ which goes to $\pi_1^{(1)}(w_1^{(1), \text{int}})$ by $\pi_1^{(2)}$. The point \hat{w} is not nodal or marked. We add \hat{w} as an extra added marked point to $\Sigma_1^{(2)}$ to obtain $\xi^{(3)}$. We then take one marked point $\hat{w}(k)$ on $\Sigma_1^{(2)}(k)$ for each k , which is ‘close’ to \hat{w} and add $\hat{w}(k)$ to $\xi^{(2)}(k)$ to obtain $\xi^{(3)}(k)$ such that $\lim_{k \rightarrow \infty} \xi^{(3)}(k) \rightarrow \xi^{(3)}$. It is easy to see that $\xi^{(3)}$ and $\xi^{(3)}(k)$ have the required properties.

Case 1-2: Suppose $\pi_1^{(1)}(w_1^{(1), \text{int}})$ is the image of a marked point w' of $\Sigma_1^{(2)}$. We add a sphere bubble S at w' to $\Sigma_1^{(2)}$ and add one marked point \hat{w} on this bubble. (Then the sphere component S has one node and two marked points. One of the two marked points corresponds to w' and the other is \hat{w} .) We thus obtain $\xi^{(3)}$. (See

Figure 63.) We consider $\Sigma_1^{(2)}(k)$. We take the marked point $w'(k)$ corresponding

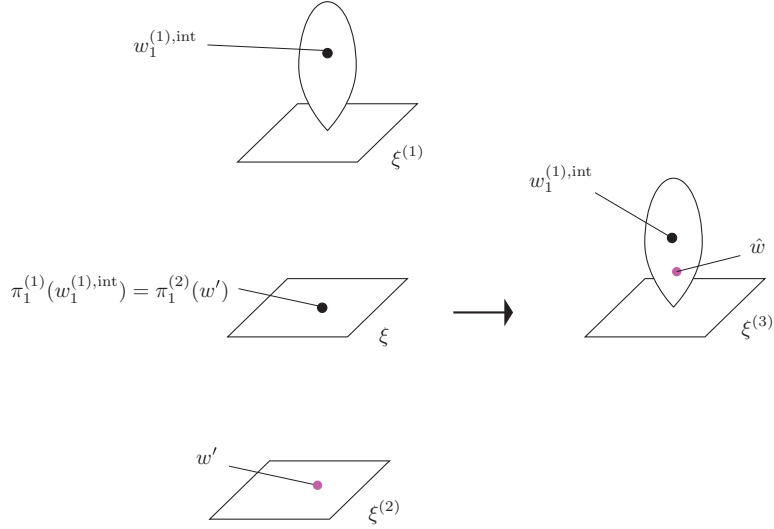

FIGURE 63. Case 1-2

to w' . We add a sphere bubble $S(k)$ at $w'(k)$ and a marked point $\hat{w}(k)$ on $S(k)$. We thus obtain $\xi^{(3)}(k)$ in the same way. It is easy to see that $\xi^{(3)}$, $\xi^{(3)}(k)$ have the required property.

Case 1-3: Suppose $\pi_1^{(1)}(w_1^{(1),int})$ is in the image of a node x of $\Sigma_1^{(2)}$. We add a sphere bubble at x to $\Sigma_1^{(2)}$ and add one marked point on this bubble. (Then this sphere component has two nodal points and one marked point.) We thus obtain $\xi^{(3)}$. (See Figure 64.) We consider $\Sigma_1^{(2)}(k)$. There are two cases. If there is a nodal

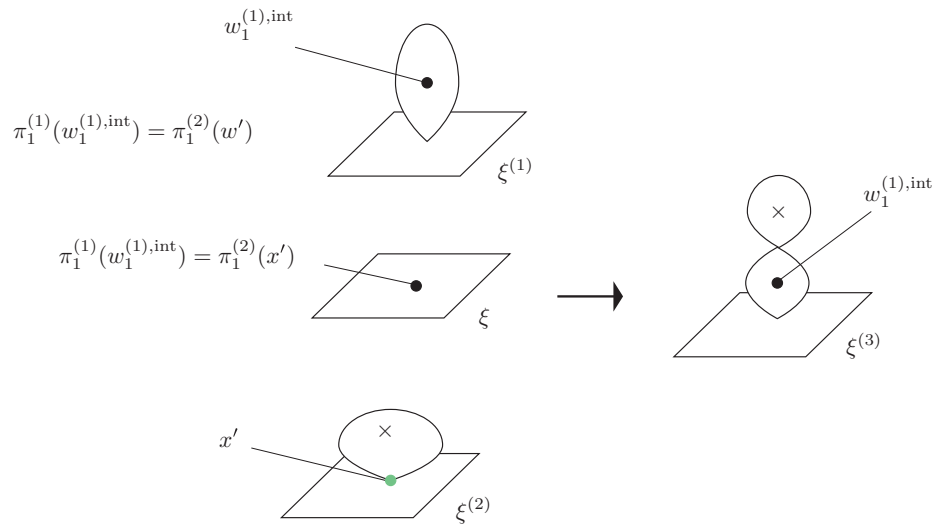

FIGURE 64. Case 1-3

point $x(k)$ corresponding to x in $\Sigma_1^{(2)}(k)$ then we add a sphere bubble $S(k)$ at $x(k)$ and do the same construction as above to obtain $\xi^{(3)}(k)$. If there is no nodal point in $\Sigma_1^{(2)}(k)$ corresponding to x , then there is a ‘neck region’ corresponding to x . We add a marked point in this neck region to obtain $\xi^{(3)}(k)$. (See Figure 65.) It is easy

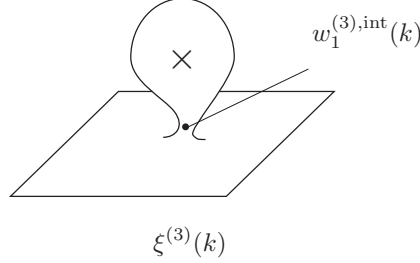

FIGURE 65. Put a marked point on the neck region

to see that $\xi^{(3)}$, $\xi^{(3)}(k)$ have the required property.

We remark that Case 1-2 and Case 1-3 can occur at the same time. Also the marked point w' in Case 1-2 or a node x in Case 1-3 may not be unique. We can take any of such choices to prove the claim in those cases.

Case 2: We assume that the component containing $w_1^{(1),\text{int}}$ is shrunk by $\pi_1^{(1)} : \Sigma_1^{(1)} \rightarrow \Sigma_1$.

We consider the point $\pi_1^{(1)}(w_1^{(1),\text{int}}) \in \Sigma_1$. We consider three subcases.

Case 2-1: $\pi_1^{(1)}(w_1^{(1),\text{int}}) \in \Sigma_1$ is not in the image of a nodal or a marked point of $\Sigma_1^{(2)}$. The construction is the same as Case 1-1.

Case 2-2: $\pi_1^{(1)}(w_1^{(1),\text{int}}) \in \Sigma_1$ is in the image of a marked point of $\Sigma_1^{(2)}$. The construction is the same as Case 1-2.

Case 2-3: $\pi_1^{(1)}(w_1^{(1),\text{int}}) \in \Sigma_1$ is not in the image of a nodal point of $\Sigma_1^{(2)}$. The construction is the same as Case 1-3.

We thus proved the claim in the case when the number of added marked points in $\xi^{(1)}$ is 1.

Now we prove the claim by the induction of the number n of added marked points in $\xi^{(1)}$. (Such an induction is possible since during the proof of this claim we do not use the assumption that $\xi^{(1)}$ is source stable.)

The case $n = 1$ is already proved. Suppose the claim is proved for $n - 1$. We remove one added marked point from $\xi^{(1)}$ and obtain $\xi^{(1),-}$. We apply induction hypothesis to obtain $\xi^{(3)-}$, $\xi^{(3)-}(k)$.

Now we apply the case $n = 1$ taking $\xi^{(1)}$, $\xi^{(3)-}$, $\xi^{(3)-}(k)$ as $\xi^{(1)}$, $\xi^{(2)}$, $\xi^{(2)}(k)$. It implies the claim in the case of n .

We have thus proved the claim.

We remark $i_{(31)}^*(\xi^{(3)}) = \xi^{(1)}$. Namely $\xi^{(1)}$ is obtained by forgetting certain marked points of $\xi^{(3)}$. We forget the corresponding marked points of $\xi^{(3)}(k)$ and obtain $\xi^{(1)}(k)$. Since $\xi^{(1)}$ is source stable $\xi^{(1)}(k)$ is source stable for sufficiently large k . Then $\lim_{k \rightarrow \infty} \xi^{(3)}(k) = \xi^{(3)}$ implies $\lim_{k \rightarrow \infty} \xi^{(1)}(k) = \xi^{(1)}$. Since $i_{(32)}^*(\xi^{(3)}(k)) = \xi^{(2)}(k)$ we have $i_{(1)}^*(\xi^{(1)}(k)) = i_{(2)}^*(\xi^{(2)}(k))$. The proof of the lemma is complete. \square

Note that we proved the next lemma also during the proof of the claim in the proof of Lemma 12.17.

Lemma 12.18. *Let $\xi \in \mathcal{M}'_{\ell, \ell_1, \ell_2}(L_{12}; \vec{a}; E)$, $\xi^{(1)} \in \mathcal{M}'_{\ell^{(1)}, \ell_1^{(1)}, \ell_2^{(1)}}(L_{12}; \vec{a}; E)$, $\xi^{(2)} \in \mathcal{M}'_{\ell^{(2)}, \ell_1^{(2)}, \ell_2^{(2)}}(L_{12}; \vec{a}; E)$. Suppose that $\mathfrak{i}_{(1)}^*(\xi^{(1)}) = \mathfrak{i}_{(2)}^*(\xi^{(2)}) = \xi$ for some $\mathfrak{i}_{(1)}, \mathfrak{i}_{(2)}$.*

Then there exists $\xi^{(3)} \in \mathcal{M}'_{\ell^{(3)}, \ell_1^{(3)}, \ell_2^{(3)}}(L_{12}; \vec{a}; E)$ where $\ell_i^{(3)} = \ell_i^{(1)} + \ell_i^{(2)} - \ell_i$, such that

$$\mathfrak{i}_{(3,1)}^*(\xi^{(3)}) = \xi^{(1)}, \quad \mathfrak{i}_{(3,2)}^*(\xi^{(3)}) = \xi^{(2)}.$$

Here $\mathfrak{i}_{(3,1)}^, \mathfrak{i}_{(3,2)}^*$ are appropriate forgetful maps. \diamond*

We now show that Definition 12.16 determines a topology on $\mathcal{M}'(L_{12}; \vec{a}; E)$. For a subset $A \subset \mathcal{M}'(L_{12}; \vec{a}; E)$ we define its closure A^c as the set of all elements ξ such that there exists a sequence $\xi(k) \in A$ which converges to ξ in the sense of Definition 12.16. Using Kuratowski's Theorem (See for example [Kel, Chapter 1 Theorem 8].) it suffices to show the next lemma to prove the existence of the topology on $\mathcal{M}'(L_{12}; \vec{a}; E)$ for which $A \mapsto A^c$ becomes the process taking the closure.

Lemma 12.19. *The following 4 properties are satisfied. (a) $\emptyset^c = \emptyset$. (b) $A \subseteq A^c$. (c) $A^{cc} = A^c$. (d) $(A \cup B)^c = A^c \cup B^c$. \diamond*

Proof. (a)(b)(d) are trivial to check. We verify (c). Let $\xi(i) \in A^c$ which converges to $\xi \in A^{cc}$. We take $\xi(i, j) \in A$ such that $\lim_{j \rightarrow \infty} \xi(i, j) = \xi(i)$. It suffices to find j_i such that $\lim_{i \rightarrow \infty} \xi(i, j_i) = \xi$.

Using Lemma 12.17 we may assume that $\xi, \xi(i), \xi(i, j)$ are all source stable. Let $\Sigma, \Sigma(i), \Sigma(i, j)$ be the source curves of $\xi, \xi(i), \xi(i, j)$ and $u, u_i, u_{i,j}$ are maps on them, respectively.

Let $\epsilon > 0$ be an arbitrary positive number. We take sufficiently small neck of Σ such that the diameter of the image by u of each of the neck is smaller than ϵ . Let Σ_0 be the complement of the neck. We are given embedding of Σ_0 to $\Sigma(i)$ and to $\Sigma(i, j)$.

By Definition 12.14 there exists I such that if $i \in I$ then the diameter of each of the u_i image of connected component of $\Sigma(i) \setminus \Sigma_0$ is smaller than 2ϵ . Moreover there exists J_i such that if $i > I, j > J_i$ then the diameter $u_{i,j}$ image of each of connected component of $\Sigma(i, j) \setminus \Sigma_0$ is smaller than 3ϵ .

By Definition 12.14 again there exists I' such that if $i \in I'$ then the C^2 distance between $u_i|_{\Sigma_0}$ and $u|_{\Sigma_0}$ is smaller than ϵ . Moreover there exists J'_i such that if $i > I', j > J'_i$ then the C^2 distance between $u_{i,j}|_{\Sigma_0}$ and $u|_{\Sigma_0}$ is smaller than 2ϵ .

This implies that if $j_i > \max J_i, J'_i$ then $\xi(i, j_i)$ converges to ξ in the sense of Definition 12.14. This proves (c). \square

In (3.28) we defined a compactification $\mathcal{M}(L_{12}; \vec{a}; E)$, whose element is a bordered stable map with boundary marked points, switching specified by \vec{a} and with energy E . We can include interior marked points and define $\mathcal{M}_\ell(L_{12}; \vec{a}; E)$. The way to include interior marked points is the same as [FOOO1, Definition 2.1.24] and so its detail is omitted.

Lemma-Definition 12.20. *We can define the forgetful map*

$$\mathfrak{fg} : \mathcal{M}_{\ell+\ell_1+\ell_2}(L_{12}; \vec{a}; E) \rightarrow \mathcal{M}'_{\ell, \ell_1, \ell_2}(L_{12}; \vec{a}; E)$$

which is continuous. \diamond

Proof. Let $((\Sigma, \vec{z}, \vec{z}^{\text{int}} \cup \vec{w}_1^{\text{int}} \cup \vec{w}_2^{\text{int}}), u, \gamma)$ be an element of $\mathcal{M}_{\ell+\ell_1+\ell_2}(L_{12}; \vec{a}; E, \gamma)$. Here $(\Sigma, \vec{z}, \vec{z}^{\text{int}} \cup \vec{w}_1^{\text{int}} \cup \vec{w}_2^{\text{int}})$ is a bordered nodal marked curve of genus zero with one boundary component. (\vec{z} are boundary marked points, \vec{z}^{int} are first ℓ interior marked points, $\vec{w}_1^{\text{int}} = (w_{1,1}^{\text{int}}, \dots, w_{1,\ell_1}^{\text{int}})$ are next ℓ_1 interior marked points and $\vec{w}_2^{\text{int}} = (w_{2,1}^{\text{int}}, \dots, w_{2,\ell_2}^{\text{int}})$ are last ℓ_2 interior marked points.) The map $u : (\Sigma, \partial\Sigma) \rightarrow (-X_1 \times X_2, L_{12})$ is pseudo-holomorphic and $\gamma : \partial\Sigma \setminus \vec{z} \rightarrow \tilde{L}_{12}$ is a lift of the restriction of u .

We put $u = (u_1, u_2)$, where u_i is a map to X_i from Σ . We consider $((\Sigma, \vec{z}, \vec{z}^{\text{int}} \cup \vec{w}_i^{\text{int}}), u_i)$ for $i = 1, 2$

We remark that, for $i = 1$, we forget the marked points \vec{w}_2^{int} and, for $i = 2$, we forget the marked points \vec{w}_1^{int} .

We shrink unstable sphere components of $((\Sigma, \vec{z}, \vec{z}^{\text{int}} \cup \vec{w}_i^{\text{int}}), u_i)$. Here an unstable sphere component of $((\Sigma, \vec{z}, \vec{z}^{\text{int}} \cup \vec{w}_i^{\text{int}}), u_i)$ is an unstable sphere component of the source curve $(\Sigma, \vec{z}, \vec{z}^{\text{int}} \cup \vec{w}_i^{\text{int}})$ on which u_i is constant. We denote by $((\Sigma_i, \vec{z}_i, \vec{z}_i^{\text{int}} \cup \vec{w}_i^{\text{int}}), u_i)$ the pair of a bordered marked curve and a map obtained by this shrinking.

We next forget \vec{w}_i^{int} and let $(\Sigma_i^0, \vec{z}_i, \vec{z}_i^{\text{int}})$ be the bordered marked curve obtained from $(\Sigma_i, \vec{z}_i, \vec{z}_i^{\text{int}})$ by shrinking all the unstable sphere components.

We remark that $(\Sigma_1^0, \vec{z}_1, \vec{z}_1^{\text{int}})$ is canonically isomorphic to $(\Sigma_2^0, \vec{z}_2, \vec{z}_2^{\text{int}})$. In fact they both are obtained by shrinking all the unstable sphere components of $(\Sigma, \vec{z}, \vec{z}^{\text{int}})$. Therefore we obtain a biholomorphic map

$$\mathcal{S} : (\Sigma_1^0, \vec{z}_1, \vec{z}_1^{\text{int}}) \rightarrow (\Sigma_2^0, \vec{z}_2, \vec{z}_2^{\text{int}}).$$

We define

$$\begin{aligned} & \text{fg}((\Sigma, \vec{z}, \vec{z}^{\text{int}} \cup \vec{w}_1^{\text{int}} \cup \vec{w}_2^{\text{int}}), u, \gamma) \\ &= (((\Sigma_1, \vec{z}_1, \vec{z}_1^{\text{int}} \cup \vec{w}_1^{\text{int}}), u_1), ((\Sigma_2, \vec{z}_2, \vec{z}_2^{\text{int}} \cup \vec{w}_2^{\text{int}}), u_2), \mathcal{S}, \gamma). \end{aligned} \quad (12.9)$$

Note that we regard the interior marked points \vec{z}_i^{int} as interior marked points of first kind and \vec{w}_i^{int} as interior marked points of second kind.

The continuity of the map is easy to show from the definition. \square

Example 12.21. We consider the case when L_{12} is embedded and \vec{a} consists of one element which corresponds to the diagonal component. We define an element $(((\Sigma_1, z_1), u_1), ((\Sigma_2, z_2), u_2), \mathcal{S}, \gamma)$ of $\mathcal{M}'_{0,0,0}(L_{12}; \vec{a}; E)$ as follows.

$\Sigma = \Sigma_1 = \Sigma_2$ is obtained by gluing the disk D^2 with S^2 at $0 \in D^2$ and $\infty \in S^2 \cong \mathbb{C} \cup \{\infty\}$. We take $z_1 = z_2 = 1 \in \partial D^2$ as the (boundary) marked point. We take a holomorphic map

$$u : (\Sigma, \partial\Sigma) \rightarrow (-X_1 \times X_2, L_{12}).$$

We denote its restriction to D^2 by $u^{\text{d}} = (u_1^{\text{d}}, u_2^{\text{d}})$. (Here u_i^{d} is a map to X_i .) We denote its restriction to S^2 by $u^{\text{s}} = (u_1^{\text{s}}, u_2^{\text{s}})$.

$u_i : \Sigma_i \rightarrow X_i$ is a map which is u_i^{d} on D^2 and is u_i^{s} on S^2 .

Note Σ_i^0 (in the sense appearing in Definition 12.7 (3)) is D^2 in this case. Let $\mathcal{S} : \Sigma_1^0 \rightarrow \Sigma_2^0$ be the identity map.

We put $\gamma = u^{\text{s}}|_{\partial\Sigma}$.

We thus obtain $\xi = (((\Sigma_1, z_1), u_1), ((\Sigma_2, z_2), u_2), \mathcal{S}, \gamma) \in \mathcal{M}'_0(L_{12}; \vec{a}; E)$. See Figure 66.

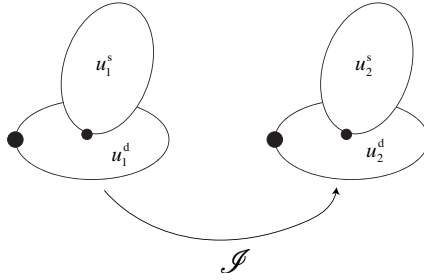
FIGURE 66. $(((\Sigma_1, z_1), u_1), ((\Sigma_2, z_2), u_2), \mathcal{I}, \gamma)$

We describe the fiber $\mathbf{fg}^{-1}(\xi) \subset \mathcal{M}_0(L_{12}; \vec{a}; E)$. It is a real 4 dimensional compact space. For $a \in \mathbb{C} \setminus \{0\}$ and $b \in \mathbb{C}$, we put

$$v_{a,b}(z) = az + b,$$

and

$$u_{a,b}^s = (u_1^s, u_2^s \circ v_{a,b}) : S^2 \rightarrow -X_1 \times X_2.$$

Since ∞ is a fixed point of $v_{a,b}$ we can glue it with u^d to obtain

$$u_{a,b} : (\Sigma, \partial\Sigma) \rightarrow (-X_1 \times X_2, L_{12}).$$

Then $\xi_{a,b} = (((\Sigma, 1), u_{a,b}), \gamma)$ is an element of $\mathcal{M}_0(L_{12}; \vec{a}; E)$ for any a, b and

$$\mathbf{fg}(\xi_{a,b}) = \xi.$$

Those elements are parametrized by $(\mathbb{C} \setminus \{0\}) \times \mathbb{C}$ and consists a non-compact space. See Figure 70.

The other elements of this fiber is described in Figures 67, 68, 69, below.

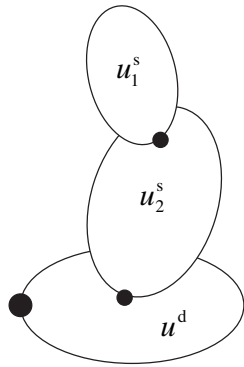

FIGURE 67. First stratum

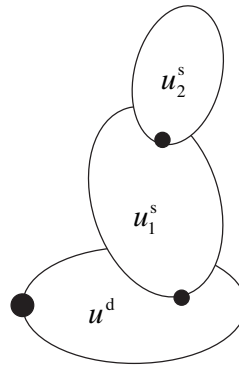

FIGURE 68. Second stratum

Figure 67 shows an element which has two sphere bubbles. The map on the sphere component directly attached to a disk is constant in the X_1 component and the map on the other sphere component is constant in the X_2 component. The element in the fiber $\mathbf{fg}^{-1}(\xi)$ of the form Figure 67 is parametrized by the position

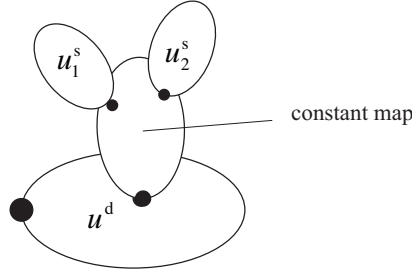

FIGURE 69. Third stratum

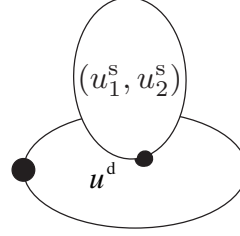

FIGURE 70. Fourth stratum

of the nodal point between two sphere components. So this part of the fiber is identified with \mathbb{C} .

In Figure 68 the role of X_1 and X_2 is exchanged from one in Figure 67. This part of fiber is also identified with \mathbb{C} .

The closures of the parts Figure 67 and Figure 68 intersect at one point that is one drawn in Figure 69. Here the map on one of the sphere components is a constant map.

The elements of the form depicted in Figures 67, 68, 69 together with $\{\xi_{a,b} \mid (a,b) \in (\mathbb{C} \setminus \{0\}) \times \mathbb{C}\}$ consists a compact 4 dimensional space, which is the fiber $\text{fg}^{-1}(\xi)$. \diamond

Proposition 12.22. *The space $\mathcal{M}'_{\ell,\ell_1,\ell_2}(L_{12}; \vec{a}; E)$ is compact and Hausdorff. \diamond*

Proof. The proof is similar to the proof of [FOn, Theorem 11.1] and [FOn, Lemma 10.4] and proceed as follows.

We first prove that the moduli space is sequentially compact.

Let ξ_k be a sequence in $\mathcal{M}'_{\ell,\ell_1,\ell_2}(L_{12}; \vec{a}; E)$. We can add marked points to ξ_k so that it becomes source stable. Since the number of irreducible components of elements of $\mathcal{M}'_{\ell,\ell_1,\ell_2}(L_{12}; \vec{a}; E)$ is bounded, we may assume that the number of marked points we add to ξ_k is independent of k . Therefore to prove the existence of convergent subsequence of ξ_k it suffices to assume that ξ_k are source stable. We assume so below.

Since the moduli space of stable marked curves is compact we may assume that the sequence of source (marked) curves of ξ_k converges. So using the local trivialization of the universal family, we obtain a diffeomorphism between source curves of ξ_k and the limit, outside the neck region. Therefore the maps $u_{k,i}$ ($i = 1, 2$) which is a part of ξ_k can be regarded as a map u_i from Σ_i , the limit curve. If $u_{k,i}$ converges there is nothing to show.

Suppose $u_{k,i}$ does not have a convergent subsequence. Then the first derivative of $u_{k,i}$ diverges somewhere.

If it diverges on a disk component, we can add two interior marked points of the first kinds there in the same way as the proof of [FOn, Theorem 11.1] so that after we perform this replacement finitely many times the sequence of maps $u_{k,i}$ does not diverge on the disk component.

Suppose $u_{k,i}$ diverges on a sphere component. Then we can add two interior marked points of the second kind around that point in the same way as the proof of [FOn, Theorem 11.1] so that after we perform this replacement finitely many times the sequence of maps $u_{k,i}$ does not diverge on the sphere component either.

Thus by adding marked points the sequence of maps $u_{k,i}$ converges. The proof of sequential compactness is complete.

We next prove the Hausdorff-ness. It is easy to see from the definition and Lemma 12.17 that $\mathcal{M}'_{\ell,\ell_1,\ell_2}(L_{12}; \vec{a}; E)$ satisfies the first axiom of countability. Therefore it suffices to show the following. “For each sequence ξ_k in $\mathcal{M}'_{\ell,\ell_1,\ell_2}(L_{12}; \vec{a}; E)$ its limit is unique.” We will prove it below.

Suppose $\lim_{k \rightarrow \infty} \xi_k = \xi$, $\lim_{k \rightarrow \infty} \xi_k = \xi'$. By definition there exists $\hat{\xi}_k, \hat{\xi}'_k, \hat{\xi}, \hat{\xi}'$, such that they are all source stable, $i^*(\hat{\xi}_k) = \xi_k$, $i^*(\hat{\xi}'_k) = \xi_k$, $\lim_{k \rightarrow \infty} \hat{\xi}_k = \hat{\xi}$, $\lim_{k \rightarrow \infty} \hat{\xi}'_k = \hat{\xi}'$ and $i^*(\hat{\xi}) = \xi$, $i^*(\hat{\xi}') = \xi'$. Here i^* are forgetful maps.

By Lemma 12.18, we can find $\hat{\xi}''_k$ such that $i_1^*(\hat{\xi}''_k) = \hat{\xi}_k$, $i_2^*(\hat{\xi}''_k) = \hat{\xi}'_k$ for certain forgetful maps i_1^* and i_2^* .

By taking a subsequence we may assume that $\hat{\xi}''_k$ converges. Let $\hat{\xi}''$ be the limit. Then by the continuity of forgetful map we have $i_1^*(\hat{\xi}'') = \hat{\xi}$, $i_2^*(\hat{\xi}'') = \hat{\xi}'$. $\xi = \xi'$ follows.

To complete the proof it suffices to show the next lemma.

Lemma 12.23. *The space $\mathcal{M}'_{\ell,\ell_1,\ell_2}(L_{12}; \vec{a}; E)$ satisfies the second axiom of countability.*

Proof. The proof is by induction on E . In the case of smallest E for which $\mathcal{M}'_{\ell,\ell_1,\ell_2}(L_{12}; \vec{a}; E)$ is non-empty we have

$$\mathcal{M}'_{\ell,\ell_1,\ell_2}(L_{12}; \vec{a}; E) = \overset{\circ}{\mathcal{M}}_{\ell,\ell_1,\ell_2}(L_{12}; \vec{a}; E).$$

It is easy to see that the right hand side satisfies the second axiom of countability.

Suppose that we have proved that $\mathcal{M}'_{\ell',\ell'_1,\ell'_2}(L_{12}; \vec{a}; E')$ satisfies the second axiom of countability for $E' < E$. We consider the case of E . Note that $\mathcal{M}'_{\ell,\ell_1,\ell_2}(L_{12}; \vec{a}; E)$ has a stratification $S_k \mathcal{M}'_{\ell,\ell_1,\ell_2}(L_{12}; \vec{a}; E)$ by its combinatorial types. We will prove that $S_k \mathcal{M}'_{\ell,\ell_1,\ell_2}(L_{12}; \vec{a}; E)$ satisfies the second axiom of countability by downward induction on k . For the stratum of smallest virtual dimension, $S_k \mathcal{M}'_{\ell,\ell_1,\ell_2}(L_{12}; \vec{a}; E)$ is a fiber product of various $\overset{\circ}{\mathcal{M}}_{\ell',\ell'_1,\ell'_2}(L_{12}; \vec{a}; E')$ with $E' \leq E$, and hence satisfies the second axiom of countability. Suppose we have proved $S_{k+1} \mathcal{M}'_{\ell,\ell_1,\ell_2}(L_{12}; \vec{a}; E)$ satisfies the second axiom of countability. We will study the case of k . As we will prove in Subsection 12.4 later each point p of $S_{k+1} \mathcal{M}'_{\ell,\ell_1,\ell_2}(L_{12}; \vec{a}; E)$ has a Kuranishi neighborhood $(V_p, \mathcal{E}_p, s_p, \psi_p)$. Therefore p has an open neighborhood W_p in $S_k \mathcal{M}'_{\ell,\ell_1,\ell_2}(L_{12}; \vec{a}; E)$ which satisfies the second axiom of countability. In fact W_p is a closed subset of an orbifold. Since $S_{k+1} \mathcal{M}'_{\ell,\ell_1,\ell_2}(L_{12}; \vec{a}; E)$ satisfies the second axiom of countability by induction hypothesis and since it is sequentially compact, we can cover its open neighborhood by a finitely many W_{p_i} . Note that

$$S_k \mathcal{M}'_{\ell,\ell_1,\ell_2}(L_{12}; \vec{a}; E) \setminus \bigcup_i W_{p_i}$$

is sequentially compact and is contained in a fiber product of various $\overset{\circ}{\mathcal{M}}_{\ell',\ell'_1,\ell'_2}(L_{12}; \vec{a}; E')$ for $E' \leq E$. Therefore it is contained in an open subset which satisfies the second axiom of countability.

Thus $S_k \mathcal{M}'_{\ell,\ell_1,\ell_2}(L_{12}; \vec{a}; E)$ is covered by a finitely many open subsets each of which satisfies the second axiom of countability. This implies that $S_k \mathcal{M}'_{\ell,\ell_1,\ell_2}(L_{12}; \vec{a}; E)$ satisfies the second axiom of countability. The proof of Lemma 12.23 is complete. \square

The proof of Proposition 12.22 is now complete. \square

12.3. Kuranishi structure of the compactification $\mathcal{M}'(L_{12}; \vec{a}; E)$. Let $\vec{a} = (a_0, \dots, a_k)$ and let $\xi = (((\Sigma_1, \vec{z}_1, \vec{z}_1^{\text{int}}, \vec{w}_1^{\text{int}}), u_1), ((\Sigma_2, \vec{z}_2, \vec{z}_2^{\text{int}}, \vec{w}_2^{\text{int}}), u_2), \mathcal{S}, \gamma)$ be an element of $\mathcal{M}'(L_{12}; \vec{a}; E)$. We define evaluation maps

$$\begin{aligned} \text{ev} &= (\text{ev}^\partial, \text{ev}^{\text{int.}(1)}, \text{ev}^{\text{int.}(2),1}, \text{ev}^{\text{int.}(2),2}) \\ &: \mathcal{M}'_{\ell, \ell_1, \ell_2}(L_{12}; \vec{a}; E) \rightarrow \prod_{j=0}^k L_{12}(a_j) \times (X_1 \times X_2)^\ell \times X_1^{\ell_1} \times X_2^{\ell_2}, \end{aligned} \quad (12.10)$$

by

$$\begin{aligned} \text{ev}^\partial(\xi) &:= (\gamma_1(z_{1,0}), \dots, \gamma_1(z_{1,k})) \\ \text{ev}^{\text{int.}(1)}(\xi) &:= ((u_1(z_{1,1}^{\text{int}}), u_2(z_{2,1}^{\text{int}})), \dots, (u_1(z_{1,\ell}^{\text{int}}), u_2(z_{2,\ell}^{\text{int}}))) \\ \text{ev}^{\text{int.}(2),i}(\xi) &:= (u_i(w_{i,1}^{\text{int}}), \dots, u_i(w_{i,\ell_i}^{\text{int}})). \end{aligned}$$

Theorem 12.24. *$\mathcal{M}'_{\ell, \ell_1, \ell_2}(L_{12}; \vec{a}; E)$ has a Kuranishi structure. The evaluation map ev^∂ becomes an underlying continuous map of a strongly smooth map. The map, ev_0^∂ , the evaluation map at the 0-th boundary marked point, is weakly submersive. They satisfy the same compatibility conditions as Theorem 3.24.*

Proof. We prove the case of $\mathcal{M}'(L_{12}; \vec{a}; E) = \mathcal{M}'_{0,0,0}(L_{12}; \vec{a}; E)$ below. The general case is similar. (We use the case $\mathcal{M}'(L_{12}; \vec{a}; E)$ only in this paper.) See Remark 12.34.

Most of the proof is similar to the proof of Theorem 3.24, which was given in the reference quoted there. We describe the place where the proof of Theorem 12.24 is different from the proof of Theorem 3.24. Especially we discuss the way how we include the maps \mathcal{S} , which is a part of the data defining an element of $\mathcal{M}'(L_{12}; \vec{a}; E)$ (See Definition 12.7 (3)), in the gluing analysis etc., which we use to construct a Kuranishi chart. The proof occupies this and the next subsections.

For this purpose we review the construction of the Kuranishi structure discussed in various literatures, explaining the places where the construction here is to be modified. Since the most detailed description of the gluing analysis is given in [FOOO12], we follow the description of [FOOO12, Section 8]. (We follow [FOOO9, Part 4] on the discussion about stabilization of the domain since that part is omitted in [FOOO12].)

Let $\xi = (((\Sigma_1, \vec{z}_1, \vec{z}_1^{\text{int}}, \vec{w}_1^{\text{int}}), u_1), ((\Sigma_2, \vec{z}_2, \vec{z}_2^{\text{int}}, \vec{w}_2^{\text{int}}), u_2), \mathcal{S}, \gamma)$ be an element of $\mathcal{M}'_{\ell, \ell_1, \ell_2}(L_{12}; \vec{a}; E)$. We first assume that it is source stable.

Let $\{\Sigma_{i,a}^{\text{d}} \mid a \in \mathbf{comp}_i^{\text{d}}\}$ (resp. $\{\Sigma_{i,a}^{\text{s}} \mid a \in \mathbf{comp}_i^{\text{s}}\}$) be the set of the disk (resp. sphere) components of Σ_i . The (bordered) nodal curve $\Sigma_{i,a}^{\text{d}}$ (resp. $\Sigma_{i,a}^{\text{s}}$) together with marked or nodal points on it determines an element of $\mathcal{M}_{k_{i,a}, \ell_{i,a}}^{\text{d}}$ (resp. $\mathcal{M}_{\ell_{i,a}}^{\text{s}}$), which we denote by $\xi_{i,a}^{\text{d}}$ (resp. $\xi_{i,a}^{\text{s}}$). Here $\mathcal{M}_{k_{i,a}, \ell_{i,a}}^{\text{d}}$ is the moduli space of complex structures of disks with $k_{i,a}$ boundary and $\ell_{i,a}$ interior marked points and $\mathcal{M}_{\ell_{i,a}}^{\text{s}}$ is the moduli space of complex structures of spheres with $\ell_{i,a}$ interior marked points. (We require that the enumeration of the boundary marked points respects the orientation of the boundary of the disk.)

Let $\mathcal{CM}_{k,\ell}^{\text{d}}, \mathcal{CM}_\ell^{\text{s}}$ be the Deligne-Mumford type compactifications of $\mathcal{M}_{k,\ell}^{\text{d}}, \mathcal{M}_\ell^{\text{s}}$, respectively. Namely we add stable nodal disks or spheres to compactify them. Let $\pi : \mathcal{C}_{k,\ell}^{\text{d}} \rightarrow \mathcal{CM}_{k,\ell}^{\text{d}}$, be the universal family. Namely $\pi : \mathcal{C}_{k,\ell}^{\text{d}} \rightarrow \mathcal{CM}_{k,\ell}^{\text{d}}$ comes

with sections \mathfrak{s}_j^d ($j = 1, \dots, k$), \mathfrak{s}_j^s ($j = 1, \dots, \ell$) such that for $\mathfrak{r} \in \mathcal{CM}_{k,\ell}^d$ the fiber $\pi^{-1}(\mathfrak{r})$ together with the marked points $((\mathfrak{s}_j^d(\mathfrak{r}))_{j=1,\dots,k}, (\mathfrak{s}_j^s(\mathfrak{r}))_{j=1,\dots,\ell})$ becomes a representative of \mathfrak{r} .

Let $\pi : \mathcal{C}_{\ell_a}^s \rightarrow \mathcal{CM}_{\ell_a}^s$ be the universal family in a similar sense.

Definition 12.25. (Compare [FOOO9, Definition 16.2] and [FOOO12, Definition 8.6]) Suppose an element ξ of $\mathcal{M}'_{\ell,\ell_1,\ell_2}(L_{12}; \vec{a}; E)$ is source stable. A *source gluing data* at ξ is the following objects.

- (1) A neighborhood $\mathcal{V}_{i,a}^d$ (resp. $\mathcal{V}_{i,a}^s$) of $\xi_{i,a}^d$ (resp. $\xi_{i,a}^s$) in $\mathcal{M}_{k_{i,a},\ell_{i,a}}^d$ (resp. $\mathcal{M}_{\ell_{i,a}}^s$).
- (2) A trivialization of $\pi : \mathcal{C}_{k_{i,a},\ell_{i,a}}^d \rightarrow \mathcal{CM}_{k_{i,a},\ell_{i,a}}^d$ (resp. $\pi : \mathcal{C}_{\ell_{i,a}}^s \rightarrow \mathcal{CM}_{\ell_{i,a}}^s$) on $\mathcal{V}_{i,a}^d$ (resp. $\mathcal{V}_{i,a}^s$). Here trivialization is one in C^∞ category and is required to be compatible with the sections $((\mathfrak{s}_j^d)_{j=1,\dots,k_{i,a}}, (\mathfrak{s}_j^s)_{j=1,\dots,\ell_{i,a}})$. (We remark that $\pi : \mathcal{C}_{k_{i,a},\ell_{i,a}}^d \rightarrow \mathcal{CM}_{k_{i,a},\ell_{i,a}}^d$ is a fiber bundle on $\mathcal{V}_{i,a}^d$ since elements of $\mathcal{V}_{i,a}^d$ are nonsingular.)
- (3) For each (boundary or interior) nodes of $\Sigma_{i,a}^d$ or $\Sigma_{i,a}^s$, we take analytic families of coordinates of the corresponding marked points on $\mathcal{V}_{i,a}^d$ or $\mathcal{V}_{i,a}^s$. (Note that one node is contained in two irreducible components. We take an analytic family of coordinates at each of them.) The notion of an analytic family of coordinates is defined in [FOOO12, Definitions 8.1 and 8.5].
- (4) The objects in (1)(2)(3) are preserved by all the weak isomorphisms $(\psi_1, \psi_2) : \xi \rightarrow \xi$.

The above conditions are mostly the same as one appearing in the construction of Kuranishi structure on $\mathcal{M}(L_{12}; \vec{a}; E)$, for example. We need additional conditions to include the map \mathcal{I} .

- (5) All the interior marked points on the disk components are of first kind. All the marked points on the sphere components are of second kind.
- (6) By (5) and Definition 12.7 (3) for each of disk component $\xi_{1,a}^d$ of Σ_1 there exists corresponding disk component of Σ_2 , which we write $\xi_{2,a}^d$. Namely \mathcal{I} gives an isomorphism between $\xi_{1,a}^d$ and $\xi_{2,a}^d$. We require that $\mathcal{V}_{1,a}^d = \mathcal{V}_{2,a}^d$. Moreover we require the trivialization on $\mathcal{V}_{1,a}^d$ given in (2) is the same as the trivialization on $\mathcal{V}_{2,a}^d$.
- (7) We require that the coordinate at nodal points given by (3) on disk component $\xi_{1,a}^d$ coincide with those on $\xi_{2,a}^d$. (We require this condition both for boundary and interior nodes.)
- (8) We will require all the analytic families of coordinates are extendable in the sense we will define later in Definition 12.32.

◇

We remark that for any element of $\mathcal{M}'(L_{12}; \vec{a}; E)$ we can find its source stabilization such that the Conditions (5)-(8) are satisfied.

We next include the process to start with $\xi \in \mathcal{M}'(L_{12}; \vec{a}; E)$ which is not necessarily source stable and add marked points to obtain an element of $\mathcal{M}'_{\ell,\ell_1,\ell_2}(L_{12}; \vec{a}; E)$ which is source stable.

Definition 12.26. (Compare [FOOO9, Definition 17.5].) Let

$$\xi = (((\Sigma_1, \vec{z}_1, \vec{z}_1^{\text{int}}, \vec{w}_1^{\text{int}}), u_1), ((\Sigma_2, \vec{z}_2, \vec{z}_2^{\text{int}}, \vec{w}_2^{\text{int}}), u_2), \mathcal{I}, \gamma)$$

be an element of $\mathcal{M}'_{\ell, \ell_1, \ell_2}(L_{12}; \vec{a}; E)$.

A *stabilization data* at ξ is the following objects.

- (1) A source stabilization ξ' of ξ is given. In particular $i^*(\xi') = \xi$.
- (2) We require that the number of the irreducible components of the source curve of ξ' is the same as one of ξ .
- (3) A gluing data in the sense of Definition 12.25 is given at ξ' .
- (4) We write $\xi' = (((\Sigma_1, \vec{z}_1, \vec{z}_1^{\text{int}}, \vec{w}_1^{\text{int}}), u_1), ((\Sigma_2, \vec{z}_2, \vec{z}_2^{\text{int}}, \vec{w}_2^{\text{int}}), u_2), \mathcal{S}, \gamma)$.

Note that we use the same symbols $\Sigma_i, \vec{z}_i, u_i, \mathcal{S}, \gamma$ for ξ' as ξ . In fact item (2) implies that we can identify the source curves of ξ' and of ξ . We do not put prime in the notation of interior marked points of ξ' . Since ξ has no interior marked points it does not cause confusion.

- (5) Let $z_{1,j}$ be an interior marked point of first kind, which is necessary on the disk component by item (2) and Definition 12.25 (5). Suppose it is contained in $\Sigma_{1,a_j}^{\text{d}}$. We put $\mathcal{S}(z_{1,j}) = z_{2,j}$ and $\mathcal{S}(\Sigma_{1,a_j}^{\text{d}}) = \Sigma_{2,a_j}^{\text{d}}$. We define $u_j^{\text{d}} : \Sigma_{1,a_j}^{\text{d}} \rightarrow -X_1 \times X_2$ by

$$u_j^{\text{d}}(z) = (u_1(z), u_2(\mathcal{S}(z))).$$

- (a) If u_j^{d} is non-constant we require that u_j^{d} is an immersion at $z_{1,j}$.
- (b) In the situation of (a) we take and fix a codimension 2 submanifold $\mathcal{N}_j^{(1)}$ of $-X_1 \times X_2$ which intersects transversally with u_j^{d} at $u_j^{\text{d}}(z_{1,j})$.
- (6) Let $w_{i,j}$ be an interior marked point of second kind, which is necessary on the sphere component by item (2) and Definition 12.25 (5). Suppose it is contained in $\Sigma_{i,a_j}^{\text{s}}$.
 - (a) If u_i is non-constant on $\Sigma_{i,a_j}^{\text{s}}$ we require that u_i is an immersion at $w_{i,j}$.
 - (b) In the situation of (a) we take and fix a codimension 2 submanifold $\mathcal{N}_j^{(2)}$ of X_i which intersects transversally with u_i at $u_i(w_{i,j})$.
- (7) The data in item (6) are invariant under the action of the group of weak isomorphisms of ξ . (Note that a weak isomorphism is the identity map on the disk components.)

◇

It is easy to see that stabilization data always exist.

Remark 12.27. We need to add marked points of *second* kinds to stabilize the source curve.◇

We next describe the way how we use gluing data to parametrize the deformation of the source objects.

Let ξ be a source stable element of $\mathcal{M}'_{\ell, \ell_1, \ell_2}(L_{12}; \vec{a}; E)$. We take its gluing data as in Definition 12.25 and use the notation of Definition 12.25.

Let

$$\{(\mathfrak{b}_{b,\partial}, \varphi_{b,\partial}^{(j)}) \mid b \in \text{Node}_{\partial}^+, j = 1, 2\}$$

be the set of pairs of boundary nodes and analytic families of coordinates at those points. (Since each boundary node is contained in two irreducible components, there are two choices $j = 1, 2$ of this pair for each boundary node.)

Let

$$\{(\mathfrak{b}_{i,b,\text{int}}, \varphi_{i,b,\text{int}}^{(j)}) \mid b \in i, \text{Node}_{i,\text{int}}^+, j = 1, 2\}$$

be the set of pairs of interior nodes of Σ_i and analytic families of coordinates at those points. ($i = 1, 2$.)

We denote by $\{\Sigma_{i,a}^d \mid a \in \mathbf{comp}_i^d\}$ (resp. $\{\Sigma_{i,a}^s \mid a \in \mathbf{comp}_i^s\}$) the set of disk (resp. sphere) components of Σ_i . Together with nodal or marked points the (bordered) Riemann surfaces $\Sigma_{i,a}^d, \Sigma_{i,a}^s$ determine $\xi_{i,a}^d, \xi_{i,a}^s$. Its neighborhood $\mathcal{V}(\xi_{i,a}^d)$ and $\mathcal{V}(\xi_{i,a}^s)$ in Deligne-Mumford type moduli spaces are determined by Definition 12.25 (1).

We consider the direct product

$$\prod_{a \in \mathbf{comp}_i^d} \mathcal{V}(\xi_{1,a}^d) \times \prod_{i=1,2} \prod_{a \in \mathbf{comp}_i^s} \mathcal{V}(\xi_{i,a}^s) \times \prod_{b \in \text{Node}_\partial^+} [0, 1]_b \times \prod_{i=1,2} \prod_{b \in \text{Node}_{i,\text{int}}^+} D_b^2. \quad (12.11)$$

Here $[0, 1]_b$ is a copy of $[0, 1]$ taken for each $b \in \text{Node}_\partial^+$ and D_b^2 is a copy of $D^2 = \{z \in \mathbb{C} \mid |z| < 1\}$ taken for each $b \in \text{Node}_{i,\text{int}}^+$.

The space (12.11) parametrizes the deformation of the source curve of ξ . We will define a map $\text{Glue} = (\text{Glue}_1, \text{Glue}_2)$

$$\text{Glue}_i : (12.11) \rightarrow \mathcal{CM}_{k,\ell+\ell_i}^d \quad (12.12)$$

to describe it.

Let $\sigma_a^d \in \mathcal{V}(\xi_{1,a}^d) = \mathcal{V}(\xi_{2,a}^d)$, $\sigma_{i,a}^s \in \mathcal{V}(\xi_{i,a}^s)$ and let $\xi_{i,a}^d(\sigma_a^d)$, $\xi_{i,a}^s(\sigma_{i,a}^s)$ be its representative. We denote by $\Sigma_{i,a}^d(\sigma_a^d)$, $\Sigma_{i,a}^s(\sigma_{i,a}^s)$ the underlying (bordered) Riemann surface. (Actually it is either a disk or a sphere.)

We also denote

$$\sigma = ((\sigma_a^d)_{a \in \mathbf{comp}_1^d}, (\sigma_{1,a}^s)_{a \in \mathbf{comp}_1^s}, (\sigma_{2,a}^s)_{a \in \mathbf{comp}_2^s}). \quad (12.13)$$

We call σ the *source deformation parameter*.

Let $r_b \in [0, 1]_b$ and $\mathbf{r}_b \in D_b^2$. We write

$$\mathbf{r} = ((r_b)_{b \in \text{Node}_\partial^+}, (\mathbf{r}_b)_{b \in \text{Node}_{1,\text{int}}^+}, (\mathbf{r}_b)_{b \in \text{Node}_{2,\text{int}}^+}). \quad (12.14)$$

We call \mathbf{r} the *gluing parameter*.

We consider the disjoint union

$$\hat{\Sigma}(\sigma) = \hat{\Sigma}_1(\sigma) \sqcup \hat{\Sigma}_2(\sigma) = \prod_{i=1,2} \prod_{a \in \mathbf{comp}_i^d} \Sigma_{i,a}^d(\sigma_a^d) \sqcup \prod_{i=1,2} \prod_{a \in \mathbf{comp}_i^s} \Sigma_{i,a}^s(\sigma_{i,a}^s). \quad (12.15)$$

For each $b \in \text{Node}_\partial^+$ and $b \in \text{Node}_{i,\text{int}}^+$ the analytic families of coordinates we have taken in Definition 12.25 (3) induce holomorphic embeddings:

$$\varphi_{i,b,\sigma}^{(j),\partial} : D_{\geq 0}^2 \rightarrow \hat{\Sigma}(\sigma), \quad \varphi_{b,\sigma}^{(j),\text{int}} : D^2 \rightarrow \hat{\Sigma}(\sigma), \quad (12.16)$$

for $j = 1, 2$, $i = 1, 2$, where $D_{\geq 0}^2 = \{z \in D^2 \mid \text{Im } z \geq 0\}$. We put

$$\begin{aligned} \hat{\Sigma}(\sigma, \mathbf{r}) = \hat{\Sigma}(\sigma) \setminus & \bigcup_{j=1,2} \bigcup_{i=1,2} \bigcup_{b \in \text{Node}_\partial^+} \varphi_{i,b,\sigma}^{(j),\partial}(\overline{D}_{\geq 0}^2(r_b)) \\ & \setminus \bigcup_{j=1,2} \bigcup_{i=1,2} \bigcup_{b \in \text{Node}_{i,\text{int}}^+} \varphi_{b,\sigma}^{(j),\text{int}}(\overline{D}^2(|\mathbf{r}_b|)), \end{aligned} \quad (12.17)$$

which we decompose to $\hat{\Sigma}(\sigma, \mathbf{r}) = \hat{\Sigma}_1(\sigma, \mathbf{r}) \sqcup \hat{\Sigma}_2(\sigma, \mathbf{r})$.

Definition 12.28. We define an equivalence relation \sim on $\hat{\Sigma}(\sigma, \mathbf{r})$ as follows.

- (1) If $b \in \text{Node}_\partial^+$, $z, w \in D_{\geq 0}^2 \setminus \overline{D}_{\geq 0}^2(r_b)$, $i = 1, 2$ with

$$|zw| = r_b, \quad \text{Arg}z = -\text{Arg}w,$$

then

$$\varphi_{i,b,\sigma}^{(1),\partial}(z) \sim \varphi_{i,b,\sigma}^{(2),\partial}(w)$$

for $i = 1, 2$. See Figure 71. Note that $-\theta$ in the figure is $\text{Arg}z$ and θ' in the figure is $\text{Arg}w$.

- (2) If $b \in \text{Node}_{i,\text{int}}^+$, $z, w \in D^2 \setminus \overline{D}^2(|\mathbf{r}_b|)$, $i = 1, 2$ with

$$zw = \mathbf{r}_b,$$

then

$$\varphi_{b,\sigma}^{(1),\text{int}}(z) \sim \varphi_{b,\sigma}^{(2),\text{int}}(w).$$

See Figure 72.

We put $\Sigma(\sigma, \mathbf{r}) = \hat{\Sigma}(\sigma, \mathbf{r}) / \sim$ and decompose $\Sigma(\sigma, \mathbf{r}) = \Sigma_1(\sigma, \mathbf{r}) \sqcup \Sigma_2(\sigma, \mathbf{r})$. \diamond

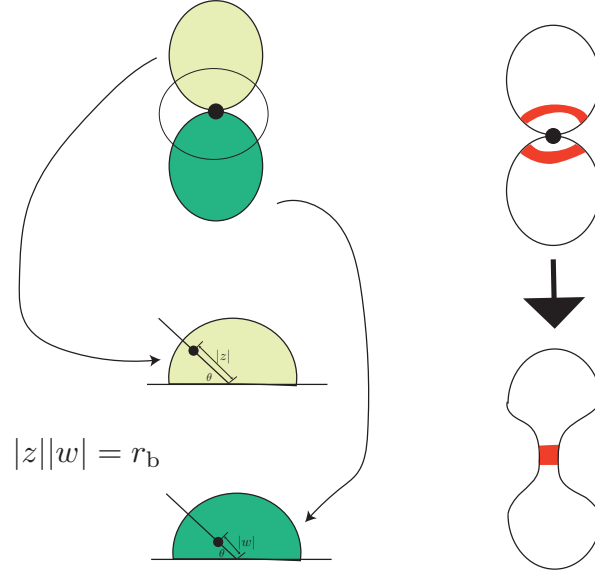

FIGURE 71. Gluing at boundary node.

The marked points of ξ determine marked points on $\Sigma_i(\sigma, \mathbf{r})$ in an obvious way. We denote them by $\vec{z}_i(\sigma, \mathbf{r})$, $\vec{z}_i^{\text{int}}(\sigma, \mathbf{r})$, $\vec{w}_i^{\text{int}}(\sigma, \mathbf{r})$. We put

$$\xi_i(\sigma, \mathbf{r}) = (\Sigma_i(\sigma, \mathbf{r}), \vec{z}_i(\sigma, \mathbf{r}), \vec{z}_i^{\text{int}}(\sigma, \mathbf{r}), \vec{w}_i^{\text{int}}(\sigma, \mathbf{r})). \quad (12.18)$$

Definition 12.29. We define

$$\text{Glue}_i(\sigma, \mathbf{r}) = \xi_i(\sigma, \mathbf{r}).$$

We call Glue_i and $\text{Glue} := (\text{Glue}_1, \text{Glue}_2)$ the *source gluing maps*.

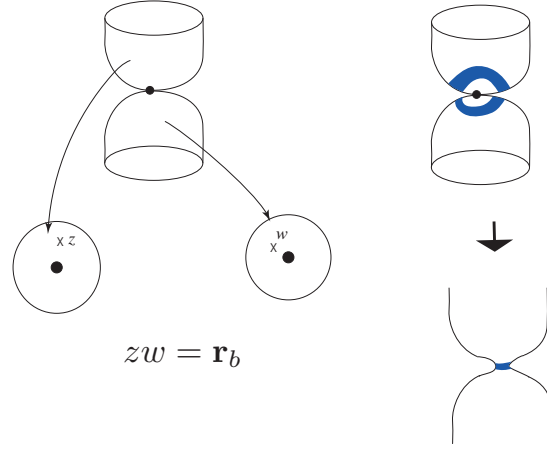

FIGURE 72. Gluing at interior node.

For $a \in \mathbf{comp}_1^d = \mathbf{comp}_2^d$, we put

$$K_{i,a}^{+,d}(\sigma_a^d) = \Sigma_{i,a}^d(\sigma_a^d) \setminus \bigcup_{j=1,2} \bigcup_{b \in \text{Node}_\partial^+} \varphi_{i,b,\sigma}^{(j),\partial}(\overline{D}_{\geq 0}^2(r_b)) \\ \setminus \bigcup_{j=1,2} \bigcup_{b \in \text{Node}_{i,\text{int}}^+} \varphi_{b,\sigma}^{(j),\text{int}}(\overline{D}^2(|\mathbf{r}_b|)),$$

and

$$K_{i,a}^d(\sigma_a^d) = \Sigma_{i,a}^d(\sigma_a^d) \setminus \bigcup_{j=1,2} \bigcup_{b \in \text{Node}_\partial^+} \varphi_{i,b,\sigma}^{(j),\partial}(\overline{D}_{\geq 0}^2) \\ \setminus \bigcup_{j=1,2} \bigcup_{b \in \text{Node}_{i,\text{int}}^+} \varphi_{b,\sigma}^{(j),\text{int}}(\overline{D}^2). \quad (12.19)$$

For $a \in \mathbf{comp}_i^s$ we define $K_{i,a}^{+,s}(\sigma_a^s)$ and $K_{i,a}^s(\sigma_a^s)$ with

$$K_{i,a}^s(\sigma_a^s) \subset K_{i,a}^{+,s}(\sigma_a^s) \subset \Sigma_{i,a}^s(\sigma_a^s)$$

in the same way. We call $K_{i,a}^s(\sigma_a^s)$ and $K_{i,a}^d(\sigma_a^d)$ the *core*. See Figures 73 and 74.

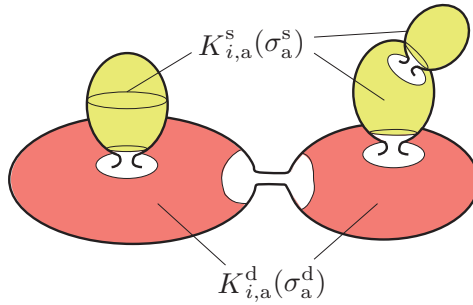
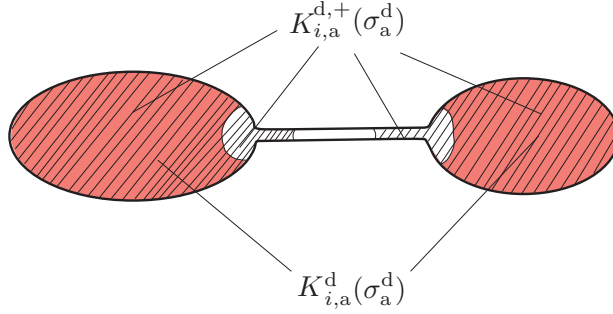

FIGURE 73. Core.

FIGURE 74. $K_{i,a}^d(\sigma_a^d)$ and $K_{i,a}^{d,+}(\sigma_a^d)$

Definition 12.30. By definition we have holomorphic embeddings

$$\mathfrak{J}_{i,a,\sigma,\mathbf{r}}^{+,d} : K_{i,a}^{+,d}(\sigma_a^d) \rightarrow \Sigma_i(\sigma, \mathbf{r}), \quad \mathfrak{J}_{i,a,\sigma,\mathbf{r}}^{+,s} : K_{i,a}^{+,s}(\sigma_a^s) \rightarrow \Sigma_i(\sigma, \mathbf{r}).$$

We call its restriction

$$\mathfrak{J}_{i,a,\sigma,\mathbf{r}}^d : K_{i,a}^d(\sigma_a^d) \rightarrow \Sigma_i(\sigma, \mathbf{r}), \quad \mathfrak{J}_{i,a,\sigma,\mathbf{r}}^s : K_{i,a}^s(\sigma_a^s) \rightarrow \Sigma_i(\sigma, \mathbf{r}),$$

the *canonical holomorphic embedding*. \diamond

Lemma 12.31. *All the weak isomorphisms $\psi = (\psi_1, \psi_2) : \xi \rightarrow \xi$ canonically induce biholomorphic maps*

$$\psi_{i,\sigma,\mathbf{r}} : \Sigma_i(\sigma, \mathbf{r}) \rightarrow \Sigma_i((\psi_i)_*(\sigma, \mathbf{r})).$$

\diamond

Proof. The map ψ_i permutes the interior nodes. We permute the components of the gluing parameter \mathbf{r} in the same way. The map ψ_i also permutes the sphere components. We permute the components of σ in the same way. This is the definition of $(\psi_i)_*$. The lemma is then an immediate consequence of Definition 12.25 (4) and the construction. \square

Our next task is to define a biholomorphic map $\mathcal{I}_{\sigma,\mathbf{r}} : \Sigma_1^0(\sigma, \mathbf{r}) \rightarrow \Sigma_2^0(\sigma, \mathbf{r})$. Here $\Sigma_i^0(\sigma, \mathbf{r})$ is the union of disk components of $\Sigma_i(\sigma, \mathbf{r})$.

Such an isomorphism is not canonically induced from \mathcal{I} , since $\Sigma_1^0(\sigma, \mathbf{r})$ may contain a part of the *sphere* components $K_{i,a}^s(\sigma_a^s)$, on which \mathcal{I} is *not* defined.

We take a certain special choice of the coordinates around the nodes which we use to glue, so that we can define $\mathcal{I}_{\sigma,\mathbf{r}}$.

Definition 12.32.

- (1) A holomorphic embedding $D^2 \rightarrow S^2$ is said to be *extendable* if it is a restriction of a biholomorphic map $S^2 \rightarrow S^2$.
- (2) A holomorphic embedding $D^2 \rightarrow D^2$ is said to be *extendable* if it is a restriction of biholomorphic map $D^2(R) \rightarrow D^2$ for some $R > 1$.
- (3) A holomorphic embedding $(D_{\geq 0}^2, D^2 \cap \mathbb{R}) \rightarrow (D^2, \partial D^2)$ is said to be *extendable* if its double is extendable in the sense of (1).
- (4) An analytic family of coordinates is said to be *extendable* if its members are extendable in the sense of (1),(2) or (3).

\diamond

We recall that we assumed that all the analytic families of coordinates appearing as a part of gluing data are extendable. (Definition 12.25 (8).)

Lemma 12.33. *We can canonically define a biholomorphic map $\mathcal{I}_{\sigma, \mathbf{r}} : \Sigma_1^0(\sigma, \mathbf{r}) \rightarrow \Sigma_2^0(\sigma, \mathbf{r})$ with the following properties.*

(1) *The next diagram commutes.*

$$\begin{array}{ccc} K_{1, \mathbf{a}}^{+, \mathbf{d}}(\sigma_{\mathbf{a}}^{\mathbf{d}}) & \longrightarrow & K_{2, \mathbf{a}}^{+, \mathbf{d}}(\sigma_{\mathbf{a}}^{\mathbf{d}}) \\ \mathfrak{J}_{1, \mathbf{a}, \sigma, \mathbf{r}}^{+, \mathbf{d}} \downarrow & & \downarrow \mathfrak{J}_{2, \mathbf{a}, \sigma, \mathbf{r}}^{+, \mathbf{d}} \\ \Sigma_1^0(\sigma, \mathbf{r}) & \xrightarrow{\mathcal{I}_{\sigma, \mathbf{r}}} & \Sigma_2^0(\sigma, \mathbf{r}) \end{array} \quad (12.20)$$

where the first horizontal arrow is the isomorphism induced by \mathcal{I} . The vertical arrows are maps induced by $\mathfrak{J}_{1, \mathbf{a}, \sigma, \mathbf{r}}^{+, \mathbf{d}}$ and $\mathfrak{J}_{2, \mathbf{a}, \sigma, \mathbf{r}}^{+, \mathbf{d}}$.

(2) *If $\psi = (\psi_1, \psi_2)$ is a weak isomorphism $:\xi \rightarrow \xi$ then we have*

$$\mathcal{I}_{\psi_*(\sigma, \mathbf{r})} \circ \psi_{1, \sigma, \mathbf{r}} = \psi_{2, \sigma, \mathbf{r}} \circ \mathcal{I}_{\sigma, \mathbf{r}}.$$

(3) *$\mathcal{I}_{\sigma, \mathbf{r}}(z_{1, j}^{\text{int}}(\sigma, \mathbf{r})) = z_{2, j}^{\text{int}}(\sigma, \mathbf{r})$. It also preserves boundary marked points.*

◇

Proof. We put

$$\Sigma_i(\sigma) := \Sigma_i(\sigma, \mathbf{0})$$

where the gluing parameter $\mathbf{0}$ is by definition $r_b = 0$, $\mathbf{r}_b = 0$ for all b . Since we deform the disk components of Σ_1 and of Σ_2 in exactly the same way by definition, we have a biholomorphic maps $\mathcal{I}_{\sigma, \mathbf{0}} : \Sigma_1^0(\sigma) \rightarrow \Sigma_2^0(\sigma)$. Therefore to construct $\mathcal{I}_{\sigma, \mathbf{r}}$ it suffices to find biholomorphic maps

$$\mathcal{I}_{\sigma, i} : \Sigma_i^0(\sigma, \mathbf{r}) \rightarrow \Sigma_i^0(\sigma) \quad (12.21)$$

such that

$$\mathcal{I}_{\sigma, i} \circ \mathfrak{J}_{i, \mathbf{a}, \sigma, \mathbf{r}}^{+, \mathbf{d}} = \mathfrak{J}_{i, \mathbf{a}, \sigma, \mathbf{0}}^{+, \mathbf{d}}. \quad (12.22)$$

We describe the construction of $\mathcal{I}_{\sigma, i}$ in the following case. $\Sigma_i(\sigma)$ is a union of D^2 and S^2 where we glue them at $0 \in D^2$ and $0 \in S^2 = \mathbb{C} \cup \{\infty\}$. By the definition of extendable coordinate we take our coordinate $\varphi^{\mathbf{d}}$ and $\varphi^{\mathbf{s}}$ by

$$\varphi^{\mathbf{d}}(z) = cz \in D^2, \quad \varphi^{\mathbf{s}}(z) = c'z \in \mathbb{C} \cup \{\infty\}$$

where $c \in \mathbb{R}_+$ is a small positive number and $c' \in \mathbb{C}$ is a nonzero complex number with small absolute value. We denote the gluing parameter by $\mathbf{r} \in D^2$.

By definition $\Sigma_i^0(\sigma) = D^2 \subset \Sigma_i(\sigma)$. Let $\mathbf{r} \neq 0$. Then $\Sigma_i^0(\sigma, \mathbf{r})$ is obtained by gluing

$$D^2 \setminus D^2(c|\mathbf{r}|) \quad (12.23)$$

and

$$\mathbb{C} \cup \{\infty\} \setminus D^2(|c'\mathbf{r}|) \quad (12.24)$$

by the equivalence relation \sim . The equivalence relation \sim is defined in Definition 12.28. In our case it is described as follows. Let $z \in (12.23)$ and $w \in (12.24)$. Then $z \sim w$ if and only if $z/c \times w/c' = \mathbf{r}$. Namely $z = cc'\mathbf{r}/w$. Therefore we define $\mathcal{I}_{\sigma, i}$ such that $\mathcal{I}_{\sigma, i}(z) = z$ if $z \in (12.23)$ and $\mathcal{I}_{\sigma, i}(w) = cc'\mathbf{r}/w$ if $w \in (12.24)$. See Figure 75. We thus defined $\mathcal{I}_{\sigma, i}$ in the above cases. Its definition in the general case is similar. See Figure 76 below. The properties (1)(2)(3) can be easily proved from the construction. \square

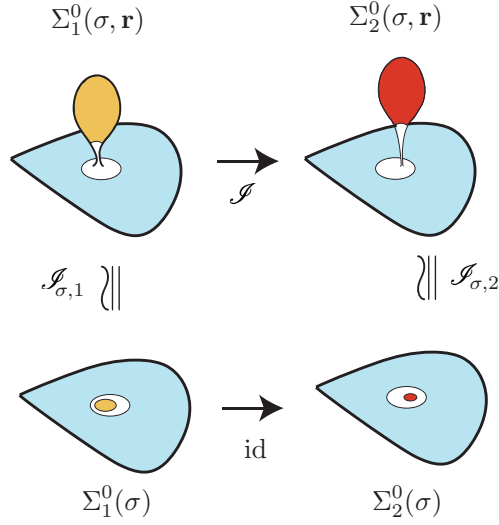

FIGURE 75. Definition of \mathcal{S} .

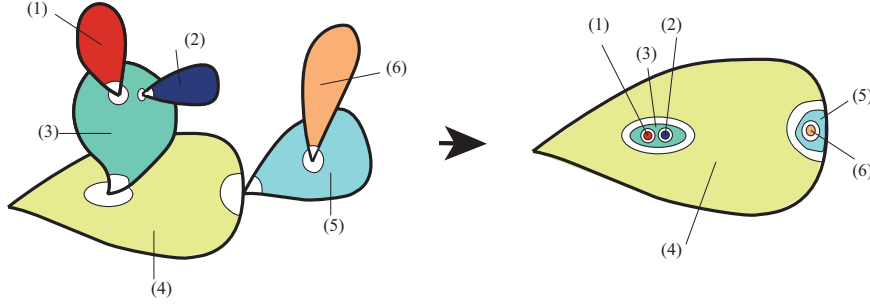

FIGURE 76. Definition of $\mathcal{S}_{\sigma,i}$ in the general case.

Remark 12.34. We remark that in our situation $\Sigma_i^0(\sigma, \mathbf{r})$ is a tree of disks *without* sphere bubbles. This is because of Definition 12.25 (5), that is, all the marked points on the sphere components are of second kind. Note that we forget all the marked points of second kind to obtain $\Sigma_i^0(\sigma, \mathbf{r})$. By this reason we consider only core of disk components $K_{i,a}^{+,d}(\sigma_a^d)$ in (12.20). Since we are studying $\mathcal{M}'_{0,0,0}(L_{12}; \vec{a}; E)$ as we mentioned at the beginning of the proof, we can assume Definition 12.25 (5). When we generalize the construction to the case of $\mathcal{M}'_{\ell,\ell_1,\ell_2}(L_{12}; \vec{a}; E)$ then we need to study the case when there is a marked point of the first kind on the sphere components. So there may exist a core $K_{i,a}^{+,s}(\sigma_a^s)$ in the sphere components contained in $\Sigma_i^0(\sigma, \mathbf{r})$. In such cases, to define $\mathcal{S}_{\sigma,\mathbf{r}}$, on such parts, we need to modify (12.11). Namely, for example, in place of $\prod_{i=1,2} \prod_{a \in \text{comp}_i^s} \mathcal{V}(\xi_{i,a}^s)$ we need to consider its subset such that $\mathcal{V}(\xi_{1,a}^s)$ factor and $\mathcal{V}(\xi_{2,a'}^s)$ factor are the same for certain a, a' . We do not discuss this point since we do not use it.

We thus described the way to glue source curves. To discuss the way to glue maps (that is the part where nonlinear functional analysis enters) we first describe the way to define obstruction spaces. This part is mostly the same as the construction

of the Kuranishi structure on the moduli space of pseudo-holomorphic disks. (See [FOOO9, Sections 17 and 18].) We include its discussion here for completeness.

Let $\xi = (((\Sigma_1, \vec{z}_1, \vec{z}_1^{\text{int}}, \vec{w}_1^{\text{int}}), u_1), ((\Sigma_2, \vec{z}_2, \vec{z}_2^{\text{int}}, \vec{w}_2^{\text{int}}), u_2), \mathcal{S}, \gamma)$ be an element of $\mathcal{M}'_{\ell, \ell_1, \ell_2}(L_{12}; \vec{a}; E)$. Using the above notations we consider the source deformation parameter σ which corresponds to the source curve of ξ itself. We denote this σ as $\mathbf{0}$. We put

$$K_{i,a}^s = K_{i,a}^s(\mathbf{0}) \subset \Sigma_i, \quad K_{i,a}^d = K_{i,a}^d(\mathbf{0}) \subset \Sigma_i. \quad (12.25)$$

Definition 12.35. An *obstruction bundle data* centered at ξ is the following objects.

- (1) We take a stabilization data at ξ .
- (2) We take a finite dimensional linear subspace

$$\mathcal{E}_{i,a}^s \subset C^\infty(K_{i,a}^s, u_i^*TX_i \otimes \Lambda^{0,1})$$

for each sphere component of Σ_i and

$$\mathcal{E}_a^d \subset C^\infty(K_{1,a}^d, (u_1, u_2)^*(T(X_1 \times X_2) \otimes \Lambda^{0,1}))$$

for each disk component of Σ_i .

Note that we regard $K_{1,a}^d \cong K_{2,a}^d$ by \mathcal{S} .

We call them the *obstruction spaces*. We assume that the supports of the elements of obstruction spaces are away from nodes and marked points. We also assume that the supports of the elements of \mathcal{E}_a^d is away from boundary. Furthermore we assume the supports of the elements of \mathcal{E}_a^s (resp. \mathcal{E}_a^d) are in a compact subset contained in the interior of $K_{1,a}^d$ (resp. $K_{i,a}^s$).

- (3) We assume that the obstruction spaces satisfy the transversality conditions, Conditions 12.37 and 12.38 below.
- (4) We assume that $\{\mathcal{E}_{i,a}^s\}$ and $\{\mathcal{E}_a^d\}$ are invariant of the weak isomorphism $\xi' \rightarrow \xi'$, where ξ' is the source stabilization of ξ which is a part of the stabilization data given in (1).
- (5) We require that $\mathcal{E}_{i,a}^s = 0$ if u_i is constant on $\Sigma_{i,a}^s$ and $\mathcal{E}_a^d = 0$ if u is constant on Σ_a^d .
- (6) We require

$$\text{Diam } (u_i \circ \varphi_{b,\sigma}^{(j),\text{int}})(D^2) \leq \epsilon_1 \quad (12.26)$$

for each $b \in \text{Node}_{i,\text{int}}^+$ and

$$\text{Diam } (u_i \circ \varphi_{i,b,\sigma}^{(j),\partial})(D_{\geq 0}^2) \leq \epsilon_1 \quad (12.27)$$

for each $b \in \text{Node}_\partial^+$. Here ϵ_1 is a sufficiently small number. (It is smaller than the injectivity radius of $X_1 \times X_2$. It is the constant appearing [FOOO12, Condition 3.1].)

- (7) We require all the marked points are in the core, $K_{i,a}^s, K_{i,a}^d$.

◇

Below we describe the transversality condition mentioned in item (3). We review the linearization of the non-linear Cauchy-Riemann equation for this purpose. For each sphere component, the linearization of the non-linear Cauchy-Riemann equation induces a linear differential operator of first order:

$$(D_{u_i} \bar{\partial})_{i,a}^s : C^\infty(\Sigma_{i,a}^s; u_i^*TX_i) \rightarrow C^\infty(\Sigma_{i,a}^s; u_i^*TX_i \otimes \Lambda^{0,1}). \quad (12.28)$$

The definition of the function spaces appearing in (12.28) is obvious from notation. Let us discuss the case of disk component $\Sigma_{i,a}^d$. We remark that $\Sigma_{1,a}^d \cong \Sigma_{2,a}^d$, which we write Σ_a^d . The pair of maps $u = (u_1, u_2)$ define a map $u : \Sigma_a^d \rightarrow -X_1 \times X_2$. Let $\vec{z}_a = (z_{a,1}, \dots, z_{a,k_a})$ be the set of all marked or nodal points on $\Sigma_{1,a}^d$. $u(z_{a,j})$ lies on the image of $\tilde{L}_{12} \times_{X_1 \times X_2} \tilde{L}_{12} = \bigcup L_{12}(a)$. We define $a_{a,j}$ such that $u(z_{a,j})$ lies in the image of $L_{12}(a_{a,j})$.

Definition 12.36. We define the function space

$$C^\infty((\Sigma_a^d, \partial\Sigma_a^d, \vec{z}_a); (u^*TX, \gamma^*L_{12}, L_{12}(\vec{a}_a)))$$

as the set of the pairs (V, v) such that:

- (1) V is a section of $u^*T(X_1 \times X_2)$ defined on Σ_a^d .
- (2) v is a section of $\gamma^*T\tilde{L}_{12}$ defined on $\partial\Sigma_a^d \setminus \vec{z}_a$.
- (3) If $z \in \partial\Sigma_a^d \setminus \vec{z}_a$ then

$$V(z) := (di_{L_{12}})(v(z)).$$

Here $i_{L_{12}} : \tilde{L}_{12} \rightarrow L_{12}$ is the immersion.

- (4) Let $z_{a,j} \in \vec{z}_a$. We then require

$$\left(\lim_{z \in \partial\Sigma_a^d \uparrow z_{a,j}} v(z), \lim_{z \in \partial\Sigma_a^d \downarrow z_{a,j}} v(z) \right) \in TL_{12}(a_{a,j}).$$

The operator:

$$\begin{aligned} (D_u \bar{\partial})_a^d : C^\infty((\Sigma_a^d, \partial\Sigma_a^d, \vec{z}_a); (u^*TX, \gamma^*L_{12}, L_{12}(\vec{a}_a))) \\ \rightarrow C^\infty(\Sigma_a^d; u^*T(X_1 \times X_2) \otimes \Lambda^{0,1}) \end{aligned} \quad (12.29)$$

is defined by

$$(D_u \bar{\partial})_a^d(V, v) := (D_u \bar{\partial})(V).$$

◇

Condition 12.37. We say that obstruction spaces $\mathcal{E}_{i,a}^s, \mathcal{E}_a^d$ satisfy *mapping transversality condition* if the following holds.

- (1) For each sphere component $\Sigma_{i,a}^s$ we assume

$$\text{Im}(D_{u_i} \bar{\partial})_{i,a}^s + \mathcal{E}_{i,a}^s = C^\infty(\Sigma_{i,a}^s; u_i^*TX_i \otimes \Lambda^{0,1}).$$

- (2) For each disk component Σ_a^d we assume

$$\text{Im}(D_u \bar{\partial})_a^d + \mathcal{E}_a^d = C^\infty(\Sigma_a^d; u^*T(X_1 \times X_2) \otimes \Lambda^{0,1}).$$

◇

To describe another transversality condition we define a linearized version $\mathcal{E}\mathcal{V}$ of the evaluation map. The domain of this evaluation map is the direct sum

$$\begin{aligned} \bigoplus_{i=1,2} \bigoplus_a C^\infty(\Sigma_{i,a}^s; u_i^*TX_i) \\ \bigoplus_a C^\infty((\Sigma_a^d, \partial\Sigma_a^d, \vec{z}_a); (u^*TX, \gamma^*L_{12}, L_{12}(\vec{a}_a))). \end{aligned} \quad (12.30)$$

Here the first direct sum is taken over all the sphere components $\Sigma_{i,a}^s$ and the second direct sum is taken over all the disk components Σ_a^d .

We next describe the target of $\mathcal{E}\mathcal{V}$. Let \mathfrak{z}_b be a boundary node. There exists a component $L_{12}(a_b)$ of $\tilde{L}_{12} \times_{X_1 \times X_2} \tilde{L}_{12}$ such that it is mapped to $u(\mathfrak{z}_b) = (u_1(\mathfrak{z}_b), u_2(\mathfrak{z}_b))$ by $i_{L_{12}}$. The target space of $\mathcal{E}\mathcal{V}$ is the direct sum:

$$\bigoplus_{i=1,2} \bigoplus_b T_{u_i(\mathfrak{z}_b)} X_i \oplus \bigoplus_b T_{\gamma(\mathfrak{z}_b)} L_{12}(a_b). \quad (12.31)$$

Here the first direct sum is one over interior nodes \mathfrak{z}_b . The second direct sum is one over boundary nodes \mathfrak{z}_b . The point $\gamma(\mathfrak{z}_b) \in L_{12}(a_b)$ is by definition

$$\gamma(\mathfrak{z}_b) = \left(\lim_{z \in \partial \Sigma_a^d \uparrow \mathfrak{z}_b} \gamma(z), \lim_{z \in \partial \Sigma_a^d \downarrow \mathfrak{z}_b} \gamma(z) \right) \in L_{12}(a_{a,j}). \quad (12.32)$$

(See Definition 3.17 (5).)

Now we define

$$\mathcal{E}\mathcal{V} : (12.30) \rightarrow (12.31). \quad (12.33)$$

Let $\vec{V} = ((V_{a,1}, (V_{a,2})), (V_a))$ be an element of (12.30). Let \mathfrak{z}_b be an interior node. There are two components $\Sigma_{i,a(1,b)}^{c(1,b)}, \Sigma_{i,a(2,b)}^{c(2,b)}$ containing it. Here $c(1,b), c(2,b)$ are either s or d. Suppose $c(1,b) = d, c(2,b) = s$. Then we define

$$T_{u_i(\mathfrak{z}_b)} X_i \text{ component of } \mathcal{E}\mathcal{V}(\vec{V}) = \Pi_i(V_{a(1,b)}(\mathfrak{z}_b)) - V_{a(2,b),i}(\mathfrak{z}_b) \quad (12.34)$$

where $\Pi_i : T(X_1 \times X_2) \rightarrow T(X_i)$ is the projection. The definitions in the other cases of $c(1,b), c(2,b)$ are similar.

Let \mathfrak{z}_b be a boundary node. There are two disk components $\Sigma_{a(1,b)}^d, \Sigma_{a(2,b)}^d$ containing it. We define

$$\begin{aligned} & T_{\gamma(\mathfrak{z}_b)} L_{12}(a_b) \text{ component of } \mathcal{E}\mathcal{V}(\vec{V}) \\ &= (V_{a(1,b)}, v_{a(1,b)})(\mathfrak{z}_b) - (V_{a(2,b)}, v_{a(2,b)})(\mathfrak{z}_b). \end{aligned} \quad (12.35)$$

Here

$$(V_{a(i,b)}, v_{a(i,b)})(\mathfrak{z}_b) = \left(\lim_{z \in \partial \Sigma_a^d \uparrow \mathfrak{z}_b} v(z), \lim_{z \in \partial \Sigma_a^d \downarrow \mathfrak{z}_b} v(z) \right) \in T_{\gamma(\mathfrak{z}_b)} L_{12}.$$

(12.34) and (12.35) define a map (12.33).

Condition 12.38. We say that obstruction spaces $\mathcal{E}_{i,a}^s, \mathcal{E}_a^d$ satisfy *evaluation transversality condition* if the restriction of $\mathcal{E}\mathcal{V}$ to the direct sum

$$\bigoplus_{i=1,2} \bigoplus_a ((D_{u_i} \bar{\partial})_{i,a}^s)^{-1}(\mathcal{E}_{i,a}^s) \oplus \bigoplus_a ((D_u \bar{\partial})_a^d)^{-1}(\mathcal{E}_a^d).$$

is surjective. \diamond

We thus defined the notion of obstruction bundle data. Our next task is to send obstruction spaces to a nearby object. We make precise the meaning of ‘nearby object’ below.

Definition 12.39. We define a *candidate of an element of the extended moduli space* of $\mathcal{M}'_{\ell, \ell_1, \ell_2}(L_{12}; \vec{a}; E)$ to be an object

$$\eta = (((\Sigma_1^\heartsuit, \vec{z}_1^\heartsuit, \vec{z}_1^{\heartsuit, \text{int}}, \vec{w}_1^{\heartsuit, \text{int}}), u_1^\heartsuit), ((\Sigma_2^\heartsuit, \vec{z}_2^\heartsuit, \vec{z}_2^{\heartsuit, \text{int}}, \vec{w}_2^{\heartsuit, \text{int}}), u_2^\heartsuit), \mathcal{I}^\heartsuit, \gamma^\heartsuit),$$

which satisfies the same conditions as Condition 12.7 except we do not assume $u_i^\heartsuit : \Sigma_i^\heartsuit \rightarrow X_i$ is pseudo-holomorphic as in Condition 12.7 (2) but only assume that it is of C^∞ class. \diamond

Definition 12.40. Let $\xi = (((\Sigma_1, \vec{z}_1, \vec{z}_1^{\text{int}}, \vec{w}_1^{\text{int}}), u_1), ((\Sigma_2, \vec{z}_2, \vec{z}_2^{\text{int}}, \vec{w}_2^{\text{int}}), u_2), \mathcal{S}, \gamma)$ be an element of $\mathcal{M}'_{\ell, \ell_1, \ell_2}(L_{12}; \vec{a}; E)$. We assume that ξ is source stable and fix a source gluing data $\mathcal{G}\mathcal{L}$ on it.

Let η be a candidate of an element of the extended moduli space of $\mathcal{M}'_{\ell, \ell_1, \ell_2}(L_{12}; \vec{a}; E)$. We say that η is ϵ close to $(\xi, \mathcal{G}\mathcal{L})$, if the following holds.

- (1) There exists σ, \mathbf{r} as in (12.13) and (12.14) such that

$$\xi_i(\sigma, \mathbf{r}) = (\Sigma_i^\heartsuit, \vec{z}_i^\heartsuit, \vec{z}_i^{\heartsuit, \text{int}}, \vec{w}_i^{\heartsuit, \text{int}}). \quad (12.36)$$

Moreover via this isomorphism the biholomorphic map $\mathcal{S}_{\sigma, \mathbf{r}}$ in Lemma 12.33 is coincides with \mathcal{S}^\heartsuit .

- (2) The object (σ, \mathbf{r}) is in the ϵ neighborhood of $(\mathbf{0}, \mathbf{0})$.
(3) The restriction of u_i to each $K_{i,a}^{\text{d}}(\sigma_a^{\text{d}})$ is ϵ close to the restriction of u_i^\heartsuit to it in C^2 norm. Here we use $\mathfrak{I}_{i,a,\sigma,\mathbf{r}}^{\text{d}}$ and the isomorphism (12.36) to regard the restrictions of u_i, u_i^\heartsuit as a map defined on $K_{i,a}^{\text{d}}(\sigma_a^{\text{d}})$.
(4) The restriction of u_i to each $K_{i,a}^{\text{s}}(\sigma_a^{\text{s}})$ is ϵ close to the restriction of u_i^\heartsuit to it in C^2 norm. Here we use $\mathfrak{I}_{i,a,\sigma,\mathbf{r}}^{\text{s}}$ and the isomorphism (12.36) to regard the restrictions of u_i, u_i^\heartsuit as maps defined on $K_{i,a}^{\text{s}}(\sigma_a^{\text{s}})$.
(5) For any connected component \mathcal{S} of

$$\Sigma_i(\sigma, \mathbf{r}) \setminus \bigcup_a K_{i,a}^{\text{d}}(\sigma_a^{\text{d}}) \setminus \bigcup_a K_{i,a}^{\text{s}}(\sigma_a^{\text{s}})$$

we require

$$\text{Diam } u_i^\heartsuit(\mathcal{S}) < \epsilon. \quad (12.37)$$

(In other words, we require the diameter of the images by u_i^\heartsuit of the neck regions are smaller than ϵ .)

◇

Let η' be a candidate of an element of the extended moduli space of $\mathcal{M}'_{\ell, \ell_1, \ell_2}(L_{12}; \vec{a}; E)$. We forget all the interior marked points of η' and shrink the components which become unstable. We then obtain a candidate of an element of the extended moduli space of $\mathcal{M}'(L_{12}; \vec{a}; E)$. We denote it by $\eta = \mathbf{i}^*(\eta')$. Note this definition is a version of (12.7). Here \mathbf{i} is (12.7) with $\ell' = \ell'_1 = \ell'_2 = 0$.

Definition 12.41. Let ξ be an element of $\mathcal{M}'(L_{12}; \vec{a}; E)$. We fix its stabilization data $\mathcal{S}\mathcal{T}$. Let η be a candidate of an element of the extended moduli space of $\mathcal{M}'(L_{12}; \vec{a}; E)$.

We say that η is ϵ close to $(\xi, \mathcal{S}\mathcal{T})$ if the following holds.

- (1) There exists a candidate of an element of the extended moduli space of $\mathcal{M}'_{\ell, \ell_1, \ell_2}(L_{12}; \vec{a}; E)$, which we denote by η' such that $\mathbf{i}^*(\eta') = \eta$.
(2) Let ξ' be the source stabilization of ξ which is a part of $\mathcal{S}\mathcal{T}$. (See Definition 12.26 (1).) Let $\mathcal{G}\mathcal{L}$ be the gluing data at ξ' which is a part of $\mathcal{S}\mathcal{T}$. (See Definition 12.26 (3).)

Then η' is ϵ close to $(\xi', \mathcal{S}\mathcal{T})$ in the sense of Definition 12.40.

- (3) Let $z_{1,j}^{\text{int}}$ be an interior marked point of first kind of ξ' . Let $z_{1,j}^{\heartsuit, \text{int}}$ be the corresponding interior marked point of first kind of η' . (See (12.36).) Let $\mathcal{N}_j^{(1)}$ be the codimension 2 submanifold of $-X_1 \times X_2$ which is a part of $\mathcal{S}\mathcal{T}$. (See Definition 12.26 (5).) We require

$$u^\heartsuit(z_{1,j}^{\heartsuit, \text{int}}) \in \mathcal{N}_j^{(1)}. \quad (12.38)$$

Here $u^\heartsuit(z) = (u_1^\heartsuit(z), u_2^\heartsuit(\mathcal{S}'(z)))$.

- (4) Let $w_{i,j}^{\text{int}}$ be an interior marked point of second kind of ξ' . Let $w_{i,j}^{\heartsuit\text{int}}$ be the corresponding interior marked point of first kind of η' . (See (12.36).) Let $\mathcal{N}_j^{(2)}$ be the codimension 2 submanifold of X_i which is a part of $\mathcal{S}\mathcal{T}$. (See Definition 12.26 (6).) We require

$$u_i^\heartsuit(w_{i,j}^{\heartsuit\text{int}}) \in \mathcal{N}_j^{(2)}. \quad (12.39)$$

◇

Let ξ be an element of $\mathcal{M}'(L_{12}; \vec{a}; E)$. We fix an obstruction bundle data $\mathcal{O}\mathcal{B}$ of it. It includes a source stabilization data $\mathcal{S}\mathcal{T}$. Let η be a candidate of an element of extended moduli space of $\mathcal{M}'(L_{12}; \vec{a}; E)$ which is ϵ close to $(\xi, \mathcal{S}\mathcal{T})$.

Our next task is to send obstruction spaces (which is a part of $\mathcal{O}\mathcal{B}$) to a subspace of sections on the source curve Σ_i^\heartsuit of η .

Let $K_{i,a}^{\text{d}}$ (resp. $K_{i,a}^{\text{s}}$) be a core of disk (resp. sphere) component of ξ . We consider

$$\mathcal{I}_{i,a}^{\text{d}} : K_{i,a}^{\text{d}} \cong K_{i,a}^{\text{d}}(\sigma_a^{\text{d}}) \rightarrow \Sigma_i(\sigma, \mathbf{r}) \cong \Sigma_i^\heartsuit. \quad (12.40)$$

Here the first map is a diffeomorphism which is induced by the trivialization given in Definition 12.25 (2). The second map is the map $\mathfrak{J}_{i,a,\sigma,\mathbf{r}}^{\text{d}}$ in Definition 12.30. The third map is a biholomorphic map (12.36). Actually the image of (12.40) lies in a certain disk component of Σ_i^\heartsuit which we denote $\Sigma_{i,a}^{\text{d},\heartsuit}$. By \mathcal{S} and \mathcal{S}^\heartsuit we can identify $\mathcal{I}_{1,a}^{\text{d}}$ with $\mathcal{I}_{2,a}^{\text{d}}$. We write the composition (12.40) as $\mathcal{I}_a^{\text{d}} : K_a^{\text{d}} \rightarrow \Sigma_a^{\text{d},\heartsuit}$. It defines a complex linear map

$$C_0^\infty(K_a^{\text{d}}; \Lambda^{0,1}) \rightarrow C^\infty(\Sigma_a^{\text{d},\heartsuit}; \Lambda^1).$$

(Note that $\mathcal{I}_{i,a}^{\text{d}}$ may not be holomorphic.) Here C_0^∞ denotes the set of smooth sections which have compact support in the interior. We compose it with the projection to obtain

$$C_0^\infty(K_a^{\text{d}}; \Lambda^{0,1}) \rightarrow C^\infty(\Sigma_a^{\heartsuit}; \Lambda^{0,1}). \quad (12.41)$$

This map is complex linear.

On the other hand, for each $z \in K_a^{\text{d}}$ we take the minimal geodesic joining $u(z) \in X_1 \times X_2$ and $u^\heartsuit(\mathcal{I}_a^{\text{d}}(z))$. Then taking a complex linear part of the parallel transport (with respect to a certain connection for which L_{12} is parallel), we obtain a complex linear map

$$T_{u(z)}(-X_1 \times X_2) \rightarrow T_{u^\heartsuit(\mathcal{I}_a^{\text{d}}(z))}(-X_1 \times X_2).$$

It induces

$$C_0^\infty(K_a^{\text{d}}; u^*(T(-X_1 \times X_2))) \rightarrow C^\infty(\Sigma_a^{\text{d},\heartsuit}; (u^\heartsuit)^*T(-X_1 \times X_2)). \quad (12.42)$$

(12.41) and (12.42) are induced by pointwise complex linear maps. So we take pointwise tensor product over \mathbb{C} of (12.41) and (12.42) and obtain

$$\begin{aligned} \Psi_{a,u^\heartsuit}^{\text{d}} : C_0^\infty(K_a^{\text{d}}; u^*(T(-X_1 \times X_2)) \otimes \Lambda^{0,1}) \\ \rightarrow C^\infty(\Sigma_a^{\text{d},\heartsuit}; (u^\heartsuit)^*T(-X_1 \times X_2) \otimes \Lambda^{0,1}). \end{aligned} \quad (12.43)$$

We consider the direct sum

$$\begin{aligned} & \bigoplus_{\mathfrak{a}^\heartsuit} C_0^\infty(\Sigma_{\mathfrak{a}^\heartsuit}^{\mathfrak{d},\heartsuit}; (u^\heartsuit)^* T(-X_1 \times X_2) \otimes \Lambda^{0,1}) \\ & \oplus \bigoplus_{i=1,2} \bigoplus_{\mathfrak{a}^\heartsuit} C_0^\infty(\Sigma_{i,\mathfrak{a}^\heartsuit}^{\mathfrak{s},\heartsuit}; (u_i^\heartsuit)^* T(X_i) \otimes \Lambda^{0,1}). \end{aligned} \quad (12.44)$$

Here the first direct sum is taken over disk components of Σ^\heartsuit and the second direct sum is taken over sphere components of Σ_i^\heartsuit . The symbol 0 in C_0^∞ means sections with compact support away from nodal or marked points and from boundary.

Taking direct sum of the maps $\Psi_{\mathfrak{a},u^\heartsuit}^{\mathfrak{d}}$ we obtain

$$\Psi_{u^\heartsuit}^{\mathfrak{d}} : \bigoplus_{\mathfrak{a}} C_0^\infty(K_{\mathfrak{a}}^{\mathfrak{d}}; u^*(T(-X_1 \times X_2)) \otimes \Lambda^{0,1}) \rightarrow (12.44). \quad (12.45)$$

Here direct sum of the domain is taken over disk components. In case we specify ξ and $\mathcal{O}\mathcal{B}$ we write $\Psi_{\xi,u^\heartsuit}^{\mathfrak{d}}$ or $\Psi_{\xi,\mathcal{O}\mathcal{B},u^\heartsuit}^{\mathfrak{d}}$.

We can perform a similar construction for sphere components to obtain

$$\Psi_{i,u^\heartsuit}^{\mathfrak{s}} = \Psi_{\xi,\mathcal{O}\mathcal{B},i,u^\heartsuit}^{\mathfrak{s}} : \bigoplus_{\mathfrak{a}} C_0^\infty(K_{i,\mathfrak{a}}^{\mathfrak{s}}; u^*(TX_i) \otimes \Lambda^{0,1}) \rightarrow (12.44). \quad (12.46)$$

Definition 12.42. We denote

$$\mathcal{E}(\xi, \mathcal{O}\mathcal{B}) := \bigoplus_{i=1,2} \bigoplus_{\mathfrak{a}} \mathcal{E}_{i,\mathfrak{a}}^{\mathfrak{s}} \oplus \bigoplus_{\mathfrak{a}} \mathcal{E}_{\mathfrak{a}}^{\mathfrak{d}}.$$

We define the subspace

$$\mathcal{E}(\xi, \mathcal{O}\mathcal{B}; \eta) \subset (12.44)$$

to be the image of $\mathcal{E}(\xi, \mathcal{O}\mathcal{B})$ by the map $\Psi_{u^\heartsuit}^{\mathfrak{d}} \oplus \Psi_{1,u^\heartsuit}^{\mathfrak{s}} \oplus \Psi_{2,u^\heartsuit}^{\mathfrak{s}}$.

We write $\mathcal{E}(\xi; \eta)$ in place of $\mathcal{E}(\xi, \mathcal{O}\mathcal{B}; \eta)$ in case the choice of $\mathcal{O}\mathcal{B}$ is obvious from the context. \diamond

We remark that the choice of σ, \mathbf{r} and the third isomorphism in (12.40) is *not* unique. The maps $\Psi_{u^\heartsuit}^{\mathfrak{d}} \oplus \Psi_{1,u^\heartsuit}^{\mathfrak{s}} \oplus \Psi_{2,u^\heartsuit}^{\mathfrak{s}}$ depend on this choice. However two different choices are transformed each other by the weak isomorphism of ξ . Therefore by Definition 12.26 (7) and Definition 12.35 (4) the image $\mathcal{E}(\xi, \mathcal{O}\mathcal{B})$ is independent of such choices.

Roughly speaking the underlying orbifold of Kuranishi chart consists of η such that $\bar{\partial}u^\heartsuit \in \mathcal{E}(\xi; \eta)$. To obtain Kuranishi chart so that we can define coordinate transformation among them we need one more steps to work out.

We remark that for each $(\xi, \mathcal{O}\mathcal{B})$ there exists $\epsilon(\xi, \mathcal{O}\mathcal{B})$ such that the construction of $\mathcal{E}(\xi, \mathcal{O}\mathcal{B}; \eta)$ works for η which is $\epsilon(\xi, \mathcal{O}\mathcal{B})$ close to $(\xi, \mathcal{S}\mathcal{T})$.

For each $\xi \in \mathcal{M}'(L_{12}; \bar{a}; E)$ we choose and fix an obstruction bundle data $\mathcal{O}\mathcal{B}$. We also take a closed neighborhood $\mathfrak{N}(\xi)$ of ξ in $\mathcal{M}'(L_{12}; \bar{a}; E)$ such that each element of $\mathfrak{N}(\xi)$ is $\epsilon(\xi, \mathcal{O}\mathcal{B})/2$ close to $(\xi, \mathcal{S}\mathcal{T})$.

We take a finite subset

$$\{\xi_i \mid i \in \mathbf{I}\} \subset \mathcal{M}'(L_{12}; \bar{a}; E) \quad (12.47)$$

such that

$$\bigcup_{i \in \mathbf{I}} \text{Int } \mathfrak{N}(\xi_i) = \mathcal{M}'(L_{12}; \bar{a}; E). \quad (12.48)$$

Using the data we fixed above, we will construct a Kuranishi neighborhood of an arbitrary element ξ of $\mathcal{M}'(L_{12}; \vec{a}; E)$. We put

$$\mathbf{I}(\xi) := \{\mathbf{i} \in \mathbf{I} \mid \xi \in \mathfrak{N}(\xi_{\mathbf{i}})\}. \quad (12.49)$$

By perturbing obstruction spaces of $(\xi_{\mathbf{i}}, \mathcal{O}\mathcal{B})$ we may assume that the sum

$$\bigoplus_{\mathbf{i} \in \mathbf{I}(\xi)} \mathcal{E}(\xi_{\mathbf{i}}, \mathcal{O}\mathcal{B}; \xi)$$

is a direct sum. See [FOOO9, Lemma 18.8], which is proved in [FOOO9, Section 27] and more detailed in [FOOO14, Subsection 11.4].

We take stabilization data $\mathcal{S}\mathcal{T}$ at ξ . We assume that Definition 12.35 (5) is satisfied. ($\mathcal{S}\mathcal{T}$ may or may not coincide with one included in $\mathcal{O}\mathcal{B}$ taken above.) We take $\epsilon_2(\xi)$ enough small so that if η is a candidate of an element of extended moduli space of $\mathcal{M}'(L_{12}; \vec{a}; E)$ which is $\epsilon_2(\xi)$ close to $(\xi, \mathcal{S}\mathcal{T})$ then η is $\epsilon(\xi_{\mathbf{i}}, \mathcal{O}\mathcal{B})$ close to $(\xi_{\mathbf{i}}, \mathcal{O}\mathcal{B})$ for each $\mathbf{i} \in \mathbf{I}(\xi)$.

Definition 12.43. For $\epsilon < \epsilon_2(\xi)$ we define $U(\xi; \epsilon)$ to be the isomorphism classes of η with the following properties.

- (1) $\eta = (((\Sigma_1^\heartsuit, \vec{z}_1^\heartsuit), u_1^\heartsuit), ((\Sigma_2^\heartsuit, \vec{z}_2^\heartsuit), u_2^\heartsuit), \mathcal{S}^\heartsuit, \gamma^\heartsuit)$ is a candidate of an element of extended moduli space of $\mathcal{M}'(L_{12}; \vec{a}; E)$.
- (2) η is ϵ close to $(\xi, \mathcal{S}\mathcal{T})$.
- (3)

$$\bar{\partial}u_{\mathbf{i}}^\heartsuit \in \bigoplus_{\mathbf{i} \in \mathbf{I}(\xi)} \mathcal{E}(\xi_{\mathbf{i}}, \mathcal{O}\mathcal{B}; \eta) \quad (12.50)$$

on the image of $\mathcal{I}_a^d : K_a^d \rightarrow \Sigma_a^{d, \heartsuit}$ and

$$\bar{\partial}u_{\mathbf{i}}^\heartsuit \in \bigoplus_{\mathbf{i} \in \mathbf{I}(\xi)} \mathcal{E}(\xi_{\mathbf{i}}, \mathcal{O}\mathcal{B}; \eta) \quad (12.51)$$

on the image of $\mathcal{I}_{i,a}^s$. Moreover $u_{\mathbf{i}}^\heartsuit$ is pseudo-holomorphic outside the images of \mathcal{I}_a^d and $\mathcal{I}_{i,a}^s$.

Let Γ_ξ be the set of all automorphisms of ξ .

We denote

$$\mathcal{E}(\xi) := \bigoplus_{\mathbf{i} \in \mathbf{I}(\xi)} \mathcal{E}(\xi_{\mathbf{i}}, \mathcal{O}\mathcal{B}).$$

◇

The next proposition claims that we can construct a Kuranishi neighborhood of ξ using the above data.

Proposition 12.44. *For sufficiently small $\epsilon > 0$ the following holds.*

- (1) *There exists a smooth manifold $V(\xi; \epsilon)$ of finite dimension on which Γ_ξ acts smoothly such that the quotient space $V(\xi; \epsilon)/\Gamma_\xi$ is homeomorphic to $U(\xi; \epsilon)$.*
- (2) *We can define a smooth Γ_ξ equivalent map*

$$\mathfrak{s}_\xi : V(\xi; \epsilon) \rightarrow \mathcal{E}(\xi)$$

as follows.

For $\hat{\eta} \in V(\xi; \epsilon)$ whose equivalence class is mapped to $\eta \in U(\xi; \epsilon)$ by the homeomorphism in item (1), we can take its representative and a choice of the map (12.40) (among finitely many possible choices) such that the

components of $\mathfrak{s}_\xi(\hat{\eta})$ is obtained by applying $(\Psi_{\xi_1, u'}^d)^{-1}$ or $(\Psi_{\xi_1, \mathcal{O}\mathfrak{B}, u'}^d)^{-1}$ to $\bar{\partial}u, \bar{\partial}u_i$.

- (3) We define $\psi_\xi : \mathfrak{s}_\xi^{-1}(0) \rightarrow \mathcal{M}'(L_{12}; \bar{a}; E)$ by regarding an element $\hat{\eta} \in \mathfrak{s}_\xi^{-1}(0)$ as an element of $\mathcal{M}'(L_{12}; \bar{a}; E)$. Then ψ_ξ induces a homeomorphism from $\mathfrak{s}_\xi^{-1}(0)/\Gamma_\xi$ to a neighborhood of ξ .
- (4) $\mathcal{U}(\xi, \epsilon) = (V(\xi; \epsilon), \Gamma_\xi, \mathcal{E}(\xi), \mathfrak{s}_\xi, \psi_\xi)$ is a Kuranishi neighborhood of ξ in the sense of [FOOO2, Definition A1.1].

◇

Proof. Below we provide the construction of $(V(\xi; \epsilon), \Gamma_\xi, \mathcal{E}(\xi), \mathfrak{s}_\xi, \psi_\xi)$ leaving the gluing analysis and smoothness proof to the next subsection.

The construction of the manifold $V(\xi; \epsilon)$ and a homeomorphism $V(\xi; \epsilon)/\Gamma_\xi \cong U(\xi; \epsilon)$ is the gluing construction of the solution space of the equation (12.50) and (12.51).

The stabilization data of ξ we take include a source stabilization ξ' and gluing data at it. It induces a source gluing map whose domain is

$$\prod_{a \in \text{comp}_1^d} \mathcal{V}(\xi'_{1,a}{}^d) \times \prod_{i=1,2} \prod_{a \in \text{comp}_i^s} \mathcal{V}(\xi'_{i,a}{}^s) \times \prod_{b \in \text{Node}_\partial^+} [0, \epsilon]_b \times \prod_{i=1,2} \prod_{b \in \text{Node}_{i,\text{int}}^+} D_b^2(\epsilon). \quad (12.52)$$

(We restrict the gluing parameter so that the domain is smaller than (12.11).) We denote (12.52) by $\mathcal{V}(\xi', \mathcal{G}\mathcal{L})$.

$V(\xi; \epsilon)$ is a submanifold of the product of this space and the other space which parametrizes the map. We define the latter space below.

For each disk component $\xi'_a{}^d$ and sphere component $\xi'_{i,a}{}^s$ we consider the set of maps

$$\begin{aligned} u_a^{\heartsuit, d} &: (\Sigma_a^d, \partial\Sigma_a^d, \bar{z}_a) \rightarrow (X_1 \times X_2, \gamma^* L_{12}, L_{12}(\bar{a}_a)) \\ u_{i,a}^{\heartsuit, s} &: \Sigma_{i,a}^s \rightarrow X_i \end{aligned}$$

(Here the notation in the first line is as in Definition 12.36), such that

$$\bar{\partial}u_a^{\heartsuit, d} \in \mathcal{E}(\xi'), \quad \bar{\partial}u_{i,a}^{\heartsuit, s} \in \mathcal{E}(\xi') \quad (12.53)$$

and that the C^2 distance between $u_a^{\heartsuit, d}$ (resp. $u_{i,a}^{\heartsuit, s}$) and $u'_a{}^d$ (resp. $u'_{i,a}{}^s$) is smaller than ϵ . Here $u'_a{}^d, u'_{i,a}{}^s$ are parts of ξ' .

We denote the set of such maps $u_a^{\heartsuit, d}$ (resp. $u_{i,a}^{\heartsuit, s}$) by $\mathcal{W}_a^d(\xi'; \epsilon)$ (resp. $\mathcal{W}_{i,a}^s(\xi'; \epsilon)$) and put

$$\mathcal{W}^+(\xi'; \epsilon) := \prod_a \mathcal{W}_a^d(\xi'; \epsilon) \times \prod_{i=1,2} \prod_a \mathcal{W}_{i,a}^s(\xi'; \epsilon). \quad (12.54)$$

Here the first product is taken over disk components and the second product is taken over sphere components.

We consider the direct product

$$\prod_{i=1,2} \prod_{b \in \text{node}_{i,\text{int}}^+} (X_i)^2 \times \prod_{b \in \text{node}_\partial^+} (L_{12}(a_b))^2. \quad (12.55)$$

Here $L_{12}(a_b)$ is as in (12.31).

Note each node is contained in exactly two irreducible components. So using the evaluation maps on those components, we define

$$\text{ev}_{\text{node}} : \mathcal{W}^+(\xi'; \epsilon) \rightarrow (12.55).$$

Lemma 12.45. *Let*

$$\Delta = \prod_{i=1,2} \prod_{b \in \text{node}_{i,\text{int}}^+} X_i \times \prod_{b \in \text{node}_\partial^+} L_{12}(a_b)$$

be the diagonal in (12.55). Then the map ev_{node} is transversal to Δ if ϵ is sufficiently small. \diamond

Proof. This is a consequence of Condition 12.37, which implies that ev_{node} is transversal to Δ at $((u_a^d), (u_{i,a}^s))$. \square

Definition 12.46. We put

$$\mathcal{W}(\xi'; \epsilon) = \text{ev}_{\text{node}}^{-1}(\Delta) \subset \mathcal{W}^+(\xi'; \epsilon).$$

\diamond

Note that Γ_ξ the group of automorphisms of ξ acts ξ' as a group of weak automorphisms. Then it acts on $\mathcal{V}(\xi', \mathcal{G}\mathcal{L})$ and $\mathcal{W}^+(\xi'; \epsilon)$ by exchanging the factors. It then acts on $\mathcal{W}(\xi'; \epsilon)$.

The gluing construction proves the next:

Proposition 12.47. *For each $\rho = ((\rho_a^d), (\rho_{i,a}^s)) \in \mathcal{W}(\xi'; \epsilon)$ and $(\sigma, \mathbf{r}) \in \mathcal{V}(\xi', \mathcal{G}\mathcal{L})$ we obtain an object $\eta(\rho, \sigma, \mathbf{r})$ satisfying conditions in Definition 12.43 except (12.38) and (12.39) and whose source object is $(\text{Glue}(\sigma, \mathbf{r}), \mathcal{I}_{\sigma, \mathbf{r}})$.*

On the contrary, any object satisfying conditions in Definition 12.43 except (12.38) and (12.39) with sufficiently small ϵ is equivalent to some $\eta(\rho, \sigma, \mathbf{r})$.

The isomorphism class of $\eta(\rho, \sigma, \mathbf{r})$ is the same as the isomorphism class of $\eta(\gamma(\rho, \sigma, \mathbf{r}))$ for $\gamma \in \Gamma_\xi$. \diamond

The proof is given in the next subsection.

We next cut down the space $\mathcal{V}(\xi', \mathcal{G}\mathcal{L}) \times \mathcal{W}(\xi'; \epsilon)$ by Conditions (12.38) and (12.39). We compose the map $(\rho, \sigma, \mathbf{r}) \mapsto \eta(\rho, \sigma, \mathbf{r})$ and the evaluation maps at the interior marked points (12.10) to obtain:

$$\text{ev}_{\text{int}} : \mathcal{V}(\xi', \mathcal{G}\mathcal{L}) \times \mathcal{W}(\xi'; \epsilon) \rightarrow (X_1 \times X_2)^\ell \times X_1^{\ell_1} \times X_2^{\ell_2}. \quad (12.56)$$

The next proposition claims its smoothness. We need carefully choose the smooth structure of $\mathcal{V}(\xi', \mathcal{G}\mathcal{L})$ so that ev_{int} becomes a smooth map.

Let $r \in [0, \epsilon)_b$ and $\mathbf{r} \in D_b^2(\epsilon)$. (See (12.52).) We define T, θ by

$$r = e^{-10\pi T}, \quad \mathbf{r} = e^{-10\pi T + 2\pi\sqrt{-1}\theta} \quad (12.57)$$

and put

$$s = 1/T, \quad \mathcal{S} = e^{2\pi\sqrt{-1}\theta}/T. \quad (12.58)$$

We use s and \mathcal{S} as coordinates in place of r and \mathbf{r} to define a smooth structure of $\mathcal{V}(\xi', \mathcal{G}\mathcal{L})$.

Proposition 12.48. *When we put the above smooth structure on $\mathcal{V}(\xi', \mathcal{G}\mathcal{L})$ the map ev_{int} in (12.56) is smooth. \diamond*

We will prove this proposition in the next subsection.

Definition 12.49. Let $V(\xi; \epsilon)$ be the subset of $\mathcal{V}(\xi', \mathcal{G}\mathcal{L}) \times \mathcal{W}(\xi'; \epsilon)$ consisting of elements $(\rho, \sigma, \mathbf{r})$ such that

$$\text{ev}_{\text{int}}(\rho, \sigma, \mathbf{r}) \in \prod_j \mathcal{N}_j^{(1)} \times \prod_j \mathcal{N}_j^{(2)}.$$

Here $\mathcal{N}_j^{(1)}$ and $\mathcal{N}_j^{(2)}$ are as in (12.38) and (12.39). The direct product in the first factor of the right hand side is taken over interior marked points on disk components and the direct product of the second factor of the right hand side is taken over interior marked points on sphere components. \diamond

Corollary 12.50. *If ϵ is sufficiently small then $V(\xi; \epsilon)$ is a smooth submanifold of $\mathcal{V}(\xi', \mathcal{GL}) \times \mathcal{W}(\xi'; \epsilon)$.* \diamond

Proof. In view of Proposition 12.48 it suffices to show that ev_{int} is transversal to $\prod_j \mathcal{N}_j^{(1)} \times \prod_j \mathcal{N}_j^{(2)}$ at $((u_a^d), (u_{i,a}^s))$. This is a consequence of Definition 12.26 (5)(b) and (6)(b). \square

From Corollary 12.50 and Proposition 12.47 it is easy to see that there is a canonical isomorphism between $V(\xi; \epsilon)/\Gamma_\xi$ and $U(\xi; \epsilon)$. We thus have proved Proposition 12.44 (1).

We next prove Proposition 12.44 (2). Let $i \in \mathbf{I}(\xi)$. We take a source stabilization ξ'_i of ξ_i and a source stabilization ξ' of ξ such that ξ' is ϵ close to (ξ'_i, \mathcal{GL}) . (Note ξ' may depend on i .) We then fix a map

$$\mathcal{I}_{i,a}^d(\mathbf{0}) : K_{i,a}^d(\xi'_i) \cong K_{i,a}^d(\sigma_a^d(\mathbf{0})) \rightarrow \Sigma_i(\sigma(\mathbf{0}), \mathbf{r}(\mathbf{0})) \cong \Sigma_i \quad (12.59)$$

where Σ_i is an irreducible component of ξ (which is also an irreducible component of ξ') and $(\sigma(\mathbf{0}), \mathbf{r}(\mathbf{0}))$ so that the source gluing map at ξ'_i sends $(\sigma(\mathbf{0}), \mathbf{r}(\mathbf{0}))$ to ξ'_i . $K_{i,a}^d(\xi'_i)$ is a core of a disk component of the source curve of ξ'_i .

Note that the image of (12.59) is in a disk component $\Sigma_{i,a}^d$ of the source curve of ξ' .

Now let $(\sigma, \mathbf{r}) \in \mathcal{V}(\xi', \mathcal{GL})$. The source curve of $\eta(\rho, \sigma, \mathbf{r})$ depends only on (σ, \mathbf{r}) and is $\epsilon(\xi_i, \mathcal{OB})$ close to (ξ_i, \mathcal{ST}) . We write $\Sigma_i(\sigma, \mathbf{r})$ it. Then we can uniquely choose

$$\mathcal{I}_{i,a}^d(\sigma, \mathbf{r}) : K_{i,a}^d(\xi'_i) \rightarrow \Sigma_i(\sigma, \mathbf{r}) \quad (12.60)$$

as (12.40) which depends continuously on (σ, \mathbf{r}) and becomes (12.59) when $(\sigma, \mathbf{r}) = (\mathbf{0}, \mathbf{0})$. We can choose a similar map for the sphere component in the same way.

Using this choice the map $\mathfrak{s}_\xi : V(\xi; \epsilon) \rightarrow \mathcal{E}(\xi)$ in Proposition 12.44 (2) is continuous.

The Γ_ξ equivalence of this map is proved by $\Gamma_\xi \subseteq \Gamma_{\xi_i}$ and Γ_{ξ_i} invariance of various objects in the obstruction bundle data.

The smoothness of \mathfrak{s}_ξ follows from the exponential decay estimate in the next subsection (Proposition 12.56).

The proof of Proposition 12.44 (3),(4) is now an immediate consequence of the construction. The proof of Proposition 12.44 is complete modulo the points postponed to the next subsection. \square

We thus constructed a Kuranishi chart at each point of $\mathcal{M}'(L_{12}; \vec{a}; E)$. Let $\xi_1 \in \mathcal{M}'(L_{12}; \vec{a}; E)$ and $\xi_2 \in \mathcal{M}'(L_{12}; \vec{a}; E)$ is in the image of ψ_{ξ_1} . Using the closedness of $\mathfrak{N}(\xi_1)$ we may assume $\mathbf{I}(\xi_2) \subseteq \mathbf{I}(\xi_1)$, by shrinking our Kuranishi neighborhood of ξ_1 if necessary. Then by definition $U(\xi_2, \epsilon_2) \subset U(\xi_1, \epsilon_1)$ if we choose ϵ_2 sufficiently small. We can use this fact and exponential decay estimate in the next subsection to construct a smooth coordinate change from the Kuranishi neighborhood of ξ_2 to one of ξ_1 . Thus we obtain the required Kuranishi structure.

12.4. Gluing analysis for the construction of a Kuranishi chart. In this subsection we prove Propositions 12.47 and 12.48. The proof is by gluing analysis similar to [FOOO2, FOOO9, FOOO12]. Since our compactification is slightly different from the stable map compactification used in those references, we explain the way we modify the method of previous literatures so that it works in our situation. In [FOOO2, FOOO9, FOOO12] a combination of the alternative method and the Newton's iteration was used. We follow this method in this subsection. We follow [FOOO12] since the description is the most detailed in this reference. Below we provide the detail of the formulation and the inductive scheme of the proof. Once they are clarified the estimate we need on each step of the induction is entirely similar to [FOOO12].

For the sake of simplicity of notation, we write the detail of our proof in the following special case. This case contains all the points we need to work out the general case.

We take $\Sigma_i^d = D^2$ with one boundary marked point $1 \in \partial D^2$ and two interior marked points $0, \mathfrak{z}_i \in \text{Int } D^2$. ($0 \neq \mathfrak{z}_i$.)

We take $\Sigma_i^s = S^2 = \mathbb{C} \cup \{\infty\}$ and consider three marked points $0, 1, \infty$ on it.

We put $\Sigma^d = \Sigma_1^d = \Sigma_2^d$. We regard $\mathfrak{z}_1, \mathfrak{z}_2 \in \Sigma^d$. We glue Σ_i^d and Σ_i^s at $\mathfrak{z}_i \in \Sigma_i^d$ and $0 \in \Sigma_i^s$. The points $\mathfrak{z}_1, \mathfrak{z}_2$ may or may not coincide. In case we use stable map compactification, a sphere component bubbles off when $\mathfrak{z}_1 = \mathfrak{z}_2$. However, in our compactification, the locus where $\mathfrak{z}_1 = \mathfrak{z}_2$ does *not* play a special role. We assume

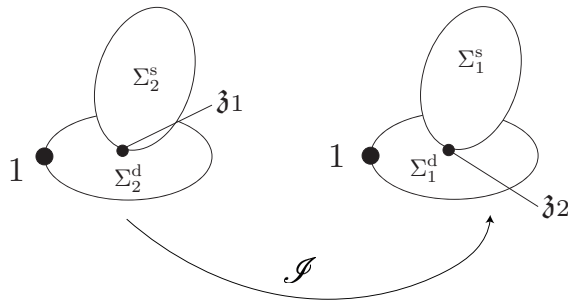

FIGURE 77. The source domain we study. (We do not draw interior marked points in the figure.)

$L_{12} \subset -X_1 \times X_2$ is an *embedded* Lagrangian submanifold. The immersed case can be worked out in a similar way, given the formulation we have provided in the last subsection. We assume L_{12} is embedded for the sake of simplicity of notation only.

We also remark that throughout this section, we use almost complex structure $-J_{X_1}$ on X_1 and J_{X_2} on X_2 , unless otherwise mentioned explicitly.

We consider families of pseudoholomorphic maps

$$\begin{aligned} u^{d, \rho^d} &= (u_1^{d, \rho^d}, u_2^{d, \rho^d}) : (\Sigma^d, \partial \Sigma^d) \rightarrow (-X_1 \times X_2, L_{12}), \\ u_i^{s, \rho_i^s} &: \Sigma_i^s \rightarrow X_i, \end{aligned} \tag{12.61}$$

parametrized by $\rho^d \in \mathcal{V}^d$, $\rho_i^s \in \mathcal{V}_i^s$.

Remark 12.51. In the case we are studying here there are two marked points and one nodal point on the sphere bubble. We identify them as $0, 1, \infty$. Therefore the

domain coordinate is canonically determined. In particular the maps $u^{d,\rho^d}, u_i^{s,\rho_i^s}$ are determined by ρ^d and ρ_i^s uniquely. See Remark 12.57, for an explanation of the case when the domain of the map is not stable. \diamond

Let $\mathfrak{o} \in \text{Int } D^2 \setminus 0$ and \mathfrak{D} a small open neighborhood of it. Let $\mathbf{0} \in \mathcal{V}^d, \mathbf{0} \in \mathcal{V}_i^s$. We assume

$$u_i^{d,\mathbf{0}}(\mathfrak{o}) = u_i^{s,\mathbf{0}}(0),$$

for $i = 1, 2$.

We consider the following element ξ_0 of $\mathcal{M}'_{1,2,2}(L_{12}; (\text{diag}); E)$. Here diag denotes the diagonal component of $L_{12} \times_{X_1 \times X_2} L_{12}$ (which is actually the only component of it) and

$$E = \sum_{i=1}^2 (-1)^i \int_{\Sigma_i^d} (u_i^{d,\mathbf{0}})^* \omega_i + \sum_{i=1}^2 (-1)^i \int_{\Sigma_i^s} (u_i^{s,\mathbf{0}})^* \omega_i.$$

The source curve of ξ_0 is a pair of Σ_i^d and Σ_i^s glued at $\mathfrak{o} \in \Sigma_i^d$ and $0 \in \Sigma_i^s$. The point $1 \in \Sigma^d$ is its boundary marked point, the point $0 \in \Sigma^d$ is an interior marked point of first kind, and the points $1, \infty \in \Sigma_i^s$ are interior marked points of second kind. \mathcal{S} is the identity map $\Sigma_1^d = \Sigma^d = \Sigma_2^d$. The maps u_i are $u_i^{d,\mathbf{0}}, u_i^{s,\mathbf{0}}$ on each of the components.

We study a neighborhood of ξ_0 in $\mathcal{M}'_{1,2,2}(L_{12}; (\text{diag}); E)$.

Definition 12.52. We consider the set \mathcal{V} consisting of $(\rho^d, \rho_1^s, \rho_2^s, \mathfrak{z}_1, \mathfrak{z}_2)$ such that:

- (1) $\rho^d \in \mathcal{V}^d, \rho_i^s \in \mathcal{V}_i^s$.
- (2) $\mathfrak{z}_1, \mathfrak{z}_2 \in \mathfrak{D}$.
- (3) $u_i^{d,\rho^d}(\mathfrak{z}_i) = u_i^{s,\rho_i^s}(0)$ for $i = 1, 2$.

\diamond

We may regard \mathcal{V} as a fiber product:

$$\mathcal{V} = (\mathcal{V}^d \times \mathfrak{D} \times \mathfrak{D}) \times_{X_1 \times X_2} (\mathcal{V}_1^s \times \mathcal{V}_2^s). \tag{12.62}$$

We work under the following assumptions.

Assumption 12.53. (1) $\mathcal{V}^d, \mathcal{V}_1^s$ and \mathcal{V}_2^s are smooth manifolds. Moreover the linearizations of the non-linear Cauchy-Riemann equations

$$\begin{aligned} D_{u^{d,\rho^d}} \bar{\partial} : C^\infty((\Sigma^d; \partial \Sigma^d); ((u^{d,\rho^d})^* T(X_1 \times X_2), (u^{d,\rho^d})^* T L_{12})) \\ \rightarrow C^\infty(\Sigma^d, (u^{d,\rho^d})^* T(X_1 \times X_2) \otimes \Lambda^{0,1}) \end{aligned}$$

and

$$D_{u_i^{s,\rho_i^s}} \bar{\partial} : C^\infty(\Sigma_i^s; (u_i^{s,\rho_i^s})^* T X_i) \rightarrow C^\infty(\Sigma^d, (u_i^{s,\rho_i^s})^* T X_i \otimes \Lambda^{0,1})$$

are surjective.

- (2) The fiber product (12.62) is transversal.

\diamond

Note that Assumption 12.53 implies that \mathcal{V} is a smooth manifold.

Remark 12.54. In the general situation we introduce obstruction bundles and use the extended moduli space in place of $\mathcal{V}^d, \mathcal{V}_i^s$, so that a similar condition as Assumption 12.53 holds. The way to introduce obstruction bundles is explained in detail in the last subsection. Then the way to include the obstruction bundle in the gluing analysis is the same as [FOOO12] etc. So, for the sake of simplicity

of notation, we restrict ourselves to the case when Assumption 12.53 is satisfied in this subsection. \diamond

We next recall the source gluing map in our situation.

Let c be a small positive number. We define a map $\varphi_{\mathfrak{z}_i}^d : D^2 \rightarrow \Sigma^d$ by

$$\varphi_{\mathfrak{z}_i}^d(z) = cz + \mathfrak{z}_i. \quad (12.63)$$

We also define $\varphi_i^s : D^2 \rightarrow \Sigma_i^s$ by

$$\varphi_i^s(z) = cz. \quad (12.64)$$

They are analytic families of coordinates and are extendable. We use them to define the source gluing map (12.12). Using also Lemma 12.33 we obtain

$$(\Sigma_1(\mathfrak{z}_1, \mathfrak{r}_1), \Sigma_2(\mathfrak{z}_2, \mathfrak{r}_2), \mathcal{S}_{\mathfrak{z}_1, \mathfrak{z}_2, \mathfrak{r}_1, \mathfrak{r}_2}), \quad (12.65)$$

for $\mathfrak{r}_1, \mathfrak{r}_2 \in D^2$. Here $\Sigma_i(\mathfrak{z}_i, \mathfrak{r}_i)$ is obtained by gluing Σ_i^d and Σ_i^s by the gluing parameter \mathfrak{r}_i using coordinates $\varphi_{\mathfrak{z}_i}^d$ and φ_i^s . $\mathcal{S}_{\mathfrak{z}_1, \mathfrak{z}_2, \mathfrak{r}_1, \mathfrak{r}_2} : \Sigma_1^0(\mathfrak{z}_1, \mathfrak{r}_1) \rightarrow \Sigma_2^0(\mathfrak{z}_2, \mathfrak{r}_2)$ is a biholomorphic map obtained in Lemma 12.33 by extending identity map.

Proposition 12.55. *We assume Assumption 12.53. Then for sufficiently small ϵ there exists a map*

$$\mathcal{G} : \mathcal{V} \times D^2(\epsilon) \times D^2(\epsilon) \rightarrow \mathcal{M}'_{1,2,2}(L_{12}; (\text{diag}); E) \quad (12.66)$$

with the following properties.

- (1) *The source object of $\mathcal{G}((\rho^d, \rho_1^s, \rho_2^s, \mathfrak{z}_1, \mathfrak{z}_2), (\mathfrak{r}_1, \mathfrak{r}_2))$ is (12.65).*
- (2) *\mathcal{G} is a homeomorphism onto a neighborhood of ξ_0 .*

\diamond

Proposition 12.55 is a special case of Proposition 12.44 (1). To prove Proposition 12.44 (2)(3)(4), Propositions 12.47, 12.48 and the smoothness of coordinate change, we use the next Proposition 12.56. To state it we need notations.

We take a small open set $\mathfrak{D}^+ \subset \Sigma^d$ which contains the closure of c -neighborhood of \mathfrak{D} . We put

$$K_{1,-}^d = K_{2,-}^d = K_-^d = \Sigma^d \setminus \mathfrak{D}^+ \quad (12.67)$$

and

$$K_i^s = \Sigma_i^s \setminus \text{Im } \varphi_i^s. \quad (12.68)$$

We may regard

$$K_{i,-}^d, K_i^s \subset \Sigma_i(\mathfrak{r})$$

for all \mathfrak{r} .

Let

$$u_i^{(\rho^d, \rho_1^s, \rho_2^s, \mathfrak{z}_1, \mathfrak{z}_2), (\mathfrak{r}_1, \mathfrak{r}_2)} : \Sigma_i(\mathfrak{r}) \rightarrow X_i$$

be the map part of $\mathcal{G}((\rho^d, \rho_1^s, \rho_2^s, \mathfrak{z}_1, \mathfrak{z}_2), (\mathfrak{r}_1, \mathfrak{r}_2))$. We denote its restriction to $K_{i,-}^d, K_i^s$ by

$$\begin{aligned} (\text{Res}_{i,-}^d \circ \mathcal{G})((\rho^d, \rho_1^s, \rho_2^s, \mathfrak{z}_1, \mathfrak{z}_2), (\mathfrak{r}_1, \mathfrak{r}_2)) &\in C^\infty(K_{i,-}^d, X_i) \\ (\text{Res}_i^s \circ \mathcal{G})((\rho^d, \rho_1^s, \rho_2^s, \mathfrak{z}_1, \mathfrak{z}_2), (\mathfrak{r}_1, \mathfrak{r}_2)) &\in C^\infty(K_i^s, X_i) \end{aligned} \quad (12.69)$$

and

$$\begin{aligned} &(\text{Res}_-^d \circ \mathcal{G})((\rho^d, \rho_1^s, \rho_2^s, \mathfrak{z}_1, \mathfrak{z}_2), (\mathfrak{r}_1, \mathfrak{r}_2)) \\ &= ((\text{Res}_{1,-}^d \circ \mathcal{G}), (\text{Res}_{2,-}^d \circ \mathcal{G}))((\rho^d, \rho_1^s, \rho_2^s, \mathfrak{z}_1, \mathfrak{z}_2), (\mathfrak{r}_1, \mathfrak{r}_2)) \\ &\in C^\infty(K_-^d, X_1 \times X_2). \end{aligned} \quad (12.70)$$

We define $T_i \in \mathbb{R}_+$, $\theta_i \in [0, 1]$ by

$$\mathfrak{r}_i = \exp(-10\pi T_i - 2\pi\sqrt{-1}\theta_i). \quad (12.71)$$

Proposition 12.56. *For $m > 10$ there exists $\epsilon_{m,n} > 0$ and $C_{m,n}, c_{m,n} > 0$ such that the following holds if $\epsilon < \epsilon_{m,n}$. (Note ϵ is the number in Proposition 12.55.)*

(1)

$$\left\| \nabla_{(\rho^d, \rho_1^s, \rho_2^s, \mathfrak{z}_1, \mathfrak{z}_2)}^n \frac{\partial^{\ell_1}}{\partial T_1^{\ell_1}} \frac{\partial^{\ell'_1}}{\partial \theta_1^{\ell'_1}} \frac{\partial^{\ell_2}}{\partial T_2^{\ell_2}} \frac{\partial^{\ell'_2}}{\partial \theta_2^{\ell'_2}} (\text{Res}_-^d \circ \mathcal{G}) \right\|_{L_{m-\ell}^2} \leq C_{m,n} e^{-c_{m,n} T_1}$$

if $\ell = \ell_1 + \ell'_1 + \ell_2 + \ell'_2 \leq m - 2$, $\ell_1, \ell'_1, \ell_2, \ell'_2 \in \mathbb{Z}_{\geq 0}$ and $\ell_1 + \ell'_1 > 0$. Here $\nabla_{(\rho^d, \rho_1^s, \rho_2^s, \mathfrak{z}_1, \mathfrak{z}_2)}^n$ is n -th derivative with respect to $(\rho^d, \rho_1^s, \rho_2^s, \mathfrak{z}_1, \mathfrak{z}_2)$.

(2)

$$\left\| \nabla_{(\rho^d, \rho_1^s, \rho_2^s, \mathfrak{z}_1, \mathfrak{z}_2)}^n \frac{\partial^{\ell_1}}{\partial T_1^{\ell_1}} \frac{\partial^{\ell'_1}}{\partial \theta_1^{\ell'_1}} \frac{\partial^{\ell_2}}{\partial T_2^{\ell_2}} \frac{\partial^{\ell'_2}}{\partial \theta_2^{\ell'_2}} (\text{Res}_-^d \circ \mathcal{G}) \right\|_{L_{m-\ell}^2} \leq C_{m,n} e^{-c_{m,n} T_2}$$

if $\ell = \ell_1 + \ell'_1 + \ell_2 + \ell'_2 \leq m - 2$, $\ell_1, \ell'_1, \ell_2, \ell'_2 \in \mathbb{Z}_{\geq 0}$ and $\ell_2 + \ell'_2 > 0$.

(3) The same inequality as (1)(2) holds for $\text{Res}_i^s \circ \mathcal{G}$, $i = 1, 2$.

◇

We can use the exponential decay estimate such as Proposition 12.56 in the same way as [FOOO12, Chapter 8] to prove Propositions 12.47, 12.44 (2)(3)(4), Proposition 12.48 and the smoothness of coordinate changes. So to complete the proof of Theorem 12.24 it remains to prove Propositions 12.55 and 12.56. The rest of this subsection is occupied by their proofs. \square

Remark 12.57. As we mentioned in Remark 12.51 we study the case when there are marked points on the sphere bubbles so that the domain is stable in Propositions 12.55 and 12.56. In the general case we follow the method of [FOOn, Appendix] and proceed as follows. (This is a special case of the method we explained in the last subsection.) Suppose we consider an element ξ'_0 of $\mathcal{M}'_{1,0,0}(L_{12}; (\text{diag}); E)$ which is similar to the element ξ_0 except we forget the 4 marked points on the sphere bubbles. We consider the case when the maps $u_i^{s;0}$ on the sphere bubbles which are parts of the data consisting ξ'_0 is non-constant. We fix two points on each of the sphere bubbles such that $u_i^{s;0}$ is an immersion at those points. We change the objects by automorphisms so that the marked points we add are $1, \infty \in S^2$. We denote by $1_i, \infty_i$ ($i = 1, 2$) those added marked points (of second kind) on the sphere bubbles S_i^2 . The nodal points on the sphere bubbles are identified with 0. We take codimension 2 submanifolds $\mathcal{N}_{i,1}, \mathcal{N}_{i,\infty}$ of X_i which intersects with the image of the map $u_i^{s;0}$ transversally at 1_i and ∞_i .

We consider ξ'_0 with those extra four marked points added as an element ξ_0 of $\mathcal{M}'_{1,2,2}(L_{12}; (\text{diag}); E)$. We can then apply Propositions 12.55 and 12.56. To obtain a map

$$\mathcal{G} : \mathcal{V} \times D^2(\epsilon) \times D^2(\epsilon) \rightarrow \mathcal{M}'_{1,2,2}(L_{12}; (\text{diag}); E).$$

Then the Kuranishi neighborhood of ξ'_0 of $\mathcal{M}'_{1,0,0}(L_{12}; (\text{diag}); E)$ is the smooth submanifold of $\mathcal{V} \times D^2(\epsilon) \times D^2(\epsilon)$ which is cut out by the conditions

$$(\text{ev}_{i,1} \circ \mathcal{G})(x) \in \mathcal{N}_{i,1}, \quad (\text{ev}_{i,\infty} \circ \mathcal{G})(x) \in \mathcal{N}_{i,\infty}. \quad (12.72)$$

Here $\text{ev}_{i,1}$, $\text{ev}_{i,\infty}$ are the evaluation maps : $\mathcal{M}'_{1,2,2}(L_{12}; (\text{diag}); E) \rightarrow X_i$ at the marked points corresponding to 1_i and ∞_i .

We remark that the Kuranishi neighborhood of ξ'_0 obtained in this way depends on the choice of additional 4 marked points on the sphere bubbles and also to the choice of transversals $\mathcal{N}_{i,1}, \mathcal{N}_{i,\infty}$. However using Proposition 12.56 we can show the Kuranishi neighborhood obtained is independent of such choices in a neighborhood of ξ'_0 up to diffeomorphism. This independence is a special case of the smoothness of the coordinate change, which is proved by using Proposition 12.56. See [FOOO12, Chapter 8].

We will discuss this example more in Remark 12.76.

Proof of Propositions 12.55 and 12.56. Proposition 12.55 is similar to [FOOO12, Theorem 3.13] and Proposition 12.56 is similar to [FOOO12, Theorem 6.4]. Their proofs are also similar.

We first modify the way to describe the disk component of the source curve in a way convenient for our gluing analysis.

Definition 12.58. We take a $\mathfrak{z} \in \mathfrak{D}$ parametrized smooth family of diffeomorphisms $h_{\mathfrak{z}} : D^2 \rightarrow D^2$ with the following properties:

- (1) $h_{\mathfrak{z}}$ is the identity map outside \mathfrak{D}^+ . Here \mathfrak{D}^+ is an open subset of D^2 which contains the closure of \mathfrak{D} and is disjoint from $\{0\} \cup \partial D^2$.
- (2) $h_{\mathfrak{z}} \circ \varphi_{\mathfrak{o}}^{\text{d}} = \varphi_{\mathfrak{z}}^{\text{d}}$. In particular $h_{\mathfrak{z}}(\mathfrak{o}) = \mathfrak{z}$.

We pull back the standard complex structure j of D^2 by $h_{\mathfrak{z}}$ to obtain

$$j_{\mathfrak{z}} = h_{\mathfrak{z}}^* j. \quad (12.73)$$

◇

We remark $((D^2, j), (1, 0, \mathfrak{z}))$ is isomorphic to $((D^2, j_{\mathfrak{z}}), (1, 0, \mathfrak{o}))$. In other words we move a complex structure j in place of moving a marked point \mathfrak{z} . In this identification the map \mathcal{S} becomes

$$\mathcal{S}_{\mathfrak{z}_1, \mathfrak{z}_2} = h_{\mathfrak{z}_2} \circ (h_{\mathfrak{z}_1})^{-1}. \quad (12.74)$$

We put

$$u_i^{\text{d}, \rho^{\text{d}}, \mathfrak{z}_i} = u_i^{\text{d}, \rho^{\text{d}}} \circ h_{\mathfrak{z}_i} \quad (12.75)$$

and $u^{\text{d}, \rho^{\text{d}}, \mathfrak{z}} = (u_1^{\text{d}, \rho^{\text{d}}, \mathfrak{z}_1}, u_2^{\text{d}, \rho^{\text{d}}, \mathfrak{z}_2})$. The map $u_i^{\text{d}, \rho^{\text{d}}, \mathfrak{z}_i}$ is holomorphic with respect to the complex structure $j_{\mathfrak{z}_i}$ of the source.

Hereafter to simplify the notation we write $\rho = (\rho^{\text{d}}, \rho^{\text{s}}, \mathfrak{z}_1, \mathfrak{z}_2)$ and write $u_i^{\text{d}, \rho}$ etc. in place of $u_i^{\text{d}, \rho^{\text{d}}, \mathfrak{z}}$ etc.

We remark

$$\mathcal{V} \cong \{\rho \mid u_i^{\text{d}, \rho}(\mathfrak{o}) = u_i^{\text{s}, \rho}(0), \text{ for } i = 1, 2\}. \quad (12.76)$$

We use the cylindrical coordinate on neighborhoods of $\mathfrak{o} \in \Sigma^{\text{d}}$ and of $0 \in \Sigma_i^{\text{s}}$, which we describe below.

Hereafter we write φ^{d} in place of $\varphi_{\mathfrak{o}}^{\text{d}}$. Let $z \in D^2$ and $p = \varphi^{\text{d}}(z) \in \Sigma^{\text{d}}$. We then define $\tau'(p) \in [0, \infty)$ and $t'(p) \in [0, 1)$ by

$$2\pi(\tau'(p) + \sqrt{-1}t'(p)) = -\log z. \quad (12.77)$$

Let $q_i = \varphi_i^{\text{s}}(w_i) \in \Sigma_i^{\text{s}}$ We then define $\tau_i''(q_i) \in (-\infty, 0]$ and $t_i''(q_i) \in [0, 1)$ by

$$2\pi(\tau_i''(q_i) + \sqrt{-1}t_i''(q_i)) = \log w_i. \quad (12.78)$$

We glue Σ^d with Σ_i^s by the gluing parameter \mathbf{r}_i as follows. If $p = \varphi^d(z)$ and $q_i = \varphi_i^s(w_i)$ we identify p and q if and only if

$$zw_i = \mathbf{r}_i. \quad (12.79)$$

See Definition 12.28. In view of (12.71) the condition (12.79) is equivalent to

$$\begin{aligned} \tau_i'' - \tau' &= 10T_i, \\ t_i'' - t' &\equiv \theta_i \pmod{\mathbb{Z}}. \end{aligned} \quad (12.80)$$

Compare [FOOO12, (6.2) and (6.3)] and see Figure 78. We use Riemannian metric

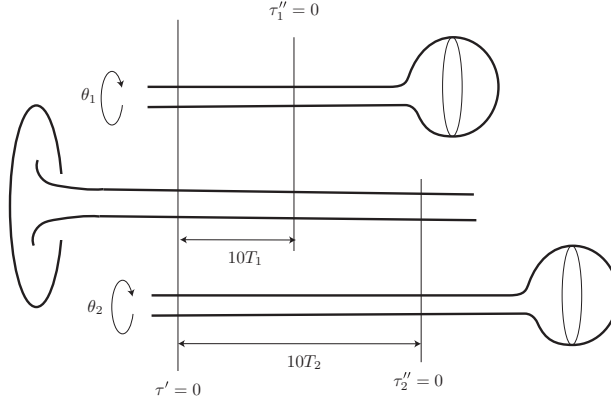

FIGURE 78. Gluing disk and 2 spheres.

on $\Sigma^d \setminus \{\mathfrak{o}\}$ (resp. $\Sigma_i^s \setminus \{0\}$) such that on the image of φ^d (resp. φ_i^s) it is isometric to $[0, \infty) \times S^1$ (resp. $(-\infty, 0] \times S^1$) with (τ', t') (resp. (τ_i'', t_i'')) as coordinates.

We introduce the weighted Sobolev spaces which we use for our gluing analysis. We follow [FOOO12, Section 3] here. For $\rho \in \mathcal{V}$ we put $u^{d,\rho}(\mathfrak{o}) = p^\rho$. We take sufficiently small positive number δ and fix it. (δ is taken to be small compared to the decay rate of the pseudo-holomorphic curve at the neck. For example $\delta < 1/100$. See [FOOO12, Section 2] for example.)

We take and fix connections of X_1 and of X_2 and then direct product connection of $X_1 \times X_2$. Let $\text{Pal}_{\mathfrak{o}}$ be the parallel transport of the tangent bundle of $X_1 \times X_2$ with respect to this connection. We denote by the same symbol the parallel transport of the tangent bundle of X_i . We denote by $\text{Pal}_{\mathfrak{o}}^J$ the complex linear part of it. (We remark that the almost complex structure we use is $-J_{X_1} \oplus J_{X_2}$.)

Definition 12.59. We denote by $W_{m+1,\delta}^2((\Sigma^d; \partial\Sigma^d), (u^{d,\rho})^*T(X_1 \times X_2); (u^{d,\rho})^*T(L_{12}))$ the set of all pairs (s, v) such that:

- (1) s is a section of $(u^{d,\rho})^*T(X_1 \times X_2)$ on $\Sigma^d \setminus \{\mathfrak{o}\}$ which is locally of L_{m+1}^2 class.
- (2) $v \in T_{p^\rho}(X_1 \times X_2)$.
- (3) $s(z) \in T_{u^{d,\rho}(z)}L_{12}$ if $z \in \partial\Sigma^d$.
- (4)

$$\sum_{k=0}^{m+1} \int_0^\infty d\tau' \int_{S^1} e^{2\delta\tau'} |\nabla^k (s - v^{\text{pal}})|^2 dt' < \infty. \quad (12.81)$$

Here $v^{\text{pal}}(\tau', t') = (\text{Pal}_{\mathfrak{o}})_{\mathfrak{o}}^{u^{d,\rho}(\tau', t')}(v)$.

The $W_{m+1,\delta}^2$ norm of (s, v) is by definition

$$\|(s, v)\|_{W_{m+1,\delta}^2}^2 := \sum_{k=0}^{m+1} \int_{\Sigma^d \setminus \varphi_0^d(D^2)} |\nabla^k(s)|^2 + (12.81) + |v|^2. \quad (12.82)$$

The L^2 inner product between two elements (s_1, v_1) and (s_2, v_2) of the space $W_{m+1,\delta}^2((\Sigma^d; \partial\Sigma^d), (u^{d,\rho})^*T(X_1 \times X_2); (u^{d,\rho})^*T(L_{12}))$ is defined by

$$\begin{aligned} \langle\langle (s_1, v_1), (s_2, v_2) \rangle\rangle_{L^2} &= \int_{[0,\infty) \times S^1} (s_1 - v_1^{\text{Pal}}, s_2 - v_2^{\text{Pal}}) \\ &+ \int_{\Sigma^d \setminus \varphi_0^d(D^2)} (s_1, s_2) + (v_1, v_2). \end{aligned} \quad (12.83)$$

We denote by $W_{m+1,\delta}^2((\Sigma^s), (u_i^{s,\rho})^*TX_i)$ the set of all pairs (s, v) such that:

- (1) s is a section of $(u_i^{s,\rho})^*TX_i$ on $\Sigma_i^s \setminus \{0\}$ which is locally of L_{m+1}^2 class.
- (2) $v \in T_{\rho^s}X_i$.
- (3)

$$\sum_{k=0}^{m+1} \int_{-\infty}^0 d\tau'' \int_{t'' \in S^1} e^{-2\delta\tau''} |\nabla^k(s - v^{\text{pal}})|^2 dt'' < \infty. \quad (12.84)$$

Here $v^{\text{pal}}(\tau'', t'') = (\text{Pal}_{\mathfrak{o}})_{\mathfrak{o}}^{u_i^{s,\rho}(\tau'', t'')}(v)$.

The $W_{m+1,\delta}^2$ norm and the L^2 inner product is defined in a similar way. \diamond

Definition 12.60. We denote by $L_{m,\delta}^2(\Sigma_i^d, (u_i^{d,\rho})^*TX_i \otimes \Lambda_\rho^{0,1})$ the set of all s such that:

- (1) s is a section of $(u_i^{d,\rho})^*TX_i \otimes \Lambda_\rho^{0,1}(\Sigma^d, j_{3_i})$ on $\Sigma^d \setminus \{\mathfrak{o}\}$ which is locally of L_m^2 class. Note that we use the complex structure j_{3_i} to define the notion of $(0, 1)$ forms on Σ^d .
- (2)

$$\sum_{k=0}^m \int_0^\infty d\tau' \int_{S^1} e^{2\delta\tau'} |\nabla^k s|^2 dt' < \infty. \quad (12.85)$$

The square of the L_m^2 norm of s is by definition the sum of (12.85) and the square of L_m^2 norm of the restriction of s to $\Sigma^d \setminus \varphi^d(D^2)$.

The weighted Sobolev space $L_{m,\delta}^2(\Sigma_i^s, (u_i^{s,\rho})^*TX_i \otimes \Lambda_\rho^{0,1})$ of sections of $(u_i^{s,\rho})^*TX_i \otimes \Lambda_\rho^{0,1}(\Sigma^s, j)$ and its $L_{m,\delta}^2$ norm is defined in a similar way.

The direct sum

$$\bigoplus_{i=1,2} L_{m,\delta}^2(\Sigma_i^d, (u_i^{d,\rho})^*TX_i \otimes \Lambda_\rho^{0,1})$$

is denoted by $L_{m,\delta}^2(\Sigma^d, (u^{d,\rho})^*T(X_1 \oplus X_2) \otimes \Lambda_\rho^{0,1})$, by a slight abuse of notation. (Note that the complex structure we use for Σ^d is different between X_1 factor and X_2 factor.) \diamond

We next define the linearization operator of the non-linear Cauchy-Riemann equation.

We use the parallel transport and the exponential map for this purpose.

Definition 12.61. We take a $z \in \Sigma^d$ depending family of connections ∇^z of the tangent bundle of $X_1 \times X_2$ such that:

- (1) If $z \in \mathfrak{D}^+$ then ∇^z coincides with direct product connection mentioned right above Definition 12.59.
- (2) There exists a neighborhood of $\partial\Sigma^d$ such that if z is in this neighborhood then ∇^z coincides with a connection ∇^0 for which L_{12} is totally geodesic.

Let

$$\text{Exp}^z : T(X_1 \times X_2) \rightarrow (X_1 \times X_2)^2 \quad (12.86)$$

be the exponential map defined by ∇^z .

If $z \in \mathfrak{D}^+$ item (1) implies that (12.86) becomes a direct product of two exponential maps:

$$\text{Exp}_i : TX_i \rightarrow (X_i)^2. \quad (12.87)$$

The restriction of the exponential maps are diffeomorphisms onto a neighborhood of the diagonal, which contain $U(\Delta_{X_i})$ etc. We denote their inverses by

$$\begin{aligned} E^z : U(\Delta_{X_1 \times X_2}) &\rightarrow T(X_1 \times X_2) \\ E_i : U(\Delta_{X_i}) &\rightarrow TX_i. \end{aligned} \quad (12.88)$$

Let $x, y \in X_1 \times X_2$ which is sufficiently close each other. Then we can use the ∇^z -parallel transport with respect to the ∇^z geodesic to define

$$(\text{Pal}_z)_x^y : T_x(X_1 \times X_2) \rightarrow T_y(X_1 \times X_2).$$

We denote by $(\text{Pal}_z)_x^y$ its complex linear part.

(1) implies that it splits into direct product if $z \in \mathfrak{D}^+$. (2) implies that if $x, y \in L_{12}$ and $z \in \partial\Sigma^d$ then

$$(\text{Pal}_z)_x^y(T_x L_{12}) \subset T_y L_{12}. \quad (12.89)$$

◇

Remark 12.62. Note that there may not exist a connection satisfying both of Definition 12.61 (1)(2). This is the reason why we use z dependent family of connections.◇

Definition 12.63. We define an operator

$$\begin{aligned} D_{u_i^{d,\rho}}^\rho \bar{\partial} &:= (D_{u_i^{d,\rho}}^\rho \bar{\partial}, D_{u_i^{d,\rho}}^\rho \bar{\partial}) \\ &: W_{m+1,\delta}^2((\Sigma^d; \partial\Sigma^d), (u_i^{d,\rho})^* T(X_1 \times X_2); (u_i^{d,\rho})^* T(L_{12})) \\ &\rightarrow L_{m,\delta}^2(\Sigma^d, (u_i^{d,\rho})^* T(X_1 \oplus X_2) \otimes \Lambda_\rho^{0,1}) \end{aligned} \quad (12.90)$$

as follows. Let $(s, v) \in W_{m+1,\delta}^2((\Sigma^d; \partial\Sigma^d), (u_i^{d,\rho})^* T(X_1 \times X_2); (u_i^{d,\rho})^* T(L_{12}))$.

Let $z \in \mathfrak{D}^+$. We put $s = (s_1, s_2)$ where s_i is a section of $(u_i^{d,\rho})^* TX_i$. Then we define

$$(D_{u_i^{d,\rho}}^\rho \bar{\partial})(s, v) := \left. \frac{d}{dt} \mathcal{P}^{-1}(\bar{\partial}_{j_{3i}} \text{Exp}_i(u_i^{d,\rho}, ts_i)) \right|_{t=0} \quad (12.91)$$

in a neighborhood of z . Here $\text{Exp}_i(u_i^{d,\rho}, ts_i)$ is a map $z \mapsto \text{Exp}_i(u_i^{d,\rho}(z), ts_i(z))$. Then $\bar{\partial}_{j_{3i}} \text{Exp}_i(u_i^{d,\rho}, ts_i)$ at z is an element of $T_{y(t)} X_i \otimes \Lambda_x^{0,1}(\Sigma_i^d, j_{3i})$, where $y(t) = \text{Exp}_i(u_i^{d,\rho}(z), ts_i(z))$. \mathcal{P} is induced by $(\text{Pal}_z)_x^{y(t)}$ where $x = u_i^{d,\rho}(z)$. (We remark that $\text{Pal}_z = \text{Pal}_0$ in our case.)

Let $z \notin \mathfrak{D}^+$. Then the complex structure j_{3i} is the standard complex structure j in a neighborhood of z . We define

$$(D_{u_i^{d,\rho}}^\rho \bar{\partial})(s, v) := \left. \frac{d}{dt} \mathcal{P}_z^{-1}(\bar{\partial} \text{Exp}_z(u_i^{d,\rho}, ts)) \right|_{t=0} \quad (12.92)$$

in a neighborhood of z . The notation in (12.92) is similar to (12.90). We however remark that in (12.92) we work on the product space $X_1 \times X_2$ and use z parametrized family of connections to define the exponential map and the parallel transport.

By Definition 12.61 (1) it is easy to see that (12.92) coincides with (12.90) on the overlapped part and define (12.89).

The definition of the linearization map

$$D_{u_i^{s,\rho}}^\rho \bar{\partial} : W_{m+1,\delta}^2(\Sigma_i^s, (u_i^{s,\rho})^*TX_i) \rightarrow L_{m,\delta}^2(\Sigma_i^s, (u_i^{s,\rho})^*TX_i \otimes \Lambda^{0,1}) \quad (12.93)$$

is similar to and easier than (12.89). \diamond

Definition 12.64. We denote by $W(m; u^{d,\rho}, u_1^{s,\rho}, u_2^{s,\rho})$ the subspace of direct sum

$$\begin{aligned} & W_{m+1,\delta}^2((\Sigma^d; \partial\Sigma^d), (u^{d,\rho})^*T(X_1 \times X_2); (u^{d,\rho})^*T(L_{12})) \\ & \oplus \bigoplus_{i=1,2} W_{m+1,\delta}^2(\Sigma_i^s, (u_i^{s,\rho})^*TX_i) \end{aligned}$$

consisting $((s, v), (s_1, v_1), (s_2, v_2))$ with

$$v = (v_1, v_2). \quad (12.94)$$

We consider the direct sum:

$$\begin{aligned} & L_{m,\delta}^2(\Sigma^d, (u^{d,\rho})^*T(X_1 \oplus X_2) \otimes \Lambda_\rho^{0,1}) \\ & \oplus \bigoplus_{i=1,2} L_{m,\delta}^2(\Sigma_i^s, (u_i^{s,\rho})^*TX_i \otimes \Lambda^{0,1}). \end{aligned} \quad (12.95)$$

We define

$$D_{u^{d,\rho}, u_1^{s,\rho}, u_2^{s,\rho}}^\rho \bar{\partial} : W(m; u^{d,\rho}, u_1^{s,\rho}, u_2^{s,\rho}) \rightarrow (12.95) \quad (12.96)$$

as the restriction of the direct sum of (12.89) and (12.93). \diamond

Lemma 12.65. *The map $D_{u^{d,\rho}, u_1^{s,\rho}, u_2^{s,\rho}}^\rho \bar{\partial}$ in (12.96) is surjective if δ is sufficiently small. \diamond*

Proof. Since we assumed Conditions 12.37 and 12.38 with trivial obstruction bundle, (that is, Assumption 12.53) this is a consequence of the standard exponential decay estimate and regularity of linear operators. \square

Definition 12.66. We denote by $\mathfrak{H}(m; u^{d,\rho}, u_1^{s,\rho}, u_2^{s,\rho})$ the L^2 orthonormal complement of the kernel of $D_{u^{d,\rho}, u_1^{s,\rho}, u_2^{s,\rho}}^\rho \bar{\partial}$ in $W(m; u^{d,\rho}, u_1^{s,\rho}, u_2^{s,\rho})$. \diamond

We next introduce bump functions we use in our gluing analysis. (This part is similar to [FOOO12, Section 3.1].)

Notation 12.67. Hereafter we use $[a, b]_{\tau'}$, $[a, b]_{\tau_1''}$, $[a, b]_{\tau_2''}$ for the interval $[a, b]$ to specify the coordinates τ' , τ_1'' or τ_2'' we use.

Definition 12.68. We define $\mathcal{A}_{T_i}^i$, $\mathcal{X}_{T_i}^i$, $\mathcal{B}_{T_i}^i$ for $i = 1, 2$ as follows.

$$\begin{aligned} \mathcal{A}_{T_i}^i &= [4T_i - 1, 4T_i + 1]_{\tau'} \times S^1 = [-6T_i - 1, -6T_i + 1]_{\tau_1''} \times S^1, \\ \mathcal{X}_{T_i}^i &= [5T_i - 1, 5T_i + 1]_{\tau'} \times S^1 = [-5T_i - 1, -5T_i + 1]_{\tau_1''} \times S^1, \\ \mathcal{B}_{T_i}^i &= [6T_i - 1, 6T_i + 1]_{\tau'} \times S^1 = [-4T_i - 1, -4T_i + 1]_{\tau_2''} \times S^1. \end{aligned} \quad (12.97)$$

They may be regarded as subsets of Σ_i^d or of Σ_i^s or of $\Sigma_i(\mathbf{r})$. (Here $\mathbf{r} = (\mathbf{r}_1, \mathbf{r}_2)$ and T_i is related to \mathbf{r}_i by (12.71).)

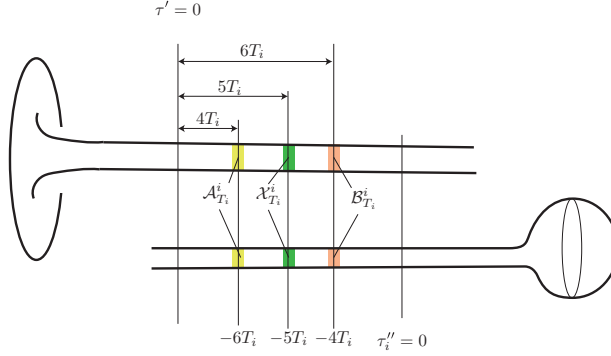
FIGURE 79. $\mathcal{A}_{T_i}^i, \mathcal{X}_{T_i}^i, \mathcal{B}_{T_i}^i$.

Let $\chi : \mathbb{R} \rightarrow [0, 1]$ be a nondecreasing smooth function such that

$$\chi(\tau) = \begin{cases} 0 & \text{if } \tau \leq -1, \\ 1 & \text{if } \tau \geq 1. \end{cases}$$

We use it to define functions on $[0, 10T_i]_{\tau'} \times S^1 \cong [-10T_i, 0]_{\tau''} \times S^1$ as follows.

$$\begin{aligned} \chi_{\mathcal{A}_{T_i}^i}^{\rightarrow}(\tau', t') &:= \chi(\tau' - 4T_i), & \chi_{\mathcal{A}_{T_i}^i}^{\rightarrow}(\tau'', t'') &:= \chi(\tau'' + 6T_i), \\ \chi_{\mathcal{X}_{T_i}^i}^{\rightarrow}(\tau', t') &:= \chi(\tau' - 5T_i), & \chi_{\mathcal{X}_{T_i}^i}^{\rightarrow}(\tau'', t'') &:= \chi(\tau'' + 5T_i), \\ \chi_{\mathcal{B}_{T_i}^i}^{\rightarrow}(\tau', t') &:= \chi(\tau' - 6T_i), & \chi_{\mathcal{B}_{T_i}^i}^{\rightarrow}(\tau'', t'') &:= \chi(\tau'' + 4T_i) \end{aligned} \quad (12.98)$$

and

$$\chi_{\mathcal{A}_{T_i}^i}^{\leftarrow} := 1 - \chi_{\mathcal{A}_{T_i}^i}^{\rightarrow}, \quad \chi_{\mathcal{X}_{T_i}^i}^{\leftarrow} := 1 - \chi_{\mathcal{X}_{T_i}^i}^{\rightarrow}, \quad \chi_{\mathcal{B}_{T_i}^i}^{\leftarrow} := 1 - \chi_{\mathcal{B}_{T_i}^i}^{\rightarrow}. \quad (12.99)$$

We can extend them outside of $[0, 10T_i]_{\tau'} \times S^1 \cong [-10T_i, 0]_{\tau''} \times S^1$ as locally constant functions and regard them as functions on Σ_i^d or on Σ_i^s or on $\Sigma_i(\mathbf{r})$. See Figure 80.

◇

Now we are ready to start our inductive construction of gluing. We discuss the case when the gluing parameters \mathbf{r}_1 and \mathbf{r}_2 are both nonzero. (In the case when $\mathbf{r}_1 = \mathbf{r}_2 = 0$, there is nothing to do. The discussion when one of $\mathbf{r}_1, \mathbf{r}_2$ is zero is similar and is omitted.)

Pregluing:

We put $u^\rho(\mathbf{o}) = p^\rho = (p_1^\rho, p_2^\rho)$. We recall $\mathbf{r} = (\mathbf{r}_1, \mathbf{r}_2)$. A pair of complex numbers \mathbf{r} corresponds to $T_1, \theta_1, T_2, \theta_2$ by (12.57). We define

$$u_{\mathbf{r},(0),i}^\rho : \Sigma_i^\rho(\mathbf{r}_i) \rightarrow X_i$$

as follows. We put $K_i^d = \Sigma_i^d \setminus \varphi_{\mathbf{o}_i}^d(D^2)$. Then

$$\Sigma_i^\rho(\mathbf{r}_i) = K_i^d \cup K_i^s \cup [0, 10T_i]_{\tau'}.$$

On $[0, 10T_i]_{\tau'} \times S^1 \cong [-10T_i, 0]_{\tau''} \times S^1$ we put

$$\begin{aligned} u_{i,\mathbf{r},(0)}^\rho(\tau', t') &= \text{Exp}_i \left(p_i^\rho, \chi_{\mathcal{B}_{T_i}^i}^{\leftarrow}(\tau', t') E_i(p_i^\rho, u_1^{\rho_1}(\tau', t')) \right. \\ &\quad \left. + \chi_{\mathcal{A}_{T_i}^i}^{\rightarrow}(\tau'', t'') E_i(p_i^\rho, u_2^{\rho_2}(\tau'', t'')) \right). \end{aligned} \quad (12.100)$$

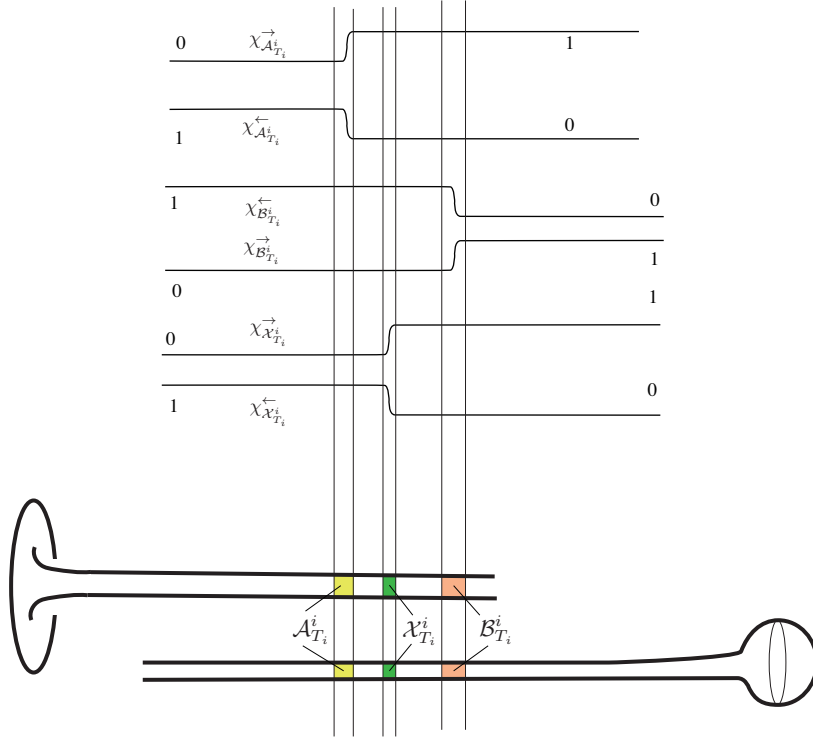

FIGURE 80. Bump functions.

Here (τ''_i, t''_i) is related to (τ', t') by (12.80). We also put $u_{\mathbf{r},(0)}^\rho = (u_{1,\mathbf{r},(0)}^\rho, u_{2,\mathbf{r},(0)}^\rho)$ with

$$u_{\mathbf{r},(0)}^\rho := u^{\mathbf{d},\rho} \quad (12.101)$$

on $K_i^{\mathbf{d}}$ and

$$u_{i,\mathbf{r},(0)}^\rho := u_i^{\mathbf{s},\rho} \quad (12.102)$$

on $K_i^{\mathbf{s}}$.

$u_{\mathbf{r},(0)}^\rho$ is an approximate solution of our pseudo-holomorphic curve equation.

Step 0-(3+4) (Separating error terms into two parts):

Definition 12.69. We define

$$\hat{u}_{\mathbf{r},(0)}^{\mathbf{d},\rho} = (\hat{u}_{1,\mathbf{r},(0)}^{\mathbf{d},\rho}, \hat{u}_{2,\mathbf{r},(0)}^{\mathbf{d},\rho}) : (\Sigma^{\mathbf{d}}, \partial\Sigma^{\mathbf{d}}) \rightarrow (-X_1 \times X_2, L_{12})$$

as follows.

$$\hat{u}_{i,\mathbf{r},(0)}^{\mathbf{d},\rho}(z) := \begin{cases} \text{Exp}_i \left(p_i^\rho, \chi_{\mathcal{B}_{T_i}^i}^{\leftarrow}(\tau' - T_i, t') \text{E}_i(p_i^\rho, u_{i,\mathbf{r},(0)}^\rho(\tau', t')) \right) & \text{if } z = (\tau', t') \in [0, 10T_i]_{\tau'} \times S^1 \\ u_{i,\mathbf{r},(0)}^\rho(z) & \text{if } z \in K_i^{\mathbf{d}} \\ p_i^\rho & \text{if } z \in [10T_i, \infty)_{\tau'} \times S^1. \end{cases} \quad (12.103)$$

We also define

$$\hat{u}_{i,\mathbf{r},(0)}^{s,\rho} : \Sigma_i^s \rightarrow X_i$$

as follows.

$$\hat{u}_{i,\mathbf{r},(0)}^{s,\rho}(z) := \begin{cases} \text{Exp}_i \left(p_i^\rho, \chi_{\mathcal{A}_{T_i}^i} \left(\tau_i'' + T_i, t_i'' \right) E_i(p_i^\rho, u_{i,\mathbf{r},(0)}^\rho(\tau_i', t_i')) \right) & \text{if } z = (\tau_i'', t_i'') \in [-10T_i, 0]_{\tau_i''} \times S^1 \\ u_{i,\mathbf{r},(0)}^\rho(z) & \text{if } z \in K_i^s \\ p_i^\rho & \text{if } z \in (-\infty, -10T_i]_{\tau_i''} \times S^1. \end{cases} \quad (12.104)$$

◇

Definition 12.70. We put

$$\begin{aligned} \text{Err}_{i,\mathbf{r},(1)}^{\rho,d} &= \chi_{\mathcal{X}_{T_i}^i} \bar{\partial}_{j_{3i}} u_{T,(0),i}^\rho, \\ \text{Err}_{i,\mathbf{r},(1)}^{\rho,s} &= \chi_{\mathcal{X}_{T_i}^i} \bar{\partial}_j u_{T,(0),i}^\rho. \end{aligned}$$

We regard them as elements of the weighted Sobolev spaces $L_{m,\delta}^2(\Sigma_i^d, (\hat{u}_{i,\mathbf{r},(0)}^{d,\rho})^* TX_i \otimes \Lambda_\rho^{0,1})$ and $L_{m,\delta}^2(\Sigma_i^s, (\hat{u}_{i,\mathbf{r},(0)}^{s,\rho})^* TX_i \otimes \Lambda_\rho^{0,1})$ respectively, by extending them to be 0 outside the support of $\chi_{\mathcal{X}_{T_i}^i}$ and $\chi_{\mathcal{X}_{T_i}^s}$, respectively. (Note that $L_{m,\delta}^2(\Sigma_i^d, (\hat{u}_{i,\mathbf{r},(0)}^{d,\rho})^* TX_i \otimes \Lambda_\rho^{0,1})$ and $L_{m,\delta}^2(\Sigma_i^s, (\hat{u}_{i,\mathbf{r},(0)}^{s,\rho})^* TX_i \otimes \Lambda_\rho^{0,1})$ are defined in the same way as Definition 12.60.) ◇

Step 1-1 (Approximate solution for linearization):

We define $W(m; \hat{u}_{\mathbf{r},(0)}^{d,\rho}, \hat{u}_{1,\mathbf{r},(0)}^{s,\rho}, \hat{u}_{2,\mathbf{r},(0)}^{s,\rho})$ in the same way as Definition 12.64. Using $(\text{Pal}_z^J)_{u^{d,\rho}(z)}^{\hat{u}_{\mathbf{r},(0)}^{d,\rho}(z)}$ and $(\text{Pal}_z^J)_{u^{s,\rho}(z)}^{\hat{u}_{i,\mathbf{r},(0)}^{s,\rho}(z)}$ we obtain a linear map

$$\Phi_{\rho,(0)} : W(m; u^{d,\rho}, u_1^{s,\rho}, u_2^{s,\rho}) \rightarrow W(m; \hat{u}_{\mathbf{r},(0)}^{d,\rho}, \hat{u}_{1,\mathbf{r},(0)}^{s,\rho}, \hat{u}_{2,\mathbf{r},(0)}^{s,\rho}).$$

(See [FOOO12, Definition 5.10 and Lemma 5.11].)

We consider the direct sum:

$$\begin{aligned} &L_{m,\delta}^2(\Sigma^d, (\hat{u}_{\mathbf{r},(0)}^{d,\rho})^* T(X_1 \oplus X_2) \otimes \Lambda_\rho^{0,1}) \\ &\oplus \bigoplus_{i=1,2} L_{m,\delta}^2(\Sigma_i^s, (\hat{u}_{i,\mathbf{r}}^{s,\rho})^* TX_i \otimes \Lambda_\rho^{0,1}). \end{aligned} \quad (12.105)$$

We define

$$D_{\hat{u}_{\mathbf{r},(0)}^{d,\rho}, \hat{u}_{1,\mathbf{r},(0)}^{s,\rho}, \hat{u}_{2,\mathbf{r},(0)}^{s,\rho}}^{\rho} \bar{\partial} : W(m; \hat{u}_{\mathbf{r},(0)}^{d,\rho}, \hat{u}_{1,\mathbf{r},(0)}^{s,\rho}, \hat{u}_{2,\mathbf{r},(0)}^{s,\rho}) \rightarrow (12.105) \quad (12.106)$$

in the same way as (12.96).

Lemma 12.71. *There exists a unique element*

$$\mathbf{V}_{\rho,(1)} = ((V_{\rho,(1)}^d, \Delta p_{\rho,(1)}), (V_{1,\rho,(1)}^s, \Delta p_{1,\rho,(1)}), (V_{2,\rho,(1)}^s, \Delta p_{2,\rho,(1)}))$$

in the image of the restriction of $\Phi_{\rho,(0)}$ to the L^2 orthogonal complement of the kernel: $\text{Ker} D_{\hat{u}_{\mathbf{r},(0)}^{d,\rho}, \hat{u}_{1,\mathbf{r},(0)}^{s,\rho}, \hat{u}_{2,\mathbf{r},(0)}^{s,\rho}}^{\rho} \bar{\partial}$ in $W(m; \hat{u}_{\mathbf{r},(0)}^{d,\rho}, \hat{u}_{1,\mathbf{r},(0)}^{s,\rho}, \hat{u}_{2,\mathbf{r},(0)}^{s,\rho})$ such that

$$(D_{\hat{u}_{\mathbf{r},(0)}^{d,\rho}, \hat{u}_{1,\mathbf{r},(0)}^{s,\rho}, \hat{u}_{2,\mathbf{r},(0)}^{s,\rho}}^{\rho} \bar{\partial})(\mathbf{V}_{\rho,(1)}) = (\text{Err}_{\mathbf{r},(1)}^{\rho,d}, \text{Err}_{1,\mathbf{r},(1)}^{\rho,s}, \text{Err}_{2,\mathbf{r},(1)}^{\rho,s}).$$

◇

This is a consequence of Lemma 12.65 and can be proved in the same way as [FOOO12, Lemma 5.13].

Step 1-2 (Gluing solutions):

Definition 12.72. We define $u_{\mathbf{r},(1)}^\rho = (u_{1,\mathbf{r},(1)}^\rho, u_{2,\mathbf{r},(1)}^\rho)$ as follows.

(1) If $z \in K^d$, we put

$$u_{\mathbf{r},(1)}^\rho(z) = \text{Exp}^z(\hat{u}_{\mathbf{r},(0)}^{d,\rho}, V_{\rho,(1)}^d(z)). \quad (12.107)$$

(2) If $z \in K_i^s$, we put

$$u_{i,\mathbf{r},(1)}^\rho(z) = \text{Exp}^z(\hat{u}_{i,\mathbf{r},(0)}^{s,\rho}, V_{i,\rho,(1)}^s(z)). \quad (12.108)$$

(3) If $z = (\tau', t') \in [0, 10T_i]_{\tau'} \times S^1$, we put

$$\begin{aligned} & u_{i,\mathbf{r},(1)}^\rho(\tau', t') \\ = & \text{Exp}^z \left(u_{\mathbf{r},(0)}^\rho(\tau', t'), \chi_{\mathcal{B}_{T_i}^i}^{\leftarrow}(\tau, t)(V_{i,\rho,(1)}^d(\tau', t') - (\Delta p_{i,\rho,(1)})^{\text{Pal}}) \right. \\ & \left. + \chi_{\mathcal{A}_{T_i}^i}^{\rightarrow}(\tau', t')(V_{i,\rho,(1)}^s(\tau''_i, t''_i) - (\Delta p_{i,\rho,(1)})^{\text{Pal}}) + (\Delta p_{i,\rho,(1)})^{\text{Pal}} \right). \end{aligned} \quad (12.109)$$

We also define $p_{(1)}^\rho = (p_{(1)}^{1,\rho}, p_{(1)}^{2,\rho})$ by

$$p_{i,(1)}^\rho = \text{Exp}_i(p_i^\rho, \Delta p_{i,\rho,(1)}).$$

◇

$u_{\mathbf{r},(1)}^\rho(z)$ is an improved approximate solution. Note that by Definition 12.61 (1), $u_{\mathbf{r},(1)}^\rho(z)$ satisfies the boundary condition at $\partial\Sigma(\mathbf{r})$.

Step 1-4 (Separating error terms into two parts):

Definition 12.73. We define

$$\hat{u}_{\mathbf{r},(1)}^{d,\rho} = (\hat{u}_{1,\mathbf{r},(1)}^{d,\rho}, \hat{u}_{2,\mathbf{r},(1)}^{d,\rho}) : (\Sigma^d, \partial\Sigma^d) \rightarrow (-X_1 \times X_2, L_{12})$$

as follows.

$$\hat{u}_{i,\mathbf{r},(1)}^{d,\rho}(z) := \begin{cases} \text{Exp}_i \left(p_{i,(1)}^\rho, \chi_{\mathcal{B}_{T_i}^i}^{\leftarrow}(\tau' - T_i, t') \text{E}_i(p_i^\rho, u_{i,\mathbf{r},(0)}^\rho(\tau', t')) \right) & \text{if } z = (\tau', t') \in [0, 10T_i]_{\tau'} \times S^1 \\ u_{i,\mathbf{r},(1)}^\rho(z) & \text{if } z \in K_i^d \\ p_{i,(1)}^\rho & \text{if } z \in [10T_i, \infty)_{\tau'} \times S^1. \end{cases} \quad (12.110)$$

We also define

$$\hat{u}_{i,\mathbf{r},(1)}^{s,\rho} : \Sigma_i^s \rightarrow X_i$$

as follows.

$$\hat{u}_{i,\mathbf{r},(1)}^{s,\rho}(z) := \begin{cases} \text{Exp}_i \left(p_{i,(1)}^\rho, \chi_{\mathcal{A}_{T_i}^i}^{\rightarrow}(\tau''_i + T_i, t''_i) \text{E}_i(p_i^\rho, u_{i,\mathbf{r},(0)}^\rho(\tau'_i, t'_i)) \right) & \text{if } z = (\tau''_i, t''_i) \in [-10T_i, 0]_{\tau''_i} \times S^1 \\ u_{i,\mathbf{r},(1)}^\rho(z) & \text{if } z \in K_i^s \\ p_{i,(1)}^\rho & \text{if } z \in (-\infty, -10T_i]_{\tau''_i} \times S^1. \end{cases} \quad (12.111)$$

◇

Definition 12.74. We put

$$\begin{aligned} \mathrm{Err}_{i,\mathbf{r},(2)}^{\rho,\mathrm{d}} &= \chi_{\mathcal{X}_{T_i}^{\leftarrow}} \bar{\partial}_{j_{\mathfrak{z}_i}} u_{T,(1),i}^{\rho}, \\ \mathrm{Err}_{i,\mathbf{r},(2)}^{\rho,\mathrm{s}} &= \chi_{\mathcal{X}_{T_i}^{\rightarrow}} \bar{\partial}_j u_{T,(1),i}^{\rho}. \end{aligned}$$

We regard them as elements of the weighted Sobolev spaces $L_{m,\delta}^2(\Sigma_i^{\mathrm{d}}, (\hat{u}_{i,\mathbf{r},(1)}^{\mathrm{d},\rho})^* TX_i \otimes \Lambda_{\rho}^{0,1})$ and $L_{m,\delta}^2(\Sigma_i^{\mathrm{s}}, (\hat{u}_{i,\mathbf{r},(1)}^{\mathrm{s},\rho})^* TX_i \otimes \Lambda^{0,1})$ respectively, by extending them to be 0 outside the support of $\chi_{\mathcal{X}_{T_i}^{\leftarrow}}$ and $\chi_{\mathcal{X}_{T_i}^{\rightarrow}}$, respectively. ◇

We now come back to Step 2-1 and continue. We thus obtain a sequence of maps $u_{\mathbf{r},(\kappa)}^{\rho} = (u_{1,\mathbf{r},(\kappa)}^{\rho}, u_{2,\mathbf{r},(\kappa)}^{\rho})$ for $\kappa = 0, 1, 2, \dots$ inductively on κ .

In the same way as [FOOO12, Section 5] we can show that it converges to $u_{\mathbf{r}}^{\rho} = (u_{1,\mathbf{r}}^{\rho}, u_{2,\mathbf{r}}^{\rho})$ in L_{m+1}^2 norm as κ goes to infinity.

Together with source object (12.65), $u_{\mathbf{r}}^{\rho}$ defines an element of $\mathcal{M}'_{1,2,2}(L_{12}; (\mathrm{diag}); E)$. This element is by definition $\mathcal{G}((\rho^{\mathrm{d}}, \rho_1^{\mathrm{s}}, \rho_2^{\mathrm{s}}, \mathfrak{z}_1, \mathfrak{z}_2), (\mathbf{r}_1, \mathbf{r}_2))$. The proof that it is injective and its image is an open neighborhood of ξ_0 is the same as [FOOO12, Section 7].

Let us elaborate on the latter proof now. Below we discuss the case when the source object is unstable. (So it is slightly more involved than the case of Proposition 12.55.)

We consider the situation at the beginning of Subsection 12.4, depicted in Figure 77. We write the element of $\mathcal{M}'_{1,2,2}(L_{12}; (\mathrm{diag}); E)$ described there as \mathbf{x}^+ . Denote the four interior marked points of \mathbf{x}^+ by $w_{i,j}$ ($i = 1, 2, j = 1, 2$) where $w_{i,j}$ is on Σ_i^{s} . Note that 0 on the disk is an interior marked point of first kind. This element \mathbf{x}^+ comes with one boundary marked point 1 (the symbol (diag) shows existence of one boundary marked point). We forget the four interior marked points of second kind and one interior marked point of first kind to obtain $\mathbf{x} \in \mathcal{M}'_{0,0,0}(L_{12}; (\mathrm{diag}); E)$.

We add 4 codimension two transversals $\mathcal{N}_{i,j} \subset X_i$ which intersect with the image of $u_i^{\mathrm{s},0}$ transversally at $w_{i,j}$. We also add 1 codimension two transversal $\mathcal{N} \subset X_1 \times X_2$ which intersect with $(u_1^{\mathrm{d},0}, u_2^{\mathrm{d},0})$ transversally at 0.

We will prove that the set of the image of \mathcal{G} satisfying the transversal constraint contains a neighborhood of \mathbf{x} in $\mathcal{M}'_{0,0,0}(L_{12}; (\mathrm{diag}); E)$. Suppose that \mathbf{y}_n is a sequence of elements $\mathcal{M}'_{0,0,0}(L_{12}; (\mathrm{diag}); E)$ converging to \mathbf{x} . By the definition of topology and Lemma 12.17, there exists \mathbf{y}_n^+ such that $i^*(\mathbf{y}_n^+) = \mathbf{y}_n$ and $\lim_{n \rightarrow \infty} \mathbf{y}_n^+ = \mathbf{x}^+$. Here i^* is the forgetful map of the marked points. In particular the source curves of \mathbf{y}_n^+ converge to the source curve of \mathbf{x}^+ . Let $w_{i,j}^n$ be the four interior marked points of second kind of \mathbf{y}_n^+ and z_i^n be the interior marked points of first kind of \mathbf{y}_n^+ . Then, the source curve of \mathbf{y}_n^+ is a pair $((\Sigma_1^n, (1; z_1^n, w_{1,1}^n, ; w_{1,2}^n)), (\Sigma_2^n, (1; z_2^n, w_{2,1}^n, ; w_{2,2}^n)))$ together with an isomorphism of the disk part of Σ_1^n to the disk part of Σ_2^n , which sends 1 and z_1^n to 1 and z_2^n , respectively. (We denote the boundary marked point by 1.) Therefore $(\Sigma_i^n, (1; z_1^n, w_{i,1}^n, ; w_{i,2}^n))$ converges to $(\Sigma, (1; 0, w_{i,1}, w_{i,2}))$ in the moduli space of marked stable bordered curves. Here Σ is a disk with one sphere bubble on it. We change the representative and assume that z_1^n is 0.

So we obtain a gluing parameter \mathbf{r}_1^n and the parameter of the position of the node \mathfrak{z}_1^n uniquely such that $(\Sigma_1^n, (1; 0; w_{1,1}^n; w_{1,2}^n))$ is conformal to $(\Sigma_1(\mathfrak{z}_1^n, \mathbf{r}_1^n), (1, 0, w_{1,1}, w_{1,2}))$. We obtain \mathbf{r}_2^n and \mathfrak{z}_2^n in a similar way. We remark that $\lim_{n \rightarrow \infty} \mathbf{r}_i^n = \mathbf{0}$.

We can identify $\Sigma_i^n \cong \Sigma_i(\mathfrak{z}_i^n, \mathbf{r}_i^n)$ and $\Sigma_i(\mathfrak{z}_i^n, \mathbf{0})$ outside the neck region⁵⁰ using the local trivialization of the universal family (outside the node). Via this identification the map u_i^n which is a part of \mathbf{y}_n^+ converges to u_i which is a part of \mathbf{x}^+ outside the neck region in the compact C^∞ topology as n goes to infinity. On the neck region we can use the exponential decay estimate such as [FOOO12, Proposition 7.1]. Therefore we can take $\rho^n = (\rho^{n,d}, \rho_1^{n,s}, \rho_2^{n,s})$ such that the difference of two elements \mathbf{y}_n^+ and $\mathcal{G}(\rho^n, \mathfrak{z}_1^n, \mathfrak{z}_2^n, \mathbf{r}_1^n, \mathbf{r}_2^n)$ goes to zero.

Hence we can interpolate u_i^n which is a part of \mathbf{y}_n^+ and $u_i^{n,s}$ which is a map part of $\mathcal{G}(\rho^n, \mathfrak{z}_1^n, \mathfrak{z}_2^n, \mathbf{r}_1^n, \mathbf{r}_2^n)$ to obtain a one parameter family of maps $u_i^{n,s} : \Sigma_i^n \rightarrow X_i$ for $\mathfrak{s} \in [0, 1]$ such that it becomes u_i^n and $u_i^{n,s}$ at $\mathfrak{s} = 0, 1$. (Note that the domain curves of them are isomorphic each other.) We may also assume that the transversality constraints are satisfied.

For a sufficiently large n this path $\mathfrak{s} \mapsto u_i^{n,s}$ can be arbitrary short. (The shortness is taken in the sense of the weighted Sobolev norm we used in the gluing analysis.)

Now we run the Newton's iteration in the one parameter family and modify $u_i^{n,s}$ so that it is pseudo-holomorphic. Since u_i^n and $u_i^{n,s}$ are both pseudo-holomorphic, Newton's iteration does not change them. Hence the path $\mathfrak{s} \mapsto u_i^{n,s}$ still joins them. We may still assume that the transversality constraint are satisfied by using implicit function theorem.

By index calculation the image of the map \mathcal{G} has the same dimension as the moduli space for each fixed domain. Therefore we can lift our path to the domain of \mathcal{G} for sufficiently large n . This is the proof of openness of the image.

We thus proved Proposition 12.55.

Then the proof of Proposition 12.56 is entirely the same as [FOOO12, Section 6].

The proof of Theorem 12.24 is now complete. \square

Example 12.75. We consider the sequence $\rho(n) = ((\rho_n^d, \rho_n^s), (\mathfrak{z}_1(n), \mathfrak{z}_2(n)))$ and $\mathbf{r}(n) = ((\mathbf{r}_1(n), \mathbf{r}_2(n)), (\mathfrak{z}_1(n), \mathfrak{z}_2(n)))$ which converges to $(\mathbf{0}, \mathfrak{z}_0, \mathfrak{z}_0)$ and to $(\mathbf{0}, \mathbf{0})$ as n goes to infinity. The limit of $\mathcal{G}(\rho(n), \mathbf{r}(n))$ in our compactification $\mathcal{M}'_{1,2,2}(L_{12}; (\text{diag}); E)$ is $\xi_0 = \mathcal{G}((\mathbf{0}, (\mathbf{0}, \mathbf{0})), \mathbf{r}(n))$ and is independent of the choice of such sequences $\rho(n)$, $\mathbf{r}(n)$.

On the other hand, the limit of $\mathcal{G}(\rho(n), \mathbf{r}(n))$ in the stable map compactification $\mathcal{M}_{1,2,2}(L_{12}; (\text{diag}); E)$ depend on the choice of $\rho(n)$, $\mathbf{r}(n)$ as follows.

We put $d(n) = |\mathfrak{z}_1(n) - \mathfrak{z}_2(n)|$.

(Case 1): If $d(n)/|\mathbf{r}_1(n)| \rightarrow 0$, $d(n)/|\mathbf{r}_2(n)| \rightarrow 0$. Then the source curve of the limit $\mathcal{G}(\rho(n), \mathbf{r}(n))$ in the stable map compactification is as in Figure 69.

(Case 2): $d(n)/|\mathbf{r}_1(n)| > c > 0$, $|\mathbf{r}_2(n)|/|\mathbf{r}_1(n)| \rightarrow 0$. Then the source curve of the limit $\mathcal{G}(\rho(n), \mathbf{r}(n))$ in the stable map compactification is as in Figure 68.

(Case 3): $d(n)/|\mathbf{r}_2(n)| > c > 0$, $|\mathbf{r}_1(n)|/|\mathbf{r}_2(n)| \rightarrow 0$. Then the source curve of the limit $\mathcal{G}(\rho(n), \mathbf{r}(n))$ in the stable map compactification is as in Figure 67.

(Case 4): $d(n)/|\mathbf{r}_2(n)| > c > 0$, $c_2 > |\mathbf{r}_1(n)|/|\mathbf{r}_2(n)| > c_1$. Then the source curve of the limit $\mathcal{G}(\rho(n), \mathbf{r}(n))$ in the stable map compactification is as in Figure 70.

⁵⁰There exists a one neck for each $i \in \{1, 2\}$.

We can prove these facts by looking the proof of Lemma 12.33.

Thus the stable map compactification $\mathcal{M}_{1,2,2}(L_{12}; (\text{diag}); E)$ is a kind of blow up of $\mathcal{M}'_{1,2,2}(L_{12}; (\text{diag}); E)$. Note that the fact that the blow up of a variety Z is smooth does not imply the smoothness of Z in algebraic geometry. By the same reason the fact that $\mathcal{M}_{1,2,2}(L_{12}; (\text{diag}); E)$ has Kuranishi structure, which was proved in previous literatures, does not imply $\mathcal{M}'_{1,2,2}(L_{12}; (\text{diag}); E)$ has Kuranishi structure. This is the reason why we provide the detail of the proof of Theorem 12.24 in this subsection. \diamond

Remark 12.76. We discuss the example in Remark 12.57 and how the gluing analysis works in that case. Moreover we will compare it to the gluing analysis in the case of stable map compactification.

In the situation of Remark 12.57 we consider the case when the configuration ξ'_0 which is defined by $(u_1^d, u_2^d, u_1^s, u_2^s)$ is isolated among the objects in this combinatorial type,⁵¹ up to an automorphism on the sphere bubbles which preserves the point $D_i^2 \cap S_i^2$ that is $0_i \in S_i^2$. Here

$$u_1^d : D^2 \rightarrow -X_1, \quad u_2^d : D^2 \rightarrow X_2, \quad u_1^s : S^2 \rightarrow -X_1, \quad u_2^s : S^2 \rightarrow X_2.$$

with the constraint

$$u_i^d(\mathbf{o}) = u_i^s(0), \quad i = 1, 2$$

and

$$(u_1^d(z), u_2^d(z)) \in L_{12}$$

for $z \in \partial D^2$. Since we assume this configuration is isolated u_i^d is uniquely determined by these conditions.⁵² The automorphisms on the sphere bubbles which preserves 0 consist a complex two dimensional group G_i . So u_i^s has a freedom $u_i^s \mapsto u_i^s \circ g_i$, $g_i \in G_i$. The space \mathcal{V} has complex dimension 6, parametrized g_1, g_2 and $\mathfrak{z}_1, \mathfrak{z}_2$. Here $\mathfrak{z}_i \in D_i^2$ which parametrizes the ‘root’ of the sphere bubble. Note that we assumed that ξ'_0 is isolated among the object in this combinatorial type. Therefore such element is unique if $\mathfrak{z}_1 = \mathfrak{z}_2$. So there is one constraint and the dimension is $\dim_{\mathbb{C}} G_1 + \dim_{\mathbb{C}} G_2 + 2 - 1 = 5$.

Together with two gluing parameters ρ_1, ρ_2 the domain of the map \mathcal{G} has 7 complex dimension.

The Kuranishi neighborhood of ξ'_0 in $\mathcal{M}'_{1,0,0}(L_{12}; (\text{diag}); E)$ is a submanifold of this real 14 dimensional manifold cutting out by the constraint (12.72). The constraint is by codimension 2 submanifolds at 4 added marked points. Therefore it decreases dimension by 8.

Thus Kuranishi neighborhood of ξ'_0 in $\mathcal{M}'_{1,0,0}(L_{12}; (\text{diag}); E)$ is a real 6 dimensional manifold. It can be depicted schematically in the Figure 81 (a).

We next compare it with the Kuranishi neighborhood of the corresponding object in the stable map compactification. The element $\eta'_0 \in \mathcal{M}_{1,0}(L_{12}; (\text{diag}); E)$ corresponding to ξ'_0 in the stable map compactification,⁵³ has a source curve consisting of D^2 and one sphere bubble. The map on the disk is (\bar{u}_1^d, u_2^d) and the map on the sphere is (\bar{u}_1^s, u_2^s) . Note that the element η'_0 is *not* isolated in this combinatorial

⁵¹Here ‘this combinatorial type’ contains the condition $\mathfrak{z}_1 = \mathfrak{z}_2$, that is, the roots $\mathfrak{z}_1, \mathfrak{z}_2 \in D^2$ of the two sphere bubbles coincide.

⁵²This follows from the fact that the group of automorphisms of the source curve acts as an identity map on the disk component. This is because the disk component has one boundary marked point and one interior node.

⁵³Note that there is no prime in $\mathcal{M}_{1,0,0}(L_{12}; (\text{diag}); E)$

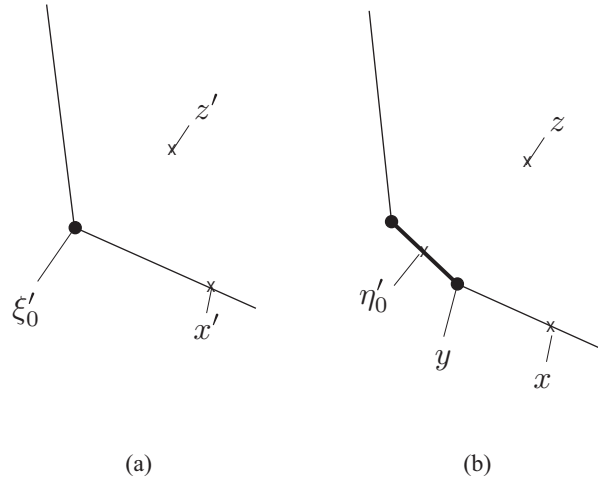

FIGURE 81. Schematical pictures of Kuranishi neighborhoods.

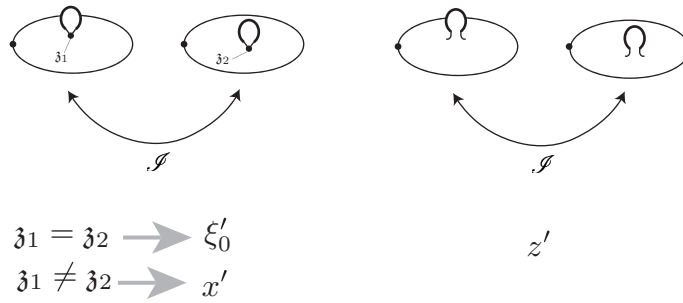

FIGURE 82. Source curves of objects in Figure 81 (a).

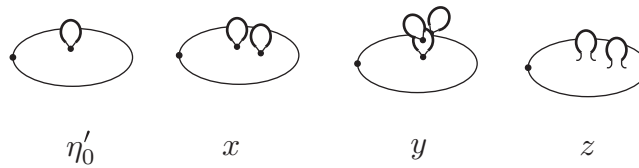

FIGURE 83. Source curves of objects in Figure 81 (b).

type. Namely if we change (\bar{u}_1^s, u_2^s) to $(\bar{u}_1^s, u_2^s \circ g_2)$ with $g_2 \in G_2$ it represents a different element in $\mathcal{M}_{1,0}(L_{12}; (\text{diag}); E)$. Thus this stratum is a real 4 dimensional manifold. (This family is depicted in Figure 81 (b) by a thick line containing η'_0 .) Together with real 2 dimensional gluing parameter it gives 6 dimensional family of objects. The dimension coincides to the dimension of the Kuranishi neighborhood of ξ'_0 in $\mathcal{M}'_{1,0,0}(L_{12}; (\text{diag}); E)$. Those two moduli spaces are identical before compactification and so the dimension must coincide.⁵⁴ The Kuranishi neighborhood

⁵⁴When we work out the gluing process starting from η'_0 , we proceed as follows. We take two marked points, say $1, \infty$, on the sphere bubble and take $\mathcal{N}_1, \mathcal{N}_\infty$ codimension 2 submanifold of

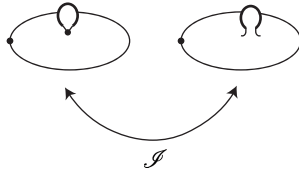

FIGURE 84. Source curves of objects mentioned in the footnote.

of η'_0 in $\mathcal{M}_{1,0,0}(L_{12}; E)$ can be depicted schematically as in Figure 81 (b).⁵⁵ The points x and z in Figure 81 (b) are objects whose domain are depicted in Figure 83.

One can observe that Figure 81 (b) is a kind of blow up of Figure 81 (a) at the stratum containing ξ'_0 .

Remark 12.77. Note that we did not care about the compatibility of the Kuranishi structure with the forgetful map of the boundary marked points in this section. We actually use such a compatibility to prove that the operations we obtain from our moduli spaces is unital. We can prove the compatibility with the forgetful map in the same way as, for example, [Fu9, Sections 3 and 5]. Note that we only need to consider the forgetful map at the diagonal component to study unitality. Let \vec{a} be as in Theorem 12.24. We remove all the diagonal components from it except possibly a_0 . We denote it by \vec{a}' . We use Theorem 12.24 to obtain a Kuranishi structure on $\mathcal{M}'(L_{12}; \vec{a}'; E)$. Now for each element of $\mathcal{M}'(L_{12}; \vec{a}'; E)$ we use the obstruction space used in the construction of $\mathcal{M}'(L_{12}; \vec{a}'; E)$. We then perform the gluing analysis in the same way to obtain a Kuranishi structure on $\mathcal{M}'(L_{12}; \vec{a}; E)$. This Kuranishi structure is obviously compatible with the forgetful map.

We omit the detail since there is nothing new in this construction compared to those which have already appeared in the literature. \diamond

13. HOMOTOPY EQUIVALENCE AND HOMOTOPY BETWEEN FILTERED A_∞ FUNCTORS

In Subsection 2.1 Definition 2.25 we defined the notion of two filtered A_∞ functors being homotopy equivalent and built homotopy theory of filtered A_∞ categories based on this notion. This is the way taken in [Fu7]. The way taken in [FOOO1] (in the case of filtered A_∞ algebras) is slightly different. We describe the method of [FOOO1] in the filtered A_∞ category case and discuss its relation to the method of Section 2.1.

There are certain issues to state it correctly because the category of categories is rather a 2-category than a 1-category and so claiming two morphisms of the category of categories to be ‘the same’ is a nontrivial issue. A certain part of the discussion of this section is related to this point.

We say a filtered A_∞ functor $\mathcal{F} : \mathcal{C}_1 \rightarrow \mathcal{C}_2$ is *linear* if $\mathcal{F}_k : B_k \mathcal{C}_1[1] \rightarrow \mathcal{C}_2[1]$ is 0 for $k \neq 1$.

$X_1 \times X_2$ which intersects with $u^s := (\bar{u}_1^s, u_2^s)$ transversally at $u^s(1)$ and $u^s(\infty)$. We thus obtain η_0 . Note that the neighborhood of η_0 has 4 extra (real) parameter corresponding to the group G of automorphisms of S^2 preserving 0. After gluing we cutout by using the constraint defined by $\mathcal{N}_1, \mathcal{N}_\infty$. Which decrease the dimension by 4.

⁵⁵This is an oversimplified picture. In fact there are other kinds of strata such as those depicted in Figure 84.

Definition 13.1. (Compare [FOOO1, Definition 4.2.1]) Let \mathcal{C} be a non-unital curved filtered A_∞ category. A *model of $\mathcal{C} \times [0, 1]$* consists of $(\mathfrak{C}, \text{Incl}, \text{Eval}_0, \text{Eval}_1)$ with the following properties.

- (1) \mathfrak{C} is a curved non-unital filtered A_∞ category.
- (2) $\text{Incl} : \mathcal{C} \rightarrow \mathfrak{C}$, $\text{Eval}_0 : \mathfrak{C} \rightarrow \mathcal{C}$, $\text{Eval}_1 : \mathfrak{C} \rightarrow \mathcal{C}$ are linear filtered A_∞ functors, such that $\text{Incl}_{ob} : \mathfrak{D}\mathfrak{B}(\mathcal{C}) \rightarrow \mathfrak{D}\mathfrak{B}(\mathfrak{C})$, $(\text{Eval}_0)_{ob} : \mathfrak{D}\mathfrak{B}(\mathfrak{C}) \rightarrow \mathfrak{D}\mathfrak{B}(\mathcal{C})$, $(\text{Eval}_1)_{ob} : \mathfrak{D}\mathfrak{B}(\mathfrak{C}) \rightarrow \mathfrak{D}\mathfrak{B}(\mathcal{C})$ are bijections.
- (3) $\text{Eval}_0 \circ \text{Incl} = \text{Eval}_1 \circ \text{Incl}$ = the identity functor $: \mathcal{C} \rightarrow \mathcal{C}$.
- (4) For $c, c' \in \mathcal{C}_{ob}$, the map $\overline{\text{Incl}}_1(c, c') : \mathfrak{C}(c, c') \rightarrow \mathfrak{C}(\text{Incl}_{ob}(c), \text{Incl}_{ob}(c'))$ is a chain homotopy equivalence of the chain complexes, where $\overline{\mathfrak{m}}_1$ is the boundary operators. (Here $\overline{\text{Incl}}$ etc. denotes the R -reduction.) For $c, c' \in \mathfrak{C}_{ob}$ and $j = 0, 1$, the map $(\overline{\text{Eval}}_j)_1(c, c') : \mathfrak{C}(c, c') \rightarrow \mathfrak{C}((\text{Eval}_j)_{ob}(c), (\text{Eval}_j)_{ob}(c'))$ is a chain homotopy equivalence of the chain complexes, where $\overline{\mathfrak{m}}_1$ is the boundary operators.
- (5) For $c, c' \in \mathfrak{C}_{ob}$ the Λ_0 module homomorphism

$$(\text{Eval}_0)_1(c, c') \oplus (\text{Eval}_1)_1(c, c')$$

$$: \mathfrak{C}(c, c') \rightarrow \mathfrak{C}((\text{Eval}_1)_{ob}(c), (\text{Eval}_1)_{ob}(c')) \oplus \mathfrak{C}((\text{Eval}_2)_{ob}(c), (\text{Eval}_2)_{ob}(c'))$$

is split surjective.

In the case when \mathcal{C} is strict (resp. unital, G -gapped) the model of $\mathcal{C} \times [0, 1]$ are said strict (resp. unital, G -gapped) if \mathfrak{C} , Incl , Eval_0 , Eval_1 are all strict (resp. unital, G -gapped).

Sometimes we say \mathfrak{C} is a model of $\mathcal{C} \times [0, 1]$ (and do not specify Eval_j and Incl) by an abuse of notation. \diamond

By (2)(3) we can identify $\mathfrak{D}\mathfrak{B}(\mathcal{C})$ and $\mathfrak{D}\mathfrak{B}(\mathfrak{C})$. So we identify these two sets from now on.

Proposition 13.2. *For any curved non-unital filtered A_∞ category \mathcal{C} a model of $\mathcal{C} \times [0, 1]$ exists. If \mathcal{C} is strict (resp. unital, G -gapped) then we take the model so that it is strict (resp. unital, G -gapped). \diamond*

The proof is the same as the proof of [FOOO1, Lemma 4.2.13] (if R contains \mathbb{Q}) [FOOO1, Lemma 4.2.25] (in general). Those are the cases of a filtered A_∞ algebra but the proof of the category case is the same.

Proposition 13.3. *Let \mathcal{C}_j ($j = 1, 2$) be non-unital curved filtered A_∞ categories and $\mathcal{F} : \mathcal{C}_1 \rightarrow \mathcal{C}_2$ a filtered A_∞ functor. Let \mathfrak{C}_j be a model of $\mathcal{C}_j \times [0, 1]$ for $j = 1, 2$.*

Then there exists a filtered A_∞ functor $\mathfrak{F} : \mathfrak{C}_1 \rightarrow \mathfrak{C}_2$ such that $\text{Eval}_j \circ \mathfrak{F} = \mathcal{F} \circ \text{Eval}_j$ for $j = 0, 1$.

If \mathcal{C}_j and \mathcal{F} are strict (resp. unital, G -gapped) we may choose \mathfrak{F} to be strict (resp. unital, G -gapped). \diamond

The proof is the same as the proof of [FOOO1, Theorem 4.2.34] and so is omitted.

Note that in Proposition 13.3 the case $\mathcal{C}_1 = \mathcal{C}_2 = \mathcal{C}$ and \mathcal{F} is the identity functor is included. In that case Proposition 13.3 implies the following.

Corollary 13.4. *Let \mathfrak{C}_j be a model of $\mathcal{C} \times [0, 1]$ for $j = 1, 2$.*

Then there exists a filtered A_∞ functor $\mathfrak{F} : \mathfrak{C}_1 \rightarrow \mathfrak{C}_2$ such that $\text{Eval}_j \circ \mathfrak{F} = \text{Eval}_j$ for $j = 0, 1$.

If \mathcal{C} is strict (resp. unital, G -gapped) we may choose \mathfrak{F} to be strict (resp. unital, G -gapped). \diamond

Definition 13.5. Let \mathcal{C}_j be a non-unital curved filtered A_∞ category for $j = 1, 2$ and $\mathcal{F}, \mathcal{G} : \mathcal{C}_1 \rightarrow \mathcal{C}_2$ filtered A_∞ functors. Let \mathfrak{C}_2 be a model of $\mathcal{C}_2 \times [0, 1]$.

We say \mathcal{F} is *homotopic* to \mathcal{G} and write $\mathcal{F} \approx \mathcal{G}$ if there exists a filtered A_∞ functor $\mathcal{H} : \mathcal{C}_1 \rightarrow \mathfrak{C}_2$ such that

$$\text{Eval}_0 \circ \mathcal{H} = \mathcal{F}, \quad \text{Eval}_1 \circ \mathcal{H} = \mathcal{G}.$$

We call \mathcal{H} the *homotopy functor*.

We can define a strict (resp. unital, G -gapped) version in an obvious way. \diamond

Remark 13.6. If \mathcal{F} is homotopic to \mathcal{G} then $\mathcal{F}_{ob} = \mathcal{G}_{ob}$. This is a consequence of Definition 13.1 (2)(3). \diamond

Lemma 13.7. (1) *The notion ‘homotopic’ is independent of the choice of the model of $\mathcal{C}_2 \times [0, 1]$.*

(2) *‘homotopic’ is an equivalence relation.*

(3) *If $\mathcal{F} \approx \mathcal{F}'$ then $\mathcal{F} \circ \mathcal{G} \approx \mathcal{F}' \circ \mathcal{G}$, $\mathcal{G} \circ \mathcal{F} \approx \mathcal{G} \circ \mathcal{F}'$.*

The strict (resp. unital, G -gapped) version of these statements also hold. \diamond

Proof. (1) follows from Corollary 13.4. (See [FOOO1, Lemma 4.2.36].) (2) can be proved in the same way as [FOOO1, Proposition 4.2.37]. The proof of (3) is the same as [FOOO1, Lemma 4.2.43]. \square

Definition 13.8. Let $\mathcal{F} : \mathcal{C}_1 \rightarrow \mathcal{C}_2$ be a filtered A_∞ functor between non-unital curved filtered A_∞ categories. We say that \mathcal{F} is a *strong homotopy equivalence* if there exists a filtered A_∞ functor $\mathcal{G} : \mathcal{C}_2 \rightarrow \mathcal{C}_1$ such that $\mathcal{F} \circ \mathcal{G} : \mathcal{C}_2 \rightarrow \mathcal{C}_2$ and $\mathcal{G} \circ \mathcal{F} : \mathcal{C}_1 \rightarrow \mathcal{C}_1$ are homotopic to the identity functor.

We call \mathcal{G} the *strong homotopy inverse* to \mathcal{F} .

We say two non-unital curved filtered A_∞ categories are *strongly homotopy equivalent* to each other if there exists a strong homotopy equivalence between them.

We can define a strict (resp. unital, G -gapped) version in an obvious way. \diamond

Remark 13.9. If $\mathcal{F} : \mathcal{C}_1 \rightarrow \mathcal{C}_2$ is a strong homotopy equivalence then it induces a bijection $\mathfrak{OB}(\mathcal{C}_1) \rightarrow \mathfrak{OB}(\mathcal{C}_2)$. This is a consequence of Definition 13.6.

This is a rather restrictive requirement. To define an appropriate notion of equivalence between (A_∞) categories, it is *not* a correct idea to require that the set of objects are equal. This point is related to the basic concept of category where an equality should be replaced by an equivalence.

This is a point where the notion of a homotopy equivalence which we introduced in Definition 2.27 is more natural from the point of view of category theory than the notion of a strong homotopy equivalence we defined above.

We will further discuss the relation between these two notions later in this section. \diamond

Lemma 13.10. *Let $\mathcal{F} : \mathcal{C}_1 \rightarrow \mathcal{C}_2$ be a strong homotopy equivalence.*

(1) *Let $\mathcal{G}, \mathcal{G}' : \mathcal{C} \rightarrow \mathcal{C}_1$ be filtered A_∞ functors. Then \mathcal{G} is homotopic to \mathcal{G}' if and only if $\mathcal{F} \circ \mathcal{G}$ is homotopic to $\mathcal{F} \circ \mathcal{G}'$.*

(2) *Let $\mathcal{G}, \mathcal{G}' : \mathcal{C}_2 \rightarrow \mathcal{C}$ be filtered A_∞ functors. Then \mathcal{G} is homotopic to \mathcal{G}' if and only if $\mathcal{G} \circ \mathcal{F}$ is homotopic to $\mathcal{G}' \circ \mathcal{F}$.*

(3) *Composition of strong homotopy equivalences is a strong homotopy equivalence.*

The strict (resp. unital, G -gapped) version of these statements also hold. \diamond

The proof is easy and is omitted.

Now a strong homotopy equivalence version of Theorem 2.28 is the following. We assume that the ground ring R is a field.

Theorem 13.11. *Let $\mathcal{C}_1, \mathcal{C}_2$ be G -gapped filtered A_∞ categories and $\mathcal{F} : \mathcal{C}_1 \rightarrow \mathcal{C}_2$ a G -gapped filtered A_∞ functor such that:*

- (1) *For any $c, c' \in \mathfrak{OB}(\mathcal{C}_1)$, the map $\overline{\mathcal{F}}_1 : \overline{\mathcal{C}}_1(c_1, c'_1) \rightarrow \overline{\mathcal{C}}_2(\mathcal{F}_{ob}(c_1), \mathcal{F}_{ob}(c'_1))$ induces an isomorphism on $\overline{\mathfrak{m}}_1$ homology :*
- (2) *The map $\mathcal{F}_{ob} : \mathfrak{OB}(\mathcal{C}_1) \rightarrow \mathfrak{OB}(\mathcal{C}_2)$ is a bijection.*

Then \mathcal{F} is a strong homotopy equivalence. The strong homotopy inverse can be taken to be G -gapped.

If $\mathcal{C}_1, \mathcal{C}_2, \mathcal{F}$ are strict (resp. unital) then we may take the strong homotopy inverse to be strict (resp. unital). \diamond

The proof is the same as the proof of [FOOO1, Theorem 4.2.45].

We next discuss a relation between strong homotopy equivalence and homotopy equivalence.

Lemma 13.12. *Suppose \mathfrak{C} is a model of $\mathcal{C} \times [0, 1]$ and assume that \mathfrak{C} is G -gapped. Then Incl is a strong homotopy inverse of Eval_0 . It is a strong homotopy inverse of Eval_1 also. \diamond*

Proof. By Theorem 13.11, Incl is strong homotopy equivalence. The lemma then follows from $\text{Eval}_j \circ \text{Incl} = \text{identity}$ and Lemma 13.10. \square

Proposition 13.13. *In the situation of Definition 13.5 we assume that $\mathcal{C}_1, \mathcal{C}_2, \mathcal{F}$ and \mathcal{G} are strict and G -gapped. We also assume that \mathcal{C}_2 is unital. Then the following holds.*

If \mathcal{F} is homotopic to \mathcal{G} in the sense of Definition 13.5, then \mathcal{F} is homotopy equivalent to \mathcal{G} in the sense of Definition 2.25. \diamond

Proof. We first prove the following analogue of Lemma 13.12.

Lemma 13.14. *Suppose \mathfrak{C} is a model of $\mathcal{C} \times [0, 1]$ and assume that \mathfrak{C} is strict unital and G -gapped. Then Incl is a homotopy inverse of Eval_0 . It is a homotopy inverse of Eval_1 also.*

Proof. Using Theorem 2.28 in place of Theorem 13.11 the proof is the same as the proof of Lemma 13.12. \square

We also remark that Lemma 13.10 still holds when we replace strong homotopy equivalence by homotopy equivalence.

Now we prove Proposition 13.13. We assume that \mathcal{F} is homotopic to \mathcal{G} in the sense of Definition 13.5 and let $\mathcal{H} : \mathcal{C}_1 \rightarrow \mathcal{C}_2$ be the homotopy. Since $\text{Eval}_0 \circ \mathcal{H} = \mathcal{F}$ Lemma 13.14 implies that $\text{Incl} \circ \mathcal{F}$ is homotopy equivalent to \mathcal{H} . In the same way we can show that $\text{Incl} \circ \mathcal{G}$ to \mathcal{H} . Therefore $\text{Incl} \circ \mathcal{F}$ is homotopy equivalent to $\text{Incl} \circ \mathcal{G}$. Since Incl is a homotopy equivalence, the analogue of Lemma 13.10 we mentioned above implies \mathcal{F} is homotopy equivalent to \mathcal{G} . \square

We remark that the converse to Lemma 13.14 is false. Namely there is a pair of strict, unital and G -gapped filtered A_∞ functors \mathcal{F}, \mathcal{G} such that they are homotopy equivalent, $\mathcal{F}_{ob} = \mathcal{G}_{ob}$, but \mathcal{F} is not homotopic to \mathcal{G} . A counter example is the following.

Example 13.15. Let C be an associative ring with unit. We regard it as a differential graded algebra with trivial boundary operator and grading. We then regard it as a (filtered) A_∞ category \mathcal{C} (with trivial filtration) as in Definition 2.8, Remark 2.9. Let $f_1, f_2 : C \rightarrow C$ be ring homomorphisms. We regard them as a (filtered) A_∞ functor $\mathcal{C} \rightarrow \mathcal{C}$. We remark that f_1 is homotopic to f_2 in the sense of Definition 13.8 if and only if $f_1 = f_2$. On the other hand f_1 is homotopy equivalent to f_2 in the sense of Definition 2.25 if and only if there exists an invertible element $g \in C$ (that is, an element such that there exists $g^{-1} \in C$ with $g \cdot g^{-1} = g^{-1} \cdot g = 1$) such that $f_1(x) = g^{-1}f_2(x)g$. Thus they are different notion in this case. \diamond

Corollary 13.16. *Let \mathcal{C}_i be a G -gapped filtered A_∞ category for $i = 1, 2$. We assume that they are strict and \mathcal{C}_2 is unital. Let $\mathcal{F} : \mathcal{C}_1 \rightarrow \mathcal{C}_2$ be a filtered A_∞ functor, which is strict and G -gapped. Assume $\mathcal{F}_{ob} : \mathfrak{OB}(\mathcal{C}_1) \rightarrow \mathfrak{OB}(\mathcal{C}_2)$ is a bijection. Then the next two conditions are equivalent.*

- (1) \mathcal{F} is a strong homotopy equivalence in the sense of Definition 13.8.
- (2) \mathcal{F} is a homotopy equivalence in the sense of Definition 2.27. \diamond

Proof. This is immediate from Theorems 2.28 and 13.11. \square

Remark 13.17. Let $\mathcal{F}, \mathcal{G} : \mathcal{C}_1 \rightarrow \mathcal{C}_2$ be two strict filtered A_∞ functors between strict filtered A_∞ categories. We assume \mathcal{F} is homotopy equivalent to \mathcal{G} . It means that there exists natural transformations $\mathcal{T} : \mathcal{F} \rightarrow \mathcal{G}$, $\mathcal{S} : \mathcal{G} \rightarrow \mathcal{F}$ of degree 0 and pre-natural transformations $\mathcal{U} : \mathcal{F} \rightarrow \mathcal{F}$, $\mathcal{V} : \mathcal{G} \rightarrow \mathcal{G}$ such that

$$\mathfrak{m}_2(\mathcal{S}, \mathcal{T}) = \mathcal{I}\mathcal{D} + \delta\mathcal{U}, \quad \mathfrak{m}_2(\mathcal{T}, \mathcal{S}) = \mathcal{I}\mathcal{D} + \delta\mathcal{V}. \tag{13.1}$$

Let us elaborate on these equalities. For $c_1, c_2 \in \mathfrak{OB}(\mathcal{C}_1)$, the functors \mathcal{F} and \mathcal{G} induce homomorphisms

$$\begin{aligned} (\mathcal{F}_1)_* &: H(\mathcal{C}_1(c_1, c_2)) \rightarrow H(\mathcal{C}_2(\mathcal{F}_{ob}(c_1), \mathcal{F}_{ob}(c_2))) \\ (\mathcal{G}_1)_* &: H(\mathcal{C}_1(c_1, c_2)) \rightarrow H(\mathcal{C}_2(\mathcal{G}_{ob}(c_1), \mathcal{G}_{ob}(c_2))). \end{aligned} \tag{13.2}$$

Here H in the right and left hand sides are \mathfrak{m}_1 -homologies. We show that the two maps in (13.2) coincide as follows.

We observe that \mathcal{T} and \mathcal{S} induce

$$\mathcal{T}(c_i) \in H(\mathcal{C}_2(\mathcal{F}_{ob}(c_i), \mathcal{G}_{ob}(c_i))), \quad \mathcal{S}(c_i) \in H(\mathcal{C}_2(\mathcal{G}_{ob}(c_i), \mathcal{F}_{ob}(c_i))).$$

We define

$$\begin{aligned} \varphi &: H(\mathcal{C}_2(\mathcal{F}_{ob}(c_1), \mathcal{F}_{ob}(c_2))) \rightarrow H(\mathcal{C}_2(\mathcal{G}_{ob}(c_1), \mathcal{G}_{ob}(c_2))) \\ \psi &: H(\mathcal{C}_2(\mathcal{G}_{ob}(c_1), \mathcal{G}_{ob}(c_2))) \rightarrow H(\mathcal{C}_2(\mathcal{F}_{ob}(c_1), \mathcal{F}_{ob}(c_2))) \end{aligned}$$

by

$$\begin{aligned} \varphi([x]) &= [\mathfrak{m}_2(\mathfrak{m}_2(\mathcal{S}(c_1), x), \mathcal{T}(c_2))] \\ \psi([y]) &= [\mathfrak{m}_2(\mathfrak{m}_2(\mathcal{T}(c_1), y), \mathcal{S}(c_2))]. \end{aligned}$$

Using (13.1) and definitions we can show that

$$\varphi \circ \psi = \text{id}, \quad \psi \circ \varphi = \text{id}, \quad \varphi \circ (\mathcal{F}_1)_* = (\mathcal{G}_1)_*.$$

In other words two maps $(\mathcal{F}_1)_*$ and $(\mathcal{G}_1)_*$ are identified by the isomorphism φ, ψ . \diamond

We also can show the proposition on a relation between associated strict functors and homotopies.

Proposition 13.18. *Let $\mathcal{F}, \mathcal{G} : \mathcal{C}_1 \rightarrow \mathcal{C}_2$ be two filtered G -gapped A_∞ functors between G -gapped non-unital curved filtered A_∞ categories. We assume \mathcal{C}_2 is unital. Let $\mathcal{F}^s, \mathcal{G}^s : \mathcal{C}_1^s \rightarrow \mathcal{C}_2^s$ be associated strict functors between associated strict categories.*

If \mathcal{F} is homotopic to \mathcal{G} then \mathcal{F}^s is homotopy equivalent to \mathcal{G}^s . \diamond

Proof. Let \mathfrak{C}_2 be a model of $\mathcal{C}_2 \times [0, 1]$ and $\mathcal{H} : \mathcal{C}_1 \rightarrow \mathfrak{C}_2$ a homotopy between \mathcal{F} and \mathcal{G} . It induces a strict filtered A_∞ functor $\mathcal{H}^s : \mathcal{C}_1^s \rightarrow \mathfrak{C}_2^s$. The linear filtered A_∞ functors $\text{Incl}, \text{Eval}_0, \text{Eval}_1$ induce $\text{Incl}^s : \mathcal{C}_1^s \rightarrow \mathfrak{C}_2^s, \text{Eval}_0^s, \text{Eval}_1^s : \mathfrak{C}_2^s \rightarrow \mathcal{C}_1^s$, respectively. We obtain equalities

$$\begin{aligned} \text{Eval}_0^s \circ \text{Incl}^s &= \text{Eval}_1^s \circ \text{Incl}^s = \mathcal{I} \mathcal{D} \\ \text{Eval}_0^s \circ \mathcal{H}^s &= \mathcal{F}^s & \text{Eval}_1^s \circ \mathcal{H}^s &= \mathcal{G}^s \end{aligned} \quad (13.3)$$

from the corresponding equalities between \mathcal{F}, \mathcal{G} and etc.

Moreover, by Theorem 2.28, the first line of (13.3) and Definition 13.1 (4) imply that $\text{Incl}^s, \text{Eval}_0^s$ and Eval_1^s are homotopy equivalences and Incl^s is a homotopy inverse to Eval_i^s ($i = 0, 1$). The second line of (13.3) then implies

$$\text{Incl}^s \circ \mathcal{F}^s \approx \text{Incl}^s \circ \text{Eval}_0^s \circ \mathcal{H}^s \approx \mathcal{H}^s \approx \text{Incl}^s \circ \text{Eval}_1^s \circ \mathcal{H}^s \approx \text{Incl}^s \circ \mathcal{G}^s.$$

Then using Proposition 2.18, we conclude $\mathcal{F}^s \approx \mathcal{G}^s$. \square

Remark 13.19. In the situation of Proposition 13.18, we can not expect \mathcal{F}^s is homotopic to \mathcal{G}^s . In fact the object $\mathcal{F}_{ob}^s(c, b)$ is $(\mathcal{F}_{ob}(c), \mathcal{F}_*(b))$ and the object $\mathcal{G}_{ob}^s(c, b)$ is $(\mathcal{G}_{ob}(c), \mathcal{G}_*(b))$. They are in general different objects. Note that $\mathcal{F}_{ob}(c) = \mathcal{G}_{ob}(c)$ but $\mathcal{F}_*(b) \neq \mathcal{G}_*(b)$ in general. We can show that $\mathcal{F}_*(b)$ is gauge equivalent to $\mathcal{G}_*(b)$, in the sense of [FOOO1, Definition 4.3.1]. So they are not so far away from being ‘equal’. However because of well-known problem to distinguish saying equal and equivalent this small difference should be taken seriously. \diamond

We remark that a filtered A_∞ bi-functor

$$\mathcal{F} : \mathcal{C}_1 \times \mathcal{C}_2 \rightarrow \mathcal{C}_3$$

is identified with a filtered A_∞ functor

$$\mathcal{C}_1 \rightarrow \text{FUNC}(\mathcal{C}_2, \mathcal{C}_3)$$

by Definition 5.14. We can use this fact to define the notion that two filtered A_∞ bi-functors to be homotopic each other, in an obvious way. The case of a tri-functor etc. is similar.

14. INDEPENDENCE OF THE FILTERED A_∞ FUNCTORS OF THE CHOICES

14.1. Statement. In this section we prove that the correspondence functor and correspondence bi-functor are independent of the choices involved in the construction. In this subsection we state the main result of this section.

Choice 14.1. Suppose we are in Situation 6.1. We choose a compatible almost complex structure J_{X_i} on X_i . We also choose Kuranishi structures and a system of their CF-perturbations on the moduli spaces of the pseudo-holomorphic disks which appear in the definition of $\mathfrak{Fut}(X_i; \mathbb{L}_i)$. (See Theorem 3.24 and Proposition 3.30.) \diamond

Choice 14.2. Suppose $(X_i, \omega_i), \mathbb{L}_i, \mathbb{L}_{12}$ etc. are as in Situation 6.1. We take $-J_{X_1} \times J_{X_2}$ as the compatible almost complex structure of $-X_1 \times X_2$.

- (1) We choose Kuranishi structures and their CF-perturbations of the moduli spaces used to define filtered A_∞ category $\mathfrak{F}\mathfrak{u}\mathfrak{k}(-X_1 \times X_2, \mathbb{L}_{12})$. This construction is the same as Theorem 3.24 and Proposition 3.30, except we use the compactification $\mathcal{M}'(L_{12}; \vec{a}; E)$ etc. which we discussed in Section 12 instead of $\mathcal{M}(L_{12}; \vec{a}; E)$.
- (2) Suppose we made Choice 14.1 and Choice 14.2 (1). Finally we take Kuranishi structures and their CF-perturbations of the moduli spaces of pseudo-holomorphic quilts appearing in the construction of the filtered A_∞ tri-functor in Theorem 5.25. See Theorem 5.43 and Proposition 5.48. These Kuranishi structures and their CF-perturbations should be compatible with those we took already in Choice 14.1 and item (1).

◇

Remark 14.3. In Choice 14.2, we take the compactification $\mathcal{M}'(L_{12}; \vec{a}; E)$ in Section 12 to define a filtered A_∞ category $\mathfrak{F}\mathfrak{u}\mathfrak{k}(-X_1 \times X_2, \mathbb{L}_{12})$. We can use the stable map compactification $\mathcal{M}(L_{12}; \vec{a}; E)$ also to define a filtered A_∞ category whose objects are identified with elements of \mathbb{L}_{12} . We will show in Subsection 14.4 that those two categories are homotopy equivalent. ◇

Theorem 14.4. *Suppose we take two different ways of Choice 14.1, which we denote by $\Xi_{i,1}$ and $\Xi_{i,2}$, respectively. We denote by $\mathfrak{F}\mathfrak{u}\mathfrak{k}(X_i; \mathbb{L}_i; \Xi_{i,1})$, $\mathfrak{F}\mathfrak{u}\mathfrak{k}(X_i; \mathbb{L}_i; \Xi_{i,2})$, the filtered A_∞ categories obtained by these two different choices, respectively.*

- (1) *The filtered A_∞ category $\mathfrak{F}\mathfrak{u}\mathfrak{k}(X_i; \mathbb{L}_i; \Xi_{i,1})$ is strongly homotopy equivalent to $\mathfrak{F}\mathfrak{u}\mathfrak{k}(X_i; \mathbb{L}_i; \Xi_{i,2})$.*
- (2) *There is a choice of the strong homotopy equivalence in item (1) which is canonical up to homotopy.*

When we take two different ways of Choice 14.2 (1), $\Xi_{12,1}$ and $\Xi_{12,2}$, then for two filtered A_∞ categories $\mathfrak{F}\mathfrak{u}\mathfrak{k}(-X_1, \times X_2, \mathbb{L}_{12}; \Xi_{12,1})$, $\mathfrak{F}\mathfrak{u}\mathfrak{k}(-X_1, \times X_2, \mathbb{L}_{12}; \Xi_{12,2})$ the same conclusion as above (1)(2) holds. ◇

The proof is given in Subsection 14.3.

We denote by

$$\begin{aligned} \mathcal{G}^i &: \mathfrak{F}\mathfrak{u}\mathfrak{k}(X_i; \mathbb{L}_i; \Xi_{i,1}) \rightarrow \mathfrak{F}\mathfrak{u}\mathfrak{k}(X_i; \mathbb{L}_i; \Xi_{i,2}), \\ \mathcal{G}^{12} &: \mathfrak{F}\mathfrak{u}\mathfrak{k}(-X_1, \times X_2, \mathbb{L}_{12}; \Xi_{12,1}) \rightarrow \mathfrak{F}\mathfrak{u}\mathfrak{k}(-X_1, \times X_2, \mathbb{L}_{12}; \Xi_{12,2}), \end{aligned} \tag{14.1}$$

the strong homotopy equivalences given in Theorem 14.4.

Situation 14.5. Suppose we are in the situation of Theorem 14.4. In particular we made a choice of $\Xi_{i,j}$ for $i = 1, 2, j = 1, 2$ and of $\Xi_{12,j}$ for $j = 1, 2$.

For each $j = 1, 2$ we make Choice 14.2(2) so that this choice is compatible with $\Xi_{1,j}$, $\Xi_{2,j}$, $\Xi_{12,j}$ at the boundaries. We denote this choice by $\Xi_{12,j}^{\text{quilt}}$.

Those choices determine a filtered A_∞ functor

$$\mathfrak{F}\mathfrak{u}\mathfrak{k}\mathfrak{st}(-X_1, \times X_2, \mathbb{L}_{12}; \Xi_{12,j}) \rightarrow \mathcal{F}\mathcal{U}\mathcal{N}\mathcal{C}(\mathfrak{F}\mathfrak{u}\mathfrak{k}\mathfrak{st}(X_1; \mathbb{L}_1; \Xi_{1,j}), \mathfrak{F}\mathfrak{u}\mathfrak{k}\mathfrak{st}(X_2; \mathbb{L}_2; \Xi_{2,j})),$$

by Corollary 7.4. (Here we put \mathfrak{st} to denote the associated strict category.) We denote by $\mathcal{M}\mathcal{W}\mathcal{W}^{\Xi_{12,j}^{\text{quilt}}}$ this filtered A_∞ functor. ◇

Theorem 14.6. *In Situation 14.5, the next diagram commutes up to homotopy equivalence.*

$$\begin{array}{ccc}
\mathfrak{Fukst}(X_1; \mathbb{L}_1; \Xi_{1,1}) & \xrightarrow{\mathcal{M}\mathcal{W}\mathcal{W}^{\Xi_{12,1}^{\text{quilt}}}} & \mathfrak{Fukst}(X_2; \mathbb{L}_2; \Xi_{2,1}) \\
\times \mathfrak{Fukst}(-X_1 \times X_2; \mathbb{L}_{12}; \Xi_{12,1}) & & \\
\mathcal{G}^1 \times \mathcal{G}^{12} \downarrow & & \mathcal{G}^2 \downarrow \\
\mathfrak{Fukst}(X_1; \mathbb{L}_1; \Xi_{1,2}) & \xrightarrow{\mathcal{M}\mathcal{W}\mathcal{W}^{\Xi_{12,2}^{\text{quilt}}}} & \mathfrak{Fukst}(X_2; \mathbb{L}_2; \Xi_{2,2}) \\
\times \mathfrak{Fukst}(-X_1 \times X_2; \mathbb{L}_{12}; \Xi_{12,2}) & &
\end{array} \tag{14.2}$$

◇

The proof is in Subsection 14.4.

14.2. Higher pseudo-isotopy. We will prove Theorem 14.4 (1) by constructing pseudo-isotopy between two filtered A_∞ algebras. As we will see in the next subsection, pseudo-isotopy induces a homotopy equivalence. To prove Theorem 14.4 (2) we need to show that the homotopy equivalence is independent of the choice of pseudo-isotopy up to homotopy. To prove it we use pseudo-isotopy of pseudo-isotopies.

As we explained in [FOOO2, Subsection 7.2.3] and Subsection 3.3, during the construction of various structures, to obtain structure operations directly from geometry (moduli spaces), we need to fix an arbitrary but finite E_0 and define structure operations up to energy level E_0 only. We then take homotopy inductive limit as $E_0 \rightarrow \infty$. To work out homotopy inductive limit argument, we need one extra parameter. Namely to obtain a pseudo-isotopy of pseudo-isotopies we need to define a pseudo-isotopy of pseudo-isotopies up to energy level E_0 and a pseudo-isotopy between two pseudo-isotopies of pseudo-isotopies, one up to energy level E_0 and the other up to energy level E_1 . In other words we need pseudo-isotopy of pseudo-isotopies of pseudo-isotopies. To define such objects it seems simpler to define a family of filtered A_∞ structures parametrized by a cornered manifold. Such a construction is worked out in detail in [FOOO11, Section 21], [FOOO13, Chapter 22] and [AFOOO]. In this subsection we provide its summary.

Let P be an n -dimensional manifold with corners. We consider only the case when $P \subset \mathbb{R}^n$. We consider $\tilde{L} \times_X \tilde{L}$, where $L = (\tilde{L}, i_L)$ is an immersed Lagrangian submanifold of a symplectic manifold X , which has clean self intersection.

Let Θ is a principal $O(1)$ bundle on $\tilde{L} \times_X \tilde{L}$ and we put

$$\begin{aligned}
CF(P \times L; \Theta; \Lambda_0) &= \Omega(P \times (\tilde{L} \times_X \tilde{L}); \Theta) \widehat{\otimes} \Lambda_0, \\
CF(P \times L; \Theta; \mathbb{R}) &= \Omega(P \times (\tilde{L} \times_X \tilde{L}); \Theta).
\end{aligned}$$

(Compare (3.16).)

Definition 14.7. ([FOOO13, Definition 21.27]) A multilinear map $F : B_k(CF(P \times L; \Theta; \mathbb{R})[1]) \rightarrow CF(P \times L; \Theta; \mathbb{R})[1]$ is said to be *pointwise in P direction* if the following holds.

For each $I, J_1, \dots, J_k \subseteq \{1, \dots, d\}$ and $\mathbf{t} \in P$ there exists a continuous map $F_{I; J_1, \dots, J_k}^{\mathbf{t}} : B_k(CF(L; \Theta; \mathbb{R})[1]) \rightarrow CF(L; \Theta; \mathbb{R})[1]$ such that

$$\begin{aligned}
& F(dt_{J_1} \wedge h_1, \dots, dt_{J_k} \wedge h_k) \Big|_{\{\mathbf{t}\} \times L} \\
&= \sum_I dt_I \wedge dt_{J_1} \wedge \dots \wedge dt_{J_k} \wedge F_{I; J_1, \dots, J_k}^{\mathbf{t}}(h_1^{\mathbf{t}}, \dots, h_k^{\mathbf{t}}), \tag{14.3}
\end{aligned}$$

where $|\{\mathbf{t}\} \times L$ means the restriction to $\{\mathbf{t}\} \times (\tilde{L} \times_X \tilde{L})$. Moreover $F_{I;J_1,\dots,J_k}^{\mathbf{t}}$ depends smoothly on \mathbf{t} with respect to the operator topology. Here $h_i^{\mathbf{t}}$ is the restriction of h_i to $\{\mathbf{t}\} \times (\tilde{L} \times_X \tilde{L})$ and $t_I = t_{i_1,\dots,i_{|I|}}$ if $I = \{i_1, \dots, i_{|I|}\}$ with $i_1 < \dots < i_{|I|}$. \diamond

Here the continuity of $F_{I;J_1,\dots,J_k}^{\mathbf{t}}$ mentioned above is one in C^∞ topology.

Definition 14.8. A P -parametrized family of G -gapped filtered A_∞ structures on $CF(P \times L; \Theta; \Lambda_0)$ is $\{\mathbf{m}_{k,\beta}^P\}$ for $\beta \in G$ and $k = 0, 1, 2, \dots$, that satisfies the following:

- (1) $\mathbf{m}_{k,\beta}^P : B_k(\Omega(P \times L)[1]) \rightarrow \Omega(P \times L)[1]$ is a multilinear map of degree 1.
- (2) $\mathbf{m}_{k,\beta}^P$ is pointwise in P direction if $\beta \neq \beta_0$.
- (3) $\mathbf{m}_{k,\beta_0}^P = 0$ for $k \neq 1, 2$.
- (4) $\mathbf{m}_{1,\beta_0}^P(h) = (-1)^* dh$. Here d is the de Rham differential and $*$ is as in (3.42).
- (5) $\mathbf{m}_{k,\beta}^P$ satisfies the following A_∞ relation.

$$\sum_{k_1+k_2=k+1} \sum_{\beta_1+\beta_2=\beta} \sum_{i=1}^{k-k_2+1} (-1)^* \mathbf{m}_{k_1,\beta_1}^P(h_1, \dots, \mathbf{m}_{k_2,\beta_2}^P(h_i, \dots, h_{i+k_2-1}), \dots, h_k) = 0, \quad (14.4)$$

where $*$ = $\deg' h_1 + \dots + \deg' h_{i-1}$.

We put

$$\mathbf{m}_k^P = \sum_{\beta \in G} T^\beta \mathbf{m}_{k,\beta}^P.$$

(14.4) the implies A_∞ relation for \mathbf{m}_k^P . \diamond

Remark 14.9. We may choose \mathbf{m}_{2,β_0}^P such that $\mathbf{m}_{2,\beta_0}^P(h_1 \wedge h_2) = (-1)^* h_1 \wedge h_2$ holds if h_1 or h_2 are supported on the diagonal component. Here \wedge is the wedge product and $*$ = $\deg h_1(\deg h_2 + 1)$. See Remark 3.44. \diamond

Definition 14.10. A partial P -parametrized family of G -gapped filtered A_∞ algebra structures on $CF(P \times L; \Theta; \Lambda_0)$ of energy cut level E and of minimal energy e_0 is $\{\mathbf{m}_{k,\beta}^P\}$ that satisfies the same properties as above except the following points.

- (a) $\mathbf{m}_{k,\beta}^P$ is defined only for $\beta \in G, k = 0, 1, 2, \dots$ with $\beta + ke_0 \leq E$.
- (b) We require the A_∞ relation (14.4) only for β, k with $\beta + ke_0 \leq E$.
- (c) $\mathbf{m}_{k,\beta}^P = 0$ if $0 < \beta < e_0$.

\diamond

We can restrict a P -parametrized family of G -gapped filtered A_∞ algebra structures to the normalized boundary of P and corners of P in an obvious way.

Example 14.11. The $[0, 1]$ -parametrized family of G -gapped filtered A_∞ algebra structures of energy cut level E is nothing but a pseudo-isotopy modulo T^E of G -gapped filtered A_∞ algebra as in Definition 3.36. \diamond

We next define the notion of collared structure. We define the case $P = [0, 1]^n$, only. See [FOOO11, FOOO13] for the general case.

Definition 14.12. Let $\{\mathbf{m}_{k,\beta}^P\}$ be a P -parametrized family of G -gapped partial A_∞ -structure of energy cut level E_0 and minimal energy e_0 . We say it is τ -collared if the following holds for $(t_1, \dots, t_n) \in [0, 1]^n$.

We consider the case $t_1 \leq t_2 \leq \dots, \leq t_{n-1} \leq t_n$, only. The general case is similar.

Let $t_i \in [0, \tau]$, $t_{j+1} \in [1 - \tau, 1]$ and $t_{i+1}, \dots, t_j \in (\tau, 1 - \tau)$.

Let $(s_1, \dots, s_{i+n-j}) = (t_1, \dots, t_i, t_{j+1}, \dots, t_n)$ and $(s'_1, \dots, s'_{j-i}) = (t_{i+1}, \dots, t_j)$. A differential form of P in a neighborhood is written as $\sum f_{I,I'} ds_I \wedge ds'_{I'}$, where ds_I are wedge products of ds_i 's and $ds'_{I'}$ are wedge products of ds'_i 's.

By definition, $\mathfrak{m}_{k,\beta}^P$ is written on this neighborhood as the form

$$\mathfrak{m}_{k,\beta}^P(h_1, \dots, h_k) = \sum_{I,I'} ds_I \wedge ds'_{I'} \wedge \mathfrak{m}_{k,\beta;I,I'}^{s,s'}(h_1, \dots, h_k),$$

where h_i are smooth differential forms $P \times L$ twisted by Θ which does not have dt_i components. We now require:

- (1) $\mathfrak{m}_{k,\beta;I,I'}^{s,s'}(h_1, \dots, h_k) = 0$ unless $I = \emptyset$.
- (2) If $I = \emptyset$, $\mathfrak{m}_{k,\beta;I,\emptyset}^{s,s'}(h_1, \dots, h_k)$ is independent of $s \in [0, \tau]^i \times [1 - \tau, 1]^{n-j}$.

We say $\{\mathfrak{m}_{k,\beta}^P\}$ is collared if it is τ -collared for some $\tau > 0$. \diamond

The main lemma we will use to prove Theorems 14.4 and 14.6 is Proposition 14.14 below.

Situation 14.13. Let P be a manifold with corner and $E_1 > E_0 \geq 0$, $e_0 > 0$. We assume that we are given the following objects.

- (1) A $P \times [0, 1]$ -parametrized collared partial A_∞ structure $\{\mathfrak{m}_{k,\beta}^{P \times [0,1]}\}$ of energy cut level E_0 and of minimal energy e_0 on $CF(P \times L; \Theta; \Lambda_0)$.
- (2) A collared partial A_∞ structure $\{\mathfrak{m}_{k,\beta}^{P \times \{1\}}\}$ on $CF(P \times \{1\} \times L; \Theta; \Lambda_0)$ of energy cut level E_1 is given. We require that it coincides with the restriction of $\{\mathfrak{m}_{k,\beta}^{P \times [0,1]}\}$ to $P \times \{1\}$ as the partial A_∞ structures of energy cut level E_0 .
- (3) Let $\partial P = \coprod \partial_i P$ be the decomposition of the normalized boundary of P into the connected components. Then for each i we are given a collared filtered A_∞ structure $\{\mathfrak{m}_{k,\beta}^{\partial_i P \times [0,1]}\}$ of energy cut level E_1 . We require that it coincides with the restriction of $\{\mathfrak{m}_{k,\beta}^{P \times [0,1]}\}$ to $\partial_i P \times [0, 1]$ as the partial A_∞ structures of energy cut level E_0 .
- (4) We assume that the restriction of the structure $\{\mathfrak{m}_{k,\beta}^{P \times \{1\}}\}$ in item (2) coincides with the structure $\{\mathfrak{m}_{k,\beta}^{\partial_i P \times [0,1]}\}$ in item (3) on $\partial_i P \times \{1\}$.
- (5) Suppose that the images of $\partial_i P$ and $\partial_j P$ intersect each other in P at the component $\partial_{ij} P$ of the codimension 2 corner of P . (Note that the case $i = j$ is included. In this case, $\partial_{ii} P$ is the 'self intersection' of $\partial_i P$.) We then assume that the restriction of $\{\mathfrak{m}_{k,\beta}^{\partial_i P \times [0,1]}\}$ to $\partial_{ij} P \times [0, 1]$ coincides with the restriction of $\{\mathfrak{m}_{k,\beta}^{\partial_j P \times [0,1]}\}$.

\diamond

See Figure 85

Proposition 14.14. *In Situation 14.13 there exists a collared partial P -parametrized family of G -gapped filtered A_∞ algebra structures on $CF(P \times L; \Theta; \Lambda_0)$ of energy cut level E_1 and of minimal energy e_0 , which we denote by $\{\mathfrak{m}_{+,k,\beta}^{P \times [0,1]}\}$. It has the following properties.*

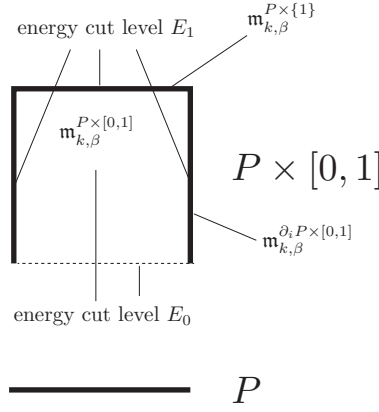

FIGURE 85. $P \times [0, 1]$ -parametrized family.

- (1) If we regard $\{\mathfrak{m}_{+,k,\beta}^{P \times [0,1]}\}$ as a partial structure of energy cut level E_0 , then it coincides with $\{\mathfrak{m}_{k,\beta}^{P \times [0,1]}\}$.
- (2) If we restrict $\{\mathfrak{m}_{+,k,\beta}^{P \times [0,1]}\}$ to $P \times \{1\}$, then it coincides with the structure $\{\mathfrak{m}_{k,\beta}^{P \times \{1}\}\}$ in Situation 14.13 (2).
- (3) If we restrict $\{\mathfrak{m}_{+,k,\beta}^{P \times [0,1]}\}$ to $\partial_i P \times [0, 1]$, then it coincides with the structure $\{\mathfrak{m}_{k,\beta}^{\partial_i P \times [0,1]}\}$ in Situation 14.13 (3).

◇

In the case when P is a one point this is nothing but Lemma 3.42. The proposition in this generality is proved in [FOOO11] [FOOO13, Proposition 22.13]. See also [Fu9, Section 14].⁵⁶

14.3. Well defined-ness of a filtered A_∞ category up to strong homotopy equivalence.

Proof of Theorem 14.4 (1). We prove the case of $(X_1, \omega_1, \mathbb{L}_1)$. The other cases are the same. By the trick we used in Subsection 3.4 it suffices to consider the case when \mathbb{L}_1 consists of a single immersed Lagrangian submanifold L_1 . Let $J_{1,j}$ ($j = 1, 2$) be the almost complex structure on X_1 chosen as a part of Choice $\Xi_{1,j}$. We take one parameter family of compatible almost complex structures $J_{1,s}$ parametrized by $s \in [0, 1]$ such that $J_{1,s} = J_1$ for $s \in [0, \tau]$ and $J_{1,s} = J_2$ for $s \in [1 - \tau, 1]$. We use the notations of Subsection 3.3. The moduli space $\mathcal{M}_{k+1}(L_1; E)$ is as in (3.29). We write $\mathcal{M}_{k+1}((L_1, J); E)$ to specify the almost complex structure J we use.

Hereafter in this subsection we omit the suffix 1 and write L, X, J_j, Ξ_j etc. in place of $L_1, X_1, J_{1,j}, \Xi_{1,j}$ etc.

Definition 14.15. We define

$$\mathcal{M}_{k+1}(L; E; [0, 1]_s) = \bigcup_{s \in [0,1]_s} \mathcal{M}_{k+1}((L, J_s); E) \times \{s\}. \tag{14.5}$$

⁵⁶The singular homology version (of the case $P = [0, 1]$) is [FOOO2, Theorem 7.2.212]. Actually singular homology version is harder to state and prove.

The evaluation map

$$\text{ev} = (\text{ev}_0, \dots, \text{ev}_k) : \mathcal{M}_{k+1}(L; E; [0, 1]_s) \rightarrow L^{k+1} \quad (14.6)$$

is defined by Definition 3.22. The other evaluation map

$$\text{ev}_{[0,1]_s} : \mathcal{M}_{k+1}(L; E; [0, 1]_s) \rightarrow [0, 1]_s \quad (14.7)$$

is defined by sending $\mathcal{M}_{k+1}((L, J_s); E) \times \{s\}$ to s .⁵⁷

Proposition 14.16. *We can define a topology on $\mathcal{M}_{k+1}(L; E; [0, 1]_s)$, the stable map topology, which is Hausdorff and compact. There exists a system of Kuranishi structures with a boundary and corners on $\mathcal{M}_{k+1}(L; E; [0, 1]_s)$ for various k and E with the following properties.*

- (1) *The evaluation maps (14.6) and (14.7) extend to strongly smooth maps. The map $(\text{ev}_0, \text{ev}_{[0,1]_s})$ is weakly submersive.⁵⁸*
- (2) *The normalized boundary of $\mathcal{M}_{k+1}(L; E; [0, 1]_s)$ is a disjoint union of the following two types of spaces.*

(I) *The fiber product*

$$\mathcal{M}_{k_1+1}(L; E_1; [0, 1]_s) \times_{(\text{ev}_i, \text{ev}_{[0,1]_s})} \times_{(\text{ev}_0, \text{ev}_{[0,1]_s})} \mathcal{M}_{k_2+1}(L; E_2; [0, 1]_s),$$

over $L \times [0, 1]_s$. Here $k_1 + k_2 = k$, $i = 1, \dots, k_2$, $E_1 + E_2 = E$. The fiber product carries a Kuranishi structure because of the weak submersivity of $(\text{ev}_0, \text{ev}_{[0,1]_s})$. See [FOOO10, Definition 4.9], [FOOO13, Chapter 26].

(II) *The inverse image*

$$\text{ev}_{[0,1]_s}^{-1}(\partial[0, 1]_s) \subset \mathcal{M}_{k+1}(L; E; [0, 1]_s).$$

- (3) *For sufficiently small τ the following holds.*

The restriction of the Kuranishi structure to $\text{ev}_{[0,1]_s}^{-1}([0, \tau])$ coincides with the direct product of the trivial Kuranishi structure on $[0, \tau]$ and the Kuranishi structure of $\mathcal{M}_{k+1}((L, J_1); E)$, which is a part of the data Ξ_1 .

The restriction of the Kuranishi structure to $\text{ev}_{[0,1]_s}^{-1}([1 - \tau, 1])$ coincides with the direct product of the trivial Kuranishi structure on $[1 - \tau, 1]$ and the Kuranishi structure of $\mathcal{M}_{k+1}((L, J_2); E)$ which is a part of the data Ξ_2 .

- (4) *The orientation bundles are compatible with the description of the boundary in item (2).*

◇

The proof is a one parameter version of the proof of Theorem 3.24. Note that the fact that our Kuranishi structure (and the moduli space) is of product type near the boundary of Type (II), which is stated as item (3), is a consequence of our choice of family of almost complex structures.

Let $G(L; \Xi_j)$ be the discrete submonoid defined in Definition 3.19. Note that it depends on the almost complex structure and so on Ξ_j . However we may choose a discrete submonoid $G(L)$ with the following properties.

(Mo.1) The submonoid $G(L)$ contains both $G(L; \Xi_1)$ and $G(L; \Xi_2)$.

(Mo.2) If $\mathcal{M}_{k+1}(L; E; [0, 1]_s)$ is nonempty then $E \in G(L)$.

⁵⁷We use the notation $[0, 1]_s$ here to distinguish it from the interval which we use for different parameter.

⁵⁸Since $[0, 1]_s$ has boundary we need to define weakly submersivity a bit carefully. See [FOOO11, Section 25], [FOOO13, Chapter 26].

We put $G(L) = \{E_1, E_2, \dots, E_n, \dots\}$ where $E_1 < E_2 < \dots$. Let $E_i \in G(L)$. Proposition 3.30 assigns a CF-perturbation of $\mathcal{M}_{k+1}((L, J_j); E)$ with $E \leq E_i$ ($j = 1, 2$). These CF-perturbations and the Kuranishi structures on which they are defined are parts of the data Ξ_j . We denote this CF-perturbation by $\widehat{\mathfrak{S}}(\Xi_j; E_i)$.

Proposition 14.17. *There exists a system of CF-perturbations $\widehat{\mathfrak{S}}([0, 1]_s; E_i)$ on outer collarings of thickenings of $\mathcal{M}_{k+1}(L; E; [0, 1]_s)$ with $E \leq E_i$ with the following properties.*

- (1) *The CF-perturbation $\widehat{\mathfrak{S}}([0, 1]_s; E)$ is transversal to 0.*
- (2) *The map $(\text{ev}_0, \text{ev}_{[0, 1]_s})$ is strongly submersive with respect to $\widehat{\mathfrak{S}}([0, 1]_s; E)$.*
- (3) *The restriction of $\widehat{\mathfrak{S}}([0, 1]_s; E)$ to the boundary in Proposition 14.16 (2) (I) coincides with the fiber product CF-perturbation ([FOOO11, Definition 10.13]), which is well-defined by item (2).*
- (4) *For sufficiently small τ the following holds.*

The restriction of $\widehat{\mathfrak{S}}([0, 1]_s; E)$ to $\text{ev}_{[0, 1]_s}^{-1}([0, \tau])$ coincides with the pull back of $\widehat{\mathfrak{S}}(\Xi_1; E)$.

The restriction of $\widehat{\mathfrak{S}}([0, 1]_s; E)$ to $\text{ev}_{[0, 1]_s}^{-1}([1 - \tau, 1])$ coincides with the pull back of $\widehat{\mathfrak{S}}(\Xi_2; E)$.

◇

Proof. We define the CF-perturbation on the neighborhood of the boundary component in Proposition 14.16 (2) (II) by item (4). Then we can extend it using the (relative version) of the existence of CF-perturbation. (See [FOOO11, FOOO13, Chapter 17].) □

Remark 14.18. During the proof of Proposition 14.17 we construct Kuranishi structures on which our CF-perturbations are defined at the same time. See [FOOO11, FOOO13] for this point.

Now for $\beta = E \in G(L)$ with $E \leq E_i$, we define

$$\mathbf{m}_{k,E}^{E_i;[0,1]_s} : CF([0, 1]_s \times L; \Theta; \mathbb{R})^{\otimes k} \rightarrow CF([0, 1]_s \times L; \Theta; \mathbb{R})$$

by

$$\begin{aligned} & \mathbf{m}_{k,E}^{E_i;[0,1]_s}(h_1, \dots, h_k) \\ &= (\text{ev}_0, \text{ev}_{[0, 1]_s})!((\text{ev}_1, \text{ev}_{[0, 1]_s})^*(h_1) \wedge \\ & \quad \dots \wedge (\text{ev}_k, \text{ev}_{[0, 1]_s})^*(h_k); \widehat{\mathfrak{S}}([0, 1]_s; E_i)). \end{aligned} \tag{14.8}$$

Here the integration by parts is taken on the space $\mathcal{M}_{k+1}(L; E; [0, 1]_s)$ using the CF-perturbation $\widehat{\mathfrak{S}}([0, 1]_s; E_i)$. See [FOOO13, Subsection 2.2.4] and [ST, Subsection 4.1] for the sign.

Lemma 14.19. *The operations $\{\mathbf{m}_{k,E}^{E_i;[0,1]_s}; E \leq E_i\}$ define a collared partial $[0, 1]_s$ -parametrized family of $G(L)$ -gapped filtered A_∞ algebra structures on $CF([0, 1]_s \times L; \Theta; \Lambda_0)$ of energy cut level E_i and of minimal energy e_0 .⁵⁹ ◇*

This is a consequence of Proposition 14.17. Point-wise-ness in $[0, 1]_s$ direction follows from [FOOO13, Proposition 22.17]. Moreover the restrictions of the structure

⁵⁹The minimal energy is always e_0 in this section. So we omit it from now on.

operations $\{\mathfrak{m}_{k,E}^{E_i;[0,1]_s}; E \leq E_i\}$ to $\{0\} \in [0, 1]_s$ (resp. $\{1\} \in [0, 1]_s$) coincide with the partial $[0, 1]_s$ -parametrized family of $G(L)$ -gapped filtered A_∞ algebra structures on $CF(L; \Theta; \Lambda_0)$ of energy cut level E_i , which we used during the construction of $\mathfrak{Fut}(X; \mathbb{L}; \Xi_1)$, (resp. $\mathfrak{Fut}(X; \mathbb{L}; \Xi_2)$).

We remark however that $\mathfrak{m}_{k,E}^{E_i;[0,1]_s}$ itself is not the structure operation of the pseudo-isotopy between $\mathfrak{Fut}(X; \mathbb{L}; \Xi_1)$ and $\mathfrak{Fut}(X; \mathbb{L}; \Xi_2)$, which we look for. This is because this structure is yet a partial structure where $\mathfrak{m}_{k,E}^{E_i;[0,1]_s}$ is defined for $E \leq E_i$ only. We will combine the process of taking homotopy limit with the construction of pseudo-isotopy as follows.

During the construction of the structure operations of $\mathfrak{Fut}(X; \mathbb{L}; \Xi_j)$ we used a Kuranishi structure on $\mathcal{M}_{k+1}((L, J_j); E) \times [0, 1]_t$ and its CF-perturbation such that the restriction of this CF-perturbation to $\mathcal{M}_{k+1}((L, J_j); E) \times \{0\}$ is $\widehat{\mathfrak{S}}(\Xi_j; E_i)$ and that the restriction of this CF-perturbation to $\mathcal{M}_{k+1}((L, J_j); E) \times \{1\}$ is $\widehat{\mathfrak{S}}(\Xi_j; E_{i+1})$. (Lemma 3.38.) We denote this CF-perturbation by $\widehat{\mathfrak{S}}([0, 1]_t, \Xi_j; E_i, E_{i+1})$. Note that we can take this CF-perturbation so that it is constant in t direction for $t \in [0, \mu] \cup [1 - \mu, 1]$.

During the proof of Proposition 3.37 we used $\widehat{\mathfrak{S}}([0, 1]_t, \Xi_j; E_i, E_{i+1})$ in the same way as (14.8) to define a collared partial $[0, 1]_t$ -parametrized family of $G(L)$ -gapped filtered A_∞ algebra structures on $CF([0, 1]_t \times L; \Theta; \Lambda_0)$ of energy cut level E_{i+1} and of minimal energy e_0 . (See (3.52).) We denote the structure operation of this structure by $\{\mathfrak{m}_{k,E}^{E_i, E_{i+1}; [0, 1]_t}; E \leq E_i\}$.

We then construct a pseudo-isotopy of pseudo-isotopies using the next proposition.

Proposition 14.20. *There exists a system of CF-perturbations, which we denote by $\widehat{\mathfrak{S}}([0, 1]_s \times [0, 1]_t; E_i, E_{i+1})$, on outer collarings of thickenings of $\mathcal{M}_{k+1}(L; E; [0, 1]_s) \times [0, 1]_t$ for $E \leq E_{i+1}$ with the following properties.*

- (1) *The CF-perturbation $\widehat{\mathfrak{S}}([0, 1]_s \times [0, 1]_t; E_i, E_{i+1})$ is transversal to 0.*
- (2) *The map*

$$(\text{ev}_0, \text{ev}_{[0,1]_s}, \text{ev}_{[0,1]_t}) : \mathcal{M}_{k+1}(L; E; [0, 1]_s) \times [0, 1]_t \rightarrow (\tilde{L} \times_X \tilde{L}) \times [0, 1]_s \times [0, 1]_t$$

is strongly submersive with respect to $\widehat{\mathfrak{S}}([0, 1]_s \times [0, 1]_t, \Xi_j; E_i, E_{i+1})$.

- (3) *We consider the restriction of $\widehat{\mathfrak{S}}([0, 1]_s \times [0, 1]_t; E_i, E_{i+1})$ to the boundary component, which is a product of $[0, 1]_t$ and the boundary component of $\mathcal{M}_{k+1}(L; E; [0, 1]_s)$ in Proposition 14.16 (2) (I). It then coincides with the fiber product CF-perturbation, which is well-defined by item (2).*
- (4) *For sufficiently small τ the following holds.*

The restriction of $\widehat{\mathfrak{S}}([0, 1]_s \times [0, 1]_t; E_i, E_{i+1})$ to $\text{ev}_{[0,1]_s}^{-1}([0, \tau])$ coincides with the pull back of $\widehat{\mathfrak{S}}([0, 1]_t, \Xi_1; E_i, E_{i+1})$.

The restriction of $\widehat{\mathfrak{S}}([0, 1]_s \times [0, 1]_t; E_i, E_{i+1})$ to $\text{ev}_{[0,1]_s}^{-1}([1 - \tau, 1])$ coincides with the pull back of $\widehat{\mathfrak{S}}([0, 1]_t, \Xi_2; E_i, E_{i+1})$.

- (5) *For sufficiently small τ the following holds.*

The restriction of $\widehat{\mathfrak{S}}([0, 1]_s \times [0, 1]_t; E_i, E_{i+1})$ to $\text{ev}_{[0,1]_t}^{-1}([0, \tau])$ coincides with the pull back of $\widehat{\mathfrak{S}}([0, 1]_s; E_i)$.

The restriction of $\widehat{\mathfrak{G}}([0, 1]_s \times [0, 1]_t; E_i, E_{i+1})$ to $\text{ev}_{[0,1]_s}^{-1}([1 - \tau, 1])$ coincides with the pull back of $\widehat{\mathfrak{G}}([0, 1]_s; E_{i+1})$.

◇

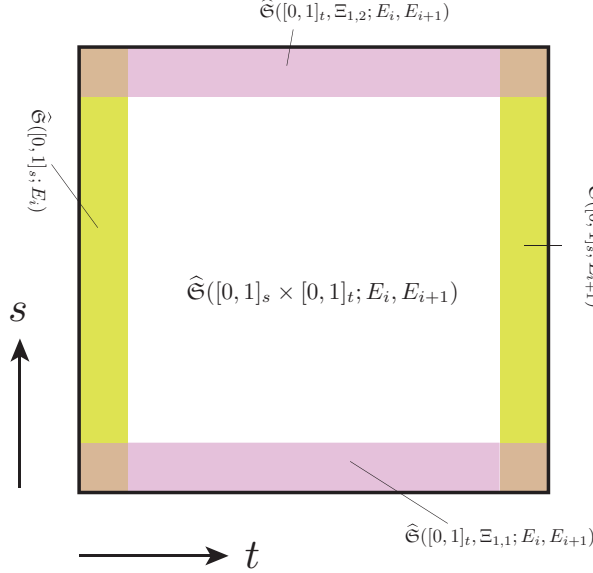

FIGURE 86. $\widehat{\mathfrak{G}}([0, 1]_s \times [0, 1]_t; E_i, E_{i+1})$

The proof of Proposition 14.20 is by induction on E . On each step of the induction the CF-perturbation on the boundary is determined by the statement we are proving. So we can extend it. (See [FOOO11, FOOO13, Chapter 17].)

We now recall the construction at the end of Subsection 3.3. We consider the restriction to $s = 0$. We use Ξ_1 to obtain a system of partial filtered A_∞ structures $\{\mathfrak{m}_{k,\beta}^{\Xi_1,i,E \leq E_i}\}$ and pseudo-isotopies $\{\mathfrak{m}_{k,\beta}^{[0,1]_t, \Xi_1,i,E \leq E_i}\}$ among them. Then we used Lemma 3.42, which is nothing but the case of $P = [0, 1]$ of Proposition 14.14. We then obtain a sequence of filtered A_∞ structures $\{\mathfrak{m}_{k,\beta}^{\Xi_1,i}\}$ on $CF(L; \Theta; \Lambda_0)$ such that it coincides with $\{\mathfrak{m}_{k,\beta}^{\Xi_1,i,E \leq E_i}\}$ as partial structures with energy cut level E_i , for each i . Moreover there exists a pseudo-isotopy $\{\mathfrak{m}_{k,\beta}^{[0,1]_t, \Xi_1,i}\}$ between $\{\mathfrak{m}_{k,\beta}^{\Xi_1,i,E \leq E_i}\}$ and $\{\mathfrak{m}_{k,\beta}^{\Xi_1,i+1,E \leq E_{i+1}}\}$ which coincides with $\{\mathfrak{m}_{k,\beta}^{[0,1]_s, \Xi_1,i,E \leq E_i}\}$ as a pseudo-isotopy with energy cut level E_i . See Figure 87.

We can perform the same construction for $s = 1$ using Ξ_1 and obtain $\{\mathfrak{m}_{k,\beta}^{[0,1]_t, \Xi_2,i}\}$, $\{\mathfrak{m}_{k,\beta}^{\Xi_2,i+1,E \leq E_{i+1}}\}$.

Now we apply Proposition 14.14 inductively and obtain the following:

Lemma 14.21. *There exists a sequence of $P = [0, 1]_s \times [0, 1]_t$ parametrized family of filtered A_∞ algebra $\{\mathfrak{m}_{k,\beta}^{[0,1]_s \times [0,1]_t, i}\}$ on $CF([0, 1]_s \times [0, 1]_t \times L; \Theta; \mathbb{R})$ with the following properties.*

- (1) *It coincides with one obtained by the CF-perturbation $\widehat{\mathfrak{G}}([0, 1]_s \times [0, 1]_t; E_i, E_{i+1})$ as partial structures with energy cut level E_i .*

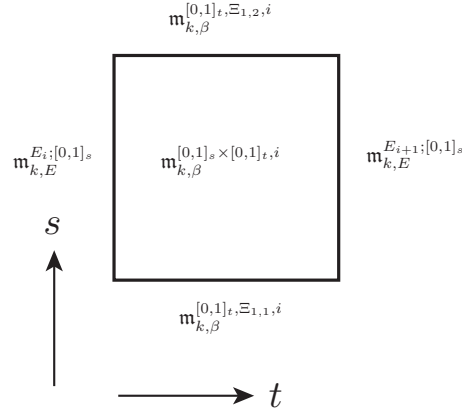

FIGURE 87. Pseudo-isotopy of pseudo-isotopies

- (2) Its restriction to $s = 0$ coincides with $\{\mathbf{m}_{k, \beta}^{[0,1]_t, \Xi_{1,1}, i}\}$.
- (3) Its restriction to $s = 1$ coincides with $\{\mathbf{m}_{k, \beta}^{[0,1]_t, \Xi_{1,2}, i}\}$.
- (4) Its restriction to $t = 1$ coincides with $\{\mathbf{m}_{k, E}^{E_{i+1}; [0,1]_s}; E \leq E_{i+1}\}$ in Lemma 14.19 as partial structures with energy cut level E_{i+1} .
- (5) Its restriction to $t = 0$ coincides with $\{\mathbf{m}_{k, E}^{E_i; [0,1]_s}; E \leq E_i\}$ in Lemma 14.19 as partial structures with energy cut level E_i .

◇

See Figure 88. We restrict $\{\mathbf{m}_{k, \beta}^{[0,1]_s \times [0,1]_t, 0}\}$ to $t = 0$ and obtain:

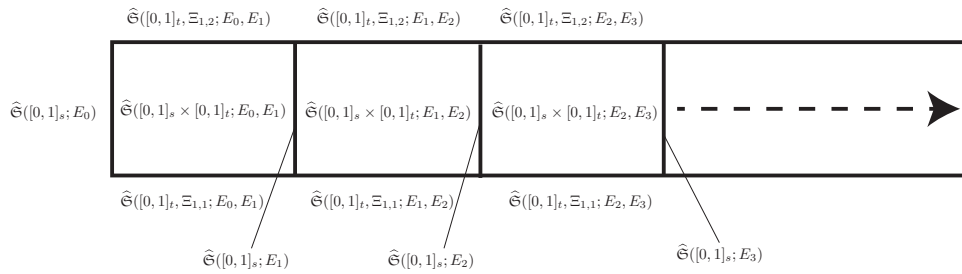

FIGURE 88. Inductive limit construction of pseudo-isotopy

Corollary 14.22. *There exists a pseudo-isotopy of filtered A_∞ structures $\{\mathbf{m}_{k, E}^{[0,1]_s}\}$ on $CF([0,1]_s \times L; \Theta; \mathbb{R})$ with the following properties.*

- (1) The structure $\{\mathbf{m}_{k, E}^{[0,1]_s}\}$ coincides with $\{\mathbf{m}_{k, E}^{E_0; [0,1]_s}; E \leq E_0\}$ in Lemma 14.19 as partial structures of energy cut level E_0 .
- (2) The restriction of $\{\mathbf{m}_{k, E}^{[0,1]_s}\}$ to $s = 0$ and $s = 1$ coincide with $\{\mathbf{m}_{k, E}^{\Xi_{1,1}}\}$ and $\{\mathbf{m}_{k, E}^{\Xi_{1,2}}\}$, respectively.

◇

Corollary 14.22 implies that $\{\mathfrak{m}_{k,E}^{\Xi_1}\}$ is pseudo-isotopic to $\{\mathfrak{m}_{k,E}^{\Xi_2}\}$. In particular they are strongly homotopy equivalent. The proof of Theorem 14.4 (1) is complete. \square

Proof of Theorem 14.4 (2). The proof of Theorem 14.4 (2) is similar to the proof of (1) but we need to iterate once more the process to take higher homotopy as the following.

During the construction of pseudo-isotopy in Corollary 14.22 we made various choices. Especially we made a choice of CF-perturbations $\widehat{\mathfrak{S}}([0,1]_s \times [0,1]_t; E_i, E_{i+1})$ in Proposition 14.20. We will prove the homotopy equivalence we obtained in the proof of Theorem 14.4 (1) is independent of such choices up to homotopy.

Suppose $\widehat{\mathfrak{S}}([0,1]_s \times [0,1]_t; j; E_i, E_{i+1})$, $j = 1, 2$ are two choices. We denote by $\{\mathfrak{m}_{k,E}^{[0,1]_s, j=1}\}$, $\{\mathfrak{m}_{k,E}^{[0,1]_s, j=2}\}$ the pseudo-isotopies obtained by these two choices, respectively.

Lemma 14.23. *There exists a system of CF-perturbations, which we denote by $\widehat{\mathfrak{S}}([0,1]_s \times [0,1]_t \times [0,1]_u; E_i, E_{i+1})$, on outer collarings of thickenings of $\mathcal{M}_{k+1}(L_1; E; [0,1]_s) \times [0,1]_t \times [0,1]_u$ for $E \leq E_{i+1}$ with the following properties.*

- (1) *The CF-perturbation $\widehat{\mathfrak{S}}([0,1]_s \times [0,1]_t \times [0,1]_u; E_i, E_{i+1})$ is transversal to 0.*
- (2) *The map*

$$\begin{aligned} (\text{ev}_0, \text{ev}_{[0,1]_s}, \text{ev}_{[0,1]_t}, \text{ev}_{[0,1]_u}) : \mathcal{M}_{k+1}(L_1; E; [0,1]_s) \times [0,1]_t \times [0,1]_u \\ \rightarrow R \times [0,1]_s \times [0,1]_t \times [0,1]_u \end{aligned}$$

is strongly submersive with respect to $\widehat{\mathfrak{S}}([0,1]_s \times [0,1]_t \times [0,1]_u; E_i, E_{i+1})$.

- (3) *We consider the restriction of $\widehat{\mathfrak{S}}([0,1]_s \times [0,1]_t \times [0,1]_u; E_i, E_{i+1})$ to the boundary components, which are products of $[0,1]_t \times [0,1]_u$ and the boundary components of $\mathcal{M}_{k+1}(L_1; E; [0,1]_s)$ in Proposition 14.16 (2) (I). It then coincides with the fiber product CF-perturbation, which is well-defined by item (2).*
- (4) *For sufficiently small τ the following holds.*

The restriction of $\widehat{\mathfrak{S}}([0,1]_s \times [0,1]_t \times [0,1]_u; E_i, E_{i+1})$ to $\text{ev}_{[0,1]_u}^{-1}([0, \tau])$ coincides with the pull back of $\widehat{\mathfrak{S}}([0,1]_s \times [0,1]_t; 1; E_i, E_{i+1})$.

The restriction of $\widehat{\mathfrak{S}}([0,1]_s \times [0,1]_t \times [0,1]_u; E_i, E_{i+1})$ to $\text{ev}_{[0,1]_u}^{-1}([1 - \tau, 1])$ coincides with the pull back of $\widehat{\mathfrak{S}}([0,1]_s \times [0,1]_t; 2; E_i, E_{i+1})$.

- (5) *For sufficiently small τ the following holds.*

The restriction of $\widehat{\mathfrak{S}}([0,1]_s \times [0,1]_t \times [0,1]_u; E_i, E_{i+1})$ to $\text{ev}_{[0,1]_s}^{-1}([0, \tau])$ coincides with the pull back of $\widehat{\mathfrak{S}}([0,1]_t, \Xi_1; E_i, E_{i+1})$. (In particular this restriction is constant in u direction.)

The restriction of $\widehat{\mathfrak{S}}([0,1]_s \times [0,1]_t \times [0,1]_u; E_i, E_{i+1})$ to $\text{ev}_{[0,1]_s}^{-1}([1 - \tau, 1])$ coincides with the pull back of $\widehat{\mathfrak{S}}([0,1]_t, \Xi_2; E_i, E_{i+1})$.

- (6) *For sufficiently small τ the following holds.*

The restriction of $\widehat{\mathfrak{S}}([0,1]_s \times [0,1]_t \times [0,1]_u; E_i, E_{i+1})$ to $\text{ev}_{[0,1]_t}^{-1}([0, \tau])$ coincides with the pull back of $\widehat{\mathfrak{S}}([0,1]_s; E_i)$.

The restriction of $\widehat{\mathfrak{S}}([0, 1]_s \times [0, 1]_t \times [0, 1]_u; E_i, E_{i+1})$ to $\text{ev}_{[0, 1]_s}^{-1}([1 - \tau, 1])$ coincides with the pull back of $\widehat{\mathfrak{S}}([0, 1]_s; E_{i+1})$.

◇

See Figure 89. The proof of Lemma 14.23 is the same as other similar results

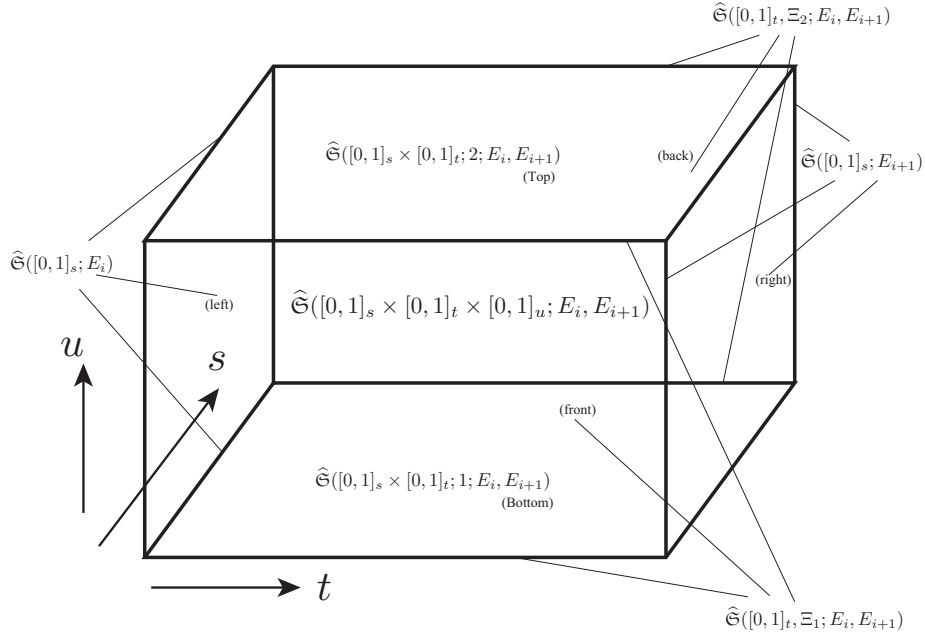

FIGURE 89. pseudo-isotopy of pseudo-isotopies of pseudo-isotopies

such as Proposition 14.20.

Now we discuss in the same way as Lemma 14.21 and Corollary 14.22 using Proposition 14.14 and obtain:

Lemma 14.24. *There exists a $P = [0, 1]_s \times [0, 1]_u$ parametrized family of filtered A_∞ structures $\{\mathfrak{m}_{k,E}^{[0,1]_s \times [0,1]_u}\}$ on $CF([0, 1]_s \times [0, 1]_u \times L; \Theta; \mathbb{R})$ with the following properties.*

- (1) *The restriction of the structure $\{\mathfrak{m}_{k,E}^{[0,1]_s \times [0,1]_u}\}$ to $u = 0$ (resp. $u = 1$) coincides with the pseudo-homotopy of Corollary 14.22 obtained by using $\widehat{\mathfrak{S}}([0, 1]_s \times [0, 1]_t; 1; E_i, E_{i+1})$ (resp. $\widehat{\mathfrak{S}}([0, 1]_s \times [0, 1]_t; 2; E_i, E_{i+1})$).*
- (2) *The restriction of $\{\mathfrak{m}_{k,E}^{[0,1]_s}\}$ to $s = 0$ and $s = 1$ coincide with the pull back of $\{\mathfrak{m}_{k,E}^{\Xi_1}\}$ and $\{\mathfrak{m}_{k,E}^{\Xi_2}\}$, respectively. In particular they are trivial in $[0, 1]_u$ factor.*

◇

In other words we have the following commutative diagram.

$$\begin{array}{ccccc}
(CF(L), \{\mathbf{m}_{k,E}^{\Xi_2}\}) & \xleftarrow{\text{Eval}_{u=0}} & CF([0, 1]_u \times L) & \xrightarrow{\text{Eval}_{u=1}} & (CF(L), \{\mathbf{m}_{k,E}^{\Xi_2}\}) \\
\text{Eval}_{s=1} \uparrow & & \uparrow \text{Eval}_{s=1} & & \uparrow \text{Eval}_{s=1} \\
(CF([0, 1]_s \times L), \{\mathbf{m}_{k,E}^{[0,1]_{s,j=1}}\}) & \xleftarrow{\text{Eval}_{u=0}} & (CF([0, 1]_s \times [0, 1]_u \times L), \{\mathbf{m}_{k,E}^{[0,1]_{s,j=1}}\}) & \xrightarrow{\text{Eval}_{u=1}} & (CF([0, 1]_s \times L), \{\mathbf{m}_{k,E}^{[0,1]_{s,j=2}}\}) \\
\text{Eval}_{s=0} \downarrow & & \downarrow \text{Eval}_{s=0} & & \downarrow \text{Eval}_{s=0} \\
(CF(L), \{\mathbf{m}_{k,E}^{\Xi_1}\}) & \xleftarrow{\text{Eval}_{u=0}} & CF([0, 1]_t \times L) & \xrightarrow{\text{Eval}_{u=1}} & (CF(L), \{\mathbf{m}_{k,E}^{\Xi_1}\})
\end{array}$$

All the arrows in the diagram are strong homotopy equivalences. By Lemma 14.24 (2) we find that $\text{Eval}_{u=1}$ in the first horizontal line is homotopic to $\text{Eval}_{u=0}$ in the first horizontal line. The same holds for the third horizontal line.

The composition

$$\text{Eval}_{s=1} \circ (\text{Eval}_{s=0})^{-1} : (CF(L), \{\mathbf{m}_{k,E}^{\Xi_1}\}) \rightarrow (CF(L), \{\mathbf{m}_{k,E}^{\Xi_2}\})$$

of maps in the first vertical line is the strong homotopy equivalence obtained from the choice $\widehat{\mathfrak{S}}([0, 1]_s \times [0, 1]_t; 1; E_i, E_{i+1})$. In the same way the third vertical line gives the strong homotopy equivalence obtained from the choice $\widehat{\mathfrak{S}}([0, 1]_s \times [0, 1]_t; 2; E_i, E_{i+1})$. Thus those two homotopy equivalences are homotopic each other. The proof of Theorem 14.4 is complete. \square

Remark 14.25. The above diagram is similar to [AJ, Figure 10.1], which is used for a similar purpose. \diamond

14.4. Proof of Theorem 14.6.

14.4.1. Pseudo-isotopy of tri-modules.

Situation 14.26. Let R_m ($m = 1, 2, 3$) be a compact smooth manifold without boundary and Θ_m a principal $O(1)$ bundles on it. Let R be a compact smooth manifold without boundary and Θ a principal $O(1)$ bundle on it.

Let P be a manifold with corners and $C(P \times R_m; \mathbb{R}) = C^\infty(\Omega(P \times R_m))$, (resp. $C(P \times R; \mathbb{R}) = C^\infty(\Omega(P \times R))$) the set of smooth forms on $P \times R_m$ (resp. R) twisted by Θ_m (resp. Θ).

We define $C(P \times R_m; \Lambda_0)$ (resp. $C(P \times R; \Lambda_0)$) as a completion of the tensor product $C(P \times R_m; \mathbb{R}) \otimes \Lambda_0$ (resp. $C(P \times R; \mathbb{R}) \otimes \Lambda_0$).

Suppose that, for each m , we are given a P -parametrized family of G -gapped filtered A_∞ structures on $C(P \times R; \Lambda_0)$, which we denote by $\{\mathbf{m}_{k,\beta}^{P,m}\}$. We put $\mathcal{C}_m^P = (C(P \times R; \Lambda_0), \{\mathbf{m}_{k,\beta}^{P,m}\})$. \diamond

Definition 14.27. A P -parametrized family of G -gapped filtered A_∞ tri-module structures on $CF(P \times R; \Theta; \Lambda_0)$ over $C(P \times R_m; \Lambda_0, \{\mathbf{m}_{k,\beta}^{P,m}\})$ ($m = 1, 2, 3$). is $\{\mathbf{n}_{k_1, k_2, k_3; \beta}^P\}$ for $\beta \in G$ and $k_i = 0, 1, 2, \dots$, that satisfies the following:

(1)

$$\mathbf{n}_{k_1, k_2, k_3; \beta}^P : \bigotimes_{i=1}^3 B_{k_i}(\Omega(P \times R_i)[1]) \otimes \Omega(P \times R)[1] \rightarrow \Omega(P \times R)[1]$$

is a multilinear map of degree 1.

- (2) The maps $\mathfrak{n}_{k_1, k_2, k_3; \beta}^P$ is pointwise in P direction if $\beta \neq \beta_0$ or $k_1 + k_2 + k_3 \geq 1$.
- (3) $\mathfrak{n}_{0,0,0; \beta_0}^P(h) = (-1)^* dh$. Here d is the de Rham differential and $*$ is as in (3.42).
- (4) The operations $\{\mathfrak{n}_{k_1, k_2, k_3; \beta}^P\}$ define a filtered A_∞ tri-module over $\mathcal{C}_m(P)$ ($m = 1, 2, 3$).

In the case when $P = [0, 1]$ we call $CF([0, 1] \times R; \Theta; \Lambda_0)$ together with its P -parametrized family of G -gapped filtered A_∞ tri-module structures, a *pseudo-isotopy of G -gapped filtered A_∞ tri-modules* over the pseudo-isotopies $\mathcal{C}_m^{[0,1]}$ ($m = 1, 2, 3$) of filtered A_∞ categories. \diamond

14.4.2. *Existence of a pseudo-isotopy of tri-modules.* We go back to our geometric situation of Theorem 14.6. We consider the case when the sets \mathbb{L}_1 , \mathbb{L}_2 and \mathbb{L}_{12} consist of single immersed Lagrangian submanifolds.

We put:

$$R_1 = \tilde{L}_1 \times_{X_1} \tilde{L}_1, \quad R_2 = \tilde{L}_2 \times_{X_2} \tilde{L}_2, \quad R_3 = \tilde{L}_{12} \times_{X_1 \times X_2} \tilde{L}_{12}. \quad (14.9)$$

The pseudo-isotopy $\mathcal{C}_m^{[0,1]}$ are given by Corollary 14.22. In particular we make Choices $\Xi_{1,j}$, $\Xi_{2,j}$, $\Xi_{12,j}$ in Situation 14.5. They give filtered A_∞ structures of $\mathcal{C}_m^{s=0}$ and of $\mathcal{C}_m^{s=1}$. We also take

$$R = \tilde{L}_1 \times_{X_1} \tilde{L}_{12} \times_{X_2} \tilde{L}_2. \quad (14.10)$$

We make a choice of $\Xi_{12,j}^{\text{quilt}}$ in Situation 14.5. It determines a filtered A_∞ tri-module structure on $CF(R; \Theta; \Lambda_0)$ over $\mathcal{C}_m^{s=0}$ or $\mathcal{C}_m^{s=1}$ for $j = 1, 2$.

Proposition 14.28. *There exists a pseudo-isotopy of filtered A_∞ tri-module on $CF([0, 1] \times R; \Theta; \Lambda_0)$ over $\mathcal{C}_m^{[0,1]}$ for $m = 1, 2, 3$.*

We may choose it so that the restriction to $s = 0, 1$ coincides with the tri-module structure induced by Choices $\Xi_{12,j}^{\text{quilt}}$ for $j = 1, 2$. \diamond

Proof. The proof of this proposition is mostly the same as the proof of Lemma 14.21 in Subsection 14.3. We first define the notion of a partial pseudo-isotopy of tri-module structures with energy cut level E . We then can show the existence of a partial pseudo-isotopy of tri-module structures with energy cut level E for any E . Then we proceed in the same way to define the notion of a partial pseudo-isotopy of pseudo-isotopies of tri-module structures and use it to work out the homotopy inductive limit construction. The way to modify the proof of Lemma 14.21 is thus a routine, which we omit. \square

Situation 14.29. Let $\mathbb{L}_1, \mathbb{L}_{12}, \mathbb{L}_2$ be as in Situation 6.1. We consider the (disjoint) union of all the elements of \mathbb{L}_1 (resp. $\mathbb{L}_{12}, \mathbb{L}_2$) and denote them by L_1, L_{12}, L_2 . We consider R as in (14.10). \diamond

We remark that since we are in Situation 6.1 the fiber product $\tilde{L}_2^0 = \tilde{L}_1 \times_{X_1} \tilde{L}_{12}$ is an open subset of L_2 . We put

$$R_0 = \tilde{L}_1 \times_{X_1} \tilde{L}_{12} \times_{X_2} \tilde{L}_2^0 \subseteq R. \quad (14.11)$$

We remark also

$$R_0 = \tilde{L}_2^0 \times_{X_2} \tilde{L}_2^0 \subseteq R_2. \quad (14.12)$$

We remark that the tri-module structure we used in Theorem 6.3 satisfies the following properties. If $h_2, h \in C^\infty(R_0, \Omega(R) \otimes \Theta)$ then

$$\mathfrak{n}_{0,0,1; \beta_0}(1, 1, h_2; h) = (-1)^{\deg h_2} h_2 \wedge h.$$

This fact is used during the proof of Proposition 6.12.

Lemma 14.30. *We can take the pseudo-isotopy in Proposition 14.28 such that the following holds in addition.*

If $h_2, h \in C^\infty([0, 1] \times R_0, \Omega(R) \otimes \Theta)$ then

$$\mathbf{n}_{0,0,1;\beta_0}^{[0,1]}(1, 1, h_2; h) = (-1)^{\deg h_2} h_2 \wedge h.$$

◇

Using the fact that the moduli space defining $\mathbf{n}_{0,0,1;\beta_0}^{[0,1]}$ on $[0, 1] \times R_0$ consists of constant maps, and has the required transversality and submersivity properties without perturbation, the proof of the lemma is similar to an argument during the proof of Proposition 6.12 and so is omitted.

14.4.3. *Completion of the proof of Theorem 14.6.* Now we are in the position to complete the proof of Theorem 14.6.

Suppose we are in Situation 14.29. We use the same trick as Subsection 3.4 to obtain a filtered A_∞ category from a filtered A_∞ algebra $\mathcal{C}_m^{[0,1]}$ ($m = 1, 2, 3$). Here $\mathcal{C}_m^{[0,1]}$ is obtained in Proposition 14.28. We denote them by $\mathfrak{Fukst}(X_1; \mathbb{L}_1)^{[0,1]}$, $\mathfrak{Fukst}(-X_1 \times X_2; \mathbb{L}_{12})^{[0,1]}$ and $\mathfrak{Fukst}(X_2; \mathbb{L}_2)^{[0,1]}$. The sets of their objects are the same as the sets of objects of $\mathfrak{Fukst}(X_1; \mathbb{L}_1)$, $\mathfrak{Fukst}(-X_1 \times X_2; \mathbb{L}_{12})$ and $\mathfrak{Fukst}(X_2; \mathbb{L}_2)$, respectively.

Hereafter we omit $\mathbb{L}_1, \mathbb{L}_{12}, \mathbb{L}_2$ from the notation for simplicity.

The pseudo-isotopy of tri-modules we produced in Proposition 14.28 induces a tri-module structure over the strict categories $\mathfrak{Fukst}(X_1)^{[0,1]}$, $\mathfrak{Fukst}(-X_1 \times X_2)^{[0,1]}$ and $\mathcal{FUNK}((\mathfrak{Fukst}(X_2)^{[0,1]}))$. It induces a strict filtered A_∞ bi-functor

$$\mathfrak{Fukst}(X_1)^{[0,1]} \times \mathfrak{Fukst}(-X_1 \times X_2)^{[0,1]} \rightarrow \mathcal{FUNK}((\mathfrak{Fukst}(X_2)^{[0,1]})^{\text{op}}, \mathcal{CH}). \quad (14.13)$$

We denote by $\mathcal{REP}(\mathfrak{Fukst}(X_2)^{[0,1]})$ the full subcategory of the filtered A_∞ category $\mathcal{FUNK}((\mathfrak{Fukst}(X_2)^{[0,1]})^{\text{op}}, \mathcal{CH})$ whose object is homotopy equivalent to the image of the Yoneda-functor

$$\mathfrak{Fukst}(X_2)^{[0,1]} \rightarrow \mathcal{FUNK}((\mathfrak{Fukst}(X_2)^{[0,1]})^{\text{op}}, \mathcal{CH}).$$

We define $\mathcal{REP}(\mathfrak{Fukst}(X_2))$ in the same way.

Lemma 14.30 implies that the image of the functor (14.13) lies in $\mathcal{REP}(\mathfrak{Fukst}(X_2)^{[0,1]})$. Thus we obtain the next diagram, which commutes up to homotopy equivalence.

$$\begin{array}{ccccc} \mathfrak{Fukst}(X_1; \Xi_{1,2}) & & & & \mathfrak{Fukst}(X_2; \Xi_{2,2}) \\ \times \mathfrak{Fukst}(-X_1 \times X_2; \Xi_{12,2}) & \xrightarrow{\mathcal{F}} & \mathcal{REP}(\mathfrak{Fukst}(X_2; \Xi_{2,2})) & \longleftarrow & \mathfrak{Fukst}(X_2; \Xi_{2,2}) \\ \text{Eval}_{s=1} \uparrow & & \downarrow \text{Eval}_{s=1}^* & & \uparrow \text{Eval}_{s=1} \\ \mathfrak{Fukst}(X_1)^{[0,1]} & & & & \mathfrak{Fukst}(X_2)^{[0,1]} \\ \times \mathfrak{Fukst}(-X_1 \times X_2)^{[0,1]} & \xrightarrow{\mathcal{F}} & \mathcal{REP}(\mathfrak{Fukst}(X_2)^{[0,1]}) & \longleftarrow & \mathfrak{Fukst}(X_2)^{[0,1]} \\ \text{Eval}_{s=0} \downarrow & & \uparrow \text{Eval}_{s=0}^* & & \downarrow \text{Eval}_{s=0} \\ \mathfrak{Fukst}(X_1; \Xi_{1,1}) & & & & \mathfrak{Fukst}(X_2; \Xi_{2,1}) \\ \times \mathfrak{Fukst}(-X_1 \times X_2; \Xi_{12,1}) & \xrightarrow{\mathcal{F}} & \mathcal{REP}(\mathfrak{Fukst}(X_2; \Xi_{2,1})) & \longleftarrow & \mathfrak{Fukst}(X_2; \Xi_{2,1}) \end{array}$$

All arrows in the diagram are homotopy equivalences except the three horizontal arrows in the left hand side, which are written as \mathcal{F} .

By definition the composition of the arrows of the first line is the filtered A_∞ functor $\mathcal{M}\mathcal{W}\mathcal{W}^{\Xi_{12,2}^{\text{quilt}}}$. The composition of the arrows of the third line is the filtered A_∞ functor $\mathcal{M}\mathcal{W}\mathcal{W}^{\Xi_{12,1}^{\text{quilt}}}$.

The composition of two arrows in the first column is the functor $\mathcal{G}^1 \times \mathcal{G}^{12}$. The composition of the two arrows in the third column is the functor \mathcal{G}^2 . Thus Theorem 14.6 follows from the commutativity of the diagram. \square

Note that we can prove the next theorem in the same way.

Theorem 14.31. *The composition functor \mathbf{Comp} in Theorem 8.5 is independent of the choices up to homotopy equivalence. \diamond*

We omit the proof.

14.5. Coincidence of A_∞ structures defined by the two compactifications.

Let \mathbb{L}_{12} be a clean collection of $\pi_1^*(TX_1 \oplus V_1) \oplus \pi_2^*(V_2)$ relatively spin immersed Lagrangian submanifolds of $-X_1 \times X_2$.

In Section 3 we used the stable map compactification $\mathcal{M}(L_{12}; \vec{a}; E)$ of the moduli space of pseudo-holomorphic disks to define a filtered A_∞ category the set of whose objects is \mathbb{L}_{12} . We denote it by $\mathfrak{F}\mathfrak{u}\mathfrak{k}(-X_1 \times X_2, \mathbb{L}_{12})$. In Section 12 we introduced a different compactification $\mathcal{M}'(L_{12}; \vec{a}; E)$. We use it also to define a filtered A_∞ category the set of whose objects is \mathbb{L}_{12} . We denote it by $\mathfrak{F}\mathfrak{u}\mathfrak{k}'(-X_1 \times X_2, \mathbb{L}_{12})$. In this subsection we prove the next:

Proposition 14.32. *$\mathfrak{F}\mathfrak{u}\mathfrak{k}(-X_1 \times X_2, \mathbb{L}_{12})$ is pseudo-isotopic to $\mathfrak{F}\mathfrak{u}\mathfrak{k}'(-X_1 \times X_2, \mathbb{L}_{12})$. \diamond*

Proof. By the same trick as Subsection 3.4, it suffices to consider the case when \mathbb{L}_{12} consists of a single immersed Lagrangian submanifold L_{12} and construct a pseudo-isotopy of filtered A_∞ algebras.

Lemma-Definition 14.33. *We can define the forgetful map*

$$\mathfrak{fg} : \mathcal{M}_\ell(L_{12}; \vec{a}; E) \rightarrow \mathcal{M}'_{\ell,0,0}(L_{12}; \vec{a}; E)$$

which is continuous. \diamond

Proof. Let $((\Sigma, \vec{z}, \vec{z}^{\text{int}}), u, \gamma)$ be an element of $\mathcal{M}_\ell(L_{12}; \vec{a}; E, \gamma)$. Here $(\Sigma, \vec{z}, \vec{z}^{\text{int}})$ is a bordered nodal marked curve of genus zero with one boundary component. (\vec{z} are boundary marked points and \vec{z}^{int} are interior marked points.) The map $u : (\Sigma, \partial\Sigma) \rightarrow (-X_1 \times X_2, L_{12})$ is pseudo-holomorphic and the map $\gamma : \partial\Sigma \setminus \vec{z} \rightarrow \tilde{L}_{12}$ is a lift of the restriction of u .

We put $(u_1, u_2) := u$, where u_i is a map to X_i from Σ . We consider $((\Sigma, \vec{z}, \vec{z}^{\text{int}}), u_i)$ for $i = 1, 2$ and shrink unstable sphere components. Here an unstable sphere component of $((\Sigma, \vec{z}, \vec{z}^{\text{int}}), u_i)$ is an unstable sphere component of the source curve $(\Sigma, \vec{z}, \vec{z}^{\text{int}})$ on which u_i is constant. We denote by $((\Sigma_i, \vec{z}_i, \vec{z}_i^{\text{int}}), u_i)$ the pair of a bordered marked curve and a map obtained by this shrinking.

Let $(\Sigma_i^0, \vec{z}_i, \vec{z}_i^{\text{int}})$ be the bordered marked curve obtained from $(\Sigma_i, \vec{z}_i, \vec{z}_i^{\text{int}})$ by shrinking all the unstable sphere components.

We remark that $(\Sigma_1^0, \vec{z}_1, \vec{z}_1^{\text{int}})$ is canonically isomorphic to $(\Sigma_2^0, \vec{z}_2, \vec{z}_2^{\text{int}})$. In fact they both are obtained by shrinking all the unstable sphere components of $(\Sigma, \vec{z}, \vec{z}^{\text{int}})$. Therefore we obtain a biholomorphic map

$$\mathcal{I} : (\Sigma_1^0, \vec{z}_1, \vec{z}_1^{\text{int}}) \rightarrow (\Sigma_2^0, \vec{z}_2, \vec{z}_2^{\text{int}}).$$

We define

$$\mathbf{fg}((\Sigma, \bar{z}, \bar{z}^{\text{int}}), u, \gamma) = (((\Sigma_1, \bar{z}_1, \bar{z}_1^{\text{int}}), u_1), ((\Sigma_2, \bar{z}_2, \bar{z}_2^{\text{int}}), \mathcal{A}, \gamma)). \quad (14.14)$$

Note that we regard the interior marked points \bar{z}^{int} as interior marked points of first kind in the sense of Definition 12.7.

The continuity of the map \mathbf{fg} is easy to show from the definition. \square

We consider the case when $\ell = 0$ to obtain a map

$$\mathbf{fg} : \mathcal{M}(L_{12}; \bar{a}; E) \rightarrow \mathcal{M}'(L_{12}; \bar{a}; E). \quad (14.15)$$

We start with a Kuranishi structure which we defined on $\mathcal{M}'(L_{12}; \bar{a}; E)$ and will pull it back to one on $\mathcal{M}(L_{12}; \bar{a}; E)$. We describe the detail of this pull back construction now.

Let $\tilde{\xi} \in \mathcal{M}(L_{12}; \bar{a}; E)$. We take $\hat{\xi} = ((\Sigma, \bar{z}, \bar{z}^{\text{int}}), u, \gamma) \in \mathcal{M}_\ell(L_{12}; \bar{a}; E)$ such that $\tilde{\xi} = [(\Sigma, \bar{z}), u, \gamma]$ and $(\Sigma, \bar{z}, \bar{z}^{\text{int}})$ is stable. We use it to define a notion that $((\Sigma', \bar{z}'), u', \gamma')$ is ϵ -close to $\hat{\xi}$ in a similar way as Definition 12.40 as follows.

Definition 14.34. Let $((\Sigma^\heartsuit, \bar{z}^\heartsuit), u^\heartsuit, \gamma^\heartsuit)$ be an object which has the same properties as an element of $\mathcal{M}(L_{12}; \bar{a}; E)$ except we do not require u^\heartsuit to be pseudo-holomorphic. We call such an object a *candidate of an element of the extended moduli space of $\mathcal{M}(L_{12}; \bar{a}; E)$* . \diamond

Definition 14.35. We say $((\Sigma^\heartsuit, \bar{z}^\heartsuit), u^\heartsuit, \gamma^\heartsuit)$ is ϵ -close to $(\tilde{\xi}, \hat{\xi})$ if there exists $\bar{z}^{\text{int}, \heartsuit}$ with the following properties.

- (1) $(\Sigma^\heartsuit, \bar{z}^\heartsuit, \bar{z}^{\text{int}, \heartsuit})$ is ϵ -close to $(\Sigma, \bar{z}, \bar{z}^{\text{int}})$ in the moduli space of marked stable disks.⁶⁰
- (2) We define the *core* K_a^s and K_a^d in the same way as (12.19). Here a is an index of the irreducible component of Σ . K_a^s lies in a sphere component and K_a^d lies in a disk component.

Then we obtain smooth embeddings

$$\mathcal{I}_\heartsuit^d : K_a^d \rightarrow \Sigma^\heartsuit, \quad \mathcal{I}_\heartsuit^s : K_a^s \rightarrow \Sigma^\heartsuit,$$

in the same way as (12.40) and Definition 12.30. (We use analytic family of coordinates at the nodal points of Σ and also a trivialization of the universal family of marked stable disks on the ϵ neighborhood of $(\Sigma, \bar{z}, \bar{z}^{\text{int}})$ to define them. See [FOOO9, Section 18], [FOOO10, Section 3] etc.)

We now require

- (a) The restriction of u to each K_a^d , is ϵ close to $u^\heartsuit \circ \mathcal{I}_\heartsuit^d$ in C^2 norm.
- (b) The restriction of u to each K_a^s is ϵ close to $u^\heartsuit \circ \mathcal{I}_\heartsuit^s$ in C^2 norm.

We remark that these conditions are similar to Definition 12.40 (3),(4) respectively.

- (3) For any connected component \mathcal{S} of

$$\Sigma^\heartsuit \setminus \bigcup_a \mathcal{I}_\heartsuit^d(K_a^d) \setminus \bigcup_a \mathcal{I}_\heartsuit^s(K_a^s)$$

we require

$$\text{Diam } u^\heartsuit(\mathcal{S}) < \epsilon. \quad (14.16)$$

⁶⁰We take and fix a metric of the moduli space of marked stable disks to define this ϵ -close-ness.

(In other words, we require the diameters of the images by u_i^\heartsuit of the neck regions are smaller than ϵ .) We remark that these conditions are similar to Definition 12.40 (6).

◇

Lemma 14.36. *Let $\hat{\xi}' = ((\Sigma, \bar{z}, \bar{z}^{\text{int},'}) , u, \gamma) \in \mathcal{M}_{\ell'}(L_{12}; \bar{a}; E)$ such that $\tilde{\xi} = [(\Sigma, \bar{z}), u, \gamma]$ and $(\Sigma, \bar{z}, \bar{z}^{\text{int},'})$ is stable.*

Then for each ϵ there exists δ with the following properties.

If $((\Sigma^\heartsuit, \bar{z}^\heartsuit), u^\heartsuit, \gamma^\heartsuit)$ is δ -close to $(\hat{\xi}', \tilde{\xi})$ then $((\Sigma^\heartsuit, \bar{z}^\heartsuit), u^\heartsuit, \gamma^\heartsuit)$ is ϵ -close to $(\hat{\xi}, \tilde{\xi})$. ◇

The proof of Lemma 14.36 and the next Lemma 14.37 are similar, for example, to the proof of [Fu12, Lemma 7.26]. So we omit it.

Let $\tilde{\eta} = ((\Sigma^\heartsuit, \bar{z}^\heartsuit), u^\heartsuit, \gamma^\heartsuit)$ be a candidate of an element of $\mathcal{M}(L_{12}; \bar{a}; E)$. We define $\eta = \mathbf{fg}(\tilde{\eta})$, which is a candidate of an element of $\mathcal{M}'(L_{12}; \bar{a}; E)$ in the sense of Definition 12.39 in the same way as Lemma-Definition 14.33.

Lemma 14.37. *Let $\tilde{\xi} \in \mathcal{M}(L_{12}; \bar{a}; E)$ and $\hat{\xi} \in \mathcal{M}_\ell(L_{12}; \bar{a}; E)$ as in Definition 14.35.*

We fix a stabilization data $\mathcal{S}\mathcal{T}$ (Definition 12.26) for $\xi = \mathbf{fg}(\tilde{\xi}) \in \mathcal{M}(L_{12}; \bar{a}; E)$.

Then for each $\epsilon > 0$ there exists $\delta > 0$ with the following properties. If η is δ -close to $(\tilde{\xi}, \hat{\xi})$ in the sense of Definition 14.35 then $\eta = \mathbf{fg}(\tilde{\eta})$ is ϵ -close to $(\xi, \mathcal{S}\mathcal{T})$ in the sense of Definition 12.41. ◇

Now we will describe the process to pull back Kuranishi structure on $\mathcal{M}'(L_{12}; \bar{a}; E)$ to one on $\mathcal{M}(L_{12}; \bar{a}; E)$. Let $\xi = \mathbf{fg}(\tilde{\xi}) \in \mathcal{M}'(L_{12}; \bar{a}; E)$. We take an obstruction bundle data $\mathcal{O}\mathcal{B}$ at ξ in the sense of Definition 12.35.

Let $\tilde{\eta}$ be a candidate of an element of $\mathcal{M}(L_{12}; \bar{a}; E)$ which is ϵ -close to $(\tilde{\xi}, \hat{\xi})$. (Here we fix $\hat{\xi}$. Lemma 14.36 shows that the Kuranishi chart we obtain below is independent of this choice in a neighborhood of the origin.)

We put $\tilde{\eta} = ((\Sigma^\heartsuit, \bar{z}^\heartsuit), u^\heartsuit, \gamma^\heartsuit)$ and

$$\eta = \mathbf{fg}(\tilde{\eta}) = (((\Sigma_1^\heartsuit, \bar{z}_1^\heartsuit), u_1^\heartsuit), ((\Sigma_2^\heartsuit, \bar{z}_2^\heartsuit), u_2^\heartsuit), \mathcal{S}^\heartsuit, \gamma^\heartsuit).$$

By Definition 12.40, we have a finite dimensional linear subspace $\mathcal{E}(\xi, \mathcal{O}\mathcal{B}; \eta)$ of

$$\begin{aligned} & \bigoplus_{\mathfrak{a}^\heartsuit} C_0^\infty(\Sigma_{\mathfrak{a}^\heartsuit}^{\text{d}, \heartsuit}; (u_1^\heartsuit, u_2^\heartsuit)^* T(-X_1 \times X_2) \otimes \Lambda^{0,1}) \\ & \oplus \bigoplus_{i=1,2} \bigoplus_{\mathfrak{a}^\heartsuit} C_0^\infty(\Sigma_{i, \mathfrak{a}^\heartsuit}^{\text{s}, \heartsuit}; (u_i^\heartsuit)^* T(X_i) \otimes \Lambda^{0,1}). \end{aligned} \quad (14.17)$$

We observe that there exists a map $\mathcal{J}_i^\heartsuit : \Sigma^\heartsuit \rightarrow \Sigma_i^\heartsuit$ which is either bi-holomorphic or a constant map, on each irreducible component. We can pull back the subspace $\mathcal{E}(\xi, \mathcal{O}\mathcal{B}; \eta)$ by $\mathcal{J}_1^\heartsuit, \mathcal{J}_2^\heartsuit$ and obtain a finite dimensional linear subspace of

$$\bigoplus_{\mathfrak{a}} C_0^\infty(\Sigma_{\mathfrak{a}}^\heartsuit; (u_{\mathfrak{a}}^\heartsuit)^* T(-X_1 \times X_2) \otimes \Lambda^{0,1}). \quad (14.18)$$

Here the index \mathfrak{a} runs in the set of irreducible components of Σ^\heartsuit and $\Sigma_{\mathfrak{a}}^\heartsuit$ is the irreducible component corresponding to \mathfrak{a} . We denote this subset by $\mathcal{E}(\xi, \mathcal{O}\mathcal{B}; \tilde{\eta})$. (Note that this subspace depends only on $\xi, \tilde{\eta}$ but is independent of the lift $\tilde{\xi}$. This is because $\mathcal{E}(\xi, \mathcal{O}\mathcal{B}; \eta)$ is zero on the part where we shrink Σ to define \mathbf{fg} .)

While we defined a Kuranishi structure on $\mathcal{M}'(L_{12}; \vec{a}; E)$ we made choices of a finite set $\{\xi_i \mid i \in \mathbf{I}\} \subset \mathcal{M}'(L_{12}; \vec{a}; E)$ (12.47) and a closed set $\mathfrak{N}(\xi_i) \subset \mathcal{M}'(L_{12}; \vec{a}; E)$ satisfying (12.48). We defined a subset $\mathbf{I}(\xi)$ in (12.49). We use them to define a Kuranishi chart at $\tilde{\xi} \in \mathcal{M}(L_{12}; \vec{a}; E)$ in the same way as Definition 12.43 as follows:

Definition 14.38. We fix $\hat{\xi}$ and take a sufficiently small positive number ϵ and define $U(\tilde{\xi}; \epsilon)$ to be the isomorphism classes of $\tilde{\eta} = ((\Sigma^\heartsuit, \vec{z}^\heartsuit), u^\heartsuit, \gamma^\heartsuit)$ with the following properties.

- (1) $\tilde{\eta}$ is a candidate of an element of extended moduli space $\mathcal{M}(L_{12}; \vec{a}; E)$.
- (2) η is ϵ close to $(\tilde{\xi}, \hat{\xi})$.
- (3)

$$\bar{\partial}u^\heartsuit \in \bigoplus_{i \in \mathbf{I}(\tilde{\xi})} \mathcal{E}(\xi_i, \mathcal{O}\mathcal{B}; \tilde{\eta}). \tag{14.19}$$

Let $\Gamma_{\tilde{\xi}}$ be the set of all automorphisms of $\tilde{\xi}$. It acts on $U(\tilde{\xi}; \epsilon)$ and the quotient space is an orbifold $V(\tilde{\xi}; \epsilon)$. \diamond

We can define $\mathcal{E}(\tilde{\xi})$ (an orbundle on $V(\tilde{\xi}; \epsilon)$), its section $s_{\tilde{\xi}}$, and a map $\psi_{\tilde{\xi}} : s_{\tilde{\xi}}^{-1}(0) \rightarrow \mathcal{M}(L_{12}; \vec{a}; E)$ which is a homeomorphism onto an open neighborhood of $\tilde{\xi}$. We can show that $(V(\tilde{\xi}; \epsilon), \mathcal{E}(\tilde{\xi}), s_{\tilde{\xi}}, \psi_{\tilde{\xi}})$ is a Kuranishi chart at $\tilde{\xi}$ of $\mathcal{M}(L_{12}; \vec{a}; E)$ in the same way as the proof of Proposition 12.44. We thus defined a Kuranishi structure on $\mathcal{M}(L_{12}; \vec{a}; E)$. We call it the induced Kuranishi structure.

Lemma 14.39. *For a given system of CF-perturbations on $\mathcal{M}'(L_{12}; \vec{a}; E)$, which induces a filtered A_∞ algebra structure \mathfrak{m}'_k on $CF(L_{12}, \Lambda_0)$, we can define a system of CF-perturbations on the induced Kuranishi structures of $\mathcal{M}(L_{12}; \vec{a}; E)$, so that the filtered A_∞ algebra structure \mathfrak{m}''_k induced by it on $CF(L_{12}, \Lambda_0)$ is exactly the same as \mathfrak{m}'_k .* \diamond

Proof. There exists a group homomorphism $\Gamma_{\tilde{\xi}} \rightarrow \Gamma_\xi$ and an equivariant map $U(\tilde{\xi}; \epsilon) \rightarrow U(\xi; \epsilon)$. Moreover there exists $\mathcal{E}(\tilde{\xi}) \rightarrow \mathcal{E}(\xi)$ which can be identified with an equivariant bundle map which covers $U(\tilde{\xi}; \epsilon) \rightarrow U(\xi; \epsilon)$. Thus the given CF-perturbation on $\mathcal{M}'(L_{12}; \vec{a}; E)$ can be lifted to a CF-perturbation on the induced Kuranishi structure. Since evaluation maps are compatible with $U(\tilde{\xi}; \epsilon) \rightarrow U(\xi; \epsilon)$, and this map is an isomorphism outside a set of codimension 2, the operations \mathfrak{m}'_k obtained by the CF-perturbation is the same as the operations \mathfrak{m}''_k obtained by the pull-backed CF-perturbation. The lemma follows. \square

Now we have two systems of Kuranishi structures and its CF-perturbations. One (the induced Kuranishi structures and its induced CF-perturbations) gives $\mathfrak{m}'_k = \mathfrak{m}''_k$. The other gives \mathfrak{m}_k . In other words, \mathfrak{m}_k is obtained from the Kuranishi structures and the CF-perturbations, which we described in Section 3. We can find a system of Kuranishi structures of $\mathcal{M}(L_{12}; \vec{a}; E) \times [0, 1]$ and their CF-perturbations which interpolates the two systems of Kuranishi structures and CF-perturbations, in the same way as Propositions 14.16 and 14.17. We use it in the same way as Lemma 14.19 to obtain the required pseudo-isotopy. (We need to use a pseudo-isotopy of pseudo-isotopies to take homotopy inductive limit. This step again is the same as Subsection 14.2 and so is omitted.) The proof of Proposition 14.32 is complete. \square

15. INDEPENDENCE OF THE FILTERED A_∞ FUNCTORS OF THE HAMILTONIAN ISOTOPY

15.1. Algebraic preliminary. In this section we prove that if (L_1, b_1) is Hamiltonian equivalent to (L'_1, b'_1) and (L_{12}, b_{12}) is Hamiltonian equivalent to (L'_{12}, b'_{12}) then $\mathcal{W}_{(L_{12}, b_{12})}(L_1, b_1)$ is homotopy equivalent to $\mathcal{W}_{(L'_{12}, b'_{12})}(L'_1, b'_1)$ in the category $\mathfrak{Fust}(X_2)$ over Λ coefficient.

To state and prove this result we start with an algebraic preliminary. Let \mathcal{C} be a filtered A_∞ category. We consider its associated strict category \mathcal{C}^s .

Definition 15.1. We define an A_∞ category \mathcal{C}^Λ as follows.

- (1) $\mathfrak{OB}(\mathcal{C}^\Lambda) = \mathfrak{OB}(\mathcal{C}^s)$.
- (2) For $(c_1, b_1), (c_2, b_2) \in \mathfrak{OB}(\mathcal{C}^\Lambda) = \mathfrak{OB}(\mathcal{C}^s)$ we put

$$\mathcal{C}^\Lambda((c_1, b_1), (c_2, b_2)) = \mathcal{C}^s((c_1, b_1), (c_2, b_2)) \otimes_{\Lambda_0} \Lambda.$$
- (3) The structure operations of \mathcal{C}^Λ is obtained by extending the structure operations of \mathcal{C}^s by Λ linearity.⁶¹

◇

Definition 15.2. In the situation of Definition 15.1, let $(c_1, b_1), (c_2, b_2) \in \mathfrak{OB}(\mathcal{C}^\Lambda) = \mathfrak{OB}(\mathcal{C}^s)$. We assume \mathcal{C} is unital.

We say (c_1, b_1) is *homotopy equivalent to* (c_2, b_2) over Λ and write $(c_1, b_1) \sim_\Lambda (c_2, b_2)$ if they are homotopy equivalent as objects of \mathcal{C}^Λ .

Suppose $(c_1, b_1) \sim_\Lambda (c_2, b_2)$. We define the *Hofer distance* $d_{\text{Hof}}((c_1, b_1), (c_2, b_2))$ between them as the infimum of the positive numbers ϵ such that the following holds.

- (1) There exists $x_{12} \in \mathcal{C}^\Lambda((c_1, b_1), (c_2, b_2))$, $x_{21} \in \mathcal{C}^\Lambda((c_2, b_2), (c_1, b_1))$, $y_1 \in \mathcal{C}^\Lambda((c_1, b_1), (c_1, b_1))$, $y_2 \in \mathcal{C}^\Lambda((c_2, b_2), (c_2, b_2))$, such that
 - (a) $\mathfrak{m}_2(x_{21}, x_{12}) = \mathfrak{e}_{c_2} + \mathfrak{m}_1(y_2)$.
 - (b) $\mathfrak{m}_2(x_{12}, x_{21}) = \mathfrak{e}_{c_1} + \mathfrak{m}_1(y_1)$.
 - (c) $\mathfrak{m}_1(x_{21}) = 0$. $\mathfrak{m}_1(x_{12}) = 0$.
- (2) We require $T^{\epsilon_1} x_{21} \in \mathcal{C}^s((c_1, b_1), (c_2, b_2))$, $T^{\epsilon_2} x_{12} \in \mathcal{C}^s((c_2, b_2), (c_1, b_1))$ where ϵ_1, ϵ_2 are positive numbers with $\epsilon_1 + \epsilon_2 \leq \epsilon$. We also require $T^\epsilon y_1 \in \mathcal{C}^s((c_1, b_1), (c_1, b_1))$, $T^\epsilon y_2 \in \mathcal{C}^s((c_2, b_2), (c_2, b_2))$.

◇

It is easy to see that \sim_Λ is an equivalence relation. It is also easy to see that

$$d_{\text{Hof}}((c_1, b_1), (c_2, b_2)) + d_{\text{Hof}}((c_2, b_2), (c_3, b_3)) \geq d_{\text{Hof}}((c_1, b_1), (c_3, b_3)). \quad (15.1)$$

We also remark that if (c_1, b_1) is homotopy equivalent to (c_2, b_2) as objects of \mathcal{C}^s then $d_{\text{Hof}}((c_1, b_1), (c_2, b_2)) = 0$.

The next lemma is also easy to show.

Lemma 15.3. *Let $\mathcal{F} : \mathcal{C}_1 \rightarrow \mathcal{C}_2$ be a strict and unital homotopy equivalence of filtered A_∞ categories. Then the following holds for $c_1, c_2 \in \mathfrak{OB}(\mathcal{C}_1)$.*

- (1) $c_1 \sim_\Lambda c_2$ if and only if $\mathcal{F}(c_1) \sim_\Lambda \mathcal{F}(c_2)$.
- (2)

$$d_{\text{Hof}}(c_1, c_2) = d_{\text{Hof}}(\mathcal{F}(c_1), \mathcal{F}(c_2)).$$

◇

⁶¹We remark that structure operations of \mathcal{C}^s are Λ_0 linear.

15.2. Homotopy equivalence over Λ in the geometric situation.

Situation 15.4. Let (X, ω) be a symplectic manifold which is compact or tame and V a background datum.

Suppose that a map $\Phi : X \rightarrow X$ is a Hamiltonian diffeomorphism generated by a compactly supported time dependent Hamiltonian $H : X \times [0, 1] \rightarrow \mathbb{R}$.

We take a finite set \mathbb{L} of V -relatively spin compact Lagrangian submanifolds of X . We assume that it is a clean collection.

We assume $L \in \mathbb{L}$ and $\Phi(L) \in \mathbb{L}$. \diamond

Theorem 15.5. *In Situation 15.4, let $b \in CF(L)$ be a bounding cochain.*

- (1) *There exists a bounding cochain $\Phi_*(b) \in CF(\Phi(L))$.*
- (2) *(L, b) is equivalent to $(\Phi(L), \Phi_*(b))$ over Λ . (Note that they are objects of $\mathfrak{Fukst}(X, \mathbb{L})$.)*
- (3) *The Hofer distance between (L, b) and $(\Phi(L), \Phi_*(b))$ is not greater than the Hofer distance $[\text{Ho}]$ between Φ and the identity map.*

\diamond

Theorem 15.5 (1) is a slightly stronger version of [FOOO1, Theorem G (G4)]. Theorem 15.5 (2) is a slightly stronger version of [FOOO1, Theorem 6.1.25]. (See also [FOOO5]). We explain how Theorem 15.5 follows from the argument of the above quoted papers [FOOO1, FOOO5] in Subsection 15.5.

We also remark the following:

Proposition 15.6. *If $(L, b), (L', b') \in \mathfrak{DB}(\mathfrak{Fukst}(X; \mathbb{L}))$ and $L \neq L'$ then*

$$d_{\text{Hof}}((L, b), (L', b')) > 0.$$

\diamond

Proof. Let L be a relatively spin (immersed) Lagrangian submanifold of (X, ω) . In [FOOO1, Definition 6.5.42], we defined the notion of a bounding cochain modulo T^E as an element b of $CF(L; \Lambda_+)$ such that

$$\sum_{k=0}^{\infty} \mathfrak{m}_k(b, \dots, b) \equiv 0 \pmod{T^E}.$$

When $(L_1, b_1), (L_2, b_2)$ are pairs of Lagrangian submanifolds with bounding cochains modulo T^E , we can define Floer homology over Λ_0/T^E as follows. (See [FOOO1, Definition 6.5.45].) Let $CF(L_1, L_2)$ be the left $CF(L_1; \Lambda_0)$ and right $CF(L_2; \Lambda_0)$ bi-module, which is nothing but the morphism space from (L_1, b_1) to (L_2, b_2) in the curved A_∞ category of X . Let

$$\mathfrak{n}_{k_1, k_2} : B_{k_1}CF(L_1)[1] \otimes CF(L_1, L_2) \otimes B_{k_2}CF(L_2)[1] \rightarrow CF(L_2; \Lambda_0)$$

be the structure operations. We put

$$\delta_{b_1, b_2}(x) = \sum_{k_1, k_2=0}^{\infty} \mathfrak{n}_{k_1, k_2}(b_1^{k_1}, x, b_2^{k_2}).$$

The A_∞ relations imply $\delta_{b_1, b_2} \circ \delta_{b_1, b_2} \equiv 0 \pmod{T^E}$. Therefore δ_{b_1, b_2} becomes a boundary operator on $CF(L_1, L_2) \otimes_{\Lambda_0} \Lambda_0/T^E$. Its cohomology is by definition $HF((L_1, b_1), (L_2, b_2); \Lambda_0/T^E)$. It is independent of the choices of perturbations and almost complex structures.

Lemma 15.7. *Let $(L_1, b_1), (L_2, b_2)$ be objects of $\mathfrak{Futst}(X, \mathbb{L})$ and (L, b) a pair of an element of \mathbb{L} and its bounding cochain modulo T^E . Suppose $d_{\text{Hof}}((L_1, b_1), (L_2, b_2)) = 0$. Then*

$$HF((L_1, b_1), (L, b); \Lambda_0/T^E) \cong HF((L_2, b_2), (L, b); \Lambda_0/T^E).$$

◇

Proof. By perturbing a bit and using [FOOO1, Theorem 6.5.47] we may assume that L_1 and L_2 are transversal to L . Then, for an arbitrary small ϵ , there exist $x_{12} \in CF(L_1, L_2; \Lambda)$ and $x_{21} \in CF(L_2, L_1; \Lambda)$ as in Definition 15.2. Multiplications with $T^\epsilon x_{12}$ and with $T^\epsilon x_{21}$ define chain maps

$$\begin{aligned} \varphi_{12} &: CF(L_1, L) \otimes_{\Lambda_0} \Lambda_0/T^{E'} \rightarrow CF(L_2, L) \otimes_{\Lambda_0} \Lambda_0/T^{E'}, \\ \varphi_{21} &: CF(L_2, L) \otimes_{\Lambda_0} \Lambda_0/T^{E'} \rightarrow CF(L_1, L) \otimes_{\Lambda_0} \Lambda_0/T^{E'}, \end{aligned}$$

for any $E' \leq E$. Moreover using Definition 15.2 (2) we can show that

$$\begin{aligned} \varphi_{12} \circ \varphi_{21} &: CF(L_1, L) \otimes_{\Lambda_0} \Lambda_0/T^E \rightarrow CF(L_1, L) \otimes_{\Lambda_0} \Lambda_0/T^E \\ \varphi_{21} \circ \varphi_{12} &: CF(L_2, L) \otimes_{\Lambda_0} \Lambda_0/T^E \rightarrow CF(L_2, L) \otimes_{\Lambda_0} \Lambda_0/T^E \end{aligned}$$

are chain homotopic to $T^{2\epsilon}$ times the identity map. We write

$$HF((L_i, b_i), (L, b); \Lambda_0/T^E) = \sum_{j=1}^{N_i} \Lambda_0/T^{a_{i,j}}$$

where $a_{i,j} \leq E$ and $a_{i,j} > a_{i,j+1}$. Then using $\varphi_{12}, \varphi_{21}$ and their properties explained above, we have the following: if $a_{1,j} > 4\epsilon$, we have $|a_{1,j} - a_{2,j}| \leq 2\epsilon$. (See [FOOO1, pp 391-392].) Since ϵ is arbitrary small we obtain the lemma by taking the limit $\epsilon \rightarrow 0$. □

Now we are in the position to prove Proposition 15.6. Suppose $L \neq L'$. We may assume that there exists $p \in L \setminus L'$. Let $d = d(p, L')$. Let ρ be a positive number sufficiently small compared to d . We can take a small Clifford type torus T_ρ such that $T_\rho \cap L' = \emptyset$, $T_\rho \cap L \neq \emptyset$ and T_ρ intersects transversally with L . We may also assume that T_ρ admits a bounding cochain b_ρ modulo T^ρ . Since $T_\rho \cap L' = \emptyset$,

$$HF((L', b'), (T_\rho, b_\rho); \Lambda_0/T^\rho) = 0.$$

On the other hand, using the fact $T_\rho \cap L \neq \emptyset$ and all the non-constant holomorphic strips have positive energy we can show

$$HF((L, b), (T_\rho, b_\rho); \Lambda_0/T^\rho) \neq 0.$$

(This is a classical fact going back to Chekanov [Che1].) This contradicts Lemma 15.7. □

15.3. The main theorem.

Situation 15.8. Let $X_1, V_1, \mathbb{L}_1, \Phi_1, L_1$ be as in Situation 15.4.

Let (X_2, ω_2) be a compact symplectic manifold and V_2 a background datum.

Let $-X_1 \times X_2, \pi_1^*(V_1 \oplus TX_1) \oplus \pi_2^*(V_2), \mathbb{L}_{12}, L_{12}, \Phi_{12}$ be also as in Situation 15.4.

Let \mathbb{L}_2 be a finite set of V_2 -relatively spin compact Lagrangian submanifolds of X_2 . We assume that it is a clean collection.

We assume also that for any $L'_1 \in \mathbb{L}_1$ and $L'_{12} \in \mathbb{L}_{12}$ the geometric transformation of L'_1 by L'_{12} is contained in \mathbb{L}_2 . ◇

Theorem 15.9. *In Situation 15.8, let b_1 be a bounding cochain of L_1 and b_{12} a bounding cochain of L_{12} . Then:*

- (1) $\mathcal{W}_{(L_{12}, b_{12})}(L_1, b_1)$ is equivalent to $\mathcal{W}_{(\Phi_{12}L_{12}, (\Phi_{12})_*b_{12})}(\Phi_1(L_1), (\Phi_1)_*(b_1))$ over Λ .
- (2) The Hofer distance

$$d_{\text{Hof}}(\mathcal{W}_{(L_{12}, b_{12})}(L_1, b_1), \mathcal{W}_{(\Phi_{12}L_{12}, (\Phi_{12})_*b_{12})}(\Phi_1(L_1), (\Phi_1)_*(b_1)))$$

is not greater than the sum of the Hofer distance [Ho] between Φ_1 and the identity map and the Hofer distance between Φ_{12} and the identity map.

◇

The proof is given in the next subsection.

The next result is a more functorial version of Theorem 15.9.

Situation 15.10. Let (X_i, ω_i) be a compact symplectic manifold, V_i a background datum of X_i , and \mathbb{L}_i a finite set of V_i relatively spin immersed Lagrangian submanifolds, for $i = 1, 2$. We assume \mathbb{L}_i are clean collections.

Let L_{12} be a $\pi_1^*(V_1 \oplus TX_1) \oplus \pi_2^*(V_2)$ relatively spin Lagrangian submanifold of $-X_1 \times X_2$ and $\Phi : -X_1 \times X_2 \rightarrow -X_1 \times X_2$ a Hamiltonian diffeomorphism.

We assume that for each $L_1 \in \mathbb{L}_1$ the geometric transformations

$$L_1 \times_{X_1} L_{12}, \quad L_1 \times_{X_1} \Phi(L_{12})$$

are both elements of \mathbb{L}_2 .

We assume that L_{12} is unobstructed and b_{12} is its bounding cochain. By Theorem 15.5 we obtain a bounding cochain $\Phi_*(b_{12})$ of $\Phi(L_{12})$.◇

Theorem 15.11. *In Situation 15.10 we consider two filtered A_∞ functors*

$$\begin{aligned} \mathcal{W}_{(L_{12}, b_{12})} &: \mathfrak{Fukst}(X_1; \mathbb{L}_1) \rightarrow \mathfrak{Fukst}(X_2; \mathbb{L}_2), \\ \mathcal{W}_{(\Phi(L_{12}), \Phi_*(b_{12}))} &: \mathfrak{Fukst}(X_1; \mathbb{L}_1) \rightarrow \mathfrak{Fukst}(X_2; \mathbb{L}_2). \end{aligned}$$

They induce the following filtered A_∞ functors of Λ linear categories in an obvious way:

$$\begin{aligned} \mathcal{W}_{(L_{12}, b_{12})}^\Lambda &: \mathfrak{Fukst}(X_1; \mathbb{L}_1)^\Lambda \rightarrow \mathfrak{Fukst}(X_2; \mathbb{L}_2)^\Lambda, \\ \mathcal{W}_{(\Phi(L_{12}), \Phi_*(b_{12}))}^\Lambda &: \mathfrak{Fukst}(X_1; \mathbb{L}_1)^\Lambda \rightarrow \mathfrak{Fukst}(X_2; \mathbb{L}_2)^\Lambda. \end{aligned}$$

- (1) $\mathcal{W}_{(L_{12}, b_{12})}^\Lambda$ is homotopy equivalent to $\mathcal{W}_{(\Phi(L_{12}), \Phi_*(b_{12}))}^\Lambda$.
- (2) The Hofer distance between $\mathcal{W}_{(L_{12}, b_{12})}$ and $\mathcal{W}_{(\Phi(L_{12}), \Phi_*(b_{12}))}$ in the filtered A_∞ category $\mathcal{FUNC}(\mathfrak{Fukst}(X_1; \mathbb{L}_1), \mathfrak{Fukst}(X_2; \mathbb{L}_2))$ is not greater than the Hofer distance between Φ and the identity map.

◇

The proof is given in the next subsection.

Remark 15.12.

- (1) The two immersed Lagrangian submanifolds $L_1 \times_{X_1} L_{12}$ and $L_1 \times_{X_1} \Phi(L_{12})$ may not be isotopic each other in general. So Theorem 15.11 provides a lot of examples of a pair of Lagrangian submanifolds which are not isotopic but are Floer theoretically equivalent.
- (2) K. Ono [Ono] studied a Lagrangian intersection between L and L' where the lifts of L and L' to the prequantum bundle are Hamiltonian isotopic each other. Theorem 15.11 is related to his study.

- (3) We recall that two Lagrangian submanifolds $L, L' \in X$ are said to be Lagrangian cobordant if there exists a Lagrangian submanifold \tilde{L} in $\mathbb{C} \times X$ and a sufficiently large ball $D(R)$ of \mathbb{C} centered at 0 such that

$$\tilde{L} \cap ((\mathbb{C} \setminus D(R)) \times X) = (((-\infty, 0) \times L) \cup ((0, \infty) \times L')) \cap ((\mathbb{C} \setminus D(R)) \times X).$$

We can show $L_1 \times_{X_1} L_{12}$ is Lagrangian cobordant to $L_1 \times_{X_1} \Phi(L_{12})$ in this sense.

- (4) In the situation of item (3), assuming L, L', \tilde{L} are monotone and $L'' \subset X$ is also monotone Biran-Cornea [BC] proved

$$HF(L, L'') \cong HF(L', L'').$$

It seems likely that we can generalize it as follows. Suppose L, L' have bounding cochains b, b' respectively. Moreover we assume that there exists a bounding cochain \tilde{b} of \tilde{L} such that on $((\mathbb{C} \setminus D(R)) \times X)$ it coincides with the pull backs of b and b' . Then

$$HF((L, b), (L'', b''); \Lambda) \cong HF((L', b'), (L'', b''); \Lambda).$$

We say (L, b) is unobstructed-Lagrangian cobordant to (L', b') in this situation.

We can then try to use the argument of the proof of Theorem 6.3 to prove the following. Let $(L_1, b_1), (L_{12}, b_{12})$ be objects of $\mathfrak{Futst}(X_1; \mathbb{L}_1), \mathfrak{Futst}(X_1; \mathbb{L}_1), \mathfrak{Futst}((X_1, \omega_1), \mathbb{L}_1) \times \mathfrak{Futst}((X_1 \times X_2, -\pi_1^*(\omega_1) + \pi_2^*(\omega_2)), \mathbb{L}_{12})$ respectively. Let $\Phi : -X_1 \times X_2 \rightarrow -X_1 \times X_2$ be a Hamiltonian diffeomorphism and $(\Phi(L_{12}), \Phi_*(b_{12}))$ be also an object of $\mathfrak{Futst}((X_1 \times X_2, -\pi_1^*(\omega_1) + \pi_2^*(\omega_2)), \mathbb{L}_{12})$.

We put $L_2 = L_1 \times_{X_1} L_{12}$ and $L'_2 = L_1 \times_{X_1} \Phi(L_{12})$. We obtain their bounding cochains by Theorem 6.3, which we denote by b_2, b'_2 . Then (L_2, b_2) is unobstructed-Lagrangian cobordant to (L'_2, b'_2) .

This argument can be an alternative proof of Theorem 15.11 (1).

- (5) Cornea-Shelukhin [CS] study the area of the image $\pi(\tilde{L})$ of the Lagrangian cobordism \tilde{L} by the projection $\pi : \mathbb{C} \times X \rightarrow \mathbb{C}$. Including the bounding cochain their argument may imply that if (L, b) is unobstructed-Lagrangian cobordant to (L', b') by a pair (\tilde{L}, \tilde{b}) , then the Hofer distance (in the sense of Definition 15.2) is not greater than the area of $\pi(\tilde{L})$.

This statement is related to Theorem 15.11 (2).

◇

15.4. Proof of the main theorem. Theorem 15.9 is an immediate consequence of Theorem 15.5 and the following purely algebraic result.

Proposition 15.13. *Let $\mathcal{C}_1, \mathcal{C}_2, \mathcal{C}_3$ be strict and unital filtered A_∞ categories and*

$$\mathcal{F} : \mathcal{C}_1 \times \mathcal{C}_2 \rightarrow \mathcal{C}_3$$

a strict and unital filtered A_∞ bi-functor.

Suppose $c_1, c'_1 \in \mathfrak{DB}(\mathcal{C}_1), c_2, c'_2 \in \mathfrak{DB}(\mathcal{C}_2)$.

- (1) *If $c_1 \sim_\Lambda c'_1, c_2 \sim_\Lambda c'_2$ then*

$$\mathcal{F}(c_1, c_2) \sim_\Lambda \mathcal{F}(c'_1, c'_2).$$

- (2)

$$d_{\text{Hof}}(\mathcal{F}(c_1, c_2), \mathcal{F}(c'_1, c'_2)) \leq d_{\text{Hof}}(c_1, c'_1) + d_{\text{Hof}}(c_2, c'_2).$$

◇

Proof. By (15.1) it suffices to show the case $c_1 = c'_1$ and the case $c_2 = c'_2$. By symmetry it suffices to prove the case $c_2 = c'_2$. Let $\epsilon > d_{\text{Hof}}(c_1, c'_1)$ and we take $x_1 \in \mathcal{C}_1^\Lambda(c_1, c'_1)$, $x_2 \in \mathcal{C}_1^\Lambda(c'_1, c_1)$, $y_1 \in \mathcal{C}_1^\Lambda(c_1, c_1)$, $y_2 \in \mathcal{C}_1^\Lambda(c'_1, c'_1)$ such that

$$\begin{aligned} \mathbf{m}_2(x_1, x_2) &= \mathbf{e}_{c_1} + \mathbf{m}_1(y_1), \\ \mathbf{m}_2(x_2, x_1) &= \mathbf{e}_{c'_1} + \mathbf{m}_1(y_2), \\ \mathbf{m}_1(x_1) &= \mathbf{m}_1(x_2) = 0. \end{aligned} \tag{15.2}$$

We also assume that $T^{\epsilon_1}x_1 \in C_1(c_1, c'_1)$, $T^{\epsilon_2}x_2 \in C_1(c'_1, c_1)$ with $\epsilon_1 + \epsilon_2 \leq \epsilon$ and $T^\epsilon y_1 \in C_1(c_1, c_1)$, $T^\epsilon y_2 \in C_1(c'_1, c'_1)$.

We put

$$\begin{aligned} \mathfrak{r}_1 &:= \mathcal{F}_{1,1}(x_1, \mathbf{e}_{c_2}), & \mathfrak{r}_2 &:= \mathcal{F}_{1,1}(x_2, \mathbf{e}_{c_2}), \\ \mathfrak{\eta}_1 &:= \mathcal{F}_{1,1}(y_1, \mathbf{e}_{c_2}), & \mathfrak{\eta}_2 &:= \mathcal{F}_{1,1}(y_2, \mathbf{e}_{c_2}). \end{aligned}$$

(Note that we extend $\mathcal{F}_{1,1}$ by Λ linearity to define the right hand sides.) Since \mathcal{F} is strict we have

$$\begin{aligned} \mathbf{m}_2(\mathfrak{r}_1, \mathfrak{r}_2) &= \mathcal{F}_{1,1}(\mathbf{m}_2(x_1, x_2), \mathbf{e}_{c_2}) = \mathcal{F}_{1,1}(\mathbf{e}_{c_1} + \mathbf{m}_1(y_1), \mathbf{e}_{c_2}) \\ &= \mathbf{e}_{\mathcal{F}(c_1, c_2)} + \mathbf{m}_1(\mathcal{F}_{1,1}(y_1, \mathbf{e}_{c_2})) = \mathbf{e}_{\mathcal{F}(c_1, c_2)} + \mathbf{m}_1(\mathfrak{\eta}_1). \end{aligned}$$

Similarly we have

$$\mathbf{m}_2(\mathfrak{r}_2, \mathfrak{r}_1) = \mathbf{e}_{\mathcal{F}(c'_1, c_2)} + \mathbf{m}_1(\mathfrak{\eta}_2),$$

and $\mathbf{m}_1(\mathfrak{r}_1) = \mathbf{m}_1(\mathfrak{r}_2) = 0$. Therefore $\mathcal{F}(c_1, c_2) \sim_\Lambda \mathcal{F}(c'_1, c_2)$. (1) follows. (2) follows from

$$\begin{aligned} T^{\epsilon_1}\mathfrak{r}_1 &\in \mathcal{C}_3(\mathcal{F}(c_1, c_2), \mathcal{F}(c'_1, c_2)), & T^{\epsilon_2}\mathfrak{r}_2 &\in \mathcal{C}_3(\mathcal{F}(c'_1, c_2), \mathcal{F}(c_1, c_2)), \\ T^\epsilon\mathfrak{\eta}_1 &\in \mathcal{C}_3(\mathcal{F}(c_1, c_2), \mathcal{F}(c_1, c_2)), & T^\epsilon\mathfrak{\eta}_2 &\in \mathcal{C}_3(\mathcal{F}(c'_1, c_2), \mathcal{F}(c'_1, c_2)). \end{aligned}$$

□

Theorem 15.11 is an immediate consequence of Theorem 15.5 and the following purely algebraic result.

Lemma 15.14. *Let $\mathcal{C}_1, \mathcal{C}_2, \mathcal{C}_3$ be strict and unital filtered A_∞ categories and*

$$\mathcal{F} : \mathcal{C}_1 \times \mathcal{C}_2 \rightarrow \mathcal{C}_3$$

a strict and unital filtered A_∞ bi-functor. It induces a strict and unital filtered A_∞ functor

$$\mathcal{F}_* : \mathcal{C}_2 \rightarrow \text{FUNC}(\mathcal{C}_1, \mathcal{C}_3) \tag{15.3}$$

by Lemma 5.14 (and its unital and strict analogue). Suppose $c_2, c'_2 \in \mathfrak{OB}(\mathcal{C}_2)$.

(1) *If $c_2 \sim_\Lambda c'_2$ then the two (Λ linear) filtered A_∞ functors*

$$\mathcal{F}_*(c_2)^\Lambda, \mathcal{F}_*(c'_2)^\Lambda : \mathcal{C}_1^\Lambda \rightarrow \mathcal{C}_3^\Lambda$$

are homotopy equivalent.

(2) *The inequality*

$$d_{\text{Hof}}(\mathcal{F}_*(c_2), \mathcal{F}_*(c'_2)) \leq d_{\text{Hof}}(c_2, c'_2)$$

holds.

◇

The proof is easy and so is omitted.

15.5. Proof of Theorem 15.5. In this subsection we explain how Theorem 15.5 follows from (the proof of) [FOOO1, Theorem G (G4) and Theorem 6.1.25] and [FOOO5]. Suppose we are in Situation 15.4.

We put $\Phi(L) = L'$. We take a compatible almost complex structure J and consider filtered A_∞ structures

$$\mathfrak{m}_k^{J,L} : \Omega(\tilde{L} \times_X \tilde{L})^{\otimes k} \rightarrow \Omega(\tilde{L} \times_X \tilde{L}) \hat{\otimes} \Lambda_0, \quad \mathfrak{m}_k^{J,L'} : \Omega(\tilde{L}' \times_X \tilde{L}')^{\otimes k} \rightarrow \Omega(\tilde{L}' \times_X \tilde{L}') \hat{\otimes} \Lambda_0.$$

Note that we can decompose $\mathfrak{m}_k^{J,L}$, $\mathfrak{m}_k^{J,L'}$ to a sum

$$\mathfrak{m}_k^{J,L} = \sum_E T^E \mathfrak{m}_{k,E}^{J,L}, \quad \mathfrak{m}_k^{J,L'} = \sum_E T^E \mathfrak{m}_{k,E}^{J,L'}$$

where $\mathfrak{m}_{k,E}^{J,L}$ and $\mathfrak{m}_{k,E}^{J,L'}$ are \mathbb{R} linear.

Remark 15.15. The right hand side is an infinite sum. However for each E_0 the set of $E < E_0$ such that $\mathfrak{m}_{k,E}^{J,L}$, $\mathfrak{m}_{k,E}^{J,L'}$ is nonzero is a finite set. This is a consequence of Gromov compactness. \diamond

We denote $CF(L) = \Omega(\tilde{L} \times_X \tilde{L}) \hat{\otimes} \Lambda_0$ and $CF(L') = \Omega(\tilde{L}' \times_X \tilde{L}') \hat{\otimes} \Lambda_0$. The next theorem is the de Rham version of [FOOO1, Corollary 4.6.3].

Theorem 15.16. *There exists a (curved) filtered A_∞ homomorphism $\hat{\mathfrak{f}} = \{\mathfrak{f}_k \mid k = 0, 1, 2, \dots\} : (CF(L), \{\mathfrak{m}_k^{J,L}; k = 0, 1, 2, \dots\}) \rightarrow (CF(L'), \{\mathfrak{m}_k^{J,L'}; k = 0, 1, 2, \dots\})$*

$$\mathfrak{f}_k : CF(L)^{\otimes k} \rightarrow CF(L')$$

such that

$$\mathfrak{f}_1(h) = (\Phi^{-1})^*(h) \pmod{\Lambda_+}.$$

\diamond

Proof. Let $J' = (\Phi^{-1})_* J$. The moduli space of J' holomorphic disks with the boundary conditions given by L is canonically identified with the moduli space of J holomorphic disks with the boundary condition given by L' . Therefore the following diagram commutes.

$$\begin{array}{ccc} B_k CF[1](L') & \xrightarrow{\mathfrak{m}_k^{J,L'}} & CF(L') \\ (\Phi^{-1})^* \uparrow & & \uparrow (\Phi^{-1})^* \\ B_k CF[1](L) & \xrightarrow{\mathfrak{m}_k^{J',L}} & CF(L) \end{array}$$

Therefore it suffices to construct a filtered A_∞ homomorphism $\mathfrak{g} = \{\mathfrak{g}_k\}$ from $(CF(L), \{\mathfrak{m}_k^{J,L}\})$ to $(CF(L), \{\mathfrak{m}_k^{J',L}\})$ such that $\mathfrak{g}_1 \equiv \text{id} \pmod{\Lambda_+}$.

We take a one parameter family of compatible almost complex structures $\mathcal{J} = \{J^{(\rho)}\}$ such that

- (1) $J^{(0)} = J$,
- (2) $J^{(1)} = J'$.

For the proof of Theorem 15.16 we can take any such \mathcal{J} . We will specify \mathcal{J} later during the proof of Proposition 15.22.

We use the ‘time ordered product’ moduli spaces $\mathcal{M}_{k+1}(L; \mathcal{J}; E; \text{top}(\rho))$ introduced in [FOOO1, Subsection 4.6.1], which have the properties spelled out in Proposition 15.17 below. We use the following notation in Proposition 15.17.

The moduli space $\mathcal{M}_{k+1}(L; E)$ is defined in (3.29). To specify the almost complex structure we use, we write $\mathcal{M}_{k+1}(L; E; J)$. It comes with evaluation maps:

$$\text{ev} = (\text{ev}_0, \text{ev}_1, \dots, \text{ev}_k) : \mathcal{M}_{k+1}(L; E; J) \rightarrow (\tilde{L} \times_X \tilde{L})^{k+1},$$

which is strongly smooth and such that ev_0 is weakly submersive. (See [FOOO10, FOOO13] and [FOOO8, Part 7] for the definition of strong smoothness and weak submersivity.)

Proposition 15.17. *There exists a compact Hausdorff space $\mathcal{M}_{k+1}(L; \mathcal{J}; E; \text{top}(\rho))$ equipped with a Kuranishi structure with corners, which enjoys the following properties.*

- (1) *There exists an evaluation map*

$$\text{ev} = (\text{ev}_0, \text{ev}_1, \dots, \text{ev}_k) : \mathcal{M}_{k+1}(L; \mathcal{J}; E; \text{top}(\rho)) \rightarrow (\tilde{L} \times_X \tilde{L})^{k+1}$$

which is strongly smooth. Moreover ev_0 is weakly submersive.

- (2) *The normalized boundary of $\mathcal{M}_{k+1}(L; \mathcal{J}; E; \text{top}(\rho))$ is the union of two types of the fiber products.*

(I) *The fiber product*

$$\mathcal{M}_{k_1+1}(L; E_1; J)_{\text{ev}_0 \times \text{ev}_i} \mathcal{M}_{k_2+1}(L; \mathcal{J}; E_2; \text{top}(\rho)), \tag{15.4}$$

where $k_1 + k_2 = k$, $E_1 + E_2 = E$ and $i = 1, \dots, k_2$.

(II) *The fiber product*

$$\prod_{i=1}^m \mathcal{M}_{k_i+1}(L; \mathcal{J}; E_i; \text{top}(\rho))_{(\text{ev}_0, \dots, \text{ev}_0) \times (\text{ev}_1, \dots, \text{ev}_m)} \mathcal{M}_{m+1}(L; E_0; J'), \tag{15.5}$$

where $k_1 + \dots + k_m = k$ and $E_1 + \dots + E_m + E_0 = E$.

- (3) *In the case when $E = 0$ and $k = 0$,*

$$\mathcal{M}_1(L; \mathcal{J}; 0; \text{top}(\rho)) = \tilde{L} \times_X \tilde{L},$$

and ev_0 is the identity map.

- (4) *The set of E such that $\mathcal{M}_{k+1}(L; \mathcal{J}; E; \text{top}(\rho)) \neq \emptyset$ is discrete.*

◇

A sketch of the proof. The construction of the moduli spaces $\mathcal{M}_{k+1}(L; \mathcal{J}; E; \text{top}(\rho))$ is worked out in detail in [FOOO1, Definition 4.6.1].⁶² Its element is an object $((\Sigma, \vec{z}), u, \gamma, \{\rho_{\alpha_i}\})$ as depicted in Figure 90. Here (Σ, \vec{z}) is a bordered marked curve of genus zero with one boundary component and $k + 1$ boundary marked points, and $u : (\Sigma, \partial\Sigma) \rightarrow (X, L)$ is a smooth map. The restriction of u to $\partial\Sigma \setminus (\vec{z} \cup \{\text{boundary node}\})$ is lifted to a map $\gamma : \partial\Sigma \setminus (\vec{z} \cup \{\text{boundary node}\}) \rightarrow \tilde{L}$. The map $\alpha_i \mapsto \rho_{\alpha_i}$ assigns a number $\rho_{\alpha_i} \in [0, 1]$ to each irreducible component Σ_{α_i} of Σ . We require the next Condition 15.18 for ρ_{α_i} . We also require that the restriction of u to Σ_{α_i} is $J^{(\rho_{\alpha_i})}$ -holomorphic. At boundary marked points and boundary nodes, we require switching conditions similar to those appeared in Section 3. (See Definition 3.17 (5).)

⁶²Actually we need a slight modification since our Lagrangian submanifolds are immersed. This modification is the same as the argument of Section 3.

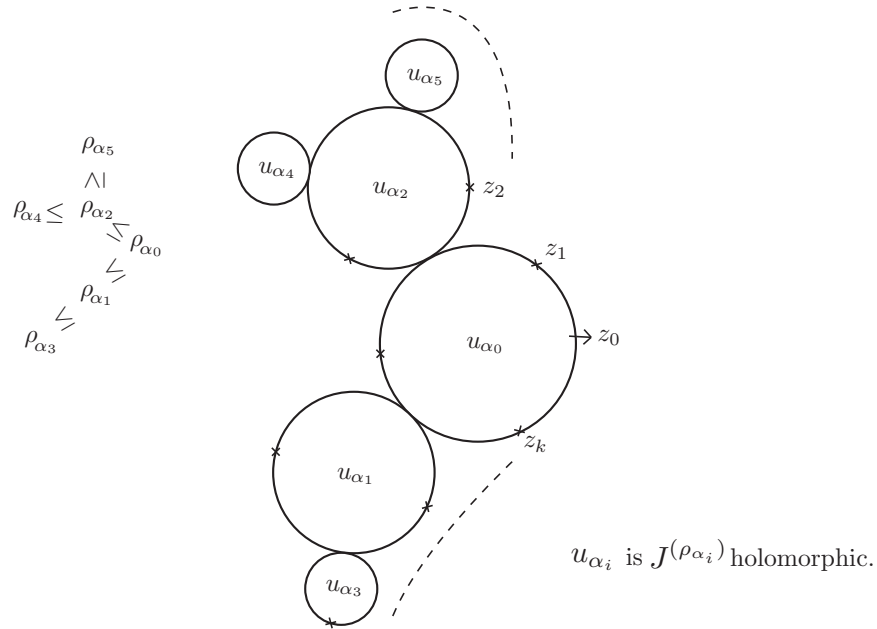

FIGURE 90. Time ordered product moduli space.

Condition 15.18. Let $p \in \Sigma$ be a boundary node and $p \in \Sigma_{\alpha_i} \cap \Sigma_{\alpha_j}$, $\Sigma_{\alpha_i} \neq \Sigma_{\alpha_j}$. We suppose Σ_{α_i} is contained in the connected component of $\Sigma \setminus \{p\}$ which contains the zero-th marked point z_0 . Then we require:

$$\rho_{\alpha_i} \geq \rho_{\alpha_j}.$$

◇

The definition of the topology of this moduli space and proof of its compactness and Hausdorff-ness are similar to those of Theorem 3.24. The construction of the Kuranishi structure is similar to the proof of Theorem 3.24.

We next describe the boundary. We observe that (15.4) corresponds to the case when one of ρ_{α_i} becomes 0 and that (15.5) corresponds to the case when one of ρ_{α_i} becomes 1. Actually such Σ_{α_i} is necessary the irreducible component containing z_0 , the zero-th marked point. (This is a consequence of Condition 15.18.)

The other possible boundary components of $\mathcal{M}_{k+1}(L; \mathcal{J}; E; \text{top}(\rho))$ cancel out each other as is explained in [FOOO1, page 246]. The key observation is the cancellation between two types of potential boundaries. One is depicted in Figure 91 below and the other is depicted in Figure 92 below. (Those two figures are [FOOO1, Figure 4.6.2] and [FOOO1, Figure 4.6.3], respectively.)

Item (3) of Proposition 15.17 is a consequence of the fact that left hand side is the moduli space of constant maps, which is transversal. Item (4) follows from Gromov compactness. \square

For later use we define

$$\rho_0 : \mathcal{M}_{k+1}(L; \mathcal{J}; E_2; \text{top}(\rho)) \rightarrow [0, 1]$$

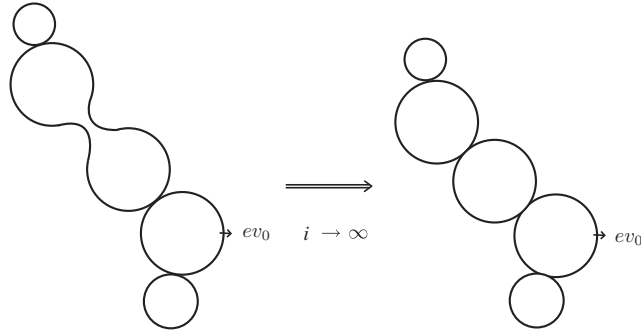

FIGURE 91. Cancellation in [FOOO1, Section 4.6] : 1.

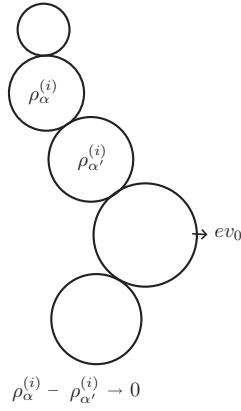

FIGURE 92. Cancellation in [FOOO1, Section 4.6] : 2.

as follows.

$$\rho_0((\Sigma, \vec{z}), u, \gamma, \{\rho_{\alpha_i}\}) = \rho_{\alpha_0} \tag{15.6}$$

where Σ_{α_0} is the irreducible component which contains the 0-th marked point.

Now using Proposition 15.17 we define $\mathfrak{g}_{k,E}$ by the next formula:

$$\begin{aligned} &\mathfrak{g}_{k,E}(h_1, \dots, h_k) \\ &= \text{ev}_0! \left(\text{ev}_1^* h_1 \wedge \dots \wedge \text{ev}_k^* h_k; (\mathcal{M}_{k+1}(L; \mathcal{J}; E; \text{top}(\rho)); \widehat{\mathfrak{S}}_\epsilon) \right). \end{aligned} \tag{15.7}$$

Here we take a system of CF-perturbations $\widehat{\mathfrak{S}}_\epsilon$ on $\mathcal{M}_{k+1}(L; \mathcal{J}; E; \text{top}(\rho))$ ⁶³ such that:

- (1) ev_0 is strongly submersive with respect to this CF-perturbation.
- (2) Those CF-perturbations are compatible with the identification of the boundary as (15.4), (15.5).

We use this system of CF-perturbations to define the integration along the fiber $\text{ev}_0!$ in (15.7). We now define

$$\mathfrak{g}_k(h_1, \dots, h_k) := \sum_E T^E \mathfrak{g}_{k,E}(h_1, \dots, h_k).$$

⁶³more precisely the outer collaring of its thickening

This is well-defined by Proposition 15.17 (4).

Stokes' formula ([FOOO10, FOOO13, Proposition 9.26]) and the composition formula ([FOOO10, FOOO13, Theorem 10.20]) imply that \mathfrak{g}_k defines a filtered A_∞ homomorphism. In fact (15.4) corresponds to

$$\mathfrak{g}_{k_1, E_1}(h_1, \dots, \mathfrak{m}_{k_1, E_2}^{J, L}(h_{i+1}, \dots, h_{i+k_1}), \dots, h_k)$$

and (15.5) corresponds to

$$\mathfrak{m}_{m, E_0}^{J', L}(\mathfrak{g}_{k_1, E_1}(\vec{h}_1), \dots, \mathfrak{g}_{k_m, E_m}(\vec{h}_m)).$$

Here $\vec{h}_1 = (h_1, \dots, h_{k_1})$, $\vec{h}_2 = (h_{k_1+1}, \dots, h_{k_1+k_2})$, etc.

The congruence $\mathfrak{g}_1 \equiv \text{id} \pmod{\Lambda_+}$ follows from Proposition 15.17 (3). The proof of Theorem 15.16 is complete. \square

Remark 15.19. We omit the argument needed to take the homotopy inductive limit $E \rightarrow \infty$, since it is similar to the other cases. (This process is necessary since we work with only finitely many moduli spaces consisting of moduli spaces of objects with energy $< E_0$, to construct a system of Kuranishi structures and its CF-perturbations.)

Theorem 15.5 (1) follows from Theorem 15.16. We turn to the proof of Theorem 15.5 (2),(3).

We use Yoneda embedding for the proof. The objects (L, b) and $(\Phi(L), \Phi_*(b))$ define filtered A_∞ right modules $\mathfrak{Yon}(L, b)$ and $\mathfrak{Yon}(\Phi(L), \Phi_*(b))$ over $\mathfrak{Fukst}(\mathbb{L})$, respectively. By Lemma 15.3 and A_∞ Yoneda lemma (Theorem 2.44), it suffices to prove the following.

- (2)' The equivalence $\mathfrak{Yon}(L, b) \sim_\Lambda \mathfrak{Yon}(\Phi(L), \Phi_*(b))$ holds in the functor category $\mathcal{FUNC}(\mathfrak{Fukst}(\mathbb{L})^{\text{op}}, \mathcal{CH})$.
- (3)' The Hofer distance $d_{\text{Hof}}(\mathfrak{Yon}(L, b), \mathfrak{Yon}(\Phi(L), \Phi_*(b)))$ is not greater than the Hofer distance between Φ and the identity map.

The proof of (2)', (3)' occupies the rest of this subsection. We put $L' = \Phi(L)$ and $M =$ the disjoint union of elements of \mathbb{L} . Note that $M = (\tilde{M}, i_M)$ is an immersed Lagrangian submanifold of X . We put

$$R := \tilde{L} \times_X \tilde{M} \quad R' := \tilde{L}' \times_X \tilde{M}. \quad (15.8)$$

They are submanifolds of $\tilde{L} \times \tilde{M}$, $\tilde{L}' \times \tilde{M}$, respectively. We define

$$\begin{aligned} CF(L, M) &= \Omega(R) \hat{\otimes} \Lambda_0, \\ CF(L', M) &= \Omega(R') \hat{\otimes} \Lambda_0, \\ CF(M) &= \Omega(\tilde{M} \times_X \tilde{M}) \hat{\otimes} \Lambda_0. \end{aligned} \quad (15.9)$$

We take a bounding cochain b_M of M . Then together with the bounding cochain b of L and $\Phi_*(b)$ of L' we obtain a right $(CF(M), \{\mathfrak{m}_k^{b_M}\})$ module structures

$$\begin{aligned} \mathfrak{n}_k^L &: CF(L, M) \otimes B_k CF(M) \rightarrow CF(L, M), \\ \mathfrak{n}_k^{L'} &: CF(L', M) \otimes B_k CF(M) \rightarrow CF(L', M). \end{aligned} \quad (15.10)$$

They are nothing but $\mathfrak{Yon}(L, b)$ and $\mathfrak{Yon}(\Phi(L), \Phi_*(b))$. We set

$$CF(L, M)^\Lambda = CF(L, M) \otimes_{\Lambda_0} \Lambda, \quad CF(L', M)^\Lambda = CF(L', M) \otimes_{\Lambda_0} \Lambda.$$

We first review the moduli spaces we use to define the filtered bi-module structure (15.10) on $CF(L, M)$ (resp. $CF(L', M)$) over $CF(L)$ - $CF(M)$ (resp. $CF(L')$ - $CF(M)$). See [FOOO1, Subsection 3.7.4,3.7.5] for detail. We consider the equation

$$\frac{\partial u}{\partial \tau} + J \frac{\partial u}{\partial t} = 0 \tag{15.11}$$

for a map $u : \mathbb{R} \times [0, 1] \rightarrow X$ with boundary conditions:

- (a) $u(\tau, 0) \in M$.
- (b) $u(\tau, 1) \in L$. (resp. $u(\tau, 1) \in L'$.)

We consider \vec{z}_0, \vec{z}_1 such that $\vec{z}_0 = (z_{0,1}, \dots, z_{0,k_0})$, where $z_{0,i} = (\tau_{0,i}, 0)$ with $\tau_{0,1} < \dots < \tau_{0,k_0}$, and $\vec{z}_1 = (z_{1,1}, \dots, z_{1,k_1})$, where $z_{1,i} = (\tau_{1,i}, 0)$ with $\tau_{1,1} > \dots > \tau_{1,k_1}$.⁶⁴

We also consider $\gamma_0 : \mathbb{R} \times \{0\} \setminus \vec{z}_0 \rightarrow \tilde{M}$, $\gamma_1 : \mathbb{R} \times \{1\} \setminus \vec{z}_1 \rightarrow \tilde{L}$, lifts of the restriction of u . We assume an appropriate switching condition similar to those appeared in Section 3. (See Definition 3.17 (5).) We finally require

- (c) $\lim_{\tau \rightarrow \pm\infty} (\gamma_0(\tau), \gamma_1(\tau)) \in R$. (resp. $\lim_{\tau \rightarrow \pm\infty} (\gamma_0(\tau), \gamma_1(\tau)) \in R'$.)
- (d)

$$\int_{\mathbb{R} \times [0,1]} u^* \omega = E.$$

We consider such $(\vec{z}_0, \vec{z}_1; u; \gamma_0, \gamma_1)$ satisfying the above conditions and the moduli space of such objects. We then take its quotient by the \mathbb{R} action induced by the translation of the first factor of the source $\mathbb{R} \times [0, 1]$. We denote this space by $\mathring{\mathcal{M}}_{k_1, k_0}(L, M; E; J)$ (resp. $\mathring{\mathcal{M}}_{k_1, k_0}(L', M; E; J)$).

Remark 15.20. In Equation (15.11) (and in other places of this subsection) we take $\mathbb{R} \times [0, 1]$ as a strip, while in Section 5 (and in other places of this paper) we took $[0, 1] \times \mathbb{R}$. In this subsection we use $\mathbb{R} \times [0, 1]$ for the sake of consistency with [FOOO1, Subsection 3.7.4,3.7.5]. In Section 5 we identified $(t, \tau) \in [0, 1] \times \mathbb{R}$ with $t + \sqrt{-1}\tau \in \mathbb{C}$ to define complex structure. (See the proof of Lemma 5.35.) Here we identify (τ, t) with $\tau + \sqrt{-1}t \in \mathbb{C}$. (Note that in Section 5 the equation corresponding to (15.11) is $\frac{\partial u}{\partial \tau} = J \frac{\partial u}{\partial t}$.)

In both cases if we regard the first coordinate (t in case of Section 5 and τ in case of this subsection) as the x -axis and the second coordinate as the y -axis, then the above choice is consistent with the standard conformal structure of the xy -plane.

We also remark that in Section 5 we construct *right* $CF(L_1)$ module and L_1 is assigned at the right, that is, $t = 1$. In this subsection we construct *right* $CF(M)$ module and M is assigned at the bottom, that is, $t = 0$. This is consistent with our choice of orientation and conformal structure of the domain. \diamond

Proposition 15.21. *The space $\mathring{\mathcal{M}}_{k_1, k_0}(L, M; E; J)$ (resp. $\mathring{\mathcal{M}}_{k_1, k_0}(L', M; E; J)$) has a compactification $\mathcal{M}_{k_1, k_0}(L, M; E; J)$ (resp. $\mathcal{M}_{k_1, k_0}(L', M; E; J)$) which is compact and Hausdorff, with respect to the stable map topology. They have Kuranishi structures with corners, and enjoy the following properties.*

- (1) *There exist evaluation maps*

$$\begin{aligned} \text{ev} &= (\text{ev}^{(1)}, \text{ev}^{(0)}) = ((\text{ev}_1^{(1)}, \dots, \text{ev}_{k_1}^{(1)}), (\text{ev}_1^{(0)}, \dots, \text{ev}_{k_0}^{(0)})) \\ &: \mathcal{M}_{k_1, k_0}(L, M; E; J) \rightarrow (\tilde{L} \times_X \tilde{L})^{k_1} \times (\tilde{M} \times_X \tilde{M})^{k_0}, \end{aligned}$$

⁶⁴Note that we use the counter clock-wise ordering to enumerate the marked points.

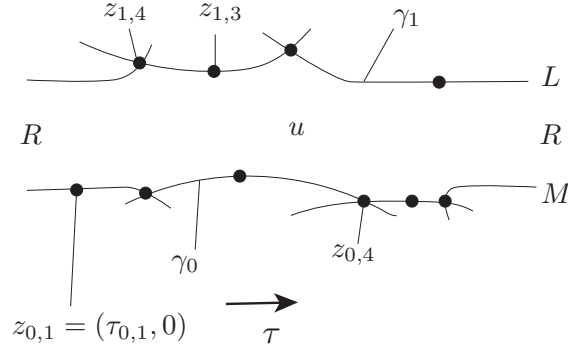
FIGURE 93. Elements of $\mathcal{M}_{k_1, k_0}(L', M; E; J)$.

(resp.

$$\begin{aligned} \text{ev} = (\text{ev}^{(1)}, \text{ev}^{(0)}) &= ((\text{ev}_1^{(1)}, \dots, \text{ev}_{k_1}^{(1)}), (\text{ev}_1^{(0)}, \dots, \text{ev}_{k_0}^{(0)})) \\ &: \mathcal{M}_{k_1, k_0}(L', M; E; J) \rightarrow (\tilde{L}' \times_X \tilde{L}')^{k_1} \times (\tilde{M} \times_X \tilde{M})^{k_0}. \end{aligned}$$

These maps are evaluation maps at the marked points \vec{z}_1, \vec{z}_0 and are underlying continuous maps of strongly smooth maps.

(2) There exists also evaluation maps at infinity

$$(\text{ev}_{-\infty}, \text{ev}_{+\infty}) : \mathcal{M}_{k_1, k_0}(L, M; E; J) \rightarrow R \times R,$$

(resp.

$$(\text{ev}_{-\infty}, \text{ev}_{+\infty}) : \mathcal{M}_{k_1, k_0}(L', M; E; J) \rightarrow R' \times R'.)$$

These maps are defined by the limit in item (c) above and are underlying continuous maps of strongly smooth maps. The map $\text{ev}_{+\infty}$ is weakly submersive.

(3) The normalized boundary of $\mathcal{M}_{k_1, k_0}(L, M; E; J)$ (resp. $\mathcal{M}_{k_1, k_0}(L', M; E; J)$) is the disjoint union of the following three types of fiber products.

(I) The fiber product

$$\mathcal{M}_{k_{1,1}+1}(L; E_1; J)_{\text{ev}_0} \times_{\text{ev}_i^{(1)}} \mathcal{M}_{k_{1,2}, k_0}(L, M; E_2; J), \quad (15.12)$$

where $k_{1,1} + k_{1,2} = k_1$, $E_1 + E_2 = E$ and $i = 1, \dots, k_{1,2}$. (resp. The same except we replace L by L' .) (Figure 94)

(II) The fiber product

$$\mathcal{M}_{k_{0,1}+1}(M; E_1; J)_{\text{ev}_0} \times_{\text{ev}_i^{(0)}} \mathcal{M}_{k_1, k_{0,2}}(L, M; E_2; J), \quad (15.13)$$

where $k_{0,1} + k_{0,2} = k_0$, $E_1 + E_2 = E$ and $i = 1, \dots, k_{0,2}$. (resp. The same except we replace L by L' .) (Figure 95)

(III) The fiber product

$$\mathcal{M}_{k_{1,1}, k_{0,1}}(L, M; E_1; J)_{\text{ev}_{+\infty}} \times_{\text{ev}_{-\infty}} \mathcal{M}_{k_{1,2}, k_{0,2}}(L, M; E_2; J), \quad (15.14)$$

where $k_{0,1} + k_{0,2} = k_0$, $k_{1,1} + k_{1,2} = k_1$, $E_1 + E_2 = E$. (resp. The same except we replace L by L' .) (Figure 96)

The evaluation maps are compatible with these identifications of the boundary with fiber product.

- (4) There exists a principal $O(1)$ bundle on $\tilde{L} \times_X \tilde{L}$, $\tilde{L} \times_X \tilde{L}$, $\tilde{L}' \times_X \tilde{L}'$, R and R' and the trivialization of the orientation bundle of $\mathcal{M}_{k_1, k_0}(L, M; E; J)$ tensored with the pull backs of those principal $O(1)$ bundles. These trivializations are compatible with the above identification of the boundary.
- (5) The set of E for which $\mathcal{M}_{k_1, k_0}(L, M; E; J)$ (resp. $\mathcal{M}_{k_1, k_0}(L', M; E; J)$) is nonempty is discrete.

◇

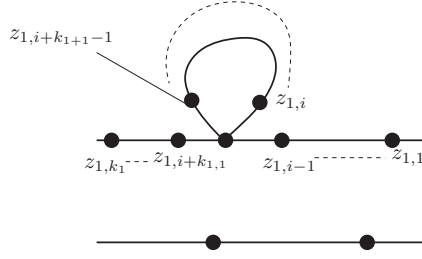

FIGURE 94. Boundary of type I.

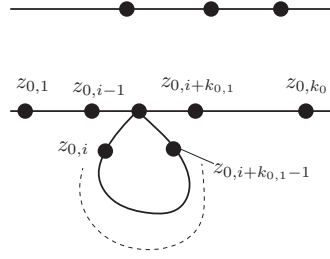

FIGURE 95. Boundary of type II.

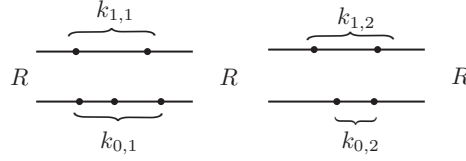

FIGURE 96. Boundary of type III.

The proof is now a routine. (See also [FOOO1, Subsection 3.7.4, 3.7.5], [FOOO15] and Subsection 3.2 of this paper.) We now define

$$\begin{aligned} \mathfrak{n}_{k_1, k_0}^L &: B_{k_0} CF(L)[1] \otimes CF(L, M) \otimes B_{k_1} CF(M)[1] \rightarrow CF(L, M), \\ \mathfrak{n}_{k_1, k_0}^{L'} &: B_{k_0} CF(L')[1] \otimes CF(L', M) \otimes B_{k_1} CF(M)[1] \rightarrow CF(L', M), \end{aligned} \tag{15.15}$$

by

$$\begin{aligned} &\mathfrak{n}_{k_1, k_0}^L(h_1^{(1)}, \dots, h_{k_1}^{(1)}; h; h_1^{(0)}, \dots, h_{k_0}^{(0)}) \\ &:= \sum_E T^E \text{ev}_{+\infty}! \left((\text{ev}_1^{(1)})^* h_1^{(1)} \wedge (\text{ev}_{k_1}^{(1)})^* h_{k_1}^{(1)} \wedge \text{ev}_{-\infty}^* h \right. \\ &\quad \left. \wedge (\text{ev}_1^{(0)})^* h_1^{(0)} \wedge (\text{ev}_{k_0}^{(0)})^* h_{k_0}^{(0)}; \mathcal{M}_{k_1, k_0}(L, M; E; J); \widehat{\mathfrak{S}}_\epsilon \right). \end{aligned} \tag{15.16}$$

Here we take a system of CF-perturbations $\widehat{\mathfrak{S}}_\epsilon$ on $\mathcal{M}_{k_1, k_0}(L, M; E; J)$ such that $\text{ev}_{+\infty}$ is strongly submersive with respect to $\widehat{\mathfrak{S}}_\epsilon$ and that the CF-perturbations $\widehat{\mathfrak{S}}_\epsilon$ are compatible with the fiber product description of the boundaries in Proposition 15.21 (3). We use the CF-perturbation to define the integration along the fiber

$\text{ev}_{+\infty}!$ in (15.16). (See [FOOO10, FOOO13, Definitions 7.78 and 9.13].) The definition of $\mathfrak{n}_{k_1, k_0}^{L'}$ is similar. We can show that these maps define structures of filtered A_∞ bi-module by using Stokes' formula ([FOOO10, FOOO13, Proposition 9.26]) and the composition formula ([FOOO10, FOOO13, Theorem 10.20]) together with Proposition 15.21 (3).

We now define the map (15.10) by

$$\mathfrak{n}_k^L(y; x_1, \dots, x_k) := \sum_{\ell, m_0, \dots, m_k} \mathfrak{n}_{\ell, k + \sum m_i}^L(b^\ell; y; b_M^{m_0} x_1 b_M^{m_1} \dots b_M^{m_{k-1}} x_k b_M^{m_k}).$$

Here and hereafter, for example, $b_M^2 x b_M$ means $b_M \otimes b_M \otimes x \otimes b_M$. The A_∞ relation of $\mathfrak{n}_{k_1, k_0}^L$ and the fact that b, b_M are bounding cochains imply that \mathfrak{n}_k^L defines a (strict and unital) filtered right A_∞ ($CF(M); \{\mathfrak{m}_k^{b_M}\}$) module structure on $CF(L, M)$.

We can define $\mathfrak{n}_k^{L'}$ in the same way.

We next describe the moduli spaces which we use to define a filtered right A_∞ module homomorphism $CF(L, M)^\Lambda \rightarrow CF(L', M)^\Lambda$. We follow [FOOO1, Subsection 5.3.1] with modification given in [FOOO5]. We will use a two parameter family of almost complex structures $\mathcal{J}\mathcal{J}$, which is defined in Definition 15.23, to define the moduli space appearing in Proposition 15.22.

Proposition 15.22. *There exists a system of compact Hausdorff spaces*

$$\mathcal{M}_{k_1, k_0}(L, L'; M; E; \mathcal{J}\mathcal{J}; \text{top}(\rho))$$

with the following properties. The spaces $\mathcal{M}_{k_1, k_0}(L, L'; M; E; \mathcal{J}\mathcal{J}; \text{top}(\rho))$ carry Kuranishi structures with corners.

(1) *There exist evaluation maps*

$$\begin{aligned} \text{ev} = (\text{ev}_1^{(1)}, \text{ev}_1^{(0)}) &= ((\text{ev}_1^{(1)}, \dots, \text{ev}_{k_1}^{(1)}), (\text{ev}_1^{(0)}, \dots, \text{ev}_{k_0}^{(0)})) \\ &: \mathcal{M}_{k_1, k_0}(L, L'; M; E; \mathcal{J}\mathcal{J}; \text{top}(\rho)) \rightarrow (\tilde{L} \times_X \tilde{L})^{k_1} \times (\tilde{M} \times_X \tilde{M})^{k_0}. \end{aligned}$$

These maps are underlying continuous maps of strongly smooth maps.

(2) *There exist also evaluation maps at infinity*

$$(\text{ev}_{-\infty}, \text{ev}_{+\infty}) : \mathcal{M}_{k_1, k_0}(L, L'; M; E; \mathcal{J}\mathcal{J}; \text{top}(\rho)) \rightarrow R \times R'.$$

These maps are underlying continuous maps of strongly smooth maps. $\text{ev}_{+\infty}$ is weakly submersive. R and R' are defined in (15.8).

(3) *The normalized boundary of $\mathcal{M}_{k_1, k_0}(L, L'; M; E; \mathcal{J}\mathcal{J}; \text{top}(\rho))$ is the disjoint union of the following four types of fiber products.*

(I) *The fiber product*

$$\mathcal{M}_{k_{1,1}+1}(L; E_1; J)_{\text{ev}_0} \times_{\text{ev}_i^{(1)}} \mathcal{M}_{k_{1,2}, k_0}(L, L'; M; E_2; \mathcal{J}\mathcal{J}; \text{top}(\rho)), \quad (15.17)$$

where $k_{1,1} + k_{1,2} = k_1$, $E_1 + E_2 = E$ and $i = 1, \dots, k_{1,2}$. (See Figure 97.)

(II) *The fiber product*

$$\mathcal{M}_{k_{0,1}+1}(M; E_1; J)_{\text{ev}_0} \times_{\text{ev}_i^{(0)}} \mathcal{M}_{k_1, k_{0,2}}(L, L'; M; E_2; \mathcal{J}\mathcal{J}; \text{top}(\rho)), \quad (15.18)$$

where $k_{0,1} + k_{0,2} = k_0$, $E_1 + E_2 = E$ and $i = 1, \dots, k_{0,2}$. (See Figure 98.)

(III) *The fiber product*

$$\mathcal{M}_{k_{0,1}, k_{1,1}}(L, M; E_1; J)_{\text{ev}_{+\infty}} \times_{\text{ev}_{-\infty}} \mathcal{M}_{k_{1,2}, k_{0,2}}(L, L'; M; E_2; \mathcal{J}\mathcal{J}; \text{top}(\rho)), \quad (15.19)$$

where $k_{0,1} + k_{0,2} = k_0$, $k_{1,1} + k_{1,2} = k_1$, $E_1 + E_2 = E$. (See Figure 99.)

(IV) The fiber product of

$$\mathcal{M}_{k_{1,1},k_{0,1}}(L, L'; M; E; \mathcal{J}\mathcal{J}; \text{top}(\rho)) \tag{15.20}$$

and

$$\prod_{j=1}^{\ell} \mathcal{M}_{m_j+1}(L; \mathcal{J}; E_{2,j}; \text{top}(\rho)) \tag{15.21}$$

$$\times_{(\text{ev}_0, \dots, \text{ev}_0)} \times_{(\text{ev}_1^{(1)}, \dots, \text{ev}_1^{(2)})} \mathcal{M}_{k_{0,2},k_{1,2}}(L', M; E_{2,0}; J)$$

where $k_{1,1} + \sum_{j=1}^{\ell} m_j = k_1$, $k_{0,1} + k_{0,2} = k_0$, $E_1 + \sum_{j=0}^{k_{1,2}} E_{2,j} = E$. We use $\text{ev}_{+\infty} : (15.20) \rightarrow R'$ and $\text{ev}_{-\infty} : (15.21) \rightarrow R'$ to take fiber product between (15.20) and (15.21). (See Figure 100.)

The evaluation maps are compatible with this identifications.

- (4) There exists a principal $O(1)$ bundle on $\tilde{L} \times_X \tilde{L}$, $\tilde{L} \times_X \tilde{L}$, $\tilde{L}' \times_X \tilde{L}'$, R and R' and the trivializations of the orientation bundle of $\mathcal{M}_{k_1,k_0}(L, L'; M; E; \mathcal{J}\mathcal{J}; \text{top}(\rho))$ tensored with the pull backs of those principal $O(1)$ bundles. These trivializations are compatible with the above identification of the boundary.
- (5) The set of E for which $\mathcal{M}_{k_1,k_0}(L, L'; M; E; \mathcal{J}\mathcal{J}; \text{top}(\rho))$ is nonempty is discrete.

◇

The elements of the moduli spaces corresponding to the boundaries of types (I)(II)(III)(IV) are depicted in the Figures 97-100 below. The explanation of the figures will be given during the proof of Proposition 15.22.

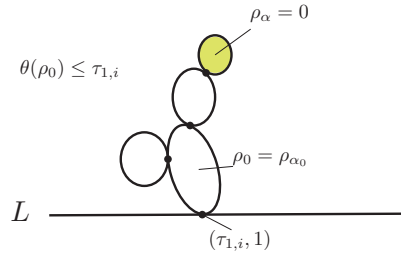

FIGURE 97. Boundary of type I.

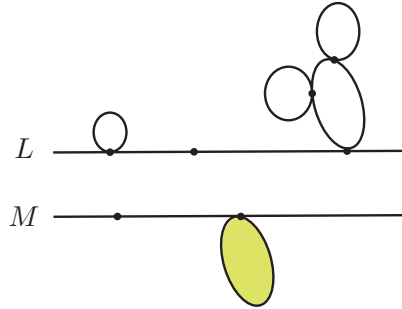

FIGURE 98. Boundary of type II.

Proof. We take one parameter family of Hamiltonian diffeomorphisms Φ^ρ such that $\Phi^0 = \text{id}$ and $\Phi^1 = \Phi$. When $H : X \times [0, 1] \rightarrow \mathbb{R}$ is the time dependent family of Hamiltonians generating Φ , we take Φ^ρ so that

$$\frac{d\Phi^\rho}{d\rho} = X_{H_\rho} \circ \Phi^\rho, \quad \Phi^0 = \text{id} \tag{15.22}$$

where $H_\rho(x) = H(x, \rho)$ and X_{H_ρ} is the Hamiltonian vector field associated to H_ρ .

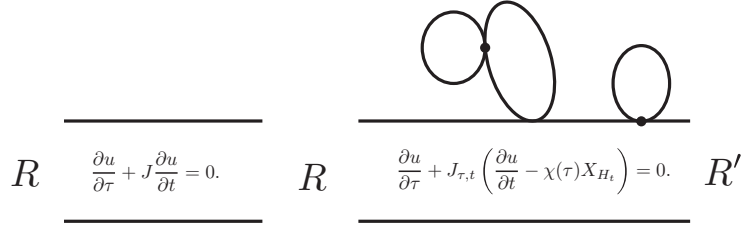

FIGURE 99. Boundary of type III.

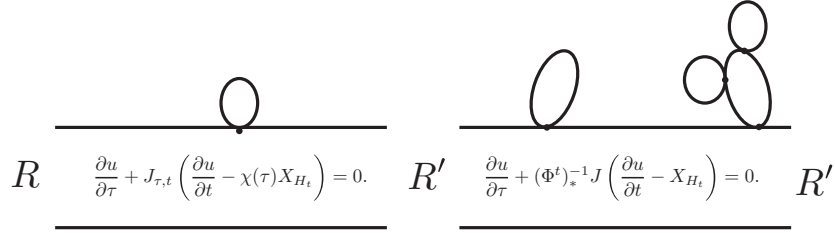

FIGURE 100. Boundary of type IV.

We replace H by cH and obtain one parameter family of Hamiltonian diffeomorphisms, which we denote by Φ_{cH}^ρ .

We take a non-decreasing function

$$\chi : \mathbb{R} \rightarrow [0, 1] \quad (15.23)$$

such that:

- (1) $\chi(\tau) = 0$ for sufficiently small τ .
- (2) $\chi(\tau) = 1$ for sufficiently large τ .

Definition 15.23. We take a two parameter family of complex structures $\mathcal{J}\mathcal{J} = \{J_{\tau,t}\}$ with the following properties.

- (1) There exists $A > 0$ such that $J_{\tau,t} = J$ if $\tau < -A$.
- (2)

$$J_{\tau,t} = (\Phi^t)_*^{-1} J \quad (15.24)$$

if $\tau > +A$.

- (3) We denote by Φ_{cH}^ρ the one parameter family of Hamilton diffeomorphisms generated by the time dependent Hamiltonian $cH : X \times [0, 1] \rightarrow \mathbb{R}$. Then

$$J_{\tau,1} = (\Phi_{\chi(\tau)H}^1)_*^{-1} J \quad (15.25)$$

if $\tau > 0$.

- (4) $J_{\tau,0} = J$ for any τ .

We take the one parameter family of almost complex structures $\mathcal{J} = \{J^{(\rho)}\}$ which we used to prove Proposition 15.17 as follows. We take and fix an order preserving diffeomorphism

$$\theta : (0, 1) \rightarrow \mathbb{R}.$$

We then put:

$$J^{(\rho)} = (\Phi_{\chi(\theta(\rho))H}^1)_*^{-1} J. \quad (15.26)$$

We consider maps

$$u : \mathbb{R} \times [0, 1] \rightarrow X, \quad (15.27)$$

which satisfy the following conditions.

Condition 15.24.

- (1) u satisfies the equation

$$\frac{\partial u}{\partial \tau} + J_{\tau,t} \left(\frac{\partial u}{\partial t} - \chi(\tau) X_{H_t} \right) = 0. \quad (15.28)$$

Here H is the time dependent Hamiltonian as in (15.22).

- (2) $u(\tau, 0) \in M$.
 (3) $u(\tau, 1) \in L$.

◇

Remark 15.25. In [FOOO1, Subsection 5.3.1] we used pseudo-holomorphic curve equation (without Hamiltonian term) with a moving boundary condition, (which becomes the condition $u(\tau, 1) \in \Phi_{\chi_+(\tau)}(L)$ in our situation). (See [FOOO1, (5.3.18.1) and (5.3.18.2)].) Here we use the equation (15.28) (which has a Hamiltonian term) and the boundary conditions are given by fixed Lagrangian submanifolds M and L . The way taken here is the same as [FOOO5]. (See [FOOO5, (3.3) and (3.4)].) The relation between these two formulations are explained in [FOOO5, Section 4]. We use the current formulation since then we can obtain energy estimate (Lemma 15.29) easier.◇

Definition 15.26. We define $\overset{\circ}{\mathcal{M}}_{k_1, k_0}(L, L'; M; E; \mathcal{J}\mathcal{J}; \text{top}(\rho))$ as the set of objects $((\mathbb{R} \times [0, 1]; \vec{z}_0, \vec{z}_1); u; \gamma; \vec{\rho})$ such that:

- (1) The map u is as in (15.27) and satisfying Conditions 15.24.
 (2) \vec{z}_0 (resp. \vec{z}_1) is a k_0 (resp. k_1) tuple of points, that is, $\vec{z}_0 = (z_{0,1}, \dots, z_{0,k_0})$, where $z_{0,i} = (\tau_{0,i}, 0)$ with $\tau_{0,1} < \dots < \tau_{0,k_0}$ (resp. $\vec{z}_1 = (z_{1,1}, \dots, z_{1,k_1})$, where $z_{1,i} = (\tau_{1,i}, 0)$ with $\tau_{1,1} > \dots > \tau_{1,k_1}$).
 (3) The maps $\gamma_0 : (\mathbb{R} \times \{0\}) \setminus \vec{z}_0 \rightarrow \tilde{M}$, $\gamma_1 : (\mathbb{R} \times \{1\}) \setminus \vec{z}_1 \rightarrow \tilde{L}$ are lifts of the restrictions of u . Namely

$$u(\tau, 1) = i_L(\gamma_1(\tau)), \quad u(\tau, 0) = i_M(\gamma_0(\tau)). \quad (15.29)$$

We assume an appropriate switching condition similar to those appeared in Section 3. (See Definition 3.17 (5).)

- (4) $\vec{\rho} = (\rho_1, \dots, \rho_{k_1})$, where ρ_i are real numbers. We require

$$\theta(\rho_i) \leq \tau_{1,i}. \quad (15.30)$$

- (5) We require

$$E = \int_{\mathbb{R} \times [0,1]} u^* \omega + \lim_{\tau \rightarrow +\infty} \int_{[0,1]} H(t, u(\tau, t)) dt.$$

◇

We define evaluation maps

$$\text{ev}_{1,i} : \overset{\circ}{\mathcal{M}}_{k_1, k_0}(L, L'; M; E; \mathcal{J}\mathcal{J}; \text{top}(\rho)) \rightarrow \tilde{L} \times_X \times \tilde{L} \quad (15.31)$$

(resp.

$$\text{ev}_{0,i} : \overset{\circ}{\mathcal{M}}_{k_1, k_0}(L, L'; M; E; \mathcal{J}\mathcal{J}; \text{top}(\rho)) \rightarrow \tilde{M} \times_X \times \tilde{M}), \quad (15.32)$$

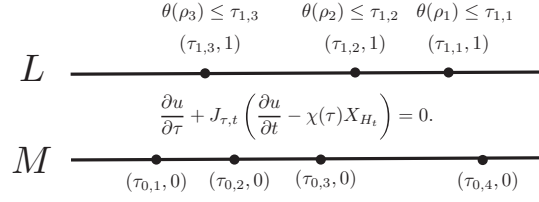
FIGURE 101. An element of $\overset{\circ}{\mathcal{M}}_{k_1, k_0}(L, L'; M; E; \mathcal{J}\mathcal{J}; \text{top}(\rho))$.

as the evaluation maps at the marked points $z_{0,i}$ (resp. $z_{1,i}$) using the switching condition in the same way as (3.19). Namely

$$\text{ev}_{1,i}((\mathbb{R} \times [0, 1]; \vec{z}_0, \vec{z}_1); u; \gamma; \vec{\rho}) = \left(\lim_{\tau \downarrow \tau_{1,i}} \gamma_1(\tau), \lim_{\tau \uparrow \tau_{1,i}} \gamma_1(\tau) \right), \quad (15.33)$$

and

$$\text{ev}_{0,i}((\mathbb{R} \times [0, 1]; \vec{z}_0, \vec{z}_1); u; \gamma; \vec{\rho}) = \left(\lim_{\tau \uparrow \tau_{0,i}} \gamma_0(\tau), \lim_{\tau \downarrow \tau_{0,i}} \gamma_0(\tau) \right), \quad (15.34)$$

respectively.

We also define the evaluation maps at infinity

$$\text{ev}_{-\infty} : \overset{\circ}{\mathcal{M}}_{k_1, k_0}(L, L'; M; E; \mathcal{J}\mathcal{J}; \text{top}(\rho)) \rightarrow R \quad (15.35)$$

(resp.

$$\text{ev}_{+\infty} : \overset{\circ}{\mathcal{M}}_{k_1, k_0}(L, L'; M; E; \mathcal{J}\mathcal{J}; \text{top}(\rho)) \rightarrow R'). \quad (15.36)$$

Here we define $\text{ev}_{+\infty}$ by

$$\text{ev}_{+\infty}((\mathbb{R} \times [0, 1]; \vec{z}_1; u; \gamma; \vec{\rho}) = \lim_{\tau \rightarrow +\infty} (\gamma_0(\tau), \Phi(\gamma_1(\tau))). \quad (15.37)$$

Note that the limit $\ell(t) = \lim_{\tau \rightarrow +\infty} u(\tau, t)$ satisfies

$$\frac{d\ell}{dt} = X_{H_t} \circ \ell.$$

This is a consequence of (15.24) and $\lim_{\tau \rightarrow +\infty} \frac{\partial u}{\partial \tau} = 0$.

Therefore

$$\lim_{\tau \rightarrow +\infty} \Phi(u(\tau, 0)) = \lim_{\tau \rightarrow +\infty} u(\tau, 1).$$

Hence the right hand side of (15.37) is an element of R' .

Finally we define

$$\text{ev}_i^{\text{deti}} : \overset{\circ}{\mathcal{M}}_{k_1, k_0}(L, L'; M; E; \mathcal{J}\mathcal{J}; \text{top}(\rho)) \rightarrow [0, 1] \quad (15.38)$$

by

$$\text{ev}_i^{\text{deti}}((\mathbb{R} \times [0, 1]; \vec{z}_0, \vec{z}_1); u; \gamma; \vec{\rho}) = \rho_i. \quad (15.39)$$

(Here deti stands for ‘time with delay’.)

Definition 15.27. $\overset{\circ}{\mathcal{M}}_{k_1, k_0}(L, L'; M; E; \mathcal{J}\mathcal{J}; \text{top}(\rho))$ is a union of fiber products of

$$\prod_{j=1}^{k'_1} \mathcal{M}_{m_j+1}(L; \mathcal{J}; E_{1,j}; \text{top}(\rho)) \quad (15.40)$$

and

$$\overset{\circ}{\mathcal{M}}_{k'_1, k_0}(L, L'; M; E_2; \mathcal{J}\mathcal{J}; \text{top}(\rho)), \quad (15.41)$$

where the union is taken over $k'_1, \{m_j\}, \{E_{1,j}\}, E_2$ with $\sum_{j=1}^{k'_1} m_j = k_1, \sum_{j=1}^{k'_1} E_{1,j} + E_2 = E$.

The fiber product is taken over $\prod_{j=1}^{k'_1} ((\tilde{L} \times_X \tilde{L}) \times \mathbb{R})$. We use the map (15.40) $\rightarrow \prod_{j=1}^{k'_1} ((\tilde{L} \times_X \tilde{L}) \times \mathbb{R})$ which is $((\text{ev}_0, \rho_0), \dots, (\text{ev}_0, \rho_0))$ and the map (15.41) $\rightarrow \prod_{j=1}^{k'_1} ((\tilde{L} \times_X \tilde{L}) \times \mathbb{R})$ which is $((\text{ev}_{1,1}, \text{ev}_{1,1}^{\text{deti}}), \dots, (\text{ev}_{1,k'_1}, \text{ev}_{1,k'_1}^{\text{deti}}))$ to define the fiber product. (Note ρ_0 is defined by (15.6).) \diamond

Figure 102 below depicts an element of $\mathring{\mathcal{M}}_{k_1, k_0}(L, L'; M; E; \mathcal{J}\mathcal{J}; \text{top}(\rho))$. It is a map to X from the domain which is a union of a strip $\mathbb{R} \times [0, 1]$ and trees of disks attached at $t = 1$. It is pseudo-holomorphic with respect to the almost complex structure of X which depends on the components of the domain. The almost complex structure we use is $J^{(\rho_i)}$ on the disk components depicted in Figure 102. Note that $J^{(\rho)}$ is defined in (15.26). We remark that all the fiber products

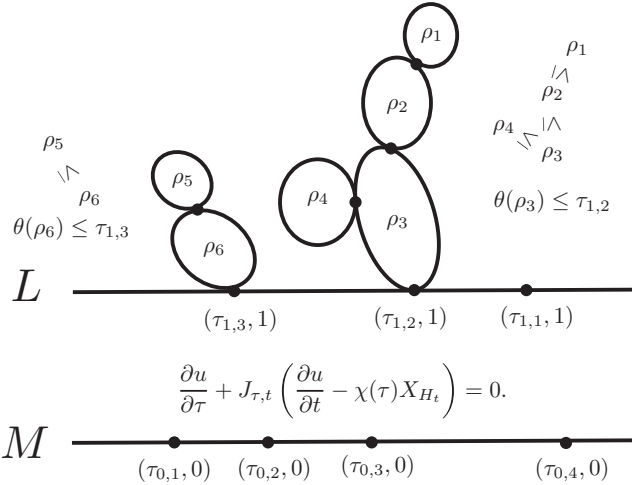

FIGURE 102. An element of $\mathring{\mathcal{M}}_{k_1, k_0}(L, L'; M; E; \mathcal{J}\mathcal{J}; \text{top}(\rho))$.

of (15.40) and (15.41) have the same virtual dimension that is independent of $k'_1, \{m_j\}, \{E_{1,j}\}, E_2$ but depends only on the total homology class of the map, and k_1, k_2 .

We also remark that the union includes the case when $m_j = 1$ and $E_{1,j} = 0$ for all j . In this case the fiber product of (15.40) and (15.41) is nothing but $\mathring{\mathcal{M}}_{k_1, k_0}(L, L'; M; E; \mathcal{J}\mathcal{J}; \text{top}(\rho))$.

Remark 15.28. We remark that $\mathring{\mathcal{M}}_{k_1, k_0}(L, L'; M; E; \mathcal{J}\mathcal{J}; \text{top}(\rho))$ contains several components with the same virtual dimension as $\mathring{\mathcal{M}}_{k_1, k_0}(L, L'; M; E; \mathcal{J}\mathcal{J}; \text{top}(\rho))$. So the subset $\mathring{\mathcal{M}}_{k_1, k_0}(L, L'; M; E; \mathcal{J}\mathcal{J}; \text{top}(\rho))$ may not be dense in the moduli space $\mathring{\mathcal{M}}_{k_1, k_0}(L, L'; M; E; \mathcal{J}\mathcal{J}; \text{top}(\rho))$ even in the case when all the elements are Fredholm regular.

The moduli space $\mathcal{M}_{k_1, k_0}(L, L'; M; E; \mathcal{J}\mathcal{J}; \text{top}(\rho))$ is the stable map compactification of $\overset{\circ}{\mathcal{M}}_{k_1, k_0}(L, L'; M; E; \mathcal{J}\mathcal{J}; \text{top}(\rho))$. The compactification is obtained by adding the following:

- (Bub.1) We include the case when the source curve has a sphere bubble.
- (Bub.2) We include the case when the source curve has a disk bubble at $t = 0$. (The disk bubble at $t = 1$ is already included when we take the fiber product in Definition 15.27.)
- (Bub.3) We include the case when the source curve splits into several pieces in the τ -direction. The cases when it splits into two pieces are depicted in Figures 99, 100.

The detail of this stable map compactification is written in [FOOO1, Subsection 5.3.1] and is now a routine. So we omit it here. (We remark that all the components corresponding to one of (Bub.1), (Bub.2), (Bub.3) have codimension ≥ 1 .)

We now study the boundary of the moduli space $\mathcal{M}_{k_1, k_0}(L, L'; M; E; \mathcal{J}\mathcal{J}; \text{top}(\rho))$. Case (I) in Proposition 15.22 (3) occurs at the point $((\xi_j), \xi_0)$ where one of the factors ξ_j of (15.40) lies in the boundary point of that factor. This corresponds to the case when some ρ_{α_i} is 0, where $\xi_j = ((\Sigma, \vec{z}), u, \gamma, \{\rho_{\alpha_i}\})$. This boundary corresponds to Proposition 15.17 (2) (15.4). Therefore this case is described by the fiber product (15.17). See Figure 97.

Note that the boundary which corresponds to Proposition 15.17 (2) (15.5) does not appear here. In fact (15.30) implies $\theta(\rho_i) \leq \tau_{1,i}$. Here $\rho_i, \tau_{1,i}$ are parts of the data of ξ_0 . Moreover by the definition of the fiber product appearing in Definition 15.27, we find $\rho_0(\xi_i) = \rho_i$. Therefore since θ is a diffeomorphism $\rho_0(\xi_i) = 1$ occurs only in the limit which we discuss in Case (IV).

Case (II) in Proposition 15.22 (3) occurs when a disk bubble occurs at $t = 0$, that is, (Bub.2). See Figure 98.

We remark that the situations of the bubbles at $t = 0$ and $t = 1$ are different. This is because the boundary conditions are different.

Case (III) in Proposition 15.22 (3) occurs when the domain splits into two pieces one of which moves to the direction $\tau \rightarrow -\infty$.

Note that in this limit some of the trees of disk bubbles at $t = 1$ may be attached to the piece which moves to the direction $\tau \rightarrow -\infty$. If such a tree of disk bubbles corresponds to ξ_i (that is, one of the factors of the fiber product (15.40) and the root of such piece is $(\tau_i, 1)$, then $\tau \rightarrow -\infty$. Therefore $\rho_0(\xi_i) = 0$. (In fact $\rho_0(\xi_i) \leq \text{ev}_{1,i}^{\text{detti}}(\xi)$, where ξ is an element of the factor (15.41).)

Therefore by definition this case is described by the fiber product (15.19). See Figure 99.

Case (IV) in Proposition 15.22 (3) occurs when the domain splits into two pieces one of which moves to the direction $\tau \rightarrow +\infty$.

Note that the piece which moves to the direction $\tau \rightarrow +\infty$ consists of a map from a strip $\mathbb{R} \times [0, 1]$ plus a union of trees of disk bubbles. The map $u_\infty : \mathbb{R} \times [0, 1] \rightarrow X$, which is a part of this map, satisfies the equation

$$\frac{\partial u_\infty}{\partial \tau} + ((\Phi^t)_*^{-1} J) \left(\frac{\partial u_\infty}{\partial t} - X_{H_t} \right) = 0, \quad (15.42)$$

together with the boundary condition $u_\infty(\tau, 0) \in M$ and $u_\infty(\tau, 1) \in L$. We put

$$v(\tau, t) = \Phi^t(u_\infty(\tau, t)). \quad (15.43)$$

Then (15.42) is equivalent to

$$\frac{\partial v}{\partial \tau} + J \frac{\partial v}{\partial t} = 0. \tag{15.44}$$

The corresponding boundary condition for v is $v(\tau, 0) \in M$ and $v(\tau, 1) \in L'$. This is the equation and the boundary condition which we used in the definition of $\mathcal{M}_{k_0, k_1}(L', M; E; J)$.

The trees of disk bubbles at $t = 1$ may be attached to the piece which moves to the direction $\tau \rightarrow +\infty$. Such a tree of disk bubbles corresponds to ξ_i , that is, one of the factors of the fiber product (15.40). Since $\text{ev}_{1,i}^{\text{detti}}$ can take any value between 0 and 1, there is no constraint on ρ_0 for ξ_i .

Therefore by definition this case is described by the fiber product of (15.20) and (15.21). See Figure 100.

We have thus checked that all the fiber products described by (I)(II)(III)(IV) in Proposition 15.22 (3) appear as boundary components of $\mathcal{M}_{k_1, k_0}(L, L'; M; E; \mathcal{J}\mathcal{J}; \text{top}(\rho))$. To show that all other potential boundary components cancel out each other, the most important point to observe is the following. We consider the case when a disk bubble occurs at $t = 1$ for a limit of a sequence of elements of $\overset{\circ}{\mathcal{M}}_{0, k_0}(L, L'; M; E; \mathcal{J}\mathcal{J}; \text{top}(\rho))$. Let E_1 be the energy of the disk bubble. The set of elements of the compactification $\overset{\circ}{\mathcal{M}}_{0, k_0}(L, L'; M; E; \mathcal{J}\mathcal{J}; \text{top}(\rho))$ corresponding to such a disk bubble is described by the pair $(\xi, \mathfrak{r}, \rho_1)$ where

(DB.1) $\xi \in \mathcal{M}_{0+1}(L; E_1; J^{(\rho_1)})$.

(DB.2) $\mathfrak{r} \in \overset{\circ}{\mathcal{M}}_{1, k_0}(L, L'; M; E_2; \mathcal{J}\mathcal{J}; \text{top}(\rho))$.

(DB.3) $(\theta(\rho_1), 1)$ is the (unique) boundary marked point of the element \mathfrak{r} .

(DB.4) $\rho_0(\xi) = \rho_1$. Here $\rho_0 : \mathcal{M}_{0+1}(L; E_1; J^{(\rho_1)}) \rightarrow [0, 1]$ is as in (15.6).

(DB.5) $\text{ev}_0(\xi) = \text{ev}_{1,i}(\mathfrak{r})$.

See Figure 103 below. We remark that the disk bubble at $(\tau, 1)$ is identified with

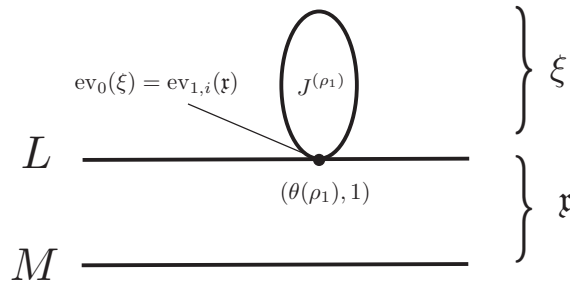

FIGURE 103. An element $(\xi, \mathfrak{r}, \rho_1)$.

an element of $\mathcal{M}_{0+1}(L; E_1; J^{(\rho(\tau))})$.

We next consider the fiber product

$$\mathcal{M}_{0+1}(L; \mathcal{J}; E_1; \text{top}(\rho)) \times_{(\text{ev}_{0, \rho_0}) \times_{(\text{ev}_{1,1}, \text{ev}_{1,1}^{\text{detti}})}} \overset{\circ}{\mathcal{M}}_{1, k_0}(L, L'; M; E_2; \mathcal{J}\mathcal{J}; \text{top}(\rho)). \tag{15.45}$$

This is a part of $\overset{\circ}{\mathcal{M}}_{0, k_0}(L, L'; M; E; \mathcal{J}\mathcal{J}; \text{top}(\rho))$ defined in Definition 15.27. We consider a part of the boundary of $\overset{\circ}{\mathcal{M}}_{1, k_0}(L, L'; M; E_2; \mathcal{J}\mathcal{J}; \text{top}(\rho))$ which consists

of $((\mathbb{R} \times [0, 1]; z_{0,1}, \vec{z}_1); u; \gamma; \vec{\rho})$ such that $z_{0,1} = \rho_1$. This is the case when the equality holds in the inequality (15.30). (See Figure 104.)

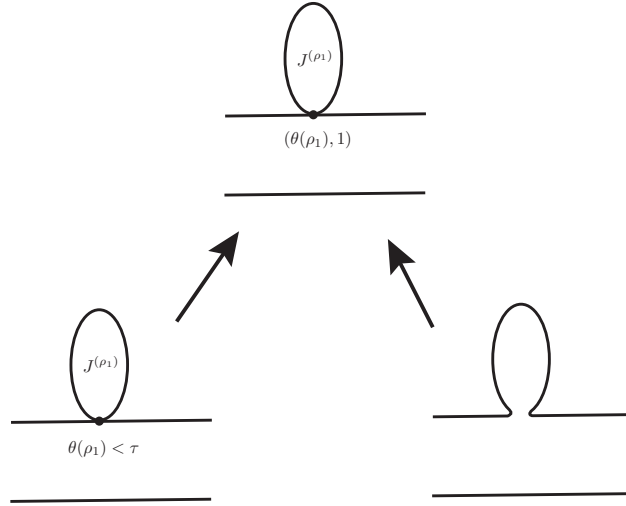

FIGURE 104. Cancellation at $(\xi, \mathfrak{r}, \rho_1)$.

Now it is easy to see that the part of the boundary of (15.45) which we describe above cancels with the part of the boundary corresponding to the disk bubble at $t = 1$, which we describe by (DB.1),(DB.2),(DB.3),(DB.4),(DB.5).

In a similar way we can show that all the potential boundaries of the moduli space $\mathcal{M}_{1,k_0}(L, L'; M; E_2; \mathcal{J}\mathcal{J}; \text{top}(\rho))$ other than those spelled out in Proposition 15.22 (3) (I)-(IV) cancel each other.

The proof of Proposition 15.22 is complete. \square

We use the next energy estimate which is due to Chekanov [Che1]. (See also [FOOO5, Section 5].) From now on we will assume $\int_X H_t \omega^n = 0$ and $\int_X \omega^n = 1$. We put

$$\|H\|_+ = \int_0^1 \sup(H_t) dt, \quad \|H\|_- = - \int_0^1 \inf(H_t) dt. \quad (15.46)$$

They are non-negative numbers. We remark that the Hofer distance [Ho] from Φ to identity is the infimum of $\|H\|_- + \|H\|_+$ for all H with $\Phi_H^1 = \Phi$.

Lemma 15.29. *If $\mathcal{M}_{k_1,k_0}(L, L'; M; E; \mathcal{J}\mathcal{J}; \text{top}(\rho))$ is nonempty then*

$$E \geq -\|H\|_-.$$

\diamond

Proof. We remark $u^* \omega = \omega(\frac{\partial u}{\partial \tau}, \frac{\partial u}{\partial t}) d\tau \wedge dt$. By Equation (15.28) we have

$$\begin{aligned} \omega \left(\frac{\partial u}{\partial \tau}, \frac{\partial u}{\partial t} \right) &= -\omega \left(J_{\tau,t} \left(\frac{\partial u}{\partial \tau} \right) + \chi(\tau) X_{H_t}, \frac{\partial u}{\partial \tau} \right) \\ &= g \left(\frac{\partial u}{\partial \tau}, \frac{\partial u}{\partial \tau} \right) - \chi(\tau) \frac{\partial(H \circ u)}{\partial \tau}. \end{aligned}$$

Therefore

$$\begin{aligned} \int_{\mathbb{R} \times [0,1]} u^* \omega &\geq - \int_{\mathbb{R} \times [0,1]} \chi(\tau) \frac{\partial(H \circ u)}{\partial \tau} d\tau dt \\ &\geq + \int_{\mathbb{R} \times [0,1]} \frac{\partial \chi}{\partial \tau} (H \circ u) d\tau dt - \lim_{\tau \rightarrow +\infty} \int_{[0,1]} H(t, u(\tau, t)) dt \\ &\geq -\|H\|_- - \lim_{\tau \rightarrow +\infty} \int_{[0,1]} H(t, u(\tau, t)) dt. \end{aligned}$$

Here the first inequality is a consequence of positivity of the Riemannian metric g , the second equality is proved by integration by parts, and the third inequality follows from the definition of $\|H\|_-$.

We remark that the energy E is defined in Definition 15.26 (5).

The lemma follows. \square

Remark 15.30. When we identified the solution space of the equation (15.42) with the moduli space $\mathcal{M}_{k_0, k_1}(L', M; E; J)$, we identify $u : \mathbb{R} \times [0, 1] \rightarrow X$ with $v : \mathbb{R} \times [0, 1] \rightarrow X$ by

$$v(\tau, t) = \Phi^t(u_\infty(\tau, t)).$$

The term $\lim_{\tau \rightarrow +\infty} \int_{[0,1]} H(t, u(\tau, t)) dt$ which appear in the definition of the energy E and the above calculation is related to this point. In fact for a solution u of Equation (15.42) we define its energy by

$$\int_{\mathbb{R} \times [0,1]} u^* \omega + \lim_{\tau \rightarrow +\infty} \int_{[0,1]} H(t, u(\tau, t)) dt - \lim_{\tau \rightarrow -\infty} \int_{[0,1]} H(t, u(\tau, t)) dt.$$

The third term is 0 in our case.

Note that Equation (15.42) is regarded as a gradient flow equation of certain action functional and the above energy is the difference between values of action functional at $\tau = +\infty$ and $\tau = -\infty$. \diamond

We define

$$\varphi_{k_1, k_0} : B_{k_1} CF[1](L) \otimes CF(L; M) \otimes B_{k_0} CF[1](M) \rightarrow CF(L'; M) \otimes_{\Lambda_0} \Lambda$$

by

$$\begin{aligned} &\varphi_{k_1, k_0}(h_{1,1}, \dots, h_{1, k_1}; h; h_{0,1}, \dots, h_{0, k_0}) \\ &= \sum_E T^E \text{ev}_{+\infty}! (\text{ev}_{1,1}^* h_{1,1} \wedge \dots \wedge \text{ev}_{1, k_1}^* h_{1, k_1} \wedge \text{ev}_{-\infty}^* h \\ &\quad \wedge \text{ev}_{0,1}^* h_{0,1} \wedge \dots \wedge \text{ev}_{0, k_0}^* h_{0, k_0}; \mathcal{M}_{k_1, k_0}(L, L'; M; E; \mathcal{J}\mathcal{J}; \text{top}(\rho)), \widehat{\mathfrak{S}}^\epsilon). \end{aligned} \tag{15.47}$$

Lemma 15.31. $\{\varphi_{k_1, k_0}\}$ is a filtered A_∞ $CF(L)$ - $CF(M)$ bi-module homomorphism over the filtered A_∞ homomorphisms $\mathfrak{g} : CF(L) \rightarrow CF(L')$ and $\text{id} : CF(M) \rightarrow CF(M)$. $^{65}\diamond$

Proof. This is a consequence of Proposition 15.22 together with Stokes' formula ([FOOO10, FOOO13, Proposition 9.26]) and the composition formula ([FOOO10, FOOO13, Theorem 10.20]). In fact the boundaries of type (I), (II), (III), (IV) corresponds to (15.48), (15.49), (15.50) and (15.51) below, respectively.

$$\varphi_{k_1, k_0, 2}(h_{1,1}, \dots, h_{1, k_1}; h; h_{0,1}, \dots, \mathfrak{m}_{k_0, 1}(h_{0,i}, \dots, h_{0, i+k_0, 1-1}), \dots, h_{0, k_0}), \tag{15.48}$$

⁶⁵See [FOOO1, Definition 3.7.7] for the definition of A_∞ bi-module homomorphism over a pair of A_∞ homomorphisms.

$$\varphi_{k_{1,2},k_0}(h_{1,1}, \dots, \mathbf{m}_{k_{1,1}}(h_{1,i}, \dots, h_{1,i+k_{1,1}-1}), \dots, h_{1,k_0}; h; h_{0,1}, \dots, h_{0,k_0}), \quad (15.49)$$

$$\begin{aligned} \varphi_{k_{1,2},k_{0,2}}(h_{1,1}, \dots, \\ \mathbf{n}_{k_{1,1},k_{0,1}}(h_{1,k_{1,2}-1}, \dots, h_{1,k_1}; h; h_{0,1}, \dots, h_{0,k_{0,1}}), \dots, h_{0,k_0}), \end{aligned} \quad (15.50)$$

$$\begin{aligned} \mathbf{n}_{k_{1,2},k_{0,2}}(\mathbf{g}_{m_1}(h_{1,1}, \dots, h_{1,m_1}), \dots, \mathbf{g}_{m_\ell}(h_{1,k_{1,2}-m_\ell+1}, \dots, h_{1,k_{1,2}}), \\ \varphi_{k_{1,2},k_{0,1}}(h_{1,k_{1,2}+1}, \dots, h_{1,k_1}; h; h_{0,1}, \dots, h_{0,k_{0,2}}), \dots, h_{0,k_2}). \end{aligned} \quad (15.51)$$

Here in (15.51) we put $k_{1,2} = \sum_{j=1}^\ell m_j$. (Note $k_{1,1} + k_{1,2} = k_1$.) \square

Note that the filtered A_∞ bi-module structure etc. appearing in Lemma 15.31 are curved.

We define

$$\psi_m : CF(L; M) \otimes B_m CF[1](M) \rightarrow CF(L'; M) \otimes_{\Lambda_0} \Lambda$$

by

$$\begin{aligned} \psi_m(h; h_1, \dots, h_m) \\ = \sum_{k_0=0}^{\infty} \sum_{k_{1,0}=0}^{\infty} \cdots \sum_{k_{1,m}=0}^{\infty} \varphi_{k_0, k_1 + \sum_{i=0}^m k_{1,i}}(b_L^{k_0}; h; b_M^{k_{1,0}} h_1 \cdots h_k b_M^{k_{1,m}}). \end{aligned} \quad (15.52)$$

Lemma 15.31 now implies the following. We use b_M and b_L to define a strict and unital filtered A_∞ $(CF(M), \{\mathbf{m}_k^{b_M}\})$ right module structure on $CF(L; M)$. We use b_M and $b_{L'}$ to define a strict and unital filtered A_∞ $(CF(M), \{\mathbf{m}_k^{b_M}\})$ right module structure on $CF(L'; M)$.

Lemma 15.32. $\{\psi_m \mid m = 0, 1, 2, \dots\}$ define a strict and unital right filtered A_∞ module homomorphism: $CF(L; M) \otimes_{\Lambda_0} \Lambda \rightarrow CF(L'; M) \otimes_{\Lambda_0} \Lambda$. \diamond

Lemma 15.29 implies the next lemma.

Lemma 15.33. $\{T^{\|H\|+\psi_m} \mid m = 0, 1, 2, \dots\}$ define a strict and unital right filtered A_∞ module homomorphism: $CF(L; M) \rightarrow CF(L'; M)$. \diamond

By exchanging the role of L' and L we obtain the following.

Lemma 15.34. There exists $\{\psi'_m \mid m = 0, 1, 2, \dots\}$ which define a strict and unital left filtered A_∞ module homomorphism: $CF(L'; M) \otimes_{\Lambda_0} \Lambda \rightarrow CF(L; M) \otimes_{\Lambda_0} \Lambda$.

Moreover $\{T^{\|\Phi\|-\psi'_m} \mid m = 0, 1, 2, \dots\}$ define a strict and unital left filtered A_∞ module homomorphism: $CF(L'; M) \rightarrow CF(L; M)$. \diamond

We put $\psi = \{\psi_m \mid m = 0, 1, 2, \dots\}$ and $\psi' = \{\psi'_m \mid m = 0, 1, 2, \dots\}$. We can use a similar argument (one parameter version) to show that there exists a strict and unital filtered A_∞ pre-natural transformations ϕ and ϕ' such that

$$\begin{aligned} \psi' \circ \psi - \mathbf{m}_1(\phi) &= \text{identity} \\ \psi \circ \psi' - \mathbf{m}_1(\phi') &= \text{identity}. \end{aligned}$$

Moreover $T^{\|H\|+\|\psi\|-\phi}$ determines pre-natural transformation $CF(L; M) \rightarrow CF(L; M)$ and Moreover $T^{\|H\|+\|\psi'\|-\phi'}$ determines pre-natural transformation $CF(L'; M) \rightarrow CF(L'; M)$. We omit the detail of the proof of this statement. See [FOOO1, Subsections 5.3.3 and 5.3.4] and [FOOO5, Lemma 6.4] for the proof of this part. (The way to adapt the argument there to the current situation is the same as the way we do so for ψ which we explained in detail above.)

We thus proved that $CF(L'; M)$ is equivalent to $CF(L; M)$ over Λ in the category of right $CF(M)$ module. This proves Theorem 15.5 (2).

To prove Theorem 15.5 (3) it suffices to recall that the infimum of $\|H\|_+ + \|H\|_-$ over all H which generates the Hamiltonian diffeomorphism Φ is nothing but the Hofer distance between Φ and the identity map.

The proof of Theorem 15.5 is now complete. □

15.6. Completion by Hofer distance. In [FOOO1, Subsection 6.5.4] we proved that if $\mathbf{c}_i, \mathbf{c}_{i'}$ are Cauchy sequences of objects of a strict filtered A_∞ category \mathcal{C} with respect to the Hofer distance d_H , then we can define an inductive limit

$$\lim_{i \rightarrow \infty} HF(\mathbf{c}_i, \mathbf{c}_{i'}) \tag{15.53}$$

as Λ_0 modules. Namely we consider the \mathfrak{m}_1 cohomology $HF(\mathbf{c}_i, \mathbf{c}_{i'})$ and write it as

$$HF(\mathbf{c}_i, \mathbf{c}_{i'}) = \Lambda_0^n \oplus \bigoplus_{j=1}^{k_i} \frac{\Lambda_0}{T^{\lambda_{i,j}} \Lambda_0}$$

Here $\lambda_{i,j}$ are positive numbers such that $\lambda_{i,j} \geq \lambda_{i,j+1}$.⁶⁶ In fact $d_H(\mathbf{c}_i, \mathbf{c}_j) < \infty$ the rank n is independent of i . The torsion exponent $\lambda_{i,j}$ is one Lipschitz by [FOOO1, Theorem 6.1.25] and [FOOO5, Theorem 6.2]. We use it to define the inductive limit (15.53). The inductive limit (15.53) has a form

$$\lim_{i \rightarrow \infty} HF(\mathbf{c}_i, \mathbf{c}_{i'}) = \Lambda_0^n \oplus \bigoplus \frac{\Lambda_0}{T^{\lambda_j} \Lambda_0} \tag{15.54}$$

Here the direct sum in the second factor may be infinite sum with $\lim_{j \rightarrow \infty} \lambda_j \rightarrow 0$. See [FOOO1, Proposition 6.5.38] and [FOOO1, Example 6.5.40]. It seems likely that we can prove the next conjecture purely algebraically.

Conjecture 15.35. *The A_∞ operations \mathfrak{m}_k extend ‘continuously’ to the limit (15.54) and define a ‘filtered A_∞ category’ whose object is a Cauchy sequence of $\mathfrak{D}\mathfrak{B}(\mathcal{C})$. \diamond*

Remark 15.36. Conjecture 15.35 appeared in the preprint version of this paper in 2017. A version of its positive answer is now given in [Fu13]. \diamond

One reason why proving Conjecture 15.35, taking completion of $\mathfrak{D}\mathfrak{B}(\mathcal{C})$ and trying to find a filtered A_∞ category whose object is an element of such a completion, could be interesting is as follows. In this paper we consider only a set of Lagrangian submanifolds L_1, L_{12} etc. which satisfy certain ‘clean intersection’ properties. If L_1 and L_{12} do not necessary have clean intersection the geometric transformation of L_1 by L_{12} may not exist. However Theorem 15.5 implies that it exists as an object of a certain completion of $\mathfrak{Futst}(X_2)$. So by taking the completion with respect to the Hofer distance we may take the geometric transformation and the composition of Lagrangian correspondences without assuming any kinds of transversality or clean-ness of the Lagrangian submanifolds involved.

⁶⁶See [FOOO1, Theorem 6.1.20].

16. KÜNNETH BI-FUNCTOR REVISITED

16.1. Tensor product of filtered A_∞ categories. We begin with defining the tensor product of filtered A_∞ categories. There are various works such as [KS, Am1, MS, SU] etc. on this subject. We describe it using the notion of filtered A_∞ bi-functor. We remark that in this section, we use the sign convention of the filtered A_∞ multi-module so that its element v contributes $\deg' v$ to the sign. This convention is different from one we used in Section 10, where the contribution is $\deg v$.

Remark 16.1. In this section we always assume the ground ring R is a field. We also assume that filtered A_∞ categories are always gapped. Moreover for two objects c, c' of \mathcal{C} we assume that the $\bar{\mathfrak{m}}_1$ cohomology $H(\mathcal{C}(c, c'); \bar{\mathfrak{m}}_1)$ is finitely generated. (It is then a finite direct sum of Λ_0 .)

Under this assumption the cohomology $H(\mathcal{C}(c, c'); \mathfrak{m}_1)$ is isomorphic to a direct sum of finitely many copies of Λ_0 or $\Lambda_0/T^a\Lambda_0$. ([FOOO1, Proposition 6.3.14].) Using this fact, cohomology of completed tensor product behaves in the same way as the case of usual tensor product over Dedekind ring. In fact

$$\frac{\Lambda_0}{T^a\Lambda_0} \widehat{\otimes} \frac{\Lambda_0}{T^b\Lambda_0} = \frac{\Lambda_0}{T^a\Lambda_0},$$

$$\mathrm{Tor}\left(\frac{\Lambda_0}{T^a\Lambda_0}, \frac{\Lambda_0}{T^b\Lambda_0}\right) = \frac{\Lambda_0}{T^a\Lambda_0},$$

if $a \leq b$. \diamond

It seems that the construction of the tensor product below is a category version of one suggested by Kontsevich and Soibelman [KS, page 174 line 6].

Let \mathcal{C}_i be a unital filtered A_∞ category for $i = 1, 2$. There are 2 versions of the story of tensor products of filtered A_∞ categories, that are, strict and G -gapped versions. Let

$$\mathcal{BIFUNC}(\mathcal{C}_1^{\mathrm{op}} \times \mathcal{C}_2^{\mathrm{op}}; \mathcal{CH})$$

be the filtered A_∞ category whose objects are filtered A_∞ bi-functors $\mathcal{C}_1^{\mathrm{op}} \times \mathcal{C}_2^{\mathrm{op}} \rightarrow \mathcal{CH}$. We require objects of \mathcal{BIFUNC} to be strict (resp. G -gapped). In other words it is a category of left $\mathcal{C}_1, \mathcal{C}_2$ bimodules. ⁶⁷

Lemma 16.2. *There exists a strict (resp. G -gapped) and unital filtered A_∞ bi-functor*

$$\mathfrak{BYDN} : \mathcal{C}_1 \times \mathcal{C}_2 \rightarrow \mathcal{BIFUNC}(\mathcal{C}_1^{\mathrm{op}} \times \mathcal{C}_2^{\mathrm{op}}; \mathcal{CH}).$$

\diamond

Definition 16.3. We call \mathfrak{BYDN} the A_∞ bi-Yoneda functor. \diamond

Proof. We discuss the strict case. The construction of G -gapped case is similar. Let $\mathfrak{c} = (c_1, c_2)$ be an objects of $\mathcal{C}_1 \times \mathcal{C}_2$ (Namely $c_i \in \mathfrak{DB}(\mathcal{C}_i)$.) We construct

$$\mathfrak{BYon}(\mathfrak{c}) : \mathcal{C}_1^{\mathrm{op}} \times \mathcal{C}_2^{\mathrm{op}} \rightarrow \mathcal{CH}.$$

Let $\mathfrak{b} = (b_1, b_2)$ be an object of $\mathcal{C}_1^{\mathrm{op}} \times \mathcal{C}_2^{\mathrm{op}}$.

We define

$$\mathfrak{BYon}_{ob}(\mathfrak{c})(\mathfrak{b}) = \mathcal{C}_1(b_1, c_1) \widehat{\otimes} \mathcal{C}_2(b_2, c_2)$$

⁶⁷In the gapped case we use the language of left filtered A_∞ modules.

which is a chain complex. This is the object part. We next define

$$\begin{aligned} \mathfrak{BiYon}_{k_1, k_2}(\mathbf{c}) &: B_{k_1} \mathcal{C}_1^{\text{op}}[1](b_{1,1}, b_{1,2}) \widehat{\otimes} B_{k_2}^{\text{op}} \mathcal{C}_2[1](b_{2,1}, b_{2,2}) \\ &\rightarrow \text{Hom}(\mathcal{C}_1(b_{1,1}, c_1) \widehat{\otimes} \mathcal{C}_2(b_{1,2}, c_2), \mathcal{C}_1(b_{2,1}, c_1) \widehat{\otimes} \mathcal{C}_2(b_{2,1}, c_2)). \end{aligned}$$

If $k_1 \neq 0$ and $k_2 \neq 0$ we put $\mathfrak{BiYon}_{k_1, k_2}(\mathbf{c}) = 0$. Otherwise we define

$$\begin{aligned} \mathfrak{BiYon}_{k_1, 0}(\mathbf{c})(\mathbf{x}_1 \otimes 1)(z_1 \otimes z_2) &= (-1)^{*1} \mathbf{m}(\mathbf{x}_1^{\text{op}}, z_1) \otimes z_2 \\ \mathfrak{BiYon}_{0, k_2}(\mathbf{c})(1 \otimes \mathbf{x}_2)(z_1 \otimes z_2) &= (-1)^{*2} z_1 \otimes \mathbf{m}(\mathbf{x}_2^{\text{op}}, z_2). \end{aligned} \quad (16.1)$$

Here

$$*1 = \epsilon(\mathbf{x}_1), \quad *2 = \epsilon(\mathbf{x}_2) + (1 + \deg' \mathbf{x}_2) \deg' y_1$$

are Koszul sign. (The symbol $\epsilon(\mathbf{x})$ is defined in (2.16).) It is easy to check that $\mathfrak{BiYon}(\mathbf{c}) = (\mathfrak{BiYon}_{ob}(\mathbf{c}), \{\mathfrak{BiYon}_{k_1, k_2}(\mathbf{c})\})$ becomes a filtered A_∞ bi-functor. (The calculation is similar to [Fu7, page 93], which is the case of usual Yoneda functor.)

We thus constructed the object part of bi-Yoneda functor. We next construct its morphism part. Let $\mathbf{c}_i = (c_{i,1}, c_{i,2})$ be an element of $\mathfrak{DB}(\mathcal{C}_1) \times \mathfrak{DB}(\mathcal{C}_2)$ for $i = 1, 2$. We denote by

$$(\mathbf{C}(\mathbf{c}_1, \mathbf{c}_2), d)$$

the complex of all pre-natural transformations from $\mathfrak{BiYon}_{ob}(\mathbf{c}_1)$ to $\mathfrak{BiYon}_{ob}(\mathbf{c}_2)$. We define the product

$$\circ : \mathbf{C}(\mathbf{c}_1, \mathbf{c}_2) \otimes \mathbf{C}(\mathbf{c}_2, \mathbf{c}_3) \rightarrow \mathbf{C}(\mathbf{c}_1, \mathbf{c}_3).$$

by the composition of pre-natural transformations. We thus obtain a DG-category (\mathbf{C}, d, \circ) . (We use the fact \mathcal{CH} is not only an A_∞ category but also DG-category to obtain this DG category.) We regard it as an A_∞ category.

We now define a filtered map:

$$\mathfrak{BiYon}_{\ell_1, \ell_2} : B_{\ell_1} \mathcal{C}_1[1](c_{1,1}, c_{1,2}) \otimes B_{\ell_2} \mathcal{C}_2[1](c_{2,1}, c_{2,2}) \rightarrow \mathbf{C}(\mathbf{c}_1, \mathbf{c}_2).$$

Let $\mathbf{b}_i = (b_{i,1}, b_{i,2})$, $\mathbf{c}_i = (c_{i,1}, c_{i,2})$ an element of $\mathfrak{DB}(\mathcal{C}_1) \times \mathfrak{DB}(\mathcal{C}_2)$ $i = 1, 2$. Let

$$\begin{aligned} (\mathbf{x}_1 \otimes \mathbf{x}_2) &\in B_{k_1} \mathcal{C}_1^{\text{op}}[1](b_{1,1}, b_{2,1}) \widehat{\otimes} B_{k_2} \mathcal{C}_2^{\text{op}}[1](b_{1,2}, b_{2,2}), \\ (\mathbf{y}_1 \otimes \mathbf{y}_2) &\in B_{\ell_1} \mathcal{C}_1[1](c_{1,1}, c_{2,1}) \widehat{\otimes} B_{\ell_2} \mathcal{C}_2[1](c_{1,2}, c_{2,2}). \end{aligned} \quad (16.2)$$

and $(z_1, z_2) \in \mathcal{F}(\mathbf{c}_1)_{ob}(\mathbf{b}_2)$. We define

$$((\mathfrak{BiYon}_{\ell_1, \ell_2}(\mathbf{y}_1 \otimes \mathbf{y}_2)_{k_1, k_2})(\mathbf{x}_1 \otimes \mathbf{x}_2))(z_1, z_2) = 0 \quad (16.3)$$

if $(k_1, \ell_1) \neq (0, 0)$ and $(k_2, \ell_2) \neq (0, 0)$. In case either $(k_1, \ell_1) = (0, 0)$ or $(k_2, \ell_2) = (0, 0)$ we define

$$\begin{aligned} &((\mathfrak{BiYon}_{\ell_1, 0}(\mathbf{y}_1 \otimes 1)_{k_1, 0})(\mathbf{x}_1 \otimes 1))(z_1, z_2) \\ &= (-1)^{*1} \mathbf{m}(\mathbf{x}_1^{\text{op}}, z_1, \mathbf{y}_1) \otimes z_2 \in \mathcal{C}_1(b_{1,1}, c_{2,1}) \widehat{\otimes} \mathcal{C}_2(b_{1,2}, c_{2,2}) \end{aligned} \quad (16.4)$$

(Note that $b_{1,2} = b_{2,2}$, $c_{1,2} = c_{2,2}$ in this case.) and

$$\begin{aligned} &((\mathfrak{BiYon}_{0, \ell_2}(1 \otimes \mathbf{y}_2)_{0, k_2})(1 \otimes \mathbf{x}_2))(z_1, z_2) \\ &= (-1)^{*2} z_1 \otimes \mathbf{m}(\mathbf{x}_2^{\text{op}}, z_2, \mathbf{y}_2) \in \mathcal{C}_1(b_{1,1}, c_{2,1}) \widehat{\otimes} \mathcal{C}_2(b_{1,2}, c_{2,2}). \end{aligned} \quad (16.5)$$

(Note that $b_{1,1} = b_{2,1}$, $c_{1,1} = c_{2,1}$ in this case.) Here $*_i$ is the Koszul sign, that is

$$\begin{aligned} *1 &= \epsilon(\mathbf{x}_1) + (\deg' z_1 + \deg' \mathbf{x}_1) \deg' \mathbf{y}_1, \\ *2 &= \epsilon(\mathbf{x}_2) + \deg' \mathbf{y}_2 (\deg' \mathbf{x}_2 + \deg' z_1 + \deg' z_2) + \deg' z_1 (\deg' \mathbf{x}_2 + 1). \end{aligned}$$

Sublemma 16.4. (16.4) and (16.5) define filtered A_∞ bi-functor. \diamond

The proof is a straightforward calculation similar to the proof of [Fu7, Lemma 9.8] and so is omitted. The proof of Lemma 16.2 is complete. \square

Definition 16.5. Let \mathcal{C}_1 and \mathcal{C}_2 be unital filtered A_∞ categories. We define the full subcategory of $BIFUNC(\mathcal{C}_1^{\text{op}} \times \mathcal{C}_2^{\text{op}}; \mathcal{CH})$ whose objects are image of the bi-Yoneda functor the *tensor product* of \mathcal{C}_1 and \mathcal{C}_2 and write $\mathcal{C}_1 \otimes \mathcal{C}_2$

By definition there exists a strict and unital filtered A_∞ bi-functor $\mathcal{C}_1 \times \mathcal{C}_2 \rightarrow \mathcal{C}_1 \otimes \mathcal{C}_2$.

It is easy to show that $\mathcal{C}_1 \otimes \mathcal{C}_2$ is homotopy equivalent to $\mathcal{C}'_1 \otimes \mathcal{C}'_2$ if \mathcal{C}_i is homotopy equivalent to \mathcal{C}'_i .

Lemma 16.6. *Suppose $\mathcal{C}_1, \mathcal{C}_2$ are DG-categories. Then the tensor product as filtered A_∞ category $\mathcal{C}_1 \otimes \mathcal{C}_2$ is homotopy equivalent to the (DG-category) tensor product $\mathcal{C}_1 \otimes \mathcal{C}_2$ as filtered A_∞ categories.*

We prove Lemma 16.6 in Subsection 16.4. Lemma 16.6 implies that the tensor product defined in [Am1, DL] etc. is the tensor product in the sense of Definition 16.5.

We put $\mathbf{C} = \mathcal{C}_1 \otimes \mathcal{C}_2$. Note that by construction there exists a left $\mathcal{C}_1, \mathcal{C}_2$ and right \mathbf{C} , filtered A_∞ tri-module $\mathbf{M}(\mathcal{C}_1, \mathcal{C}_2; \mathbf{C})$, and left \mathbf{C} right $\mathcal{C}_1, \mathcal{C}_2$ tri-module $\mathbf{M}(\mathbf{C}; \mathcal{C}_1, \mathcal{C}_2)$, as follows. Let $\mathbf{c} = (c_1, c_2) \in \mathfrak{DB}(\mathcal{C}_1) \times \mathfrak{DB}(\mathcal{C}_2)$, $\mathbf{b} = (b_1, b_2) \in \mathfrak{DB}(\mathbf{C}) = \mathfrak{DB}(\mathcal{C}_1) \times \mathfrak{DB}(\mathcal{C}_2)$. Then we put:

$$\begin{aligned} \mathbf{M}(\mathcal{C}_1, \mathcal{C}_2; \mathbf{C})(c_1, c_2; \mathbf{b}) &= \mathcal{C}_1[1](c_1, b_1) \otimes \mathcal{C}_2[1](c_2, b_2), \\ \mathbf{M}(\mathbf{C}; \mathcal{C}_1, \mathcal{C}_2)(\mathbf{b}; c_1, c_2) &= \mathcal{C}_1[1](b_1, c_1) \otimes \mathcal{C}_2[1](b_2, c_2). \end{aligned} \quad (16.6)$$

This is the object part of our tri-module. The morphism part is defined as follows. Let $\mathcal{T} \in \mathbf{C}(\mathbf{b}_1, \mathbf{b}_2)$ and $\mathbf{T} \in B_k \mathbf{C}(\mathbf{b}_1, \mathbf{b}_2)$. Let $\mathbf{x}_1 \otimes \mathbf{x}_2$ be as in (16.2). Let $(z_1, z_2) \in \mathcal{C}_1[1](c_{2,1}, b_{1,1}) \otimes \mathcal{C}_2[1](c_{2,2}, b_{1,2}) = \mathbf{M}(\mathcal{C}_1, \mathcal{C}_2; \mathbf{C})(c_{2,1}, c_{2,2}; \mathbf{b}_1)$. Now we define the bi-module structure $\mathbf{n}_{\ell_1, \ell_2; k}$ as

$$\mathbf{n}_{\ell_1, \ell_2; k}(\mathbf{x}_1 \otimes \mathbf{x}_2; (z_1, z_2); \mathbf{T}) \in \mathbf{M}(\mathcal{C}_1, \mathcal{C}_2; \mathbf{C})(c_{1,1}, c_{1,2}; \mathbf{b}_2) \quad (16.7)$$

where (16.7) = 0 unless $(\ell_1, \ell_2; k) = (\ell_1, 0; 0)$, $(\ell_1, \ell_2; k) = (0, \ell_2; 0)$, or $k = 1$. In case $k = 1$ we define

$$(16.7) = (-1)^{\text{deg}' \mathcal{T}_{\ell_1, \ell_2}(\text{deg}' \mathbf{x}_1 + \text{deg}' \mathbf{x}_2 + \text{deg}' z_1 + \text{deg}' z_2)} \mathcal{T}_{\ell_1, \ell_2}(\mathbf{x}_1 \otimes \mathbf{x}_2)(z_1, z_2). \quad (16.8)$$

Here $\mathbf{T} = \mathcal{T}$ is a pre-natural transformation. In case $k = 0$ the structure $\mathbf{n}_{\ell_1, \ell_2; k}$ is nothing but the left filtered A_∞ module structure over $\mathcal{C}_1, \mathcal{C}_2$, which is nothing but the filtered A_∞ bi-functor $\mathcal{C}_1^{\text{op}} \times \mathcal{C}_2^{\text{op}} \rightarrow \mathcal{CH}$. More explicitly it is:

$$\begin{aligned} \mathbf{n}_{\ell_1, 0; 0}(\mathbf{x}_1 \otimes \mathbf{1}; (z_1, z_2); \mathbf{1}) &= \mathbf{m}(\mathbf{x}_1, z_1) \otimes z_2, \\ \mathbf{n}_{0, \ell_2; 0}(\mathbf{1} \otimes \mathbf{x}_2; (z_1, z_2); \mathbf{1}) &= (-1)^* z_1 \otimes \mathbf{m}(\mathbf{x}_2, z_2), \end{aligned} \quad (16.9)$$

with $*$ = $(\text{deg}' \mathbf{x}_2 + 1) \text{deg}' z_1$.

The definition of tri-module structure on $\mathbf{M}(\mathbf{C}; \mathcal{C}_1, \mathcal{C}_2)$ is similar.

By the definition of a pre-natural transformation, the composition and the differential, it is straightforward to check that (16.6)-(16.9) define filtered A_∞ tri-module structure. (We remark that \mathbf{C} is a DG-category because \mathcal{CH} is a DG-category.)

We next define a filtered A_∞ bi-module $\mathbf{M}(\mathbf{C}; \mathbf{C})$ over $\mathbf{C} \times \mathbf{C}$ as follows.

$$\mathbf{M}(\mathbf{C}; \mathbf{C})(\mathbf{c}, \mathbf{b}) = \mathbf{C}(\mathbf{c}, \mathbf{b}).$$

and the structure operations of the bi-moduli structure are given by the structure operation of the filtered A_∞ category \mathbf{C} . (This is actually a DG bi-module.) Using

A_∞ bi-functor $\mathcal{C}_1 \times \mathcal{C}_2 \rightarrow \mathbf{C}$ we regard $\mathbf{M}(\mathbf{C}; \mathbf{C})$ as a left $\mathcal{C}_1, \mathcal{C}_2$ and right \mathbf{C} A_∞ tri-modules or left \mathbf{C} and right $\mathcal{C}_1, \mathcal{C}_2$ A_∞ tri-module.

Lemma 16.7. *There exists a homotopy equivalence*

$$\mathbf{M}(\mathbf{C}; \mathbf{C}) \sim \mathbf{M}(\mathcal{C}_1, \mathcal{C}_2; \mathbf{C})$$

as left $\mathcal{C}_1, \mathcal{C}_2$ and right \mathbf{C} tri-modules. There exists also a homotopy equivalence

$$\mathbf{M}(\mathbf{C}; \mathbf{C}) \sim \mathbf{M}(\mathbf{C}; \mathcal{C}_1, \mathcal{C}_2)$$

as left \mathbf{C} and right $\mathcal{C}_1, \mathcal{C}_2$ tri-modules. \diamond

The proof is given in Subsection 16.4.

16.2. Künneth functor in Lagrangian Floer theory.

Situation 16.8. Let (X_i, ω_i) be a compact symplectic manifold, V_i a background datum of X_i , and \mathbb{L}_i a finite set of V_i -relatively spin immersed Lagrangian submanifolds, for $i = 1, 2$. We assume \mathbb{L}_i is a clean collections, for $i = 1, 2$.

We obtain a curved filtered A_∞ category $\mathfrak{Fuk}(X_i; \mathbb{L}_i)$, for $i = 1, 2$. We denote by $\mathfrak{Fukst}(X_i; \mathbb{L}_i)$ the strict category associated to $\mathfrak{Fuk}(X_i; \mathbb{L}_i)$.

We consider the direct product $(X_1 \times X_2, \omega_1 \oplus \omega_2)$ and the background datum $\pi_1^*V_1 \oplus \pi_1^*V_2$ on it. We put

$$\mathbb{L}_1 \times \mathbb{L}_2 := \{L_1 \times L_2 \mid L_1 \in \mathbb{L}_1, L_2 \in \mathbb{L}_2\}.$$

This is a clean collection of $\pi_1^*V_1 \oplus \pi_1^*V_2$ relatively spin immersed Lagrangian submanifolds. We then obtain a curved filtered filtered A_∞ category $\mathfrak{Fuk}(X_1 \times X_2; \mathbb{L}_1 \times \mathbb{L}_2)$. We denote by $\mathfrak{Fukst}(X_1 \times X_2; \mathbb{L}_1 \times \mathbb{L}_2)$ the strict category associated to $\mathfrak{Fuk}(X_1 \times X_2; \mathbb{L}_1 \times \mathbb{L}_2)$.

The next theorem is the main result of this section.

Theorem 16.9. *There exists a strict and unital filtered A_∞ functor*

$$\mathfrak{Fukst}(X_1; \mathbb{L}_1) \otimes \mathfrak{Fukst}(X_2; \mathbb{L}_2) \rightarrow \mathfrak{Fukst}(X_1 \times X_2; \mathbb{L}_1 \times \mathbb{L}_2)$$

which is a homotopy equivalence to the image. \diamond

Theorem 16.9 was obtained previously by L. Amarin [Am2] by a different method.

We call the functor in Theorem 16.9 the Künneth bi-functor and denote it by \mathcal{K} .

Corollary 16.10. *Let $L_i \subset X_i$ be a V_i -relatively spin immersed Lagrangian submanifold, for $i = 1, 2$. Suppose L_1, L_2 are unobstructed.*

Then $L_1 \times L_2$ is also unobstructed.

Moreover bounding cochains b_1 and b_2 of L_1 and L_2 determine a bounding cochain $b_1 \times b_2$ of $L_1 \times L_2$ canonically up to gauge equivalence and we have an exact sequence:

$$\begin{aligned} 0 &\rightarrow \text{Tor}(HF((L_1, b_1), (L'_1, b'_1)), HF((L_2, b_2), (L'_2, b'_2))) \\ &\rightarrow HF((L_1 \times L_2, b_1 \times b_2), (L'_1 \times L'_2, b'_1 \times b'_2)) \\ &\rightarrow HF((L_1, b_1), (L'_1, b'_1)) \otimes_{\Lambda_0} HF((L_2, b_2), (L'_2, b'_2)) \rightarrow 0. \end{aligned}$$

\diamond

Proof. Let $\mathcal{C}_1, \mathcal{C}_2$ be strict and unital filtered A_∞ categories and $c_i, c'_i \in \mathfrak{D}\mathfrak{B}(\mathcal{C}_i)$. It suffices to show the existence of the next exact sequence

$$\begin{aligned} 0 &\rightarrow \mathrm{Tor}(H(\mathcal{C}_1(c_1, c'_1), \mathfrak{m}_1), H(\mathcal{C}_2(c_2, c'_2), \mathfrak{m}_1)) \\ &\rightarrow H((\mathcal{C}_1 \otimes \mathcal{C}_2)((c_1, c_2), (c'_1, c'_2)), \mathfrak{m}_1) \\ &\rightarrow H(\mathcal{C}_1(c_1, c'_1), \mathfrak{m}_1) \otimes_{\Lambda_0} H(\mathcal{C}_2(c_2, c'_2), \mathfrak{m}_1) \rightarrow 0. \end{aligned}$$

This is immediate in case $\mathcal{C}_1, \mathcal{C}_2$ are DG-categories by Lemma 16.6. The corollary then follows from the fact that any filtered A_∞ category is homotopy equivalent to a DG-category. \square

Proof of Theorem 16.9. We apply Theorems 5.25 and 3.54. We then obtain a left $\mathfrak{F}\mathfrak{u}\mathfrak{k}((X_1 \times X_2, \pi_1^*(V_1) \oplus \pi_2^*(V_2); \mathbb{L}_1 \times \mathbb{L}_2)$, right $\mathfrak{F}\mathfrak{u}\mathfrak{k}((X_1, V_1); \mathbb{L}_1), \mathfrak{F}\mathfrak{u}\mathfrak{k}((X_2, V_2); \mathbb{L}_2)$ filtered A_∞ tri-module

$$\mathcal{C}\mathcal{F}(\mathbb{L}_{12}; \mathbb{L}_1, \mathbb{L}_2) \tag{16.10}$$

as follows. We replace $(X_1, \omega_1), V_1$ in Theorems 5.25 by $(X_1, -\omega_1), V_1 \oplus TX_1$. Since

$$\mathfrak{F}\mathfrak{u}\mathfrak{k}((-X_1, V_1 \oplus TX_1); \mathbb{L}_2) \cong \mathfrak{F}\mathfrak{u}\mathfrak{k}((X_1, V_1); \mathbb{L}_1)^{\mathrm{op}}$$

by Theorem 3.54, we obtain (16.10).

The tri-module (16.10) induces a filtered A_∞ bi-functor:

$$\mathcal{F} : \mathfrak{F}\mathfrak{u}\mathfrak{k}\mathfrak{st}(X_1; \mathbb{L}_1) \times \mathfrak{F}\mathfrak{u}\mathfrak{k}\mathfrak{st}(X_2; \mathbb{L}_2) \rightarrow \mathcal{F}\mathcal{U}\mathcal{N}\mathcal{C}(\mathfrak{F}\mathfrak{u}\mathfrak{k}\mathfrak{st}(X_1 \times X_2; \mathbb{L}_1 \times \mathbb{L}_2)^{\mathrm{op}}, \mathcal{C}\mathcal{H}).$$

Proposition 16.11. *Let $(L_i, b_i) \in \mathfrak{D}\mathfrak{B}(\mathfrak{F}\mathfrak{u}\mathfrak{k}\mathfrak{st}(X_i; \mathbb{L}_i))$.*

- (1) $L_1 \times L_2$ is unobstructed. Moreover b_1, b_2 determine a bounding cochain $b_1 \times b_2$ of $L_1 \times L_2$ up to gauge equivalence canonically.
- (2) The object $(L_1 \times L_2, b_1 \times b_2)$ of $\mathfrak{F}\mathfrak{u}\mathfrak{k}\mathfrak{st}(X_1 \times X_2; \mathbb{L}_1 \times \mathbb{L}_2)$ represents the functor $\mathcal{F}((L_1, b_1), (L_2, b_2)) : \mathfrak{F}\mathfrak{u}\mathfrak{k}\mathfrak{st}(X_1 \times X_2; \mathbb{L}_1 \times \mathbb{L}_2)^{\mathrm{op}} \rightarrow \mathcal{C}\mathcal{H}$.

Proof. The proof of (1) is similar to the proof of Theorem 6.3 and the proof of (2) is similar to the proof of Theorem 7.3.

We start with (1). The tri-module applied to L_1, L_2 and $L_1 \times L_2$ induces a left $CF(L_1 \times L_2)$, right $CF(L_1), CF(L_2)$ tri-module D . Its structure operations are

$$\mathfrak{n}_{k_{12}, k_1, k_2} : B_{k_{12}}CF(L_1 \times L_2)[1] \otimes D \otimes B_{k_1}CF(L_1)[1] \otimes B_{k_2}CF(L_2)[1] \rightarrow D.$$

We use bounding cochains b_1, b_2 to deform it to obtain

$$\mathfrak{n}_{k_{12}}^{b_1, b_2} : B_{k_{12}}CF(L_1 \times L_2) \otimes D \rightarrow D.$$

Namely we put:

$$\mathfrak{n}_k^{b_1, b_2}(x_1, \dots, x_k; y) = \sum_{k_1, k_2} \mathfrak{n}_{k, k_1, k_2}(x_1, \dots, x_k; y; b_1^{k_1}, b_2^{k_2}).$$

The maps $\{\mathfrak{n}_k^{b_1, b_2} \mid k = 0, 1, 2, \dots\}$ define a structure of left $CF(L_1 \times L_2)$ module over D .

By definition, there exists an isomorphism

$$D = \Omega((\tilde{L}_1 \times_{X_1} (\tilde{L}_1 \times \tilde{L}_2) \times_{X_2} \tilde{L}_2)) \otimes \hat{\Lambda}_0$$

as Λ_0 modules. So D is actually isomorphic to $CF(L_1 \times L_2)$, as a Λ_0 module. The differential 0-form (function) 1 on the diagonal component

$$\tilde{L}_1 \times \tilde{L}_2 \subset \tilde{L}_1 \times_{X_1} (\tilde{L}_1 \times \tilde{L}_2) \times_{X_2} \tilde{L}_2$$

is a cyclic element of the left $CF(L_1 \times L_2)$ module D . (We can prove it in the same way as Proposition 6.12.)

Proposition 16.11 (1) now follows from (the left module analogue of) Proposition 6.6. We remark that the bounding cochain $b_1 \times b_2$ is characterized by the formula

$$0 = \sum_{k_1, k_2, k_{12}} \mathbf{n}_{k_{12}, k_1, k_2} ((b_1 \times b_2)^{k_{12}}; 1; b_1^{k_1}, b_2^{k_2}). \quad (16.11)$$

We turn to the proof of (2). Let K_1, \dots, K_k be elements of $\mathbb{L}_1 \times \mathbb{L}_2$ and b_{K_i} a bounding cochain of K_i . We consider

$$D(K_i) = \mathcal{F}(L_1, L_2)(K_i).$$

It is a left $CF(K_i)$, right $CF(L_1)$, $CF(L_2)$ tri-module. Note that we use b_1, b_2, b_{K_i} to obtain a left $CF(K_i, b_{K_i})$, right $CF(L_1, b_1)$, $CF(L_2, b_2)$ tri-module structure on $D(K_i)$, which we write

$$\mathbf{n}_{k_{12}, k_1, k_2}^{b_{K_i}, b_1, b_2} : B_{k_{12}} CF(K_i)[1] \otimes D(K_i) \otimes B_{k_1} CF(L_1) \otimes B_{k_2} CF(L_2) \rightarrow D(K_i).$$

We also have

$$\mathbf{n}_m : \bigotimes_{i=1}^m CF(K_{i-1}, K_i) \otimes D(K_m) \rightarrow D(K_0). \quad (16.12)$$

In (16.12) we include corrections by bounding cochains of L_i and K_i .

We consider two left $\mathfrak{Fust}(X_1 \times X_2; \mathbb{L}_1 \times \mathbb{L}_2)$ modules \mathfrak{D}_1 and \mathfrak{D}_2 as follows. We write $\mathcal{K} = (K, b_K)$, $\mathcal{K}_i = (K_i, b_{K_i})$. They are elements of $\mathfrak{DB}(\mathfrak{Fust}(X_1 \times X_2; \mathbb{L}_1 \times \mathbb{L}_2))$.

(M1-1) As a Λ_0 module $\mathfrak{D}_1(\mathcal{K})$ is $D(K)$.

(M1-2) The structure operations of the left $\mathfrak{Fust}(X_1 \times X_2; \mathbb{L}_1 \times \mathbb{L}_2)$ module structure are (16.12).

(M2-1)

$$\mathfrak{D}_2(\mathcal{K}) := CF((K, b_K), (L_1 \times L_2, b_1 \times b_2)).$$

Here the right hand side is the module of morphisms in $\mathfrak{Fust}(X_1 \times X_2; \mathbb{L}_1 \times \mathbb{L}_2)$.

(M2-2) The structure operations of the left $\mathfrak{Fust}(X_1 \times X_2; \mathbb{L}_1 \times \mathbb{L}_2)$ module structure are the structure operations of the filtered A_∞ structure of $\mathfrak{Fust}(X_1 \times X_2; \mathbb{L}_1 \times \mathbb{L}_2)$.

Note that \mathfrak{D}_1 is nothing but the left filtered A_∞ module $\mathcal{F}((L_1, b_1), (L_2, b_2))$ and \mathfrak{D}_2 is nothing but the left filtered A_∞ module $\mathfrak{Yon}(X_1 \times X_2; \mathbb{L}_1 \times \mathbb{L}_2)$. Therefore the next lemma completes the proof of Proposition 16.11.

Lemma 16.12. $\mathfrak{D}_1(\mathcal{K})$ is homotopy equivalent to $\mathfrak{D}_2(\mathcal{K})$ as left $\mathfrak{Fust}(X_1 \times X_2; \mathbb{L}_1 \times \mathbb{L}_2)$ modules. \diamond

Proof. Let

$$\mathbf{1} \in D(L_1 \times L_2, b_1 \times b_2)$$

be the cyclic element. We define

$$\begin{aligned} \mathfrak{T}_0(\mathcal{K}) &: \mathfrak{D}_2(\mathcal{K}) \rightarrow \mathfrak{D}_1(\mathcal{K}) \\ \mathfrak{T}_{m-1}(\mathcal{K}_1, \dots, \mathcal{K}_m) &: \bigotimes_{i=1}^{m-1} CF(\mathcal{K}_i, \mathcal{K}_{i+1}) \otimes D_2(\mathcal{K}_m) \rightarrow \mathfrak{D}_1(\mathcal{K}_1) \end{aligned}$$

as follows. We put $\mathcal{K}_0 = \mathcal{K}$, $\mathcal{K}_1 = (L_1 \times L_2, b_1 \times b_2)$ in (16.12) and define:

$$\mathfrak{T}_0(\mathcal{K})(z) = \mathbf{n}_1(z; \mathbf{1}).$$

Here $z \in CF(K, L_1 \times L_2)$ and $\mathbf{1} \in CF(L_1 \times L_2; L_1, L_2)$ is the cyclic element.

We put $\mathcal{K}_m = (L_1 \times L_2, b_1 \times b_2)$ and take \mathcal{K}_i for $i = 1, \dots, m-1$ in (16.12) and define:

$$\mathfrak{T}_{m-1}(\mathcal{K})(x_1, \dots, x_{m-1})(z) = \mathbf{n}_{m-1}(x_1, \dots, x_{m-1}; z; \mathbf{1}),$$

for $z \in D_2(K_m) \in CF(K_m, L_1 \times L_2)$, $x_i \in CF(K_i, K_{i+1})$. See Figure 105.

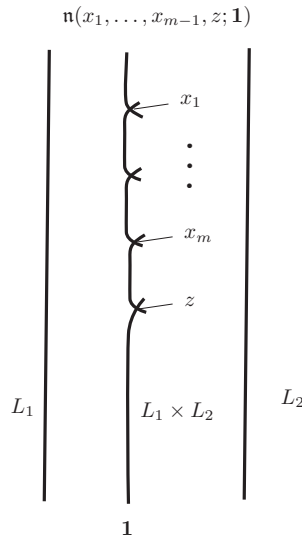

FIGURE 105. \mathfrak{T}_{m-1}

The A_∞ relations for $\{\mathbf{n}_m\}$ imply that $\{\mathfrak{T}_i \mid i = 0, 1, \dots\}$ is a left $\mathfrak{Fukst}(X_1 \times X_2; \mathbb{L}_1 \times \mathbb{L}_2)$ module homomorphism.

To show that it is a homotopy equivalence, we first observe that $\mathfrak{D}_1(\mathcal{K})$, $\mathfrak{D}_2(\mathcal{K})$ both are isomorphic to

$$\Omega(\tilde{K} \times_{X_1 \times X_2} (\tilde{L}_1 \times \tilde{L}_2)) \hat{\otimes} \Lambda_0$$

as Λ_0 modules. (Here $\tilde{K} \rightarrow X_1 \times X_2$ is the immersed Lagrangian submanifold which is a part of \mathcal{K} .)

We next observe that $\mathfrak{T}_0(\mathcal{K})$ is congruent to the identity map (via the above identification $\mathfrak{D}_1(\mathcal{K}) = \mathfrak{D}_2(\mathcal{K})$). In fact $\mathfrak{T}_0 = \mathbf{n}_1$ is defined by using the moduli space of pseudo-holomorphic disks and we put T^E as a part of the weight when we use the moduli space of pseudo-holomorphic disks with symplectic area E . The disk with symplectic area 0 is nothing but a constant map, whose contribution to \mathfrak{T}_0 is the identity map.

The proof of Lemma 16.12 is complete. □

The proof of Proposition 16.11 is complete. □

We consider the full subcategory of $\mathfrak{Fukst}(X_1 \times X_2; \mathbb{L}_1 \times \mathbb{L}_2)$ the set of whose objects consists of $(L_1 \times L_2, b_1 \times b_2)$ where $L_i \in \mathbb{L}_i$ and $b_1 \times b_2$ is a bounding cochain

of $L_1 \times L_2$ obtained by Lemma 16.11 from bounding cochains b_1 and b_2 of L_1 and L_2 . We denote it by \mathcal{L} .

We put $\mathcal{C}_i = \mathfrak{F}\mathfrak{u}\mathfrak{k}\mathfrak{st}(X_i, \mathbb{L}_i)$ and $\mathbf{C} = \mathcal{C}_1 \otimes \mathcal{C}_2$. The formulas (16.6) and (16.8) define a left $\mathcal{C}_1, \mathcal{C}_2$ and right \mathbf{C} filtered A_∞ tri-module $\mathbf{M}(\mathcal{C}_1, \mathcal{C}_2; \mathbf{C})$. (See also (16.13).)

By (16.10) we obtain a left \mathcal{L} right $\mathcal{C}_1, \mathcal{C}_2$ tri-module, which we denote by $\mathbf{M}(\mathcal{L}; \mathcal{C}_1, \mathcal{C}_2)$.

Note that the set of objects of \mathbf{C} is canonically identified with the set of objects of \mathcal{L} . (In fact, they both are $\mathfrak{D}\mathfrak{b}\mathfrak{F}\mathfrak{u}\mathfrak{k}\mathfrak{st}(X_1, \mathbb{L}_1) \times \mathfrak{D}\mathfrak{b}\mathfrak{F}\mathfrak{u}\mathfrak{k}\mathfrak{st}(X_2, \mathbb{L}_2)$.) For any objects \mathfrak{c} of \mathbf{C} the tri-module $\mathbf{M}(\mathbf{C}; \mathcal{C}_1, \mathcal{C}_2)$ determines a right $\mathcal{C}_1, \mathcal{C}_2$ filtered A_∞ bi-module, which we write $\mathbf{M}(\mathbf{C}; \mathcal{C}_1, \mathcal{C}_2)(\mathfrak{c}; *, *)$. We define a right $\mathcal{C}_1, \mathcal{C}_2$ filtered A_∞ bi-module $\mathbf{M}(\mathcal{L}; \mathcal{C}_1, \mathcal{C}_2)(\mathfrak{c}; *, *)$ in the same way.

Lemma 16.13. *For any object \mathfrak{c} of \mathbf{C} , the module $\mathbf{M}(\mathbf{C}; \mathcal{C}_1, \mathcal{C}_2)(\mathfrak{c}; *, *)$ is isomorphic⁶⁸ to $\mathbf{M}(\mathcal{L}; \mathcal{C}_1, \mathcal{C}_2)(\mathfrak{c}; *, *)$ as right $\mathcal{C}_1, \mathcal{C}_2$ filtered A_∞ bi-modules.*

Remark 16.14. Let $\mathfrak{c}_i = (L_i, b_i), \mathfrak{c}'_i = (L'_i, b'_i) \in \mathbb{L}_i$ and we put $\mathfrak{c} = (\mathfrak{c}_1, \mathfrak{c}_2), \mathfrak{c}' = (\mathfrak{c}'_1, \mathfrak{c}'_2)$. The chain complex $\mathbf{M}(\mathcal{L}; \mathcal{C}_1, \mathcal{C}_2)(\mathfrak{c}; \mathfrak{c}'_1, \mathfrak{c}'_2)$ is chain homotopy equivalent to $CF((L_1 \times L_2, b_1 \times b_2), (L'_1 \times L'_2, b'_1 \times b'_2))$ by Proposition 16.11 (2).

On the other hand, the chain complex $\mathbf{M}(\mathbf{C}; \mathcal{C}_1, \mathcal{C}_2)(\mathfrak{c}; \mathfrak{c}'_1, \mathfrak{c}'_2)$ is chain homotopy equivalent to $CF((L_1, b_1), (L'_1, b'_1)) \otimes CF((L_2, b_2), (L'_2, b'_2))$, by definition. Therefore Lemma 16.13 implies

$$CF((L_1 \times L_2, b_1 \times b_2), (L'_1 \times L'_2, b'_1 \times b'_2)) \sim CF((L_1, b_1), (L'_1, b'_1)) \otimes CF((L_2, b_2), (L'_2, b'_2))$$

where \sim means chain homotopy equivalence. This is Künneth formula. The proof of Theorem 16.9 shows that this chain homotopy equivalence is functorial. \diamond

Proof of Lemma 16.13. We put $\mathfrak{c} = (\mathfrak{c}_1, \mathfrak{c}_2)$ and $\mathfrak{c}'_j = (\mathfrak{c}'_{j,1}, \mathfrak{c}'_{j,2})$ for $j = 1, 2$. The structure operations of the right bi-module structure on $\mathbf{M}(\mathbf{C}; \mathcal{C}_1, \mathcal{C}_2)(\mathfrak{c}; *, *)$, which we denote by \mathfrak{m}' is defined by

$$\begin{aligned} & \mathfrak{m}'(((z_1, z_2), \mathbf{x}, \mathbf{y})) \\ & := \begin{cases} 0 & \text{if } \mathbf{x} \neq 1 \text{ or } \mathbf{y} \neq 1, \\ (-1)^{\deg' \mathbf{x} \deg' z_2} (\mathfrak{m}(z_1, \mathbf{x}), z_2) & \text{if } \mathbf{y} = 1, \\ (-1)^{\deg' z_1} (z_1, \mathfrak{m}(z_2, \mathbf{y})) & \text{if } \mathbf{x} = 1. \end{cases} \end{aligned} \quad (16.13)$$

Here \mathfrak{m} is the structure operations of \mathcal{C}_i , which is obtained by ‘counting’ pseudo-holomorphic polygons, $\mathbf{x} \in B\mathcal{C}_1[1](\mathfrak{c}'_{1,1}, \mathfrak{c}'_{2,1}), \mathbf{y} \in B\mathcal{C}_2[1](\mathfrak{c}'_{1,2}, \mathfrak{c}'_{2,2})$ and $z_i \in \mathcal{C}_i[1](\mathfrak{c}_i, \mathfrak{c}'_{1,i})$ for $i = 1, 2$.

On the other hand, the structure operations of the bi-module structure on $\mathbf{M}(\mathcal{L}; \mathcal{C}_1, \mathcal{C}_2)(\mathfrak{c}; *, *)$ is the operations $\{\mathfrak{n}\}$ which are structure operations of the tri-module (16.10) and obtained by ‘counting’ pseudo-holomorphic quilts.

For $\mathfrak{b}_i, \mathfrak{b}'_i \in \mathfrak{D}\mathfrak{b}\mathfrak{F}\mathfrak{u}\mathfrak{k}\mathfrak{st}(X_i, \mathbb{L}_i)$, we define

$$\begin{aligned} \mathcal{F}_{k_1, k_2} : \mathbf{M}(\mathbf{C}; \mathcal{C}_1, \mathcal{C}_2)(\mathfrak{c}; \mathfrak{b}_1, \mathfrak{b}_2) \otimes B_{k_1} \mathcal{C}_1[1](\mathfrak{b}_1, \mathfrak{b}'_1) \otimes B_{k_2} \mathcal{C}_2[1](\mathfrak{b}_2, \mathfrak{b}'_2) \\ \rightarrow \mathbf{M}(\mathcal{L}; \mathcal{C}_1, \mathcal{C}_2)(\mathfrak{c}; \mathfrak{b}'_1, \mathfrak{b}'_2) \end{aligned}$$

⁶⁸Here two right filtered A_∞ bi-modules are said to be isomorphic each other if there exist a bi-module homomorphism between them which has an inverse.

by

$$\begin{aligned} & \mathcal{F}_{k_1, k_2}((z_1, z_2), (\mathbf{x}, \mathbf{y})) \\ & := \sum_c (-1)^* \mathbf{n}(\mathbf{1}; \mathbf{1} \otimes (z_2 \otimes \mathbf{y}_c)); (z_1 \otimes \mathbf{x}) \otimes \mathbf{y}'_c, \end{aligned} \quad (16.14)$$

where

$$* = \deg' z_1 (\deg' z_2 + \deg' \mathbf{y}_c) + \deg' \mathbf{x} \deg' \mathbf{y}_c$$

is the Koszul sign. Here $\mathbf{x} \in B_{k_1} \mathcal{C}_1[1](\mathbf{b}_1, \mathbf{b}'_1)$, $\mathbf{y} \in B_{k_2} \mathcal{C}_2[1](\mathbf{b}_2, \mathbf{b}'_2)$, and $z_i \in \mathcal{C}_i[1](\mathbf{c}_i, \mathbf{b}_i)$. The symbol $\mathbf{1}$ is the fundamental class of $\mathbf{M}(\mathcal{L}; \mathcal{C}_1, \mathcal{C}_2)(\mathbf{c}; (\mathbf{c}_1, \mathbf{c}_2))$, that is, the cyclic element and $\Delta(\mathbf{y}) = \sum_c \mathbf{y}_c \otimes \mathbf{y}'_c$. The idea behind this definition can be seen from Figure 106 below.

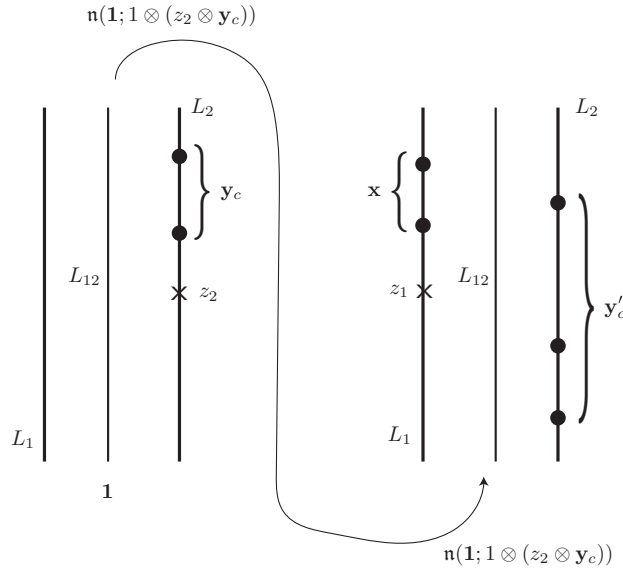

FIGURE 106. $\mathcal{F}_{k_1, k_2}((z_1, z_2), (\mathbf{x}, \mathbf{y}))$.

We will prove that $\{\mathcal{F}_{k_1, k_2}\}$ is a right filtered A_∞ bi-module homomorphism.

We denote by $\widehat{\mathbf{m}}'$ the maps

$$\begin{aligned} & \bigoplus_{\mathbf{b}_1, \mathbf{b}_2} \mathbf{M}(\mathbf{C}; \mathcal{C}_1, \mathcal{C}_2)(\mathbf{c}; \mathbf{b}_1, \mathbf{b}_2) \otimes B\mathcal{C}_1[1](\mathbf{b}_1, \mathbf{c}'_1) \otimes B\mathcal{C}_2[1](\mathbf{b}_2, \mathbf{c}'_2) \\ & \rightarrow \bigoplus_{\mathbf{b}_1, \mathbf{b}_2} \mathbf{M}(\mathbf{C}; \mathcal{C}_1, \mathcal{C}_2)(\mathbf{c}; \mathbf{b}_1, \mathbf{b}_2) \otimes B\mathcal{C}_1[1](\mathbf{b}_1, \mathbf{c}'_1) \otimes B\mathcal{C}_2[1](\mathbf{b}_2, \mathbf{c}'_2) \end{aligned}$$

induced by \mathbf{m}' , (See (16.13).) and denote by \mathbf{m} the structure operations of \mathcal{C}_i . We also denote by

$$\begin{aligned} \widehat{\mathcal{F}} & : \bigoplus_{\mathbf{b}_1, \mathbf{b}_2} \mathbf{M}(\mathbf{C}; \mathcal{C}_1, \mathcal{C}_2)(\mathbf{c}; \mathbf{b}_1, \mathbf{b}_2) \otimes B\mathcal{C}_1[1](\mathbf{b}_1, \mathbf{c}'_1) \otimes B\mathcal{C}_2[1](\mathbf{b}_2, \mathbf{c}'_2) \\ & \rightarrow \bigoplus_{\mathbf{b}_1, \mathbf{b}_2} \mathbf{M}(\mathcal{L}; \mathcal{C}_1, \mathcal{C}_2)(\mathbf{c}; \mathbf{b}_1, \mathbf{b}_2) \otimes B\mathcal{C}_1[1](\mathbf{b}_1, \mathbf{c}'_1) \otimes B\mathcal{C}_2[1](\mathbf{b}_2, \mathbf{c}'_2) \end{aligned}$$

the map induced by \mathcal{F}_{k_1, k_2} .

We will check

$$(\mathbf{n} \circ \widehat{\mathcal{F}})((z_1, z_2), (\mathbf{x}, \mathbf{y})) = (\mathcal{F} \circ \widehat{\mathbf{m}})((z_1, z_2), (\mathbf{x}, \mathbf{y})). \quad (16.15)$$

Remark 16.15. Intuitively (16.15) can be proved easily by studying the boundary of the moduli space depicted by Figure 106. The proof below is an algebraic analogue of such a geometric argument.

Let $\widehat{\mathbf{m}}_i : B\mathcal{C}_i \rightarrow B\mathcal{C}_i$ is the map induced by the structure operations of \mathcal{C}_i . We denote $\widehat{\mathbf{m}} = \widehat{\mathbf{m}}_1 \widehat{\otimes} \text{id} + \text{id} \widehat{\otimes} \widehat{\mathbf{m}}_2$. Let \mathbf{m} be the $\mathcal{C}_1 \otimes \mathcal{C}_2$ component of $\widehat{\mathbf{m}}$.

We put $\Delta(\mathbf{x}) = \sum_b \mathbf{x}_b \otimes \mathbf{x}'_b$, $((\Delta \otimes \text{id}) \circ \Delta)(\mathbf{y}) = \sum_{c'} \mathbf{y}_c \otimes \mathbf{y}'_{c'} \otimes \mathbf{y}''_{c'}$.

Now the right hand side of (16.15) is

$$\begin{aligned} & \sum_c (-1)^{*1} \mathbf{n}(\mathbf{n}(\mathbf{1}; 1 \otimes (z_2 \otimes \mathbf{y}_c)); (z_1 \otimes \widehat{\mathbf{m}}(\mathbf{x})) \otimes \mathbf{y}'_c) \\ & + \sum_c (-1)^{*2} \mathbf{n}(\mathbf{n}(\mathbf{1}; 1 \otimes (z_2 \otimes \mathbf{y}_c)); (z_1 \otimes \mathbf{x}) \otimes \widehat{\mathbf{m}}(\mathbf{y}'_c)) \\ & + \sum_c (-1)^{*3} \mathbf{n}(\mathbf{n}(\mathbf{1}; 1 \otimes (z_2 \otimes \widehat{\mathbf{m}}(\mathbf{y}_c))); (z_1 \otimes \mathbf{x}) \otimes \mathbf{y}'_c) \\ & + \sum_{c, c'} (-1)^{*4} \mathbf{n}(\mathbf{n}(\mathbf{1}; 1 \otimes (\mathbf{m}(z_2 \otimes \mathbf{y}_{c'}) \otimes \mathbf{y}'_{c'})); (z_1 \otimes \mathbf{x}) \otimes \mathbf{y}''_{c'}) \\ & + \sum_{b, c} (-1)^{*5} \mathbf{n}(\mathbf{n}(\mathbf{1}; \mathbf{n}(1 \otimes (z_2 \otimes \mathbf{y}_c))); (\mathbf{m}(z_1 \otimes \mathbf{x}_b) \otimes \mathbf{x}'_b) \otimes \mathbf{y}'_c) \end{aligned} \quad (16.16)$$

where the signs $*_i$ are by Koszul rule. Note that the sign here is always by Koszul rule and so it is actually not necessary to calculate the sign as we will explain at the end of the proof of (16.15).

On the other hand, the left hand side of (16.15) is:

$$\sum_{b, c'} \mathbf{n}(\mathbf{n}(\mathbf{n}(\mathbf{1}; 1 \otimes (z_2 \otimes \mathbf{y}_{c'})); (z_1 \otimes \mathbf{x}_b) \otimes \mathbf{y}'_{c'}); \mathbf{x}'_b \otimes \mathbf{y}''_{c'}), \quad (16.17)$$

up to sign. We put

$$z_c := \pm \mathbf{n}(\mathbf{1}; 1 \otimes (z_2 \otimes \mathbf{y}_c)),$$

where $\Delta(\mathbf{y}) = \sum_c \mathbf{y}_c \otimes \mathbf{y}'_c$.

(16.17) plus the next formula (16.18) is obtained by applying \mathbf{n} twice to the element $\sum_c z_c \otimes ((z_1 \otimes \mathbf{x}) \otimes \mathbf{y}'_c)$ up to sign.

$$\sum_{c''} \mathbf{n}(\mathbf{n}(\mathbf{n}(\mathbf{1}; 1 \otimes (z_2 \otimes \mathbf{y}_c)); 1 \otimes \mathbf{y}'_{c'}); (z_1 \otimes \mathbf{x}) \otimes \mathbf{y}''_{c'}). \quad (16.18)$$

Therefore applying A_∞ formula for \mathbf{n} , the formula (16.17) is equal to

$$\begin{aligned} & + \sum_c \mathbf{n}(z_c; \widehat{\mathbf{m}}(z_1 \otimes \mathbf{x}) \otimes \mathbf{y}'_c) \\ & + \sum_c \mathbf{n}(z_c; (z_1 \otimes \mathbf{x}) \otimes \widehat{\mathbf{m}}(\mathbf{y}'_c)) \\ & + (16.18) \end{aligned} \quad (16.19)$$

up so sign. This cancels with (16.16) up to sign. In fact the first term of (16.19) cancel with the first and fifth terms of (16.16), the second term of (16.19) cancel with the second term of (16.16), and (16.18) cancel with the third and fourth terms of (16.16), using A_∞ relation (of left bi-module structure) applied to $\mathbf{1} \otimes (1 \otimes (z_2 \otimes \mathbf{y}_c))$.

The calculation of sign looks complicated. However we actually do *not* need to check the sign by calculation to see the corresponding terms cancel out with sign. In fact all the signs are caused by changing the order of operators or elements (which are graded), that is by Koszul rule. So except the minus sign which comes from exchanging the order of \mathfrak{m} and \mathfrak{n} (both of which have degree ± 1) the sign of the corresponding terms coincide. Therefore the cancellation occurs with signs.⁶⁹

Thus $\{\mathcal{F}_{k_1, k_2}\}$ defines a filtered bi-module homomorphism.

We remark that $\mathbf{M}(\mathbf{C}; \mathcal{C}_1, \mathcal{C}_2)(\mathfrak{c}; \mathfrak{c}')$ as Λ_0 module is a T -adic completion of the tensor product of de Rham complex $\Omega(\tilde{L}_1 \times_{X_1} \tilde{L}'_1) \widehat{\otimes} \Lambda_0$ and $\Omega(\tilde{L}_2 \times_{X_2} \tilde{L}'_2) \widehat{\otimes} \Lambda_0$. On the other hand, $\mathbf{M}(\mathcal{L}; \mathcal{C}_1, \mathcal{C}_2)(\mathfrak{c}; \mathfrak{c}')$ is $\Omega((\tilde{L}_1 \times \tilde{L}_2) \times_{X_1 \times X_2} (\tilde{L}'_1 \times \tilde{L}'_2)) \widehat{\otimes} \Lambda_0$. Therefore their reductions to the ground ring is isomorphic each other. It is easy to see that R reduction of $\mathcal{F}_{0,0}$ is this isomorphism. Therefore $\mathcal{F}_{0,0}$ is an isomorphism. Hence \mathcal{F} is an isomorphism. \square

We recall that $\mathbf{C} = \mathcal{C}_1 \otimes \mathcal{C}_2$ can be regarded as the category of right bi-module homomorphisms $\mathbf{M}(\mathbf{C}; \mathcal{C}_1, \mathcal{C}_2) \rightarrow \mathbf{M}(\mathbf{C}; \mathcal{C}_1, \mathcal{C}_2)$ in the following sense. An object of \mathbf{C} is identified with a pair of objects $(\mathfrak{c}_1, \mathfrak{c}_2)$ of \mathcal{C}_1 and of \mathcal{C}_2 . For a fix $(\mathfrak{c}_1, \mathfrak{c}_2)$, by moving $(\mathfrak{c}'_1, \mathfrak{c}'_2)$ this defines a right $\mathcal{C}_1, \mathcal{C}_2$ module, which is nothing but $\mathbf{M}(\mathbf{C}; \mathcal{C}_1, \mathcal{C}_2)(*, *, (\mathfrak{c}_1, \mathfrak{c}_2))$. The morphisms and operations in \mathbf{C} are defined to be the right $\mathcal{C}_1, \mathcal{C}_2$ bi-module homomorphisms and their compositions.⁷⁰

By Lemma 16.13, $\mathbf{M}(\mathbf{C}; \mathcal{C}_1, \mathcal{C}_2)$ is isomorphic to $\mathbf{M}(\mathcal{L}; \mathcal{C}_1, \mathcal{C}_2)$. Now using the fact $\mathbf{M}(\mathcal{L}; \mathcal{C}_1, \mathcal{C}_2)$ is a left \mathcal{L} , right $\mathcal{C}_1, \mathcal{C}_2$ tri-module, we obtain a filtered A_∞ functor

$$\mathcal{G} : \mathcal{L} \rightarrow \mathcal{C}_1 \otimes \mathcal{C}_2.$$

Note that the object part of \mathcal{G} is the identity map.

Lemma 16.16. *The linear part \mathcal{G}_1 of \mathcal{G} is a chain homotopy equivalence from $\mathcal{L}((\mathfrak{c}'_1, \mathfrak{c}'_2), (\mathfrak{c}_1, \mathfrak{c}_2))$ to $\mathbf{C}((\mathfrak{c}'_1, \mathfrak{c}'_2), (\mathfrak{c}_1, \mathfrak{c}_2))$.*

We prove Lemma 16.16 at the end of Subsection 16.3. Lemma 16.16 implies \mathcal{G} is a homotopy equivalence. The proof of Theorem 16.9 is complete. \square

16.3. The Künneth functor and the correspondence tri-module. Suppose that we are in Situation 5.24. We consider the set $\mathbb{L}_1 \times \mathbb{L}_2$ of Lagrangian submanifolds of $-X_1 \times X_2$ which consists of direct products $L_1 \times L_2$ of elements $L_1 \in \mathbb{L}_1$ and $L_2 \in \mathbb{L}_2$. The Künneth functor defines:

$$\begin{aligned} \mathcal{K} : \mathfrak{Fukst}((-X_1, V_1 \oplus TX_1); \mathbb{L}_1) \times \mathfrak{Fukst}((X_2, V_2); \mathbb{L}_2) \\ \rightarrow \mathfrak{Fukst}((-X_1 \times X_2, \pi_1^*(V_1 \oplus TX_1) \oplus \pi_2^*(V_2)); \mathbb{L}_1 \times \mathbb{L}_2). \end{aligned} \quad (16.20)$$

Note that we replace X_1, V_1 by $-X_1, V_1 \oplus TX_1$ when we apply Theorem 16.9 to obtain (16.20).

Theorem 16.17. *Let $L_1 \in \mathbb{L}_1$, $L_{12} \in \mathbb{L}_{12}$ and b_1, b_{12} their bounding cochains. We put $\mathcal{L}_1 = (L_1, b_1)$, $\mathcal{L}_{12} = (L_{12}, b_{12})$. Using correspondence bi-functor we obtain $(L_2, b_2) = \mathcal{W}_{\mathcal{L}_{12}}(\mathcal{L}_1)$.*

Then we have the following isomorphism for any $L'_2 \in \mathbb{L}_2$ and its bounding cochain b'_2 .

$$HF((L_2, b_2); (L'_2, b'_2); \Lambda_0) \cong HF((L_{12}, b_{12}); (L_1 \times L'_2, b_1 \times b'_2); \Lambda_0). \quad (16.21)$$

⁶⁹This is the standard magic of Koszul sign.

⁷⁰Here we use the operation taking opposite module (See Definition 11.3.) to go from left module to right module and vice versa.

Here $(L_1 \times L'_2, b_1 \times b'_2) := \mathcal{K}_{\text{ob}}((L_1, b_1), (L'_2, b'_2))$.

Proof. In our situation where X_1, V_1 are replaced by $-X_1, V_1 \oplus TX_1$ the tri-module (16.10) is the correspondence tri-module. Therefore the theorem is an immediate consequence of Theorems 7.3 and 16.9. \square

16.4. Proof of Lemmas 16.6, 16.7 and 16.16. In this subsection we prove Lemmas 16.6, 16.7 and 16.16. It suffices to consider the case when $\mathcal{C}_1, \mathcal{C}_2$ are DG-categories.

Proof of Lemma 16.7. We prove the first half. The proof of the second half is similar. We define a tri-module homomorphism

$$\mathfrak{J} : \mathbf{M}(\mathcal{C}_1, \mathcal{C}_2; \mathbf{C}) \rightarrow \mathbf{M}(\mathbf{C}; \mathbf{C})$$

as follows.

We first define

$$\begin{aligned} \mathbf{n} : (B\mathcal{C}_1[1](b_{1,1}, b_{2,1}) \otimes B\mathcal{C}_2[1](b_{1,2}, b_{2,2})) \\ \otimes \mathcal{C}_1[1](b_{2,1}, c_{1,1}) \otimes \mathcal{C}_2[1](b_{2,2}, c_{1,2}) \\ \otimes \mathbf{C}(\mathbf{c}_1, \mathbf{c}_2) \rightarrow \mathcal{C}_1[1](c_{1,1}, c_{2,1}) \otimes \mathcal{C}_2[1](c_{1,2}, c_{2,2}), \end{aligned}$$

as follows. Note an element $\mathcal{T} \in \mathbf{C}(\mathbf{c}_1, \mathbf{c}_2)$ is a pre-natural transformation from $\mathbf{C}(\mathbf{c}_1)$ to $\mathbf{C}(\mathbf{c}_2)$. Such pre-natural transformation assigns to each $\mathbf{b}_1 = (b_{1,1}, b_{1,2}), \mathbf{b}_2 = (b_{2,1}, b_{2,2})$ a map

$$\begin{aligned} (B\mathcal{C}_1[1](b_{1,1}, b_{2,1}) \otimes B\mathcal{C}_2[1](b_{1,2}, b_{2,2})) \\ \otimes \mathcal{C}_1[1](b_{2,1}, c_{1,1}) \otimes \mathcal{C}_2[1](b_{2,2}, c_{1,2}) \rightarrow \mathcal{C}_1[1](c_{1,1}, c_{2,1}) \otimes \mathcal{C}_2[1](c_{1,2}, c_{2,2}). \end{aligned}$$

For $\mathbf{x} \otimes \mathbf{y} \otimes z \in (B\mathcal{C}_1[1](b_{1,1}, b_{2,1}) \otimes B\mathcal{C}_2[1](b_{1,2}, b_{2,2})) \otimes \mathcal{C}_1[1](b_{2,1}, c_{1,1}) \otimes \mathcal{C}_2[1](b_{2,2}, c_{1,2})$ we denote by

$$\mathbf{n}(\mathbf{x} \otimes \mathbf{y}, z, \mathcal{T})$$

the image of $\mathbf{x} \otimes \mathbf{y} \otimes z$ by this map.

We next define

$$\mathfrak{J}_{0,0,0}(\mathbf{c}_1, \mathbf{c}_2) : \mathcal{C}_1[1](c_{1,1}, c_{1,2}) \otimes \mathcal{C}_2[1](c_{2,1}, c_{2,2}) \rightarrow \mathbf{C}(\mathbf{c}_1, \mathbf{c}_2)$$

by the formula

$$\begin{aligned} \mathbf{n}(\mathbf{x} \otimes \mathbf{y}, z, \mathfrak{J}_{0,0,0}(\mathbf{c}_1, \mathbf{c}_2)(a_1, a_2)) \\ = \begin{cases} (-1)^{\deg' a_1 \deg' z_2} \mathbf{m}_2(z_1, a_1), \mathbf{m}_2(z_2, a_2) & \text{if } \mathbf{x} \otimes \mathbf{y} = 1 \otimes 1 \\ 0 & \text{otherwise.} \end{cases} \quad (16.22) \end{aligned}$$

Here \mathbf{n} is defined as above⁷¹ and $z = (z_1, z_2) \in \mathcal{C}_1[1](b_{2,1}, c_{1,1}) \otimes \mathcal{C}_2[1](b_{2,2}, c_{1,2})$, $\mathbf{x} \otimes \mathbf{y} \in B\mathcal{C}_1[1](b_{1,1}, b_{2,1}) \otimes B\mathcal{C}_2[1](b_{1,2}, b_{2,2})$, $(a_1, a_2) \in \mathcal{C}_1[1](c_{1,1}, c_{1,2}) \otimes \mathcal{C}_2[1](c_{2,1}, c_{2,2})$.

Hereafter we write $\mathfrak{J}_{0,0,0}$ in place of $\mathfrak{J}_{0,0,0}(\mathbf{c}_1, \mathbf{c}_2)$.

We define all other $\mathfrak{J}_{k_1, k_2; \ell}$ to be 0.

Sublemma 16.18. $\mathfrak{J} : \mathbf{M}(\mathcal{C}_1, \mathcal{C}_2; \mathbf{C}) \rightarrow \mathbf{M}(\mathbf{C}; \mathbf{C})$ is a tri-module homomorphism. \diamond

⁷¹We remark that the pre-natural transformation \mathcal{T} is determined if $\mathbf{n}(\mathbf{x} \otimes \mathbf{y}, z, \mathcal{T})$ are given for all $\mathbf{x}, \mathbf{y}, z$.

Proof. Since \mathcal{C}_i and \mathbf{C} are DG categories, (16.22) implies that

$$\mathbf{n}(\mathbf{x} \otimes \mathbf{y}; z; \delta(\mathfrak{J}_{0,0,0}(a_1, a_2))) = 0$$

unless $\mathbf{x} \otimes \mathbf{y} \in B_{k_1} \mathcal{C}_1[1] \otimes B_{k_2} \mathcal{C}_2[1]$ with $(k_1, k_2) = (0, 0), (1, 0), (1, 1)$. Here δ is the boundary operator of \mathbf{C} . In case $(k_1, k_2) = (1, 0)$ we calculate⁷²

$$\begin{aligned} & \mathbf{n}(x \otimes 1, z, \delta(\mathfrak{J}_{0,0,0}(a_1, a_2))) \\ &= (\mathbf{m}_2(\mathbf{m}_2(x, z_1), a_1), \mathbf{m}_2(z_2, a_2)) + (\mathbf{m}_2(x, \mathbf{m}_2(z_1, a_1)), \mathbf{m}_2(z_2, a_2)) \\ &= 0 \\ &= \mathbf{n}(x \otimes 1, z, \mathfrak{J}_{0,0,0}(\mathbf{m}_1(a_1, a_2))) \end{aligned}$$

Note that the second equality follows from the fact that the product structures on \mathcal{C}_i are strictly associative.

The case $(k_1, k_2) = (0, 1)$ is similar. In case $(k_1, k_2) = (0, 0)$ we calculate:

$$\begin{aligned} & \mathbf{n}(1 \otimes 1, z, \delta(\mathfrak{J}_{0,0,0}(a_1, a_2))) \\ &= \mathbf{m}_1(\mathbf{n}(1 \otimes 1, z, \mathfrak{J}_{0,0,0}(a_1, a_2))) - \mathbf{n}(1 \otimes 1, \mathbf{m}_1(z), \mathfrak{J}_{0,0,0}(a_1, a_2)) \\ &= (\mathbf{m}_1(\mathbf{m}_2(z_1, a_1)), \mathbf{m}_2(z_2, a_2)) + (\mathbf{m}_2(z_1, a_1), \mathbf{m}_1(\mathbf{m}_2(z_2, a_2))) \\ &\quad - (\mathbf{m}_2(\mathbf{m}_1(z_1), a_1), \mathbf{m}_2(z_2, a_2)) - (\mathbf{m}_2(z_1, a_1), \mathbf{m}_2(\mathbf{m}_1(z_2), a_2)) \\ &= \mathbf{n}(1 \otimes 1; z; \mathfrak{J}_{0,0,0}(\mathbf{m}_1(a_1, a_2))). \end{aligned}$$

We thus proved that $\mathfrak{J}_{0,0,0}$ is a chain map. Note that the fact the equality holds with the sign since we always use Koszul sign here, as we mentioned during the proof of (16.15).

The calculation to show that \mathfrak{J} is a tri-module homomorphism is similar. We omit it. \square

We remark that \mathfrak{J} is a bijection on objects. So to prove Lemma 16.7 it suffices to show that $\mathfrak{J}_{0,0,0}$ is a chain homotopy equivalence. We will prove it below.⁷³ We write \mathfrak{J} in place of $\mathfrak{J}_{0,0,0}$, for simplicity.

We define a map $\mathfrak{J} : \mathbf{M}(\mathbf{C}; \mathbf{C})(\mathfrak{c}, \mathfrak{b}) \rightarrow \mathbf{M}(\mathcal{C}_1, \mathcal{C}_2; \mathbf{C})(\mathfrak{c}, \mathfrak{b})$ by

$$\mathfrak{J}(\mathcal{T}) = \mathbf{n}(1; (\mathbf{e}, \mathbf{e}); \mathcal{T}). \quad (16.23)$$

Here \mathbf{e} is the unit of \mathcal{C}_i and $\mathcal{T} \in \mathbf{C}$.

Sublemma 16.19. \mathfrak{J} is a chain map. \diamond

Proof.

$$\mathbf{m}_1(\mathfrak{J}(\mathcal{T})) = \mathbf{m}_1(\mathbf{n}(1; \mathbf{m}_1(\mathbf{e}, \mathbf{e}); \mathcal{T})) + \mathbf{n}(1; (\mathbf{e}, \mathbf{e}); \delta(\mathcal{T})) = \mathbf{n}(1; (\mathbf{e}, \mathbf{e}); \delta(\mathcal{T})).$$

\square

We calculate

$$\mathfrak{J}(\mathfrak{J}(a_1, a_2)) = \mathbf{n}(1; (\mathbf{e}, \mathbf{e}); \mathfrak{J}(a_1, a_2)) = (a_1, a_2).$$

⁷²In the calculation below we omit the Koszul sign unless otherwise mentioned.

⁷³The proof below is similar to a proof of A_∞ Yoneda's lemma. The key idea of the proof of Yoneda's lemma is plugging in the identity morphisms to obtain an inverse to the Yoneda embedding. We follow this idea. In fact (16.23) is nothing but plugging in the identity morphism. In the case of usual Yoneda's lemma then it defines an inverse. In the A_∞ case, it is only a chain homotopy inverse. So we need to find a chain homotopy. The chain homotopy (16.24) is similar to one given in [Fu7] for the A_∞ Yoneda's lemma.

Therefore $\mathfrak{J} \circ \mathfrak{J} = \text{id}$. We finally prove $\mathfrak{J} \circ \mathfrak{J}$ is chain homotopic to the identity map. We define the maps $\mathcal{H}_i : \mathbf{C}(\mathbf{c}_1, \mathbf{c}_2) \rightarrow \mathbf{C}(\mathbf{c}_1, \mathbf{c}_2)$ by the next formula.

$$\begin{aligned} \mathbf{n}(\mathbf{x} \otimes \mathbf{y}; z; \mathcal{H}_1(\mathcal{T})) &= (-1)^{*1} \mathbf{n}((\mathbf{x} \otimes z_1) \otimes \mathbf{y}; (\mathbf{e} \otimes z_2); \mathcal{T}) \\ \mathbf{n}(\mathbf{x} \otimes \mathbf{y}; z; \mathcal{H}_2(\mathcal{T})) &= (-1)^{*2} \mathbf{n}(\mathbf{x} \otimes (\mathbf{y} \otimes z_2); (z_1 \otimes \mathbf{e}); \mathcal{T}), \end{aligned} \quad (16.24)$$

where $*_1 = \text{deg}' z_2 + \text{deg}' \mathbf{x} \text{deg}' z_1$, $*_2 = \text{deg}' z_1 \text{deg}' z_2$. We will calculate $\delta \circ \mathcal{H}_i + \mathcal{H}_i \circ \delta$, where δ is the boundary operator of \mathbf{C} . We define maps $\Phi_i : \mathbf{C}(\mathbf{c}_1, \mathbf{c}_2) \rightarrow \mathbf{C}(\mathbf{c}_1, \mathbf{c}_2)$ by the next formula.

$$\begin{aligned} &\mathbf{n}(\mathbf{x} \otimes \mathbf{y}; z; \Phi_1(\mathcal{T})) \\ &= \begin{cases} (-1)^{*3} \mathbf{n}(z_1 \otimes 1; \mathbf{n}(1 \otimes \mathbf{y}; (\mathbf{e} \otimes z_2); \mathcal{T})) & \text{if } \mathbf{x} = 1 \\ 0 & \text{otherwise} \end{cases} \\ &\mathbf{n}(\mathbf{x} \otimes \mathbf{y}; z; \Phi_2(\mathcal{T})) \\ &= \begin{cases} (-1)^{*4} \mathbf{n}(1 \otimes z_2; \mathbf{n}(\mathbf{x} \otimes 1; (z_1 \otimes \mathbf{e}); \mathcal{T})) & \text{if } \mathbf{y} = 1 \\ 0 & \text{otherwise} \end{cases}, \end{aligned} \quad (16.25)$$

where $*_3 = \text{deg}' z_1 \text{deg}' \mathbf{y} + (\text{deg}' \mathbf{y} + \text{deg}' z_2) + \text{deg}' z_2$, $*_4 = \text{deg}' z_2 \text{deg}' \mathbf{x} + \text{deg}' \mathbf{x} \text{deg}' z_1$.

Sublemma 16.20.

$$\delta \circ \mathcal{H}_i + \mathcal{H}_i \circ \delta = \text{id} + \Phi_i.$$

◇

Proof. We write $\mathbf{x} = x_f \otimes \mathbf{x}_R = \mathbf{x}_L \otimes x_l$. and $\mathbf{y} = y_f \otimes \mathbf{y}_R = \mathbf{y}_L \otimes y_l$. We first calculate omitting all the signs.

$$\begin{aligned} &\mathbf{n}(\mathbf{x} \otimes \mathbf{y}; z; (\mathcal{H}_1 \circ \delta)(\mathcal{T})) \\ &= \mathbf{n}((\mathbf{x} \otimes z_1) \otimes \mathbf{y}; (\mathbf{e} \otimes z_2); \delta(\mathcal{T})) \\ &= \mathbf{m}(\mathbf{n}((\mathbf{x} \otimes z_1) \otimes \mathbf{y}; (\mathbf{e} \otimes z_2); \mathcal{T})) \\ &\quad + \mathbf{n}^{\mathcal{C}}(x_f \otimes 1; \mathbf{n}(\mathbf{x}_R \otimes z_1) \otimes \mathbf{y}; (\mathbf{e} \otimes z_2); \mathcal{T}) \\ &\quad + \mathbf{n}((\mathbf{x} \otimes \mathbf{y}); z; \Phi_1(\mathcal{T})) \\ &\quad + \mathbf{n}^{\mathcal{C}}(1 \otimes y_f; \mathbf{n}((\mathbf{x} \otimes z_1) \otimes \mathbf{y}_R; (\mathbf{e} \otimes z_2); \mathcal{T})) \\ &\quad + \mathbf{n}((\widehat{\mathbf{m}}(\mathbf{x}) \otimes z_1) \otimes \mathbf{y}; (\mathbf{e} \otimes z_2); \mathcal{T}) \\ &\quad + \mathbf{n}((\mathbf{x} \otimes \mathbf{m}(z_1)) \otimes \mathbf{y}; (\mathbf{e} \otimes z_2); \mathcal{T}) \\ &\quad + \mathbf{n}((\mathbf{x}_L \otimes \mathbf{m}_2(x_l, z_1)) \otimes \mathbf{y}; (\mathbf{e} \otimes z_2); \mathcal{T}) \\ &\quad + \mathbf{n}((\mathbf{x} \otimes z_1) \otimes \widehat{\mathbf{m}}(\mathbf{y}); (\mathbf{e} \otimes z_2); \mathcal{T}) \\ &\quad + \mathbf{n}((\mathbf{x} \otimes z_1) \otimes \mathbf{y}; (\mathbf{e} \otimes \mathbf{m}_1(z_2)); \mathcal{T}) \\ &\quad + \mathbf{n}(\mathbf{x} \otimes \mathbf{y}; (z_1 \otimes z_2); \mathcal{T}). \end{aligned}$$

Here $\mathbf{n}^{\mathcal{C}}$ is the structure operation of left $\mathcal{C}_1, \mathcal{C}_2$ bimodule structure on $\mathcal{C}_1 \otimes \mathcal{C}_2$. (\mathbf{n} is defined at the beginning of the proof of Lemma 16.7.)

We also calculate

$$\begin{aligned}
& \mathbf{n}(\mathbf{x} \otimes \mathbf{y}; z; (\delta \circ \mathcal{H}_1)(\mathcal{T})) \\
&= \mathbf{m}(\mathbf{n}((\mathbf{x} \otimes z_2) \otimes \mathbf{y}; (\mathbf{e} \otimes z_1); \mathcal{T})) \\
&\quad + \mathbf{n}^{\mathcal{C}}(x_f \otimes \mathbf{1}; \mathbf{n}((\mathbf{x} \otimes z_1) \otimes \mathbf{y}; (\mathbf{e} \otimes z_2); \mathcal{T})) \\
&\quad + \mathbf{n}^{\mathcal{C}}(\mathbf{1} \otimes y_f; \mathbf{n}((\mathbf{x} \otimes z_1) \otimes \mathbf{y}_R; (\mathbf{e} \otimes z_2); \mathcal{T})) \\
&\quad + \mathbf{n}((\widehat{\mathbf{m}}(\mathbf{x} \otimes \mathbf{y}) \otimes (z_1 \otimes \mathbf{1}); (\mathbf{e} \otimes z_2); \mathcal{T})) \\
&\quad + \mathbf{n}((\mathbf{x} \otimes \mathbf{m}(z_1)) \otimes \mathbf{y}; (\mathbf{e} \otimes z_2); \mathcal{T}) \\
&\quad + \mathbf{n}((\mathbf{x} \otimes z_1) \otimes \mathbf{y}; (\mathbf{e} \otimes \mathbf{m}_1(z_2)); \mathcal{T}) \\
&\quad + \mathbf{n}((\mathbf{x}_L \otimes \mathbf{m}_2(x_l, z_1)) \otimes \mathbf{y}; (\mathbf{e} \otimes z_2); \mathcal{T}) \\
&\quad + \mathbf{n}((\mathbf{x} \otimes z_1) \otimes \mathbf{y}_L; (\mathbf{e} \otimes \mathbf{m}_2(y_l \otimes z_2)); \mathcal{T}).
\end{aligned}$$

We remark that all the terms of the first formula except the 3rd and 10th ones appear in the second formula. The formula for \mathcal{H}_1 thus follows up to sign.

Remark again that all the signs are caused by changing the order of operators or elements (which are graded), that is by Koszul rule. So except the minus sign which comes from exchanging the order of δ and \mathcal{H}_i (both of which are degree ± 1) the sign of the corresponding terms coincide.

Therefore the cancellation occurs with signs. Thus the formula for \mathcal{H}_1 holds with sign.

The proof of the formula for \mathcal{H}_2 is similar. \square

Sublemma 16.20 implies that $\Phi_1 \circ \Phi_2$ is chain homotopic to the identity. It is easy to see that $\Phi_1 \circ \Phi_2 = \mathcal{J} \circ \mathfrak{J}$. The proof of Lemma 16.7 is complete. \square

Proof of Lemma 16.6. We define

$$\mathcal{S}_{1,1} : \mathcal{C}_1[1](c_{1,1}, c_{1,2}) \otimes \mathcal{C}_2[1](c_{2,1}, c_{2,2}) \rightarrow \mathbf{C}(c_1, c_2),$$

by (16.22) and define all the other $\mathcal{S}_{k,\ell}$ to be zero. It is easy to see that it defines a DG-functor. (We use the assumption that \mathcal{C}_1 and \mathcal{C}_2 are DG-categories here.) We proved, during the proof of Lemma 16.7, that $\mathcal{S}_{1,1}$ is a chain homotopy equivalence. The lemma now follows from Theorem 2.28. \square

Proof of Lemma 16.16. Let $\mathbf{c}_i = (L_i, b_i)$, $\mathbf{c}'_i = (L'_i, b'_i)$. Note that $\mathcal{L}((\mathbf{c}'_1, \mathbf{c}'_2), (\mathbf{c}_1, \mathbf{c}_2)) \cong CF(L'_1, L_1) \otimes CF(L'_2, L_2) \cong \mathcal{C}_1(c'_1, c_1) \otimes \mathcal{C}_2(c'_2, c_2)$.

On the other hand, we use the fact that the filtered A_∞ category obtained by Lagrangian Floer theory becomes a DG-category, after reduction of coefficient to the ground ring, the reduction of the map $\mathcal{S}_{1,1}$ is given by Formula (16.22). Here we use the fact that \mathcal{F}_{k_1, k_2} in (16.14) is 0 for $(k_1, k_2) \neq (0, 0)$ and is an isomorphism for $(k_1, k_2) = (0, 0)$.

It is easy to see that the reduction of \mathcal{S}_1 is the same map. Therefore the reduction of \mathcal{S}_1 to the ground ring is a chain homotopy equivalence. It implies that \mathcal{S}_1 is a chain homotopy equivalence. \square

17. ORIENTATION AND SIGN

In this section we discuss the orientation and the sign. The orientation of the moduli spaces of pseudo-holomorphic quilts is studied by [WW4]. The orientation of the moduli spaces of pseudo-holomorphic disks (polygons) and its relation to A_∞ structures is studied in detail in [FOOO1, Chapter 8]. In this section, we will

prove that orientation and sign appearing in various moduli spaces and operations in this paper can be reduced to ones of the moduli spaces of pseudo-holomorphic disks and operations defined by it.

17.1. Koszul rule in A_∞ structures. As we mentioned several times the sign in various formulas in this paper is by Koszul rule, (except a few cases which appear in purely algebraic situations. See the beginning of Subsection 10.5.). By this reason we do not write the explicit sign in many of those formulas. In principle it is possible (and not so difficult) to calculate and put the explicit sign to those formulas. However actually it is unnecessary to calculate the sign for the purpose of this paper. This is because the check of the signs in the equalities needed in this paper is carried out based on the fact that the sign is always by Koszul rule and *not* by an explicit calculation of the signs. Since some of such formulas are complicated, checking the signs by an explicit calculation could be cumbersome and lengthy. Fortunately we never need it in this paper.

In this subsection we describe what we mean by Koszul rule precisely and demonstrate how it works in certain examples.

We first consider the A_∞ formula:

$$0 = \sum_{k_1+k_2=k+1} \sum_{i=0}^{k_1-1} (-1)^* \mathbf{m}_{k_1}(x_1, \dots, x_i, \mathbf{m}_{k_2}(x_{i+1}, \dots, x_{k_2}), \dots, x_k). \quad (17.1)$$

Here the sign is given by

$$* = i + \sum_{j=1}^i \deg x_j. \quad (17.2)$$

We explain how this sign is determined by the Koszul rule. We order variables and operations appearing in the formula as follows.⁷⁴

$$\mathbf{m}, \mathbf{m}, x_1, x_2, \dots, x_k \quad (17.3)$$

In one of the terms of (17.1) it appears in the following order

$$\mathbf{m}, x_1, x_2, \dots, \mathbf{m}, x_{i+1}, \dots, x_k. \quad (17.4)$$

The permutation of operators and variables we need to go from (17.3) to (17.4) is a composition of permutations of \mathbf{m} and x_j for $j = 1, \dots, i$. We remark that the degree of \mathbf{m} is 1 and the (shifted) degree of x_j is $1 + \deg x_j$. So the sign we pick up by exchanging them is $1 + \deg x_j$. Summing them up for $j = 1, \dots, i$ we obtain the sign (17.2).⁷⁵

In this way we can obtain the signs appearing in various formulas systematically. The author emphasizes that this is not only an idea to define a sign but is also a logical and rigorous *definition* of the sign.

⁷⁴The particular choice of orders in (17.3) is not important. If we take another choice then the sign in the formulas changes in exactly the same way for all the terms of (17.1).

⁷⁵There are several other sign conventions of A_∞ structure in the literature. For example Stasheff [St]'s original convention and Seidel [Se2]'s convention are different from our convention, which is introduced in [FOOO1]. An advantage of our convention lies in the fact that it is *exactly* by Koszul rule. Therefore we can automatically determine all the signs appearing in various formulas by requiring them to be the Koszul convention. Since there are many operators which are related to but are slightly different each other in this paper, putting the sign 'by hand' and checking the consistency by a calculation becomes much cumbersome and lengthy. We can avoid it by using Koszul convention in all the places.

To elaborate on this rule let us describe one more example. We consider Formula (9.30) in Proposition 9.11. In a similar way to (17.3) we start with

$$\mathcal{Y} \mathcal{T}, \mathbf{m}, h_{\infty,123}, \mathbf{h}_{12}, \mathbf{h}_{23}, \mathbf{h}_{13}, h_{\infty,12}, h_{\infty,23}, \mathbf{h}_1, \mathbf{h}_2, \mathbf{h}_3. \quad (17.5)$$

(Here the symbol \mathbf{m} appears. It is identified with \mathbf{n} while studying certain terms of (9.30).) In the third term where $(-1)^{*3}$ appears, the operations and variables appear in the order

$$\mathcal{Y} \mathcal{T}, h_{\infty,123}, \mathbf{h}_{12}, \mathbf{h}_{23}, \mathbf{h}_{13}^{c;1}, \mathbf{m}, \mathbf{h}_{13}^{c;2}, \mathbf{h}_{13}^{c;3}, h_{\infty,12}, h_{\infty,23}, \mathbf{h}_1, \mathbf{h}_2, \mathbf{h}_3 \quad (17.6)$$

Here we put

$$((\Delta \otimes \text{id}) \circ \Delta)(\mathbf{h}_{13}) = \sum_c \mathbf{h}_{13}^{c;1} \otimes \mathbf{h}_{13}^{c;2} \otimes \mathbf{h}_{13}^{c;3}$$

and remark that

$$\hat{d}(\mathbf{h}_{13}) = \sum_c (-1)^{\deg' \mathbf{h}_{13}^{c;1}} \mathbf{h}_{13}^{c;1} \otimes \mathbf{m}(\mathbf{h}_{13}^{c;2}) \otimes \mathbf{h}_{13}^{c;3}. \quad (17.7)$$

The sign we pick up to go from (17.5) to (17.6) is $(-1)^*$ with

$$* = \deg' h_{\infty,123} + \deg' \mathbf{h}_{12} + \deg' \mathbf{h}_{23} + \deg' \mathbf{h}_{13}^{c;1}.$$

Since $\deg' \mathbf{h}_{13}^{c;1}$ cancels with the corresponding sign in (17.7), we have:

$$*3 = \deg' h_{\infty,123} + \deg' \mathbf{h}_{12} + \deg' \mathbf{h}_{23}.$$

We next consider the 9th term where $(-1)^{*9}$ appears. The order of the operations and variables appearing in this term is:

$$\mathcal{Y} \mathcal{T}, h_{\infty,123}, \mathbf{h}_{12}, \mathbf{h}_{23}^{c;1}, \mathbf{h}_{13}, h_{\infty,12}, \mathbf{n}, \mathbf{h}_2^{c;1}, \mathbf{h}_3^{c;1}, \mathbf{h}_{23}^{c;2}, h_{\infty,23}, \mathbf{h}_1, \mathbf{h}_2^{c;2}, \mathbf{h}_3^{c;2}. \quad (17.8)$$

The sign we pick up to go from (17.5) to (17.8) is

$$\begin{aligned} & \deg' h_{\infty,123} + \deg' \mathbf{h}_{12} + \deg' \mathbf{h}_{23}^{c;1} + \deg' \mathbf{h}_{13} + \deg' h_{\infty,12} \\ & + \deg' \mathbf{h}_{23}^{c;2} (\deg' \mathbf{h}_{13} + \deg' h_{\infty,12} + \deg' \mathbf{h}_2^{c;1} + \deg' \mathbf{h}_3^{c;1}) \\ & + \deg' h_{\infty,23} (\deg' \mathbf{h}_2^{c;1} + \deg' \mathbf{h}_3^{c;1}) \\ & + \deg' \mathbf{h}_1 (\deg' \mathbf{h}_2^{c;1} + \deg' \mathbf{h}_3^{c;1}) \\ & + \deg' \mathbf{h}_2^{c;2} \deg' \mathbf{h}_3^{c;1}. \end{aligned}$$

This is by definition $*_9$. The other $*_k$ is defined in the same way. Note that there is a minus sign in front of the 10th term. This minus sign is caused by the fact that the order of \mathbf{n} and $\mathcal{Y} \mathcal{T}$ is exchanged (only) in this term.

The formula we gave for $*_9$ above is rather complicated and actually it is not useful to write it down explicitly. On the other hand, it is important that there is a well-defined and canonical way to determine the signs.

The latter fact is used, for example, in the following way. During the proof of Theorem 10.16 in Subsection 10.4, we claimed that the Y-diagram transformation is a quatio-module homomorphism. In other words, the formula which implies that a pre-quatio-module homomorphism is a quatio-module homomorphism coincides with Formula (9.30) in Proposition 9.11. It is easy to see that the terms appearing in those two formulas are the same except possibly the sign. We also need to check the signs appearing in those two formulas coincide. Since there are many terms to be checked and since the signs (such as $*_9$ above) are rather complicated to write

down explicitly, verifying this coincidence by calculating the signs in those formulas could be cumbersome and lengthy. Fortunately we do not need to carry out any calculation to check the coincidence of the signs, since this fact is an *immediate* consequence of the fact that both signs are by Koszul rule.

The author also remarks that the way we use Koszul rule here is equivalent to a certain point in the study of A_∞ , L_∞ structures and their cousins by using the language of supermanifolds and super-vector-fields on it. See for example [AKSZ] for such a method. In those methods, calculation of the explicit sign is avoided by saying several objects are functions, vector fields, etc. in the sense of supermanifolds.

Another point where we use the fact that all the signs are by Koszul rule is the proof of the fact that after adding appropriate correction terms and putting appropriate orientations, the operations obtained from moduli spaces satisfy the basic formulas with *Koszul sign*. The way we will prove it in this section is as follows. We describe the way how various moduli spaces such as those used to define tri-module structures, Y-diagram transformations, Double pants transformations, and etc. can be identified to moduli spaces of holomorphic disks (polygons) outside a certain subspace lying in strata of positive codimension. Then we use the conclusion of the papers on the construction of A_∞ operations in Lagrangian Floer theory *with sign* (such as [FOOO2, FOOO13, ST]) so that there *exists* a way to define orientations of those moduli spaces and correction terms of the signs, by importing ones of the corresponding moduli space of pseudo-holomorphic disks via the identification we will give in this section. Then the A_∞ formula of operations in Lagrangian Floer theory implies the basic formulas on tri-module structures, Y-diagram transformations, Double pants transformations, and etc. *with signs*. This is because they both are by Koszul rule. We will explain this process more in a concrete situation in Example 17.3. We emphasize that this proof does not need to use the proof of the signs for the A_∞ formula of Lagrangian Floer theory, in the literature. It uses only the *conclusion* of those papers. In fact, there could be several different ways to put orientations and correction terms of the signs so that the A_∞ formula of Lagrangian Floer theory can be proved. The argument of this section is independent on such choices. For each choice of system of orientations and correction terms in Lagrangian Floer theory, we can expand it to the case of tri-module structures, Y-diagram transformations, Double pants transformations, and etc. We also remark that we will *not* provide explicit correction terms to define tri-module structures, Y-diagram transformations, Double pants transformations, and etc. In principle it is possible to find it by going back to the corresponding discussions in the case of Lagrangian Floer theory and modify it by Koszul rule. See Subsection 17.2 and Example 17.3.⁷⁶ However doing so in many places are rather cumbersome and lengthy process. Fortunately we do not need to do so, since we only claim the *existence* of the correction terms of the signs. Existence of such correction terms is certainly enough to prove all the results in this paper.

⁷⁶If we want to do so, we would need to see the detail of the proof of the signs in Lagrangian Floer theory. For example it occupies more than 70 pages in [FOOO2]. So, it seems likely that many of the readers do *not* want to go back and see the proof in the literature and try to understand how it is adapted to our situation. The way we take in this section is written in such a way that it is unnecessary for the readers to do so.

17.2. Orientation of the moduli space of the simplest quilt. In this subsection we consider the case of the moduli space $\mathring{\mathcal{M}}_{\text{QT}}(\vec{a}_1, \vec{a}_{12}, \vec{a}_2; a_-, a_+; E)$ which is defined in Definition 5.27. For simplicity we begin with the case when $\vec{a}_1, \vec{a}_{12}, \vec{a}_2$ are empty sets, that is, the case we do not consider marked points. (We will discuss the case when there are marked points later in this subsection.) We write this moduli space as $\mathring{\mathcal{M}}_{\text{QT}}(L_1, L_{12}, L_2; a_-, a_+; E)$, where a_\pm are connected components of $\tilde{L}_1 \times_{X_1} \tilde{L}_{12} \times_{X_2} \tilde{L}_2$. When we are interested in defining orientation only it suffices to consider its subset consisting of a map from a strip $\Sigma = [-1, 1] \times \mathbb{R}$. We write this subset as $\mathcal{M}_{\text{QT}}^{\text{reg}}(L_1, L_{12}, L_2; a_-, a_+; E)$. It is an equivalence class of maps $((u_1, u_2), (\gamma_1, \gamma_{12}, \gamma_2))$, where $u_1 : [-1, 0] \times \mathbb{R} \rightarrow X_1$, $u_2 : [0, 1] \times \mathbb{R} \rightarrow X_2$ and $\gamma_i : \mathbb{R} \rightarrow L_i$ ($i = 1, 2$), $\gamma_{12} : \mathbb{R} \rightarrow L_{12}$ and they have the following properties:

$$(A.1) \quad u_1(-1, \tau) = i_{L_1}(\gamma_1(\tau)), \quad u_2(1, \tau) = i_{L_2}(\gamma_2(\tau)) \text{ and}$$

$$(u_1(0, \tau), u_2(0, \tau)) = i_{L_{12}}(\gamma_{12}(\tau)).$$

(A.2) We require asymptotic boundary condition Condition 5.29.

(A.3) u_1, u_2 are assumed to be J_1, J_2 holomorphic, respectively.

(A.4)

$$\int_{[-1, 0] \times \mathbb{R}} u_1^* \omega_1 + \int_{[0, 1] \times \mathbb{R}} u_2^* \omega_2 = E.$$

We define $\text{Dub}((u_1, u_2), (\gamma_1, \gamma_{12}, \gamma_2))$ as $(u; \gamma_l, \gamma_r)$ such that:

(B.1) $u : [0, 1] \times \mathbb{R} \rightarrow -X_1 \times X_2$ is defined by

$$u(\tau, t) = (u_1(-t, \tau), u_2(t, \tau)).$$

(B.2) $\gamma_r = \gamma_{12} : \mathbb{R} \rightarrow \tilde{L}_{12}$. $\gamma_l : \mathbb{R} \rightarrow \tilde{L}_1 \times \tilde{L}_2$ is defined by

$$\gamma_l(\tau) = (\gamma_1(\tau), \gamma_2(\tau)).$$

By definition u is $-J_1 \times J_2$ holomorphic.

We consider the disjoint union $L = (L_1 \times L_2) \cup L_{12}$. Then (u, γ_l, γ_r) becomes an element of $\mathring{\mathcal{M}}(L, (a_-, a_+); E)$ which is defined in Definition 3.19. Here we write it as $\mathring{\mathcal{M}}(L_{12}, L_1 \times L_2; (a_-, a_+); E)$. This is the moduli space used in [FOOO1, Subsection 3.7.4] to define the boundary operator on $CF(L_{12}, L_1 \times L_2)$.

We thus obtain an open embedding

$$\text{Dob} : \mathcal{M}_{\text{QT}}^{\text{reg}}(L_1, L_{12}, L_2; a_-, a_+; E) \rightarrow \mathring{\mathcal{M}}(L_{12}, L_1 \times L_2; (a_-, a_+); E). \quad (17.9)$$

We assumed that L_{12} is $\pi_1^*(V_1 \oplus TX_1) \oplus \pi_2^*V_2$ relatively spin.

We also assumed L_1 is V_1 relatively spin and so is $V_1 \oplus TX_1$ relatively spin. In fact since $TX_1|_{L_1} = TL_1 \otimes_{\mathbb{R}} \mathbb{C}$ and TL_1 is oriented. So $TX_1|_{L_1}$ has canonical spin structure. We assumed L_2 is V_2 relatively spin. Therefore $L_1 \times L_2$ is also $\pi_1^*(V_1 \oplus TX_1) \oplus \pi_2^*V_2$ relatively spin.

Thus by Proposition 3.29 we have an isomorphism of principal $O(1)$ bundle

$$O_{\mathcal{M}^{\text{reg}}(a_-, a_+; E)} \cong O_{\mathring{\mathcal{M}}(L, (a_-, a_+); E)} \cong \text{ev}_-^* \Theta_{a_-}^- \otimes \text{ev}_+^* \Theta_{a_+}^+. \quad (17.10)$$

We can use the isomorphism (17.10) to define

$$\text{ev}_+! \circ \text{ev}_-^* : \Omega(R_{a_-}; \Theta_{a_-}^-) \rightarrow \Omega(R_{a_+}; \Theta_{a_+}^-)$$

by smooth correspondence. This is (5.34) in case we do not have boundary marked points.

We next show the consistency of orientations at the boundary.

Remark 17.1. Before doing so we explain what we mean by ‘consistency of orientations at the boundary’ more precisely. We consider the ‘open inclusion’

$$(-1)^{*_1} \mathcal{M}_{k_1+1}(L; \beta_1)_{\text{ev}_i} \times_{\text{ev}_0} \mathcal{M}_{k_2+1}(L; \beta_2) \subseteq \partial \mathcal{M}_{k+1}(L; \beta)$$

where $k_1 + k_2 = k$, $\beta_1 + \beta_2 = \beta$. Here $*_1$ is a certain correction term of the sign.⁷⁷ This is an example of consistency of orientations at the boundary. Namely the orientations of the moduli spaces appearing in the left and right hand sides of the formula coincide. To give a rigorous meaning to its coincidence we also need to fix a convention of the orientation of the fiber product (as well as the boundary).

The ‘consistency of orientations at the boundary’ are supposed to imply the fundamental equation (in this case the A_∞ relation) *with sign*, which is the Koszul sign in this paper. Let us elaborate on this point. Let $C(L)$ be a certain chain model of the cohomology of the space $\tilde{L} \times_X \tilde{L}$. (In this paper we take de Rham model.) The moduli space $\mathcal{M}_{k+1}(L; \beta)$ regarded as a correspondence from L^k to L gives an operation, which is

$$\mathfrak{m}_{k,\beta} : C(L)^{\otimes k} \rightarrow C(L).$$

In the case of de Rham model, it is

$$(h_1, \dots, h_k) \mapsto (-1)^{*_2} \text{ev}_{0!}(\text{ev}_1^* h_1 \wedge \dots \wedge \text{ev}_k^* h_k)$$

(More precisely we need CF-perturbations.) To make sense of this formula we need to fix a convention of sign for integration along fiber $\text{ev}_{0!}$. (Provably the sign convention for the pull back ev_i^* is mostly obvious.) Here $*_2$ is a certain correction term of the sign. Thus we have to fix all the conventions mentioned above together with correction terms $*_1$, $*_2$ so that the operator $\mathfrak{m}_{k,\beta}$ satisfies the A_∞ relation with Koszul sign.

In the case of this A_∞ relation, this is worked out in singular chain complex model in [FOOO2] and in de Rham model in [FOOO13] and [ST], in the case when our Lagrangian submanifold is embedded. In the case of an immersed Lagrangian submanifold which has transversal self-intersection, it is worked out in [AJ] in singular chain complex model. In the case of an immersed Lagrangian submanifold which has self-clean intersection, it is written in Subsection 17.6 in singular chain complex model and in Appendix by Kaoru Ono in de Rham model. We use the conclusion of those results (but not the proof of them).

The sign convention of [FOOO2] and of [FOOO13] are different⁷⁸ but they both satisfy the same A_∞ formula with the same sign. (Note that if we regard smooth singular chains as currents and approximate them by smooth differential forms, then we can ask whether various conventions (the convention of the sign of push out (=integration along the fiber) or pull back), together with correction terms $*_2$ ⁷⁹ gives the same operator $\mathfrak{m}_{k,\beta}$ with sign or not.)⁸⁰ The author did not check whether the convention of [FOOO13] coincides with [ST] or not. The convention of [AJ] is slightly different from [FOOO2] at the point which we mention in Proposition 17.39.

⁷⁷ $\overline{\mathcal{M}}_{k+1}(L; \beta)$ is the compactified moduli space of pseudo-holomorphic disks with $k+1$ boundary marked points and of homology class $\beta \in \pi_2(X, L)$.

⁷⁸In fact the sign of \mathfrak{m}_1 is different.

⁷⁹which is not the same in two books

⁸⁰The correction term $*_1$ coincide in those two books.

The sign part of the works [FOOO2], [FOOO13], [ST], [AJ] is computational.⁸¹ The conventions and correction terms are defined by ‘hand’ and the sign part of the A_∞ formula is checked by computation. It might be possible to give more conceptual proof. So far no such proof is written in the literature. Since the check of sign in many cases are complicated and pains taking such a proof would be desired. However it is not a theme of this paper.

The discussion of this section, which reduces the sign issue of this paper to one of A_∞ relation among \mathfrak{m} , is not computational. \diamond

Remark 17.2. In several places we write explicit correction terms (written as $(-1)^{*1}, (-1)^{*2}$ in Remark 17.1), following the convention of [FOOO13], [ST]. However actually we never used these particular choices or the choices of other conventions. We use only the fact that there *exist* such choices which induce A_∞ formula with Koszul sign. \diamond

We go back to the discussion of consistency of orientations at the boundary. We first observe that the boundary of the compactification $\mathcal{M}_{\text{QT}}(L_1, L_{12}, L_2; a_-, a_+; E)$ of the moduli space $\mathcal{M}_{\text{QT}}^{\text{reg}}(L_1, L_{12}, L_2; a_-, a_+; E)$ consists of four kinds of components depicted in Figures 20-23.

On the other hand, the codimension one boundary component of the compactification $\mathcal{M}(L_{12}, L_1 \times L_2; (a_-, a_+); E)$ of $\mathring{\mathcal{M}}(L_{12}, L_1 \times L_2; (a_-, a_+); E)$ is described by one of the configurations (1), (2), (3) depicted in Figures 107 below.

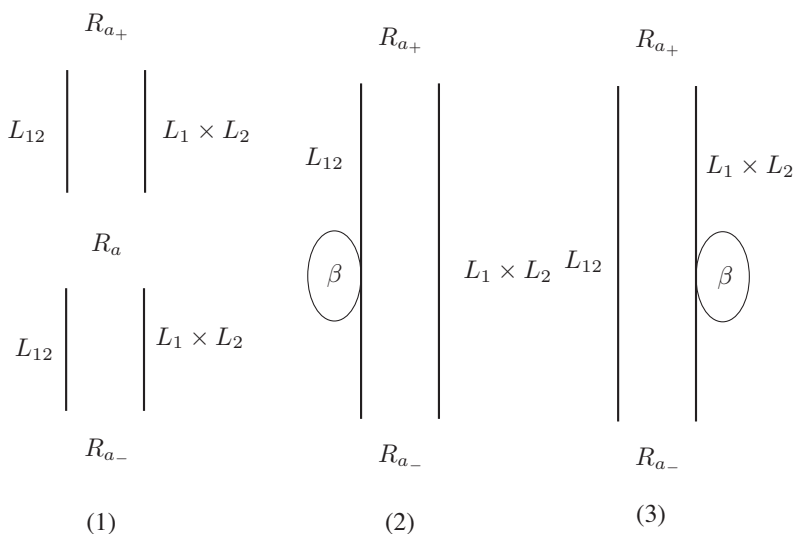

FIGURE 107. Boundary components of $\mathcal{M}(L_1, L_{12}, L_2; a_-, a_+; E)$.

We observe that Figure 107 (1) and (2) correspond to Figure 20 and 22 respectively. Since the orientation is defined so that (17.9) lifts to the isomorphism of orientation bundles (principal $O(1)$ bundles) the compatibility of the orientation of the moduli space, the compactification of $\mathcal{M}_{\text{QT}}^{\text{reg}}(L_1, L_{12}, L_2; a_-, a_+; E)$, at the

⁸¹There are geometric ideas behind those computations in many cases. However such ideas are not used during the proof.

boundary described by Figure 20 and 22 follows from the corresponding compatibility of $\mathcal{M}(L_{12}, L_1 \times L_2; (a_-, a_+); E)$ at the boundary described by Figure 107 (1) and (2). The latter is established in [FOOO1, Chapter 8, Theorem 8.8.10 etc.].

We finally consider the boundary described by Figure 107 (3). The homology class of the bubbled disk is $\beta \in \pi_2(X_1 \times X_2; L_1 \times L_2; \mathbb{Z}) = \pi_2(X_1; L_1; \mathbb{Z}) \times \pi_2(X_2; L_2; \mathbb{Z})$. We write it (β_1, β_2) . We consider the following three cases separately.

(Case 1: $\beta_1 \neq 0 \neq \beta_2$) The configuration which corresponds to an element of $\mathcal{M}^{\text{reg}}(L_1, L_{12}, L_2; a_-, a_+; E)$ of this case is depicted in Figure 108 below. We remark that this component has codimension greater than 1. Therefore we do not need to study this case to show the consistency of the orientation at the boundary.

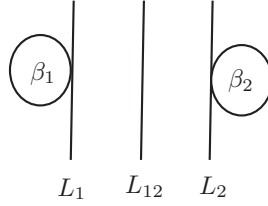

FIGURE 108. Case 1.

(Case 2: $\beta_1 = 0 \neq \beta_2$) This case corresponds to Figure 23. Therefore the consistency of orientation at this boundary component follows from the corresponding discussion for Figure 23, which is in [FOOO1, Chapter 8, Theorem 8.8.10 etc.].

(Case 3: $\beta_1 \neq 0 = \beta_2$) This case corresponds to Figure 21. Therefore the consistency of orientation at this boundary component follows from [FOOO1, Chapter 8], except the following points.

For an element $((u_1, u_2), (\gamma_1, \gamma_{12}, \gamma_2))$ of $\mathcal{M}^{\text{reg}}(L_1, L_{12}, L_2; a_-, a_+; E)$, we require u_1 to be $-J_1$ holomorphic. Since in Case 3 bubble occurs at the line $t = -1$, the map in the bubble is $-J_1$ holomorphic. We also consider the map $(t, \tau) \mapsto u_1(-t, \tau)$. Note we use $V_1 \oplus TX_1$ relative spin structure of L_1 for our orientation. As was shown as Theorem 3.54, the orientation of the moduli space of $-J_1$ holomorphic map $(t, \tau) \mapsto u_1(-t, \tau)$ using $V_1 \oplus TX_1$ relative spin structure, coincides with one of u_1 using J_1 holomorphic map moduli space using V_1 relative spin structure, after reversing the enumeration of the boundary marked points. This is consistent with the fact that we study opposite category for L_1 . Moreover we use $V_1 \oplus TX_1$ relative spin structure in place of V_1 relative spin structure for orientation. As is shown in Subsection 3.5 this is equivalent to use $-J_{X_1}$ instead of J_{X_1} .

Note that the above discussion proves Theorem 5.43 (7).

We next include the case when there are marked points and explain the way to fix the sign of the operations $\mathfrak{n}_{k_1, k_{12}, k_2}^{E, \epsilon}$ in (5.34).

We use the notations in (5.34). We put $m = k_1 + k_2$. We denote by $\text{Shuf}(k_1, k_2)$ the set of pairs of maps (I_1, I_2) , where $I_j : \{1, \dots, k_j\} \rightarrow \{1, \dots, m\}$ such that

- (1) The image of I_1 and I_2 are disjoint.
- (2) I_1 reverses the order.
- (3) I_2 preserves the order.

For $I = (I_1, I_2) \in \text{Shuf}(k_1, k_2)$ we write

$$\mathfrak{r}_j^I = \begin{cases} x_i & \text{if } I_1(i) = j \\ z_i & \text{if } I_2(i) = j. \end{cases} \quad (17.11)$$

Let

$$\begin{aligned} \mathfrak{n}_{m, k_{12}}^E : B_m CF(L_1 \times L_2) \otimes CF(L_1 \times L_2; L_{12}) \otimes B_{k_{12}} CF(L_{12}) \\ \rightarrow CF(L_1 \times L_2; L_{12}) \end{aligned}$$

be the filtered A_∞ bimodule structure for the pair of Lagrangian submanifolds $L_1 \times L_2, L_{12}$ of $X_1 \times X_2$. (More precisely its coefficient of T^E .) This is defined in [FOOO1, Definition 3.7.41] in the singular homology version. The de Rham version is a part of the structure operation of the filtered A_∞ category associated to the symplectic manifold $X_1 \times X_2$, which we defined in Theorem 3.49. See also [FOOO13, ST].

The discussion in the case without marked point, implies that in our case the moduli space we use to define the filtered tri-module structure $\mathfrak{n}_{k_1, k_{12}, k_2}^{E, \epsilon}$ coincides with the closure of union of the moduli spaces defining $\mathfrak{n}_{m, k_{12}}^E$ for various $I = (I_1, I_2) \in \text{Shuf}(k_1, k_2)$, outside codimension 1 set. Namely we have

$$\mathfrak{n}_{k_1, k_{12}, k_2}^{E, \epsilon}(\mathbf{x}, \mathbf{y}, w, \mathbf{z}) = \sum_{I \in \text{Shuf}(k_1, k_2)} (-1)^{*I} \mathfrak{n}_{m, k_{12}}^E(\mathbf{y}, w, \mathfrak{r}^I). \quad (17.12)$$

Here the sign $(-1)^{*I}$ is the Koszul sign, which is determined as follows. We remark that $\mathfrak{r}^I, w, \mathbf{y}$ coincide with $\mathbf{x}, \mathbf{y}, \mathbf{z}$ up to exchanging the order. So we shift the degree of them by one and put the sign which arises when we exchange the order of those variables via Koszul rule.

For example if $k_1 = 2, k_2 = 1$ and $k_{12} = 1$ and $\text{Im}(I_1) = \{1, 3\}$ then the corresponding term is

$$(-1)^* \mathfrak{n}_{1,3}(y_1, w, x_2, z_1, x_1).$$

where

$$\begin{aligned} * &= \text{deg}' x_1 (\text{deg}' y_1 + \text{deg}' w' + \text{deg}' x_2 + \text{deg}' z_1) \\ &+ \text{deg}' x_2 (\text{deg}' y_1 + \text{deg}' w') + \text{deg}' w \text{deg}' y_1 \end{aligned}$$

is the sign which we get to exchange

$$y_1, w, x_2, z_1, x_1 \mapsto x_1, x_2, y_1, w, z_1.$$

See Figure 109 and Example 17.3. The bimodule structure \mathfrak{n} satisfies the relation,

$$\begin{aligned} \sum_{a_1, a_2} (-1)^* \mathfrak{n}(\mathbf{y}_{a_1}^{(1)}, \mathfrak{n}(\mathbf{y}_{a_1}^{(2)}, w, \mathfrak{r}_{a_2}^{(1)}), \mathfrak{r}_{a_2}^{(2)}) \\ + \sum_a (-1)^* \mathfrak{n}(\mathbf{y}_a^{(1)} \otimes \mathfrak{m}(\mathbf{y}_a^{(2)}) \otimes \mathbf{y}_a^{(3)}, w, \mathfrak{r}) \\ + \sum_a (-1)^* \mathfrak{n}(\mathbf{y}, w, \mathfrak{r}_a^{(1)} \otimes \mathfrak{m}(\mathfrak{r}_a^{(2)}) \otimes \mathfrak{r}_a^{(3)}). \end{aligned} \quad (17.13)$$

Here $\Delta(\mathbf{y}) = \sum_{a_1} \mathbf{y}_{a_1}^{(1)} \otimes \mathbf{y}_{a_1}^{(2)}$, $(\Delta \otimes 1)(\Delta(\mathbf{y})) = \sum_a \mathbf{y}_a^{(1)} \otimes \mathbf{y}_a^{(2)} \otimes \mathbf{y}_a^{(3)}$ etc.

The sign $*$ in (17.13) is the Koszul sign. The relation (17.13) is [FOOO1, Theorem 3.7.72] in singular homology version and is a part of Theorem 3.49 in de Rham version. The Koszul sign rule is a consequence of [FOOO1, Chapter 8, Theorem 8.8.10].

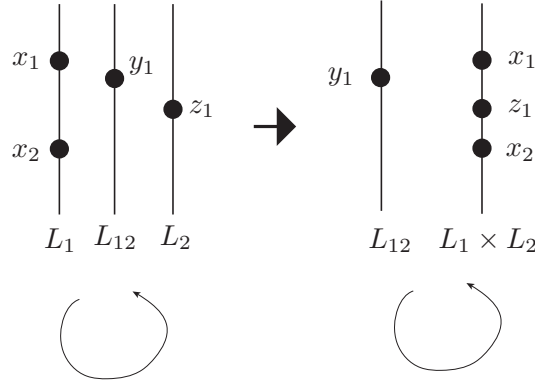

FIGURE 109. Enumeration of marked points assigned to $L_1 \times L_2$.

Since the sign is always by Koszul rule in this paper, the (tri-module analogue of) the formula (5.19), where the sign is also by Koszul rule, is a consequence of (17.13), once we take the next two points (dif.1) (dif.2) into account.

(dif.1) When we put $\mathfrak{r} = \mathfrak{r}^I$ in Formula (17.13), the third sum contains a term where \mathfrak{m} is applied to both x_i 's and z_i 's. For example if $k_1 = 2$, $k_2 = 1$ and $k_{12} = 1$ and $\text{Im}(I_1) = \{1, 3\}$ a term such as

$$\pm n_{1,2}(y_1, w, x_2, \mathfrak{m}_2(z_1, x_1)) \tag{17.14}$$

appears. There is no corresponding term in (5.19). The reason is as follows. The compactification we take for the moduli space $\mathcal{M}_{\text{QT}}(L_1, L_{12}, L_2; \vec{a}_1, \vec{a}_{12}, \vec{a}_2; a_-, a_+; E)$ which we used to define (5.19) is different from the compactification of $\mathring{\mathcal{M}}(L_{12}, L_1 \times L_2; (a_-, a_+); E)$ which we use to define $n_{m, k_{12}}$. More specifically the configuration such as Figure 108 (with marked points included) do *not* appear in the codimension one boundary of $\mathcal{M}_{\text{QT}}(L_1, L_{12}, L_2; \vec{a}_1, \vec{a}_{12}, \vec{a}_2; a_-, a_+; E)$. As we observed before, this is a special case of the codimension one boundary described in Figure 107 (2), which gives a term such as (17.14).

Note that this fact does not affect the discussion of sign of the other components which both appear in (5.19) and (17.13).

(def.2) We remark the following three points.

- For $(I_1, I_2) \in \text{Shuf}(k_1, k_2)$ we require I_1 to be order *reversing*.
- When we consider the bubble which occurs at L_1 for the compactified moduli space $\mathcal{M}_{\text{QT}}(L_1, L_{12}, L_2; \vec{a}_1, \vec{a}_{12}, \vec{a}_2; a_-, a_+; E)$, the map on this bubble is regarded as a J_1 holomorphic map. On the other hand, when we consider the corresponding object as a bubble in an element of the compactification of $\mathring{\mathcal{M}}(L_{12}, L_1 \times L_2; (a_-, a_+); E)$ the map on the bubble is regarded as a $-J_1$ holomorphic map by using appropriate anti-holomorphic map $D^2 \rightarrow D^2$.
- We regard L_1 as $V_1 \oplus TX_1$ relatively spin when we consider the moduli space $\mathcal{M}_{\text{QT}}(L_1, L_{12}, L_2; \vec{a}_1, \vec{a}_{12}, \vec{a}_2; a_-, a_+; E)$ but as V_1 relatively spin when we consider $\mathring{\mathcal{M}}(L_{12}, L_1 \times L_2; (a_-, a_+); E)$.

By Theorem 3.54 these three points cancel out and we obtain the correct sign.

Example 17.3. Let us elaborate on this fact more by an explicit example. Let us consider the moduli space depicted in Figure 109. We first study the boundary component depicted in Figure 110 below.

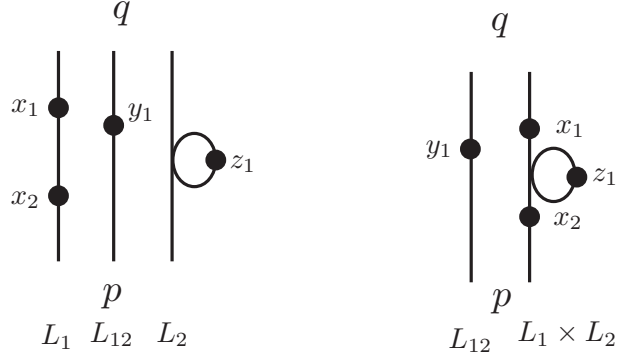

FIGURE 110. A boundary component of Figure 109.

The left figure corresponds to

$$\langle \mathbf{n}_{2,1;1}(x_1, x_2; y_1; p; \mathbf{m}_1(z_1)), q \rangle \quad (17.15)$$

Here p and q are chains of $(L_1 \times L_2) \times_{X_1 \times X_2} L_{12}$ appearing at $\tau \rightarrow \pm\infty$. The right figure corresponds to

$$\langle \mathbf{n}_{1,3}(y_1; p; x_2, \mathbf{m}_1(z_1), x_1), q \rangle \quad (17.16)$$

Note that in the A_∞ relation of tri-module, (17.15) appears with sign $(-1)^{*1}$ where

$$*1 = \deg' x_1 + \deg' x_2 + \deg' y_1 + \deg' p.$$

In the A_∞ relation of Lagrangian Floer theory (the A_∞ bi-module structure on $CF(L_{12}, L_1 \times L_2)$), (17.16) appears with sign $(-1)^{*2}$ where

$$*2 = \deg' y_1 + \deg' p + \deg' x_2.$$

We next study the boundary component depicted in Figure 111 below. The left figure corresponds to

$$\langle \mathbf{n}_{1,1;0}(x_1, y_1; \mathbf{n}_{1,0;1}(x_2; p; z_1)), q \rangle \quad (17.17)$$

and the right figure corresponds to

$$\langle \mathbf{n}_{1,1}(y_1, \mathbf{n}_{0,2}(p, x_2, z_1), x_1), q \rangle. \quad (17.18)$$

(17.17) comes with sign $(-1)^{*3}$ where

$$*3 = \deg' x_1 + \deg' y_1 + \deg' x_2 \deg' y_1.$$

(17.18) comes with sign $(-1)^{*4}$ where

$$*4 = \deg' y_1.$$

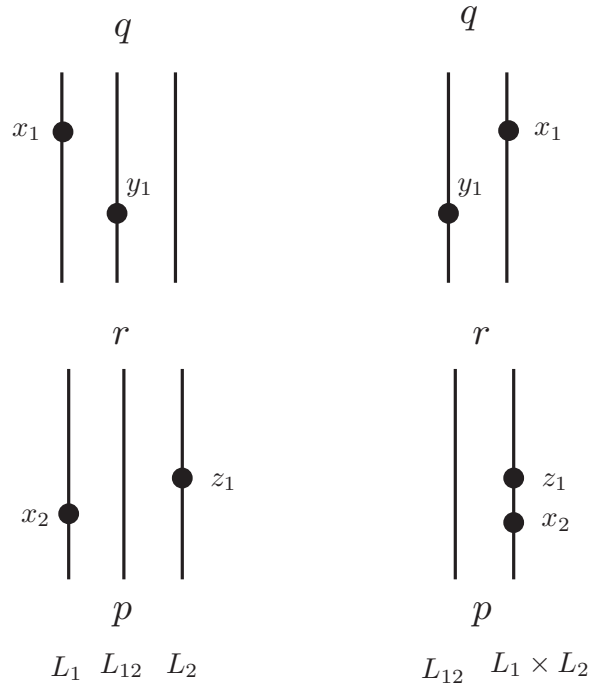

FIGURE 111. Another boundary component of Figure 109.

Thus the A_∞ formula of the tri-module structure \mathbf{n} which we want to prove is of the form

$$\begin{aligned}
 0 = & \dots \\
 & + (-1)^{*1} \mathbf{n}_{2,1;1}(x_1, x_2; y_1; p; \mathbf{m}_1(z_1)) \\
 & + \dots \\
 & + (-1)^{*3} \mathbf{n}_{1,1;0}(x_1, y_1; \mathbf{n}(x_2; p; z_1)) \\
 & + \dots,
 \end{aligned} \tag{17.19}$$

and the A_∞ formula for operations \mathbf{n}, \mathbf{m} which was proved in the literature is

$$\begin{aligned}
 0 = & \dots \\
 & + (-1)^{*2} \mathbf{n}_{1,3}(y_1, p, x_2, \mathbf{m}_1(z_1), x_1) \\
 & + \dots \\
 & + (-1)^{*4} \mathbf{n}_{1,1}(y_1, \mathbf{n}_{0,2}(p, x_2, z_1), x_1) \\
 & + \dots.
 \end{aligned} \tag{17.20}$$

We claim that (17.19) is a consequence of (17.20). To see this we calculate the difference of signs between \mathbf{n} 's and \mathbf{m} 's.

We note that for $v = \mathbf{m}_1(z_1)$ we have

$$\mathbf{n}_{2,1;1}(x_1, x_2; y_1; p; v) = (-1)^{*5} \mathbf{n}_{1,3}(y_1, p, x_2, v, x_1)$$

where $*_5$ is the Koszul sign induced by the change of the order of variables

$$x_1, x_2, y_1, p, v \longrightarrow y_1, p, x_2, v, x_1.$$

Therefore

$$\begin{aligned} *_5 &= \deg' x_1(\deg' x_2 + \deg' y_1 + \deg' p + \deg' v) \\ &\quad + \deg' x_2(\deg' y_1 + \deg' p) \\ &= \deg' x_1(\deg' x_2 + \deg' y_1 + \deg' p + \deg' z_1 + 1) \\ &\quad + \deg' x_2(\deg' y_1 + \deg' p). \end{aligned}$$

We have also:

$$\mathbf{n}_{1,1}(x_2; p; z_1) = (-1)^{*6} \mathbf{n}_{0,2}(p, x_2, z_1)$$

where $*_6$ is the Koszul sign induced by the change of the order of variables

$$x_2, p, z_1 \longrightarrow p, x_2, z_1.$$

Therefore

$$*_6 = \deg' x_2 \deg' p.$$

For $w = \pm \mathbf{n}_{0,2}(p, x_2, z_1)$ we have

$$\mathbf{n}_{1,1;0}(x_1, y_1; w) = (-1)^{*7} \mathbf{n}_{1,1}(y_1, w, x_1)$$

where $*_7$ is the Koszul sign induced by the change of the order of variables

$$x_1, y_1, w \longrightarrow y_1, w, x_1.$$

Therefore

$$\begin{aligned} *_7 &= \deg' x_1(\deg' y_1 + \deg' w) \\ &= \deg' x_1(\deg' y_1 + \deg' p + \deg' x_2 + \deg' z_1 + 1). \end{aligned}$$

The claim that (17.19) is a consequence of (17.20) follows from the congruence

$$*_1 + *_2 + *_3 + *_4 + *_5 + *_6 + *_7 \equiv 0 \pmod{2}. \quad (17.21)$$

One can check (17.21) by calculating the formula of $*_i$ given explicitly above. However actually we do not need any calculation to show (17.21), since (17.21) is an immediate consequence of the fact that the map from permutation group to $\{\pm 1\}$ which associates the Koszul sign to each permutation is a group homomorphism.

In fact both $*_1 + *_2 + *_5$ and $*_3 + *_4 + *_6$ are the Koszul sign associated to the permutation

$$\mathbf{n}, \mathbf{n}, x_1, x_2, y_1, p, z_1 \rightarrow \mathbf{n}, \mathbf{n}, y_1, p, x_2, z_1, x_1.$$

By this reason the discussion of this example can be easily generalized to other cases, as far as the sign of the formulas we want to prove is by Koszul rule and we are given an identification of the moduli spaces we use to moduli spaces of pseudo-holomorphic disks (polygons).

17.3. Orientation of the moduli space of pseudo-holomorphic drums.

In this subsection we study the orientation of the moduli space of pseudo-holomorphic drums, Definition 8.15. The quilted domain W there is divided into three pieces W_1 , W_2 and W_3 and $u_i : W_i \rightarrow X_i$ is $-J_{X_i}$ holomorphic. We identify $W_i = [-1, 1] \times \mathbb{R}$ and put

$$W_i^- = [-1, 0] \times \mathbb{R}, \quad W_i^+ = [0, 1] \times \mathbb{R}$$

Let u_i^+ , u_i^- be the restriction of u_i to W_i^+ , W_i^- . We define $\hat{u}_i = (\hat{u}_i^-, \hat{u}_i^+) : [0, 1] \times \mathbb{R} \rightarrow X_i^2$ by

$$\hat{u}_i^-(t, \tau) = u_i^-(t, \tau), \quad \hat{u}_i^+(t, \tau) = u_i^+(-t, \tau)$$

Then

$$(\hat{u}_1, \hat{u}_2, \hat{u}_3) : [-1, 0] \times \mathbb{R} \rightarrow (-X_1 \times X_1) \times (-X_2 \times X_2) \times (-X_3 \times X_3),$$

is pseudo-holomorphic. See Figures 112 and 113. In Figure 112 we add 3 extra seams that are depicted by dotted lines in Figure 112. The boundary condition becomes the product of diagonals $\prod_{i=1}^3 \Delta_{X_i}$ at the boundary $\{0\} \times \mathbb{R}$ and is $L_{13} \times L_{12} \times L_{23}$ at the boundary $\{1\} \times \mathbb{R}$.

Let L be the disjoint union of $\prod_{i=1}^3 \Delta_{X_i}$ and $L_{13} \times L_{12} \times L_{23}$. It is an immersed Lagrangian submanifold of $\prod_{i=1}^3 (-X_i \times X_i)$.

We decompose

$$\prod_{i=1}^3 \Delta_{X_i} \times_{\prod_{i=1}^3 (-X_i \times X_i)} (\tilde{L}_{13} \times \tilde{L}_{12} \times \tilde{L}_{23})$$

into components $R_{123}(a)$, $a \in \mathcal{A}$.

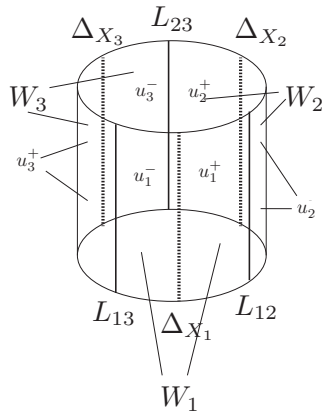

FIGURE 112. Adding diagonal to a drum.

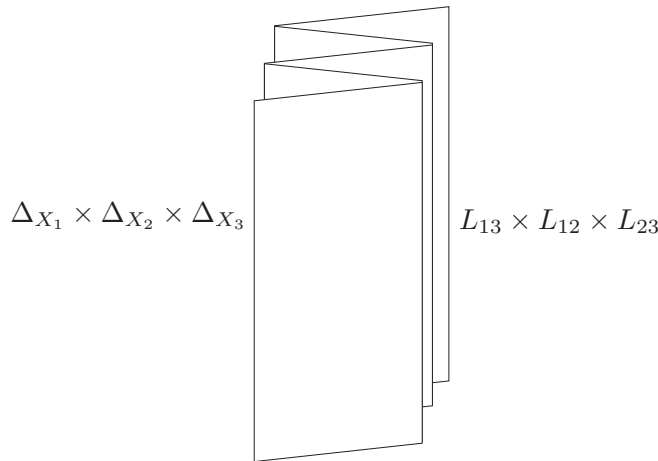

FIGURE 113. Regard a drum as a strip.

Thus the above construction defines a map

$$\begin{aligned} \text{Dob} : \mathcal{M}_{\text{DR}}^{\text{reg}}(L_{13}, L_{12}, L_{23}; a_-, a_+; E) \\ \rightarrow \overset{\circ}{\mathcal{M}}(\Delta_{X_1} \times \Delta_{X_2} \times \Delta_{X_3}, L_{13} \times L_{12} \times L_{23}; a_-, a_+; E). \end{aligned} \quad (17.22)$$

Here the moduli space $\overset{\circ}{\mathcal{M}}_{\text{DR}}(L_{13}, L_{12}, L_{23}; a_-, a_+; E)$ is a special case of the moduli space $\overset{\circ}{\mathcal{M}}_{\text{DR}}(\vec{a}_{13}, \vec{a}_{12}, \vec{a}_{23}; a_-, a_+; E)$ in Definition 8.15, where $\vec{a}_{13}, \vec{a}_{12}, \vec{a}_{23}$ are empty sets.⁸² $\overset{\circ}{\mathcal{M}}(\Delta_{X_1} \times \Delta_{X_2} \times \Delta_{X_3}, L_{12} \times L_{23} \times L_{13}; a_-, a_+; E)$ is the part of $\overset{\circ}{\mathcal{M}}(L, a_-, a_+; E)$ which is used to define the boundary operator

$$\begin{aligned} \mathfrak{n}_{0,0} : CF(\Delta_{X_1} \times \Delta_{X_2} \times \Delta_{X_3}, L_{12} \times L_{23} \times L_{13}) \\ \rightarrow CF(\Delta_{X_1} \times \Delta_{X_2} \times \Delta_{X_3}, L_{12} \times L_{23} \times L_{13}). \end{aligned}$$

(17.22) is an isomorphism of Kuranishi structure and so we can use orientation of the right hand side to define orientation of the left hand side. This implies Proposition 8.19 (3). We remark that once Proposition 8.19 (3) is proved then the choice of σ_{13} , the relative spin structure of the geometric composition $L_{13} = L_{12} \times_{X_2} L_{23}$ is obtained in the same way as the proof of Lemma 6.7. Namely we apply Proposition 8.19 in the case $L_{13} = L_{12} \times_{X_2} L_{23}$. Then the triple fiber product

$$\Delta \times_{X_1^2 \times X_2^2 \times X_3^2} (\tilde{L}_{12} \times \tilde{L}_{23} \times \tilde{L}_{13}) = \bigcup_{a \in \mathcal{A}_{123}} R_{123}(a) \quad (17.23)$$

contains a ‘diagonal component’ which is diffeomorphic to \tilde{L}_{13} . We can use Lemma 3.11 to prove the unique existence of the relative spin structure σ_{13} on \tilde{L}_{13} so that the orientation bundle Θ_- induced on the diagonal component \tilde{L}_{13} is trivial.

Now we include boundary marked points. In other words, we use the structure operation of the bimodule structure

$$\begin{aligned} \mathfrak{n}_{k,m} : B_k CF[1](\Delta_{X_1} \times \Delta_{X_2} \times \Delta_{X_3}) \\ \otimes CF(\Delta_{X_1} \times \Delta_{X_2} \times \Delta_{X_3}, L_{12} \times L_{23} \times L_{13}) \\ \otimes B_m CF[1](L_{12} \times L_{23} \times L_{13}) \\ \rightarrow CF(\Delta_{X_1} \times \Delta_{X_2} \times \Delta_{X_3}, L_{12} \times L_{23} \times L_{13}) \end{aligned} \quad (17.24)$$

to define the structure operations:

$$\begin{aligned} \mathfrak{n}_{k_{13}, k_{12}, k_{23}}^{\text{tri}, < E_0, \epsilon} : CF(L_{13})^{\otimes k_{13}} \otimes CF(L_{12})^{\otimes k_{12}} \\ \otimes CF(L_{13}, L_{12}, L_{23}) \otimes CF(L_{23})^{\otimes k_{23}} \rightarrow CF(L_{13}, L_{12}, L_{23}). \end{aligned} \quad (17.25)$$

of the tri-module structure. We use appropriate triples I_{13}, I_{12}, I_{23} which splits $\{1, \dots, m\}$ ($m = k_{13} + k_{12} + k_{23}$), in the same way as (17.12). We use again the Koszul sign rule. Namely (17.25) is a sum with Koszul sign of (17.24) over the choice of I_{13}, I_{12}, I_{23} . (In (17.24) we put $k = 0$. See (def.3).)

Now taking into account similar points as (dif.1) (dif.2) and the next point (dif.3), the bi-module property of (17.24) implies the tri-module property (8.24) of (17.25), *with sign*.

(def.3) The bubble at the Lagrangian submanifold $\Delta_{X_1} \times \Delta_{X_2} \times \Delta_{X_3}$ appears in the compactification $\mathcal{M}(\Delta_{X_1} \times \Delta_{X_2} \times \Delta_{X_3}, L_{12} \times L_{23} \times L_{13}; a_-, a_+; E)$ but there is

⁸²In other words we do not put marked points on the seams.

no corresponding boundary component in the compactification of the moduli space $\mathcal{M}_{\text{DR}}^{\text{reg}}(L_{13}, L_{12}, L_{23}; a_-, a_+; E)$.

In fact the disk bubble at $\Delta_{X_1} \times \Delta_{X_2} \times \Delta_{X_3}$ corresponds to the *sphere* bubble of an element of $\mathcal{M}_{\text{DR}}^{\text{reg}}(L_{13}, L_{12}, L_{23}; a_-, a_+; E)$ at the seams depicted by the dotted lines in Figure 112. Since they are sphere bubbles and occurs in codimension ≥ 2 , they do not contribute the formula. In other words, we can consider only $k = 0$ case of (17.24) and obtain a left $CF(L_{13})$ $CF(L_{12})$ and right $CF(L_{23})$ tri-module structure.

17.4. Orientation of the moduli space of Y -diagrams. In this subsection we study orientation of the moduli space of Y -diagrams. We consider Y -diagram as in Figure 36 and Definition 9.6. We put 3 extra seams which are depicted by dotted lines in Figure 114 below. The domain \mathcal{Y} in Figure 36 is divided into three pieces \mathcal{Y}_i ($i = 1, 2, 3$). The added seams divide each of \mathcal{Y}_i into two pieces $\mathcal{Y}_{i,+}$ and $\mathcal{Y}_{i,-}$ as depicted in Figure 114.

Definition 9.6 defines a moduli space $\overset{\circ}{\mathcal{M}}_{\mathcal{Y}}(\vec{a}_{12}, \vec{a}_{23}, \vec{a}_{13}; \vec{a}_1, \vec{a}_2, \vec{a}_3, a_{\infty,-}, \vec{a}_{\infty,+}; E)$. We consider the case when $\vec{a}_{12}, \vec{a}_{23}, \vec{a}_{13}; \vec{a}_1, \vec{a}_2, \vec{a}_3$ are all empty sets and write it as $\overset{\circ}{\mathcal{M}}_{\mathcal{Y}}(L_1, L_2, L_3; L_{12}, L_{23}, L_{13}; a_{\infty,-}, \vec{a}_{\infty,+}; E)$.

We consider an element $(\Sigma; \vec{z}_1, \vec{z}_2, \vec{z}_3; \vec{z}_{12}, \vec{z}_{23}, \vec{z}_{13}; u_1, u_2, u_3; \gamma_1, \gamma_2, \gamma_3; \gamma_{12}, \gamma_{23}, \gamma_{13})$ of the moduli space $\overset{\circ}{\mathcal{M}}_{\mathcal{Y}}(L_1, L_2, L_3; L_{12}, L_{23}, L_{13}; a_{\infty,-}, \vec{a}_{\infty,+}; E)$. We restrict u_i to $\mathcal{Y}_{i,+}$ and $\mathcal{Y}_{i,-}$ and obtain u_i^+ and u_i^- .

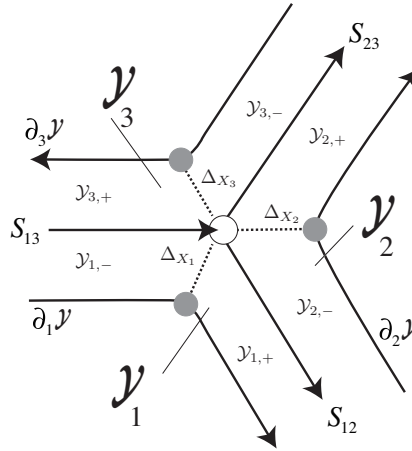

FIGURE 114. Split domains in the Y -diagram

We identify $\mathcal{Y}_{i,+}$ and $\mathcal{Y}_{i,-}$ with a triangle \mathfrak{T} in Figure 115. We use a holomorphic map to identify $\mathcal{Y}_{i,+}$ with \mathfrak{T} and an anti-holomorphic map to identify $\mathcal{Y}_{i,-}$ with \mathfrak{T} . By this identification the point depicted by the white circle (resp. the gray circles) in Figure 114 is sent to the point depicted by the white circle (resp. the gray circle) in Figure 115. Three ends of the domain \mathcal{Y} in Figure 114 is sent to the black circle in Figure 115. Thus u_i^+ and u_i^- ($i = 1, 2, 3$) altogether induce a pseudo-holomorphic map

$$\hat{u} : \mathfrak{T} \rightarrow \prod_{i=1}^3 (-X_i \times X_i).$$

At the three boundary components the map \hat{u} satisfies the boundary condition given by the Lagrangian submanifolds $\prod_{i=1}^3 \Delta_{X_i}$, $L_{12} \times L_{23} \times L_{13}$, $L_1^2 \times L_2^2 \times L_3^2$, respectively.

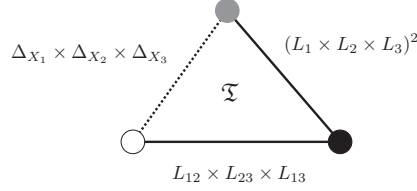

FIGURE 115. Reglue maps from the Y-diagram

The boundary conditions at the three vertices are obtained as follows. $a_{\infty,-}$ assigns a component $R_{123}(a_{\infty,-})$ of the fiber product (17.23). (See (9.6).) This boundary condition is used at the vertex depicted by white circles in Figure 115. We next use $\vec{a}_{\infty,+} = (a_{\infty,+12}, a_{\infty,+23}, a_{\infty,+13})$. Then determine components $R_{ii'}(a_{\infty,+ii'})$ of

$$\tilde{L}_i \times_{X_i} \tilde{L}_{ii'} \times_{X_{i'}} \tilde{L}_{i'}.$$

(See (9.5).) Here $(ii') = (12), (23), (13)$. Then the boundary condition at the black circles is given by

$$R(\vec{a}_{\infty,+}) := R_{12}(a_{\infty,+12}) \times R_{23}(a_{\infty,+23}) \times R_{13}(a_{\infty,+13}). \quad (17.26)$$

We finally describe the boundary condition at the vertex drawn by gray circle in Figure 115.

It should be a component of the fiber product

$$\left(\prod_{i=1}^3 \Delta_{X_i} \right) \times_{\prod_{i=1}^3 (-X_i \times X_i)} L_1^2 \times L_2^2 \times L_3^2.$$

We take the diagonal component $\cong \tilde{L}_1 \times \tilde{L}_2 \times \tilde{L}_3$ and its fundamental class as the boundary condition. We denote by

$$\begin{aligned} \mathcal{M}_3^{\text{reg}}(\prod \Delta_{X_i}, L_{12} \times L_{23} \times L_{13}, L_1^2 \times L_2^2 \times L_3^2 \\ ; \Delta, R_{123}(a_{\infty,-}), R(\vec{a}_{\infty,+}); E) \end{aligned}$$

the moduli space of such holomorphic triangles.

Thus the above construction defines a map:

$$\begin{aligned} \text{Dob} : \overset{\circ}{\mathcal{M}}_Y(L_1, L_2, L_3; L_{12}, L_{23}, L_{13}; a_{\infty,-}, \vec{a}_{\infty,+}; E) \\ \rightarrow \mathcal{M}_3^{\text{reg}}(\prod \Delta_{X_i}, L_{12} \times L_{23} \times L_{13}, L_1^2 \times L_2^2 \times L_3^2 \\ ; \Delta, R_{123}(a_{\infty,-}), R(\vec{a}_{\infty,+}); E). \end{aligned} \quad (17.27)$$

The orientation of the right hand side of (17.27) is defined by Proposition 3.29. We thus define the orientation of $\overset{\circ}{\mathcal{M}}_Y(L_1, L_2, L_3; L_{12}, L_{23}, L_{13}; a_{\infty,-}, \vec{a}_{\infty,+}; E)$ so that (17.27) preserves orientation. This proves Proposition 9.8 (3).

We show the compatibility of the orientation at the boundary below. We consider the codimension one boundary component of the target of (17.27). We divide it into various cases.

(Case 1) Disk bubble at $\prod \Delta_{X_i}$. There is no corresponding codimension one boundary component in the source of (17.27). In fact this corresponds to the sphere bubble at the seams depicted by the dotted lines in Figure 114. This occurs in codimension ≥ 2 .

(Case 2) Disk bubble at $L_{12} \times L_{23} \times L_{13}$. This corresponds to the disk bubble in Figure 39. The homotopy class β of such disk is determined by

$$\pi_2 \left(\prod_{i=1}^3 (X_i \times X_i), L_{12} \times L_{23} \times L_{13} \right) \cong \prod_{(ii')=(12),(23),(13)} \pi_2(X_i \times X_{ii'}; L_{ii'}).$$

If $\beta = (\beta_{12}, \beta_{23}, \beta_{13})$ and at least two of $\beta_{12}, \beta_{23}, \beta_{13}$ are nonzero, then there is no corresponding component in the source of (17.27). The reason is the same as the reason why Figure 108 appears in codimension ≥ 2 . Therefore it suffices to consider the case when only one of $\beta_{12}, \beta_{23}, \beta_{13}$ is nonzero. The boundary component corresponding to such cases corresponds to the boundary component described by Figure 39. Therefore the orientation is consistent at this boundary component.

(Case 3) Disk bubble at $L_1^2 \times L_2^2 \times L_3^2$. The homotopy class of such bubble is given by $(\prod (\pi_2(X_i, L_i)))^2$. By the same reason as above it suffices to consider the case only one of those 6 factors is nonzero. Then it corresponds to the boundary component depicted by Figure 40 in the right hand side. Thus the orientation is consistent at this boundary.

We next consider the boundary component corresponding to the three vertices of \mathfrak{T} .

(Case 4) The boundary component corresponding to the white vertex. This is described by the fiber product of

$$\mathcal{M}(\prod \Delta_{X_i}; L_{12} \times L_{23} \times L_{13}; R_{123}(a)) \quad (17.28)$$

with

$$\begin{aligned} \mathcal{M}_3^{\text{reg}}(\prod \Delta_{X_i}, L_{12} \times L_{23} \times L_{13}, L_1^2 \times L_2^2 \times L_3^2 \\ ; \Delta, R_{123}(a), R(\vec{a}_{\infty,+}); E) \end{aligned}$$

over $R_{123}(a)$. We apply the identification of (17.22) and (17.28). Then this boundary component corresponds to one in Figure 41. Thus the orientation is consistent at this boundary.

(Case 5) The boundary component corresponding to the black vertex. This is described by the fiber product of

$$\begin{aligned} \mathcal{M}_3^{\text{reg}}(\prod \Delta_{X_i}, L_{12} \times L_{23} \times L_{13}, L_1^2 \times L_2^2 \times L_3^2 \\ ; \Delta, (a_{\infty,-}), R(\vec{a}'_{\infty,+}); E) \end{aligned}$$

with

$$\mathcal{M}(L_{12} \times L_{23} \times L_{13}, L_1^2 \times L_2^2 \times L_3^2; R(\vec{a}'_{\infty,+}), R(\vec{a}_{\infty,+})) \quad (17.29)$$

taken over $R(\vec{a}'_{\infty,+})$. We put $\vec{a}'_{\infty,+} = (a'_{\infty,+12}, a'_{\infty,+23}, a'_{\infty,+13})$. In the case when two among the three inequalities $a'_{\infty,+12} \neq a_{\infty,+12}$, $a'_{\infty,+23} \neq a_{\infty,+23}$, $a'_{\infty,+13} \neq a_{\infty,+13}$, hold, the corresponding component in the source of (17.27) has codimension ≥ 2 . (The reason is the same as Case 2.) Therefore it suffices to consider the case when exactly one of the three inequalities $a'_{\infty,+12} \neq a_{\infty,+12}$,

$a'_{\infty,+23} \neq a_{\infty,+23}$, $a'_{\infty,+13} \neq a_{\infty,+13}$ hold. This case corresponds to one depicted in Figure 42. Thus the orientation is consistent at this boundary.

(Case 6) The boundary component corresponding to the gray vertex. The corresponding component in the source of (17.27) has codimension ≥ 2 . In fact it corresponds to the case when there is a disk bubble exactly at the gray vertex of Figure 114. This is a codimension 2 phenomenon.

We thus checked the consistency of the orientation at the codimension one component. We proved Proposition 9.8 (3).

Proof of Proposition 9.2 (1). Given L_1, L_2, L_{12}, L_{23} we consider the case when $\tilde{L}_{13} = \tilde{L}_{12} \times_{X_2} \tilde{L}_{23}$ and $\tilde{L}_3 = \tilde{L}_2 \times_{X_2} \tilde{L}_{23} = \tilde{L}_1 \times_{X_1} \tilde{L}_{23}$.

We take the diagonal component as a for $R_{123}(a)$ and $a_{\infty,+12}, a_{\infty,+23}, a_{\infty,+13}$ for $R(\vec{a}_{\infty,+})$.

Given relative spin structure σ_1, σ_{12} of $\tilde{L}_1, \tilde{L}_{12}$ we have chosen the relative spin structure σ_2 of \tilde{L}_2 so that the local system associated to $R_{12}(a_{\infty,+12}) \cong \tilde{L}_2$ is trivial. We also have chosen the relative spin structure σ_{13} of \tilde{L}_{13} so that the local system associated to $R_{123}(a) \cong \tilde{L}_{13}$ is trivial.

We consider the moduli space $\overset{\circ}{\mathcal{M}}(L_1, L_2, L_3; L_{12}, L_{23}, L_{13}; a_{\infty,-}, \vec{a}_{\infty,+}; 0)$ consisting of constant map. It corresponds to the moduli space of constant maps

$$\mathcal{M}_3^{\text{reg}}(\prod \Delta_{X_i}, L_{12} \times L_{23} \times L_{13}, L_1^2 \times L_2^2 \times L_3^2; \Delta, (a_{\infty,-}), R(\vec{a}'_{\infty,+}); 0).$$

This space is diffeomorphic to \tilde{L}_3 and is oriented.

Therefore by Proposition 3.29, for any choice of relative spin structure σ_3 of \tilde{L}_3 , the local system induced on $R_{13}(a_{\infty,+13}) \cong \tilde{L}_3$ is isomorphic to one on $R_{23}(a_{\infty,+23}) \cong \tilde{L}_3$.

If $\sigma_3 = \sigma_3^{(1)}$ then it is trivial for $R_{23}(a_{\infty,+23}) \cong \tilde{L}_3$. If $\sigma_3 = \sigma_3^{(2)}$ then it is trivial for $R_{13}(a_{\infty,+13}) \cong \tilde{L}_3$. Therefore $\sigma_3^{(1)} = \sigma_3^{(2)}$. Proposition 9.2 (1) is proved. \square

We next include marked points on the boundary of Y -diagram and will prove the equality (9.30) *with sign*.

Including marked points on the boundary the target of (17.27) becomes the moduli space which is used to define structure operation:

$$\begin{aligned} \mathfrak{m}_{m_1+m_2+m_3+3} : & BCF_{m_1} \left(\prod \Delta_{X_i} \right) \otimes CF(\Delta) \\ & \otimes BCF_{m_2} (L_{12} \times L_{23} \times L_{13}) \otimes CF(R_{123}(a)) \\ & \otimes BCF_{m_3} (L_1^2 \times L_2^2 \times L_3^2) \\ & \rightarrow CF(R(\vec{a}_{\infty,+}); E), \end{aligned} \quad (17.30)$$

of a filtered A_∞ category assigned to $\prod(-X_i \times X_i)$ and its Lagrangian submanifolds $\{\prod \Delta_{X_i}, L_1^2 \times L_2^2 \times L_3^2, L_{12} \times L_{23} \times L_{13}\}$. It satisfies the A_∞ relation. We convert first and second factor of the output

$$CF(R(\vec{a}_{\infty,+})) = CF(R(a_{\infty,+12})) \otimes CF(R(a_{\infty,+23})) \otimes CF(R(a_{\infty,+13}))$$

to the input by duality.

Then the operation (17.30) with an appropriate sign becomes the operator $\mathscr{Y} \mathscr{F}_{k_{12}, k_{23}, k_{13}; k_1, k_2, k_3}^{E, \epsilon}$ in (9.26). Here $m_1 = 0$, $m_2 = k_{12} + k_{23} + k_{13}$, $m_3 = k_1 + k_2 + k_3$. We use the Koszul rule in the same way as Subsections 17.2, 17.3, to define the sign.

Then taking into account (def.2), the A_∞ relation for (17.30) becomes the equality (9.30) with sign. (We use the fact that some of the terms of the A_∞ relation of (17.30) is absent in (9.30). The reason is explained in Cases 1-6 above.)

17.5. Orientation of the moduli space of double pants diagrams. In this subsection we study orientation of the moduli space of double pants diagrams. We draw double pants as in Figure 47 and put 12 seams as in Figure 116 below. In Figure 116 the new seams are depicted by dotted lines. We have new vertices also. There are 4 black vertices which are new. The circles of Figure 47 are now depicted by white vertices in Figure 116. There are 4 white vertices in Figure 116. Here the outer circle in Figure 116 should be regarded as a vertex. (In other words the domain should be regarded as S^2 .)

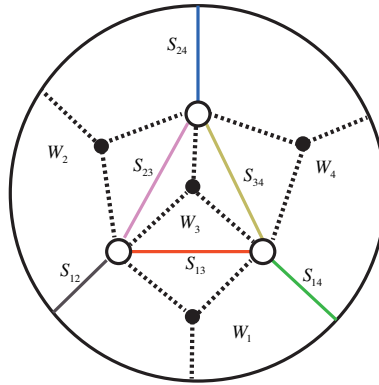

FIGURE 116. Adding seams to double pants

We cut the domain in Figure 116 and obtain the triangle \mathfrak{T} in the Figure 117 below. The maps u_i ($i = 1, 2, 3, 4$) in Definition 11.9 induces a map

$$\hat{u} : \mathfrak{T} \rightarrow \prod_{i=1}^4 (-X_i \times X_i).$$

Its boundary condition is given by $\Delta_{X_1} \times \Delta_{X_2} \times \Delta_{X_3} \times \Delta_{X_4}$ for the (two) dotted edges and $\prod_{(ij)=(12),(13),(14),(23),(24),(34)} L_{ij}$ for the other edge.

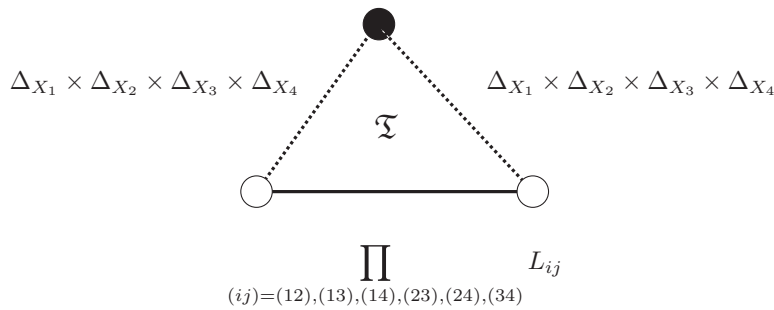

FIGURE 117. Regluing double pants

We thus obtain an identification of the moduli space $\overset{\circ}{\mathcal{M}}((\vec{a}_{ii'}; i, i'); (a_{ii''}; i, i', i''); E)$ of Definition 11.9 with the moduli space of pseudo-holomorphic triangles depicted in Figure 117. Therefore applying Proposition 3.29 to the moduli space of pseudo-holomorphic triangles depicted in Figure 117, we obtain an orientation of the moduli space $\overset{\circ}{\mathcal{M}}_{\text{DP}}((\vec{a}_{ii'}; i, i'); (a_{ii''}; i, i', i''); E)$. The compatibility at the boundary can be proved in the same way as Subsection 17.4. It implies Proposition 11.10 (3).

The proof of Proposition 11.16 (1) is the same as the proof of Proposition 9.2 (1) given in Subsection 17.4.

We consider marked points on the seam in Figure 116. Then the double pants transformation $\mathcal{D}\mathcal{P}\mathcal{T}^{E,\epsilon}$ in Definition 11.12 is defined by using appropriate A_∞ operation (which is defined from (117) with marked points added). The sign is defined by Koszul rule. So again taking into account (def.2), A_∞ formula implies Formula (11.24) *with Koszul sign*.

17.6. Orientation and sign for A_∞ -structure in the Morse-Bott case. The proof of A_∞ -formula *with sign* is written in detail in the case of a single embedded Lagrangian submanifold in [FOOO2, FOOO13, ST] etc. For an immersed Lagrangian submanifold which has transversal self-intersection, it is written in detail in [AJ]. The latter implies the A_∞ formula with sign in the case when we have finitely many immersed Lagrangian submanifolds which have transversal self-intersection and are mutually transversal. We can prove it in the case of immersed Lagrangian submanifold which has clean self-intersection (Morse-Bott type) in a similar way. Since it is not easy to find a reference which describes Morse-Bott case in detail, we below explain the way to obtain the orientation which gives A_∞ -formula with Koszul sign in such a case.

In this subsection we follow Akaho-Joyce's method in [AJ] and will explain how we modify it to generalize to the Morse-Bott case. In Appendix, written by Kaoru Ono, the way to generalize [FOOO13] to the Morse-Bott situation will be written.

We consider the moduli space $\mathcal{M}(L; \vec{a}; E)$ defined in (3.28). It comes with evaluation maps (3.30)

$$\text{ev} = (\text{ev}_0, \dots, \text{ev}_k) : \mathcal{M}(L; \vec{a}; E) \rightarrow L(\vec{a}). \quad (17.31)$$

Here $L(\vec{a}) = L(a_0) \times \dots \times L(a_k)$ is a direct products of connected components of $\tilde{L} \times_X \tilde{L}$. In [AJ] $\tilde{L} \times_X \tilde{L}$ minus diagonal components is written as R . (In their case R is a finite set. In our case it is a disjoint union of smooth compact manifolds.) In [AJ, page 425 (50)] Akaho and Joyce take a product of $\mathcal{M}(L; \vec{a}; E)$ with vector spaces associated to each point R to obtain $\widehat{\mathcal{M}}(L; \vec{a}; E)$. (They use the notation $\widetilde{\mathcal{M}}$. The author changes it to $\widehat{\mathcal{M}}$ since $\widetilde{\mathcal{M}}$ is used in Definition 3.19.)

Let $x \in L(a)$ which is not in a diagonal component. We consider operators

$$\begin{aligned} \bar{\partial}_{Z_-, \lambda_x} &: L_k^2(Z_-; T_x X; \lambda_a; \delta) \rightarrow L_{k-1}^2(Z_-; T_x X; \delta), \\ \bar{\partial}_{Z_+, \lambda_x} &: L_k^2(Z_+; T_x X; \lambda_a; \delta) \rightarrow L_{k-1}^2(Z_+; T_x X; \delta). \end{aligned} \quad (17.32)$$

as in (3.9). Here we fix a choice of λ_x . As is proved in [AJ, Proposition 5.15] the definition of orientation and sign which we describe below is independent of such a choice. To study orientation problem we can work locally on $L(\vec{a})$. So when x is in a (small) neighborhood of given x_0 we can and will take a choice of λ_x depending continuously on x . We can also perturb appropriately so that $\bar{\partial}_{Z_\pm, \lambda_x}$ are surjective. Then $\text{Ker} \bar{\partial}_{Z_-, \lambda_x}$ defines a vector bundle on $L(a)$. (More precisely on

a neighborhood of x_0 of $L(a)$.) We denote its total space by $\hat{L}(a)$. In case $L(a)$ is a diagonal component we define $\hat{L}(a) = L(a)$. We put $\hat{L}(\vec{a}) = \hat{L}(a_0) \times \cdots \times \hat{L}(a_k)$. Following [AJ, (59)] we put

$$\widehat{\mathcal{M}}(L; \vec{a}; E) := \mathcal{M}(L; \vec{a}; E) \times_{L(\vec{a})} \hat{L}(\vec{a}). \quad (17.33)$$

Note that the line bundle $\Theta_{a_i}^-$ appearing in Proposition 3.29 is the determinant line bundle of $\hat{L}(a_i) \rightarrow L(a_i)$. Therefore Proposition 3.29 implies that $\widehat{\mathcal{M}}(L; \vec{a}; E)$ has a canonical orientation.

For $i = 0$, the convention of $e\tilde{v}_0$ in [AJ, (62)] is slightly inconsistent with our convention of ev_0 at the point which we explain below. Let σ be the involution $\tilde{L} \times_X \tilde{L} \rightarrow \tilde{L} \times_X \tilde{L}$ defined by $\sigma(x, y) = (y, x)$. We denote by $L(\sigma(a))$ the component to which $L(a)$ is sent by σ . (If $L(a)$ is a diagonal component then $\sigma(a) = a$.) The 0-th evaluation map used by [AJ] is the composition $\sigma \circ ev_0$, where ev_0 is the evaluation map (17.31). From now on *in this subsection* we use [AJ]'s convention. Namely we change the definition of ev_0 to those by Akaho-Joyce.⁸³ This is only a matter of notation and there is no mathematical difference. Note that then $L(\vec{a}) = L(\sigma(a_0)) \times L(a_1) \times \cdots \times L(a_k)$ in this convention.

We next describe the evaluation map following [AJ, (61),(62)]. We first define $\tilde{L}(a)$ by modifying a bit [AJ]'s \tilde{R} . (We need slight modification since our $L(a)$ may not be discrete.) Let $x = (p, q) \in L(a)$. We take $\lambda_x \in \mathcal{P}_x^a$. (See Definition 3.7.) Then as we proved in (3.10) we have

$$T_x \tilde{L} \cong \text{Ker} \bar{\partial}_{Z_-, \lambda_x} \oplus \text{Ker} \bar{\partial}_{Z_+, \lambda_x} \oplus T_x L(a). \quad (17.34)$$

We take a vector bundle on $L(a)$ (more precisely on a neighborhood of x_0 in $L(a)$) whose fiber at x is $\text{Ker} \bar{\partial}_{Z_-, \lambda_x} \oplus \text{Ker} \bar{\partial}_{Z_+, \lambda_x}$ and define $\tilde{L}(a)$ to be the total space of this vector bundle. We remark that $L(a)$ may not be orientable. However since we assume L to be oriented $\tilde{L}(a)$ is oriented.

We put $\tilde{L}(\vec{a}) = \tilde{L}(\sigma(a_0)) \times \tilde{L}(a_1) \times \cdots \times \tilde{L}(a_k)$. For $\sigma(x) \in L(\sigma(a))$ we take $\lambda_{\sigma(x)}$ to be the opposite path to λ_x . Then we have canonical isomorphisms

$$\begin{aligned} \text{Ker} \bar{\partial}_{Z_-, \lambda_{\sigma(x)}} &\cong \text{Ker} \bar{\partial}_{Z_+, \lambda_x} \\ \text{Ker} \bar{\partial}_{Z_+, \lambda_{\sigma(x)}} &\cong \text{Ker} \bar{\partial}_{Z_-, \lambda_x}. \end{aligned} \quad (17.35)$$

In particular the involution $\sigma : L(a) \rightarrow L(\sigma(a))$ lifts to an involution $\sigma : \tilde{L}(a) \rightarrow \tilde{L}(\sigma(a))$.

We remark that (17.34) implies that

$$\dim \tilde{L}(a) = n \quad (17.36)$$

for any a . (Here $n = \dim L$.) (The right hand side is independent of a . This is an advantage to replace $L(a)$ by $\tilde{L}(a)$.)

Now we define

$$e\tilde{v} = (e\tilde{v}_0, \dots, e\tilde{v}_k) : \widehat{\mathcal{M}}(L; \vec{a}; E) \rightarrow \tilde{L}(\vec{a}) \quad (17.37)$$

in a similar way as [AJ, (61),(62)] as follows. We remark that an element of $\widehat{\mathcal{M}}(L; \vec{a}; E)$ is $(\mathfrak{r}; (\xi_i)_{i=0}^k)$ where $\xi_i \in \text{Ker} \bar{\partial}_{Z_-, \lambda_{ev_i(\mathfrak{r})}}$ for $i \neq 0$ and $\xi_0 \in \text{Ker} \bar{\partial}_{Z_-, \lambda_{\sigma(ev_0(\mathfrak{r}))}}$.

⁸³The map ev_0 used to define (17.33) is the one in (17.31). With this choice our $\widehat{\mathcal{M}}$ coincides with [AJ]'s $\widehat{\mathcal{M}}$.

We put

$$\begin{aligned} \tilde{e}v_i(\mathfrak{r}) &= (ev_i(\mathfrak{r}), \xi_i) \in \tilde{L}(a_i) & i \neq 0, \\ \tilde{e}v_i(\mathfrak{r}) &= (ev_0(\mathfrak{r}), \sigma(\xi_0)) \in \tilde{L}(\sigma(a_0)) & i = 0. \end{aligned} \quad (17.38)$$

We remark that

$$\sigma(\xi_0) \in \text{Ker} \bar{\partial}_{Z_+, \lambda_{ev_0(\mathfrak{r})}}.$$

We use this fact and Theorem 3.24 to prove the following:

Proposition 17.4. $\widehat{\mathcal{M}}(L; \vec{a}; E)$ has Kuranishi structure with corners whose normalized boundary is the disjoint union of the fiber products as follows

$$\begin{aligned} &\partial \widehat{\mathcal{M}}(L; \vec{a}; E) \\ &= \coprod_{\substack{b, i, j \\ E_1 + E_2 = E}} (-1)^* \widehat{\mathcal{M}}(L; \vec{a}(b, i, j, 2); E_2)_{\tilde{e}v_0} \times_{\tilde{e}v_{i+1}} \widehat{\mathcal{M}}(L; \vec{a}(b, i, j, 1); E_1). \end{aligned} \quad (17.39)$$

(17.39) is mostly the same as (3.50),⁸⁴ but we replace \mathcal{M} by $\widehat{\mathcal{M}}$ and ev by $\tilde{e}v$. We also remark that the order of first and second factors in the right hand side of (17.39) is the same as [AJ, (73)] but is opposite to [FOOO13, (20.11)]. (See [AJ, the last part of Subsection 4.2].) In this subsection we follow [AJ]. Note that in (17.39) $\tilde{e}v_{i+1}$ is used at the place where $\tilde{e}v_i$ is used in [AJ]. This is because of the convention used in $\vec{a}(b, i, j, 2)$ and $\vec{a}(b, i, j, 1)$ and is not related to the mathematical contents of the formula.

Now we state the compatibility of the orientations with the isomorphism (17.39), that is, the sign $*$ in (17.39). As we mentioned already Proposition 3.29 can be restated that $\widehat{\mathcal{M}}(L; \vec{a}; E)$ is oriented. Also in (17.39) we take the fiber product over $\tilde{L}(a)$, which is always n -dimensional and oriented.

Therefore the situation is the same as the case of A_∞ algebra associated to a single embedded Lagrangian submanifold. We require

$$* = n + (i + 1) + (i + 1)k_2. \quad (17.40)$$

This is the same as [AJ, (73)] except i is replaced by $i + 1$. (It is different from [FOOO13, (21.7)] by the above mentioned reason.)

The rest of the argument is mostly the same as [AJ]. Let $P_i = (P_i, f_i)$ be a chain in $L(a_i)$. More precisely it is a smooth singular chain with an orientation of $\Theta_{a_i, -} \otimes \text{Det} N_{P_i} L(a_i)$ given.⁸⁵ (Such a chain can be used to calculate the cohomology of $L(a_i)$ with $\Theta_{a_i, -}$ coefficient. Note that in case $\Theta_{a_i, -}$ is trivial, the chain is co-oriented and so is related to cohomology rather than homology. We remark that $L(a_i)$ may not be orientable. Even in such a case the set of singular chains with co-orientation is a model of its cohomology.) We put

$$\tilde{P}_i = P_i \times \text{Ker} \bar{\partial}_{Z_-, \lambda_{\sigma(x_0)}}. \quad (17.41)$$

Here we take $\lambda_{\sigma(x_0)}$ for $x_0 \in L(a_i)$ and assume the image of f_i is in a small neighborhood of x_0 . Compare [AJ, (68)]. Note that

$$\text{Ker} \bar{\partial}_{Z_-, \lambda_{\sigma(x_0)}} \cong \text{Ker} \bar{\partial}_{Z_+, \lambda_{x_0}}. \quad (17.42)$$

⁸⁴(3.50) is the case of Theorem 3.24 (3) when the graph Γ has one interior vertex.

⁸⁵Here we denote by $N_{P_i} L(a_i)$ the normal bundle. The determinant line bundle of the normal bundle is defined even in the case $f_i : P_i \rightarrow L(a_i)$ is not an immersion.

Then by the definition of $\Theta_{a_i, -}$ and (17.34) the chain \tilde{P}_i is oriented.⁸⁶ Using (17.42) we obtain $\tilde{f}_i : \tilde{P}_i \rightarrow \tilde{L}(a_i)$ in an obvious way.

Now we define

$$\widehat{\mathcal{M}}(L; \vec{a}; E; \vec{P}) := (-1)^* \widehat{\mathcal{M}}(L; \vec{a}; E) \times_{\tilde{L}(a_1) \times \dots \times \tilde{L}(a_k)} \tilde{P}_1 \times \dots \times \tilde{P}_k. \quad (17.43)$$

Here we use $\tilde{e}\tilde{v}_i$ and \tilde{f}_i to define the fiber product. The sign is

$$* = (n+1) \sum_{\ell=1}^k (k-\ell) \deg P_\ell. \quad (17.44)$$

Since \deg in [AJ] is the shifted degree \deg' in FOOO's notation (See [AJ, page 418].) (17.44) exactly coincides with the sign in [AJ, (79)]. (In (17.44) $\deg P_\ell$ is one in FOOO's convention.) Note that the degree of the chain in $L(a_i)$ as an element of $CF(L(a_{i-1}), L(a_i))$ is shifted from its codimension in $L(a_i)$ by the dimension of $\text{Ker} \partial_{Z-, \lambda_{x_0}}$. (It is the Morse index in the related context of Morse-Bott theory.) Therefore the degree of P_i as an element of $CF(L(a_{i-1}), L(a_i))$ is equal to the codimension of \tilde{P}_i in $\tilde{L}(a_i)$.

It is easy to see that $\widehat{\mathcal{M}}(L; \vec{a}; E; \vec{P})$ coincides with

$$\mathcal{M}(L; \vec{a}; E; \vec{P}) = \mathcal{M}(L; \vec{a}; E) \times_{L(a_1) \times \dots \times L(a_k)} P_1 \times \dots \times P_k \quad (17.45)$$

as spaces with Kuranishi structure (if we forget the orientation). The reason we rewrite (17.45) to (17.43) is then the correction term to orientation is easier to write down. The map $\tilde{e}\tilde{v}_0 : \widehat{\mathcal{M}}(L; \vec{a}; E) \rightarrow \tilde{L}(a_0)$ induces

$$\tilde{e}\tilde{v}_0 : \widehat{\mathcal{M}}(L; \vec{a}; E; \vec{P}) \rightarrow \tilde{L}(a_0).$$

If we triangulate the domain, it gives singular chains of $\tilde{L}(a_0)$. It is easy to see that those singular chains are related to the singular chains obtained from

$$\text{ev}_0 : \mathcal{M}(L; \vec{a}; E; \vec{P}) \rightarrow L(a_0)$$

by the formula (17.41).

Now the rest of the construction is entirely the same as [AJ, pages 434–444] and we obtain operations which satisfy A_∞ relations with Koszul sign, in the singular chain complex model. As is explained in [Fu8] (See the discussion around formula [Fu8, Pages 190–191].), the sign and orientation in the singular homology model induces one in the de Rham model.⁸⁷

In Appendix by Kaoru Ono, the direct discussion based on de Rham model is given.

18. CONCLUDING REMARKS

18.1. What we need to convert informal Definition 1.1/Informal summary 1.2 into formal ones. In this subsection we explain certain issues which will appear when one tries to give a rigorous versions of Definition 1.1 or Informal summary 1.2. We explain the following three points:

⁸⁶It might be more natural to say that it is co-oriented. However in our situation the ambient manifold $\tilde{L}(a_i)$ is oriented. So 'oriented' and 'co-oriented' are equivalent.

⁸⁷Since we converted the situation to the case when all the fiber products involved are taken over n dimensional oriented manifolds, we can also import the method of [FOOO13].

- (A) In Theorem 1.3 we take a finite set of Lagrangian submanifolds (not all the Lagrangian submanifolds) and the object set of the curved filtered A_∞ category is this finite set.
- (B) The geometric transformation of a Lagrangian submanifold L_1 by a Lagrangian correspondence L_{12} is defined under certain transversality assumptions. The composition of Lagrangian correspondences is defined under certain transversality assumptions.
- (C) The commutativity of several diagrams such as (1.1) or (1.10) is up to homotopy equivalence and is not strict.

We elaborate on those points below.

18.1.1. (A). In Theorem 1.3 we take a *finite* set of (immersed and spin) Lagrangian submanifolds \mathbb{L} of (X, ω) and an object of our filtered A_∞ category is a pair (L, b) of an element L of \mathbb{L} and its bounding cochain b . This category of course depends on the choice of \mathbb{L} and so is not canonically associated to (X, ω) . A natural way to make it more canonical is taking all the Lagrangian submanifolds. There is an issue for such a construction.

First we use a trick in Subsection 3.4 to reduce the construction of a filtered A_∞ category to one of a filtered A_∞ algebra, by taking disjoint union of all the elements of \mathbb{L} and regarding it as a single immersed Lagrangian submanifold. This trick does not work if \mathbb{L} has infinite order. However this point itself does not seem to be so serious since we used this trick mainly to shorten the paper.

The other and more essential issue is gapped-ness. Our construction in Section 3 is based on the induction on energy filtration. We took and fix a discrete submonoid $G = \{0 = E_0, E_1, \dots\}$ of $\mathbb{R}_{\geq 0}$ and construct an A_∞ category modulo T^{E_i} by an induction on i . The monoid G is generated by the set of symplectic areas of the all pseudo-holomorphic maps (polygons, strips and etc.) which appear during the construction. Such G is discrete by Gromov compactness when \mathbb{L} is finite. In the case \mathbb{L} is infinite we cannot take such a *discrete* submonoid G .

In a certain situation we can overcome this problem by using ‘homotopy inductive limit’ as follows. Suppose we have a countable set of spin immersed Lagrangian submanifolds \mathbb{L} of (X, ω) . We take finite subsets $\mathbb{L}^{(j)}$ of \mathbb{L} for each $j = 1, 2, 3, \dots$ such that $\mathbb{L}^{(j)} \subset \mathbb{L}^{(j+1)}$ and the union of all $\mathbb{L}^{(j)}$ is \mathbb{L} . For each j we can take a discrete submonoid G_j such that we can construct a G_j -gapped filtered A_∞ category $\mathfrak{F}\mathfrak{u}\mathfrak{k}\mathfrak{e}\mathfrak{r}\mathfrak{e}\mathfrak{t}((X, \omega), \mathbb{L}^{(j)})$ from the finite set $\mathbb{L}^{(j)}$. We may assume $G_j \subset G_{j+1}$. We next regard $\mathfrak{F}\mathfrak{u}\mathfrak{k}\mathfrak{e}\mathfrak{r}\mathfrak{e}\mathfrak{t}((X, \omega), \mathbb{L}^{(j)})$ as a G_{j+1} -gapped filtered A_∞ category. Then we can construct a G_{j+1} -gapped filtered A_∞ functor $\mathfrak{F}\mathfrak{u}\mathfrak{k}\mathfrak{e}\mathfrak{r}\mathfrak{e}\mathfrak{t}((X, \omega), \mathbb{L}^{(j)}) \rightarrow \mathfrak{F}\mathfrak{u}\mathfrak{k}\mathfrak{e}\mathfrak{r}\mathfrak{e}\mathfrak{t}((X, \omega), \mathbb{L}^{(j+1)})$ which is a homotopy equivalence to the image. In this way we can construct an inductive system of filtered A_∞ categories.

In the case when the completion (with respect to the Hofer-Chekanov distance [Che2]) of the set of Lagrangian submanifolds we study is separable, we can use the above sequence and construct the inductive limit

$$\varinjlim \mathfrak{F}\mathfrak{u}\mathfrak{k}\mathfrak{e}\mathfrak{r}\mathfrak{e}\mathfrak{t}((X, \omega), \mathbb{L}^{(j)}) = \mathfrak{F}\mathfrak{u}\mathfrak{k}\mathfrak{e}\mathfrak{r}\mathfrak{e}\mathfrak{t}((X, \omega), \mathbb{L}). \quad (18.1)$$

See [Fu13]. The author does not know how much the separability assumption is essential.

18.1.2. (B). Let $L_{12} \subset -X_1 \times X_2$ and $L_{23} \subset -X_2 \times X_3$ be immersed Lagrangian correspondences. If the fiber product $L_{12} \times_{X_2} L_{23}$ is transversal then it becomes

a Lagrangian correspondence $\subset -X_1 \times X_3$. If those Lagrangian correspondences are self-clean then assuming L_{12}, L_{23} are unobstructed, we proved that the composition of correspondence functors $\mathcal{W}_{(L_{12}, b_{12})}$ and $\mathcal{W}_{(L_{23}, b_{23})}$ are represented by an unobstructed Lagrangian correspondence (L_{13}, b_{13}) . (We need to restrict ourselves to a finite set of Lagrangian submanifolds because of point (A).)

However if the fiber product $L_{12} \times_{X_2} L_{23}$ is not transversal there is no good candidate of a Lagrangian correspondence representing the composition of correspondence functors.

A possible way to resolve this issue is using the result of [Fu13] as follows. We perturb L_{23} to L_{23}^ϵ by a small Hamiltonian isotopy. Then we obtain $L_{13}^\epsilon = L_{12} \times_{X_2} L_{23}^\epsilon$ which is an immersed Lagrangian correspondence. If b_{12} and b_{23} are bounding cochains of L_{12} and L_{23} respectively then we obtain a bounding cochain b_{13}^ϵ of L_{13}^ϵ . We can show that for $\epsilon_n \rightarrow 0$, the sequence $(L_{13}^{\epsilon_n}, b_{13}^{\epsilon_n})$ becomes a Cauchy sequence with respect to the Hofer distance as objects of $\mathfrak{Futst}(-X_1 \times X_3)$ (Definition 15.1).⁸⁸ Generalizing various constructions of this paper to the completion of filtered A_∞ category via Gromov-Hausdorff distance (which is introduced in [Fu13]), it seems likely that we can define the composed functor as the limit of $\mathcal{W}_{(L_{13}^{\epsilon_n}, b_{13}^{\epsilon_n})}$.

We remark that if we change the coefficient from Novikov ring Λ_0 to its field of fractions Λ , then the problem becomes easier to handle. In fact over Λ two objects (L_{23}, b_{23}) and $(L_{23}^\epsilon, b_{23}^\epsilon)$ are equivalent. So we do not need to take the limit as above. On the other hand, the Lagrangian Floer theory over Λ_0 is much richer and contains much more informations than the Lagrangian Floer theory over Λ .

18.1.3. (C). By inspecting the proofs of the commutativity of Diagrams (1.1) and (1.10) given in this paper, we find that they actually do not strictly commute but commute only up to homotopy equivalence. It seems likely that there is a certain pseudo-isotopy which interpolates two compositions appearing in the diagram. Those pseudo-isotopies are well-defined up to pseudo-isotopy of pseudo-isotopies. For the composition, we can also try to understand the ‘higher associativity’, as follows. In the case when we consider four unobstructed immersed Lagrangian correspondences $(L_{i(i+1)}, b_{i(i+1)})$, $i = 1, 2, 3, 4$ from X_i to X_{i+1} , the correspondence functors $\mathcal{W}_{(L_{12}, b_{12})}$, $\mathcal{W}_{(L_{23}, b_{23})}$, $\mathcal{W}_{(L_{34}, b_{34})}$, $\mathcal{W}_{(L_{45}, b_{45})}$ can be composed in various different orders. For example

$$\begin{aligned} & \mathcal{W}_{(L_{45}, b_{45})} \circ (\mathcal{W}_{(L_{34}, b_{34})} \circ (\mathcal{W}_{(L_{23}, b_{23})} \circ \mathcal{W}_{(L_{12}, b_{12})})), \\ & ((\mathcal{W}_{(L_{45}, b_{45})} \circ \mathcal{W}_{(L_{34}, b_{34})}) \circ \mathcal{W}_{(L_{23}, b_{23})}) \circ \mathcal{W}_{(L_{12}, b_{12})} \end{aligned}$$

and etc. There exist pseudo-isotopies between the compositions with different orders. Moreover, it seems likely that one can construct a pseudo-isotopies of pseudo-isotopies parametrized by the Stasheff 2-gon. It seems likely that one can continue and obtain a certain infinite category type construction, if the issues (A),(B) are resolved.

18.1.4. The above discussions sketch a possible way to proceed to overcome (A), (B), (C) and actually prove ‘Informal summary 1.2’. However the actual works needed to carry out those plans are extremely heavy and likely become extremely lengthy. So I think taking a break at the point where we proved the results in this paper before going further is a reasonable choice.

⁸⁸Moreover it is a Cauchy sequence with respect to the Hofer infinite distance, which is introduced in [Fu13].

18.2. Relations to the works by Bottman-Wehrheim. In this subsection, we mention relations of this paper with several papers by Bottman [Bo1, Bo2] and Bottman-Wehrheim [BW]. First we review briefly the method of a strip shrinking, introduced by Wehrheim-Woodward, in the simplest case. In Subsection 5.2, we consider a moduli space consisting of u_1, u_2 where $u_1 : [-1, 0] \times \mathbb{R} \rightarrow X_1$ and $u_2 : [0, 1] \rightarrow X_2$ are pseudo-holomorphic maps, which satisfy a certain matching (boundary) condition at $\{0\} \times \mathbb{R}$. One can generalize this moduli space so that u_1 is a map from $[-S, 0] \times \mathbb{R}$ for a certain $S > 0$. We denote by $\mathcal{M}_{\text{QT}}(L_1, L_{12}, L_2; S)$ the moduli space obtained in this way.⁸⁹ We can then proceed in the same way to obtain a tri-module, which we denote by:

$$\mathcal{CF}(\mathbb{L}_1, \mathbb{L}_{12}; \mathbb{L}_2; S). \quad (18.2)$$

We can use it instead of $\mathcal{CF}(\mathbb{L}_1, \mathbb{L}_{12}; \mathbb{L}_2)$ to obtain a filtered A_∞ functor,

$$\mathcal{W}_{L_{12}}^S : \mathfrak{Fukst}(X_1; \mathbb{L}_1) \rightarrow \mathfrak{Fukst}(X_2; \mathbb{L}_2)$$

in the same way as Sections 6, 7.

Wehrheim-Woodward-Ma'u-Bottman studied the limit when S goes to zero. It is believed that the limit $\lim_{S \rightarrow 0} \mathcal{M}_{\text{QT}}(L_1, L_{12}, L_2; S)$ becomes a moduli space $\mathcal{M}(L'_2, L_2)$ together with bubbles on the boundary $\{0\} \times \mathbb{R}$. Here $\mathcal{M}(L'_2, L_2)$ is a moduli space of pseudo-holomorphic maps $u : [0, 1] \rightarrow X_2$ such that $u(0, \tau) \in L'_2$ and $u(1, \tau) \in L_2$ and L'_2 is the geometric transformation $L_1 \times_{X_1} L_{12}$. See Figure 118.

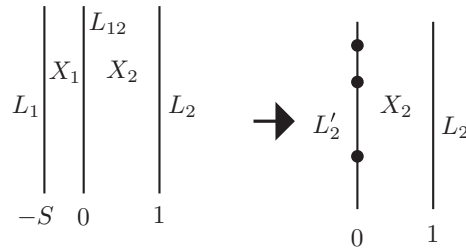

FIGURE 118. Strip shrinking 1.

The bubble on the line $\{0\} \times \mathbb{R}$ is called a Figure 8 bubble and in this case it is expected to be described by a moduli space of (u_1, u_2) which are pseudo-holomorphic maps

$$u_1 : [-1, 0] \times \mathbb{R} \rightarrow X_1, \quad u_2 : [0, \infty) \times \mathbb{R} \rightarrow X_2$$

with boundary conditions:

$$u_1(-1, \tau) \in L_1, \quad (u_1(0, \tau), u_2(0, \tau)) \in L_{12}, \quad \lim_{t \rightarrow \infty} u_2(t, \tau) = p,$$

where $p \in L'_2$ is independent of τ . See Figure 119.

The conjecture mentioned in Remark 1.6 claims that the virtual fundamental chain of the moduli space of Figure 8 bubbles becomes a bounding cochain b'_2 of L'_2 and the homology of the tri-module $\mathcal{CF}((L_1, b_1), (L_{12}, b_{12}); (L_2, b_2))$ becomes isomorphic to $HF((L'_2, b'_2), (L_2, b_2))$.

⁸⁹It is an analogue of the moduli space $\mathcal{M}_{\text{QT}}(\vec{a}_1, \vec{a}_{12}, \vec{a}_2; a_-, a_+; E)$ introduced in Subsection 5.2. Since the discussion here is heuristic I do not include the marked points or energy in the notation.

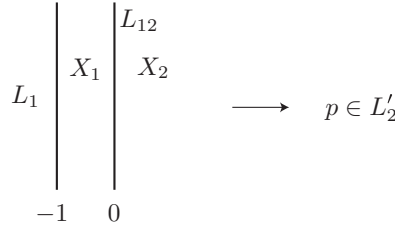

FIGURE 119. Figure 8 bubble 1

We conjecture also that b'_2 is gauge equivalent to the bounding cochain we obtained in Theorem 1.5 as follows.

We consider the bounding cochains $b'_2(S)$ such that $(L'_2, b'_2(S)) = \mathcal{W}_{L_{12}}^S(L_1, b_1)$. Using the fact that $\mathcal{CF}(\mathbb{L}_1, \mathbb{L}_{12}; \mathbb{L}_2; S)$ is pseudo-isotopic to $\mathcal{CF}(\mathbb{L}_1, \mathbb{L}_{12}; \mathbb{L}_2; S')$ for $S, S' > 0$, we can show that $b'_2(S)$ is independent of S up to gauge equivalence. Note that $b'_2(S)$ is characterized by the condition that

$$\mathbf{n}_S(e^{b_1}, e^{b_{12}}, \mathbf{1}; e^{b'_2(S)}) = 0, \tag{18.3}$$

where \mathbf{n}_S is the structure operation of the tri-module $\mathcal{CF}(L_1, L_{12}; L'_2; S)$ and $\mathbf{1}$ is the cyclic element, which is the 0-form 1 on the diagonal component of the fiber product $L_1 \times_{X_1} L_{12} \times_{X_2} L'_2 \cong L'_2 \times_{X_2} L'_2$.

The tri-module $\mathcal{CF}(L_1, L_{12}; L'_2; S)$ is expected to ‘converge’ to the Floer chain complex $CF(L'_2, L'_2)$ with the boundary operator corrected by b'_2 , which is

$$d(x) = \mathbf{m}(e^{b'_2}, x). \tag{18.4}$$

Here b'_2 is the conjectured bounding cochain obtained from Figure 8 bubbles.⁹⁰ It is easy to see that

$$\mathbf{m}(e^{b'_2}, \mathbf{1}, e^{b'_2}) = 0. \tag{18.5}$$

Here \mathbf{m} is the structure operation of the A_∞ algebra associated to L'_2 and $\mathbf{1}$ is the fundamental class, which is the 0 form 1 of L'_2 . Comparing (18.3) and (18.5) we expect

$$\lim_{S \rightarrow 0} b'_2(S) = b'_2.$$

Namely the bounding cochain obtained from the moduli space of Figure 8 bubbles is gauge equivalent to one in Theorem 1.5.

We mention a reason⁹¹ why the virtual fundamental chain of the moduli space of Figure 8 bubbles is not yet rigorously constructed. We draw Figure 119 on the 2 sphere as in Figure 120 below. Two lines (seams) $\{0\} \times \mathbb{R}$ and $\{1\} \times \mathbb{R}$ on which we require boundary conditions are tangent at the point ∞ (which is required to be sent to p). This is different from the situation of the Y-diagram, where 3 seams intersect *transversally* at the hole. The existence of tangency between seams is a new phenomenon and Fredholm theory for such boundary valued problem is not yet established. We like to mention Bottman [Bo1, Bo2] and Bottman-Wehrheim [BW] established compactness and removable singularity, which is a very important step

⁹⁰Note that $d \circ d = 0$ may not hold for the operator (18.4). We need to add bounding cochain of $CF(L'_2, L'_2)$ which acts from the *right* also to obtain d' such that $d' \circ d' = 0$.

⁹¹which was known to various researchers before the year 2010

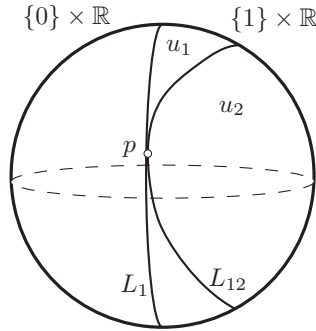

FIGURE 120. Figure 8 bubble 2

toward constructing the virtual fundamental chain of the moduli space of Figure 8 bubbles.

18.3. Relation to the works by Ma'u-Wehrheim-Woodward. As we mentioned in the introduction, Weinstein [Wei] proposed to regard a Lagrangian submanifold of the product $-X \times Y$ as a morphism $X \rightarrow Y$ between symplectic manifolds. Since Weinstein's proposal looks so natural, there had been attempts to associate a functor $\mathfrak{F}_\mathcal{L} : \mathfrak{Fukst}(X) \rightarrow \mathfrak{Fukst}(Y)$ to an unobstructed immersed Lagrangian correspondence $\mathcal{L} = (L, b)$. A possible naive idea to do so is the following. Let L_1 be a Lagrangian submanifold of X . Instead of associating an object of $\mathfrak{Fukst}(Y)$ to L_1 , we try to define a right $\mathfrak{Fukst}(Y)$ module $\mathfrak{F}_\mathcal{L}(L_1)$. In the cohomology level, $\mathfrak{F}_\mathcal{L}(L_1)$ can be defined by associating the Floer homology $HF(L; L_1 \times L_2)$ in the product $-X \times Y$ to a Lagrangian submanifold L_2 of Y . Actually we can construct an A_∞ functor:

$$\mathfrak{F}_\mathcal{L} : \mathfrak{Fukst}(X) \rightarrow \mathcal{R}MOD(\mathfrak{Fukst}(Y)) \quad (18.6)$$

in this way, as we did in Section 5. Here $\mathcal{R}MOD(\mathfrak{Fukst}(Y))$ is the DG-category of right $\mathfrak{Fukst}(Y)$ modules. Because of Yoneda's lemma, an object of $\mathcal{R}MOD(\mathfrak{Fukst}(Y))$ can be regarded as an 'extended object' of $\mathfrak{Fukst}(Y)$. Thus (18.6) could be regarded as a version of $\mathfrak{F}_\mathcal{L} : \mathfrak{Fukst}(X) \rightarrow \mathfrak{Fukst}(Y)$.

However the problem is in this formulation it is difficult to compose $\mathfrak{F}_{\mathcal{L}_{12}}$ and $\mathfrak{F}_{\mathcal{L}_{23}}$ where $\mathcal{L}_{i(i+1)} = (L_{i(i+1)}, b_{i(i+1)})$ is an unobstructed immersed Lagrangian submanifold of $-X_i \times X_{i+1}$, for $i = 1, 2$. This point is mentioned also in the first page of [MWW]. In the early 2000's the author tried to resolve this problem by a purely algebraic method of homological algebra of A_∞ categories, but he was not successful.⁹²

Remark 18.1. The above naive idea can be regarded as a 'finite dimensional analogue' of the proposal [Fu5] to construct Instanton Floer homology of 3-manifolds with boundary as an A_∞ module. In the moduli space introduced in [Fu6] during the attempt to realize the proposal, a line in the domain of \mathbb{C} where the equation changes from the ASD-equation (on a 4-manifold) to the pseudo-holomorphic curve equation, appears. This line plays the same role as seams play in the study of Lagrangian correspondences. The moduli space introduced by Lipyanskiy [Lip]

⁹²Theorem 1.5 resolves this problem by using more geometric input.

is more directly an infinite dimensional analogue of the moduli space of pseudo-holomorphic quilts.

As mentioned in Remark 1.6, Wehrheim-Woodward-Ma'u used the following idea to go around this problem. For a given symplectic manifold X , they consider a series of Lagrangian correspondences $L_i \subset -X_i \times X_{i+1}$ such that X_0 is a point and $X_n = X$. They regard such a system (L_0, \dots, L_n) as an object of expanded category $\mathfrak{Fut}^\#(X)$. Then, if $L'' \subset -X \times Y$ is a Lagrangian correspondence, one can define

$$(\mathcal{W}_{\mathcal{L}})_{ob} : \mathfrak{DB}(\mathfrak{Fut}^\#(X)) \rightarrow \mathfrak{DB}(\mathfrak{Fut}^\#(Y)),$$

by $(L_0, \dots, L_n) \mapsto (L_0, \dots, L_n, L'')$.

To define the A_∞ category $\mathfrak{Fut}^\#(X)$, one needs to define the Floer homology between extended objects $(L_0, \dots, L_n), (L'_0, \dots, L'_{n'})$, where $L_i \subset -X_i \times X_{i+1}$ and $L'_i \subset -X'_i \times X'_{i+1}$, X_0, X'_0 are points and $X_n = X'_{n'} = X$. They denote this Floer homology by $HF(L_0, \dots, L_n, L'_{n'}, \dots, L'_0)$. Wehrheim-Woodward-Ma'u used the notion of a pseudo-holomorphic quilt to define it. The pseudo-holomorphic quilt used to define $HF(L_0, \dots, L_n, L'_{n'}, \dots, L'_0)$ is as in Figure 121 below. Here u_i (resp.

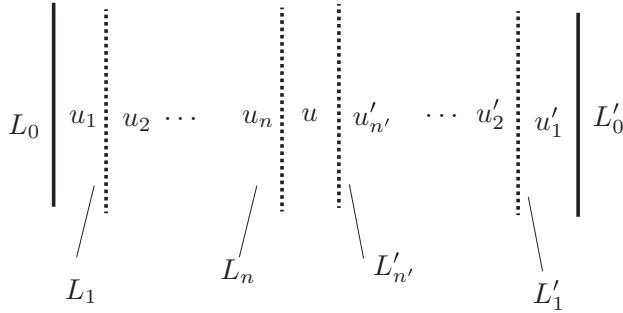

FIGURE 121. A pseudo-holomorphic quilt.

u'_i) is a pseudo-holomorphic map to X_i (resp. X'_i) and u is a pseudo-holomorphic map to X .

Wehrheim-Woodward-Ma'u went further to define a version of the correspondence bi-functor

$$\mathcal{MWW} : \mathfrak{Fut}^\#(-X \times Y) \times \mathfrak{Fut}^\#(X) \rightarrow \mathfrak{Fut}^\#(Y). \tag{18.7}$$

Their works are very important contributions to the study of Lagrangian correspondence and Lagrangian Floer homology.

We remark that in a way similar to Theorem 16.17 (and using reflexion principle in a similar way as we used in Section 17), we can show the next isomorphism.

$$HF(L_0, \dots, L_n, L'_{n'}, \dots, L'_0) \cong HF(L_0 \times \dots \times L_n \times L'_0 \times \dots \times L'_{n'}; \Delta). \tag{18.8}$$

Here

$$\Delta \subset \left(\prod_{i=1}^{n-1} (-X_i \times X_i) \right) \times \left(\prod_{i=1}^{n'-1} (-X'_{i'} \times X'_{i'}) \right) \times (-X \times X) \tag{18.9}$$

is the product of diagonals. The right hand side of (18.8) is the Floer homology of two Lagrangian submanifolds in the symplectic manifold given in (18.9).

The advantage to use a pseudo-holomorphic quilt rather than Floer homology in the direct product (as in (18.8)) lies in the fact that, then, one can use a strip shrinking to prove the next important isomorphism

$$\begin{aligned} HF(L_0, \dots, L_n, L'_{n'}, \dots, L'_0) \\ \cong HF(L_0, \dots, L_{n-1}, L_n \times_X L'_{n'}, L'_{n'-1}, \dots, L'_0). \end{aligned} \quad (18.10)$$

As mentioned in the last subsection, a strip shrinking is a process to change the width between two seams until it becomes 0. (See Figure 122.) Note that the method of using reflexion principle to replace Wehrheim-Woodward's definition by (18.8) works only in the case when all the strips have the same width. Therefore it is not consistent with strip shrinking.

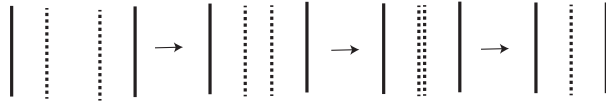

FIGURE 122. Strip shrinking 2.

Wehrheim-Woodward proved the isomorphism (18.10) under the assumption that all the Lagrangian submanifolds involved (including the fiber product $L_n \times_X L'_{n'}$) are embedded and monotone. The isomorphism (18.10) is a version of composability of filtered A_∞ functors associated to the composition of Lagrangian correspondences.

The reason why one does not need to study Figure 8 bubbles in the case when all the Lagrangian submanifolds involved are embedded and monotone is as follows. One can show that if the Figure 8 bubble occurs then it carries a strictly positive energy and so the virtual dimension of the moduli space of the configuration drops at least 2 in the monotone case. By this dimension counting argument one can avoid Figure 8 bubbles in the monotone situation. Later Lekili and Lipyanskiy [LL] gave an alternative proof of (18.10) using Y-diagram. (They assume embedded-ness and monotonicity.)

This is somewhat similar to the usual Floer theory or Gromov-Witten theory. In the semi-positive case, one can avoid sphere bubbles by the dimension counting argument. Therefore one does not need to find a Kuranishi chart at such 'infinity'. When we study a symplectic manifold which is not semi-positive then we need an abstract perturbation and so we need a chart centered at a point of infinity, which corresponds to a stable map with sphere bubbles.

INDEX

- \mathcal{A}_L , 25
- $\widehat{\otimes}$, 11
- 0-th vertex, 36
- A_∞ Yoneda functor, 24
- A_∞ formula, 12
- $B_k \mathcal{C}[1](a, b)$, 12
- $CF(L; \Lambda_0^R)$, 32
- $CF(L_1, L_{12}, L_2; \Lambda_0)$, 86
- $C_0^{\text{ext}}(\Gamma)$, 36
- $C_0^{\text{int}}(\Gamma)$, 36
- $C_1^{\text{ext}}(\Gamma)$, 37
- $C_1^{\text{int}}(\Gamma)$, 37
- $D_{\geq 0}^2$, 189
- G -gapped, 11, 13, 16, 64, 90
- $G(L)$, 35
- $G(L_1, L_{12}, L_2)$, 85
- $L(+)$, 25
- $L_{c, c'}(a)$, 54
- O_p , 43
- $O_{(X, \widehat{U})}$, 43
- P -parametrized family of G -gapped filtered A_∞ algebra, 230
- P -parametrized family of tri-module structures, 240
- $PSO L$, 27
- R linear, 24
- R -reduction, 11, 13
- T -adic metric, 10
- $Z(R)$, 30
- Z_- , 28
- Δ , 12
- Λ_0 linear, 247
- Λ , 10
- Λ linear, 24
- Λ_+ , 10
- Λ_0 , 10
- Λ_0 linear, 24
- Θ_a^+ , 29
- Θ_a^- , 29
- $\Theta_{c, c'; a}^-$, 54
- deg' , 13
- ϵ close, 198
- ϵ -close, 244
- $\epsilon(\mathbf{x})$, 22
- $\mathfrak{m}_k(\mathcal{T}^{(1)}, \dots, \mathcal{T}^{(k)})$, 18
- \mathfrak{t}^\flat , 67
- $\mathfrak{B}\mathfrak{J}\mathfrak{U}\mathfrak{S}\mathfrak{T}$, 273
- $\mathfrak{J}\mathfrak{u}\mathfrak{t}\mathfrak{s}\mathfrak{t}$, 97
- $\mathfrak{J}\mathfrak{u}\mathfrak{t}((X, \omega); V; \mathbb{L})$, 54
- $\mathfrak{h}\mathfrak{o}\mathfrak{m}$, 141
- $\mathfrak{h}\mathfrak{o}\mathfrak{m}_{\mathcal{C}_1}(\mathfrak{D}_1, \mathfrak{D}_2)(c_1, c_3)$, 139
- $\mathfrak{R}\mathfrak{J}\mathfrak{O}\mathfrak{N}$, 130
- $\mathfrak{R}\mathfrak{e}\mathfrak{p}(\mathcal{C}^{\text{op}}, \mathcal{C}\mathcal{H})$, 23
- $\mathfrak{Y}\mathfrak{O}\mathfrak{N}$, 24
- deg , 18
- ten , 131
- \widehat{d} , 13
- $\lim_{z \uparrow z_i}$, 34
- \mathcal{P}_x^a , 26
- \mathcal{S} , 63
- $\mathcal{C}\mathcal{H}$, 22
- $\text{FUN}\mathcal{C}(\mathcal{C}_1, \mathcal{C}_2)$, 19
- $\text{FUN}\mathcal{C}(\mathcal{F}, \mathcal{G})$, 18
- $\text{FUN}\mathcal{C}^G(\mathcal{C}_1, \mathcal{C}_2)$, 20
- $\mathcal{L}\mathcal{G}\mathcal{R}$, 26
- $\mathcal{L}\mathcal{G}\mathcal{R}_x$, 26
- \mathcal{C}^s , 14
- \mathcal{C}^Λ , 247
- \mathcal{C}^{op} , 21
- \mathcal{F}_{k_1, k_2} , 63
- $\mathcal{F}_{k_1, k_{12}, k_2}^{< E_0, \epsilon}$, 86
- \mathcal{F}_{ob} , 63
- $\mathcal{I}\mathcal{R}_{E, \bar{a}}$, 38
- $\mathcal{I}\mathcal{R}_{k+1, E}$, 36
- $\text{Id}_{\mathcal{F}}$, 20
- $\bar{\partial}_{Z(R), \lambda_x^2}$, 30
- $\bar{\partial}_{Z_-, \lambda_x}$, 29
- $\overset{\circ}{\mathcal{M}}((\bar{a}_{ii'})_{ii'}; (a_{ii'ii''})_{ii'ii''}; E)$, 160
- $\overset{\circ}{\mathcal{M}}(\bar{a}_{12}, \bar{a}_{23}, \bar{a}_{31}; \bar{a}_1, \bar{a}_2, \bar{a}_3; a_{\infty, -}, \bar{a}_{\infty, +}; E)$, 117
- $\overset{\circ}{\mathcal{M}}_{\text{DR}}(\bar{a}_{12}, \bar{a}_{23}, \bar{a}_{13}; a_-, a_+; E)$, 108
- $\overset{\circ}{\mathcal{M}}_{\text{QT}}(\bar{a}_1, \bar{a}_{12}, \bar{a}_2; a_-, a_+; E)$, 76
- $\overset{\circ}{\mathcal{M}}(L; \hat{\Gamma})$, 38
- $\overset{\circ}{\mathcal{M}}(L; \bar{a}; E)$, 35
- $\overset{\circ}{\mathcal{M}}_{\text{QT}}(\bar{a}_1, \bar{a}_{12}, \bar{a}_2; a_-, a_+; E)$, 81
- $\overset{\circ}{\mathcal{M}}(L; \bar{a}; E)$, 33
- ρ_0 , 256
- \sim_Λ , 247
- $\widehat{\oplus}$, 12
- $\widetilde{\mathcal{W}}_{\mathcal{L}12}$, 97
- $\widetilde{\mathbf{I}}_{\lambda_x}$, 27
- $\widetilde{\mathfrak{M}}(C; \Lambda_+)$, 14
- i -th exterior vertex, 36
- $i_{a, l}$, 26
- $i_{a, r}$, 26
- \mathbf{I}_{λ_x} , 27
- $\mathcal{M}'(L_{12}; \bar{a}^{12, (j)}; E_{12, j})$, 82
- $\mathcal{M}(L; \hat{\Gamma})$, 39
- $\mathcal{M}(L; \bar{a}; E)$, 38
- $\mathcal{M}(\bar{a}_1, \bar{a}_{12}, \bar{a}_2; a_-, a_+; E)$, 82
- $\mathcal{M}_{k+1}(L; E)$, 38
- OP, 64
- ev_j^1 , 79
- ev_j^{12} , 79
- $\text{ev}_{\infty, +}$, 79
- $\text{ev}_i^{\text{deti}}$, 265

- lims, 176
- $\widehat{\mathfrak{S}}$, 45, 85
- added marked point, 176
- associated strict category, 15
- associated strict functor, 17
- background data, 26
- bi-Yoneda functor, 273
- bounding cochain, 14
- candidate of an element of an extended moduli space $\mathcal{M}(L_{12}; \vec{a}; E)$, 244
- candidate of an element of extended moduli space, 197
- canonical holomorphic embedding, 192
- CF-perturbations, 45
- clean collection of V -relatively spin immersed Lagrangian submanifolds, 54
- clean self-intersection, 25
- clean transformation, 61
- completed free Λ_0 module, 11
- composition, 17
- core, 191
- corner compatibility condition, 42
- corner structure stratification, 45
- correspondence bi-functor, 98
- correspondence functor, 97, 98
- correspondence tri-module, 74
- curved, 12
- cyclic element, 90
- degree shift, 11
- derived hom-functor, 141
- derived tensor product, 131
- DG category, 15
- diagonal component, 25
- differential graded category, 15
- discrete monoid, 11
- double pants transformation, 163
- double pants transformation, 164
- energy cut level, 230
- energy filtration, 10
- equivalent, 118, 175
- evaluation map, 35, 39, 78, 83
- evaluation map at infinity, 79
- evaluation transversality condition, 197
- extendable, 192
- exterior edge, 37
- exterior vertex, 36
- filtered A_∞ algebra, 14
- filtered A_∞ algebra homomorphism, 16
- filtered A_∞ bi-functor, 63
- filtered A_∞ bi-module, 56, 64
- filtered A_∞ category, 12
- filtered A_∞ functor, 15
- filtered A_∞ structure modulo T^{E_0} , 48
- filtered right A_∞ module, 90
- formal coalgebra, 12
- functor category, 19
- geometric composition, 62
- geometric transformation, 93, 95
- gluing parameter, 189
- ground ring, 10
- Hofer distance, 247
- hom-module, 139
- homotopic, 224
- homotopy equivalence, 20, 21
- homotopy equivalent, 20, 21
- homotopy equivalent over Λ , 247
- homotopy functor, 224
- homotopy inverse, 21
- identity natural transformation, 20
- immersed Lagrangian submanifold, 25
- integration along the fiber, 47
- interior edge, 37
- interior marked points of first kind, 174
- interior marked points of second kind, 174
- interior vertex, 36
- isomorphism, 175
- linear, 222
- mapping transversality condition, 196
- Maurer-Cartan solution space, 14
- minimal energy, 230
- model of $\mathcal{C} \times [0, 1]$, 223
- module of morphisms, 12
- natural transformation, 18
- non-unital, 12
- normalized boundary, 40
- normalized corner, 40
- obstruction bundle data, 195
- obstruction spaces, 195
- opposite A_∞ category, 21
- opposite A_∞ functor, 22
- orientation local system, 43
- outer collaring, 45
- partial P -parametrized family of G -gapped filtered A_∞ algebras, 230
- pointwise in P direction, 229
- pre-natural transformation, 17
- pseudo-isotopy modulo T^E , 50
- quilted drum, 106
- relative spin structure, 25
- relative Yoneda functor, 130
- representable, 23
- root, 76
- seam, 76, 106
- source deformation parameter, 189

- source gluing data, 187
- source gluing map, 190
- source stabilization, 176
- source stable, 175
- stable, 109, 118, 175
- stable decorated ribbon tree, 36
- stable map topology, 176, 233
- strict, 13, 16, 63
- strong homotopy inverse, 224
- strongly homotopy equivalent, 224
- strongly smooth, 254
- strongly submersive, 45
- structure operations, 12
- switching components, 25
- switching condition, 76

- tensor product of filtered A_∞ category, 275
- thickening, 45
- time ordered product, 253
- transversal self-intersection, 25
- tree of sphere components, 76

- unital, 14, 16, 64
- universal Novikov field, 10
- universal Novikov ring, 10
- Unobstructed Weinstein category, 4

- weak isomorphism, 174
- weakly submersive, 254

- Y diagram transformation, 124, 127

REFERENCES

- [AFOOO] M. Abouzaid, K. Fukaya, Y.-G. Oh, H. Ohta and K. Ono, *Quantum cohomology and split generation in Lagrangian Floer theory*, in preparation.
- [Ak] M. Akaho, *Intersection theory for Lagrangian immersions*, Math. Res. Lett. **12** (2005), 543–550.
- [AJ] M. Akaho and D. Joyce, *Immersed Lagrangian Floer theory*, J. Differential Geometry **86** (2010) 381–500.
- [AKSZ] M. Alexandrov, A. Schwarz, M. Kontsevich and O. Zaboronsky, *The geometry of the master equation and topological quantum field theory*, Intern. J. Modern Phys. A **12** (1997) 1405–1429.
- [Am1] L. Amorim, *Tensor product of filtered A_∞ -algebras*, arXiv:1404.7184, Journal of Pure and Applied Algebra **220-12** (2016) 3984–4016.
- [Am2] L. Amorim, *The Künneth theorem for the Fukaya algebra of a product of Lagrangians*, Internat. J. Math. **28** (2017), no. 4, 1750026, 38 pp, arXiv:1407.8436.
- [BLM] Yu. Bernalov, V. Lyubashenko and O. Manzyuk, *Pretriangulated A_∞ -categories*, Proceedings of the Institute of Mathematics of NAS of Ukraine, vol. **76**, Institute of Mathematics of NAS of Ukraine, Kyiv, 2008
- [BC] P. Biran and O. Cornea, *Lagrangian Cobordism I*, J. Amer. Math. Soc. **26** (2013), 295–340.
- [BK] A. Bondal and M. Kapranov, *Framed triangulated categories*, Math. USSR. Sbornik **1** (1991 (1990 in Russian)), 93 - 107.
- [Bo1] N. Bottman, *Pseudoholomorphic quilts with figure eight singularity*, Journal of Symplectic Geometry **18** (2020), no. 1; 1–55, arXiv:1410.3834.
- [Bo2] N. Bottman, *Geometric composition and strip-shrinking*, Talk at Simons Center for Geometry and Physics, 2014 June 5th, <http://scgp.stonybrook.edu/archives/7151>.
- [BW] N. Bottman and K. Wehrheim, *Gromov compactness for squiggly strip shrinking in pseudo-holomorphic quilts*, Selecta Math. (N.S.) **24** (2018), no. 4, 3381–3443. arXiv:1410.3834.
- [Che1] Y.V. Chekanov, *Lagrangian intersections, symplectic energy, and areas of holomorphic curves*, Duke Math. J. **95** (1998), no. 1, 213–226.
- [Che2] Y. Chekanov, *Invariant Finsler metrics on the space of Lagrangian embeddings*, Math. Z., **234** (2000) 605–619.
- [CS] O. Cornea and E. Shelukhin *Lagrangian cobordism and metric invariants* J. Differential Geom. **112**(1): 1–45.
- [DF] A. Daemi and K. Fukaya, *Atiyah-Floer Conjecture: a Formulation, a Strategy to Prove and Generalizations*, in “Modern geometry: a celebration of the work of Simon Donaldson”, 23–57, Proc. Sympos. Pure Math., **99**, Amer. Math. Soc., Providence, RI, 2018.
- [DFL] A. Daemi, K. Fukaya and M. Lipynskiy, *Lagrangians, $SO(3)$ -instantons and the Atiyah-Floer Conjecture*, arXiv:2109.07032.
- [DL] O.D. Deken and W. Lowen, *Filtered cA_∞ -Categories and Functor Categories*, Appl. Categor. Struct. (2018) **26**, pp 943–996.
- [EL] J. Evans and Y. Lekili, *Generating the Fukaya categories of Hamiltonian G -manifolds*, J. Amer. Math. Soc. **32** (2019), no. 1, 119–162, arXiv:1507.05842
- [Fu1] K. Fukaya, *Floer homology for oriented 3-manifolds*, Aspects of low-dimensional manifolds, 1–92, Adv. Stud. Pure Math., **20**, Kinokuniya, Tokyo, 1992.
- [Fu2] K. Fukaya, *Morse homotopy, A^∞ -Category, and Floer homologies*, in “Proceedings of Garc Workshop on Geometry and Topology” ed. by H.J. Kim, Seoul National University (1994), 1-102.
- [Fu3] K. Fukaya, *Floer homology for 3-manifolds with boundary -abstract -*, in ‘Topology Geometry and Field theory’ ed by Fukaya, Furuta, Khono, Kotchick, World Scientific, Singapore (1994), 1-22.
- [Fu4] K. Fukaya, *Floer homology of connected sum of homology 3-spheres*, Topology **35** (1996) 88–136.
- [Fu5] K. Fukaya, *Floer homology for 3-manifolds with boundary I* (1997), **never** to be published but is available at <http://www.math.kyoto-u.ac.jp/%7Efukaya/fukaya.html>.

- [Fu6] K. Fukaya, *Anti-self-dual equation on 4-manifolds with degenerate metric*, Geom. Funct. Anal. **8** (1998) 466–528.
- [Fu7] K. Fukaya, *Floer homology and mirror symmetry II*, Minimal Surfaces, Geometric Analysis and Symplectic Geometry (Baltimore, MD, 1999), Adv. Stud. Pure Math. **34** (2002), 31–127.
- [Fu8] K. Fukaya, *Differentiable operad, Kuranishi correspondence, and Foundation of topological field theories based on pseudo holomorphic curves*, in ‘Arithmetic and geometry around quantization’, 123–200, Progr. Math., **279**, Birkhäuser Boston, Inc., Boston, MA, (2010).
- [Fu9] K. Fukaya, *Cyclic symmetry and adic convergence in Lagrangian Floer theory*, Kyoto J. Math. **50** (2010), no. 3, 521–590.
- [Fu10] K. Fukaya, *SO(3)-Floer homology of 3-manifold with boundary: 1*, arXiv:1506.01435.
- [Fu11] K. Fukaya, *Categorification of invariants in gauge theory and symplectic geometry*, Japanese Journal of Mathematics (2018) **13**-1, pp 1–65, arXiv:1703.00603.
- [Fu12] K. Fukaya *Lie groupoid, deformation of unstable curve, and construction of equivariant Kuranishi charts*, Publ. Res. Inst. Math. Sci. **57**, no 3 (2010) 1109–1225, arXiv:1701.02840.
- [Fu13] K. Fukaya, *Gromov-Hausdorff distance between filtered A_∞ categories*, arXiv:2106.06378.
- [FOOO1] K. Fukaya, Y.-G. Oh, H. Ohta and K. Ono, *Lagrangian intersection Floer theory-anomaly and obstruction, Part I*, AMS/IP Studies in Advanced Math. vol. 46.1, International Press/ Amer. Math. Soc. (2009). MR2553465.
- [FOOO2] K. Fukaya, Y.-G. Oh, H. Ohta and K. Ono, *Lagrangian intersection Floer theory-anomaly and obstruction, Part II*, AMS/IP Studies in Advanced Math. vol. 46.2, International Press/ Amer. Math. Soc. (2009). MR2548482.
- [FOOO3] K. Fukaya, Y.-G. Oh, H. Ohta and K. Ono, *Anchored Lagrangian submanifolds and their Floer theory*. in ‘Mirror symmetry and tropical geometry’, 15–54, Contemp. Math., **527**, Amer. Math. Soc., Providence, RI, (2010).
- [FOOO4] K. Fukaya, Y.-G. Oh, H. Ohta and K. Ono, *Lagrangian Floer theory on compact toric manifolds I*, Duke Math. J. **151** (2010), 23–174.
- [FOOO5] K. Fukaya, Y.-G. Oh, H. Ohta and K. Ono, *Displacement of polydisks and Lagrangian Floer theory*, J. Symplectic Geom. **11** (2013), no. 2, 231–268.
- [FOOO6] K. Fukaya, Y.-G. Oh, H. Ohta and K. Ono, *Floer theory and mirror symmetry on compact toric manifolds*, Astérisque **376** (2016) 1–340, arXiv:1009.1648v3.
- [FOOO7] K. Fukaya, Y.-G. Oh, H. Ohta and K. Ono, *Anti-symplectic involution and Floer cohomology*, Geometry and Topology **21** (2017) 1–106, arXiv:0912.2646.
- [FOOO8] K. Fukaya, Y.-G. Oh, H. Ohta and K. Ono, *Spectral invariants with bulk, quasimorphisms and Lagrangian Floer theory*, Mem. Amer. Math. Soc. **260** (2019), no. 1254, x+266 pp, arXiv:1105.5123.
- [FOOO9] K. Fukaya, Y.-G. Oh, H. Ohta and K. Ono, *Technical details on Kuranishi structure and virtual fundamental chain*, arXiv:1209.4410.
- [FOOO10] K. Fukaya, Y.-G. Oh, H. Ohta and K. Ono, *Kuranishi structure, Pseudo-holomorphic curve, and Virtual fundamental chain: Part 1*, arXiv:1503.07631.
- [FOOO11] K. Fukaya, Y.-G. Oh, H. Ohta and K. Ono, *Kuranishi structure, Pseudo-holomorphic curve, and Virtual fundamental chain: Part 2*, arXiv:1704.01848.
- [FOOO12] K. Fukaya, Y.-G. Oh, H. Ohta and K. Ono, *Exponential decay estimate and smoothness of the moduli space of pseudo-holomorphic curves*, to appear in Memoir of Amer. Math., arXiv:1603.07026.
- [FOOO13] K. Fukaya, Y.-G. Oh, H. Ohta and K. Ono, *Kuranishi structures, and Virtual fundamental chains*, Springer Monograph in Math. 2020 Springer Singapore, (This is an improved version of the union of [FOOO10] and [FOOO11].)
- [FOOO14] K. Fukaya, Y.-G. Oh, H. Ohta and K. Ono, *Construction of Kuranishi structures on the moduli spaces of pseudo-holomorphic disks: I*, Surveys in Differential Geometry **22** (2018) 133–190, arXiv:1710.01459.
- [FOOO15] K. Fukaya, Y.-G. Oh, H. Ohta and K. Ono, *Construction of Kuranishi structures on the moduli spaces of pseudo-holomorphic disks: II*, arXiv:1808.06106.
- [FOn] K. Fukaya and K. Ono, *Arnold conjecture and Gromov-Witten invariant*, Topology **38** (1999), no. 5, 933–1048.

- [Ga] Y. Gao, *Wrapped Floer cohomology and Lagrangian correspondences*, arXiv:1703.04032.
- [Gr] M. Gromov, *Pseudoholomorphic curves in symplectic manifolds*, Invent. Math. **82** (1985), no. 2, 307–347.
- [Ho] H. Hofer, *On the topological properties of symplectic maps*, Proceedings of the Royal Society of Edinburgh **115** A (1990), 25–38.
- [Jo] D. Joyce, *On manifolds with corners*, arXiv:0910.3518, in S. Janeczko, J. Li, D.H. Phong eds, *Advances in Geometric Analysis*, Advanced Lectures in Math. 21, International Press, (2012) 225–258.
- [Ke1] B. Keller, *Introduction to A-infinity algebra and modules*, Homology Homotopy Appl. **3** (2001) no 1-35 (electronic). 340.
- [Ke2] B. Keller, *A_∞ algebras, modules and functor categories*, in “Trends in Representation Theory of Algebras and Related Topics”, Contemporary Mathematics, **406** (2006) 67–93, math/0510508.
- [Kel] J. Kelly, *General topology*, Springer, Graduate text in Mathematics **27**, ISSN: 0072-5285.
- [KS] M. Kontsevich and Y. Soibelman, *Notes on A_∞ -Algebras, A_∞ -Categories and Non-Commutative Geometry*, Lect. Notes Phys. **757**, 153–219 (2009).
- [LL] Y. Lekili and M. Lipyanskiy, *Geometric composition in quilted Floer theory*, Adv. Math. **236** (2013), 1–23.
- [Lip] M. Lipyanskiy, *Gromov-Uhlenbeck Compactness*, arXiv:1409.1129.
- [Le] K. Lefèvre-Hasegawa, *Sur les A_∞ catégories*, Thèse Doctorat Université Paris **7** (2003).
- [Ly] V. Lyubashenko, *Category of A_∞ -categories*, Homology, Homotopy and Applications **5** (2003), 1–48.
- [MS] M. Markl and S. Shnider, *Associahedra, cellular W -construction and products of A^∞ -algebras*, Trans. Amer. Math. Soc., **358**(6):2353–2372 (electronic), 2006.
- [MWW] S. Ma'u, K. Wehrheim and C. Woodward, *A_∞ -functor for Lagrangian correspondences*, Selecta Math. (N.S.) **24** (2018), no. 3, 1913–2002.
- [Oh] Y.-G. Oh, *Floer cohomology of Lagrangian intersections and pseudo-holomorphic disks I, II*, Comm. Pure and Appl. Math. **46** (1993), 949–994, 995–1012; Addenda, *ibid*, 48 (1995), 1299–1302.
- [Ono] K. Ono, *Lagrangian intersection under Legendrian deformations*, Duke Math. J. Volume **85**, Number 1 (1996), 209–225.
- [SU] S. Sanedidze and R. Umble, *A Diagonal on the Associahedra*, arXiv:0011065.
- [Se1] P. Seidel, *Graded Lagrangian submanifolds*, Bull. Soc. Math. France **128** (2000), 103–149.
- [Se2] P. Seidel, *Fukaya categories and Picard-Lefschetz theory*, ETH Lecture Notes series of the European Math. Soc., 2008.
- [ST] J.P. Solomon and S. B. Tukachinsky *Differential forms, Fukaya A^∞ algebras, and Gromov-Witten axioms*, arXiv:1608.01304.
- [St] J. Stasheff, *Homotopy associativity of H -spaces I, II*, Trans. Amer. Math. Soc. **108** (1963) 275–312.
- [To] B. Töen *The homotopy theory of dg-categories and derived Morita theory*, Invent. Math. **167** (2007), no. 3, 615–667.
- [Weh] K. Wehrheim, *Figure eight bubbles in pseudo-holomorphic quilts*, talk at SCGP, can be seen at SCGP’s web page, 2012-11-12.
- [WW1] K. Wehrheim and C. Woodward, *Quilted Floer cohomology*, Geometry & Topology, **14**:833–902, 2010.
- [WW2] K. Wehrheim and C. Woodward, *Functoriality for Lagrangian correspondences in Floer theory*, Quantum Topology **1** (2010), 129–170.
- [WW3] K. Wehrheim and C. Woodward, *Pseudoholomorphic quilts*, Journal of Symplectic Geometry **13** (2015) 849–904.
- [WW4] K. Wehrheim and C. Woodward, *Floer cohomology and geometric composition of Lagrangian correspondences*, Advances in Mathematics **230** (2012), 177–228.
- [WW5] K. Wehrheim and C. Woodward, *Orientation for pseudo-holomorphic quilt*, arXiv:1503.07803.

- [Wei] A. Weinstein, *The symplectic “category”*, in Differential Geometric methods in mathematical Physics (Clausthal, 1980) Lecture notes in Math., 905 pages 45–51, Springer, Berlin

SIMONS CENTER FOR GEOMETRY AND PHYSICS, STATE UNIVERSITY OF NEW YORK, STONY BROOK, NY 11794-3636 U.S.A. & CENTER FOR GEOMETRY AND PHYSICS, INSTITUTE FOR BASIC SCIENCES (IBS), POHANG, KOREA

Email address: kfukaya@scgp.stonybrook.edu