

UNIONS OF 3-PUNCTURED SPHERES IN HYPERBOLIC 3-MANIFOLDS

KEN'ICHI YOSHIDA

Abstract

We classify the topological types for the unions of the totally geodesic 3-punctured spheres in orientable hyperbolic 3-manifolds. General types of the unions appear in various hyperbolic 3-manifolds. Each of the special types of the unions appears only in a single hyperbolic 3-manifold or Dehn fillings of a single hyperbolic 3-manifold. Furthermore, we investigate bounds of the moduli of adjacent cusps for the union of linearly placed 3-punctured spheres.

1 Introduction

In this paper, we consider totally geodesic 3-punctured spheres in orientable hyperbolic 3-manifolds. The ϵ -thick part of an orientable hyperbolic 3-manifold M is its submanifold $M_{[\epsilon, \infty)}$ such that the open ball of radius ϵ centered at any $x \in M_{[\epsilon, \infty)}$ is embedded in M . We call it simply the thick part after fixing ϵ to be at most the Margulis constant for \mathbb{H}^3 . Then the thin part (i.e. the complement of the thick part) is the disjoint union of tubes and cusp neighborhoods. A tube is a regular neighbourhood of a closed geodesic of length less than 2ϵ . By removing the cusp neighborhoods from M , we obtain a 3-manifold M_0 . Then the interior of M_0 is homeomorphic to M , and a boundary component of M_0 is a torus or annulus, called a cusp. For convenience, we ignore the distinction between M and M_0 . Thus an orientable hyperbolic 3-manifold of finite volume is regarded as a compact 3-manifold with (possibly empty) boundary consisting of torus cusps.

The upper half-space model gives the identifications of the ideal boundary $\partial\mathbb{H}^3 \cong \widehat{\mathbb{C}} = \mathbb{C} \cup \{\infty\}$ and the group of the orientation-preserving isometries $\text{Isom}^+(\mathbb{H}^3) \cong \text{PSL}(2, \mathbb{C})$. A torus cusp neighborhood is isometric to a neighborhood of the image of ∞ in \mathbb{H}^3/G , where $G \cong \mathbb{Z}^2$ is a group that consists of parabolic elements fixing ∞ . Thus a torus cusp admits the natural Euclidean structure up to scaling.

A 3-punctured sphere is obtained by removing three points from the 2-sphere, but we often regard it as a compact orientable surface of genus zero with three boundary components. We always assume that the boundary of a 3-punctured sphere in a hyperbolic 3-manifold is contained in the cusps. Adams [1] showed that an essential 3-punctured sphere in an orientable hyperbolic 3-manifold

is isotopic to a totally geodesic one. A totally geodesic 3-punctured sphere is isometric to the double of an ideal triangle in the hyperbolic plane \mathbb{H}^2 . Moreover, the hyperbolic structure of a 3-punctured sphere is unique up to isometry. After we cut a hyperbolic 3-manifold along a totally geodesic 3-punctured sphere, we can glue it again by an isometry along the new boundary. Since there are six orientation-preserving isometries of a totally geodesic 3-punctured sphere, we can construct hyperbolic 3-manifolds with a common volume.

We remark on an immersed 3-punctured sphere. The existence of a non-embedded immersed 3-punctured sphere almost determines the ambient hyperbolic 3-manifold.

Theorem 1.1 (Agol [3]). *Let Σ be an immersed 3-punctured sphere in an orientable hyperbolic 3-manifold M . Suppose that Σ is not homotopic to an embedded one. Then M is obtained by a (possibly empty) Dehn filling on a cusp of the Whitehead link complement. Furthermore, Σ is homotopic to a totally geodesic 3-punctured sphere immersed in M as shown in Figure 1.*

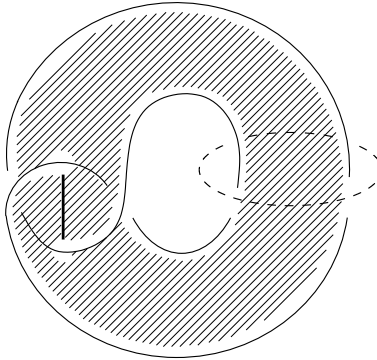

Figure 1: Non-embedded 3-punctured sphere

From now on, we consider embedded totally geodesic 3-punctured spheres. If all the 3-punctured spheres in a hyperbolic 3-manifold are disjoint, we can standardly decompose the 3-manifold along the 3-punctured spheres. However, 3-punctured spheres may intersect. Thus we consider all the 3-punctured spheres. Although the unions of 3-punctured spheres may be complicated, we can classify them. The JSJ decomposition of an irreducible orientable 3-manifold gives atoroidal pieces and Seifert pieces, and then every essential torus in the 3-manifold can be isotoped into a Seifert piece. Theorem 1.2 can be regarded as an analog of the classification of the Seifert 3-manifolds.

Theorem 1.2. *Let M be an orientable hyperbolic 3-manifold. Suppose that X is a connected component of the union of all the (embedded) totally geodesic 3-punctured spheres in M . Let $N(X)$ be a regular neighborhood of X . By abuse of terminology, we refer to the topological type of the pair $(N(X), X)$ as the type*

of X . If X consists of finitely many 3-punctured spheres, then X is one of the following types:

- (general types)
 $A_n (n \geq 1), B_{2n} (n \geq 1), T_3, T_4$.
- (types determining the manifolds)
 $Whi_{2n} (n \geq 2), Whi'_{4n} (n \geq 2), Bor_6, Mag_4, Tet_8, Pen_{10}, Oct_8$.
- (types almost determining the manifolds)
 $\widehat{Whi}_n (n \geq 2), \widehat{Whi}'_{2n} (n \geq 1), \widehat{Tet}_2, \widehat{Pen}_4, \widehat{Oct}_4$.

The indices indicate the numbers of 3-punctured spheres.

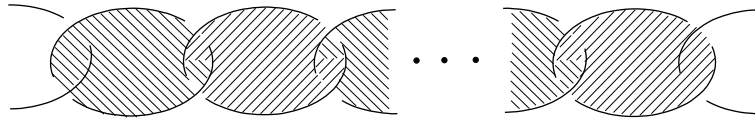

Figure 2: A_n

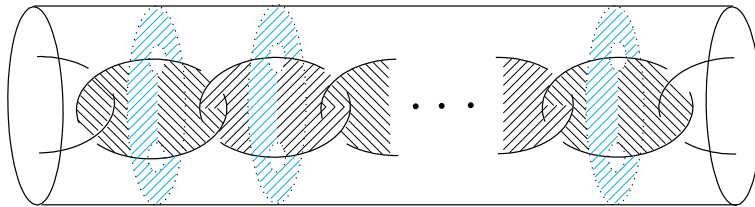

Figure 3: B_{2n}

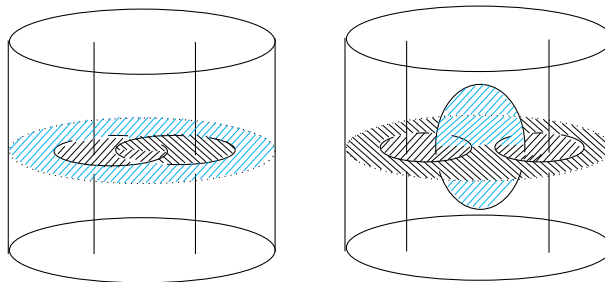

Figure 4: T_3 and T_4

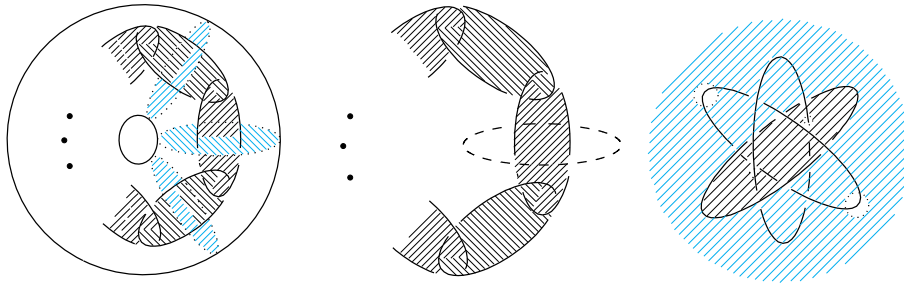

Figure 5: $Whi^{(l)}_{2n}$, $\widehat{Whi}^{(l)}_n$, and Bor_6

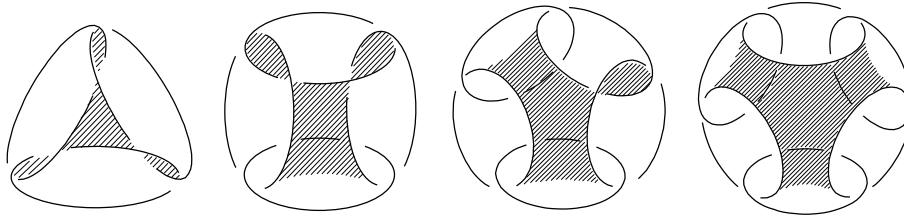

Figure 6: Mag_4 , Tet_8 , Pen_{10} , and Oct_8

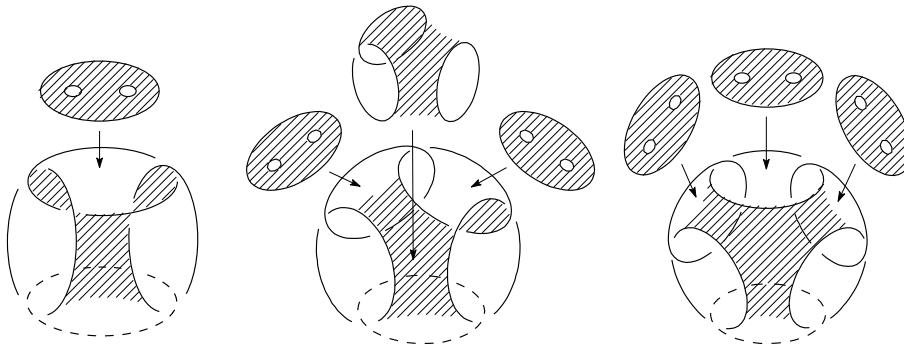

Figure 7: \widehat{Tet}_2 , \widehat{Pen}_4 , and \widehat{Oct}_4

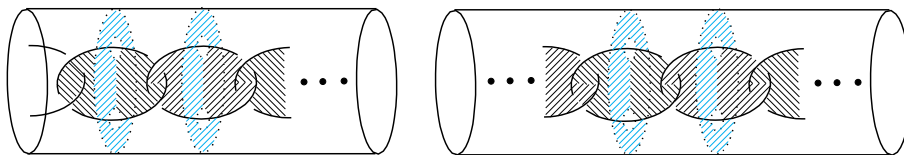

Figure 8: B_∞ and Whi_∞

Theorem 1.3. *Let M be an orientable hyperbolic 3-manifold. Suppose that X is a connected component of the union of all the totally geodesic 3-punctured spheres in M . If X consists of infinitely many 3-punctured spheres, then X is the type B_∞ or Whi_∞ .*

Careful descriptions of these types will be given in Section 2. Now we explain them briefly. The general types appear in various manifolds. For any finite multiset of general types, there are infinitely many hyperbolic 3-manifolds containing 3-punctured spheres of such types. When the type B_{2n}, T_3 , or T_4 appears, there are additional isolated 3-punctured spheres, which are contained in the boundary of 3-manifolds shown in Figures 3 and 4. In contrast, each of the determining types appears only in a certain special manifold. Not all the 3-punctured spheres are shown in Figures 5 and 6, because there are too many 3-punctured spheres. The almost determining types appear only in manifolds obtained by Dehn fillings of such special manifolds. The dashed circles in Figures 5 and 7 indicate filled cusps. For an (almost) determining type, the ambient 3-manifold has finite volume. For each $n \geq 2$, the unions of 3-punctured spheres of the types Whi_{4n} and Whi'_{4n} have a common topology as topological spaces, but they are distinguished by their neighborhoods. The same argument holds for \widehat{Whi}_{2n} and \widehat{Whi}'_{2n} .

For $3 \leq n \leq 6$, let \mathbb{M}_n denote the minimally twisted hyperbolic n -chain link complement as shown in Figure 6. The 3-punctured spheres of the types Mag_4, Tet_8, Pen_{10} , and Oct_8 are respectively contained only in the manifolds $\mathbb{M}_3, \mathbb{M}_4, \mathbb{M}_5$, and \mathbb{M}_6 . These manifolds are quite special for several reasons. Agol [4] conjectured that they have the smallest volume of the n -cusped orientable hyperbolic 3-manifolds. This conjecture was proven for \mathbb{M}_4 by the author [32].

The manifold \mathbb{M}_3 is called the magic manifold by Gordon and Wu [15]. It is known that many interesting examples are obtained by Dehn fillings of \mathbb{M}_3 . For example, Kin and Takasawa [21] showed that some mapping tori of punctured disk fibers with small entropy appear as Dehn fillings of \mathbb{M}_3 . The manifold \mathbb{M}_5 is known to give most of the census manifolds [9] by Dehn fillings. Martelli, Petronio, and Roukema [25] classified the non-hyperbolic manifolds obtained by Dehn fillings of \mathbb{M}_5 . Kolpakov and Martelli [22] constructed the first examples of finite volume hyperbolic 4-manifolds with exactly one cusp by using \mathbb{M}_6 . Baker [5] showed that every link in S^3 is a sublink of a link whose complement is a covering of \mathbb{M}_6 . He then used the link in Figure 9 to construct coverings of \mathbb{M}_6 efficiently. We can show that the complement of this link is homeomorphic to \mathbb{M}_6 by finding eight 3-punctured spheres of the type Oct_8 (see also [20, Lemma 5.9]).

Moreover, the manifolds $\mathbb{M}_3, \mathbb{M}_4, \mathbb{M}_5$, and \mathbb{M}_6 are arithmetic hyperbolic 3-manifolds. A cusped finite volume hyperbolic 3-manifold is arithmetic if and only if its fundamental group is commensurable to a Bianchi group $\mathrm{PSL}(2, \mathcal{O}_d)$, where \mathcal{O}_d is the ring of integers of the imaginary quadratic field $\mathbb{Q}(\sqrt{-d})$ (see [23, Ch. 8] for more details). Thurston [30, Ch. 6] gave an explicit representation of $\pi_1(\mathbb{M}_3)$ as a subgroup of $\mathrm{PSL}(2, \mathcal{O}_7)$. Baker [5] gave an explicit representation

of $\pi_1(\mathbb{M}_4)$ as a subgroup of $\mathrm{PSL}(2, \mathcal{O}_1)$, and showed that \mathbb{M}_6 is a double covering of \mathbb{M}_4 . The fundamental group of the Whitehead link complement is also commensurable to $\mathrm{PSL}(2, \mathcal{O}_1)$. Hatcher [16] showed that the fundamental group of a hyperbolic 3-manifold obtained from regular ideal tetrahedra (resp. regular ideal octahedra) is commensurable to $\mathrm{PSL}(2, \mathcal{O}_3)$ (resp. $\mathrm{PSL}(2, \mathcal{O}_1)$). As we will describe in Section 2, the manifold \mathbb{M}_5 can be decomposed into ten regular ideal tetrahedra. Hence $\pi_1(\mathbb{M}_5)$ is commensurable to $\mathrm{PSL}(2, \mathcal{O}_3)$. In addition, Kin and Rolfsen [20] studied bi-orderability of their fundamental groups.

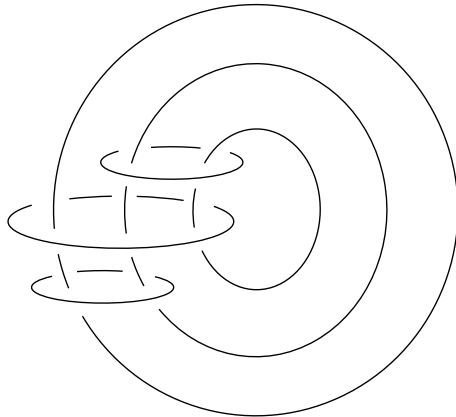

Figure 9: A link whose complement is \mathbb{M}_6

Eudave-Muñoz and Ozawa [12] characterized non-hyperbolic 3-component links in the 3-sphere whose complements contain essential 3-punctured spheres with non-integral boundary slopes. Moreover, they conjectured that a hyperbolic link complement does not contain an essential n -punctured sphere with non-meridional and non-integral boundary slope. Since our result does not concern embeddings of hyperbolic 3-manifolds in the 3-sphere, we do not solve this conjecture for 3-punctured spheres. Nevertheless, our result might be helpful to approach this conjecture.

2 Description of the types of the unions of 3-punctured spheres

In this section we describe the types of the unions of 3-punctured spheres in Theorems 1.2 and 1.3. This section concerns the existence of the 3-punctured spheres. In Section 3 we will show that each special manifold has no other 3-punctured spheres than the described ones.

We first introduce manifolds containing the 3-punctured spheres of some types. Let \mathbb{W}_n denote the manifold as shown in the left of Figure 5 that is an n -sheeted cyclic cover of the Whitehead link complement. Let \mathbb{W}'_n denote

the manifold obtained by a half twist along a blue 3-punctured sphere of \mathbb{W}_n , which can be also shown in the left of Figure 5. The manifolds \mathbb{W}_n and \mathbb{W}'_n are homeomorphic to certain link complements. For odd n , the manifold \mathbb{W}'_n is homeomorphic to \mathbb{W}_n by reversing orientation. Kaiser, Purcell and Rollins [19] described more details on these manifolds. Note that our notations are different from theirs. The manifolds $\mathbb{W}_{2n-1}, \mathbb{W}_{4n-2}, \mathbb{W}_{4n}, \mathbb{W}'_{4n-2}$, and \mathbb{W}'_{4n} are respectively homeomorphic to $\widehat{W}_{2n-1}, \overline{W}_{4n-2}, \widehat{W}_{4n}, \widehat{W}_{4n-2}$, and \overline{W}_{4n} in [19].

It is well known that the Whitehead link complement \mathbb{W}_1 can be decomposed into a regular ideal octahedron. Hence $\text{vol}(\mathbb{W}_n) = \text{vol}(\mathbb{W}'_n) = nV_{oct}$, where $V_{oct} = 3.6638\dots$ is the volume of a regular ideal octahedron. At present, this is the smallest known volume of the $(n+1)$ -cusped orientable hyperbolic 3-manifolds for $n \geq 10$. The manifold \mathbb{W}'_2 is the Borromean rings complement.

We recall that the manifolds $\mathbb{M}_3, \dots, \mathbb{M}_6$ are the minimally twisted hyperbolic n -chain link complements for $n = 3, \dots, 6$ as shown in Figure 6.

For $n \geq 1$, let \mathbb{B}_n denote the hyperbolic 3-manifold with totally geodesic boundary obtained by cutting \mathbb{W}_n along a blue 3-punctured sphere shown in the left of Figure 5. The manifold \mathbb{B}_n is shown in Figure 3. The manifold \mathbb{B}_1 can be decomposed into a regular ideal octahedron as shown in Figure 10, where faces X and X' are glued so that the orientations of edges match. We will use this decomposition in Section 5.

Similarly, let \mathbb{T}_3 and \mathbb{T}_4 denote the hyperbolic 3-manifolds with totally geodesic boundary respectively obtained by cutting \mathbb{M}_5 and \mathbb{M}_6 along a 3-punctured sphere. The manifolds \mathbb{T}_3 and \mathbb{T}_4 are shown in Figure 4.

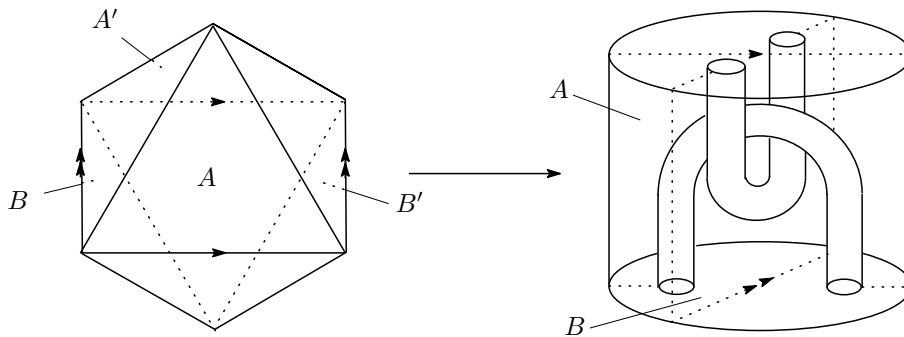

Figure 10: Gluing of a regular ideal octahedron for \mathbb{B}_1

A_n

The 3-punctured spheres of the type A_n are placed linearly, and can be regarded as the most general types. We consider an isolated 3-punctured sphere as the type A_1 . For example, an appropriate Dehn filling of \mathbb{W}_{n+3} gives a manifold with 3-punctured spheres of the type A_n .

B_{2n}, T_3, T_4

The manifolds $\mathbb{B}_{n+1}, \mathbb{T}_3$, and \mathbb{T}_4 respectively contain 3-punctured spheres of the types B_{2n}, T_3 , and T_4 . If there are 3-punctured spheres of the type B_{2n}, T_3 , or T_4 , there are two (possibly identical) isolated 3-punctured spheres that correspond to the boundary of $\mathbb{T}_3, \mathbb{T}_4$, or \mathbb{B}_{n+1} .

The 3-punctured spheres of the type B_{2n} consist of n 3-punctured spheres of the type A_n and n more 3-punctured spheres (shown in blue) which intersect the former ones. The 3-punctured spheres of the type T_3 intersect at a common geodesic. The type T_3 is symmetric. In other words, for any pair of 3-punctured spheres in \mathbb{T}_3 , there is an isometry of \mathbb{T}_3 that maps one of the pair to the other. A blue 3-punctured sphere in the type T_4 intersects the three other 3-punctured spheres. The latter three 3-punctured spheres are symmetric.

For each of the types B_{2n}, T_3 , and T_4 , the metric of neighborhood of the union is uniquely determined in $\mathbb{B}_{n+1}, \mathbb{T}_3$, or \mathbb{T}_4 . In contrast, the metric of neighborhood of the union of the type A_n for $n \geq 2$ depends on the modulus of an adjacent torus cusp. We will consider this modulus in Section 5.

$\widehat{Whi}^{(\prime)}_n$

If 3-punctured spheres are placed cyclically, their union is the type \widehat{Whi}_n or \widehat{Whi}'_{2n} . The two types \widehat{Whi}_{2n} and \widehat{Whi}'_{2n} are distinguished by neighborhoods.

Suppose that a hyperbolic 3-manifold M contains 3-punctured spheres of the type \widehat{Whi}_n . Then the union of the n 3-punctured spheres with the n adjacent torus cusps has a regular neighborhood homeomorphic to the manifold \mathbb{W}_n . The ambient 3-manifold M is obtained by a Dehn filling on a cusp of \mathbb{W}_n since it is atoroidal. The same argument holds for \widehat{Whi}'_{2n} in \mathbb{W}'_{2n} . In fact, such a surgered hyperbolic 3-manifold except $\mathbb{M}_3, \dots, \mathbb{M}_6$ contains no more 3-punctured spheres.

We remark that the Whitehead link complement \mathbb{W}_1 has two embedded 3-punctured spheres of the type \widehat{Whi}'_2 .

$Whi^{(\prime)}_{2n}$

The 3-punctured spheres of the type $Whi^{(\prime)}_{2n}$ consist of the n 3-punctured spheres of the type $\widehat{Whi}^{(\prime)}_n$ and n more 3-punctured spheres (shown in blue in the left of Figure 5) which intersect the former ones. The type $Whi^{(\prime)}_{2n}$ can be regarded as a cyclic version of B_{2n} .

The 3-punctured spheres of the types Whi_{2n} and Whi'_{4n} are respectively contained only in the manifolds \mathbb{W}_n and \mathbb{W}'_{2n} . Suppose that a hyperbolic 3-manifold M contains 3-punctured spheres of the type Whi_{2n} . Since M contains 3-punctured spheres of the type \widehat{Whi}_n , it is obtained by a (possibly empty) Dehn filling on a cusp of \mathbb{W}_n . Then the Dehn filling must be empty, because M has a cusp that does not intersect the 3-punctured spheres of the type \widehat{Whi}_n . Thus M is uniquely determined as \mathbb{W}_n . The same argument holds for Whi'_{4n} in \mathbb{W}'_{2n} .

Bor_6

The Borromean rings complement \mathbb{W}'_2 contains six 3-punctured spheres of the type Bor_6 instead of Whi'_4 . In order to display them, we put the Borromean rings so that each component is contained in a plane in \mathbb{R}^3 . Then there are two 3-punctured spheres in the union of each plane with the infinite point as shown in the right of Figure 5.

The union of the 3-punctured spheres of the type Bor_6 with the adjacent torus cusps has a regular neighborhood whose boundary consists of spheres. The ambient hyperbolic 3-manifold is uniquely determined as \mathbb{W}'_2 since it is irreducible.

$Mag_4, Tet_8, Pen_{10}, Oct_8$

The 3-punctured spheres of the types Mag_4, Tet_8, Pen_{10} , and Oct_8 are respectively contained only in the manifolds $\mathbb{M}_3, \mathbb{M}_4, \mathbb{M}_5$, and \mathbb{M}_6 . For $3 \leq n \leq 6$, the manifold \mathbb{M}_n contains 3-punctured spheres of the type $\widehat{Whi}^{(l)}_n$ and more 3-punctured spheres as shown in Figure 6. Rotational symmetry gives the remaining 3-punctured spheres.

Let X be the union of the 3-punctured spheres of such a special type. The union of X with the adjacent torus cusps has a regular neighborhood whose boundary consists of spheres. The ambient hyperbolic 3-manifold is uniquely determined since it is irreducible.

$\widehat{Tet}_2, \widehat{Pen}_4, \widehat{Oct}_4$

The 3-punctured spheres of the types $\widehat{Tet}_2, \widehat{Pen}_4$, and \widehat{Oct}_4 are respectively contained only in the hyperbolic manifolds obtained by Dehn fillings on a cusp of $\mathbb{M}_4, \mathbb{M}_5$, and \mathbb{M}_6 . In fact, such a surgered hyperbolic 3-manifold except $\mathbb{M}_3, \mathbb{M}_4$, and \mathbb{M}_5 contains no more 3-punctured spheres. The 3-punctured spheres of the types $\widehat{Tet}_2, \widehat{Pen}_4$, and \widehat{Oct}_4 come from the ones of the types Tet_8, Pen_{10} , and Oct_8 that are disjoint from the filled cusps.

Let X be the union of the 3-punctured spheres of such a special type. The union of X with the adjacent torus cusps has a regular neighborhood homeomorphic to $\mathbb{M}_4, \mathbb{M}_5$ – two balls, or \mathbb{M}_6 . The ambient hyperbolic 3-manifold is obtained by a Dehn filling on a cusp of $\mathbb{M}_4, \mathbb{M}_5$, or \mathbb{M}_6 since it is irreducible and atoroidal.

B_∞, Whi_∞

There are two types of the union of infinitely many 3-punctured spheres, which are infinite versions of B_{2n} . The 3-punctured spheres of the type Whi_∞ extend infinitely to both sides, and is contained only in the manifold \mathbb{W}_∞ shown in the right of Figure 8, which is an infinite cyclic cover of the Whitehead link complement \mathbb{W}_1 . The 3-punctured spheres of the type B_∞ extend infinitely to one side, and is contained in half of \mathbb{W}_∞ shown in the left of Figure 8.

It is possible to consider infinite versions of A_n , but in such a case there is a cusp that bounds additional 3-punctured spheres. Then the union is B_∞ or Whi_∞ . We will prove it in Section 5.

2.1 Symmetries of Mag_4 , Tet_8 , Pen_{10} , and Oct_8

The central 3-punctured sphere of M_3 in Figure 6 is special in the sense that this is the unique 3-punctured sphere intersecting any other one at two geodesics. In contrast, for any pair of the 3-punctured spheres in M_4, M_5 , or M_6 , the manifold has an isometry that maps one of the pair to the other.

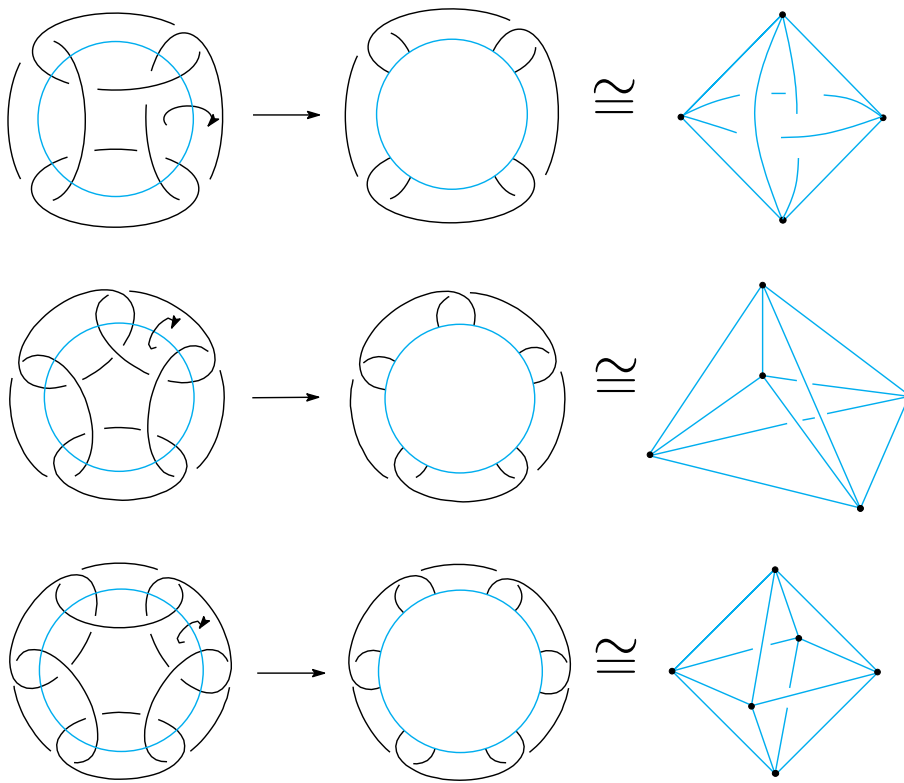

Figure 11: Quotients of M_4, M_5 , and M_6

Following Dunfield and Thurston [10], we describe the manifolds M_4, M_5 , and M_6 with respect to their intrinsic symmetry. Each of M_4, M_5 , and M_6 has an involutory isometry that rotates about the blue circle in Figure 11. The quotients by these involutions are naturally decomposed into ideal polyhedra. (In the deformations shown in the right side of Figure 11, the black arcs shrink to the black vertices.) Then the original manifolds are recovered by the double branched coverings. The quotient of M_5 is the boundary of a 4-dimensional

simplex (a.k.a. a pentachoron) made of five regular ideal tetrahedra. The quotient of \mathbb{M}_6 is the double of a regular ideal octahedron. The quotient of \mathbb{M}_4 is decomposed into four ideal tetrahedra whose dihedral angles are $\pi/4, \pi/4$, and $\pi/2$. Each 3-punctured sphere in $\mathbb{M}_4, \mathbb{M}_5$, and \mathbb{M}_6 is the preimage of a face of these ideal polyhedra by the double branched covering. In particular, the manifolds $\mathbb{M}_4, \mathbb{M}_5$, and \mathbb{M}_6 have isometries that can map a 3-punctured sphere to any other one.

If we cut the manifolds $\mathbb{M}_3, \mathbb{M}_4, \mathbb{M}_5$, and \mathbb{M}_6 along all the 3-punctured spheres, we respectively obtain two ideal triangular prisms, eight ideal tetrahedra each of which is a quarter of a regular ideal octahedron, ten regular ideal tetrahedra, and four regular ideal octahedra. By Sakuma and Weeks [28], these are the canonical decompositions in the sense of Epstein and Penner [11].

2.2 Graphs for the unions

In Figure 12, we give graphs that indicate how the 3-punctured spheres intersect. The vertices of a graph correspond to the 3-punctured spheres. Two vertices are connected by an edge if the corresponding 3-punctured spheres intersect. Two vertices are connected by two edges if the corresponding 3-punctured spheres intersect at two geodesics. An edge is oriented if the corresponding intersection is separating in a 3-punctured sphere and non-separating in the other 3-punctured sphere. Our notations T_3 and T_4 come from the triangle and tripod of the graphs.

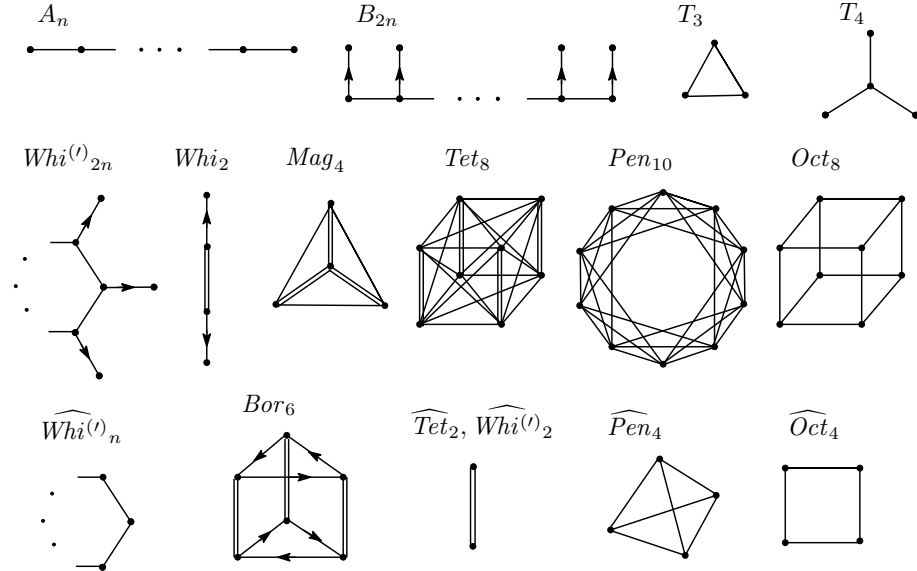

Figure 12: Graphs indicating intersection of 3-punctured spheres

2.3 3-punctured spheres in a non-orientable hyperbolic 3-manifold

We remark that the assumption of orientability is necessary. For instance, we can obtain a non-orientable hyperbolic 3-manifold \mathbb{N}_3 by gluing one regular ideal octahedron as shown in Figure 13. The manifold \mathbb{N}_3 was given by Adams and Sherman [2] as the 3-cusped hyperbolic 3-manifold of minimal complexity. We remark that the manifold \mathbb{M}_5 is the 5-cusped hyperbolic 3-manifold of minimal complexity. The pairs of faces $A \cup B$ and $C \cup D$ are mapped to two 3-punctured spheres in \mathbb{N}_3 . These 3-punctured spheres intersect at three geodesics. Such intersection does not appear in an orientable hyperbolic 3-manifold as we will show in Lemma 3.2.

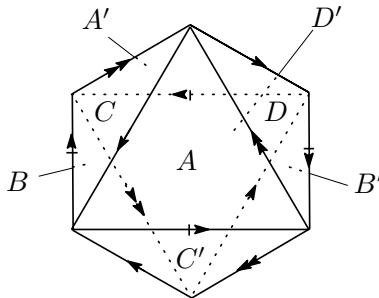

Figure 13: Gluing of a regular ideal octahedron for \mathbb{N}_3

3 Proof of the classification

We begin to prove Theorem 1.2. Theorem 1.3 will be proven in Section 5. We consider totally geodesic embedded 3-punctured spheres in an orientable hyperbolic 3-manifold. For simplicity, we assume that every 3-punctured sphere is totally geodesic. We first consider the intersection of two 3-punctured spheres. After that, we classify the union of 3-punctured spheres.

3.1 Intersection of two 3-punctured spheres

In this subsection, we classify the intersection of two 3-punctured spheres. The intersection of two 3-punctured spheres consists of disjoint simple geodesics. There are six simple geodesics in a 3-punctured sphere. Three of them are non-separating, and the other three are separating as shown in Figure 14. A component of the intersection of two 3-punctured spheres is a type (N,N), (S,N), or (S,S) depending on whether the geodesic is non-separating or separating in the two 3-punctured spheres. Of course, “N” and “S” respectively indicate non-separating and separating. In Lemma 3.4, we will show that an (S,S)-intersection does not occur. The unions of the types A_2 and B_2 , shown in Theorem 1.2, respectively contain an (N,N)-intersection and an (S,N)-intersection.

Proposition 3.1. *The intersection of two 3-punctured spheres in an orientable hyperbolic 3-manifold is one of the following types:*

- (o) *The intersection is empty, i.e. the two 3-punctured spheres are disjoint.*
- (i) *The intersection consists of an (N,N) -intersection.*
- (ii) *The intersection consists of an (S,N) -intersection.*
- (iii) *The intersection consists of two (N,N) -intersections.*

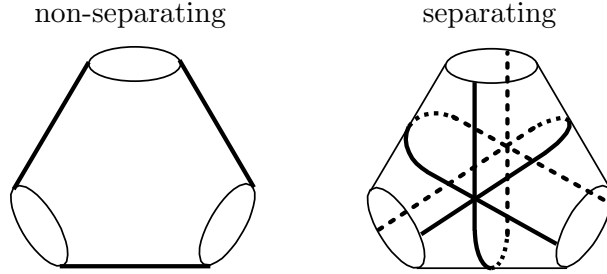

Figure 14: The simple geodesics in a 3-punctured sphere

We show that the other types of intersection are impossible. There are at most three disjoint simple geodesics in a 3-punctured sphere. We first show that the intersection of two 3-punctured spheres does not consist of three geodesics.

Lemma 3.2. *Let M be a (possibly non-orientable) hyperbolic 3-manifold. Suppose that M contains 3-punctured spheres Σ_0 and Σ_1 that intersect at three geodesics. Then M is decomposed into a regular ideal octahedron along Σ_0 and Σ_1 . Furthermore, M is non-orientable.*

Proof. We regard the hyperbolic 3-space \mathbb{H}^3 as the universal covering of M , and use the upper-half space model of \mathbb{H}^3 . We denote by (a, b) the geodesic in \mathbb{H}^3 whose endpoints are $a, b \in \widehat{\mathbb{C}} = \partial\mathbb{H}^3$. Let $\widetilde{\Sigma}_i \subset \mathbb{H}^3$ denote the preimage of Σ_i for $i = 0, 1$. Let $\widetilde{\Sigma}_0^0$ be a component of $\widetilde{\Sigma}_0$. The plane $\widetilde{\Sigma}_0^0$ contains an ideal triangle Δ whose edges are lifts of the intersection $\Sigma_0 \cap \Sigma_1$. We may assume that the vertices of Δ are $0, 1, \infty \in \widehat{\mathbb{C}} = \partial\mathbb{H}^3$. Hence there are components $\widetilde{\Sigma}_1^k$ of $\widetilde{\Sigma}_1$ for $k = 0, 1, 2$ such that $\widetilde{\Sigma}_0^0 \cap \widetilde{\Sigma}_1^0 = \overline{(0, \infty)}$, $\widetilde{\Sigma}_0^0 \cap \widetilde{\Sigma}_1^1 = \overline{(1, \infty)}$, and $\widetilde{\Sigma}_0^0 \cap \widetilde{\Sigma}_1^2 = \overline{(0, 1)}$. Since Σ_1 is embedded in M , the three planes $\widetilde{\Sigma}_1^0, \widetilde{\Sigma}_1^1$, and $\widetilde{\Sigma}_1^2$ are mutually disjoint. Therefore $\widetilde{\Sigma}_1^0, \widetilde{\Sigma}_1^1$, and $\widetilde{\Sigma}_1^2$ orthogonally intersect $\widetilde{\Sigma}_0^0$.

In the same manner, there are components $\widetilde{\Sigma}_0^1$ and $\widetilde{\Sigma}_0^2$ of $\widetilde{\Sigma}_0$ such that $\widetilde{\Sigma}_0^1 \cap \widetilde{\Sigma}_1^0 = \overline{(ai, \infty)}$ and $\widetilde{\Sigma}_0^2 \cap \widetilde{\Sigma}_1^0 = \overline{(0, ai)}$ for $a > 0$. The planes $\widetilde{\Sigma}_0^1$ and $\widetilde{\Sigma}_0^2$ orthogonally intersect $\widetilde{\Sigma}_1^0$.

We continue the same argument. Since each of the preimages of Σ_0 and Σ_1 consists of disjoint planes, we have $a = 1$. There are components $\widetilde{\Sigma}_j^3$ of $\widetilde{\Sigma}_j$ such that $\widetilde{\Sigma}_0^3 \cap \widetilde{\Sigma}_1^1 = \overline{(1, 1+i)}$ and $\widetilde{\Sigma}_0^1 \cap \widetilde{\Sigma}_1^3 = \overline{(i, 1+i)}$. Figure 15 shows the boundary

of these planes in $\widehat{\mathbb{C}}$. The planes $\widetilde{\Sigma}_j^k$ for $j = 0, 1$ and $k = 0, 1, 2, 3$ bound a regular ideal octahedron. The other components of $\widetilde{\Sigma}_0$ and $\widetilde{\Sigma}_1$ are disjoint from this regular ideal octahedron. An isometry of a regular ideal octahedron has a fixed point in the interior. Consequently, if M is decomposed along Σ_0 and Σ_1 , one of the components after the decomposition is a regular ideal octahedron. Now the surface area of a regular ideal octahedron is equal to 8π , and the area of a 3-punctured sphere is equal to 2π . Therefore there are no other components after the decomposition.

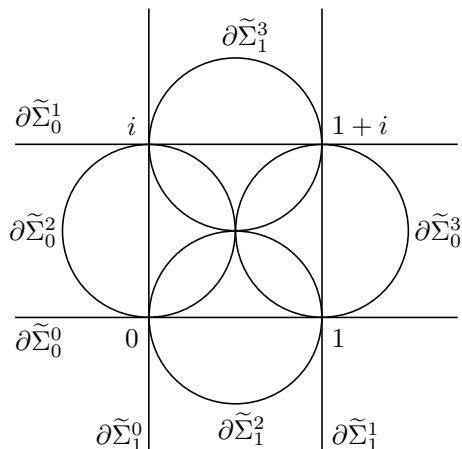

Figure 15: Boundary of components of $\widetilde{\Sigma}_0$ and $\widetilde{\Sigma}_1$

According to the cusped octahedral census by Goerner [14, Table 2], there are two orientable hyperbolic 3-manifolds and six non-orientable hyperbolic 3-manifolds obtained from one regular ideal octahedron. Agol [4] showed that the Whitehead link complement and the $(-2, 3, 8)$ -pretzel link complement have the smallest volume V_{oct} of the orientable hyperbolic 3-manifold with two cusps, and described the ways to glue a regular ideal octahedron to obtain the two manifolds. Assume that M is orientable. Then M is one of the above two manifolds. The 3-punctured spheres Σ_0 and Σ_1 are the images of the faces of a regular ideal octahedron. The gluing ways, however, do not give two 3-punctured spheres from the faces of a regular ideal octahedron. \square

Therefore the intersection of two 3-punctured spheres in an orientable hyperbolic 3-manifold cannot consist of three geodesics. We orient the hyperbolic 3-manifold and the 3-punctured spheres. We can easily show the following lemma by considering the orientation of a neighborhood of the arc.

Lemma 3.3. *Let S and T be properly embedded oriented surfaces in an oriented 3-manifold with boundary. Suppose that S and T intersect transversally. Let an arc g be a component of $S \cap T$. Let x_0 and x_1 denote the endpoints of g . For $i = 0$ and 1 , let s_i denote the boundary components of S containing x_i , which*

possibly coincide. In the same manner, let t_i denote the boundary components of T containing x_i . Then the intersections of s_i and t_i at x_i have opposite signs with respect to the induced orientation.

We return the cases of two 3-punctured spheres in an oriented hyperbolic 3-manifold. Note that the boundary components of a 3-punctured sphere are closed geodesics in a cusp with respect to its Euclidean metric.

Lemma 3.4. *The intersection of two 3-punctured spheres contain no (S,S) -intersection.*

Proof. Assume that a geodesic g in the intersection is separating in both 3-punctured spheres. Note that there might be another component of the intersection. We consider a cusp containing the endpoints of g . Let s and t denote the boundary components of the two 3-punctured spheres that intersect g . Then the intersection of the loops s and t contains at least the endpoints of g . Since the loops s and t are contained in a common cusp, the signs of the intersection at these endpoints coincide. This is impossible by Lemma 3.3. \square

We suppose that the intersection of two 3-punctured spheres consists of two geodesics.

Lemma 3.5. *The intersection of two 3-punctured spheres does not consist of one (N,N) -intersection and one (S,N) -intersection.*

Proof. Assume that two 3-punctured spheres intersect at one (N,N) -intersection and one (S,N) -intersection. There are two possibilities of the intersection as shown in the left and center of Figure 16.

In the left case, a cusp contains three loops s, u , and v of boundary components of the 3-punctured spheres. The loops u and v are disjoint. The loops s and u intersect at two points, but the loops s and v intersect at one point. This is impossible.

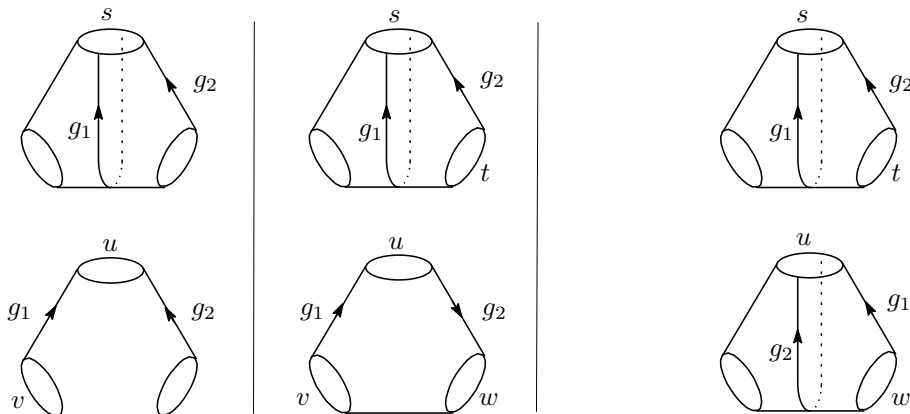

Figure 16: Orientations of two geodesics containing an (S,N) -intersection

In the central case, a cusp contains five loops s, t, u, v , and w of boundary components of the 3-punctured spheres. The two loops s and t are disjoint, and the three loops u, v , and w are mutually disjoint. Hence the number of intersection of these five loops is a multiple of six. This contradicts the fact that the intersection consists of the four endpoints of the two geodesics g_1 and g_2 . \square

Lemma 3.6. *The intersection of two 3-punctured spheres does not consist of two (S, N) -intersections.*

Proof. Assume that two 3-punctured spheres intersect at two (S, N) -intersections. It is sufficient to consider the intersection as shown in the right of Figure 16.

In the case, a cusp contains four loops s, t, u , and w of the boundary components of the 3-punctured spheres. Then $s \cap t = \emptyset, u \cap w = \emptyset, t \cap w = \emptyset$, whereas $s \cap u \neq \emptyset$. This is impossible. \square

Proof of Proposition 3.1. We have excluded the cases other than the cases in Proposition 3.1. \square

3.2 The unions with the type (iii)-intersection

In this subsection, we classify the unions of 3-punctured spheres that contain the type (iii)-intersection shown in Proposition 3.1.

Lemma 3.7. *If two 3-punctured spheres have the type (iii)-intersection, the ambient hyperbolic 3-manifold is obtained by a (possibly empty) Dehn filling from one of the following manifolds (Figure 17):*

- the manifold \mathbb{W}_2 , which is a double covering of the Whitehead link complement,
- the Borromean rings complement \mathbb{W}'_2 , or
- the minimally twisted hyperbolic 4-chain link complement \mathbb{M}_4 .

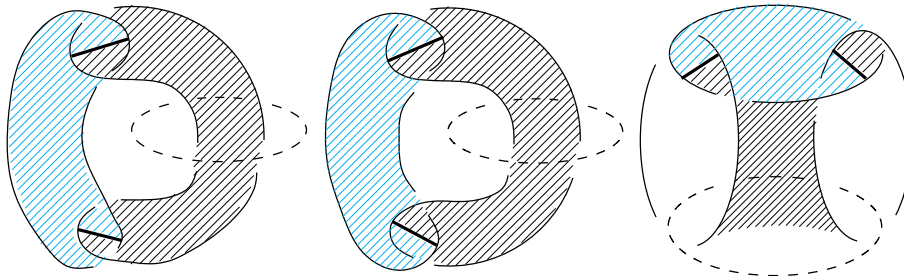

Figure 17: Two 3-punctured spheres intersecting at two geodesics

Note that each of the manifolds $\mathbb{W}_2, \mathbb{W}'_2$, and \mathbb{M}_4 is obtained by gluing two regular ideal octahedra, and hence they have a common volume.

Proof. There are three possibilities depending on the orientations of intersectional geodesics as shown in Figure 18.

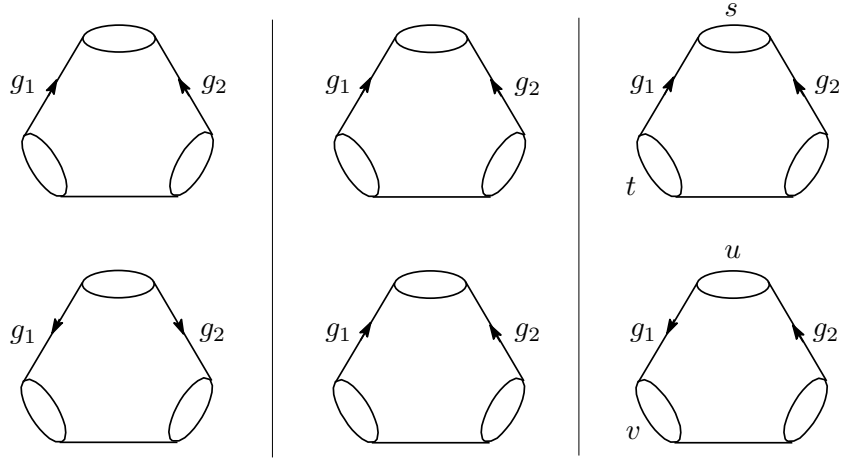

Figure 18: Orientations of two (N,N)-intersections

The left case gives the union of two 3-punctured spheres of the types \widehat{Whi}_2 and \widehat{Whi}'_2 depending on the signs of the intersections on the boundary. The union of the two 3-punctured spheres with the adjacent cusps has a regular neighbourhood whose boundary is a torus. Hence the ambient 3-manifold is obtained by a (possibly empty) Dehn filling from \mathbb{W}_2 or \mathbb{W}'_2 .

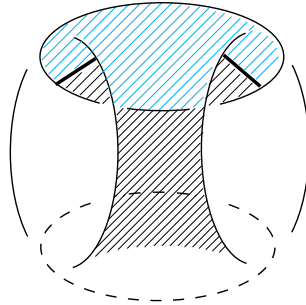

Figure 19: The non-hyperbolic minimally twisted 4-chain link

The central case also gives two types of the union depending on the signs of the intersections on the boundary. One of these is the type \widehat{Tet}_2 . Then the ambient 3-manifold is obtained by a (possibly empty) Dehn filling from \mathbb{M}_4 in the same manner as above. The other type occurs in a manifold obtained by a (possibly empty) Dehn filling from the non-hyperbolic minimally twisted 4-chain link complement \mathbb{M}'_4 as shown in Figure 19. The manifold \mathbb{M}'_4 can be decom-

posed along a torus into two copies of $\Sigma \times S^1$, where Σ is a 3-punctured sphere. Hence the ambient 3-manifold is a graph manifold, which is not hyperbolic.

The right case does not occur. Assume that it occurs. Then a cusp contains four boundary components s, t, u , and v of the 3-punctured spheres. We have $s \cap t = \emptyset$ and $u \cap v = \emptyset$, but the intersection in s, t, u , and v consists of three points. This is impossible. \square

In Lemmas 3.11–3.15, we will show that if two 3-punctured spheres have the type (iii)-intersection shown in Proposition 3.1, then the union of all the 3-punctured spheres is $Whi_4, \widehat{Whi}_2, Bor_6, \widehat{Whi}'_2, Tet_8, \widehat{Tet}_2$, or Mag_4 . We need Corollary 3.9 and Lemma 3.10 to prove that there are no other 3-punctured spheres than the described ones in certain manifolds.

Theorem 3.8 (Miyamoto [27]). *Let N be a hyperbolic 3-manifold with totally geodesic boundary. Then*

$$\text{vol}(N) \geq \frac{1}{2} |\chi(\partial N)| V_{\text{oct}},$$

where χ indicates the Euler characteristic, and $V_{\text{oct}} = 3.6638\dots$ is the volume of a regular ideal octahedron.

Corollary 3.9. *A hyperbolic 3-manifold M contains at most $\lfloor \text{vol}(M)/V_{\text{oct}} \rfloor$ disjoint 3-punctured spheres.*

Proof. By cutting n disjoint totally geodesic 3-manifolds, we obtain a hyperbolic 3-manifold N with totally geodesic boundary such that $\chi(\partial N) = -2n$. Then we apply Theorem 3.8 to N . \square

Lemma 3.10. *Let M be an orientable hyperbolic 3-manifold. Suppose that two distinct totally geodesic 3-punctured spheres Σ and Σ' in M represent a common homology class in $H_2(M, \partial M; \mathbb{Z})$. Then Σ and Σ' are disjoint.*

Proof. It is sufficient to show that $\partial\Sigma \cap \partial\Sigma' = \emptyset$. For $i = 0, 1, 2$, let s_i and s'_i denote the components of $\partial\Sigma$ and $\partial\Sigma'$. The unions of loops $\partial\Sigma = s_0 \cup s_1 \cup s_2$ and $\partial\Sigma' = s'_0 \cup s'_1 \cup s'_2$ represent a common homology class in $H_1(\partial M; \mathbb{Z})$.

We first suppose the homology classes of any pair of s_0, s_1 , and s_2 do not cancel in $H_1(\partial M; \mathbb{Z})$. By changing indices, we may assume that $[s_i] = [s'_i] \in H_1(\partial M; \mathbb{Z})$. Since the loops s_i and s'_j do not coincide, we have $\partial\Sigma \cap \partial\Sigma' = \emptyset$.

Otherwise we may assume that $[s_0] = -[s_1]$ and $[s'_0] = -[s'_1]$ in $H_1(\partial M; \mathbb{Z})$. If $s_0 \cup s_1$ and $s'_0 \cup s'_1$ intersect, then Σ and Σ' have the type (iii)-intersection, and the loops s_0, s_1, s'_0 , and s'_1 are contained in a common cusp. This is impossible by Lemma 3.7. Therefore we have $\partial\Sigma \cap \partial\Sigma' = \emptyset$. \square

In order to apply Corollary 3.9 and Lemma 3.10, we use the Thurston norm. For a surface $S = \sqcup_i S_i$ (each S_i is a connected component), we define $\chi_-(S) = \sum_i \max\{0, -\chi(S_i)\}$. For an orientable compact 3-manifold M , the Thurston norm of a class $\sigma \in H_2(M, \partial M; \mathbb{Z})$ is defined to be $\|\sigma\| = \min \chi_-(S)$, where the minimum is taken over the (possibly disconnected) embedded surfaces S

that represent the class σ . Thurston [31] showed that $\|\cdot\|$ is extended to a norm on $H_2(M, \partial M; \mathbb{R})$ for a hyperbolic 3-manifold, and the unit norm ball $\{\sigma \in H_2(M, \partial M; \mathbb{R}) \mid \|\sigma\| \leq 1\}$ is convex. Note that the norm $\|\sigma\|$ of an integer class σ is odd if and only if σ can be represented by an essential surface S such that the number of the components of ∂S is odd.

Lemma 3.11. *The Borromean rings complement \mathbb{W}'_2 has exactly the six 3-punctured spheres of the type Bor_6 .*

Proof. Thurston [31] described the unit Thurston norm ball for \mathbb{W}'_2 as follows. We may assume that linearly independent classes $x, y, z \in H_2(\mathbb{W}'_2, \partial \mathbb{W}'_2; \mathbb{R})$ are represented by three of the 3-punctured spheres of the type Bor_6 as described in Section 2. The classes x, y and z form a basis of $H_2(\mathbb{W}'_2, \partial \mathbb{W}'_2; \mathbb{R}) \cong \mathbb{R}^3$. Moreover, $\|x\| = \|y\| = \|z\| = 1$. The eight classes $\pm x \pm y \pm z$ are fibered class, i.e. they are represented by a fiber of a mapping torus. Hence each of the classes $\pm x \pm y \pm z$ is not represented by a 3-punctured sphere. Moreover, each of the classes $\pm x \pm y \pm z$ is represented by a surface with at least three boundary components. Hence $\|\pm x \pm y \pm z\| \neq 1$. Therefore we have $\|\pm x \pm y \pm z\| = 3$. The 14 classes $\pm x, \pm y, \pm z$, and $(\pm x \pm y \pm z)/3$ are contained in the boundary of the unit Thurston norm ball. This fact and the convexity imply that the unit Thurston norm ball is the octahedron whose vertices are $\pm x, \pm y$, and $\pm z$.

We know that $\pm x, \pm y$, and $\pm z$ are exactly the integer classes in the boundary of the unit Thurston norm ball. Hence any 3-punctured sphere in \mathbb{W}'_2 represents $\pm x, \pm y$, or $\pm z$. By ignoring the orientation, we may state that for each of x, y , and z , there are two 3-punctured spheres each of which represents the class. Therefore it is sufficient to show that x, y and z cannot be represented by any other 3-punctured sphere. Assume that \mathbb{W}'_2 has another 3-punctured sphere Σ . Then Lemma 3.10 implies that Σ is disjoint from the two 3-punctured spheres representing the same class. This contradicts Corollary 3.9 and the fact that $\text{vol}(\mathbb{W}'_2) = 2V_{oct}$. Therefore \mathbb{W}'_2 has no other 3-punctured spheres than the described ones of Bor_6 . \square

Lemma 3.12. *The manifold \mathbb{W}_2 has exactly the four 3-punctured spheres of the type Whi_4 .*

Proof. Since $\text{vol}(\mathbb{W}_2) = 2V_{oct}$, the manifold \mathbb{W}_2 contains at most two disjoint 3-punctured spheres by Corollary 3.9. Let $\Sigma_1, \dots, \Sigma_4$ be the 3-punctured spheres of Whi_4 , and let C_1, \dots, C_3 be the cusps of \mathbb{W}_2 as shown in Figure 20. In order to show that there are no other 3-punctured spheres, we describe the unit Thurston norm ball for \mathbb{W}_2 . Let $x \in H_2(\mathbb{W}_2, \partial \mathbb{W}; \mathbb{R})$ denote the class represented by each of Σ_1 and Σ_2 , and let $y, z \in H_2(\mathbb{W}_2, \partial \mathbb{W}; \mathbb{R})$ denote the classes respectively represented by Σ_3 and Σ_4 . The classes x, y , and z form a basis of $H_2(\mathbb{W}_2, \partial \mathbb{W}; \mathbb{R}) \cong \mathbb{R}^3$. Moreover, $\|x\| = \|y\| = \|z\| = 1$. Consider the class $x + y + z$. A surface representing $x + y + z$ intersects the three cusps. If we show that $x + y + z$ cannot be represented by a 3-punctured sphere, we have $\|x + y + z\| = 3$.

Assume that $x + y + z$ is represented by a 3-punctured sphere Σ . The boundary slopes of Σ are determined, and each cusp contains one of these slopes.

The intersection $\Sigma \cap \Sigma_1$ is disjoint from the cusp C_1 . Since each cusp contains exactly one boundary component of Σ , the intersection $\Sigma \cap \Sigma_i$ for $i = 1, 3$ is not a separating geodesic in Σ_i . Hence Σ and Σ_1 are disjoint. Similarly, Σ and Σ_2 are also disjoint. This contradicts the fact that \mathbb{W}_2 contains at most two disjoint 3-punctured spheres.

In the same manner, we have $\|\pm x \pm y \pm z\| = 3$. Hence the unit Thurston norm ball for \mathbb{W}_2 is the octahedron whose vertices are $\pm x, \pm y$, and $\pm z$ similarly to \mathbb{W}'_2 . Therefore any 3-punctured sphere in \mathbb{W}_2 represents $\pm x, \pm y$, or $\pm z$.

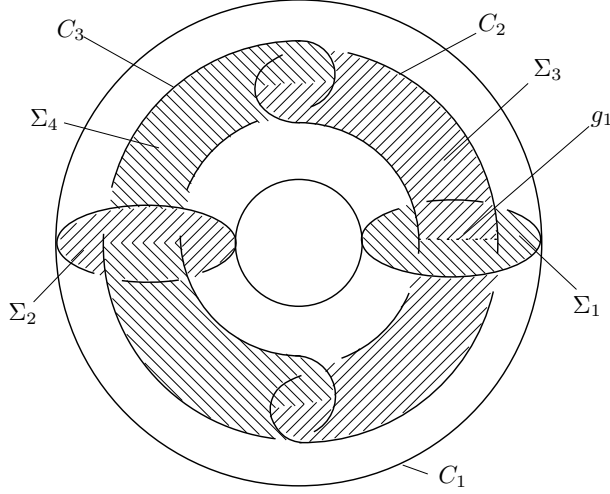

Figure 20: The 3-punctured spheres of the type Whi_4

Now the class x is represented only by Σ_1 and Σ_2 . Assume that \mathbb{W}_2 has another 3-punctured sphere Σ representing y than Σ_3 . Then $\Sigma \cap \Sigma_3 = \emptyset$. Since the homology classes represented by the components of $\partial\Sigma_3$ do not cancel, the boundary $\partial\Sigma$ consists of a loop in C_2 and two loops in C_3 . Hence Σ intersects Σ_1 at the geodesic $g_1 = \Sigma_1 \cap \Sigma_3$. This contradicts the fact that $\Sigma \cap \Sigma_3 = \emptyset$. Hence there are no other 3-punctured spheres representing y than Σ_3 . The same argument holds for z . Therefore \mathbb{W}_2 has no other 3-punctured spheres than $\Sigma_1, \dots, \Sigma_4$. \square

Lemma 3.13. *The manifold \mathbb{M}_4 has exactly the eight 3-punctured spheres of the type Tet_8 .*

Proof. We first describe the unit Thurston norm ball for \mathbb{M}_4 . Let $\Sigma_1, \dots, \Sigma_4$ be the 3-punctured spheres as shown in Figure 21, which respectively represent $x, y, z, w \in H_2(\mathbb{M}_4, \partial\mathbb{M}_4; \mathbb{R})$. Here the orientations of these 3-punctured spheres are induced by the projection to the diagram. Let $\Sigma_5, \dots, \Sigma_8$ denote the 3-punctured spheres that respectively represent $y + z + w, -x + z + w, x + y - w$, and $x + y + z$. These eight 3-punctured spheres are the ones described in Section 2.

Let $u_1 = (x + y)/2$, $u_2 = (y + z)/2$, $u_3 = (z + w)/2$, and $u_4 = (x - w)/2$. The classes u_1, \dots, u_4 form a basis of $H_2(\mathbb{M}_4, \partial\mathbb{M}_4; \mathbb{R}) \cong \mathbb{R}^4$. With respect to this basis, we can present classes as

$$\begin{aligned} x &= (1, -1, 1, 1), \quad y = (1, 1, -1, -1), \quad z = (-1, 1, 1, 1), \quad w = (1, -1, 1, -1), \\ y + z + w &= (1, 1, 1, -1), \quad -x + z + w = (-1, 1, 1, -1), \\ x + y - w &= (1, 1, -1, 1), \quad x + y + z = (1, 1, 1, 1). \end{aligned}$$

Since the norms of $u_1, \dots, u_4, x, y, z, w, y + z + w, -x + z + w, x + y - w$, and $x + y + z$ are equal to one, the convexity implies that the unit Thurston norm ball for \mathbb{M}_4 is the 4-dimensional cube whose vertices are $\pm x, \pm y, \pm z, \pm w, \pm(y + z + w), \pm(-x + z + w), \pm(x + y - w)$, and $\pm(x + y + z)$. Therefore any 3-punctured sphere in \mathbb{M}_4 represents one of these classes.

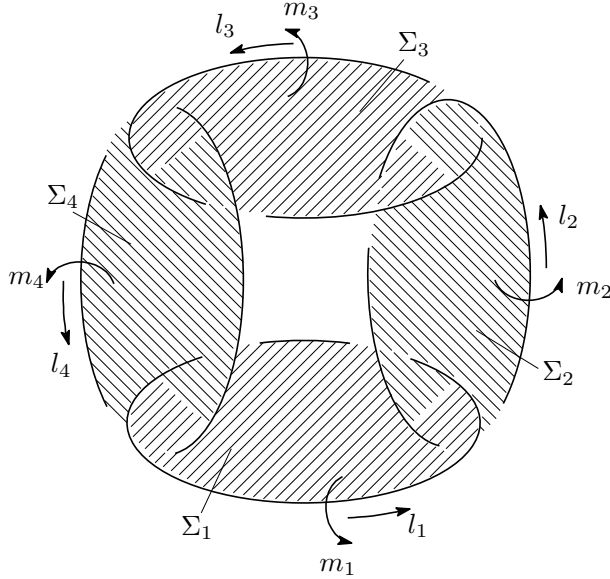

Figure 21: Four 3-punctured spheres in \mathbb{M}_4

As we showed in Section 2, for any pair of $\Sigma_1, \dots, \Sigma_8$, there is an isometry of \mathbb{M}_4 that maps one of the pair to the other. Hence it is sufficient to show that Σ_1 is the unique 3-punctured sphere representing x .

Since $\text{vol}(\mathbb{M}_4) = 2V_{oct}$, the manifold \mathbb{M}_4 contains at most two disjoint 3-punctured spheres by Corollary 3.9. Assume that \mathbb{M}_4 has another 3-punctured sphere Σ representing x than Σ_1 . Lemma 3.10 implies that $\Sigma \cap \Sigma_1 = \emptyset$. Since the components of $\partial\Sigma$ are contained in distinct cusps, their three slopes are the same as the slopes of $\partial\Sigma_1$. Hence $\Sigma \cap \Sigma_3 = \emptyset$. This contradicts the fact that \mathbb{M}_4 contains at most two disjoint 3-punctured spheres. \square

Lemma 3.14. *Let M be a hyperbolic 3-manifold obtained by a (non-empty) Dehn filling on the cusp of \mathbb{W}_2 or \mathbb{W}'_2 as in Lemma 3.7. Then M has exactly the two 3-punctured spheres of the type \widehat{Whi}_2 or \widehat{Whi}'_2 respectively.*

Proof. The Mayer-Vietoris sequence and the Poincaré duality imply that $H_2(M, \partial M; \mathbb{R}) \cong \mathbb{R}^2$. The manifold M contains at least two 3-punctured spheres of the type \widehat{Whi}_2 or \widehat{Whi}'_2 . They represent classes x and y that form a basis of $H_2(M, \partial M; \mathbb{R})$. Since $\|x\| = \|y\| = 1$ and $\|x + y\| = \|x - y\| = 2$, the unit Thurston norm ball for M is the square whose vertices are $\pm x$ and $\pm y$. Hence any 3-punctured sphere in M represents $\pm x$ or $\pm y$. Since a hyperbolic Dehn surgery decreases the volume [30, Theorem 6.5.6], we have $\text{vol}(M) < 2V_{oct}$. Hence the manifold M does not contain two disjoint 3-punctured spheres by Corollary 3.9. Therefore M has no other 3-punctured spheres. \square

Lemma 3.15. *Let M be a hyperbolic 3-manifold obtained by a (non-empty) Dehn filling on a cusp of \mathbb{M}_4 . If $M = \mathbb{M}_3$, it has exactly the four 3-punctured spheres of the type Mag_4 . Otherwise M has exactly the two 3-punctured spheres of the type \widehat{Tet}_2 .*

Proof. Thurston [31] described the unit Thurston norm ball for \mathbb{M}_3 as follows. We may assume that the four known 3-punctured spheres represent $x, y, z, x + y + z \in H_2(\mathbb{M}_3, \partial \mathbb{M}_3; \mathbb{R})$. Then the unit Thurston norm ball is the parallelepiped whose vertices are $\pm x, \pm y, \pm z$, and $\pm(x + y + z)$. Since $\text{vol}(\mathbb{M}_3) < 2V_{oct}$, the manifold \mathbb{M}_3 has no other 3-punctured spheres by Corollary 3.9.

We orient the meridians m_i and the longitudes l_i of the cusps of \mathbb{M}_4 as shown in Figure 21. For coprime integers $p \geq 0$ and q , let M be a hyperbolic 3-manifold obtained by the (p, q) -Dehn filling on the first cusp of \mathbb{M}_4 . In other words, M is obtained by gluing a solid torus to \mathbb{M}_4 along the slope $pm_1 + ql_1$ as meridian. If $(p, q) = (0, 1), (1, 0), (1, 1)$, or $(2, 1)$, then M is not hyperbolic. If $(p, q) = (1, -1), (1, 2), (3, 1)$, or $(3, 2)$, then $M = \mathbb{M}_3$. We exclude these cases. Note that in general four Dehn fillings give a common 3-manifold by the symmetry of \mathbb{M}_4 .

Following the notation in Lemma 3.13, the two 3-punctured spheres Σ_3 and Σ_5 in \mathbb{M}_4 are disjoint from the filled cusp. Their union is \widehat{Tet}_2 . Assume that M contains another 3-punctured sphere Σ than Σ_3 or Σ_5 . We may assume that Σ is the union of an n -punctured sphere Σ' in \mathbb{M}_4 and $(n - 3)$ essential disks in the filled solid torus. Suppose that Σ' represents $ax + by + cz + dw \in H_2(\mathbb{M}_4, \partial \mathbb{M}_4; \mathbb{R})$ for $a, b, c, d \in \mathbb{Z}$. Note that n is odd if and only if $a + b + c + d$ is odd. Then the homology classes of the boundaries are

$$\begin{aligned} [\partial \Sigma'] &= ((b - d)m_1 + al_1) + ((a + c)m_2 + bl_2) \\ &\quad + ((b + d)m_3 + cl_3) + ((-a + c)m_4 + dl_4), \\ [\partial \Sigma_3] &= m_2 + l_3 + m_4, \\ [\partial \Sigma_5] &= (m_2 + l_2) + (2m_3 + l_3) + (m_4 + l_4). \end{aligned}$$

For $i = 3$ and 5 , two components of $\partial\Sigma$ and $\partial\Sigma_i$ intersect in at most two points by Proposition 3.1. Hence

$$\begin{aligned} \left| \det \begin{pmatrix} a+c & 1 \\ b & 0 \end{pmatrix} \right| = |b| \leq 2, \quad \left| \det \begin{pmatrix} a+c & 1 \\ b & 1 \end{pmatrix} \right| = |a-b+c| \leq 2, \\ \left| \det \begin{pmatrix} b+d & 0 \\ c & 1 \end{pmatrix} \right| = |b+d| \leq 2, \quad \left| \det \begin{pmatrix} b+d & 2 \\ c & 1 \end{pmatrix} \right| = |b-2c+d| \leq 2, \\ \left| \det \begin{pmatrix} -a+c & 1 \\ d & 0 \end{pmatrix} \right| = |d| \leq 2, \quad \left| \det \begin{pmatrix} -a+c & 1 \\ d & 1 \end{pmatrix} \right| = |a-c+d| \leq 2. \end{aligned}$$

Suppose that $(b-d, a) = (0, 0)$. Then $|b| \leq 1, |b-c| \leq 1$, and n is odd. Since c is odd, we have $(b, c) = \pm(0, 1)$ or $\pm(1, 1)$. If $(a, b, c, d) = \pm(0, 0, 1, 0)$, then Σ is disjoint from Σ_3 . If $(a, b, c, d) = \pm(0, 1, 1, 1)$, then Σ is disjoint from Σ_5 . Since $\text{vol}(M) < 2V_{oct}$, these are impossible by Corollary 3.9.

Suppose that $(b-d, a) \neq (0, 0)$. Then $p/q = (b-d)/a$. By reversing the orientation if necessary, we may assume that $b-d \geq 0$. Then $(b-d)/p$ is odd if and only if n is even. Therefore it is sufficient to consider the cases

$$\begin{aligned} (a, b, c, d) = & (-1, 0, -1, -2), (-1, 2, 1, 0), (1, 2, \pm 1, -2), \\ & (3, 0, -1, -2), (3, 2, 1, 0), (3, 2, \pm 1, -2). \end{aligned}$$

Suppose that $(a, b, c, d) = (-1, 0, -1, -2)$. Then $(a+c, b) = (-2, 0)$, $(b+d, c) = (-2, -1)$, and $(-a+c, d) = (0, -2)$. Hence $\partial\Sigma'$ has at least five components disjoint from the filled cusp. This is impossible. The other cases are also impossible similarly. \square

3.3 The unions with the type (ii)-intersection

In this subsection, we classify the unions of 3-punctured spheres that contain the type (ii)-intersection shown in Proposition 3.1.

Lemma 3.16. *Suppose that two 3-punctured spheres Σ_1 and Σ_2 in a hyperbolic 3-manifold M have the type (ii)-intersection. In other words, we may assume that $\Sigma_1 \cap \Sigma_2$ is separating in Σ_1 and non-separating in Σ_2 . Let X be the component of the union of the 3-punctured spheres in M that contains Σ_1 and Σ_2 . Then X is B_{2n} , Whi_{2n} , Whi'_{4n} , or Bor_6 . (We allow $2n = \infty$.)*

Proof. We consider the two 3-punctured spheres Σ_1 and Σ_2 as shown in Figure 22. Suppose that another 3-punctured sphere Σ intersects Σ_2 . Consider the intersection of Σ and the cusp C . Proposition 3.1 implies that $\Sigma \cap \Sigma_2 \cap C$ consists of at most two points. If $\Sigma \cap \Sigma_2 \cap C = \emptyset$, then $\Sigma \cap \Sigma_2 = g_2$, $\Sigma \cap \Sigma_1 = g_3$, and $\Sigma \cap C = \emptyset$. Otherwise $\Sigma \cap \Sigma_2 = g_4 \cup g_5$ and $\Sigma \cap \Sigma_1 = \emptyset$. In both cases, the ambient 3-manifold M is the Borromean rings complement \mathbb{W}'_2 . Then X is Bor_6 by Lemma 3.11.

Suppose that Σ_2 is disjoint from any other 3-punctured sphere than Σ_1 . If Σ_1 is also disjoint from any other 3-punctured sphere than Σ_2 , then X is B_2 . If Σ_1 intersects another 3-punctured sphere Σ_3 , there is another 3-punctured

sphere Σ_4 that is homologous to Σ_2 and intersects only Σ_3 . We can continue this argument. If 3-punctured spheres lies cyclically, then X is Whi_{2n} or Whi'_{4n} . Otherwise X is B_{2n} . If X consists of infinitely many 3-punctured spheres, then X is B_∞ or Whi_∞ . \square

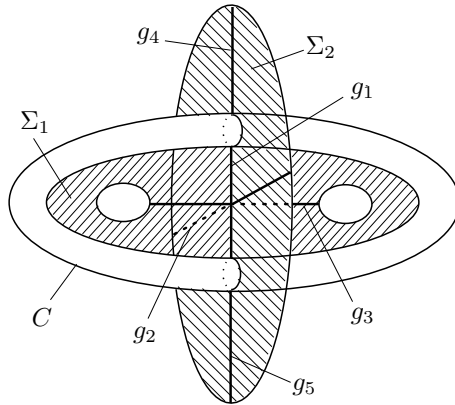

Figure 22: 3-punctured spheres of the type B_2

3.4 The unions without intersection of the type (ii) or (iii)

From now on, we consider a component X of the union of 3-punctured spheres without intersection of the type (ii) or (iii). Let us consider the intersection $L = X \cap C$, where C is a cusp. For the intersection of a 3-punctured sphere and a cusp, we call a component of it a *boundary loop*, which is a closed geodesic in the cusp with respect to the Euclidean metric. Then L is the union of the boundary loops in the cusp C .

Lemma 3.17. *Let X be a component of the union of 3-punctured spheres without intersection of the type (ii) or (iii). Then the intersection of two boundary loops consists of at most one point. Moreover, each boundary loop intersects other boundary loops at most two points.*

Proof. The first assertion follows from the assumption that any pair of 3-punctured spheres in X has the type (i)-intersection. The second assertion follows from the fact that each boundary component of a 3-punctured sphere meets exactly two non-separating simple geodesics. \square

By Lemma 3.17, we may assume that the slope of a boundary loop in L is $0, 1$, or ∞ with respect to a choice of meridian and longitude. We say that the following types of L are general (Figure 23):

- disjoint simple boundary loops,
- two boundary loops with one common point, and

- three boundary loops with two common points, two of which are parallel.

If L is not general, then L contains boundary loops that are one of the three special types shown in Figure 24. Figures 23 and 24 show fundamental domains of the cusp C .

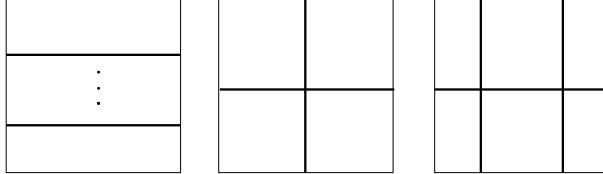

Figure 23: General types of L

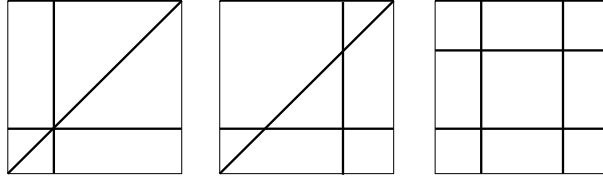

Figure 24: Special types of L

We first consider special types of L .

Lemma 3.18. *Let X and L be as above.*

- If L contains three loops of slopes $0, 1$, and ∞ with common intersection, then X contains T_3 .
- If L contains three loops of slopes $0, 1$, and ∞ without common intersection, then X contains \widehat{Pen}_4 .
- If L contains two pairs of loops of slopes 0 and ∞ , then X contains \widehat{Oct}_4 .

Proof. We obtain the asserted containments by manually combining 3-punctured spheres. In the second case, the union of the three 3-punctured spheres with C has a regular neighborhood that contains another 3-puncture. Moreover, the union of these four 3-punctured spheres is \widehat{Pen}_4 . In the last case, the assertion follows from Lemma 3.19. \square

Lemma 3.19. *Suppose that L contains two pairs of loops of slopes 0 and ∞ . Let $\Sigma_1, \dots, \Sigma_4$ be 3-punctured spheres in X such that $\Sigma_1 \cap C$ and $\Sigma_3 \cap C$ are of slope 0 , and $\Sigma_2 \cap C$ and $\Sigma_4 \cap C$ are of slope ∞ . Then $\Sigma_1 \cap \Sigma_3 = \emptyset$ and $\Sigma_2 \cap \Sigma_4 = \emptyset$.*

Proof. Assume that two 3-punctured spheres Σ_1 and Σ_3 intersect at a geodesic g_5 . There are two cases depending on orientations of geodesics at the intersection as shown in Figure 25.

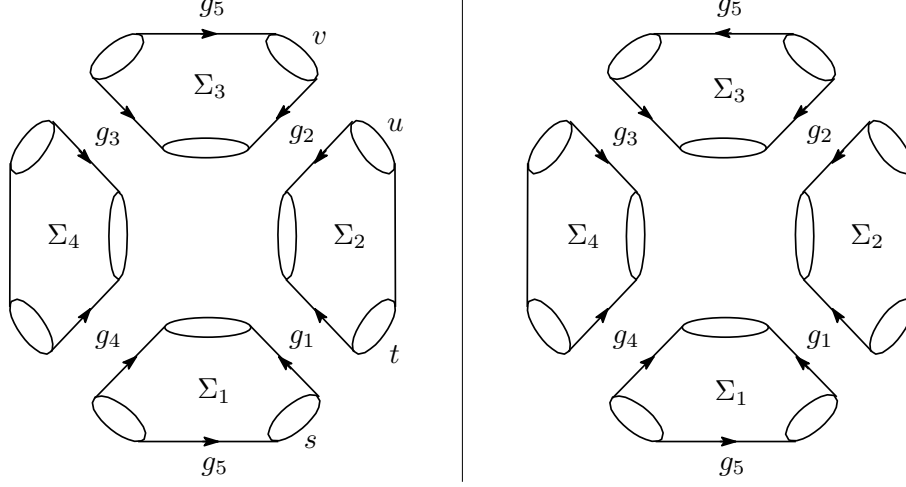

Figure 25: Orientations of geodesics in four 3-punctured spheres

In the left case, four loops s, t, u , and v are contained in a common cusp. Then $s \cap u = \emptyset$ and $t \cap u = \emptyset$, whereas $s \cap t \neq \emptyset$. This is impossible.

In the right case, the union of Σ_1, Σ_2 , and Σ_3 is \widehat{Whi}_3 . Hence the ambient 3-manifold M is obtained by a Dehn filling on a cusp of \mathbb{W}_3 . Then the proof is completed by Lemma 3.20. \square

Lemma 3.20. *Let M be a hyperbolic 3-manifold obtained by a (non-empty) Dehn filling on the cusp C_1 of \mathbb{W}_3 . Suppose that $M \neq \mathbb{M}_3$. Then M has exactly the three 3-punctured spheres of the type \widehat{Whi}_3 .*

Proof. We orient the meridians m_i and the longitudes l_i of the cusps of \mathbb{W}_3 as shown in Figure 26. The 3-punctured spheres $\Sigma_1, \Sigma_2, \Sigma_3$, and Σ_4 respectively represent classes x, y, z , and w that form a basis of $H_2(\mathbb{W}_3, \partial\mathbb{W}_3; \mathbb{R}) \cong \mathbb{R}^4$. Assume that M has another 3-punctured sphere Σ than Σ_2, Σ_3 , or Σ_4 . Then we may assume that Σ is the union of an n -punctured sphere Σ' in \mathbb{W}_3 and $(n - 3)$ essential disks in the filled solid torus. Suppose that Σ' represents $ax + by + cz + dw \in H_2(\mathbb{W}_3, \partial\mathbb{W}_3; \mathbb{R})$ for $a, b, c, d \in \mathbb{Z}$. Then

$$[\partial\Sigma'] = al_1 + ((-c - d)m_2 + bl_2) + ((-b - d)m_3 + cl_3) + ((-b - c)m_4 + dl_4).$$

If $a \neq 0$, then M is obtained by the $(0, 1)$ -Dehn filling, which is not hyperbolic. Hence we have $a = 0$, and $b + c + d$ is odd. Since we exclude \mathbb{M}_3 , two components of $\partial\Sigma$ and $\partial\Sigma_i$ for $i = 2, 3, 4$ intersect in at most one point. Hence we have

$$|b| \leq 1, |c| \leq 1, |d| \leq 1, |c + d| \leq 1, |b + d| \leq 1, |b + c| \leq 1.$$

These inequalities imply that $(b, c, d) = (\pm 1, 0, 0), (0, \pm 1, 0),$ or $(0, 0, \pm 1)$.

Therefore we may assume that Σ is homologous to Σ_2 in M . Lemma 3.10 implies that $\Sigma \cap \Sigma_2 = \emptyset$, but we have $\Sigma \cap \Sigma_3 = \Sigma_2 \cap \Sigma_3$ and $\Sigma \cap \Sigma_4 = \Sigma_2 \cap \Sigma_4$. This is impossible. \square

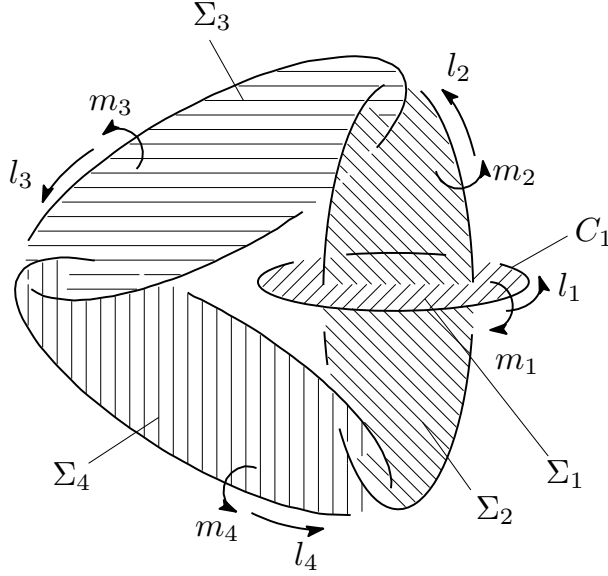

Figure 26: Four 3-punctured spheres in \mathbb{W}_3

Based on Lemma 3.18, we classify the unions X that contain special types of L . We recall that two 3-punctured spheres of X intersect in at most one geodesic.

Lemma 3.21. *Let X be a component of the union of the 3-punctured spheres without intersection of the type (ii) or (iii) in Proposition 3.1.*

- If X contains T_3 , then X is T_3 or Pen_{10} .
- If X contains \widehat{Pen}_4 , then X is \widehat{Pen}_4 or Pen_{10} .
- If X contains \widehat{Oct}_4 , then X is $\widehat{Oct}_4, Oct_8,$ or Pen_{10} .

Proof. We first show that the manifold \mathbb{M}_5 has exactly the ten 3-punctured spheres of Pen_{10} . The intersection of the 3-punctured spheres of Pen_{10} and each cusp consists of six boundary loops of slopes 0, 1, and ∞ . If \mathbb{M}_5 has another 3-punctured sphere, a cusp contains a more boundary loop. This contradicts Lemma 3.17. Therefore \mathbb{M}_5 has no other 3-punctured spheres.

Suppose that X contains T_3 and another 3-punctured sphere. Then the intersection of X and a cusp contains three loops of slopes 0, 1 and ∞ without common intersection. Hence X contains \widehat{Pen}_4 . The ambient 3-manifold is

obtained by a possibly empty Dehn filling on a cusp of \mathbb{M}_5 . Since the ambient 3-manifold contains 3-punctured spheres of T_3 , its volume is at least $\text{vol}(T_3) = \text{vol}(\mathbb{M}_5)$. Therefore the ambient 3-manifold is \mathbb{M}_5 , and X is \widehat{Pen}_{10} .

Suppose that X contains \widehat{Pen}_4 and another 3-punctured sphere. Since X also contains T_3 , the union X is \widehat{Pen}_{10} .

Suppose that X contains \widehat{Oct}_4 . The ambient 3-manifold is obtained by a possibly empty Dehn filling on a cusp of \mathbb{M}_6 . The manifold \mathbb{M}_6 has exactly the eight 3-punctured spheres of the type \widehat{Oct}_8 , for otherwise X contains T_3 and \widehat{Pen}_4 .

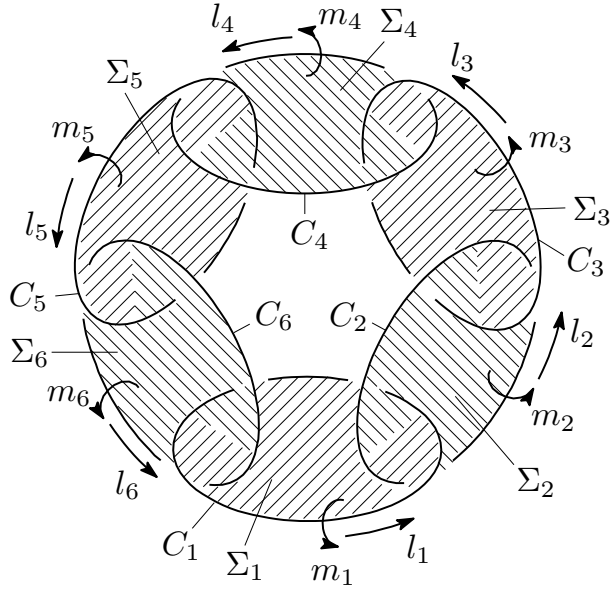

Figure 27: Six 3-punctured spheres in \mathbb{M}_6

Let M be a hyperbolic 3-manifold obtained by a Dehn filling on the cusp C_1 of \mathbb{M}_6 . Assume that M is not \mathbb{M}_5 , and has another 3-punctured sphere Σ than the ones of \widehat{Oct}_4 . We orient the meridians m_i and the longitudes l_i of the cusps of \mathbb{M}_6 as shown in Figure 27. The 3-punctured spheres $\Sigma_1, \dots, \Sigma_6$ respectively represent classes x_1, \dots, x_6 that form a basis of $H_2(\mathbb{M}_6, \partial\mathbb{M}_6; \mathbb{R}) \cong \mathbb{R}^6$. We may assume that Σ is the union of an n -punctured sphere Σ' in \mathbb{M}_6 and $(n-3)$ essential disks in the filled solid torus. Suppose that Σ' represents $a_1x_1 + \dots + a_6x_6 \in H_2(\mathbb{M}_6, \partial\mathbb{M}_6; \mathbb{R})$ for $a_1, \dots, a_6 \in \mathbb{Z}$. Then

$$[\partial\Sigma'] = ((-a_6 + a_2)m_1 + a_1l_1) + ((a_1 - a_3)m_2 + a_2l_2) + ((-a_2 + a_4)m_3 + a_3l_3) \\ + ((a_3 - a_5)m_4 + a_4l_4) + ((-a_4 + a_6)m_5 + a_5l_5) + ((a_5 - a_1)m_6 + a_6l_6).$$

The 3-punctured sphere Σ is disjoint from the cusp C_4 , for otherwise X is \widehat{Pen}_{10} . By the same reason, each $\Sigma \cap C_i$ for $i = 2, 3, 5, 6$ is a multiple of m_i or l_i . Since

Σ is a 3-punctured sphere, we have

$$|a_1 - a_3| + |a_2| + |-a_2 + a_4| + |a_3| + |-a_4 + a_6| + |a_5| + |a_5 - a_1| + |a_6| = 1 \text{ or } 3.$$

However,

$$(a_1 - a_3) + a_2 + (-a_2 + a_4) + a_3 + (-a_4 + a_6) + a_5 + (a_5 - a_1) + a_6 = 2(a_5 + a_6)$$

is even. This is impossible. \square

Thus we have classified the unions that contain special boundary loops. In the remaining cases, the intersection L is general (Figure 23). Note that if L consists three boundary loops with two common points, the two parallel loops in L are contained in distinct 3-punctured spheres.

Lemma 3.22. *Suppose that the intersection of X and any cusp is general. If X contains 3-punctured sphere Σ that intersects three other 3-punctured spheres, then X is T_4 .*

Proof. Clearly X contains T_4 . Let C_1, C_2 , and C_3 denote the cusps meeting the 3-punctured sphere Σ . Assume that there is another 3-punctured sphere Σ than the ones of T_4 . Then Σ intersects at least one of the three cusps C_1, C_2 , and C_3 . This contradicts the assumption that the intersection of X and a cusp is general. \square

In the last remaining cases, the 3-punctured spheres in X are placed linearly or cyclically. Suppose that X consists of finitely many 3-punctured spheres. If the 3-punctured spheres in X are placed linearly, then X is A_n . If the 3-punctured spheres in X are placed cyclically, then X is \widehat{Whi}_n or \widehat{Whi}'_{2n} .

Thus we complete the proof of Theorem 1.2.

4 Volume and number of 3-punctured spheres

As an application of Theorem 1.2, we estimate the number of 3-punctured spheres in a hyperbolic 3-manifold by its volume. We recall that if a hyperbolic 3-manifold M contains n disjoint 3-punctured spheres, then $\text{vol}(M) \geq nV_{oct}$ by Corollary 3.9.

Theorem 4.1. *Suppose that an orientable hyperbolic 3-manifold M has k 3-punctured spheres. Then $k \leq 4\text{vol}(M)/V_{oct}$. The equality holds if and only if M is the manifold \mathbb{M}_4 .*

Proof. We first consider the special cases. Let $V_{oct} = 3.6638\dots$ be the volume of a regular ideal octahedron, and let $V_3 = 1.0149\dots$ be the volume of a regular ideal tetrahedron. The assertion for the special manifolds is obtained from the following inequalities:

- $\text{vol}(\mathbb{W}_n) = \text{vol}(\mathbb{W}'_n) = nV_{oct} > \frac{n}{2}V_{oct}$ for Whi_{2n} and Whi'_{4n} ,

- $\text{vol}(\mathbb{W}'_2) = 2V_{oct} > \frac{3}{2}V_{oct}$ for Bor_6 ,
- $\text{vol}(\mathbb{M}_3) = 5.3334\dots > V_{oct}$ for Mag_4 ,
- $\text{vol}(\mathbb{M}_4) = 2V_{oct}$ for Tet_8 ,
- $\text{vol}(\mathbb{M}_5) = 10V_3 > \frac{5}{2}V_{oct}$ for Pen_{10} ,
- $\text{vol}(\mathbb{M}_6) = 4V_{oct} > 2V_{oct}$ for Oct_8 .

Since a hyperbolic 3-manifold with 3-punctured spheres of the type \widehat{Whi}_n contains $\lfloor n/2 \rfloor$ disjoint 3-punctured spheres, its volume is at least $\lfloor n/2 \rfloor V_{oct}$. The same argument holds for \widehat{Whi}'_{2n} . For \widehat{Tet}_2 , the volume of a hyperbolic 3-manifold obtained by a Dehn filling on a cusp of \mathbb{M}_4 is at least V_{oct} , since the manifold contains a 3-punctured sphere. For \widehat{Pen}_4 and \widehat{Oct}_4 , the volume of a hyperbolic 3-manifold obtained by a Dehn filling on a cusp of \mathbb{M}_5 or \mathbb{M}_6 is at least $2V_{oct}$. Indeed, such a manifold has at least 4 cusps, and \mathbb{M}_4 has the smallest volume of the orientable hyperbolic 3-manifolds with at least 4 cusps [32]. Thus we have shown the assertion for the special cases.

We consider the general cases. Suppose that the union of the 3-punctured spheres of an orientable hyperbolic 3-manifold M consists of the types A_n, B_{2n}, T_3 , and T_4 . Let a_n, b_{2n}, t_3 , and t_4 denote the number of the corresponding components. At least one of a_n, b_{2n}, t_3 , and t_4 is positive. Then M contains $\sum_n (\lfloor (n+1)/2 \rfloor a_n + nb_{2n}) + t_3 + 3t_4$ disjoint 3-punctured spheres. Hence $\text{vol}(M) \geq (\sum_n (\lfloor (n+1)/2 \rfloor a_n + nb_{2n}) + t_3 + 3t_4) V_{oct}$. The assertion follows from the inequality

$$\sum_n (\lfloor \frac{n+1}{2} \rfloor a_n + nb_{2n}) + t_3 + 3t_4 > \frac{1}{4} \left(\sum_n (na_n + 2nb_{2n}) + 3t_3 + 4t_4 \right),$$

which is easily checked by comparing the coefficients termwise. \square

5 Bound of modulus for A_n

Neighborhoods of 3-punctured spheres of the types B_{2n}, T_3 , and T_4 are isometrically determined as the manifolds $\mathbb{B}_{n+1}, \mathbb{T}_3$, and \mathbb{T}_4 . The metric of a neighborhood of 3-punctured spheres of the type A_n for $n \geq 2$, however, depends on the ambient hyperbolic 3-manifold. Let us consider 3-punctured spheres $\Sigma_1, \dots, \Sigma_n$ of the type A_n . There are n cusps each of which intersects two or three of $\Sigma_1, \dots, \Sigma_n$ at loops of two slopes. We will call them the *adjacent torus cusps* for $\Sigma_1, \dots, \Sigma_n$. We define the meridians and longitudes of the adjacent torus cusps as the intersection of the cusps and the 3-punctured spheres, so that each 3-punctured sphere meets exactly one longitude. Then the meridians and the longitudes are uniquely determined if $n \geq 3$. For A_2 , however, there is ambiguity to permute the meridian and longitude. In this case we take them arbitrarily.

The Euclidean structure of such an adjacent cusp determines its modulus τ with respect to the meridian and longitude. Then the cusp is isometric to the quotient of \mathbb{C} under the additive action of $\{m + n\tau \in \mathbb{C} | m, n \in \mathbb{Z}\}$, where 1 and τ respectively correspond to the meridian and longitude. We may assume that $\text{Im}(\tau) > 0$ by taking an appropriate orientation. We first show that the moduli of such adjacent cusps coincide.

Proposition 5.1. *Suppose that an orientable hyperbolic 3-manifold M contains two 3-punctured spheres Σ_1 and Σ_2 of the type A_2 . Let τ and τ' denote the moduli of the two adjacent cusps C_1 and C_2 . Then $\tau = \tau'$.*

Proof. Let $x, y, z, w \in \pi_1(M)$ be represented by the loops shown in Figure 28. The base point is taken in $\Sigma_1 \cap \Sigma_2$. The meridians correspond to y and z , and the longitudes correspond to x and w . Regard $\pi_1(M)$ as a subgroup of $\text{PSL}(2, \mathbb{C}) \cong \text{Isom}^+(\mathbb{H}^3)$. Since x and y are parabolic elements with distinct fixed points in $\partial\mathbb{H}^3$, we may assume that

$$x = \begin{pmatrix} 1 & 2 \\ 0 & 1 \end{pmatrix} \quad \text{and} \quad y = \begin{pmatrix} 1 & 0 \\ c & 1 \end{pmatrix}$$

by taking conjugates. Then $xy^{-1} = \begin{pmatrix} 1 - 2c & 2 \\ -c & 1 \end{pmatrix}$ is also parabolic. Hence $|\text{tr}(xy^{-1})| = |2 - 2c| = 2$. Since y is not the identity, we have $c = 2$.

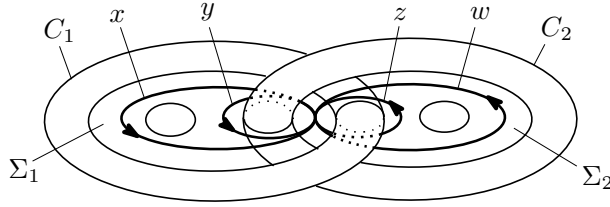

Figure 28: Generators of $\pi_1(\Sigma_1)$ and $\pi_1(\Sigma_2)$

The moduli τ and τ' give the representations

$$z = \begin{pmatrix} 1 & 2/\tau \\ 0 & 1 \end{pmatrix} \quad \text{and} \quad w = \begin{pmatrix} 1 & 0 \\ 2\tau' & 1 \end{pmatrix}.$$

Then $zw^{-1} = \begin{pmatrix} 1 - 4(\tau'/\tau) & 2/\tau \\ -2\tau' & 1 \end{pmatrix}$ is also parabolic. Hence $|\text{tr}(zw^{-1})| = |2 - 4(\tau'/\tau)| = 2$. Since $\tau' \neq 0$, we have $\tau = \tau'$. \square

Therefore the metric of a neighbourhood of 3-puncture spheres of the type A_n ($n \geq 2$) is determined by the single modulus τ . In particular, the angle at the intersection is equal to $\arg \tau$.

Let \mathcal{C}_n denote the set of the moduli for 3-punctured spheres of the type A_n contained in (possibly infinite volume) orientable hyperbolic 3-manifolds. We first give a bound for \mathcal{C}_n by using the Shimizu-Leutbecher lemma.

Lemma 5.2 (the Shimizu-Leutbecher lemma [29]). *Suppose that a group generated by two elements*

$$\begin{pmatrix} 1 & 1 \\ 0 & 1 \end{pmatrix}, \begin{pmatrix} a & b \\ c & d \end{pmatrix} \in \mathrm{PSL}(2, \mathbb{C})$$

is discrete. Then $c = 0$ or $|c| \geq 1$.

Proposition 5.3. *Let $\tau \in \mathcal{C}_2$. Then*

$$|m\tau + n| \geq \frac{1}{4} \quad \text{and} \quad \left| \frac{m}{\tau} + n \right| \geq \frac{1}{4}$$

for any $(m, n) \in \mathbb{Z} \times \mathbb{Z} \setminus \{(0, 0)\}$. In particular,

$$\frac{1}{4} \leq |\tau| \leq 4 \quad \text{and} \quad 0.079 < \arg \tau < \pi - 0.079.$$

Proof. Let $x, y, z, w \in \pi_1(M)$ be as in the proof of Proposition 5.1. By taking conjugates for the Shimizu-Leutbecher lemma, we have if $x = \begin{pmatrix} 1 & 2 \\ 0 & 1 \end{pmatrix}$ and $\begin{pmatrix} a & b \\ c & d \end{pmatrix}$ generate a discrete subgroup of $\mathrm{PSL}(2, \mathbb{C})$, then $c = 0$ or $|c| \geq 1/2$. Now considering $y^n w^m = \begin{pmatrix} 1 & 0 \\ 2m\tau + 2n & 1 \end{pmatrix}$, we obtain $|m\tau + n| \geq 1/4$. Similarly, since $y = \begin{pmatrix} 1 & 0 \\ 2 & 1 \end{pmatrix}$ and $x^n z^m = \begin{pmatrix} 1 & 2(m/\tau) + 2n \\ 0 & 1 \end{pmatrix}$ generate a discrete subgroup, we have $|(m/\tau) + n| \geq 1/4$.

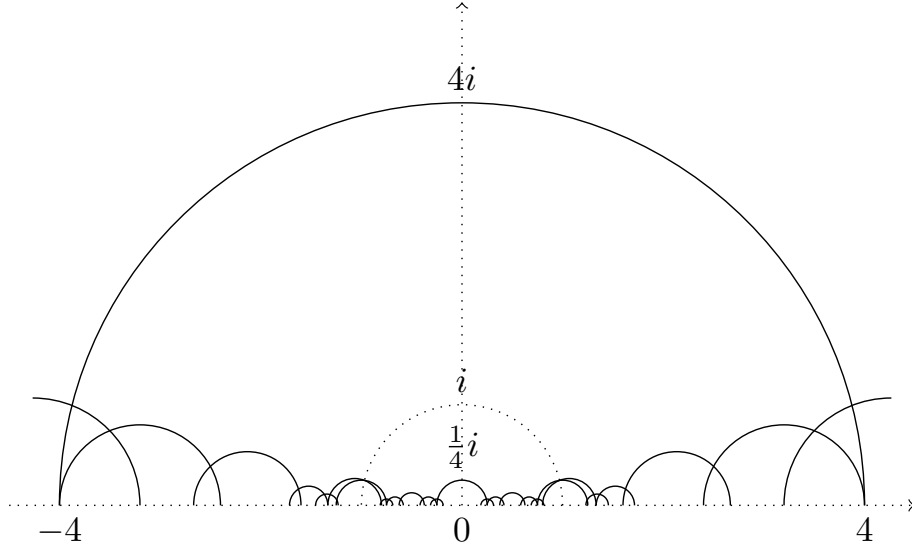

Figure 29: A bound for the modulus τ

In fact, these conditions are equivalent to the inequalities for

$$(m, n) = (1, 0), (4, \pm 1), (3, \pm 1), (2, \pm 1), (3, \pm 2), (4, \pm 3), (1, \pm 1).$$

Indeed, for large (m, n) , the equalities $|m\tau + n| = 1/4$ and $|(m/\tau) + n| = 1/4$ give small circles in \mathbb{C} . The above inequalities define the region bounded by 26 arcs as shown in Figure 29. This region is symmetric about the imaginary axis and invariant under the inversion with respect to the unit circle. We recall that $\text{Im}(\tau) > 0$. The inequalities for $(m, n) = (1, 0)$ imply that $\frac{1}{4} \leq |\tau| \leq 4$. A point of minimal slope of τ in the first quadrant satisfying these inequalities is $(93 + \sqrt{55}i)/128$, which is contained in the intersection of two circles given by $|3\tau - 2| = 1/4$ and $|4\tau - 3| = 1/4$. Therefore $\arg \tau \geq \arctan(\sqrt{55}/93) > 0.079$. \square

For the 3-punctured spheres $\Sigma_1, \dots, \Sigma_n$ of the type A_n , let M_n be a regular neighborhood of the union of $\Sigma_1 \cup \dots \cup \Sigma_n$ with the n adjacent torus cusps. The frontier $\partial_0 M_n$ is a 4-punctured sphere. For $\tau \in \mathbb{C} \setminus \{0\}$, we define a representation $\rho_\tau: \pi_1(M_n) \rightarrow \text{PSL}(2, \mathbb{C})$ whose restriction to $\pi_1(\Sigma_i \cup \Sigma_{i+1})$ for each $1 \leq i \leq n-1$ is conjugate to the one in the proof of Proposition 5.1. The parameter space $\mathbb{C} \setminus \{0\}$ can be regarded as the character variety for M_n . We regard \mathcal{C}_n as a subspace of $\mathbb{C} \setminus \{0\}$. If $\tau \in \mathcal{C}_n$, then ρ_τ is the holonomy representation for M_n with the cusp modulus τ . The image of ρ_τ is discrete if and only if τ or $\bar{\tau} \in \mathcal{C}_n$.

Jørgensen's inequality [18] implies that if representations of a group to $\text{PSL}(2, \mathbb{C})$ have discrete images, their algebraic limits is elementary or has a discrete image. Hence \mathcal{C}_n is closed in $\mathbb{C} \setminus \{0\}$. We divide \mathcal{C}_n into two subsets $\mathcal{C}_n^{\text{incomp}} = \{\tau \in \mathcal{C}_n \mid \rho_\tau \text{ is injective}\}$ and $\mathcal{C}_n^{\text{comp}} = \{\tau \in \mathcal{C}_n \mid \rho_\tau \text{ is not injective}\}$.

Theorem 5.4. *The set $\mathcal{C}_n^{\text{incomp}}$ is homeomorphic to a closed disk.*

Theorem 5.4 is due to Minsky [26]. Although in that paper he mainly considered once-punctured torus groups, he noted that the same argument holds for hyperbolic 3-manifolds with boundary consisting of 4-punctured spheres. This homeomorphism is described as follows. Let $\mathcal{T}_{0,4}$ denote the Teichmüller space of a 4-punctured sphere. Its Thurston compactification $\overline{\mathcal{T}_{0,4}}$ is homeomorphic to a closed disk. The set $\mathcal{C}_n^{\text{incomp}}$ is the image of a continuous map $\iota: \overline{\mathcal{T}_{0,4}} \rightarrow \mathbb{C} \setminus \{0\}$. The Thurston boundary $\partial\mathcal{T}_{0,4} = \overline{\mathcal{T}_{0,4}} - \mathcal{T}_{0,4}$ can be identified with $\mathbb{R} \cup \{\infty\}$. A rational point of $\partial\mathcal{T}_{0,4}$ corresponds to the homotopy class of an essential simple closed curve on the 4-punctured sphere. Here we conventionally regard ∞ as a rational point. A parameter $\tau \in \mathcal{C}_n^{\text{incomp}}$ determines a hyperbolic structure of M_n as $\mathbb{H}^3/\rho_\tau(\pi_1(M_n))$. If $\tau \in \text{int}(\mathcal{C}_n^{\text{incomp}})$, then the hyperbolic structure is geometrically finite, and the conformal structure on the infinite end $\partial_0 M_n$ is given by $\iota^{-1}(\tau) \in \mathcal{T}_{0,4}$. If $\iota^{-1}(\tau)$ is a rational point of $\partial\mathcal{T}_{0,4}$, there is an annular cusp of the corresponding slope on $\partial_0 M_n$. On the other hand, if $\iota^{-1}(\tau)$ is an irrational point of $\partial\mathcal{T}_{0,4}$, then $\mathbb{H}^3/\rho_\tau(\pi_1(M_n))$ is geometrically infinite.

Theorem 5.5. *The set $\mathcal{C}_n^{\text{comp}}$ is a countably infinite set.*

If $\tau \in \mathcal{C}_n^{\text{comp}}$, the manifold $\mathbb{H}^3/\rho_\tau(\pi_1(M_n))$ is the complement of a Montesinos link. We prepare the notion of Montesinos links.

Let $B^3 = \{(x, y, z) \in \mathbb{R}^3 \mid x^2 + y^2 + z^2 \leq 1\}$. Consider the natural projection of B^3 into the xy -plane. A 2-tangle is two arcs properly embedded in B^3 whose endpoints are $\{(\pm 1/\sqrt{2}, \pm 1/\sqrt{2}, 0)\}$. The equivalence of 2-tangles is given by isotopy fixing the endpoints of the arcs. A trivial tangle is a 2-tangle that is injected by the projection. The homotopy class of a (non-oriented) essential closed curve in the 4-punctured sphere $\partial_0 B^3 = \partial B^3 - \{(\pm 1/\sqrt{2}, \pm 1/\sqrt{2}, 0)\}$ is determined by a slope $r \in \mathbb{Q} \cup \{\infty\}$. Here the slope $r = p/q$ for coprime integers p and q is defined so that the homology class of the loop is $\pm(pm + ql)$, where $m, l \in H_1(\partial_0 B^3, \mathbb{Z})$ are respectively represented by the loops $\theta \in [0, 2\pi] \mapsto (\sin \theta, 0, \cos \theta), (0, \sin \theta, \cos \theta)$. A 2-tangle homeomorphic to a trivial tangle is determined up to isotopy by $r \in \mathbb{Q} \cup \{\infty\}$, where the compressing disk for $\partial_0 B^3$ in the complement has the boundary of slope r . This tangle is called a rational tangle of slope r .

For $r_1, \dots, r_n \in \mathbb{Q} \cup \{\infty\}$, the Montesinos link $L(r_1, \dots, r_n)$ is defined by composing rational tangles of slopes r_1, \dots, r_n as shown in Figure 30. We consider that the diagram is drawn in the xy -plane, which determines the slopes of tangles.

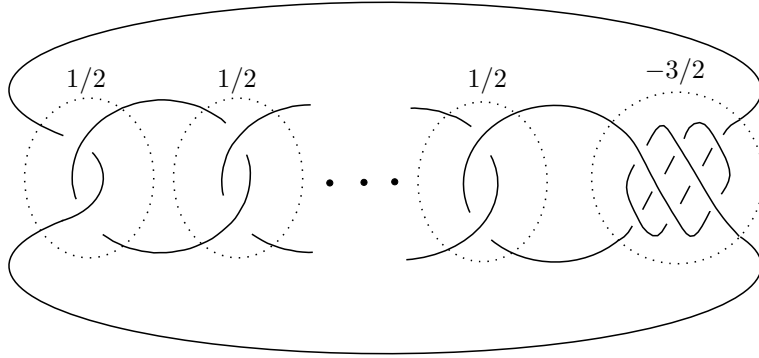

Figure 30: The Montesinos link $L(1/2, 1/2, \dots, 1/2, -3/2)$

Proof of Theorem 5.5. Let $\tau \in \mathcal{C}_n^{\text{comp}}$. Equip M_n with the metric for the cusp modulus τ . Then $\partial_0 M_n$ is compressible. By taking a regular neighborhood of the union of M_n with the compressing disk, we obtain that the ambient hyperbolic 3-manifold $\mathbb{H}^3/\rho_\tau(\pi_1(M_n))$ is the union of M_n with the complement of a trivial tangle. Hence the manifold $\mathbb{H}^3/\rho_\tau(\pi_1(M_n))$ is the complement of a Montesinos link $L(1/2, \dots, 1/2, r)$, where the number of tangles of slope $1/2$ is $n + 1$. The set $\mathcal{C}_n^{\text{comp}}$ corresponds to the set of slopes r such that $L(1/2, \dots, 1/2, r)$ are hyperbolic links.

The classification of Montesinos links by Bonahon and Siebenmann [6] implies that all these links but the following exceptions are hyperbolic (see also [13, Section 3.3]).

- For $n = 2$, the four slopes $r = -2, -3/2, -1, \infty$ are excluded.
- For $n = 3$, the two slopes $r = -2, \infty$ are excluded.
- For $n \geq 4$, the slope $r = \infty$ is excluded.

□

Remark 5.6. If an annular cusp of an excluded slope is added to M_n , we obtain one of the manifolds $\mathbb{B}_{n+1}, \mathbb{T}_3$, and \mathbb{T}_4 . If the union of a 3-punctured sphere with the compressing disk is an annulus, the filled manifold is not hyperbolic.

Let us consider the subset $\mathcal{C}_n^{\text{fin}}$ of \mathcal{C}_n consisting of the moduli that appears in a finite volume hyperbolic 3-manifold. Note that $\mathcal{C}_n^{\text{comp}} \subset \mathcal{C}_n^{\text{fin}}$. By Theorem 5.7, the restriction about finite volume does not give serious difference on bounds.

Theorem 5.7 (Brooks [8]). *Let $\Gamma < \text{PSL}(2, \mathbb{C})$ be a geometrically finite Kleinian group. Then there exist arbitrarily small quasi-conformal deformations Γ_ϵ of Γ , such that Γ_ϵ is contained in the fundamental group of a finite volume hyperbolic 3-manifold.*

We apply Theorem 5.7 to $\Gamma = \rho_\tau(\pi_1(M_n))$.

Corollary 5.8. *The set $\mathcal{C}_n^{\text{fin}}$ is dense in \mathcal{C}_n .*

Proposition 5.9. *If 3-punctured spheres of the type A_n are contained in the ones of the type B_{2n} , the adjacent cusp modulus τ is equal to $2i$. In particular, $2i \in \partial\mathcal{C}_n^{\text{incomp}}$ for any $n \geq 2$.*

Proof. The 3-punctured spheres of the type B_{2n} are contained in the manifold \mathbb{B}_{n+1} , which is decomposed into $n + 1$ regular ideal octahedra. This is obtained from the decomposition of \mathbb{B}_1 into a regular ideal octahedron shown in Figure 10. We can construct a fundamental domain of each adjacent cusp by two Euclidean unit squares. Then the lengths of the meridian and longitude are respectively equal to 1 and 2. Hence the modulus τ is equal to $2i$.

We have another proof by computing the representation. We use the elements

$$y = \begin{pmatrix} 1 & 0 \\ 2 & 1 \end{pmatrix} \quad \text{and} \quad z = \begin{pmatrix} 1 & 2\tau^{-1} \\ 0 & 1 \end{pmatrix}$$

shown in Figure 28. Suppose that y and z represents meridians. If 3-punctured spheres of the type A_2 are contained in the ones of the type B_4 , the element

$$yzy^{-1}z^{-1} = \begin{pmatrix} 1 - 4\tau^{-1} & 8\tau^{-2} \\ -8\tau^{-1} & 1 + 4\tau^{-1} + 16\tau^{-2} \end{pmatrix}$$

is parabolic. Hence $|\text{tr}(yzy^{-1}z^{-1})| = |2 + 16\tau^{-2}| = 2$. Since $\text{Im}(\tau) > 0$, we have $\tau = 2i$. □

Proposition 5.10. *It holds that*

$$\mathcal{C}_{n+1} \subset \mathcal{C}_n, \quad \mathcal{C}_{n+1}^{\text{incomp}} \subset \mathcal{C}_n^{\text{incomp}}, \quad \text{and} \quad \mathcal{C}_{n+2} \subset \mathcal{C}_n^{\text{incomp}}.$$

Proof. The first two containments are obvious. If $\tau \in \mathcal{C}_n^{\text{comp}}$, the number of the cusps of the ambient hyperbolic 3-manifold is $n + 1$ or $n + 2$ by the proof of Theorem 5.5. Then $\tau \notin \mathcal{C}_{n+2}$. Therefore we have $\mathcal{C}_{n+2} \subset \mathcal{C}_n^{\text{incomp}}$. \square

The sets \mathcal{C}_n become arbitrarily smaller as n increases.

Theorem 5.11. *For $n \geq 2$, let $\tau_n \in \mathcal{C}_n$. Then $\lim_{n \rightarrow \infty} \tau_n = 2i$.*

By Corollary 5.8, we may assume that $\tau_n \in \mathcal{C}_n^{\text{fin}}$. Theorem 5.11 follows from Theorem 5.12 and Lemma 5.13. Theorem 5.12 states that a Dehn filling along a long slope gives a manifold with metric uniformly close to the original one in their thick parts. Here we use the normalized length of a slope, i.e. it is measured after rescaling the metric on the torus cusp to have unit area. We recall that $M_{[\epsilon, \infty)}$ is the ϵ -thick part of a hyperbolic 3-manifold M . It is crucial that the estimates in Theorem 5.12 do not depend on manifolds.

Theorem 5.12. *For any $J > 1$, there is a constant $K \geq 4\sqrt{2}\pi$ satisfying the following condition. Suppose that M is obtained by a Dehn filling on a cusp of a finite volume hyperbolic 3-manifold M_0 along a slope of normalized length L at least K . Then*

- (i) *the filled core loop (i.e. the core loop in the filled solid torus of the Dehn filling) is isotopic in M to a closed geodesic of length $\leq 2\pi/(L^2 - 16\pi^2)$, and*
- (ii) *there is a J -bilipschitz diffeomorphism $\varphi: (M_0)_{[\epsilon, \infty)} \rightarrow M_{[\epsilon, \infty)}$ isotopic to the restriction of the natural inclusion $M_0 \hookrightarrow M$.*

The part (i) follows from the work of Hodgson and Kerckhoff [17]. The part (ii) follows from the drilling theorem due to Brock and Bromberg [7], which requires that the filled core loop is short. Magid [24, Section 4] unified their arguments and gave the explicit bound in (i).

Lemma 5.13. *Suppose that an orientable finite volume hyperbolic 3-manifold M contains 3-punctured spheres $\Sigma_1, \dots, \Sigma_n$ of the type A_n . Then there is a finite volume hyperbolic 3-manifold M_0 satisfying the following properties:*

- *The manifold M is obtained by a Dehn filling on a cusp of M_0 along a slope of normalized length at least $\sqrt{n+1}/2$.*
- *The 3-punctured spheres $\Sigma_1, \dots, \Sigma_n$ come from ones contained in 3-punctured spheres of the type B_{2n} in M_0 .*

Proof. Let γ be a loop in M such that γ and two meridians of an adjacent cusp bound a 2-punctured disk Σ as shown in Figure 31. Let $N(\gamma)$ be an open regular neighborhood of γ . Assume that $M \setminus N(\gamma)$ contains an essential sphere S . Since M is irreducible, the sphere S bounds a ball in M . Note that the cusps of M are incompressible. We apply the standard argument to reduce the intersection of surfaces in a 3-manifold by considering innermost intersection. Then by

isotoping S in $M \setminus N(\gamma)$, we may assume that S is disjoint from $\Sigma_1, \dots, \Sigma_n$, and $S \cap \Sigma$ consists of (possibly empty) loops parallel to γ . If $S \cap \Sigma = \emptyset$, then S bounds a ball in $M \setminus N(\gamma)$. Otherwise γ bounds a disk D in M such that $\Sigma \cap D = \gamma$. Then $\Sigma \cup D$ is an essential annulus, which contradicts the fact that M is hyperbolic. Hence $M \setminus N(\gamma)$ is irreducible.

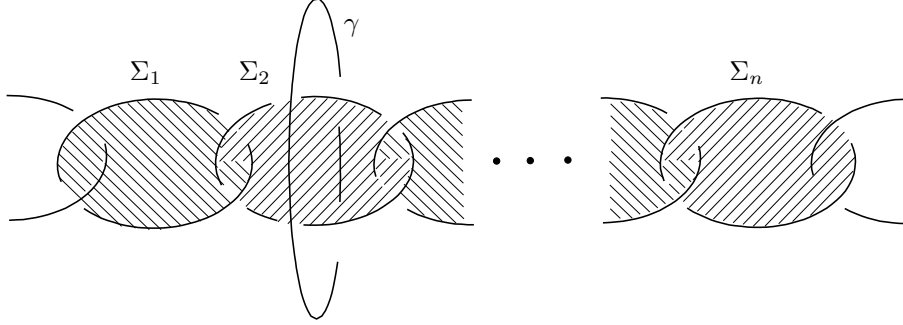

Figure 31: A drilled loop γ in M

If $M \setminus N(\gamma)$ is hyperbolic, then it is sufficient to let $M_0 = M \setminus N(\gamma)$. Suppose that $M \setminus N(\gamma)$ is not hyperbolic. Since M is hyperbolic, $M \setminus N(\gamma)$ is not a graph 3-manifold. Hence there are non-empty family of essential disjoint tori T_1, \dots, T_m for the JSJ decomposition of $M \setminus N(\gamma)$. Then we may assume that $T_i \cap \Sigma_j = \emptyset$. After the JSJ decomposition of $M \setminus N(\gamma)$ along T_1, \dots, T_m , there is a piece M_0 such that $\Sigma_1 \cup \dots \cup \Sigma_n \subset M_0$. We may assume that the frontier of M_0 is T_1, \dots, T_k . Since M is hyperbolic, each T_i for $1 \leq i \leq k$ is compressible in M . Hence the manifold M is obtained by a Dehn filling of M_0 along T_1, \dots, T_k . Since γ is contained in a single solid torus for this Dehn filling, we have $k = 1$. We can take T_1 by isotopy so that $\Sigma \cap M_0$ is a 3-punctured sphere in M_0 . Hence M_0 contains 3-punctured spheres of the type B_{2n} . Moreover, the piece M_0 is hyperbolic.

The manifold M_0 can be decomposed along two 3-punctured spheres into the manifold \mathbb{B}_{n+1} and a (possibly empty) manifold M'_0 . We consider the cusp C of M_0 on which we perform a Dehn filling. Let a meridian of C be homotopic to γ in M . Then the outer boundary component of a blue 3-punctured sphere of \mathbb{B}_{n+1} in Figure 3 is a meridian. We can construct a fundamental domain of the annular cusp $C' = C \cap \mathbb{B}_{n+1}$ by $4(n+1)$ Euclidean unit squares. This is obtained from the decomposition of \mathbb{B}_1 into a regular ideal octahedron shown in Figure 10. By adding a fundamental domain F of $C \setminus C'$, we obtain a fundamental domain of C as shown in Figure 32. Let $r \geq 0$ denote the height of F with respect to the meridian as the base of F . Note that M_0 is \mathbb{W}_{n+1} or \mathbb{W}'_{n+1} if $r = 0$. When we normalize C to have unit area, the length of the meridian is $2/\sqrt{n+1+r}$. Since M is hyperbolic, the slope of the Dehn filling of M_0 is not the meridian. Hence the length of this slope is at least $\sqrt{n+1+r}/2$. \square

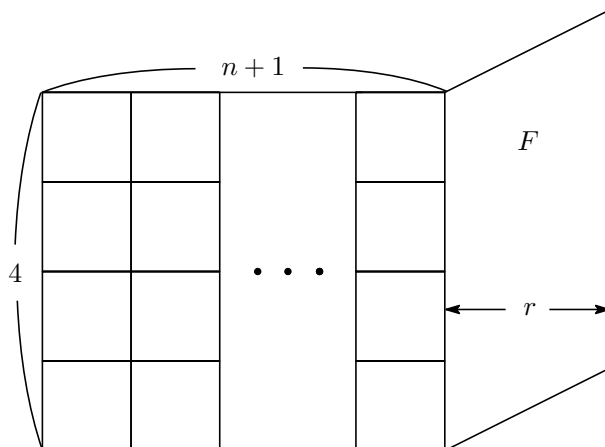

Figure 32: A fundamental domain of the cusp C

We finally complete the classification for infinitely many 3-punctured spheres.

Proof of Theorem 1.3. If infinitely many intersecting 3-punctured spheres are placed linearly, the adjacent cusp modulus is equal to $2i$ by Theorem 5.11. Then there is a cusp that bounds additional 3-punctured spheres. Hence the union of the 3-punctured spheres is B_∞ or Whi_∞ . The argument in Section 3 implies that there is no other type of the union. \square

Acknowledgements

The author would like to thank Hidetoshi Masai for his several helpful comments. This work was supported by JSPS KAKENHI Grant Numbers 24224002, 15H05739.

References

- [1] C. C. ADAMS, *Thrice-punctured spheres in hyperbolic 3-manifolds*, Trans. Amer. Math. Soc., 287 (1985), pp. 645–656.
- [2] C. C. ADAMS AND W. SHERMAN, *Minimum ideal triangulations of hyperbolic 3-manifolds*, Discrete Comput. Geom., 6 (1991), pp. 135–153.
- [3] I. AGOL, *Pants immersed in hyperbolic 3-manifolds*, Pacific J. Math., 241 (2009), pp. 201–214.
- [4] ———, *The minimal volume orientable hyperbolic 2-cusped 3-manifolds*, Proc. Amer. Math. Soc., 138 (2010), pp. 3723–3732.

- [5] M. D. BAKER, *All links are sublinks of arithmetic links*, Pacific J. Math., 203 (2002), pp. 257–263.
- [6] F. BONAHOE AND L. C. SIEBENMANN, *New geometric splittings of classical knots and the classification and symmetries of arborescent knots*, preprint, (1979–2010). available at <http://www-bcf.usc.edu/~fbonahon>.
- [7] J. F. BROCK AND K. W. BROMBERG, *On the density of geometrically finite Kleinian groups*, Acta Math., 192 (2004), pp. 33–93.
- [8] R. BROOKS, *Circle packings and co-compact extensions of Kleinian groups*, Invent. Math., 86 (1986), pp. 461–469.
- [9] P. J. CALLAHAN, M. V. HILDEBRAND, AND J. R. WEEKS, *A census of cusped hyperbolic 3-manifolds*, Math. Comp., 68 (1999), pp. 321–332.
- [10] N. M. DUNFIELD AND W. P. THURSTON, *The virtual Haken conjecture: Experiments and examples*, Geom. Topol., 7 (2003), pp. 399–441.
- [11] D. B. A. EPSTEIN AND R. C. PENNER, *Euclidean decompositions of non-compact hyperbolic manifolds*, J. Differential Geom., 27 (1988), pp. 67–80.
- [12] M. EUDAVE-MUÑOZ AND M. OZAWA, *Characterization of 3-punctured spheres in non-hyperbolic link exteriors*, Topology Appl., 264 (2019), pp. 300–312.
- [13] D. FUTER AND F. GUÉRITAUD, *Angled decompositions of arborescent link complements*, Proc. Lond. Math. Soc. (3), 98 (2009), pp. 325–364.
- [14] M. GOERNER, *A census of hyperbolic Platonic manifolds and augmented knotted trivalent graphs*, New York J. Math, 23 (2017), pp. 527–553.
- [15] C. M. GORDON AND Y.-Q. WU, *Toroidal and annular Dehn fillings*, Proc. Lond. Math. Soc. (3), 78 (1999), pp. 662–700.
- [16] A. HATCHER, *Hyperbolic structures of arithmetic type on some link complements*, J. Lond. Math. Soc. (2), 27 (1983), pp. 345–355.
- [17] C. D. HODGSON AND S. P. KERCKHOFF, *Universal bounds for hyperbolic Dehn surgery*, Ann. of Math. (2), 162 (2005), pp. 367–421.
- [18] T. JØRGENSEN, *On discrete groups of Möbius transformations*, Amer. J. Math., 98 (1976), pp. 739–749.
- [19] J. KAISER, J. S. PURCELL, AND C. ROLLINS, *Volumes of chain links*, J. Knot Theory Ramifications, 21 (2012). 1250115.
- [20] E. KIN AND D. ROLFSEN, *Braids, orderings, and minimal volume cusped hyperbolic 3-manifolds*, Groups Geom. Dyn., 12 (2018), pp. 961–1004.
- [21] E. KIN AND M. TAKASAWA, *Pseudo-anosov braids with small entropy and the magic 3-manifold*, Comm. Anal. Geom., 19 (2011), pp. 705–758.

- [22] A. KOLPAKOV AND B. MARTELLI, *Hyperbolic four-manifolds with one cusp*, *Geom. Funct. Anal.*, 23 (2013), pp. 1903–1933.
- [23] C. MACLACHLAN AND A. W. REID, *The Arithmetic of Hyperbolic 3-Manifolds*, vol. 219 of Graduate Texts in Mathematics, Springer-Verlag, 2003.
- [24] A. D. MAGID, *Deformation spaces of Kleinian surface groups are not locally connected*, *Geom. Topol.*, 16 (2012), pp. 1247–1320.
- [25] B. MARTELLI, C. PETRONIO, AND F. ROUKEMA, *Exceptional Dehn surgery on the minimally twisted five-chain link*, *Comm. Anal. Geom.*, 22 (2014), pp. 689–735.
- [26] Y. N. MINSKY, *The classification of punctured-torus groups*, *Ann. of Math.* (2), 149 (1999), pp. 559–626.
- [27] Y. MIYAMOTO, *Volumes of hyperbolic manifolds with geodesic boundary*, *Topology*, 33 (1994), pp. 613–629.
- [28] M. SAKUMA AND J. WEEKS, *Examples of canonical decompositions of hyperbolic link complements*, *Jpn. J. Math.*, 21 (1995), pp. 393–439.
- [29] H. SHIMIZU, *On discontinuous groups operating on the product of the upper half planes*, *Ann. of Math.* (2), 77 (1963), pp. 33–71.
- [30] W. P. THURSTON, *The Geometry and Topology of Three-Manifolds*, Lecture Notes from Princeton University, 1978–80. available at <http://library.msri.org/books/gt3m/>.
- [31] ———, *A norm for the homology of 3-manifolds*, *Mem. Amer. Math. Soc.*, 59 (1986), pp. 99–130.
- [32] K. YOSHIDA, *The minimal volume orientable hyperbolic 3-manifold with 4 cusps*, *Pacific J. Math.*, 266 (2013), pp. 457–476.

GRADUATE SCHOOL OF SCIENCE AND ENGINEERING, SAITAMA UNIVERSITY, 255 SHIMO-OKUBO, SAKURA-KU, SAITAMA-SHI, 338-8570, JAPAN.
E-mail address: kyoshida@mail.saitama-u.ac.jp