

# Support Spinor Machine

Kabin Kanjamapornkul,<sup>1,\*</sup> Richard Pinčák,<sup>2,3,†</sup> Sanphet Chunitpaisan,<sup>1,‡</sup> and Erik Bartoš<sup>4,§</sup>

<sup>1</sup>*Department of Computer Engineering, Faculty of Engineering,  
Chulalongkorn University, Pathumwan, Bangkok 10330, Thailand*

<sup>2</sup>*Institute of Experimental Physics, Slovak Academy of Sciences, Watsonova 47, 043 53 Košice, Slovak Republic*

<sup>3</sup>*Bogoliubov Laboratory of Theoretical Physics, Joint Institute for Nuclear Research, 141980 Dubna, Moscow Region, Russia*

<sup>4</sup>*Institute of Physics, Slovak Academy of Sciences,  
Dúbravská cesta 9, 845 11 Bratislava, Slovak Republic*

We generalize a support vector machine to a support spinor machine by using the mathematical structure of wedge product over vector machine in order to extend field from vector field to spinor field. The separated hyperplane is extended to Kolmogorov space in time series data which allow us to extend a structure of support vector machine to a support tensor machine and a support tensor machine moduli space. Our performance test on support spinor machine is done over one class classification of end point in physiology state of time series data after empirical mode analysis and compared with support vector machine test. We implement algorithm of support spinor machine by using Holo-Hilbert amplitude modulation for fully nonlinear and nonstationary time series data analysis.

Keywords: support spinor machine, support vector machine, time series, moduli state space, holo-Hilbert spectrum

## I. INTRODUCTION

In present time, most researchers in econometrics [1] are turning their interests to higher mathematical invariant property so called the Gaussian curvature, especially in a hypothesis test [2]. On the other side there exists an active research [3, 4] in a machine learning and a support vector machine (SVM) [5] applying the usage of modern mathematical structure behind Riemannian curvature so called curvature tensor and spinor field [6]. The differential geometry and cohomology theory approach [7] was introduced for the study of a geometry of an arbitrage opportunity as a new quantity in financial market in the modern econometric theory.

Recent studies of a deep learning in convolution network [8, 9] and on twin SVM [10, 11] are still based on statistical learning theory over Euclidean plane with Hausdorff separation criterion  $T_2$  over induced underlying topological structure of feature space of classification. Naturally, one can extend a scalar field to a Killing vector field by using the Lie derivative of a tensor field and finally to spinor field and to induce an existences of mathematical structure of Clifford algebras over support spinor machine and artificial neuron network like a Basic Clifford neuron (BCN) [12, 13]. Therefore, theoretically, SVM can be extended to a support tensor machine (STM) [14, 15] by using an algebraic operation of free product over equivalent class of quadratic form. The spinor field in the form of Clifford algebra have been directly used [16] in a neuroscience and cognitive science to

improve mathematics in classical model of support vector machine up to so called Clifford fuzzy SVM [17], but with a lack of empirical analysis with financial time series data. The financial time series data by nature [18] are nonlinear and nonstationary time series data and it is very difficult to classify the future direction up and down for them. Because of only simulation works based on both BCN and Clifford fuzzy SVM have been done, one needs to apply a generalization of a vector field to high dimensional mathematical object so called spinor field with real empirical result on financial time series in order to classify their nonlinear and nonstationary behavior. In algebraic geometry a classification space is studied [19] by using the invariant property of curvature over Teichmüller space. It is selected as a mathematical object to classify a feature space in the space of time series data. This fact gives us a new theory of quantum probability over hyperbolic number [20], and an extradimension approach [21–24] for time series data prediction.

We observe that there exists some algebraic topological defect in the mathematical structure of machine learning for support vector classification. The separation in support vector machine [25] performs the classification based on Euclidean plane. This plane can not be used for the classification of some types of input data in the entanglement state with topological Hopf fibration space underlying the input feature space of time series data in non Euclidean plane. Typically, SVM is based on  $T_2$  topological space in which distinct points have disjoint neighborhoods. This criterion is too restrictive for SVM and it does not match with nondisjoint feature set of the classification. Many researchers in STM try to solve this classification problem of SVM under  $T_2$ -separation by introducing the tensor product over feature space and kernel of SVM in which they do not know that in fact the space of time series data is in  $T_0$ -separation space.  $T_0$  space implies  $T_2$  but  $T_2$  property can not always im-

\*Electronic address: [kabinsky@hotmail.com](mailto:kabinsky@hotmail.com)

†Electronic address: [pincak@saske.sk](mailto:pincak@saske.sk)

‡Electronic address: [sanphet.c@chula.ac.th](mailto:sanphet.c@chula.ac.th)

§Electronic address: [erik.bartos@savba.sk](mailto:erik.bartos@savba.sk)

ply  $T_0$ -separation in SVM. In order to solve this problem, we introduce a support spinor machine (SSM) and a support Dirac machine (SDM) as a generalization of SVM based on mathematical structure of connection and Riemannian curvature over principle bundle of Kolmogorov space in time series data. We can classify input data with  $T_0$ -separation axiom of spinor field in time series data over non-Euclidean plane of the classification instead of Hausdorff  $T_2$ -separation axiom in SVM over Euclidean plane. The support spinor machine is a new mathematical object arising from the algebraic topological and machine learning approaches on the level of the invariant property over topological space underlying the observed data, so called moduli space in time series data. SVM poses the intrinsic property of the classification allowing higher dimension of feature space for the classification embedded in the complex projective space with oriented and non-oriented states instead of using pointed space embedded in the real number system.

In SSM we are based on the concept of adaptive data analysis method of Hilbert-Huang transformation [26] and Holo-Hilbert amplitude modulation [27] suitable for the empirical analysis of financial time series data induced from adaptive behavior of traders [28]. We can not defined explicit statistical formulae for learning algorithm of SSM. Instead we use data learning themselves from the sifting process of moduli state space model. It is implied that we do empirical analysis in more flexible form than BCN and Clifford fuzzy SVM in which it is based on explicit form of data simulation of Clifford algebras. The contribution of SSM over BCN and Clifford fuzzy SVM lays in fact, that in SSM we use invariant property of topological space and also second cohomology group of spinor field to analyze data. We use moduli state space to visualized data in SSM which are generalization of data points in BCN and Clifford fuzzy SVM. The separation hyperplane in SSM is based not only on algebraic property of spinor field but also on geometric property of loop space in time series data in which we use invariant property of plane and duality map between second cohomology group as spinor field. Although BCN and Clifford fuzzy SVM also can be applied to real analysis to nonlinear and nonstationary data like SSM if we need to compare the performance to real data set between them and SSM.

In this work, we give the precise definition of moduli state space model in financial time series data and we prove the existence of support spinor field and its application with algebraic topological approach. We verify the existence of spinor field by using mathematical invariant property of second cohomology group and moduli space. To guarantee the usefulness of new SSM model, the empirical analysis have been done over financial time series data. We compare the result of performance of one day ahead directional prediction with support vector machine. We find the equation of moduli state space model over support Dirac machine. In the equation, we have a solution of weight of SSM as a coupling tensor field

between two sides of market in the behavior of trader in hidden state space  $X_t([A_1], [A_2], [A_3])$  ( $[A_i]$  are defined in [7]) and in a physiology of time series data. This equation of moduli state space model is an equivalent class over moduli state space  $C_n(Y_t/X_t)$  between observed state space,  $Y_t([s_1], [s_2], [s_3], [s_4])$  (the definition of physiology state,  $[s_i]$  can be found in [6]) and hidden state space,  $X_t([A_1], [A_2], [A_3])$ .

Based on the proposed mathematical motives we state that SSM superiors SVM with nonstationary data analysis [29]. Basically, SVM are used to classifying data with constant time. For time series data, there exists support vector regression machines [30] based on SVM concept and cannot be used for general time series data.

The advantage of SSM over SVM is that SSM can be useful for classifying future direction of nonlinear [31] and nonstationary [32, 33] time series data, especially financial time series data. SVM can be used only for nonlinear but stationary time series data based on linear algebras of vector space for support vector classification. But SSM are based on a spinor field in which can be linear and nonlinear vector space and Holo-Hilbert spectral analysis [27] in which can be done fully nonstationary time series analysis. Based on criterion of nature of input data, SSM can be used in more general conditions than SVM.

The paper is organized as follows, in Section II we prove the existence of the support spinor machine and the moduli state space model. We explain the application of SSM algorithm in the form of classification of point over complex projective plane. We explain the market cocycle in the form of coupling between the tensor field in time series data. We build a new equation for financial market in the form of Killing vector field over connection and we derive the explicit formula of an equivalent class of weight in SSM. In Section III, we apply SSM to the directional prediction over six different types of time series data. We measure the performance of the directional prediction in out of sample data. We compare the performance of SSM with SVM and the empirical result of Holo-Hilbert transform amplitude modulation (AM) mode with second layer. In Section IV, we give the discussion and conclusion for our new model of SSM and the plans for the future work.

## II. SUPPORT SPINOR MACHINE

### A. Moduli State Space Model

In  $T_0$ -separation criterion of time series data, we obtain a loop space in time series data. In this section we want to introduce standard classification of topological space by using genus of Riemann surface so called Teichmüller space in time series data. Each data of classification we associate with a genus of Riemann surface of data in the form of moduli stack of time series data analogue with moduli stack  $\mathcal{M}_g$  in algebraic geometry (Fig. 1). We use Riemann surface  $S^2 \sim \mathbb{C}P^1$ , where

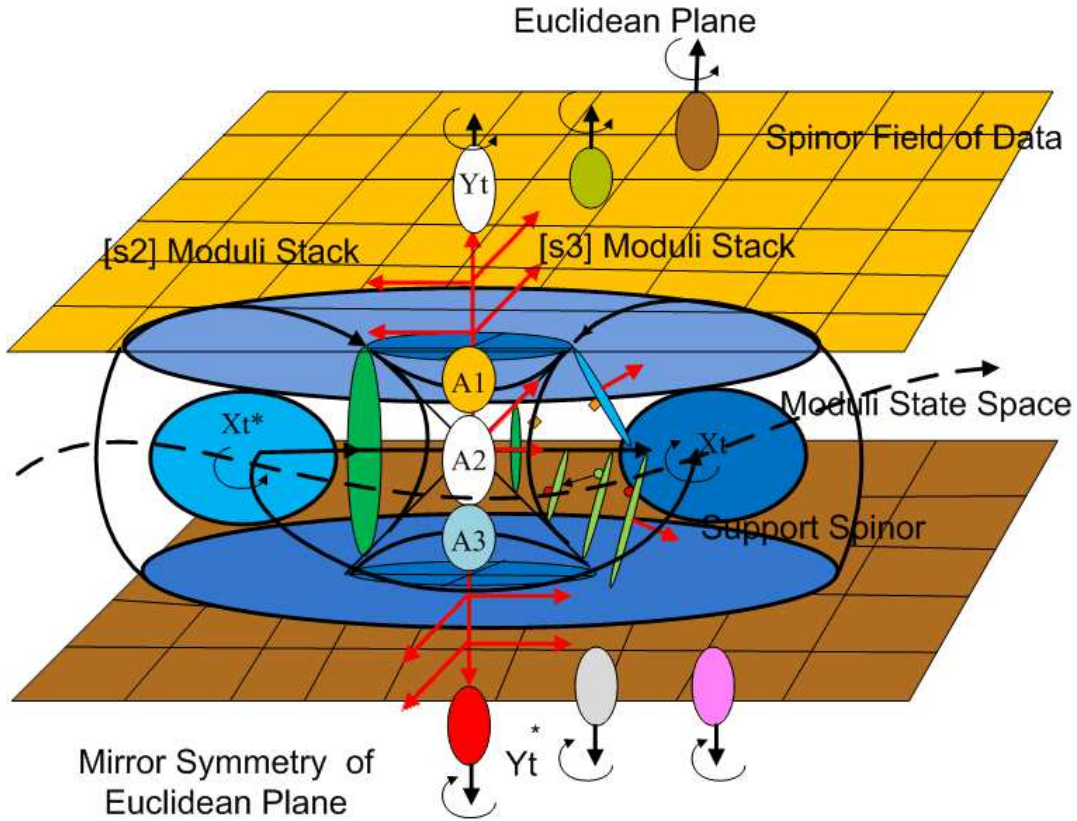

FIG. 1: Picture shows the moduli state space model with classical support vector. We use the error of prediction to build a cone of separated hyperplane in quantization field of spinor machine. It is supposed to be Teichmüller space in time series data.

$\sim$  is the homotopy equivalent, as the surface of principle bundle for embedding data of classification with genus zeros, non-Euclidean plane in support spinor machine. The algorithm for embedding data to Riemann surface with genus  $g$  as a toric model of moduli space  $\mathcal{M}_g$  of data so called Teichmüller map of time series data  $x_t \in X_t = \mathcal{M}_g$  is,

$$\gamma : [0, 1] \rightarrow \mathcal{M}_g, \quad \gamma(0) = x_t, \quad \gamma(1) = \text{Id}.$$

Given a time series data as a sequence of observation data  $x_1 \rightarrow x_2 \rightarrow \dots \rightarrow x_n$ , we induce a sequence of embedded Teichmüller spaces in time series data as following

$$\begin{array}{ccccccc} x_1 & \longrightarrow & x_2 & \longrightarrow & \dots & \longrightarrow & x_n \\ \downarrow & & \downarrow & & \downarrow & & \downarrow \\ \mathcal{M}_{g=1} & \xrightarrow{d} & \mathcal{M}_{g=2} & \xrightarrow{d} & \dots & \xrightarrow{d} & \mathcal{M}_{g=n} \end{array} \quad (1)$$

where  $\mathcal{M}_{g=n}$  is the moduli state space of time series data which is isomorphic to Riemann surface of data with  $n$ -hole (genus  $n$ ).

**Definition 1.** Let  $X_t$  be a Kolmogorov space in time series data of input financial time series data for the classification,  $X_t = X_t([A_i])$ ,  $i = 1, \dots, 3$ , where  $[A_i]$  is an equivalent class of the behavior of trader. We have  $2^3 = 8$

hidden market states as all possibilities (discrete topology of categories of coordinate of  $[A_i]$ ) of transition between all hidden states.

**Definition 2.** Let  $Y_t$  be a Kolmogorov space in time series data of input financial time series data for the classification,  $Y_t = Y_t([s_i])$ ,  $i = 1, \dots, 4$ , where  $[s_i]$  is a physiology of time series data in observation or classification space.

**Definition 3.** Let  $C_n(X_t)$  be a chain complex of state space and  $C_n(Y_t)$  be a  $n$ -chain complex of observation space. We have a differential of chain  $C_n(Y_t)$  and cochain  $C^n(Y_t)$  between state and observation complex. We define a relative complex  $C_n(Y_t/X_t) := C_n(Y_t)/C_n(X_t)$ . The cohomology group for moduli state space model with equivalent class of moduli regression coefficient  $[\beta]$  is defined for  $n = 0, 1, 2, \dots$  by

$$[\beta_n] \in H_n(Y_t/X_t) = \ker \partial_{n-1} C_{n-1}(Y_t) / \text{Im } \partial_n C_n(Y_t).$$

**Definition 4.** A equivalent path  $[\alpha_n]$  in support spinor machine (SSM) is an equivalent class of degree of map between homotopy class of Teichmüller space in time series data  $\mathcal{M}_g$  with genus  $g$  to classifying space  $Y_t = \mathbb{Z}_2$

$$[\gamma_i] \in [\mathcal{M}_g, \mathbb{Z}_2] := [\mathcal{M}_g, Y_t] \quad (2)$$

with  $[\gamma_i] = [(e^{i\theta}, e^{i\beta})] \mapsto (\alpha^*, \beta^*) \mapsto \mathbb{Z}_2$ .

**Definition 5.** A Holo-Hilbert functor in time series data is an equivalence between an functor map of homotopy class in higher dimension of  $n$ -sphere defined by

$$\begin{aligned} \text{Holo} : [S^0, -] &\rightarrow [S^1, -] \\ &\rightarrow [S^2, -] \rightarrow \dots [S^n, -] \rightarrow \dots \end{aligned} \quad (3)$$

with

$$\begin{aligned} \text{Holo}(X_t) = [S^0, X_t] &\rightarrow [S^1, X_t] \\ &\rightarrow [S^2, X_t] \rightarrow \dots [S^n, X_t] \rightarrow \dots \end{aligned}$$

**Definition 6.** A loop space in time series data is an observation state space of a physiology of time series data defined by  $Y_t := \pi_1(\mathbb{R}^{n+1} - X_t)$ . We define a spinor field in time series of observation data by equivalent class of duality map between  $y_t \in \pi_1(\mathbb{R}^{n+1} - \{x_t\}) := Y_t$ ,  $x_t \in X_t$  be a classifying observation data in observation state space,  $y_t \in Y_t$

$$\begin{aligned} [w] : \pi_1(\mathbb{R}^{n+1} - X_t) &:= Y_t \rightarrow H_1(X_t) \\ &\rightarrow H_2(X_t) \rightarrow H^2(X_t). \end{aligned} \quad (4)$$

**Definition 7.** We define an equilibrium state in moduli state space model by an isotopy group under group operation of  $G = PSL(2, \mathbb{C})$ ,

$$G \times X_t \rightarrow X_t \quad (5)$$

Let  $Y_t$  be a time series of measurement financial data induced from coupling between equivalent class of behavior of trader  $[A_i]$  ( $i = 1, 2, 3$ ). Consider  $y_t \in Y_t$  with  $y_t = G([A_1, A_2, A_3])$ . The moduli state space model is a moduli of classical ARIMA model in time series analysis with coefficient as parameter in quantization state of spinor field  $a, b, c, d, \alpha \in \mathbb{H}$  into a modified diophantine equation [34] (just borrowing the notation with different algebraic operation in new definition) as following

$$ax_t \equiv 1 \pmod{[s_1]} \quad (6)$$

$$bx_t \equiv i \pmod{[s_2]} \quad (7)$$

$$cx_t \equiv -1 \pmod{[s_3]} \quad (8)$$

$$dx_t \equiv -i \pmod{[s_4]} \quad (9)$$

$$\alpha y_t \equiv x_t([s_i], A[i]) \pmod{[A_i]}. \quad (10)$$

We have

$$ax_t - [s_1]x_t^* = 1 \quad (11)$$

$$bx_t - [s_2]x_t^* = i \quad (12)$$

$$cx_t - [s_3]x_t^* = 1 \quad (13)$$

$$dx_t - [s_4]x_t^* = -i \quad (14)$$

where  $x_t^*$  is a hidden state of time series data.

## B. Proof of $T_0$ -separation criterion for SSM

The source of SVM is a second cohomology group of the classification of a plane by using a loop space in time

series data. Let  $X_t, Y_t$  be a topological space of state and observation time series data with  $Y_t = \pi_1(\mathbb{R}^{n+1} - X_t)$ . Let  $x_1, x_2 \in X_t$ ,  $[-1] \in \pi_1(\mathbb{R}^2 - \{x_1\})$  and  $[1] \in \pi_1(\mathbb{R}^2 - \{x_2\})$

$$\pi_1(\mathbb{R}^2 - X_t) \rightarrow H_1(X_t) \rightarrow H_2(X_t). \quad (15)$$

**Definition 8.**  $\langle X_t, \mathcal{O} \rangle$  is a  $T_0$ -space if and only if  $x, y \in S$  with  $y \neq x$  implies that  $\exists U, V \in \tau$  with  $x \in U, y \in S - U$  and  $y \in V, x \in S - V$ .  $T_0$ -spaces are also called Kolmogorov spaces.

**Definition 9.**  $\langle X_t, \mathcal{O} \rangle$  is a  $T_2$ -space if and only if  $x, y \in S$  with  $y \neq x$  implies that  $\exists U, V \in \tau$  with  $x \in U, y \in V$  and  $U \cap V = \emptyset$ .  $T_2$ -spaces are also called Hausdorff spaces.

**Theorem 1.** Let  $(x_1, y_1)$  and  $(x_2, y_2)$  be input space and classifying space for a support vector machine in the Euclidean plane such that  $x_1 = x_2$  and  $y_1 \neq y_2, x_1, x_2 \in \mathbb{R}^n, y_1, y_2 \in \mathbb{Z}_2$ . We can separate a non-separation data in  $T_2$ -separation with a disjoint neighborhood in a moduli state space in time series data with  $T_0$ -separation of SSM.

*Proof.* Let  $x_1, x_2 \in \mathbb{R}^n$ , with  $x_1 = x_2$  and  $y_1 \neq y_2 \in \mathbb{Z}_2 = \{-1, 1\}$ , if  $y_1 = 1$  we imply  $y_2 = -1$ . For SVM, there exists some defect on algebraic construction over real line on classification of input data  $(x_i, y_i)$ , which can not be used when two input data have similar value with different output of classification  $y_i \in \{+1, -1\}$ . We suppose that the training data of  $n$ -samples are recorded and visualized as embedded pointed space  $(x_1, y_1), \dots (x_n, y_n)$ ,  $x \in \mathbb{R}^{n+1}$ ,  $y \in \{+1, -1\}$  in the Euclidean space with hyperplane decision function

$$\langle w, x \rangle - b \geq +\Delta, \quad y = +1, \quad (16)$$

$$\langle w, x \rangle - b \leq -\Delta, \quad y = -1, \quad (17)$$

where  $w$  is normal vector to the hyperplane. In the Euclidean plane over real number field, there exists the case when the input space  $x_i \in \mathbb{R}$  is not compact and complete space, e. g., the space contains only two disjoint similar points with points defined to infinity  $*$  =  $\{\infty\}$ . Therefore one cannot use the compact equation because the value of classification ground field has the same algebraic structure with inner product  $\langle w, x \rangle, y \in \mathbb{R}$ . This problem is well known in the functional analysis and it is so called ill-posed problem or regularization problem. Therefore we get the equation

$$y \langle w, x \rangle - b \leq \Delta, \quad (18)$$

which is not hold for SVM in the cases of ill-posed problem over classification data.

The spinor field of time series data model is a hidden stats of classical time series model throughout a quantization state of time series data. The quantization state of time series data can be explained by the concept of orientation and non-orientation state in time series data in

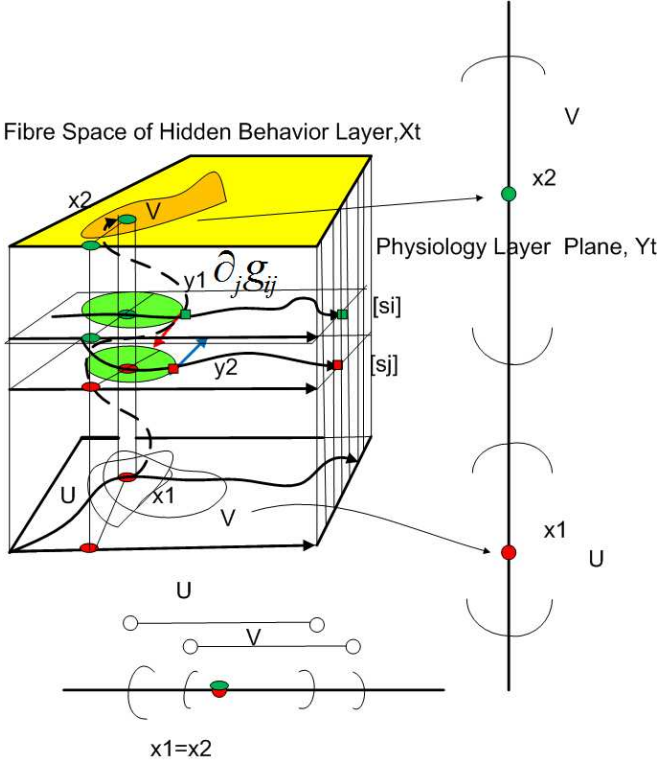

FIG. 2: The projection of similar input data to real number line. We lift the path of data to fibre space, it is the source of curvature in time series data. The curvature blend a real line into curve with operator of Riemannian tensor field  $\partial_k g_{ij}$ . The side of curve in this plot is moduli state space model of physiology of time series data. This space is an observation space of time series data. Its source is coming from the coupling of behavior of trader in the hidden state space  $X_t([A_i])$  layers. In SVM, there exists an algebraic defect over Euclidean plane of separation. This situation happens when input feature space contains the same data with  $x_1 = x_2 \in U, V \subset \mathbb{R}^n$ , but  $(x_1, y_1) \neq (x_2, y_2)$ . In SVM, we use  $T_0$ -separation axiom to solve this problem with the lift path of  $x_1, x_2$  to the fibre space with homotopy path. The separation is a diffeomorphic map in the tangent of manifold of Kolmogorov space in time series data.

which it is deep connected to the concept of tanglement and entanglement states in the quantum mechanics, in some situations we can resolve this problem over principle bundle theory.

Let us consider a neighborhood of classification data over input space  $X = U \cup V$ , with  $U \cap V = \phi$ . Let  $U_\epsilon(x \in \mathbb{R}^n; x_i)$  defined by  $U_\epsilon(x; x_i) = \{x \mid \|x - x_i\| < \epsilon\}$ . Choose a radius ball  $\epsilon$  such that  $wx - b < \epsilon < 1$  then set  $\epsilon' = \frac{\epsilon}{w}$  such that  $x - \frac{b}{w} < \frac{\epsilon}{w} < 1$ , set  $x_i = \frac{b}{w}$ . We have  $U_\epsilon(x; x_i) = \{x \mid \|x - x_i\| < \epsilon < 1\}$ . Let  $x_1 \in U_\epsilon(x; x_i) =: U$ . It implies that  $x_2 \in U_\epsilon(x; x_i) =: V \subset \mathbb{R}^n$ . Therefore  $U \cap V \neq \phi$ . It is in the contradiction with the assumption above. Therefore, we can not use  $T_2$ -separation in the case of such algebraic defect over SVM. (We want to proof that in SSM the covering spaces of  $X_1$  and  $X_2$  are separated with  $T_0$ -separation axiom.)  $\square$

Let  $x_1, x_2 \in \mathbb{R}^n$ . It is enough to perform the proof for the case  $n = 2$ . Let  $T^2 = \mathbb{R}^2/\mathbb{Z}$  be a torus with genus  $g = 1$ . If we consider  $\mathbb{R}^2 - \{x_1\}$ , this space is homotopy equivalent to  $S^1$ . We use the fact that  $S^2 = S^1 \vee S^1 \sim \mathbb{C}P^1$  where  $\vee$  is a smash product in the algebraic topology and  $\sim$  is a homotopy equivalence operation, the complex projective space  $\mathbb{C}P^1$  is a principle bundle. Let define a lift path from  $\mathbb{R}^2 \rightarrow T^2$ .

**Theorem 2.** SVM cannot use  $T_2$ -separation axiom to separate similar values of input time series data over the Euclidean plane. We will prove that if the input feature space is extended to the non-Euclidean plane of a equivalent class of degree of map in the loop space in time series data then we can use  $T_0$ -separation axiom to separate the non-separated similar values of input data in SVM. The algebraic defect of SVM will be repaired by SSM with input feature space in the form of a equivalent class of degree of loop space in time series data  $x_1 := [\theta_1] \in \pi_1(X_t, x_1)$ ,  $x_2 = [\theta_2] \in \pi_1(X_t, x_2)$  with  $[\theta_1] = [\theta_2]$  but  $\theta_1 \neq \theta_2$ .

*Proof.* Let  $(x_i, y_i)$  be a feature space of SSM with  $x_1 \in U \subset X_t$ ,  $x_2 \in V \subset X_t$  with  $U \cap V = \phi$ . Let  $y_1 = [e^{2i\pi}] = [1] \in \pi_1(\mathbb{R}^{n+1} - U) = H^1(U)$ ,  $y_2 = [e^{i\pi}] = [-1] \in \pi_1(\mathbb{R}^{n+1} - V) = H^1(V)$ ,  $n = 1$ . We assume that the input  $\{x_i\}$  is a pointed space. The point  $x_i$  is contractible from compact feature space of data  $U, V \sim *$ . Let a deform plane of the classification for SSM be a Kolmogorov space in time series data  $Y_t$ . When we delete one point  $x_i$  from the plane of classification  $y_i \in \mathbb{R}^{n+1}$  we induce a vector field on unit cycle of the classification space  $y_i \in S^n$  around input data  $x_i$  since  $\mathbb{R}^{n+1} - \{x_i\} \sim S^n$ .

Let  $x_1 = x_2$  with  $(x_1, y_1) \neq (x_2, y_2) \in U \cap V$ . We want to prove that  $x_1 \in U$  and  $x_2 \notin V$  or  $x_1 \notin U$  and  $x_2 \in V$  over the fibre space by using the homotopy lift path (see Fig. 2 for more details). We want to remark that if  $U, V \subset \mathbb{R}^n$  or the Euclidean flat plane, we cannot separate  $x_1$  from  $x_2$  as we have demonstrated in the previous section. But if  $U, V$  are subset of the non-Euclidean plane we can separate them by using homotopy to deform the Kolmogorov space of time series data. The definition of a homotopy map in this prove is used to glue the deleted points from the classification space to Riemann sphere  $S^2 \sim \mathbb{C}P^1$

$$H : \mathbb{R}^3 - \{x_i\} \times I \rightarrow S^2. \quad (19)$$

In the second part of proof we let  $x_1 \in U, x_2 \in V$  with  $X_t = U \amalg_\alpha V$  and the homotopy class above is defined by

$$[\alpha] : U \amalg V \rightarrow S^1, \quad (20)$$

$$(x_1, 0) \mapsto [-1] = e^{i\pi} \in S^1, (x_2, 1) \mapsto [1] = e^{i2\pi} \in S^1.$$

We let  $\theta_1 = \pi$ ,  $\theta_2 = 2\pi$ , it is clear that  $\theta_1 \neq \theta_2$ . There exists the optimal degree  $\theta^*$  such that the line passing  $\theta^*$  cuts unit cycle and separates  $\theta_1 = \pi$  and  $\theta_2 = 2\pi$  from each other. We have chosen the separate plane over

the complex projective plane with  $[\theta^*] = \frac{3\pi}{4}$ , so we have  $\theta_1 < \theta^* < \theta_2$ .  $\square$

The source of the spinor field in time series data induces from the behavior of trader for the expectation on next period of the physiology of time series data state  $[s_i]_{i+1} := [s_i^*]$  in financial time series data. There exists many possibilities in the expected futures price from various behaviors of trader. We can classify them into four types of tensor fields under moduli state space model in the next section. The source of SSM in the classification of state in the financial market induces from coupling between these behavior fields of trader in the financial market. We explain in detail with the definition of action of these fields to space of financial market as market cycle and cocycle quantity. These quantities are equivalent to the genus of our new model of Teichmüller space in time series data in the previous subsection.

### C. Financial Market Cocycle

The element  $g \in G$  induces a Lie algebras [35]  $g_{ij}$  in  $T_x G$  over the tangent of spin manifold of time series data with jacobian flow  $\frac{dg_{ij}}{dt}$ , where  $t \in [0, 1]$  of phase space of transition over homotopy class [36] of space of time series data. We define so called cocycle property of orbifold in time series data with its dual  $g_k^l = g_{ki}g_{im}g_m^l$ . We call  $g_{ij}$  a covariance tensor field in financial time series data,  $g^{ij}$  is a contravariance tensor field in financial data and  $g_k^l$  a natural map between covariance and contravariance functor in time series data. We denote the market state in the physiology layer of time series data  $x_t$  as  $[s_i]$  and in the main layer of time series data as hidden market state  $[A_i]$ . The expectation states of the prediction we denote as  $[s_i^*]$  and  $[A_i^*]$ . In this work we use a symbol of a homotopy path  $[\beta_{t+1}]$  as a equivalent class of path over behavior of trader  $[A_i^*] := [\beta_{t+1}]$ , and a symbol  $[\theta_{t+1}]$  as a equivalent class of path over behavior of trader  $[s_i^*] := [\theta_{t+1}]$ . The jacobian is defined as the market cocycle between the hidden coordinate transformation of behavior of trader to the coordinate of the physiology of time series data in outer layer of observation state space  $Y_t$

$$g_{ij} = \left( \frac{\partial [A_j]}{\partial [s_j]} \right)_{ij}. \quad (21)$$

The scalar product over the tangent of manifold of space of time series data is define over principle bundle  $\mathbb{C}P^1$

$$\langle \beta_{t+1}, \theta_{t+1} \rangle \simeq \left[ \frac{\beta_{t+1}}{\theta_{t+1}}, 1 \right] \in \mathbb{C}P^1. \quad (22)$$

**Definition 10.** Let define four types of tensor fields in time series data with extradimensions in fibre space with coupling between vector and covector field in moduli state space in time series data  $x_t \in X_t$ ,  $y_t \in Y_t$ ,  $[\theta_{t+1}] \in$

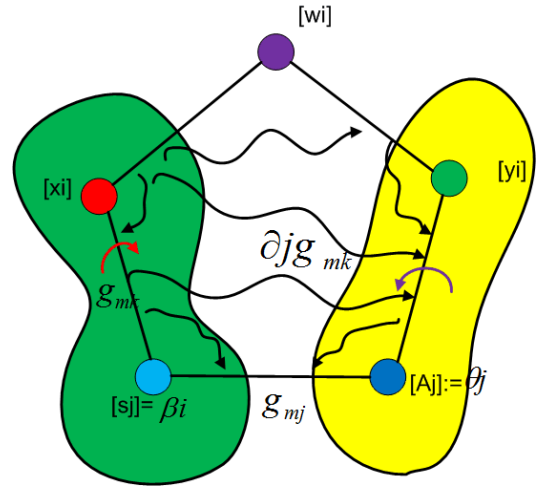

FIG. 3: The picture shows the example of the definition of four types of tensor field between the physiology layer of time series data  $Y_t = Y_t([s_1], [s_2], [s_3], [s_4])$  and main layer in time series data so called hidden behavior of trader  $X_t([A_1, A_2, A_3])$ . The connection is the strength of a tensor field, i. e., the map between sides in the diagram.

$[X_{t+1}, S^1]$ ,  $[\beta_{t+1}] \in [Y_{t+1}, S^1]$ . It is an expectation field of behavior of trader with four component fields

$$\begin{aligned} \partial_j &:= \frac{\partial}{\partial [\theta_{t+1}]}, & \partial_k &:= \frac{\partial}{\partial x_{t+1}}, \\ \partial_l &:= \frac{\partial}{\partial y_{t+1}}, & \partial_m &:= \frac{\partial}{\partial [\beta_{t+1}]} \end{aligned} \quad (23)$$

**Definition 11.** Let  $g_{ij}$  be a market cycle and  $g^{ij}$  be a market cocycle over the moduli state space of Kolmogorov space  $X_t, Y_t$ . The cocycle is an expected futures cycle. Such model is a market communication model between supply and demand side of the physiology layer of time series data and the behavior of trader in hidden layer of time series data.

We define each component of tensor field in time series data by jacobian of coordinate transformation  $g_{ij}$  with explicitly four components of jacobian flow associated with four types of market cycles as the followings (see Fig. 3 for details of the definition)

- Type I. Let  $g_{kl}$  is a cycle associate with scalar product of  $\langle x_{t+1}, y_{t+1} \rangle = \sum_{kl} g_{kl} x_k y_l := \sum_{kl} g_{kl} x_{t+1,k} y_{t+1,l}$ ,  $g^{kl}$  is a cocycle associate with scalar product of  $\langle x_{t+1}^*, y_{t+1}^* \rangle = \sum_{kl} g^{kl} x_k^* y_l^* := \sum_{kl} g^{kl} x_{t+1,k}^* y_{t+1,l}^*$ .
- Type II. Let  $g_{ml}$  is a cycle associate with scalar product of  $\langle [\beta]_{t+1}, y_{t+1} \rangle = \sum_{ml} g_{ml} [\beta]_m y_l := \sum_{ml} g_{ml} [\beta]_{t+1,m} y_{t+1,l}$ ,  $g^{ml}$  is a cocycle associate with scalar product of  $\langle [\beta]_{t+1}^*, y_{t+1}^* \rangle = \sum_{ml} g^{ml} [\beta]_m^* y_l^* := \sum_{ml} g^{ml} [\beta]_{t+1,m}^* y_{t+1,l}^*$ .
- Type III. Let  $g_{km}$  is a cycle associate with scalar product of  $\langle x_{t+1}, [\beta]_{t+1} \rangle = \sum_{km} g_{km} x_k [\beta]_m :=$

$\sum_{km} g_{km} x_{t+1,k} [\beta]_{t+1,l}$ ,  $g^{kl}$  is a cocycle associate with scalar product of their dual basis.

- Type IV. Let  $g_{jm}$  is a cycle associate with scalar product of  $\langle [\theta]_{t+1}, [\beta]_{t+1} \rangle = \sum_{jm} g_{jm} [\theta]_j [\beta]_m := \sum_{jm} g_{jm} [\theta]_{t+1,j} [\beta]_{t+1,m}$ ,  $g^{jm}$  is a cocycle associate with scalar product of their dual basis.

It is known from the differential geometry that a connection over tensor field can be written as

$$\nabla_j g_{kl} = \partial_j g_{kl} - \Gamma_{jk}^m g_{ml} - \Gamma_{jl}^m g_{km}, \quad (24)$$

$$\Gamma_{ij}^m = \frac{1}{2} g^{ml} (\partial_j g_{il} + \partial_i g_{lj} - \partial_l g_{ji}). \quad (25)$$

The above equation allow us to work over the connection of fibre space [37] as an extradimension in moduli state space of Killing vector field approach. We just use the tool for the computation of expected state of our new definition of spinor field in time series data.

**Definition 12.** Let support spinor be an arbitrage opportunity  $\Gamma_{ij}^m$  in financial market over the moduli state space model in time series data as an Riemannian connection preserves scalar product over the parallel translation along fibre space of the physiology layer in time series data.

**Definition 13.** The Ricci tensor in time series data is a contraction of a curvature tensor defined by  $R_{ik} = R_{ikl}^j$  with respect to natural frame of connection

$$R_{ik} = \partial_k \Gamma_{ji}^j - \partial_j \Gamma_{ki}^j + \Gamma_{km}^j \Gamma_{ji}^m - \Gamma_{jm}^k \Gamma_{ki}^m. \quad (26)$$

Note that we deform space time of Kolmogorov space in time series data by using a curvature tensor and give an existence of price particle with spin and 8-market states so called arbitron or arbitrage opportunity  $R_{ik}$  in financial market. It is known from differential geometry that

$$\Gamma_{jk}^j = \frac{1}{2} g^{jm} (\partial_k g_{mj}) = \frac{1}{2g} \frac{\partial g}{\partial x^k} = \frac{\partial}{\partial x^k} \ln |g|^{\frac{1}{2}} \quad (27)$$

since

$$g^{ij} = \frac{1}{g} \frac{\partial g}{\partial g_{ij}}. \quad (28)$$

For the case of the market equilibrium Ricci curvature is zero  $R_{ik} = 0$ , i. e., the arbitrage opportunity disappears and the physiology of time series data contains no curvature. It is a Peterson-Codazzi equation in the differential form [38, 39]. The solution of the equation is a curvature of SSM for classification Riemann surface of time series data.

We have a support Dirac machine (SDM) for financial time series data (see Fig. 4 for new type of artificial neuron network with connection) by using a connection and market cocycle modulo the state of behavior of trader as bias module in neuron network,

$$\sum_i [s_i] \nabla_{[s_i]} g_{kl} \langle x_t, y_t \rangle = \gamma([A_i]) \langle x_t, y_t \rangle \text{ mod } [A_i] \quad (29)$$

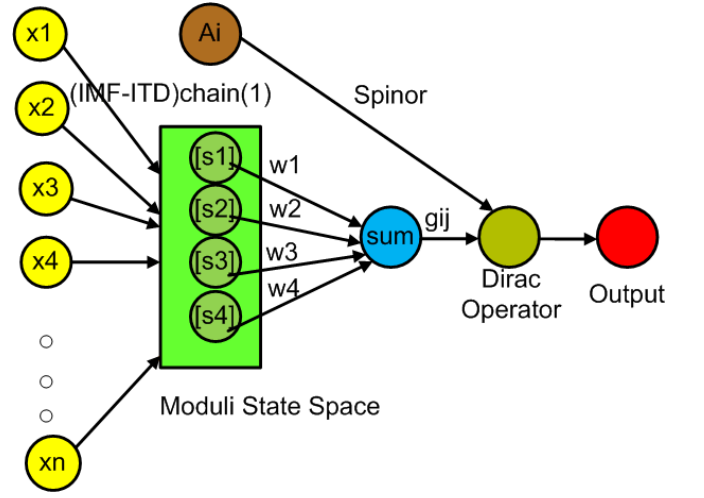

FIG. 4: The diagram of SSM with support Dirac machine. In comparison with the artificial neuron network we call this network the artificial support spinor network. The network is associated with Dirac equation in finances with solution with spin half particle of behavior of trader  $A_i$  in market four states. We call the solution of a lagrangian of SSM an arbitron or arbitrage opportunity state.

where  $\gamma([A_i])$  is Dirac matrix over Pauli matrix of equivalent class of behavior of trader  $[A_i]$ ,  $i = 1, 2, 3$ .

The modulation of  $[A_i]$  is equivalent to the amplitude modulation in Holo-Hilbert algorithm [27] in our empirical part of the paper (see Section III).

**Definition 14.** A support spinor is a coupling state between a market four states in financial market induced from trading behavior with spin half as an optimal solution of following equation

$$L([s_i], [A_i], w_i) = \sum_{i=1}^4 [s_i] \nabla_{[s_i]} \langle w, [s_i(x_t)] \rangle - \gamma([A_i]) \langle w, [s_i(x_t)] \rangle \text{ mod } [A_i]. \quad (30)$$

#### D. Proof of the existence of SSM

**Theorem 3.** The weight of support spinor machine is an equivalent class  $[w]$  as a solution of Eq. (30), for financial time series data it can be written as

$$[w] = i \oint_{H^2(X_t/Y_t)} (\Gamma_{jk}^m g_{ml} + \Gamma_{jl}^m g_{km}) d[s_i] \wedge d[s_j^*] \text{ mod } [A_i]. \quad (31)$$

*Proof.* Let  $[w] \in [X_t, S^1]$  is defined by  $[w] = [\beta_t : \sum \lambda_i \frac{x_t}{y_t} \mapsto e^{i \langle x_t, y_t \rangle}] = [e^{i x_t y_t}]$ . Consider type II of SSM with  $g_{kl}$  defined by

$$g_{kl} = \langle w, x \rangle = \langle [\beta]_{t+1}, x_{t+1} \rangle = \langle [e^{i x_{t+1} y_{t+1}}], x_{t+1} \rangle \simeq e^{i x_{t+1} y_{t+1}} x_{t+1} \quad (32)$$

where

$$-i \frac{\partial}{\partial y_{t+1}} e^{ix_{t+1}y_{t+1}} = e^{ix_{t+1}y_{t+1}} x_{t+1} := g_{kl} \quad (33)$$

We define a covector field of  $\partial_j g_{kl}$  by a vector field

$$\partial_j g_{kl} := \frac{\partial}{\partial y_{t+1}} g_{kl} = -i \frac{\partial^2}{\partial^2 y_{t+1}} [w] \quad (34)$$

Consider Killing equation over Killing support vector field

$$\nabla_j g_{kl} = 0 \quad (35)$$

with

$$\sum_{i=1}^4 [s_i] \cdot \nabla_j g_{kl} \langle x_t, y_t \rangle = 0. \quad (36)$$

We have an equation

$$\nabla_j g_{kl} = \partial_j g_{kl} - \Gamma_{jk}^m g_{ml} - \Gamma_{jl}^m g_{km} = 0, \quad (37)$$

with

$$\partial_j g_{kl} := -i \frac{\partial^2}{\partial^2 y_{t+1}} [w] = \Gamma_{jk}^m g_{ml} + \Gamma_{jl}^m g_{km}, \quad (38)$$

where

$$\Gamma_{ij}^m = \frac{1}{2} g^{ml} (\partial_j g_{il} + \partial_i g_{lj} - \partial_l g_{ji}). \quad (39)$$

If we classify the observation space  $y_{t+1} \in [s_i]$ , where  $[s_i]$  is an equivalent class of the physiology of time series data, we will receive an equation for SSM  $[w]$  by using De-Rahm cohomology in financial time series. We induce a closed surface integral over second differential form of Riemann sphere over the physiology of time series data of present state  $[s_i]$  and expectation state  $[s_j^*]$  (from Eq. (34), integrate both sides two times and then take modulo of the state of behavior of trader)

$$\begin{aligned} [w]_{n=0,1,2,\dots} = \\ \text{i} \oint_{H^2(X_i/Y_i)} (\Gamma_{jk}^m g_{ml} + \Gamma_{jl}^m g_{km}) d[s_i] \wedge d[s_j^*] \quad \text{mod} [A_i]. \end{aligned} \quad (40)$$

Therefore we get a diophantine equation for financial time series data as a equation for SSM (we call it SSM-equation) with the quantization state of the weight  $[w]_{n=0,1,2,\dots}$

$$\begin{aligned} [w]_{n=0,1,2,\dots} - n[A_i] = \\ \text{i} \oint_{H^2(X_i/Y_i)} (\Gamma_{jk}^m g_{ml} + \Gamma_{jl}^m g_{km}) d[s_i] \wedge d[s_j^*]. \end{aligned} \quad (41)$$

in moduli state space of behavior of equivalent class of a behavior of trader  $[A_i]$ . This equivalent class satisfies a

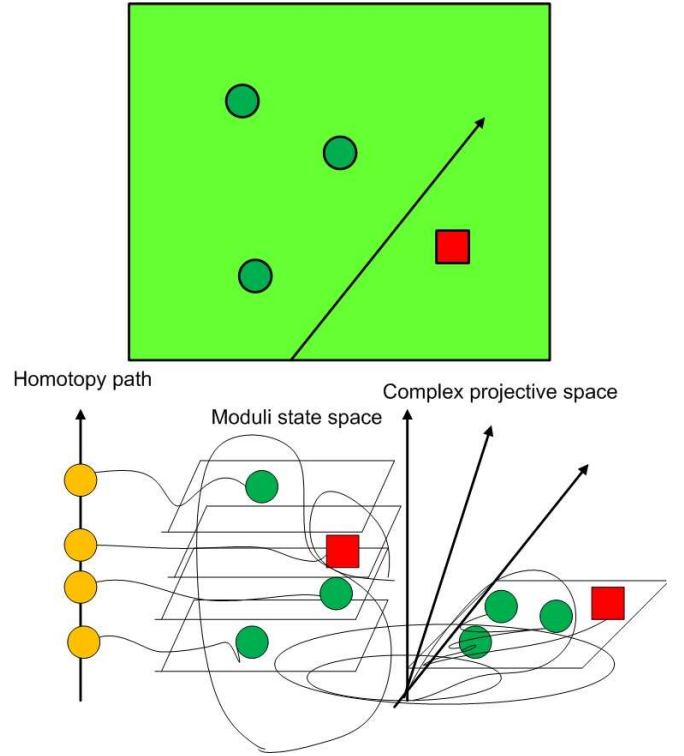

FIG. 5: Picture shows the extradimension in spinor field of plane separation in classical support vector machine.

differential 3-form of behavior of trader as market potential field  $\mathcal{A}$

$$d\mathcal{A} = \sum_{ijk=1,2,3} F_{ijk}^{\nabla[s_i]} dA_i \wedge A_j \wedge A_k \quad (42)$$

and it has a deep relationship with supply and demand potentials in cohomology theory of financial market [7].  $\square$

### E. Optimal hyperplane for SSM

In SSM we work on non-Euclidean space as the plane of classification in which we can use homotopy to deform classical Euclidean space of classification plane in SVM into moduli space of time series. The space of time series has intrinsic cocycle as jacobian flow in another hidden space and its dual space that embed in between plane of classification in D-brane and anti-Dbrane model for time series data.

Let us consider Hermitian product over section  $\mathbb{C}P^1$  of hyper-Kähler manifold. Let  $w \in A$  be support spinor  $w$  associated with a hyper-spinor plane  $H_w = \{w \in A | w^* = w\}$  as a source of existence of weight in optimal SSM,

$$\langle w, w \rangle = \sum_j \langle w, e_j^* \rangle \langle e_j, w \rangle. \quad (43)$$



We work on hidden space of time series data with induced dual Lagrangian  $L^*$  with free product over von Neumann algebras,

$$L^*(w^*, b^*, \alpha^*) \otimes_A L(w, b, \alpha). \quad (44)$$

We set extra parameter called a Lagrange multiplier  $\alpha_i = \frac{dg_{ij}}{dt}$  as a Jacobian flow of a extradimension of hidden space of time series  $X_t$  and we introduce  $\alpha_i^* = \frac{dg_{ij}^*}{dt}$  as a Jacobian flow of a extradimension of hidden space of time series  $X_t^*$ . The space of input data  $x_t \in X_t$  is endowed with  $T_0$ -separation over quotient topology of moduli space of induce a Teichmüller space in time series data with genus  $g = g_{ij}(x_t)$ . We use D-brane theory of double D-brane. One side of brane is a modelling time series data as classifying space with separation with non-Euclidean plane with negative curvature as geometrical meaning of SSM. If input data of feature space  $(x_i, y_i = 1)$ , we associate with what spinor machine do by using homotopy to deform underlying topological space (Riemann surface of time series data) to target Riemann sphere with positive curvature. We deform by Jacobian flow or derivative of Riemann metric tensor  $g_{ij}$  along parallel transport of Killing vector field.

If a curvature of the plane of classification of SSM is not zero, we deform moduli space to hyperbolic space with induced classification function for SSM classify with negative curvature  $g_{ij} = -1$

$$g_{ij} \langle w, x \rangle = - \langle w, x \rangle = \|w\| \cdot \|x\| \cosh d(w, x) \quad (45)$$

We normalized support spinor and input state vector to unit length in  $S^1$  according to our definition above, so we have a distance from complex plane,  $[w] \in H_0(X_t/Y_t)$  project to projective line by  $\langle w, x \rangle \in \mathbb{R}$  with  $\langle w, x \rangle := [\tan \theta_t] = \left[ \frac{w}{x} \right] \simeq \left[ \frac{\text{Im}(y_t)}{\text{Re}(y_t)} \right] \in \mathbb{C}P^1 \simeq S^2$ . Where  $[\text{Im}(y_t)]$ ,  $[\text{Re}(y_t)]$  are equivalent class of real as market cocycle and imaginary part as market boundary in cohomology theory in financial market. This scalar product has a Hermitian structure of complex projective space. We define a market cocycle over Hermitian product of section of Kähler manifold of financial market by

$$g'_{ij} := d(w, x) = \text{arccosh}(- \langle w, x \rangle). \quad (46)$$

We consider  $\partial_k g_{ij} = 0$  as a simple solution of an example of how to find a separated hyperplane of SSM over complex projective plane (see Fig. 5 for the projective hyperplane) with previous definition of  $\partial_k := \frac{\partial}{\partial \theta_{t+1}}$ . We will not compute all components of Riemannian curvature here, because the equation will be very cumbersome. We just want to shown the simple solution without the definition of Riemannian curvature of parallel translation of support vector along curves on a Kähler manifold.

Consider

$$\begin{aligned} \partial_k g'_{ij} &:= \frac{\partial}{\partial \theta_{t+1}} \text{arccosh}(- \langle w, x \rangle) = \\ &= \frac{1}{\sqrt{\langle w, x \rangle^2 - 1}} \frac{\partial}{\partial \theta_{t+1}} (- \langle w, x \rangle) = 0. \end{aligned} \quad (47)$$

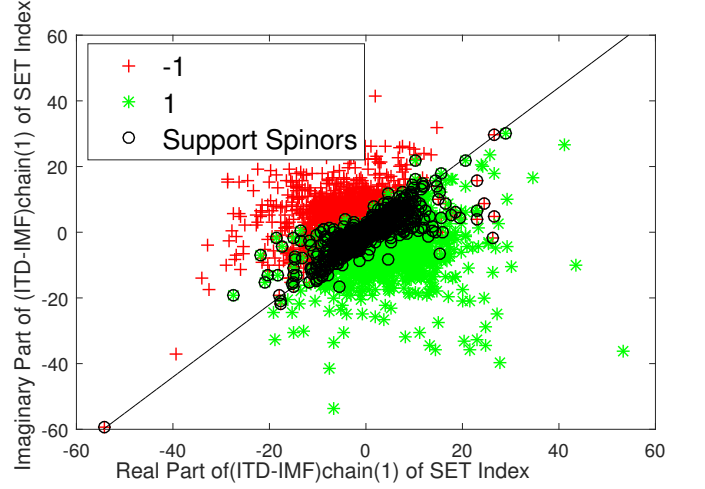

FIG. 6: The empirical analysis of SSM over complex plane  $(\text{ITD} - \text{IMF})\text{chain}_1$  of closed price for financial time series data of SET index in 9528 days from 02/05/1975 to 24/06/2014. The separated hyperplane between up and down state of  $y_t = \{-1, 1\}$  with linear kernel of HT-SSM is approximately a straight line cut unit cycle  $S^1$  at  $\frac{\pi}{4}$  and  $\frac{3\pi}{4}$ . This line separate the up state as the equivalent class of  $[1] := [2\pi] \in Y_1 := \pi_1(\mathbb{R}^2 - X_t)$  and the down state defined by the equivalent class of  $[-1] := [\pi]$ .

We have  $\langle y_t, x_t \rangle \in \left[ \frac{y_t}{x_t}, 1 \right] \simeq \langle w, x \rangle \in \mathbb{C}P^1 \simeq S^2$  so we approximate the scalar curvature of weight  $\langle w, x \rangle$  approximated by  $\langle y, x \rangle \in \mathbb{C}P^1$  since weight of SSM use for classifying  $y_t \in Y_t$ . We assume that the solution is perfect approximation. In the above scalar product of weight of SVM with parallel translation along curve in  $S^2$ , we induce a Riemannian curvature in SSM over principle bundle  $\mathbb{C}P^1$  of Kolmogorov space in time series data by

$$\begin{aligned} \frac{1}{\sqrt{\langle w, x \rangle^2 - 1}} \frac{\partial}{\partial \theta_{t+1}} (- \langle w, x \rangle) = \\ \frac{1}{\sqrt{\langle w, x \rangle^2 - 1}} \frac{\partial}{\partial \theta_{t+1}} (- \tan \theta) = 0. \end{aligned} \quad (48)$$

We get

$$(\langle w, x \rangle - 1)(\langle w, x \rangle + 1) = 0 \quad (49)$$

and  $\tan \theta = 0$ . We consider

$$\langle w, x \rangle \simeq \frac{w}{x} \simeq \tan \theta \simeq \frac{[\text{Im}(y_t)]}{[\text{Re}(y_t)]} \in \mathbb{C}P^1. \quad (50)$$

Since  $(\langle w, x \rangle - 1)(\langle w, x \rangle + 1) = 0$  we get an equivalent class of classification over degree of map in complex plane by given a simple example of solution a hyperplane with equivalent class of weight in spinor of SSM with solution in principle angle,

$$[\theta^*] = \arctan \frac{[\text{Im}(y_t)]}{[\text{Re}(y_t)]} = 0, \frac{\pi}{4}, \frac{3\pi}{4}, 2\pi. \quad (51)$$

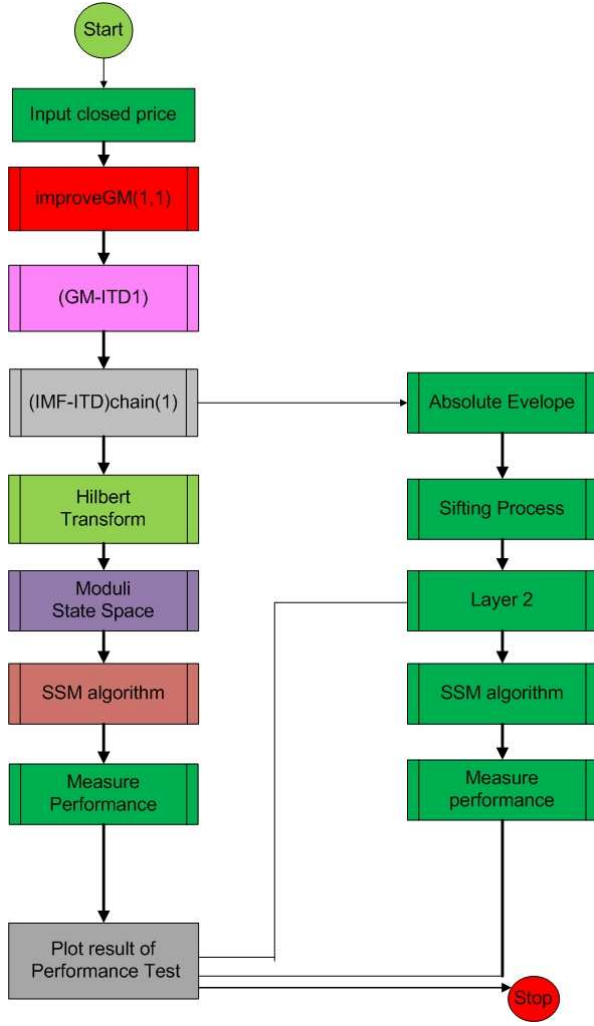

FIG. 7: The flowchart of all involved modules for the performance measuring between SSM and SVM in this work .

We choose an optimal separate hyperplane for SSM as a support spinor with degree  $[\theta^*] = [\frac{\pi}{4}]$ . The of result of empirical analysis for SSM is shown in Fig. 6.

### III. RESULT OF EMPIRICAL ANALYSIS

In this section we implement the SSM with the adaptive data analysis algorithm. The end points of time series data are classified after empirical mode decomposition into four states in observation state space model  $Y_t = Y_t([s_1], [s_2], [s_3], [s_4])$ . The hidden state space of behavior of trader  $X_t$  is in the complex projective space over second layer of the Holo-Hilbert spectral analysis with the amplitude modulation mode. We test the performance of the SSM to classify the state in financial time series data only for the up and down states with 6 different types of financial time series data (for details about the empirical test data see Table I). The performance of directional prediction for various kernels is compared

with the classical SVM methodology.

The sifting process of the empirical mode decomposition is one of an example of moduli state space model since mean of sifting process can be approximate by identity of an equivalent class over physiology of time series data  $[s_2] + [s_4] = [1] \simeq [s_3] + [s_1]$ . It is a moduli of mean in sifting process of intrinsic mode functions (IMF). The Holo-Hilbert transform of the result of (ITD – IMF)chain<sub>1</sub> (defined in [6]) to a complex plane is equivalent to the equivalent class of cohomology group in time series data in this work. The Holo-Hilbert algorithm renders a spinor field in higher extradimension. It is assumes that the result of 2nd-layer is an angle of support spinor field as a solution of the Eq. (30) in Definition 14.

In deep, the Holo-Hilbert transform is related with a new concept of cohomology sequence in extradimension of Kolmogorov space in time series data. Let  $x(t) \in \mathbb{R}$  be

$$x(t) = \text{Re} \sum_{j=1}^N a_j e^{i2\pi f_j t}, \quad (52)$$

The expansion above is based on an adaptive IMF basis, so we have [27]

$$x(t) = \sum_{j=1}^N c_j(t) = \text{Re} \sum_{j=1}^N a_j e^{i \int_t \omega_j(\tau) d\tau}, \quad (53)$$

The algorithm (Fig. 7) to find a Holo-Hilbert spectrum is iterative over a few steps:

1. Take the absolute value of the (ITD – IMF)chain<sub>1</sub>.
2. Identify all maxima of the absolute-valued function of (ITD – IMF)chain<sub>1</sub>.
3. Construct the envelope by a natural spline through all the maxima.
4. Do (ITD – IMF)chain<sub>1</sub> transform over the envelope of layer from the previous step.
5. Repeat step 1. again for the next layer of amplitude modulation process.

The procedure above is applied separately to the amplitude modulation (AM) and the frequency modulation. The result of Holo-Hilbert amplitude hidden layer is obtained as an extradimension presentation which we can use to detect market crash and classify next state of prediction. The nested expression for the amplitude function has the form

$$a_j(t) = \sum_k [\text{Re} \sum_l a_{jkl}(t) e^{i \int_t \omega_l(\tau) d\tau} \dots] e^{i \int_t \omega_k(\tau) d\tau}. \quad (54)$$

The Holo-Hilbert spectrum is a high-dimensional spectrum. The presentation is on the four layers AM spectra modulation for price prediction.

Stock index	Country	Data Set	Sample type	Size	Date	Date number
SET	Thailand	(1)	Out of sample test	651	26/06/2014 — 14/10/2016	9530–10181
		(2)	Training set	9529	02/05/1975 — 24/06/2014	1–9528
		(3)	Out of sample	31	26/06/2014 — 13/08/2014	9530–9560
RTS	Russia	(1)	Out of sample test	31	03/12/2015 — 20/01/2016	5019–5049
		(2)	Training set	5018	01/09/1995 — 02/12/2015	1–5018
		(3)	Out of sample	142	03/12/2015 — 01/07/2016	5019–5160
FBM KLCI	Malaysia	(1)	Out of sample test	99	03/03/2016 — 25/07/2016	8416–8514
		(2)	Out of sample test	31	03/03/2016 — 14/04/2016	8416–8446
		(3)	Training set	8415	04/03/1982 — 02/03/2016	1–8445
PSEi	Philippines	(1)	Out of sample test	31	03/03/2016 — 18/04/2016	7192–7222
		(2)	Training set	7191	02/03/1987 — 02/03/2016	1–7191
		(3)	Out of sample	99	03/03/2016 — 25/07/2016	7192–7290
JKSE	Indonesia	(1)	Out of sample test	31	25/02/2016 — 12/04/2016	6327–6358
		(2)	Training set	6356	06/04/1990 — 24/02/2016	1–6356
		(3)	Out of sample	96	25/02/2016 — 20/07/2016	6327–6422
STI	Singapore	(1)	Out of sample test	31	04/03/2016 — 20/04/2016	4145–4176
		(2)	Training set	4144	31/08/1999 — 03/03/2016	1–4144
		(3)	Out of sample	85	04/03/2016 — 04/07/2016	4145–4229

TABLE I: Table shows six different types of testing time series data for stock indexes of closed prices.

Stock index	Country	Days	Date	Kernel type	Performance SVM	SSM	Profit SVM	SSM	Improved performance
SET	Thailand	31	9530-9560	rbs(0.05)	43.33%	67.74%	-1.73	116.48	56.34%
			9530-9560	linear	33.33%	58.06%	-90.25	50.82	74.20%
RTS	Russia	31	5019-5049	rbs(0.05)	58.06%	67.74%	-27.65	113.55	16.67%
			5019-5049	linear	41.94%	61.29%	-62.41	64.71	46.13%
FBM KLCI	Malaysia	31	8416-8446	rbs(0.05)	56.25%	58.06%	19.80	22.25	3.22%
			8416-8446	linear	46.88%	38.71%	-36.96	-31.29	-17.49%
PSEi	Philippines	31	7192-7222	rbs(0.05)	48.39%	61.29%	-189.03	376.49	26.66%
			7192-7222	linear	41.94%	61.29%	-198.97	281.39	46.14%
JKSE	Indonesia	31	6327-6358	rbs(0.05)	54.84%	58.06%	100.72	129.25	5.87%
			6327-6358	linear	41.94%	61.30%	-129.25	187.36	46.19%
STI	Singapore	31	4145-4176	rbs(0.05)	48.39 %	48.39%	-25.31	62.89	0%
			4145-4176	linear	45.16%	46.67%	-33.99	-183.44	0.007%
Average					46.70%	57.38%	-56.25	98.71	25.33%

TABLE II: Table shows six different types of test time series data for stock indexes with SVM forecasting. The table reports the performance of SVM with different kernels in Euclidean plane.

### A. Result of Empirical Analysis of SSM and Holo Hilbert Spectrum

At first we compare the result of SSM with traditional SVM method. From the studies [40] follows that all stock indices around the world have similar statistical property, so called stylized fact [41] of long memory process. The performance test is therefor done on six different financial time series data of stock market closed prices, see Table I, which are the sample data for an analysis of country in-

stances [42] with SSM since all countries have the same rule for stock trading and the behaviors [43] of traders among all countries are quite similar behaviors. In order to see the different result of performance between SVM and SSM we set the number of sample size to the same size as 31 days. The result of computation shows that SSM gets better performance than SVM, see Table II. The average performance of one day ahead of directional prediction for out of sample test of SVM is just 46.70%, but for SSM we get 57.38%. The improved performance

Stock index	Country	Days	Date	Kernel type	Performance		Profit		Improved performance
					HT-SVM	HT-SSM	HT-SVM	HT-SSM	
SET	Thailand	31	9530-9560	rbs(0.05)	58.06%	67.74%	30.20	116.48	16.67%
			9530-9560	linear	51.61%	58.06%	-2.84	50.82	12.50%
RTS	Russia	31	5019-5049	rbs(0.05)	61.29%	67.74%	55.89	113.55	10.52%
			5019-5049	linear	51.61%	61.29%	46.67	64.71	18.76%
FBM KLCI	Malaysia	31	8416-8446	rbs(0.05)	54.84%	58.06%	-5.09	22.25	5.87%
			8416-8446	linear	41.94%	38.71%	-26.41	-31.29	-7.70%
PSEi	Philippines	31	7192-7222	rbs(0.05)	58.06%	61.29%	215.45	376.49	5.58%
			7192-7222	linear	45.16%	61.29%	-240.53	281.39	35.72%
JKSE	Indonesia	31	6327-6358	rbs(0.05)	70.97%	58.06%	495.90	129.25	-18.19%
			6327-6358	linear	58.06%	61.30%	169.22	187.36	5.58%
STI	Singapore	31	4145-4176	rbs(0.05)	45.16 %	48.39%	16.13	62.89	7.15%
			4145-4176	linear	44.44%	46.67%	-60.20	-183.44	5.02%
Average					53.43%	57.38%	57.45	98.71	8.12%

TABLE III: Table shows six different types of test time series data for stock indexes with one day ahead prediction of HT-(ITD-IMF)chain<sub>1</sub>-SSM methodology compared with HT-(ITD-IMF)chain<sub>1</sub>-SVM. The separation is done over the complex plane by using Hilbert transform. SSM has a better performance in directional one day ahead prediction than SVM.

Stock index	Country	Days	Date	Kernel type	Performance		Profit		Improved performance
					HT-SVM	HT-SSM	HT-SVM	HT-SSM	
SET	Thailand	651	9530-10181	rbs(0.01)	52.15%	54.62%	531.34	584.94	4.74%
			9530-10181	linear	48.77%	51.23%	30.5	298.06	5.04%
RTS	Russia	142	5019-5160	rbs(0.05)	49.30%	54.93%	117.62	299.88	11.42%
			5019-5160	linear	54.22%	50.70%	432.20	-17.06	-6.49%
FBM KLCI	Malaysia	99	8416-8514	linear	43.43%	47.47%	-106.60	13.32	9.30%
			8416-8514	rbs(0.01)	41.42%	53.54%	-115.90	100.34	29.26%
PSEi	Philippines	99	7192-7290	rbs(0.05)	53.53%	58.59%	-17.19	1342.53	9.45%
			7192-7290	linear	57.57%	57.57%	1381.27	1204.59	0%
JKSE	Indonesia	96	6327-6422	rbs(0.05)	59.37%	62.50%	735.46	731.66	3.13%
			6327-6422	linear	51.04%	60.42%	58.67	390.05	5.58%
STI	Singapore	85	4145-4229	rbs(0.05)	52.94%	49.41%	304.84	217.5	-6.67%
			4145-4229	linear	44.71%	50.59%	-205.16	-82.94	13.15%
Average					50.70%	54.29%	262.20	423.57	6.49%

TABLE IV: Table shows six different types of test time series data for stock indexes with one day ahead prediction of HT-(ITD-IMF)chain<sub>1</sub>-SSM methodology compared with HT-(ITD-IMF)chain<sub>1</sub>-SVM. The separation is done over the complex plane by using Hilbert transform. Again SSM has better performance in one day ahead directional prediction than SVM.

from SVM to SSM is approximately 25.33% for 31 days out of sample time series data. Next we can compare the performance of HT-SVM and HT-SSM methodology, see the results in Tables III, IV. The HT-SVM is a Hilbert transform of (ITD - IMF)chain<sub>1</sub> followed by SVM procedure. Similarly, the HT-SSM means a Hilbert transform of (ITD - IMF)chain<sub>1</sub> followed by SSM. The result of performance is tested again on six different types of time series data of stock closed prices. One can use different kernels and the same or longer date ranges than in the previous test. We confirm again that HT-SSM gets a better performance than HT-SVM. We test the per-

formance of directional prediction out of sample in 665 days of SET index. For interest, on our hardware configuration, it takes up to 3194.05 seconds (53.23 min.) for one input sample point to train HT-SSM algorithm. Therefore within 665 days out of sample, we used computational time more than a month to show the result of analysis of SET index in this work. For SVM, the running time takes only 93.93 seconds. The results of profit are shown in Fig. 8, we can conclude that HT-SVM shows better performance than traditional SVM (also for the case of HT-SSM and SSM).

Next we test the different types of financial time series

Rank	SET Symbol	Securities Name	SVM	Profit	SSM	Profit
1	ADVANC	ADVANCED INFO SERVICE	43.47%	-5	71.73%	225
2	AOT	AIRPORTS OF THAILAND	41.43%	-10.9	51.44%	30
3	BANPU	BANPU	36.23%	1.45	47.10%	12.9
4	BAY	BANK OF AYUDHYA	48.55%	0.00	38.41%	8.0
5	BBL	BANGKOK BANK	37.68%	-26.5	36.23%	7.0
6	BCP	THE BANGCHAK PETROLEUM	44.20%	3.5	51.45%	27.75
7	BEC	BEC WORLD	41.30%	-2.5	42.02%	9.0
8	BDMS	BANGKOK DUSIT MEDICAL SERVICES	44.93%	-0.6	60.14%	12.4
9	BH	BUMRUNGRAD HOSPITAL	44.43%	-0.6	64.49%	255.0
10	BIGC	BIG C SUPERCENTER	36.93%	-29	50.72%	72.0
11	BTS	BTS GROUP HOLDINGS	42.75%	0.55	49.27%	3.6
12	CPALL	CP ALL	36.23%	-15	48.55%	20
13	CPF	CHAROEN POKPHAND FOODS	34.78%	-1.6	45.65%	6.6
14	CPN	CENTRAL PATTANA	49.27%	11.75	49.27%	13.75
15	DELTA	DELTA ELECTRONICS (THAILAND)	44.93%	13.75	60.87%	114.75
16	EGCO	ELECTRICITY GENERATING	43.48%	6	57.25%	81
17	GLOW	GLOW ENERGY	46.37%	6	63.77%	115.25
18	HMPRO	HOME PRODUCT CENTER	40.58%	-0.39	54.35%	5.09
19	IRPC	IRPC	39.85%	-1.18	42.03%	0.04
20	KBANK	KASIKORNBANK	36.95%	-2	38.40%	-70
21	KKP	KIATNAKIN BANK	39.13%	0.75	42.03%	35
22	KTB	KRUNG THAI BANK	47.10%	7	51.45%	8
23	LH	LAND AND HOUSES	42.05%	0.8	45.65%	3.45
24	MAKRO	SIAM MAKRO	31.88%	1	36.23%	13
25	MINT	MINOR INTERNATIONAL	51.43%	13	56.24%	24.93
26	PS	PRUKSA REAL ESTATE	40.58%	0.25	63.77%	35.95
27	PTT	PTT	42.75%	52	49.28%	172.00
28	PTTEP	PTT EXPLORATION AND PRODUCTION	40.58%	-34	35.51%	-78
29	RATCH	RATCHABURI ELECTRICITY GENERATING HOLDING	39.13%	-1.5	50.00%	2.6
30	ROBINS	ROBINSON DEPARTMENT STORE	43.48%	-2.25	48.55%	11
31	SCB	THE SIAM COMMERCIAL BANK	49.27%	47	28.26%	-97
32	SCC	THE SIAM CEMENT	50.00%	16	55.07%	18.40
33	SCCC	SIAM CITY CEMENT	43.48%	105	51.45%	103
34	SSI	SAHAVIRIYA STEEL INDUSTRIES	18.00%	-0.6	32.60%	0.24
35	STA	SRI TRANG AGRO-INDUSTRY	39.10%	3	47.10%	8.6
36	TCAP	THANACHART CAPITAL	36.97%	2	51.44%	11.5
37	THAI	THAI AIRWAYS INTERNATIONAL	38.40%	1.9	36.23%	-1.8
38	TMB	TMB BANK	37.68%	0.3	52.89%	2.22
39	TOP	THAI OIL	40.48%	-8.25	44.92%	6.25
40	TPIPL	TPI POLENE	47.83%	0.37	53.62%	2.88
41	TRUE	TRUE CORPORATION	44.20%	-0.6	50.00%	7.4
42	TU	THAI UNION GROUP	39.13%	-0.53	63.00%	25.8
Average performance and sum of profit			38.55%	158.91	44.21%	1234

TABLE V: Table shows 42 stocks in SET50 Index Futures of Thai stock market. The training data with (ITD – IMF)chain<sub>1</sub> transformation have run in out of sample for 2000 trading days over close price between the dates 23/08/2007 to 29/10/2015. An out of sample test set for SVM with linear kernel has run over 138 days between 19/08/2014 to 10/03/2015. An out of sample test set for SSM with linear kernel has run over 138 days between 09/04/2015 to 02/11/2015. The better performance of SSM vs. SVM is evident from the empirical result of one day ahead directional forecasting.

data. We choose a sample set of closed prices of 42 stocks underlying SET50 Index Futures as shown in Table V.

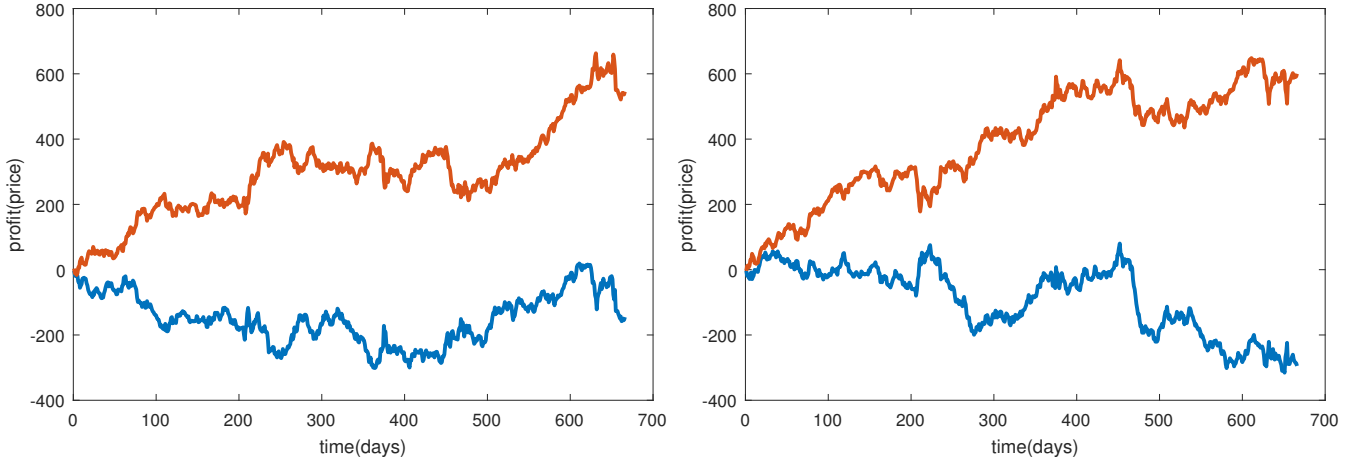

FIG. 8: On the left: The comparison between the performance of SVM (blue) and SVM with Hilbert transform of  $(ITD - IMF)chain_1$  (red) with the linear kernel of SVM. The performance of HT-SVM is 51.28% with profit 485.86, the performance of traditional SVM is 49.77% with lost  $-145.34$ . On the right: The comparison between the performance of SSM (blue) and SSM with Hilbert transform of  $(ITD - IMF)chain_1$  (red). We used rbs kernel(0.001) for HT-SSM, with the performance of directional prediction 55.19% and the profit 606.84. The blue line describes classical SVM with rbs kernel(0.05) with the performance of directional prediction just 47.67% with the lost  $-294$ . For both cases the SET data are run out of sample in one day ahead directional prediction for 665 trading days starting from 26/6/2014 to 2/11/2016.

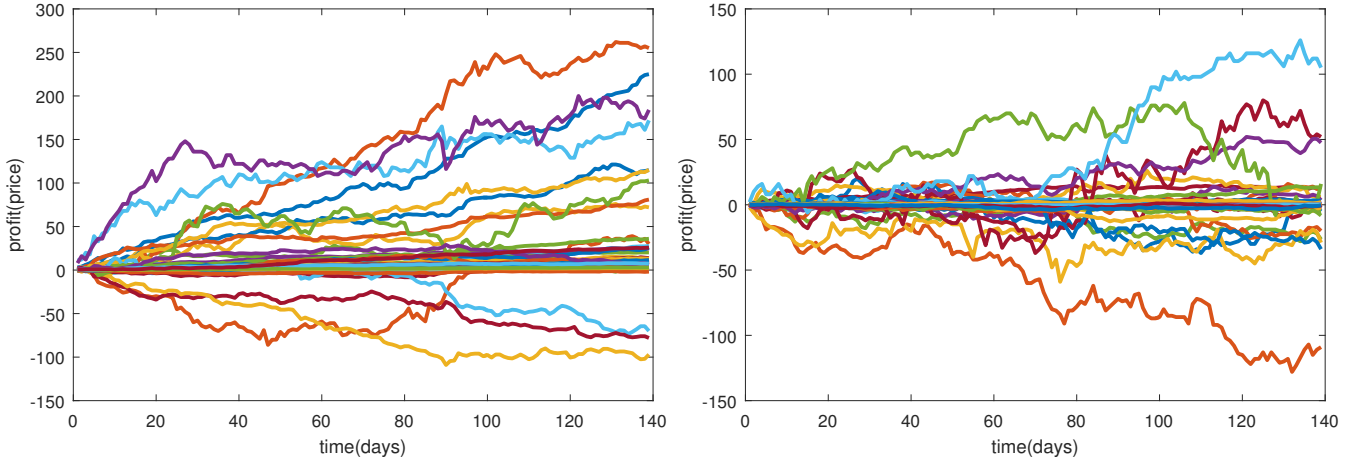

FIG. 9: The profit of 42 stocks in SET50 Index Futures for SSM and SVM according Table V. The data run out of sample in one day ahead directional prediction for 138 days and trained with 2000 days starting from 23/08/2007 to 29/10/2015. On the left: The profit of one day ahead directional prediction for SSM with a linear kernel and Hilbert transform of  $(ITD - IMF)chain_1$ . The color lines are the earning prices after trading with the result of directional prediction. The average performance of SSM is just 44% because of too short number of training days, but the sum of profit of within 138 days is 1234 points. On the right: The profit of one day ahead directional prediction for SVM with a linear kernel without  $(ITD - IMF)chain_1$ .

The result of profit after directional prediction of SSM compared with SVM within 138 trading days are shown in Fig. 9. The result for a profit of the first stock, namely ADVANC, is shown in Fig. 10. According to the empirical analysis of a sample set of closed prices, we found that for this particular data set of 42 stocks, SSM shows better average performance in directional prediction of time series than SVM. The average performance of SSM in our empirical data set is 44.21% in comparison with SVM which has only 38.55%. The average profit of SSM 1234 is also higher than SVM one with 158.91 points.

The general statements about SSM performance require detailed studies of more stock markets. Such studies are beyond the scope of this paper, however, the received results constitute a very useful ingredient for them.

We check the performance of SSM with Hilbert transform of  $(ITD - IMF)chain_1$  also with russian stock market RTS, which also confirm the conclusion that HT-SSM outperforms SVM method. The results are presented in Fig. 11 with the performance of HT-SSM 54.93% with the profit price 299.88 in 142 trading days.

Finally, we implement the algorithm of SSM over Holo-

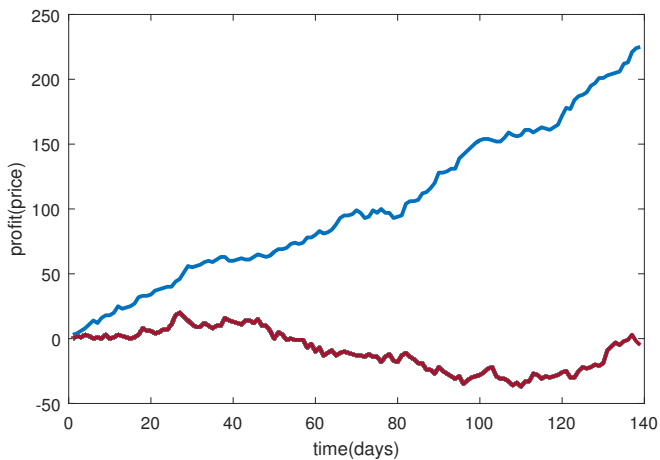

FIG. 10: The profit of one day ahead directional prediction for the first SET50 stock, namely ADVANCE. SSM is a linear kernel of closed price with  $(ITD-IMF)_{chain_1}$  in blue line and without  $(ITD-IMF)_{chain_1}$  in red line. The data are run out of sample in directional prediction one day ahead within 138 days and trained with data from 23/08/2007 to 29/10/2015 with 2000 trading days.

Hilbert analysis of AM modulation of  $(ITD-IMF)_{chain_1}$  with SET index. The result of prediction is activated when time series data are in nonstationary state. It will generate signal of time series prediction two days ahead in directional prediction up or down with respect to the previous days. The empirical analysis with performance measuring is reported in Table VI. The result of 100 days of 2nd layer Holo-Hilbert spectral FM mode of SET index and a performance test of comparison with HT-SSM are shown in Fig. 12.

#### IV. DISCUSSION AND CONCLUSION

We extend support vector machine to support spinor machine by using mathematical structure of spinor field and tensor product over vector space. We define a support spinor from second cohomology group of moduli state space model in time series data.

We demonstrate the simple calculation of time series classification of SSM over  $T_0$ -separation axiom. We define a tensor field in financial time series data and obtain a spinor field from coupling states between them. We finally prove that the separate hyperplane of SSM is separated by using degree with  $\frac{\pi}{4}$ . We propose the equation of connection over Killing vector field in time series data. The solution of equation so called support Dirac machine is a weight of SSM. The equivalent class of weight of SSM can be written by integral over second cohomology group in time series data. We prove the existence of  $T_0$ -separation criterion for SSM, different from  $T_2$ -separation of SVM in which two similar points of time series data can not be separated.

We report the empirical analysis performed with SSM

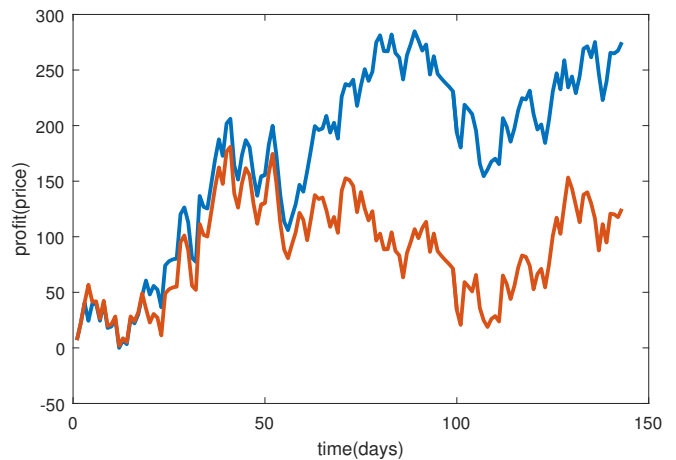

FIG. 11: The profit of one day ahead directional prediction over out of sample 142 data set of closed price between 03/12/2015 to 01/07/2016 for Russian stock market. SSM with Hilbert transform HT-SSM (blue) and SVM with Hilbert transform HT-SVM (red) are with rbs kernel parameter set to 0.05. The performance of HT-SSM is 54.93% with profit price 299.88 in 142 trading days.

and SVM, which confirms the better performance of SSM than SVM over six testing time series data from six different countries. We implement an algorithm of SSM over Holo-Hilbert analysis of AM. The result of extradimension of amplitude modulation confirms the existence of moduli state space model of time series data. We implement algorithm of SSM by using Holo-Hilbert amplitude modulation mode for fully nonlinear and nonstationary time series data analysis. The result of analysis of hidden second layer can be used to predict market state of one day ahead with very high accuracy in comparison to typical SVM classification over state of end point in time series data. We compare the AM mode with Holo-Hilbert strategy, the AM mode strategy shows better results than HT-SVM and HT-SSM. It is also used to make two days ahead prediction with 71.68% performance. The HT-SSM is just about 57% and SVM is about 46.70%. The empirical analysis is done with out of sample test for all three strategies.

The SSM method promises a better performance than SVM. Although SVM is based on linear and nonlinear classifier with stationary signal processing data, there is no evidence that SVM can be used for nonstationary signal processing data efficiently or not. The nonlinear and nonstationary signal processing data have more geometric general property than linear and stationary signal processing data for which SVM is widely use. There are many types of nonlinear and nonstationary signal processing data and financial time series data are only one type of them. Another types are data measured from stress tensor and tensor based visualizing image processing data from Video Share (VDO) streaming, by nature based on mathematical structure of tensor field and spinor field and thereafter more suitable for SSM than

Date number	Number	Closed price	LH(2)-AM-SSM	Result	Profit	SM(rbs, 0.01)	State
9529	1	1276.84	up(forecast 9531)	correct	14.99	up(correct,+3.41)	
9530	2	1280.25	up(forecast 9532)	correct	1.25	up(correct,+14.99)	
9531	3	1295.24	up(forecast 9533)	wrong	-5.83	up(correct,+1.25)	
9532	4	1296.49	up(forecast 9534)	correct	5.59	up(wrong,-5.83)	
9533	5	1290.66	up(forecast 9535)	correct	17.81	up(correct,+5.59)	entanglement, [s4]
9534	6	1296.25	down(forecast 9536)	correct	2.19	up(correct,+17.81)	
9535	7	1314.06	up(forecast 9537)	correct	20.50	up(wrong,-2.19)	
9536	8	1311.87	down(forecast 9538)	wrong	-6.16	up(correct,+20.50)	
9537	9	1332.37	down(forecast 9539)	correct	5.21	up(wrong,-6.16)	
9538	10	1326.21	up(forecast 9540)	wrong	-17.02	up(wrong, -5.21)	normal, [s3]
9539	11	1321.00	up(forecast 9541)	correct	0.23	up(wrong,-17.02)	
9540	12	1303.98	up(forecast 9542)	wrong	-2.83	up(correct, 0.23)	
9541	13	1304.21	up(forecast 9543)	correct	2.50	up(wrong, -2.83)	
9542	-	1301.38	no signal	-			entanglement, [s2]
9543	14	1303.88	up(forecast 9545)	correct	13.43	up(correct, 0.74)	
9544	15	1304.62	up(forecast 9546)	correct	7.28	up(correct, 13.43)	
9545	16	1318.05	up(forecast 9547)	correct	13.88	up(correct,7.28)	
9546	17	1325.33	up (forecast 9548)	correct	6.61	up(correct,13.88)	
9547	18	1339.21	up(forecast 9549)	correct	5.82	up(correct, 6.61)	
9548	19	1345.82	down(forecast 9550)	wrong	-0.57	up(correct,5.82)	entanglement, s[1]
9549(-9558)	-	1351.64	no signal	-			
Performance		14/19		71.68%	84.88	68.42% (71.81), 13/19	
9571	20	1392.01	up(forecast 9573)	correct	2.68	up(wrong,-12.67)	
9572	-	1379.34	no signal	-			
9573	-	1382.02	no signal	-			
9574	21	1389.56	up(forecast 9576)	correct	12.68	up(wrong,-0.40)	
9575	22	1389.16	up(forecast 9577)	correct	6.94	up(correct,12.68)	
9576	-	1401.84	no signal	-			
9577	23	1408.78	up(forecast 9579)	correct	3.89	up(correct,0.40)	
9578	24	1409.18	up(forecast 9580)	correct	1.98	up(correct, 3.89)	
9579	25	1413.07	up(forecast 9581)	correct	8.34	up(correct, 1.98)	
Performance		20/25		80%	121.39	68% (77.69), 17/25	
9580	26	1415.05	up(forecast 9582)	wrong	-0.72	up(correct,8.34)	
9581	-	1423.39	no signal	-			
9582	-	1422.67	no signal	-			entanglement, [s3]
9583	27	1408.16	up(forecast 9585)	correct	1.10	up(wrong,-14.51)	
9584(-9589)	-	1411.23	no signal	-			
9590	28	1379.02	up(forecast 9592)	wrong	-2.23	up(wrong,-1.65)	entanglement, [s2]
9591	29	1377.37	down(forecast 9593)	wrong	-20.89	up(wrong,-2.23)	
9592	-	1375.14	no signal	-			entanglement, [s4]
9593	-	1396.03	no signal	-			
9594	30	1395.21	up(forecast 9596)	correct	5.37	up(correct,+10.05)	
9595	-	1405.26	no signal	-			
9596(-9602)	-	1410.63	no signal	-			
9603	31	1402.79	up(forecast 9605)	correct	7.22	up(correct,5.72)	
Performance		23/31		74.19%	111.24	64.51% (83.41), 20/36	
9604(-9606)	-	1408.51	no signal	-			
9607	32	1415.73	up(forecast 9609)	correct	3.76	up(wrong,-4.84)	
9608(-9610)	-	1449.40	no signal	-			
9611	33	1457.30	down(forecast 9613)	correct	5.48	up(correct,11.89)	
9612	-	1469.19	no signal	-			
9613	-	1463.71	no signal	-			
9614	34	1457.02	up(forecast 9616)	correct	6.69	up(wrong,-1.00)	
9615	-	1456.02	no signal	-			
9616	35	1471.85	down(forecast 9618)	correct	19.66	up(wrong,-0.83)	
9617	-	1471.02	no signal	-			
9618	36	1451.36	up (forecast 9620)	correct	5.38	up(correct,10.55)	
Performance		28/36		77.78%	152	60.00% (172.45), 22/36	

TABLE VI: Table shows the performance for two day ahead directional prediction by using AM-mode over 2nd layer of Holo-Hilbert transform of (ITD – IMF)chain<sub>1</sub> prediction method of SSM.

SVM. The algorithms based on SSM can replace SVM in cybernetics and electronics, it can be used for program-



ming the robots and autonomic systems and completely replace SVM and neural networks.

### Acknowledgment

K. Kanjamapornkul is supported by the scholarship from the 100th Anniversary Chulalongkorn University

Fund for Doctoral Scholarship. The work was supported by Dean of Faculty of Engineering under the collaboration between Chulalongkorn University and SAS. The work was partly supported by the grants VEGA 2/009/16, 2/0153/17 and APVV-0463-12. R. Pinčák would like to thank the TH division in CERN for hospitality.

- 
- [1] Andrea Loi and Stefano Matta. On the topology of the set of critical equilibria. *International Journal of Economic Theory*, 12(2):107–126, 2016.
- [2] Isaiiah Andrews and Anna Mikusheva. A geometric approach to nonlinear econometric models. *Econometrica*, 84(3):1249–1264, 2016.
- [3] R. Pinčák and E. Bartos. with string model to time series forecasting. *Physica A: Statistical Mechanics and its Applications*, 436:135 – 146, 2015.
- [4] D. Horváth and R. Pinčák. From the currency rate quotations onto strings and brane world scenarios. *Physica A: Statistical Mechanics and its Applications*, 391(21):5172 – 5188, 2012.
- [5] C. Cortes and V. Vapnik. Support-vector networks. *Machine Learning*, 20(3):273–297, 1995.
- [6] K. Kanjamapornkul and R. Pinčák. Kolmogorov space in time series data. *Mathematical Methods in the Applied Sciences*, 2016.
- [7] K. Kanjamapornkul, Richard Pinčák, and Erik Bartoš. The study of thai stock market across the 2008 financial crisis. *Physica A: Statistical Mechanics and its Applications*, 462:117 – 133, 2016.
- [8] Y. Lecun, Y. Bengio, and G. Hinton. Deep learning. *Nature*, 521(7553):436–444, 2015.
- [9] J. Schmidhuber. Deep learning in neural networks: An overview. *Neural Networks*, 61:85–117, 2015.
- [10] H. Shi, X. Zhao, L. Zhen, and L. Jing. Twin bounded support tensor machine for classification. *International Journal of Pattern Recognition and Artificial Intelligence*, 30(1), 2016.
- [11] Reshma Khemchandani, Pooja Saigal, and Suresh Chandra. Improvements on -twin support vector machine. *Neural Networks*, 79:97 – 107, 2016.
- [12] S. Buchholz and G. Sommer. On clifford neurons and clifford multi-layer perceptrons. *Neural Networks*, 21(7):925–935, 2008.
- [13] J. Zhu and J. Sun. Global exponential stability of clifford-valued recurrent neural networks. *Neurocomputing*, 173:685–689, 2016.
- [14] Y. Chen, K. Wang, and P. Zhong. One-class support tensor machine. *Knowledge-Based Systems*, 96:14–28, 2016.
- [15] X. Guo, X. Huang, L. Zhang, L. Zhang, A. Plaza, and J. A. Benediktsson. Support tensor machines for classification of hyperspectral remote sensing imagery. *IEEE Transactions on Geoscience and Remote Sensing*, 2016.
- [16] Masaki Kobayashi. Rotational invariance of quaternionic hopfield neural networks. *IEEJ Transactions on Electrical and Electronic Engineering*, 11(4):516–520, 2016.
- [17] R. Wang, X. Zhang, and W. Cao. Clifford fuzzy support vector machines for classification. *Advances in Applied Clifford Algebras*, 26(2):825–846, 2016.
- [18] A. Madhavan and G. Sofianos. An empirical analysis of nyse specialist trading. *Journal of Financial Economics*, 48(2):189–210, 1998.
- [19] L. Ji and A. Papadopoulos. Historical development of teichmüller theory. *Archive for History of Exact Sciences*, 67(2):119–147, 2013.
- [20] Daniel Alpay, M. Elena Luna-Elizarrarás, and Michael Shapiro. Kolmogorov’s axioms for probabilities with values in hyperbolic numbers. *Advances in Applied Clifford Algebras*, pages 1–17, 2016.
- [21] M. Bundzel, T. Kasanický, and R. Pinčák. Using string invariants for prediction searching for optimal parameters. *Physica A: Statistical Mechanics and its Applications*, 444:680–688, 2016.
- [22] R. Pinčák and E. Bartoš. With string model to time series forecasting. *Physica A: Statistical Mechanics and its Applications*, 436:135–146, 2015.
- [23] R. Pincak. The string prediction models as invariants of time series in the forex market. *Physica A: Statistical Mechanics and its Applications*, 392(24):6414–6426, 2013.
- [24] M. Bundzel, T. Kasanický, and R. Pincak. Experimental analysis of the prediction model based on string invariants. *Computing and Informatics*, 32(6):1131–1146, 2013.
- [25] V. Vapnik. Learning hidden information: Svm+. page 22, 2006.
- [26] N.E. Huang, Z. Shen, S.R. Long, M.C. Wu, H.H. Snin, Q. Zheng, N.-C. Yen, C.C. Tung, and H.H. Liu. The empirical mode decomposition and the hubert spectrum for nonlinear and non-stationary time series analysis. *Proceedings of the Royal Society A: Mathematical, Physical and Engineering Sciences*, 454(1971):903–995, 1998.
- [27] N.E. Huang, K. Hu, A.C.C. Yang, H.-C. Chang, D. Jia, W.-K. Liang, J.R. Yeh, C.-L. Kao, C.-H. Juan, C.K. Peng, J.H. Meijer, Y.-H. Wang, S.R. Long, and Z. Wu. On holo-hilbert spectral analysis: A full informational spectral representation for nonlinear and non-stationary data. *Philosophical Transactions of the Royal Society A: Mathematical, Physical and Engineering Sciences*, 374(2065), 2016.
- [28] M. Potters, R. Cont, and J.-P. Bouchaud. Financial markets as adaptive systems. *Europhysics Letters*, 41(3):239–244, 1998.
- [29] N.E. Huang and Z. Wu. A review on hilbert-huang transform: Method and its applications to geophysical studies. *Reviews of Geophysics*, 46(2), 2008.
- [30] H. Drucker, C.J.C. Surges, L. Kaufman, A. Smola, and V. Vapnik. Support vector regression machines. *Advances in Neural Information Processing Systems*, pages 155–161, 1997.

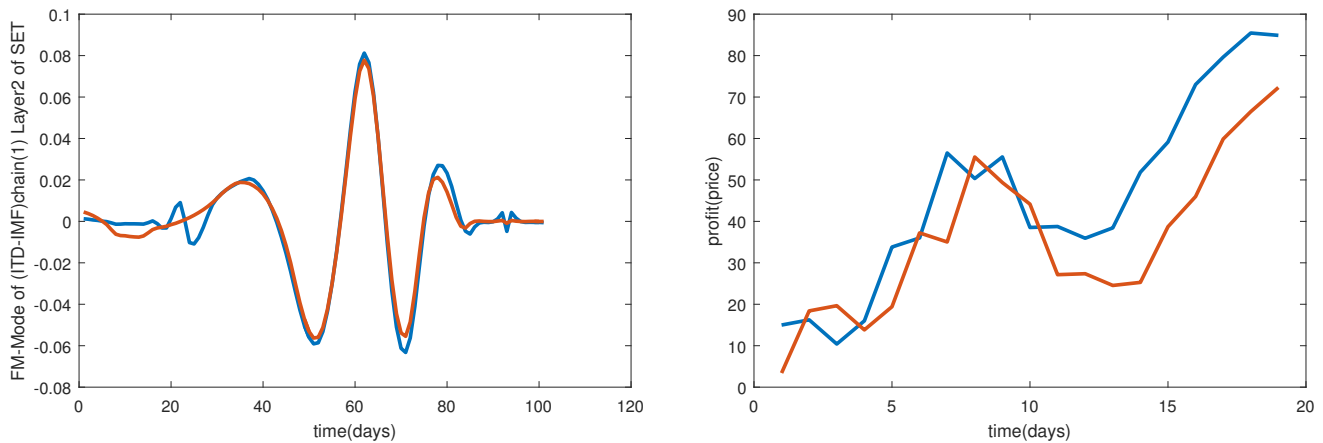

FIG. 12: On the left: The FM mode of 2nd layer of (ITD – IMF)chain<sub>1</sub> for SET index in 9539 days (red) and in 9544 days (blue). The shape of frequency shows the stationary state of the last 100 days with normal state in up direction with two days ahead prediction of frequency. On the right: The performance between two day ahead of Holo-Hilbert AM mode of 2nd layer with SSM price forecasting with highest profit 78.94% within 19 days out of sample. The result of one day ahead of Holo-Hilbert AM mode of 2nd layer forecasting with highest profit also 78.94% within 19 days out of sample. The HT-SSM has lower performance with 73.68%. All three strategies earn profit from the stock market. The highest profit is for two day ahead of Holo-Hilbert AM mode of 2nd layer with the value of 112, HT-SSM can earn only 78.26.

- [31] R.N. Mantegna and H.E. Stanley. Scaling behaviour in the dynamics of an economic index. *Nature*, 376(6535):46–49, 1995.
- [32] P. F. Verdes, P. M. Granitto, H. D. Navone, and H. A. Ceccatto. Nonstationary time-series analysis: Accurate reconstruction of driving forces. *Phys. Rev. Lett.*, 87:124101, Sep 2001.
- [33] Guillermo L. Grinblat, Lucas C. Uzal, Pablo F. Verdes, and Pablo M. Granitto. Nonstationary regression with support vector machines. *Neural Computing and Applications*, 26(3):641–649, Apr 2015.
- [34] L. J. Mordell. Review: Serge lang, diophantine geometry. *Bull. Amer. Math. Soc.*, 70(4):491–498, 07 1964.
- [35] C.-A. Popa. Lie algebra-valued hopfield neural networks. pages 212–215, 2015.
- [36] W. S. Massey. *A Basic Course in Algebraic Topology*. Undergraduate Texts in Mathematics. Springer New York, 1997.
- [37] Ralph L. Cohen. *The Topology of Fiber Bundles Lecture Notes*, 1998. Stanford University.
- [38] E.R. Phillips. Karl m. peterson: The earliest derivation of the mainardi-codazzi equations and the fundamental theorem of surface theory. *Historia Mathematica*, 6(2):137–163, 1979.
- [39] V.T. Fomenko. A general formula of the solutions of the peterson-codazzi equations on a hypersphere. *Journal of Soviet Mathematics*, 59(2):777–779, 1992.
- [40] R.N. Mantegna and H.E. Stanley. Scaling behaviour in the dynamics of an economic index. *Nature*, 376(6535):46–49, 1995.
- [41] R. Cont. Empirical properties of asset returns: Stylized facts and statistical issues. *Quantitative Finance*, 1(2):223–236, 2001.
- [42] P. Gopikrishnan, V. Plerou, L.A. Nunes Amaral, M. Meyer, and H.E. Stanley. Scaling of the distribution of fluctuations of financial market indices. *Physical Review E - Statistical Physics, Plasmas, Fluids, and Related Interdisciplinary Topics*, 60(5 A):5305–5316, 1999.
- [43] K. Daniel, D. Hirshleifer, and A. Subrahmanyam. Investor psychology and security market under- and over-reactions. *Journal of Finance*, 53(6):1839–1885, 1998.