

# Application of Compressive Sensing Techniques in Distributed Sensor Networks: A Survey

Thakshila Wimalajeewa, *Senior Member, IEEE* and Pramod K Varshney, *Life Fellow, IEEE*

**Abstract**—In this survey paper, our goal is to discuss recent advances of compressive sensing (CS) based solutions in wireless sensor networks (WSNs) including the main ongoing/recent research efforts, challenges and research trends in this area. In WSNs, CS based techniques are well motivated by not only the sparsity prior observed in different forms but also by the requirement of efficient in-network processing in terms of transmit power and communication bandwidth even with non-sparse signals. In order to apply CS in a variety of WSN applications efficiently, there are several factors to be considered beyond the standard CS framework. We start the discussion with a brief introduction to the theory of CS and then describe the motivational factors behind the potential use of CS in WSN applications. Then, we identify three main areas along which the standard CS framework is extended so that CS can be efficiently applied to solve a variety of problems specific to WSNs. In particular, we emphasize on the significance of extending the CS framework to (i), take communication constraints into account while designing projection matrices and reconstruction algorithms for signal reconstruction in centralized as well in decentralized settings, (ii) solve a variety of inference problems such as detection, classification and parameter estimation, with compressed data without signal reconstruction and (iii) take practical communication aspects such as measurement quantization, physical layer secrecy constraints, and imperfect channel conditions into account. Finally, open research issues and challenges are discussed in order to provide perspectives for future research directions.

**Index Terms**—Wireless sensor networks, Data gathering, Distributed inference, Data compression, Compressive sensing (CS), Distributed/decentralized CS, Fading channels, Physical layer secrecy, Compressive detection, Compressive classification, Quantized CS

## I. INTRODUCTION

Over the last two decades, the wireless sensor network (WSN) technology has gained increasing attention by both the research community and actual users [1]–[5]. Applications of WSNs span a wide range including environmental monitoring and surveillance [6], [7], detection and classification [8]–[11], target/object tracking [12]–[16], industrial applications [17], [18], and health care [19] to name a few. In addition to domain specific and task-oriented applications, WSN technology has been identified as one of the key components in designing future Internet of Things (IoT) platforms [20], [21].

A typical sensor network consists of multiple sensors of the same or different modalities/types deployed over a geo-

graphical area for monitoring a phenomenon of interest (PoI). Once deployed, the distributed sensors are required to form a connected network without a backbone infrastructure as in cellular networks. Most of the sensors are power constrained since they are equipped with small sized batteries which are difficult or impossible to be replaced especially in hostile environments. At the same time, the available (limited) communication bandwidth needs to be efficiently used while exchanging information for efficient fusion. Thus, sensor networks are inherently resource constrained and they starve for energy and communication efficient protocols [1], [22]. While distributed sensor fusion under resource constraints has been a research topic investigated for decades, the emergence of new sensors of different modalities that are capable of generating huge amounts of data in heterogeneous environments makes real-time fusion increasingly challenging [23]–[25]. Thus, desirable (or lossless) data compression is very important in designing WSNs for task-oriented as well as IoT based information systems.

Advances in compressive sensing (CS) have led to novel ways of thinking about approaches to design energy efficient WSNs with low cost data acquisition. CS has emerged as a promising paradigm for efficient high dimensional sparse signal acquisition. In the CS framework, a high dimensional signal can be reliably recovered with a small number of random projections under certain conditions if the signal of interest is sufficiently sparse [26]–[29]. In particular, compression is a simple linear operation implemented using random projection matrices which is independent of the signal parameters. In order to reconstruct the original high dimensional signal from its compressed version, several reconstruction techniques have been proposed where each one is different from the other in terms of their recovery performance and computational complexity [30]–[33].

CS is well motivated for a variety of WSN applications due to several reasons. Due to inherently scarce energy and communication resources in WSNs, data compression prior to transmission within WSNs is vital. On the other hand, sparsity is a common characteristic of many signals of interest that can be observed in various forms/dimensions. Thus, an immediate use of CS in WSNs is data gathering with reduced rate samples, as required by many environment and infrastructure monitoring applications. CS based data gathering may either exploit temporal, and/or spatial sparsity. Signal reconstruction with compressed data in CS was initially developed for a single measurement vector (SMV) which was later extended to estimate multiple sparse signals sharing joint structures using multiple measurement vectors (MMVs) [34], [35]. Direct use

of CS with SMV or MMVs may not be desirable due to communication constraints and specific application requirements in large scale WSNs. In particular, recent extensions and modifications of CS to cope with communication/energy constraints and variations of sensor readings can be exploited to better utilize CS based techniques in WSNs. These extensions/modifications beyond the standard SMV/MMV include the design of adaptive and sparse projection matrices to compress data at distributed nodes while meeting the desired communication constraints, and distributed and decentralized solutions for signal reconstruction considering different network models.

The simple and universal low rate data acquisition scheme provided by CS enables the design of new approaches to solve a variety of inference problems by suitable fusion of WSN data. In solving inference problems with compressed data, complete signal reconstruction, as employed in the standard CS framework, may not be necessary. Instead, constructing a decision statistic directly in the compressed domain is sufficient to make a reliable inference decision, for example, in intruder detection, early detection of natural disasters in smart environments, estimation of parameters such as energy radiated by cell stations in smart cities, and object tracking. Moreover, when applying CS techniques to perform different tasks in WSNs, their robustness in the presence of issues such as fading channels, physical layer secrecy concerns and quantization needs to be understood. This is because, the desirable conditions need to be satisfied by the standard CS framework can be violated under such practical aspects. Thus, to make CS ideas practically implementable for different tasks in a variety of WSN applications, above mentioned factors beyond the standard CS framework need to be understood. Over the last several years, there has been extensive research efforts in this direction.

#### A. Overview of the Current Paper

The goal of this review paper is to discuss in some detail how the extensions and modifications done to the original CS framework can be utilized to solve a variety of problems in WSNs under practical considerations. Our review is based on the following classification of existing work. We believe that this classification allows us to gather most of the recent modifications/extensions to the CS framework to meet WSN specific objectives and would provide the reader a comprehensive understanding on the use of CS in WSN specific applications. In particular, our discussion covers:

- i) Extensions of the CS framework to operate under communication constraints for data gathering considering
  - form of sparsity exploited: temporal, spatial, spatio-temporal
  - data acquisition/collection techniques: sparse, adaptive, and structured projection matrices, single-hop and multi-hop data collection
  - reconstruction techniques: centralized, and decentralized implementation of different reconstruction algorithms including optimization based, greedy/iterative and Bayesian algorithms

- ii) Extensions of the CS framework to solve a variety of inference problems without signal reconstruction including
  - detection, classification, parameter estimation, source localization, and sensor management
- iii) Incorporation of practical communication issues into the CS framework including
  - channel fading
  - physical layer secrecy constraints and
  - quantization
- iv) Lessons learned and future directions.

In the following, we discuss the most related existing review/survey papers and highlight the contribution of the current paper compared to the existing papers.

#### B. Comparison with Related Survey/Review Articles

CS ideas have gained significant interest in a variety of applications such as imaging [36], [37], video processing [37], [38], [39], cognitive radio networks [40], [41], machine-type communications [42], radar signal processing [43], and physical layer operations in communication systems such as channel estimation in wireless networks [44]–[49], channel estimation in power line communication [50], to name a few. In early review papers/book chapters related to CS, theory, algorithms and general applications of CS have been discussed [27], [33], [51]. There are also few recent survey papers that discuss recent advances in CS algorithms [52], [53].

Applications of CS in WSNs have been discussed to some extent in several related papers. There are survey/review papers available in the literature on CS in communication systems in general where sensor networks are treated as one application and some results can be easily applied to sensor networks as special cases. In [57], the application of CS for compressed data gathering, distributed compression and source localization has been briefly reviewed under the general topic of CS for communications and networks. Similarly, the use of CS for communication networks has been reviewed in [63] focusing on getting different physical, network and application layer tasks done. Specific to WSNs, several topics such as compressed data gathering exploiting temporal and spatial sparsity, and compressed data routing in a centralized setting are reviewed in [63]. In a recent survey paper [58], the authors have emphasized on the factors to be considered when applying CS for channel estimation, interference cancellation, symbol detection, support identification in wireless communication as applicable to different application scenarios. Some of the operations discussed in [58] such as simultaneous sparse signal recovery using MMVs and source localization are applicable to WSNs as well.

When considering existing survey papers that specifically focus on WSNs, most of them discuss how CS can be utilized for compressed data gathering using the centralized architecture. In a centralized setting, the direct use (by direct use, we mean that there is no additional work done on designing projection matrices and/or reconstruction algorithms beyond the standard CS framework) of CS reduces to the MMV problem if temporal sparsity is exploited and the SMV problem if spatial sparsity is exploited. In [59], the direct

TABLE I: Related survey/review papers

Aspect	References	Year	Contributions
CS Recovery algorithms with SMV/MMV	[53]	2015	A survey on sparse signal recovery algorithms with a single measurement vector; discusses different types of reconstruction algorithms along with a comparative study
	[54]	2011	A survey on sparse signal recovery algorithms with multiple measurement vectors; discusses optimization and greedy/iterative based simultaneous sparse approximation algorithms considering the JSM-2 model [55]
	[56]	2014	A review on CS reconstruction algorithms; discusses CS reconstruction algorithms for different distributed network models
CS for communications and networks	[57]	2013	A survey on theory and applications of CS; discusses compressed data gathering, distributed compression and source localization under CS in communications and networks
CS for wireless communication	[58]	2017	A survey on factors to be considered when applying CS for channel estimation, interference cancellation, symbol detection, support identification in wireless communication
Compression techniques in WSNs	[59]	2013	A survey on compression techniques used in WSNs for data gathering; compares the use of CS based techniques and the conventional compression schemes such as transformed based and distributed source coding
CS for WSNs	[60]	2011	A survey on CS for WSNs; discusses the improvements in factors such as lifetime, delay, cost and power
CS for image/video data compression in WSNs	[39]	2013	A tutorial on a distributed compressive video sensing; discusses the advantages of CS based video processing vs traditional techniques in a distributed manner
CS for cognitive radio networks	[61]	2013	A survey on wideband spectrum sensing techniques; discusses Nyquist and sub-Nyquist (CS based) techniques for spectrum sensing
	[40]	2016	A survey on application of CS in cognitive radio networks; discusses CS based wideband spectrum sensing, CS based CR-related parameter estimation and the use of CS for radio environment map construction
	[62]	2016	A survey on CS based techniques for cognitive radio networks; discusses the use of CS for a variety of CR applications including spectrum sensing, channel estimation, and multiple-input multiple-output based CR

use of CS for data gathering exploiting spatial sparsity has been considered. A comparative study on the advantages and disadvantages of CS based compression with inter- and intra-signal correlation compared to conventional compression schemes employed for WSNs has been presented. In [60], the direct use of CS exploiting spatial sparsity of data collected at multiple nodes for distributed compression has been considered. The authors have discussed as to how certain sensor network parameters such as lifetime, delay, cost and power can be improved using CS. However, the work related to the exploitation of other forms of sparsity, incorporation of communication related issues when designing projection matrices and reconstruction techniques for data gathering is missing in [59], [60]. In [54], [56], work related to development of reconstruction algorithms taking different network models and communication architectures has been reviewed. In particular, the authors in [56] have discussed the distributed development of some reconstruction algorithms for several signal models, and network topologies. Simultaneous sparse approximation algorithms reviewed in [54] are applicable for WSNs with the JSM-2 model (as defined in [55] and discussed in detail in Section III-A1). While some of the algorithms discussed in this review paper for data gathering have an overlap to some extent with the ones that are discussed in [54], [56], our discussion is more comprehensive with respect to recent developments focusing on centralized as well as decentralized settings and complexity analysis. Moreover, [54], [56] did not consider data gathering exploiting spatio-temporal sparsity,

design of data acquisition and reconstruction schemes to meet communication constraints and the use of CS to solve any other inference tasks. The review papers [40], [61], [62] have focused mainly on cognitive radio networks, while some of the algorithms discussed are applicable for data gathering in sensor network applications as well. To the best of the authors' knowledge, there is no any review paper that discusses CS based inference or impact of practical aspects on CS based processing in WSNs. A summary of survey/review papers most related to this paper is given in Table I.

The organization of the paper is summarized below.

### C. Paper Organization

The roadmap of the paper is shown in Fig. 1. In Section II, CS basics and motivation behind its use in several WSN applications are discussed. Application of CS in efficient data gathering exploiting temporal and spatial sparsity is reviewed in Section III. Furthermore, data gathering techniques and algorithms developed in centralized as well as in distributed/decentralized settings are discussed. CS based inference including detection, classification and localization is reviewed in Section IV. In Section V, a review on CS based signal processing under practical communication considerations such as channel fading, physical layer secrecy and quantization is given. Finally future research directions are discussed in Section VI and concluding remarks are given in Section VII.

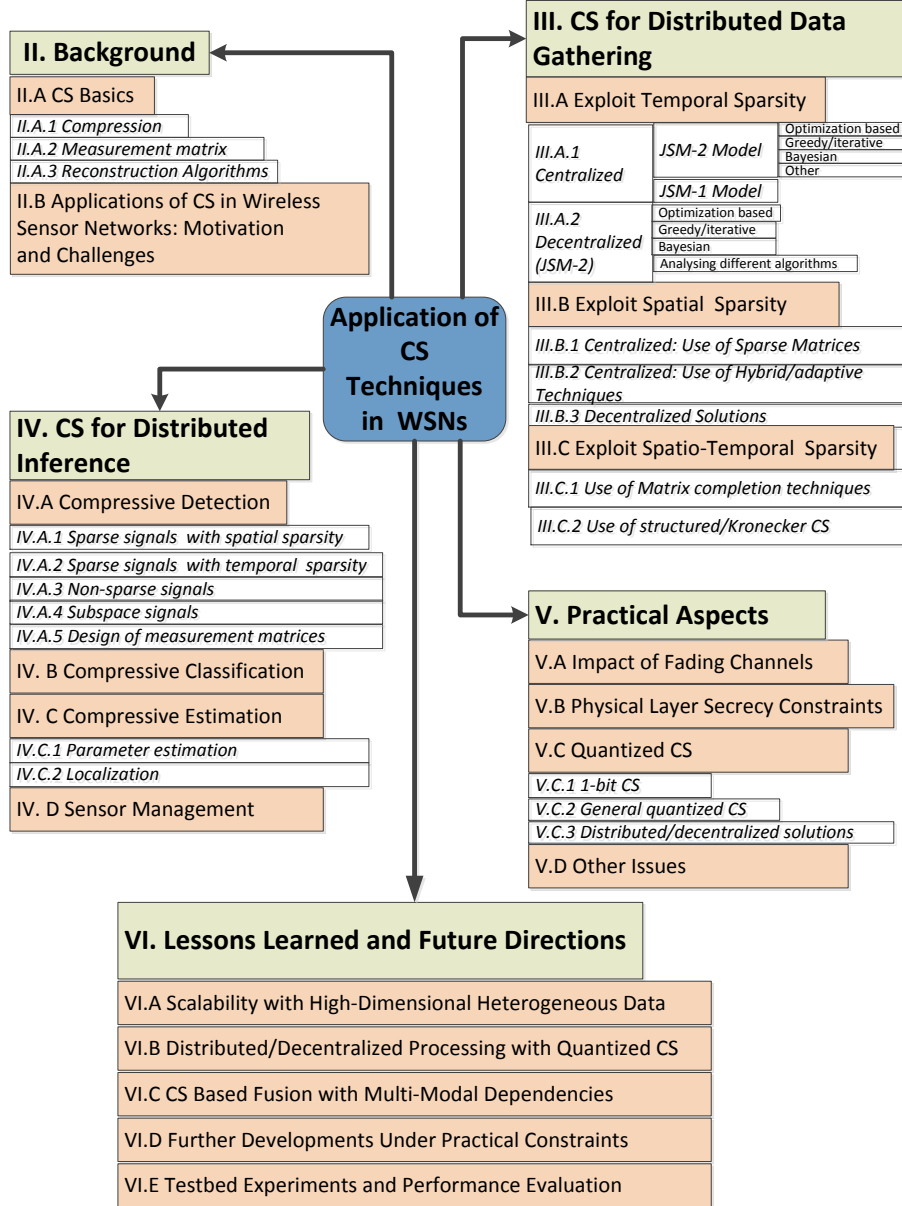

Fig. 1: Roadmap of the paper

#### D. Notation and Abbreviations

Throughout the paper, we use the following notation. Scalars (in  $\mathbb{R}$ ) are denoted by lower case letters and symbols, e.g.,  $x$  and  $\theta$ . Vectors (in  $\mathbb{R}^N$ ) are written in boldface lower case letters and symbols, e.g.,  $\mathbf{x}$  and  $\boldsymbol{\beta}$ . Matrices are written in boldface upper case letters or symbols, e.g.,  $\mathbf{A}$  and  $\boldsymbol{\Psi}$ . By  $\mathbf{0}$  and  $\mathbf{1}$ , we denote the vectors with appropriate dimension in which all elements are zeros and ones, respectively. The identity matrix with appropriate dimension is denoted by  $\mathbf{I}$ . The transpose of matrix  $\mathbf{A}$  is denoted by  $\mathbf{A}^T$ . The  $i$ -th row vector and the  $j$ -th column vector of matrix  $\mathbf{A}$  are denoted

by  $\mathbf{a}^i$  and  $\mathbf{a}_j$ , respectively. The  $(i, j)$ -the element of matrix  $\mathbf{A}$  is denoted by  $\mathbf{A}_{i,j}$  or  $\mathbf{A}[i, j]$ . The  $i$ -th element of vector  $\mathbf{x}$  is denoted by  $\mathbf{x}[i]$  or  $x_i$ . The  $l_p$  norm is denoted by  $\|\cdot\|_p$  while  $|\cdot|$  is used for both the cardinality (of a set) and the absolute value (of a scalar). The Frobenius norm of  $\mathbf{A}$  is denoted by  $\|\mathbf{A}\|_F$ . The Hadamard (element-wise) product is denoted by  $\odot$  while the Kronecker product is denoted by  $\otimes$ . The notation  $\mathbf{x} \sim \mathcal{N}(\boldsymbol{\mu}, \boldsymbol{\Sigma})$  means that the random vector  $\mathbf{x}$  is distributed as multivariate Gaussian with mean  $\boldsymbol{\mu}$  and covariance matrix  $\boldsymbol{\Sigma}$ . The abbreviations used in the paper are summarized in Table II.

TABLE II: Abbreviations used throughout the paper

Abbreviation	Description	Abbreviation	Description
ACIE	Alternating Common and Innovation Estimation	IST	Iterative Soft Thresholding
ADM	Alternating Direction Method	JSM	Joint Sparsity Model
AFC	Analog Fountain Codes	LASSO	Least Absolute Shrinkage and Selection Operator
ALM	Augmented Lagrangian Multiplier	LMS	Least-Mean Squares
AMP	Approximate Message Passing	MAC	Multiple Access Channel
AWGN	Additive White Gaussian Noise	MAP	Maximum <i>a posteriori</i>
BCD	Block-Coordinate Descent	ML	Maximum Likelihood
BCS	Bayesian CS	MMV	Multiple Measurement Vector
BIHT	Binary IHT	MSP	Matching Sign Pursuit
BP	Basis Pursuit	MT-BCS	Multitask BCS
BPDN	Basis Pursuit Denoising	NHTP	Normalized HTP
BSC	Binary Symmetric Channel	NIHT	Normalized IHT
BSBL	Block SBL	NP	Neyman Pearson
CB-DIHT	Consensus Based Distributed IHT	OMP	Orthogonal Matching Pursuit
CB-DSBL	Consensus Based Distributed SBL	PoI	Phenomenon of Interest
CoSaMP	Compressive Sampling Matching Pursuit	RIP	Restricted Isometry Property
CS	Compressive Sensing	RLS	Recursive Least Squares
CRLB	Cramèr-Rao Lower Bound	RSSI	Received Signal Strength Indicator
CWS	Compressive Wireless Sensing	RVM	Relevance Vector Machines
DBS	Distributed BP	SBL	Sparse Bayesian Learning
DC-OMP	Distributed and Collaborative OMP	SCoSaMP	Simultaneous CoSaMP
DCSP	Distributed and Collaborative SP	SCS	Sequential CS
DCT	Discrete Cosine Transform	SDP	SemiDefinite Programming
DIHT	Distributed IHT	SHTP	Simultaneous HTP
DiOMP	Distributed OMP	SIHT	Simultaneous IHT
DiSP	Distributed SP	SiOMP	Side information based OMP
DOA	Direction of Arrival	SMV	Single Measurement Vector
DOI	Difference-of-Innovations	SNHTP	Simultaneous NHTP
DR-LASSO	Decentralized Row-based LASSO	SNIHT	Simultaneous NIHT
DWT	Discrete Wavelet Transform	SNR	Signal-to-Noise Ratio
FOCUSS	FOCal Underdetermined System Solver	SOCP	Second-Order Cone Programming
FPC	Fixed Point Continuation	S-OMP	Simultaneous OMP
GAMP	Generalized AMP	SP	Subspace Pursuit
GLRT	Generalized Likelihood Ratio Test	SR	Sparse Representation
GMM	Gaussian Mixture Model	SSP	Simultaneous SP
GMP	Greedy Matching Pursuit	TDOA	Time-difference-of-arrival
GSM	Gaussian Scale Mixture	TECC	Transpose Estimation of Common Component
GSP	Generalized SP	VBEM	Variational Bayesian expectation-maximization
HTP	Hard Thresholding Pursuit	VQ	Vector Quantizers
IHT	Iterative Hard Thresholding	WSN	Wireless Sensor Network
IoT	Internet of Things		

## II. BACKGROUND

We start our discussion by presenting some background material on CS along with motivating factors behind its application in WSNs.

### A. CS Basics

Let  $\mathbf{x} \in \mathbb{R}^N$  be a discrete time signal vector. When represented in an appropriate basis  $\Phi \in \mathbb{R}^{N \times N}$  so that  $\mathbf{x} = \Phi \mathbf{s}$ ,  $\mathbf{x}$  is said to be sparse (with respect to the basis  $\Phi$ ) if  $\mathbf{s}$  contains only a few nonzero elements; i.e.,  $\|\mathbf{s}\|_0 \ll N$ . The support of  $\mathbf{s}$  (also known as the sparsity pattern/sparse support set) is defined as the set  $\mathcal{U} \in \{1, \dots, N\}$  such that

$$\mathcal{U} := \{i \in \{1, \dots, N\} \mid \mathbf{s}[i] \neq 0\}$$

where  $\mathbf{s}[i]$  denotes the  $i$ -th element of  $\mathbf{s}$  for  $i = 1, \dots, N$ .

1) *Compression*: In the CS framework, compression of  $\mathbf{x}$  is performed using the following linear operation:

$$\mathbf{y} = \mathbf{A}\mathbf{x} \quad (1)$$

where  $\mathbf{A}$  is a  $M \times N$  linear projection (measurement) matrix with  $M < N$ . In the presence of noise, (1) can be represented in a more general form,

$$\mathbf{y} = \mathbf{A}\mathbf{x} + \mathbf{v} \quad (2)$$

where  $\mathbf{v}$  denotes the  $M \times 1$  additive noise vector. With a SMV, one aims to solve for sparse  $\mathbf{s}$  (equivalently  $\mathbf{x}$  since  $\mathbf{x} = \Phi \mathbf{s}$  with known  $\Phi$ ) from (1) or (2).

Recovering  $\mathbf{s}$  from its compressed form  $\mathbf{y}$  in (1) (or (2)) is ill-conditioned when  $M < N$ , however, it has been shown that it is possible to reconstruct  $\mathbf{s}$  under certain conditions on the measurement matrix  $\mathbf{A}$  if  $\mathbf{s}$  is sufficiently sparse [26], [28], [29]. Reconstruction of  $\mathbf{s}$  is exact when there is no noise and approximate when there is noise.

2) *Requirements for the measurement matrix*: Several matrix properties have been discussed to establish necessary and sufficient conditions satisfied by the matrix  $\mathbf{A}$  so that  $\mathbf{s}$  can be recovered from  $\mathbf{y}$  [26], [28], [29], [33]. One such property is the *restricted isometry property (RIP)* property. The matrix  $\mathbf{A}$  is said to satisfy RIP of order  $k$  if there exists a  $\delta_k \in (0, 1)$  such that

$$(1 - \delta_k) \|\mathbf{x}\|_2^2 \leq \|\mathbf{A}\mathbf{x}\|_2^2 \leq (1 + \delta_k) \|\mathbf{x}\|_2^2 \quad (3)$$

for all  $\mathbf{x} \in \Sigma_k$  where  $\Sigma_k = \{\mathbf{x} : \|\mathbf{x}\|_0 \leq k\}$ . It has been shown that when the entries of  $\mathbf{A}$  are chosen according to a Gaussian (mean 0 and variance  $\frac{1}{M}$ ), Bernoulli ( $+\frac{1}{\sqrt{M}}$  or  $-\frac{1}{\sqrt{M}}$  with equal probability) or in general from a sub-Gaussian distribution,  $\mathbf{A}$  satisfies RIP with high probability when  $M = \mathcal{O}(k \log(N/k))$  [33].

3) *Reconstruction algorithms*: In order to recover  $\mathbf{s}$  from  $\mathbf{y}$ , the natural choice is to solve the following optimization problem (with no noise) [26], [28], [29], [33]:

$$\min_{\mathbf{s}} \|\mathbf{s}\|_0 \text{ such that } \mathbf{y} = \mathbf{A}\Phi\mathbf{s}. \quad (4)$$

Unfortunately, this  $l_0$  norm minimization problem is generally computationally intractable. In order to approximately solve (4), several approaches have been proposed. One of the commonly used approaches is to replace the  $l_0$  norm in (4) with a convex  $l_1$  norm. Greedy pursuit and iterative algorithms are also promising in approximately solving (4). In the following, we briefly discuss these approaches.

- *Convex relaxation*: A fundamental approach for signal reconstruction proposed in CS theory is the so-called basis pursuit (BP) [64] in which the  $l_0$  term in (4) is replaced by the  $l_1$  norm to get

$$\min_{\mathbf{s}} \|\mathbf{s}\|_1 \text{ such that } \mathbf{y} = \mathbf{A}\Phi\mathbf{s}. \quad (5)$$

Under some favorable conditions, the solution to (4) coincides with that in (5). In the presence of noise, basis pursuit denoising (BPDN) [64] aims at solving

$$\min_{\mathbf{s}} \|\mathbf{s}\|_1 \text{ such that } \|\mathbf{y} - \mathbf{A}\Phi\mathbf{s}\|_2 \leq \epsilon_1 \quad (6)$$

and least absolute shrinkage and selection operator (LASSO) [30], [65], [66] solves

$$\min_{\mathbf{s}} \|\mathbf{y} - \mathbf{A}\Phi\mathbf{s}\|_2 \text{ such that } \|\mathbf{s}\|_1 \leq \epsilon_2 \quad (7)$$

or equivalently

$$\min_{\mathbf{s}} \lambda \|\mathbf{s}\|_1 + \frac{1}{2} \|\mathbf{y} - \mathbf{A}\Phi\mathbf{s}\|_2^2 \quad (8)$$

where  $\lambda$  is the penalty parameter and  $\epsilon_1, \epsilon_2 > 0$ . In order to further enhance the performance of the  $l_1$  norm minimization based approach, the authors in [67]

have proposed to optimize the reweighted  $l_1$  norm. The reweighted  $l_1$  norm form of LASSO in (8) reduces to

$$\min_{\mathbf{s}} \sum_{i=1}^N w_i |\mathbf{s}[i]| + \frac{1}{2} \|\mathbf{y} - \mathbf{A}\Phi\mathbf{s}\|_2^2 \quad (9)$$

where  $w_i > 0$  denotes the weight at index  $i$ . While convex optimization based techniques are promising in providing optimal and/or near optimal solutions to the sparse signal recovery problem, their computational complexity is relatively high. For example, the computational complexity of BP when interior point method is used scales as  $\mathcal{O}(M^2 N^{3/2})$  [68]. To reduce computational complexity of sparse signal recovery, greedy and iterative algorithms as discussed below have been proposed.

- *Greedy and iterative algorithms*: Greedy/iterative algorithms aim to solve (4) (or its noise resistant extension) in a greedy/iterative manner which are in general less computationally complex than the optimization based approaches. Examples of such algorithms include orthogonal matching pursuit (OMP) [31], subspace pursuit (SP) [68], Compressive sampling matching pursuit (CoSaMP) [69], iterative hard thresholding (IHT) [32], [70] and their variants such as regularized OMP [71], and stagewise OMP [72], Normalized IHT (NIHT) [73] and Hard thresholding pursuit (HTP) [74]. The OMP and SP algorithms can be implemented with a computational complexity in the order of  $\mathcal{O}(kMN)$  [57], [68] while the complexities of CoSaMP and IHT scale as  $\mathcal{O}(MN)$  [57] and  $\mathcal{O}(MNT_r)$  [32], [70], respectively where  $T_r$  denotes the number of iterations required by the IHT algorithm for convergence. The recovery performance of OMP and IHT is comparable to the  $l_1$  norm minimization based approach when the signal is sufficiently sparse ( $k$  is very small) and the SNR is relatively large [31], [68], [70]. On the other hand, SP can perform comparable to the  $l_1$  norm minimization based approach even with relatively large  $k$  depending on the distribution of non-zero coefficients of the sparse signal.
- *Bayesian algorithms*: Another class of sparse recovery algorithms falls under the Bayesian formulation. In the Bayesian framework, the sparse signal reconstruction problem is formulated as a random signal estimation problem after imposing a sparsity promoting probability density function (pdf) on  $\mathbf{x}$  in (2). A widely used sparsity promoting pdf is the Laplace pdf [75]. With Laplace prior,  $\mathbf{x}$  is imposed with the pdf,

$$p(\mathbf{x}|\rho) = \left(\frac{\rho}{2}\right)^{\rho/2} e^{-\sum_{i=1}^N |\mathbf{x}[i]|} \quad (10)$$

where  $\rho > 0$ . When the noise  $\mathbf{v}$  in (2) is modeled as Gaussian with mean  $\mathbf{0}$  and covariance matrix  $\sigma_v^2 \mathbf{I}$ , the solution in (8) corresponds to a maximum *a posteriori* (MAP) estimate of  $\mathbf{x}$  with the prior (10). Computation of the MAP estimator in closed-form with the Laplace prior is computationally intractable, and several computationally tractable algorithms have been proposed in the literature. Sparse signal recovery using sparse Bayesian learning (SBL) algorithms has been proposed in [76]. In

[75], a Bayesian CS framework has been proposed where relevance vector machines (RVM) [77] are used for signal estimation after introducing a hierarchical prior which shares similar properties as the Laplace prior, yet, providing tractable computation. Babacan et.al. in [78] have also considered a hierarchical form of the Laplace prior of which RVM is a special case. CS via belief propagation has been considered in [79]. Bayesian CS by means of expectation propagation has been considered in [80]. An interesting characteristic of the Bayesian formulation is that it lets one exploit the statistical dependencies of the signal or dictionary atoms while developing sparse signal recovery algorithms. The authors in [81] have considered the problem of sparse signal recovery in the presence of correlated dictionary atoms in a Bayesian framework. While Bayesian approaches provide more flexibility in designing recovery algorithms than deterministic approaches their computational cost is relatively high compared to greedy and iterative techniques. For example, the computational complexity of SBL scales as  $O(N^3)$  [58].

Comparisons of different sparse signal recovery algorithms in terms of computational complexities and the minimum number of measurements needed can be found in [53], [57].

In the following section, we discuss the motivation behind applying CS techniques in WSN applications.

### *B. Applications of CS in Wireless Sensor Networks: Motivation and Challenges*

In a WSN deployed to collect field information in different application scenarios such as environment monitoring and surveillance, gathering sensed information at distributed sensors in an energy efficient manner is critical to the operation of the sensor network for a long period of time. Since the energy consumption of distributed sensors is mostly dominated by the radio communication [82] and sensing [83], data compression prior to transmission is vital. Further, the data collected at multiple nodes can be redundant in temporal or spatial domains, thus transmitting raw data may be inefficient. Data compression in WSNs has been studied for a long time focusing on redundancy in temporal and/or spatial domains. A nice review on different compression schemes proposed for WSNs can be found in [82]. Most of the existing schemes can be categorized as transform coding [82], [84] and distributed source coding [55], [85] which basically suffer from the requirement of in-network computation and control overheads. To that end, the CS framework, as a successful way of data compression not only for data gathering but also for solving other inference tasks, has been found to be attractive in the recent years. CS based compression does not require intensive computation at sensor nodes and complicated transmission control compared to conventional compression techniques. In order to further reduce the computation and communication costs at the local nodes, quantized CS [86]–[90] can be utilized.

As such, an immediate application of CS in WSNs is compressive data gathering. When merging CS and data gathering,

one of the main issues to be considered is how to design the two parts; compression side and the reconstruction side, under communication constraints. In WSNs, data collected at multiple nodes may have low dimensional properties in different dimensions; e.g., spatial, temporal, or spatio-temporal. On the compression side, practical design of compression schemes via random projections depends on how the sparsity is exploited. CS theory was initially developed for estimating a single sparse signal using SMV [26]–[29], and then it was extended to estimate multiple sparse signals using MMVs [34], [35], [91] under certain assumptions. While the CS reconstruction techniques developed for the SMV and MMV cases can be applied for CS based data gathering in ideal situations, extensions to the standard CS framework was required to account for communication related aspects. In early works on applying CS based techniques for data gathering, it was mainly assumed that the sensor nodes communicate with a fusion center, and signal reconstruction is performed at the fusion center [92]. In this approach, multi-hop communication between the sensors and the fusion center incurs a significant communication cost. In order to reduce the communication overhead, one of the approaches explored widely is to design sparse, structured or adaptive measurement matrices [93] which can be different from 'good' CS measurement matrices. When using such matrices for compression, it is required to establish the conditions under which the successful recovery is guaranteed. Another approach is to minimize the communication overhead is to perform reconstruction in a decentralized manner which requires sensor nodes to communicate only with their one-hop neighbors. Decentralized processing is attractive in WSN applications since it improves the scalability and robustness compared to centralized processing. This approach requires the extension of the CS recovery algorithms into the decentralized setting.

In certain WSN applications where compression via CS seems to be promising, complete signal reconstruction as required for data gathering is not required. For example, in detection, classification and parameter estimation problems, it is more important to understand the amount of information retained in the compressed domain so that a reliable inference decision can be obtained without complete signal reconstruction. In these inference problems with compressed data, the performance and the specific design principles depend on how the signals or the parameters are modeled. Further, the robustness and the accuracy of the CS framework under other practical communication considerations such as fading channels, secrecy issues, measurement quantization, link failures and missing data need to be understood to make CS based techniques feasible in WSN applications. In the recent literature, the CS framework has been extended to cope with a variety of practical aspects. The rest of the sections are devoted to a discussion of recent efforts of such extensions in some detail.

## III. CS FOR DISTRIBUTED DATA GATHERING

In this section, we discuss the CS based data gathering problem formulated as a sparse signal reconstruction problem

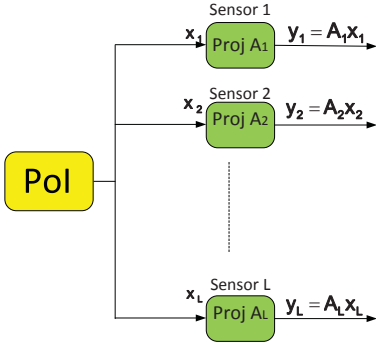

Fig. 2: Acquisition of compressed measurements of observations with temporal sparsity

exploiting temporal, spatial and spatio-temporal sparsity in WSNs. We describe the modifications and extensions to the CS framework to take communication constraints into account focusing on compression side as well as the recovery algorithms considering centralized and distributed/decentralized settings.

#### A. CS Based Data Gathering Exploiting Temporal Sparsity

Consider a WSN with  $L$  sensor nodes observing a PoI as illustrated in Fig. 2. The time samples collected at the  $j$ -th node are represented by the vector  $\mathbf{x}_j \in \mathbb{R}^N$ . In data gathering, sensor readings need be collected efficiently. Transmitting raw data vectors  $\mathbf{x}_j$ 's is inefficient in many applications since sensor data is compressible with many types of sensors. Data collected at acoustic, seismic, IR, pressure, temperature, etc., can have sparse representation in a certain basis. For example, audio signals collected by acoustic sensors (microphones) can be sparsely represented in DCT and DWT [94]. Formally, with an orthonormal basis  $\Psi_j \in \mathbb{R}^{N \times N}$ , when  $\mathbf{x}_j$  is represented as  $\mathbf{x}_j = \Psi_j \mathbf{s}_j$  for  $j = 1, \dots, L$ ,  $\mathbf{x}_j$  is said to be sparse when  $\mathbf{s}_j$  contains only a few nonzero elements compared to  $N$ . Thus, CS is readily applicable to compress temporal sparse data. In particular, only a small number of random projections obtained via  $\mathbf{y}_j = \mathbf{A}_j \mathbf{x}_j$  at the  $j$ -th node for  $j = 1, \dots, L$  (Fig. 2) are sufficient to be transmitted where  $\mathbf{A}_j \in \mathbb{R}^{M \times N}$ ,  $M < N$  is the measurement matrix used at the  $j$ -th node. When applying CS to compress temporal sparse data at a given node, the data streams collected at the node are compressed via random projections independently. The goal is to reconstruct  $[\mathbf{x}_1, \dots, \mathbf{x}_L]$  based on their compressed versions communicated through the network where the reconstruction techniques depend on the specific communication architecture used to combine  $\mathbf{y}_j$ 's.

1) *Centralized solutions for simultaneous sparse signal recovery exploiting temporal sparsity:* First, we focus on recovering  $\mathbf{X} \equiv [\mathbf{x}_1, \dots, \mathbf{x}_L]$  jointly based on  $\mathbf{Y} = [\mathbf{y}_1, \dots, \mathbf{y}_L]$  in a centralized setting. In this setting, the nodes transmit their compressed measurements to a central fusion center with long-range single-hop communication. The MMVs collected at the fusion center in matrix form with the same projection matrix so that  $\mathbf{A}_j = \mathbf{A}$  for  $j = 1, \dots, L$  can be represented by

$$\mathbf{Y} = \mathbf{A}\mathbf{X}. \quad (11)$$

For the more general case with different projection matrices, the observation matrix at the fusion center can be expressed as

$$\mathbf{Y} = [\mathbf{A}_1 \mathbf{x}_1, \dots, \mathbf{A}_L \mathbf{x}_L]. \quad (12)$$

In the simultaneous sparse approximation framework,  $\mathbf{X}$  needs to be reconstructed when  $\mathbf{Y}$  (or its noisy version) and  $\mathbf{A}$  (with the same projection matrix) or  $\mathbf{A}_1, \dots, \mathbf{A}_L$  (with different matrices) are given. In order to jointly estimate  $\mathbf{X}$ , joint sparse structures of  $\mathbf{X}$  can be exploited. There are several such structures discussed with applications to sensor networks [55], [95], [96]. It is worth noting that estimation of  $\mathbf{X}$  sometimes refers to estimating the support of  $\mathbf{X}$  by some authors. While the techniques and performance guarantees are not the same for estimating  $\mathbf{X}$  and its support, sometimes it is sufficient to estimate only the support jointly. This is because, once the support set is known, estimating individual coefficients reduces to a linear estimation problem.

*Common support set model (JSM-2):* The widely considered joint sparse model for sensor network data is the common support set model which is termed as the JSM-2 model in [55]. In this model, the sparse signals observed at multiple nodes,  $\mathbf{x}_j$ 's, have the same but unknown sparsity pattern with respect to the same basis. However, the corresponding amplitudes can be different in general. The JSM-2 model with the same measurement matrix as in (11) is commonly termed as the MMV model [91], [97]. Without loss of generality, in the rest of the section, we assume that  $\mathbf{x}_j$ 's are sparse in the standard canonical basis unless otherwise specified.

While developing algorithms and evaluating performance with the JSM-2 model, several measures have been defined. To measure the number of nonzero elements of  $\mathbf{X}$ ,  $\|\cdot\|_{\text{row-0}}$  norm is widely used where

$$\|\mathbf{X}\|_{\text{row-0}} = |\text{rowsupp}(\mathbf{X})| \quad (13)$$

with

$$\text{rowsupp}(\mathbf{X}) = \{i \in [1, \dots, N] : \mathbf{X}_{i,j} \neq 0 \text{ for some } j\}. \quad (14)$$

The natural approach to solve for sparse  $\mathbf{X}$  from  $\mathbf{Y}$  in (11) is to solve the following optimization problem:

$$\min_{\mathbf{X}} \|\mathbf{X}\|_{\text{row-0}} \text{ such that } \mathbf{Y} = \mathbf{A}\mathbf{X} \quad (15)$$

with no noise or

$$\min_{\mathbf{X}} \|\mathbf{X}\|_{\text{row-0}} \text{ such that } \frac{1}{2} \|\mathbf{Y} - \mathbf{A}\mathbf{X}\|_F \leq \epsilon \quad (16)$$

in the presence of noise. Since the problem (15) (and (16)) is NP hard, one often solves (15) (and (16)) by using the mixed norm approach which is an extension of the convex relaxation method for the SMV case to the MMV case.

*Convex relaxation:* A large class of relaxation versions of  $\|\mathbf{X}\|_{\text{row-0}}$  aims at solving an optimization problem of the following form [54]:

$$\min_{\mathbf{X}} J_{p,q}(\mathbf{X}) \text{ such that } \mathbf{Y} = \mathbf{A}\mathbf{X} \quad (17)$$

in the noiseless case and

$$\min_{\mathbf{X}} \frac{1}{2} \|\mathbf{Y} - \mathbf{A}\mathbf{X}\|_F^2 + \lambda J_{p,q}(\mathbf{X}) \quad (18)$$



in the noisy case (also known as R-LASSO [98]) where  $\lambda$  is a penalty parameter and

$$J_{p,q}(\mathbf{X}) = \sum_i (\|\mathbf{x}^i\|_p)^q \quad (19)$$

where typically  $p \geq 1$  and  $q \leq 1$ . It is noted that the value  $q$  promotes the common sparsity profile of  $\mathbf{X}$ ,  $p$  is a measure to weight the contribution of multiple signals to the common sparsity profile and (19) is convex whenever  $q = 1$  and  $p \geq 1$ . Different approaches have been discussed to solve (17) and (18) for different values of  $p$  and  $q$ . The most widely considered scenario is  $p = 2$  and  $q = 1$  which is commonly known as M-BP [53], [54], [97], [99]–[104]. This case is also dubbed as the mixed  $l_2/l_1$  norm minimization approach. When  $L = 1$ , this case reduces to the BP (or LASSO) formulation in (5) (or (8)). The works in [53], [54], [97], [99]–[104] have focused on developing different algorithms, and establishing recovery guarantees. In [97], M-FOCUSS (FOCAL Underdetermined System Solver) has been developed for the noiseless case, and the regularized M-FOCUSS for the noisy case. M-FOCUSS is an iterative algorithm that uses Lagrange multipliers and is also applicable when  $q \leq 1$ . The average case analysis on recovery guarantees using multichannel BP has been discussed in [101]. In [102], an alternating direction methods (ADM) based approach has been proposed to solve (18) which is called MMV-ADM. The M-BP problem as a special case of group LASSO, with the block coordinate descent algorithm called M-BCD, has been discussed in [54], [103], [104]. In [100], the mixed  $l_2/l_1$  type norm minimization problem has been solved via a semi-definite program which is shown to reduce to solving a second-order cone program (SOCP)-a special type of semi-definite program. In [34], the case where  $p = \infty$  and  $q = 1$  has been considered and the authors have discussed the conditions under which the convex relaxation is capable of ensuring recovery guarantees. Some known theoretical results on recovery guarantees of the SMV case have been generalized to the MMV case in [91] considering  $q = 1$  and arbitrary  $p$ . Recovery guarantees using fast thresholded Landweber algorithms considering  $p = 1, 2, \infty$ , and  $q = 1$  have been discussed in [105]. A comparison of different simultaneous sparse approximation methods with different values for  $p$  and  $q$  can be found in [34], [54].

*Greedy algorithms:* In order to solve (15), several greedy and iterative algorithms have been proposed which typically have less computational complexity than convex relaxation based approaches. In particular, most of these approaches are extensions of their SMV counterparts. The extension of the OMP algorithm to the MMV case with the common support set model, S-OMP, has been considered in [35]. Performance analysis of the S-OMP algorithm including noise robustness has been presented in a recent paper [124]. An MMV extension of the IHT algorithm, SIHT has been considered in [107], [108]. Some variants of SIHT such as SNIHT, and extensions of other greedy algorithms such as HTP, NHTP, and CoSaMP have also been discussed in [107], [109]. Generalized SP as an extension of the SP algorithm with MMVs has been considered in [110] which is shown to outperform the natural extension of SP, i.e., simultaneous SP (S-SP).

*Bayesian algorithms:* Solutions to the MMV problem with the JSM-2 model in the Bayesian setting have been discussed in [111]–[117], [120]. The MSBL algorithm, which is an extension of the SBL algorithm with SMV, has been developed in [111]. Multitask BCS (MT-BCS) has been developed in [115] in which applications of multitask learning to solve the MMV problem in the Bayesian framework have been discussed. In [116], the authors have extended the MT-BCS framework to take the intra-task dependency into account. In [117], the MMV problem in a Bayesian setting has been considered focusing on DOA estimation where the prior probability distribution is modeled with a Gaussian scale mixture (GSM) model. The proposed approach is dubbed M-BCS-GSM. Belief propagation based methods have been proposed in [112], [113] in which the approximate message passing (AMP) framework is used to jointly estimate the sparse signals. In [114], the MMV problem has been solved when the nonzero elements of a given column of  $\mathbf{X}$  are correlated and the two Bayesian learning algorithms, called T-SBL and T-MSBL have been developed.

*Other approaches:* The MMV problem with the JSM-2 model has been treated as a block sparse signal recovery problem after vectorizing  $\mathbf{X}$  to a block sparse signal in [119]. Then, the algorithms developed for block sparse signal recovery with SMV can be used to solve the MMV problem. In [120], block SBL (BSBL) algorithms, which take intra-block correlations into account, have been developed where the MMV problem is treated as a block sparse signal recovery problem. In [118], the authors have shown that most simultaneous sparse recovery algorithms discussed above are rank blind. They have proposed rank aware algorithms with mixed norm minimization as well as greedy algorithms which show better performance than rank blind algorithms under certain conditions. In [125], real temperature, humidity and light data have been used to validate some algorithms developed under the JSM-2 model exploiting spatial and time correlations among network data. An adaptive sparse sensing framework has been proposed in [126] which precisely recovers spatio-temporal physical fields by optimizing for sparse sampling patterns.

*Common support set + innovation model (JSM-1):* Another widely considered joint sparse support set model with many WSN applications is the common support set + innovation model, which is termed as the JSM-1 model in [55]. It is assumed that each sparse signal  $\mathbf{x}_j$  can be expressed as  $\mathbf{x}_j = \mathbf{x}_C + \tilde{\mathbf{x}}_j$  where  $\mathbf{x}_C$  is a common (to all  $\mathbf{x}_j$ 's) component which is sparse and  $\tilde{\mathbf{x}}_j$  is called the innovation component which is also sparse but different from  $\mathbf{x}_C$ 's sparsity pattern. Recovery of  $\mathbf{X}$  with the JSM-1 model has been discussed in [55]. In [55], weighted  $l_1$  norm minimization for jointly estimating  $\mathbf{X}$  is discussed. Considering the signal vector at one node as side information, the authors in [123] have developed the Difference-Of-Innovations (DOI) and Texas DOI algorithms for simultaneous sparse signal approximation for the JSM-1 model. In [121], centralized (as well as distributed) implementation of the ADM algorithm with MMV has been presented. In [122], side information based OMP (SiOMP) has been proposed. In SiOMP, the distributed CS is performed for the JSM-1 model where the estimate at one node via OMP is

TABLE III: Centralized solutions for joint sparse signal recovery with MMVs exploiting temporal sparsity

Approach	Algorithms and References
<b>JSM-2</b>	
Convex relaxation, $p = 2, q = 1$ in (19)	Group LASSO (with BCD) [54], [103], [104], SDP-SOCP [100], MMV-ADM [102], MMV <sub>prox</sub> [106]
Convex relaxation, $p = 2, q \leq 1$ in (19)	M-FOCUSS [97]
Convex relaxation, $p = 1, 2, \infty, q = 1$ in (19)	Landweber algorithms [105]
Convex relaxation, $p = \infty, q = 1$ in (19)	[34] (Algorithm is implemented via standard mathematical software)
Greedy and iterative	S-OMP [35], SIHT, SNIHT [107], [108], SHTP [109], SNHTP [107], SCoSaMP [107], Generalized SP [110]
Bayesian	MSBL [111], MMV-AMP [112], [113], T-MSBL [114], MT-BCS [115], [116], M-BCS-GSM [117]
Other approaches	Rank-aware algorithms [118], block sparse signal recovery based algorithms [119], BSBL [120]
<b>JSM-1</b>	
Convex relaxation	weighted $l_1$ norm minimization [55], $l_1$ norm minimization using ADM [121]
Greedy	SiOMP [122]
Greedy/optimization based	DOI and Texas DOI [123] (to estimate sparse innovation components, greedy/optimization based recovery algorithms can be used, valid for JSM-3 model as well)
<b>JSM-3</b>	
Greedy/optimization based	TECC and ACIE [55] (to estimate sparse innovation components, greedy/optimization based recovery algorithms can be used)

considered to be the initial value for the estimate at the next node.

Although not as interesting as the JSM-1 and JSM-2 models, some works can be found for the JSM-3 model discussed in [55]. In the JSM-3 model, the signal observed at each node is assumed to be composed of a nonsparse common component + sparse innovation component. Applications of this model in sensor network settings have been discussed in [55]. Further, two algorithms called Transpose Estimation of Common Component (TECC) and Alternating Common and Innovation Estimation (ACIE) have been developed in [55]. In these algorithms, the nonsparse common support is computed jointly and using that the sparse innovation components are computed by running sparsity aware algorithms. The algorithms developed in [123] for the JSM-1 model are applicable to the JSM-3 model as well.

In Table III, we summarize the simultaneous sparse signal recovery algorithms classifying under different categories as discussed above with MMVs for different JSM models.

2) *Decentralized solutions for simultaneous sparse signal recovery exploiting temporal sparsity:* While centralized solutions are attractive in terms of the performance, their implementation can be prohibitive in resource constrained WSNs since the power costs for long-range transmission can be still quite high. Further, centralized solutions are not robust to node and link failures. Decentralized solutions are attractive and are sometimes necessary in resource constrained sensor networks in which distributed nodes exchange (locally processed) messages only with their neighbors. They can significantly reduce the overall communication power and bandwidth compared to centralized processing. In the decentralized setting, each node is required to obtain the centralized solution (or an approximation to it) by only communicating within one-hop neighbors. Since the initial CS framework was developed for the SMV or the MMV case with centralized architecture, there was a need to extend it to the distributed and decentralized framework to address the necessities arising out of WSN

applications.

In developing decentralized algorithms exploiting temporal sparsity, where the goal is to estimate a set of sparse signals using their compressed versions, the joint sparse structures play an important role. In fact, most of the decentralized solutions developed so far consider the JSM-2 model for multiple sparse signals. First, we review the decentralized extensions of the optimization based algorithms where the goal is to solve equations of the form (17) or (18) in decentralized manner.

*Optimization based approaches:* With the JSM-2 model, the matrix  $\mathbf{X}$  has only a small number of nonzero rows. In other words, when the common support set is estimated jointly, the individual estimates of  $\mathbf{x}_j$ 's can be estimated by the  $j$ -th node. For the JSM-2 model with different measurement matrices at multiple nodes, the row-based LASSO (R-LASSO) formulation has been extended to the decentralized setting in [98]. Recall that R-LASSO in (18) with different measurement matrices reduces to

$$\min_{\mathbf{X}} \frac{1}{2} \sum_{l=1}^L \|\mathbf{y}_l - \mathbf{A}_l \mathbf{x}_l\|_2^2 + L\lambda J_{p,q}^{1/p}(\mathbf{X}) \quad (20)$$

where  $J_{p,q}(\mathbf{X})$  is as defined in (19). In [98], a decentralized implementation of (20) has been proposed with  $p = 2$  and  $q = 1$ . In particular, the authors have reformulated (20) as a consensus optimization problem and developed an iterative algorithm. It is noted that consensus optimization is a powerful tool that can be utilized in designing decentralized networked systems with distributed nodes. In [98], the  $l$ -th node estimates the common support set and the individual coefficient vectors by solving a local optimization problem via augmented Lagrangian multiplier (ALM) method based on the information received from its local neighborhood. The algorithm requires each node to communicate a length  $N$  message at each iteration to its one-hop neighbors, thus the communication burden is proportional to the total number of iterations required and  $N$ . In [127], with the same problem

model as in [98], a non-convex optimization approach has been discussed extending the reweighted  $l_q$  norm minimization approach proposed in [67] for simultaneous sparse signal recovery in a decentralized manner. Similar to [98], the authors have reformulated the decentralized sparse signal recovery problem as a consensus optimization problem and only a length  $N$  weight vector needs to be exchanged among neighboring nodes during each iteration. In [127], the ADM method has been used to solve the corresponding optimization problem at a given node. A decentralized extension to the reweighted  $l_1$  norm minimization approach has also been discussed in a recent work in [128], where the authors propose to solve the problem using the iterative soft thresholding algorithm (IST). This algorithm requires each node to transmit a length  $N$  messages in its local neighborhood at each iteration and the number of iterations depends on the IST convergence rate.

A special case of the JSM-2 model is the case where all the nodes observe the same sparse signal (same support and same coefficients). We refer to this case as the common signal model where there is only a single sparse signal to be estimated with MMVs. Decentralized algorithms for this model have been developed in [129]–[133]. It is worth noting that the work reported in [130], [132] is application specific to spectrum sensing in cognitive radio networks, while the algorithms are applicable for WSNs with MMVs. In [132], [133], the distributed LASSO (D-LASSO) algorithm has been employed to compute the common LASSO estimator by collaboration among nodes. In [130], a similar formulation and approach has been adopted as in [132], however, their algorithm has faster convergence rate via proper fusion. In [129], [131], it is assumed that each node has access to only partial information on random projections of the common signal. In [129], a decentralized gossip based algorithm has been developed to implement the  $l_1$  norm minimization approach in a decentralized manner. Each node solves the optimization problem via the projected-gradient approach by communicating only with one-hop neighbors. Formulating the  $l_1$  norm minimization problem as a bound-constrained quadratic program, the gradient computation at each step of the coordinate descent algorithm is expressed as a sum of quantities computed at each node applying distributed consensus algorithm. In [131], distributed basis pursuit (DBS) has been developed based on the ADM method.

There are a few works that extend the optimization techniques considering the JSM-1 model to the decentralized setting. In [121], the authors have proposed a distributed version of the ADM algorithm (dubbed as DADMM) to implement an equivalent version of (20) in a decentralized manner where communication is only with one hop neighbours.

*Greedy/iterative approaches:* Distributed and decentralized versions of greedy/iterative algorithms can be found in [56], [122], [134]–[137], [141], [144], [145]. In [134], [137], distributed SP (DiSP) and Distributed OMP (DiOMP) have been developed which are applicable to both JSM-1 and JSM-2 models. In DiSP, at each iteration an estimate to the support set is updated based on the local support set estimates of the neighboring nodes. In each iteration, it is required to transmit the whole support set among the neighborhood. It is

noted that, the number of iterations required for convergence depends on the network topology and is fairly close to the sparsity index. In [140], the distributed parallel pursuit (DIPP) algorithm has been proposed for the JSM-1 model. In DIPP, fusion is performed to improve the estimate of the common support set via local communication, and the estimated support set is used as side information for complete signal reconstruction. Embedding fusion within OMP iterations, in [136], the authors have proposed two decentralized versions of the OMP algorithm, called DC-OMP 1 and DC-OMP 2 for the JSM-2 model. In DC-OMP 1, an estimate of the support index is computed similar to the standard OMP and those computed indices at all the nodes are fused at each iterations to get a more accurate set of indices for the support set. In DC-OMP 2, fusion is performed at two stages; to improve the initial estimate of the support set at each node, measurement fusion is done within the one-hop neighborhood. Similar to DC-OMP 1, index fusion is performed to get a more accurate index set. Both DC-OMP 1 and DC-OMP -2 can terminate with less than  $k$  number of iterations and require multi-hop communication for the index fusion stage since global knowledge is required. In [138], [139], the distributed and collaborative subspace pursuit (DCSP) algorithm has been developed for the JSM-2 model. The ideas developed in [138], [139] are similar to that in [136] with OMP, however, communication overhead requirements are slightly higher in [138], [139] than that for DC-OMP 1 and DC-OMP 2. The algorithm requires each node to communicate with its neighbors twice in each iteration to update the common support set. Distributed IHT (D-IHT) and a consensus based distributed IHT named (CB-DIHT) have been proposed in [141], [145] for the common signal model.

*Bayesian approaches:* Distributed and decentralized Bayesian algorithms for sparse signal recovery have been proposed in [142], [143], [146]. In [142], an approximate message passing (AMP) based decentralized algorithm, AMP-DCS, is developed to reconstruct a set of jointly sparse signals with JSM-2. The sparse signals are assumed to have sparsity inducing Bernoulli-Gaussian signal prior. The algorithm requires each node communicate  $MN$  messages at each iteration. In [146] a decentralized Bayesian CS framework has been proposed for the JSM-1 model where applying variational Bayesian approximation, the common support component and the innovation component are decoupled. Formulating the decoupled reconstruction problem as a set of decentralized problems with consensus constraints, each node estimates its innovation component independently and the common component jointly via local communication. In [143], a Consensus Based Distributed Sparse Bayesian Learning (CB-DSBL) algorithm has been proposed. The authors also exploit ADM to solve the consensus optimization problems in the sparse Bayesian learning framework at each node.

*Analysing different types of decentralized solutions:* The above discussed decentralized algorithms are summarized in Table IV. The three cases in Table IV correspond to the JSM-2 model, common signal model and the JSM-1 model. Selection of one algorithm over the other mainly depends on the desired performance requirements and tolerable communication and

TABLE IV: Decentralized estimation of sparse signals with multiple measurements exploiting joint sparse structures; Different cases are for different joint structures of multiple sparse signals, Case 1: JSM-2 with different coefficients, Case 2: JSM-2 with the same coefficients (common signal model), Case 3: JSM-1

Algorithm/References	Applicability	Commun. complexity (# of transmitted messages per node )	Features/average computational complexity per node
<b>Optimization based</b>			
DR-LASSO [98]	Case I	$\mathcal{O}(NT_1I_t)$	ALM to solve the optimization problem / $\mathcal{O}(I_t(N^2MT_1 + n_0NT_2))$
reweighted $l_1$ norm min. [128]	Case I	$\mathcal{O}(NI_t)$	IST to solve the optimization problem/ $\mathcal{O}(I_t(N^2M + N^2 + NM))$
reweighted $l_q$ norm min. [127]	Case I	$\mathcal{O}(NI_t)$	Use non-convex sum-log-sum penalty, ADM to solve the optimization problem / $\mathcal{O}(I_t((N^2 + M^3 + NM^2)T_3 + n_0N))$
Distributed ADMM [121]	Case III	$\mathcal{O}(2NI_t)$	ADM complexity
D-LASSO [130], [132]	Case III	$\mathcal{O}(NI_t)$	ADM complexity
Distributed BP [131]	Case II	$\mathcal{O}(NI_t)$ or $\mathcal{O}(NT_3I_t)$	ADM complexity
$l_1$ norm min. [129]	Case II	$\mathcal{O}(NI_t)$	Projected-gradient approach/dominated by $\mathcal{O}((N^2n_0 + N)I_t)$
<b>Greedy and iterative</b>			
DiOMP [134]	Case I/Case III	$\mathcal{O}(k^2)$	$\mathcal{O}(k^c(T_4MN))$
DC-OMP 1 [135], [136]	Case I	$\mathcal{O}(I_t^\dagger)$	Fusion of estimated indices at each iteration / $\mathcal{O}(I_t(MN + L))$
DC-OMP 2 [136]	Case I	$\mathcal{O}(I_t^\dagger + NI_t)$	Fusion of estimated indices as well as correlation coefficients in the neighborhood at each iteration / $\mathcal{O}(I_t(MN + n_0N + L))$
DiSP [137]	Case I/Case III	$\mathcal{O}(kI_t)$	SP operations, fusion via majority rule/ $\mathcal{O}(I_tkMN)$
DCSP [138], [139]	Case I	$\mathcal{O}(kI_t)$	SP operations, fusion via majority rule/ $\mathcal{O}(I_t(MN + n_0))$
GDCSP [138], [139]	Case I	$\mathcal{O}((k + N)I_t)$	SP operations, fusion of indices, measurements/ $\mathcal{O}(I_t(MN + n_0N))$
DIPP [140]	Case III	$\mathcal{O}(kI_t)$	Modification of SP, fusion via consensus, expansion/ $\mathcal{O}(I_t(NMT_5 + kn_0))$
D-IHT [141]	Case II	$\mathcal{O}(N^\dagger I_t)$	IHT operations/ $\mathcal{O}(M_pNI_t)$
<b>Bayesian</b>			
DCS-AMP [142]	Case I	$\mathcal{O}(MNI_t)$	Bernoulli Gaussian signal prior is used/ $\mathcal{O}(I_t(MN + n_0N))$
CB-DSBL [143]	Case I	$\mathcal{O}(NT_3I_t)$	$\mathcal{O}(I_t((N^2 + M^3 + NM^2 + NT_3n_0))$

- 1)  $N$ : dimension of the unknown sparse signals,  $M$ : number of compressed measurements per node,  $k$ : number of nonzero elements of the sparse signals in JSM-2 (sparsity index),  $k^c \leq k$ : number of nonzero elements with commons support set in JSM-1,  $L$ : number of total nodes in the network,  $n_0$ : average number of on-hop neighbors per each node
- 2)  $I_t$  denotes the number of iterations required for convergence which is a algorithm dependent variable
- 3)  $T_1$  and  $T_2$  denote the number of inner loop iterations required by DR-LASSO [98]
- 4)  $T_3$ : a variable to denote inner loop iterations in ADM
- 5)  $T_4$ : number of inner loop iterations in DiOMP
- 6)  $T_5$ : number of inner loop iterations in DiPP
- 7) In DC-OMP 1, DC-OMP 2, DCSP, and GDCSP:  $I_t \leq k$
- 8)  $\dagger$  denotes that messages need to be communicated globally via multi-hop communication
- 9)  $M_p \leq M$ : number of partial measurements at each node

computational complexities. In terms of computational and communication complexities, it is worth mentioning that almost all the optimization based techniques require a relatively large number of iterations to converge. Thus, the communication cost per each node is relatively high. Further, the computational cost at each node scales at least quadratic with respect to  $N$  resulting in a relatively large computational cost when dealing with high dimensional signals. Similarly, the decentralized versions of Bayesian algorithms also require a relatively high computational cost in processing high dimensional signals. On the other hand, most of the greedy approaches require only few iterations for algorithm termination [134], [136]–[139] that are comparable to the sparsity index  $k$ . This results in relatively small communication overhead compared to implementing optimization based algorithms in a decentralized manner. In particular, DC-OMP 1 and DC-OMP 2 have a faster convergence rate which require less than  $k$  number of iterations. Further, the in-node computational complexity

of greed algorithms is much smaller (mostly linear with  $N$ ) than that with optimization based and Bayesian approaches. In terms of performance, optimization based techniques with a suitable penalty parameter performs better than the other types of algorithms especially when  $k$  is large and SNR is relatively small. While both Bayesian and optimization based methods show similar order of computational complexity per node, Bayesian methods are more flexible in terms dependency on parameters than the optimization based techniques. Bayesian CS techniques can be implemented fully automated since all the unknown parameters are estimated during the execution of the algorithm while the optimization based techniques require the tuning of parameters such as penalty parameter and noise statistics for optimal performance. Thus, the optimization based techniques may require a larger communication overhead than the Bayesian techniques since the communication overhead depends on the number of iterations of the algorithm. Moreover, the Bayesian approach provides a framework to

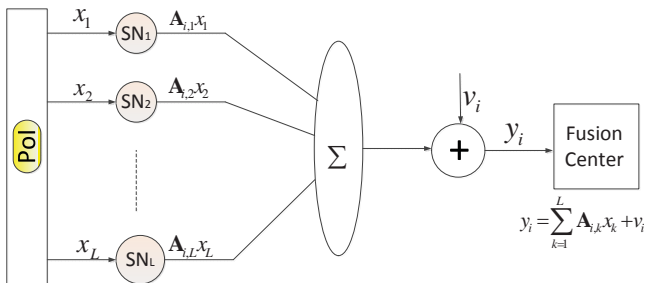

Fig. 3: MAC model for CS based data gathering exploiting spatial sparsity [84], [147]

account for the spatial and temporal statistical dependencies of the joint sparse signals. Comparing all types of algorithms, the greedy and iterative algorithms appear to be quite promising in decentralized processing of temporal sparse signals under severe network resource constraints although a certain performance loss can be expected compared to the optimization based and Bayesian approaches.

### B. CS Based Data Gathering/Reconstruction Exploiting Spatial Sparsity

To exploit CS techniques for data gathering exploiting spatial sparsity, compression of spatial data (over the nodes) via random projections at a given time step is needed. In contrast to temporal data compression as considered in Section III-A where individual nodes use random projection matrices independently, in this case, random projections have to be implemented in a distributed manner. Several architectures have been explored to implement distributed random projections so that a compressed version of sparse spatial data is made available at the fusion center. One of the architectures, with one-hop communication between the sensors and the fusion center is known as compressive wireless sensing (CWS) as proposed in [84], [147]. The CWS framework enables distributed compression with random projections employing synchronous multiple access channels (MACs). With MAC, individual nodes transmit their scaled observations to the fusion center coherently. This architecture is depicted in Fig. 3 for one MAC transmission. With this model, the observation at the  $j$ -th sensor, denoted by  $x_j$ , is multiplied by a scalar factor, and transmitted to the fusion center via a MAC channel. The received signal at the fusion center after the  $i$ -th MAC transmission is given by,

$$y_i = \sum_{j=1}^L \mathbf{A}_{i,j} x_j + v_i \quad (21)$$

where  $\mathbf{A}_{i,k}$  is the scalar factor, and  $v_i$  is the receiver noise. After  $M < L$  such MAC transmissions, the observation vector at the fusion center has the form of (2) where the  $(i, j)$ -th element of  $\mathbf{A}$  is given by  $\mathbf{A}_{i,j}$  for  $i = 1, \dots, M$  and  $k = 1, \dots, L$ ,  $\mathbf{x} = [x_1, \dots, x_L]^T$  and  $\mathbf{v} = [v_1, \dots, v_M]^T$ . With this model, the fusion center receives a compressed version of the sparse (or compressible) signal  $\mathbf{x}$ . In worth noting that, to avoid ambiguity in the paper, in this section, we denote the

signal under compression as a length  $L$  vector in contrast to a length  $N$  vector as considered in Section III-A.

Note that the CWS architecture requires synchronization among multiple sensors during each MAC transmission. To alleviate this requirement, another architecture widely considered is employing random projections through multi-hop transmission [92], [148]–[151]. In this framework, the data aggregation process is implemented with multi-hop routing as illustrated in Fig. 4. In [92], [148], [151], a tree based architecture is used to implement the multi-hop routing protocol so that the fusion center receives the observation vector  $\mathbf{y} = \mathbf{A}\mathbf{x}$ . In the baseline multihop routing approach (without any compression), the  $j$ -th sensor transmits its reading  $x_j$  along with the messages received from the previous node to the next node, thus, the nodes located closer to the sink consume a large amount of energy. In contrast, in the CS based multihop routing approach in Fig. 4, each node has to transmit only  $M = \mathcal{O}(k \log L)$  messages where  $k$  is the sparsity index with respect to an appropriate basis as defined before.

In both single-hop or multi-hop architectures, the problem of compressive data gathering exploiting spatial sparsity can be formulated as a CS recovery problem at the fusion center with a SMV. The works reported in [84], [147] and [92] are the first few papers that demonstrated the savings in communication and computations costs using direct application of CS techniques in large scale networks in contrast to the traditional sample-then-process approach. Robustness of CS based data gathering with this set-up in the presence of link failures and outlying sensor readings is further studied in [151]. While directly applying random projections to compress spatial data saves communication power costs compared to gathering raw data, still the transmission power costs can be high since all the nodes participate in the data aggregation process. In particular, when a dense Gaussian matrix is used for compression in the multi-hop routing architecture, the communication cost in terms of the total number of message transmissions and/or the maximum number of message transmissions of any single node can be high. In order to take limited communication and energy resources into account in CS based data gathering exploiting spatial sparsity in large scale sensor networks, further research has been done mainly focusing on controlling the amount of information transmitted by each node (equivalently designing projection matrices) and developing reconstruction algorithms.

1) *Centralized processing: Use of sparse matrices for spatial data gathering:* When dense random projections such as Gaussian random variables are used, each node has to forward all of its scaled observations which can incur a significant transmission power cost. When the projection matrix is made sparse, not all the sensors need to transmit all the local data under both single-hop and multi-hop architectures. The use of sparse random projections has the potential of reducing both communication and computational costs at sensor nodes. In CS theory, the signal recovery guarantees with sparse random matrices are widely discussed [51], [93], [152]–[157]. It is noted that many desirable properties that need to be satisfied to enable reliable reconstruction are violated when the projection matrix is made very sparse. Nevertheless, the authors in [157]

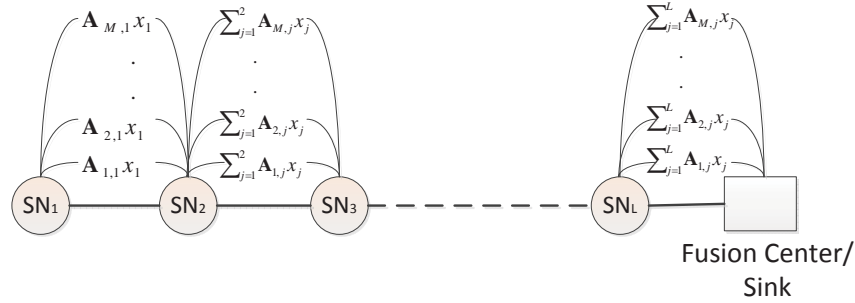

Fig. 4: Compressive data gathering with multi-hop routing exploiting spatial sparsity [92], [148]

have shown that very sparse random matrices can be used for data compression with a small recovery performance loss. Some widely considered sparse random projections are sparse Bernoulli and sparse Gaussian matrices as defined below. In sparse Bernoulli matrices, the  $(i, k)$ -th element of  $\mathbf{A}$  is drawn from [93]

$$\mathbf{A}_{i,k} = \sqrt{\frac{1}{\gamma}} \begin{cases} 1 & \text{with prob } \frac{\gamma}{2} \\ 0 & \text{with prob } 1 - \gamma \\ -1 & \text{with prob } \frac{\gamma}{2} \end{cases} \quad (22)$$

while in sparse Gaussian matrices  $\mathbf{A}_{i,k}$  is chosen as [155]

$$\mathbf{A}_{i,k} = \begin{cases} \mathcal{N}(0, \frac{1}{\gamma}) & \text{with prob } \gamma \\ 0 & \text{with prob } 1 - \gamma \end{cases} \quad (23)$$

with  $0 < \gamma < 1$ . The CWS scheme with sparse random projections in a centralized architecture is depicted in Fig. 5 for one MAC transmission.

Using the sparse matrix (22), it has been shown that it is sufficient to have  $\mathcal{O}(\text{poly}(k, \log L))$  random projections (equivalently MAC transmissions) to reconstruct the original signal with high probability when only  $\mathcal{O}(\log L)$  nodes on an average transmit their scaled observations during a given MAC transmission [93]. Instead of randomly selecting participating nodes as in [93], design of which nodes to transmit or equivalently constructing routing trees minimizing the overall energy consumption has been considered in [158]. While the optimal solution is NP-hard, several suboptimal approaches have been proposed with significantly less amount of data to be transmitted compared to the case where raw data forwarding. The minimum number of MAC transmissions required to enable signal reconstruction with high probability in the presence of fading has been analyzed by [153] using the matrix (22) while the authors in [154] have provided a similar analysis with the matrix (23) assuming phase coherent transmission. Impact of fading channels on signal reconstruction is further discussed in Section V-A.

In [148], design of the matrix  $\mathbf{A}$  so that the total communication cost kept under a desired level has been investigated. The matrix should be designed so that reliable recovery is guaranteed. In particular, the authors have proposed to split the measurement matrix and incorporated sparsity to one side so that the RIP property is not significantly violated. Thus, the designed matrix with smaller communication overhead is able to provide closer performance to the case using a dense matrix which consumes a large communication burden. The

authors in [149] have also considered multi-hop routing based CS data gathering, considering more general network models. In particular, a single sink as well as multi-sink models were considered. The capacity; the maximum rate that the sink can receive the data generated at nodes, and the delay; the time between the data sampling at nodes and the receiving at the sink were analyzed with both single sink and multi-sink models exploiting sparse random projections. In [159], the measurement matrix has been made as sparsest as possible where each row contains only one element. Since this matrix is not capable of providing reliable recovery guarantees when representing sensor data in a common transform basis, the authors have designed the transform basis so that the corresponding projection matrix is capable of providing reliable recovery guarantees. While this method reduces the communication cost significantly it adds computational cost in designing the transform basis as required for signal reconstruction. In [150], a non-uniform version of the sparse Bernoulli matrix (22) has been used where each column is generated using sparsity parameter  $0 < \gamma_j < 1$  for  $j = 1, \dots, L$ . Recovery guarantees with such non-uniform sparse matrices have been established in [150]. In terms of recovery performance, it is comparable to the case with direct application of CS as in [92] with large  $M$ , however, it leads to a performance degradation compared to [92] when  $M$  is small. Incorporating practical constraints such as interference in adjacent transmissions into sparse projections based data gathering framework has been addressed in [160], [161].

Hybrid and adaptive approaches to design the measurement matrices and/or the reconstruction algorithms to minimize communication cost in data gathering exploiting spatial sparsity are also attractive. Recent developments of adaptive CS are exploited in these approaches which will be discussed next.

2) *Centralized processing: Hybrid and adaptive approaches for CS based spatial data gathering:* In [162], a hybrid data aggregation approach has been proposed combining the energy efficiency aspect of applying CS to data collection in WSNs focusing on multihop networking scenarios. In particular, by joint routing and compressed aggregation, the energy consumption is reduced compared to applying CS directly as in [92]. Ideas of adaptive compressive sensing [163], where the goal is to design projections in an iterative manner to maximize the amount of information and minimize the number of projections, have been exploited in [164], to design



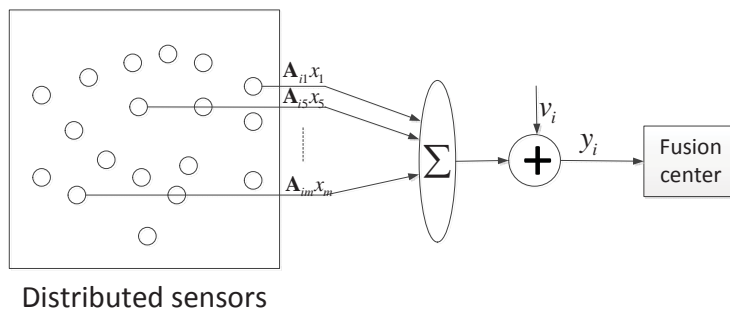

Fig. 5: Compressive Wireless Sensing with sparse random projections; only few sensors transmit during a given MAC transmission.

projection matrices. In particular, the subsequent projections have been designed taking into both energy constraints and the information gain into account so that the desired recovery performance is achieved at the sink. Simulated as well as testbed (to measure temperature) setups have been used to adaptively collect sensor data in [164]. Adaptive techniques for CS based data gathering have also been explored in [165]–[167]. In [165], both measurement scheme and the reconstruction approach are adaptively updated to cope with the variation of sensed data as well as the application requirements. Testbed data has been used to illustrate the variation of sensor readings due to external event and internal errors as well as to show the performance of the proposed adaptive techniques. In [166], a testbed for wildfire monitoring has been used to illustrate the performance of the proposed adaptive data compression scheme exploiting spatial sparsity. In [167], a feed-back controlled adaptive technique has been proposed to cope with the variation of sensor readings. The performance has been evaluated using a testbed designed to monitor the luminosity of the environment.

In Table V, we summarize the centralized data gathering approaches discussed above exploiting spatial sparsity.

3) *Decentralized solutions for sparse signal recovery exploiting spatial sparsity*: In contrast to forwarding the compressed data to a sink node for reconstruction, decentralized implementation is to estimate the sparse vector of interest in a distributed/decentralized manner when a given node has access to only local or some partial information about the information that would go to a sink node in a centralized setting. This requires the communication to be only within one-hop neighborhood of each node thus reducing the communication cost significantly compared to multi-hop transmission and long-range single-hop transmission as considered in Section III-B.

Most of the decentralized algorithms developed exploiting spatial sparsity are application specific since the constraints, available local information and the communication overhead depend on the application scenario. The work in [168] models the sparse event monitoring task as a sparse signal reconstruction problem where compression is achieved letting only few active sensors collect data. With  $L$  distributed sensors each having a position denoted by  $r_i$  for  $i = 1, \dots, L$ , the sources of events are confined to sensor points; i.e., an event occurs only at a sensor point as shown in Fig. 6. The magnitude

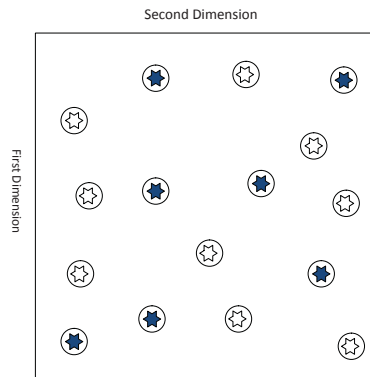

Fig. 6: Sparse event monitoring; ([168], [169]), locations of sources (stars) coincide with the locations of sensors (circles), solid stars - active sources, void stars - inactive sources

of the event at the  $r_i$ -th location is denoted by a positive scalar  $s_i$ . If no event occurred at the location  $r_i$ ,  $s_i = 0$ , then those sensors are called inactive sensors. Forming a vector  $\mathbf{s} = [s_1, \dots, s_L]^T$ , the measurement at the sensor located at  $r_i$  is given by,

$$y_i = \sum_j \Psi_{i,j} s_j + v_i \quad (24)$$

where  $\Psi_{i,j}$  denotes the influence of a unit-magnitude event at the position  $r_j$  on the sensor position at  $r_i$  for  $i, j = 1, \dots, L$ . The observation vector at  $M < L$  active sensors in vector-matrix notation has the form of (2) where  $\mathbf{y} = [y_1, \dots, y_M]^T$ ,  $\mathbf{A}$  in (2) is replaced by  $\mathbf{A}\Psi$  with  $\Psi$  being an  $L \times L$  matrix where  $\Psi_{i,j}$  is the  $(i, j)$ -th element, and  $\mathbf{A}$  being an  $M \times L$  matrix which selects the  $M$  rows of  $\Psi$  corresponding to active sensors and  $\mathbf{v} = [v_1, \dots, v_M]^T$ . In this formulation, the problem of estimating the active sources is formulated as estimating the sparse vector  $\mathbf{s}$  so that [168]

$$\arg \min_{\mathbf{s}} \frac{\lambda}{2} \|\mathbf{A}\Psi\mathbf{s} - \mathbf{y}\|_2^2 + \|\mathbf{s}\|_1 \text{ such that } \mathbf{s} \geq \mathbf{0} \quad (25)$$

where  $\lambda$  is a penalty parameter which is a generalization of the LASSO formulation. The main idea of the decentralized implementation in (25) is to estimate the  $s_i$  at the  $i$ -th node and the elements corresponding to the inactive sensors in the  $i$ -th node's one hop neighborhood by collaborating with the

TABLE V: Centralized solutions for sparse signal recovery exploiting spatial sparsity

Architecture	Features	References
Single-hop	Use of MAC, consider AWGN channels	[84], [147]
	Use of MAC, consider fading channels	[153], [154]
Multi-hop	Direct application of CS	[92], [151]
	Design of sparse random matrices to meet communication constraints	[148]–[150], [157], [159]–[161]
	Use adaptive, and hybrid approaches	[162], [164]–[167]

neighboring active nodes exploiting consensus optimization and ADM ideas. In this framework, in contrast to estimating the whole length  $N$  sparse vector at each node, the coefficients corresponding to itself and neighboring nodes are estimated. This reduces the amount of information to be exchanged among nodes in the one hop neighborhood. In [169], a similar problem formulation as in [168] has been considered where the authors have proposed to use partial consensus based and the Jacobi approaches to further reduce the communication cost in the decentralized implementation.

### C. Data Gathering Exploiting Spatio-Temporal Sparsity

In Section III-A, we considered the case where random projections are used to compress a single high dimensional sparse vector of time samples collected at a given node. The goal was to simultaneously estimate multiple such high dimensional sparse signals exploiting joint structures. In particular, the sparsity of the signal is considered with respect to the transform basis for temporal data. On the other hand, in Section III-B, the spatial samples collected at multiple nodes at a given time instant were compressed using random projections in a distributed manner. In this case, sparsifying basis was taken with respect to the spatial data. In both Sections III-A and III-B, sparsifying basis was considered with respect to a single vector. In many applications, network data generally exhibits spatio-temporal correlations [170], thus, data compression exploiting sparsity in both dimensions (spatial and temporal) leads to better performance than the case where compression is done considering only one dimension [171]. In the following, we discuss CS techniques that can be utilized to process high dimensional data exploiting spatio-temporal sparsity.

Recall that  $\mathbf{X}$  defined in Section III-A is a  $N \times L$  matrix in which each column contains the length- $N$  data vector (uncompressed) collected at a given node. When exploiting spatio-temporal sparsity, it is desired that  $\mathbf{X}$  is compressed both row- and column-wise. When implementing such compression schemes in WSN settings, there have been research efforts which exploit some concepts developed in CS theory for sparse matrix compression [83], [171]–[173]

1) *Use of matrix completion techniques:* In [83], [171], the authors have exploited the ideas of matrix completion [174] inspired by CS theory to develop efficient data gathering schemes exploiting spatio-temporal sparsity. In particular, the matrix  $\mathbf{X}$  can be assumed to be low rank [175] in the presence of spatio-temporal correlations which can be recovered reliably from a compressed version of it (or a subset of its entries) using matrix completion ideas [174]. Low rank feature of data collected by WSNs has been demonstrated using testbed

experiments in [171]. Mathematically the  $\mathbf{X}$  can be found by solving the optimization problem

$$\min_{\mathbf{X}} \text{rank}(\mathbf{X}) \text{ such that } f_A(\mathbf{X}) = \mathbf{Y} \quad (26)$$

where  $f_A(\cdot)$  denotes a linear operation and  $\mathbf{Y}$  is the received data matrix at the sink. Solving (26) in its current form is NP hard, thus there have been several attempts to find approximate solutions for (26) where nuclear norm minimization as discussed in [176] is shown to be a promising approach. In the data gathering scheme presented in [171], each sensor forwards its observed data to the sink with a certain probability leading to sparsity in the matrix  $\mathbf{X}$ . By defining  $f_A(\cdot) = \mathbf{X} \odot \mathbf{Q}$  where  $\mathbf{Q}$  is a  $N \times L$  matrix consisting of 1's and 0's, the data gathering problem is solved via the nuclear norm minimization approach which has been shown to outperform the case where only spatial sparsity is exploited as in the plain CS setting [92]. The performance evaluation is done using testbed data reported in [177] as well as with a testbed setup implemented by the authors in [171] to collect temperature, light, humidity, and voltage data.

2) *Use of structured/Kronecker CS:* Another approach considered to exploit spatio-temporal sparsity in data gathering is to exploit ideas in Kronecker CS [178]. The Kronecker CS framework can be used to combine the individual sparsifying bases in both spatial and temporal domains to a single transformation matrix. In particular, if each column in  $\mathbf{X}$  has a sparse representation in the basis  $\Phi_c \in \mathbb{R}^{N \times N}$  and each row has a sparse representation in the basis  $\Phi_r \in \mathbb{R}^{L \times L}$ , the vectorized<sup>1</sup> version of  $\mathbf{X}$  denoted by  $\text{vec}(\mathbf{X})$  has a sparse representation in  $\Phi_r \otimes \Phi_c \in \mathbb{R}^{NT \times NT}$  [178]. Kronecker CS ideas have been used for spatio-temporal data gathering in [172], [173], [179], [180] with enhanced performance compared to the use of CS only considering a single domain. It is noted that with the Kronecker based formulation, the communication and computational complexities of the data transmission and recovery algorithms increase due to the need of handling a  $NT \times NT$  matrix. In order to reduce communication complexity, a Kronecker based approach has been proposed in [172] where nodes communicate with only limited number of nodes in data forwarding. In [173], a sequential approach has been discussed which exploits Kronecker sparsifying bases (in spatial and temporal domains) with improved performance compared to using Kronecker CS ideas [178] directly.

Advances of CS techniques discussed above to solve the data gathering problem exploiting spatio-temporal sparsity are summarized in Table VI.

<sup>1</sup>vectorized version is obtained by stacking columns of  $\mathbf{X}$  one after the other.



TABLE VI: Data gathering exploiting spatio-temporal sparsity

Technique	Features	References
Matrix completion techniques	Centralized processing, exploit low-rank property of spatio-temporal data, nuclear norm minimization	[83], [171]
structured/Kronecker CS	Centralized processing, combine spatial and temporal sparsifying bases to a single transformation matrix	[172], [173], [179], [180]

Irrespective of the form of sparsity exploited, the data gathering problem as discussed in this section deals with complete signal reconstruction be it centralized or distributed. In the next section, we discuss other applications of WSNs that do not necessarily require signal reconstruction, however, CS can still be utilized

#### IV. CS FOR DISTRIBUTED INFERENCE

In WSNs, CS techniques can be used as a means of data compression while the end result is not signal reconstruction but solving an inference problem. For example, in order to solve a variety of inference problems such as detection, classification, estimation of parameters and tracking, it is sufficient to construct a reliable decision statistic based on compressed data without completely recovering the original signal. Beyond the standard CS framework, this requires the investigation of different metrics for performance analysis and quantification of the amount of information preserved under compression to obtain a reliable inference decision. Further, in contrast to complete signal reconstruction, sparsity prior is not necessary and the performance and the specific design principles depend on how the signals or the noise parameters are modeled. Thus, research on the applications of CS to solve such inference problems under resource constraints is attractive in WSNs. In the following, we discuss detection, classification, and parameter estimation problems with CS.

##### A. Compressive Detection

Detection is one of the fundamental tasks performed by WSNs [181]. In order to solve a detection problem efficiently, a decision statistic needs to be computed by intelligently combining multisensor data under resource constraints. In order to minimize the amount of information to be transmitted by sensor nodes, processing sensor data locally is of great importance. The overall decision statistic further depends on how the signals of interest and noise are modeled. In the following, we discuss how CS can be beneficial in solving detection problems. Based on the specific application and the approach employed, we classify the existing CS based detection techniques into five categories which will be presented in Subsections IV-A1 to IV-A5.

1) *Sparse events detection exploiting spatial sparsity*: An immediate application of CS in detection is to exploit spatial sparsity in sparse event detection problems. Detection of the presence of rare events by a sensor networks has applications in diverse areas such as environment monitoring and alarm systems [182]. When the number of active events is less than the number of all possible events, the event detection problem can be reformulated as a sparse recovery problem. CS ideas

have been exploited in sparse event detection in [168], [169], [183], [184]. Spatial sparsity can be exploited in sparse event detection in several ways.

In [183], the sparse event detection problem is formulated in the following sense. Let there be altogether  $K$  sources in which  $k$  (out of  $K$ ) are active. In particular, the  $k$  events are assumed to occur simultaneously. The measurement vector at

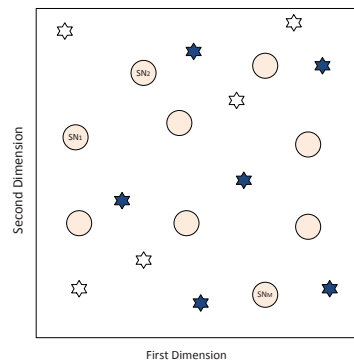

Fig. 7: Sparse event monitoring; ( [183]), dark stars-active sources, void stars-inactive sources, circles-sensor nodes

$M$  active sensors (out of  $L$ ) has the form of (2) where  $\mathbf{x}$  is a sparse vector with  $\mathbf{x}[i] \in \{0, 1\}$ . The  $(i, j)$ -th element of  $\mathbf{A}$  is given by

$$\mathbf{A}_{i,j} = r_{i,j}^{-\alpha/2} |h_{i,j}| \quad (27)$$

where  $r_{i,j}$  denotes the distance from the  $i$ -th sensor to the  $j$ -th source,  $\alpha$  is the propagation loss factor and  $h_{i,j}$  is the fading coefficient of the channel between the  $i$ -th sensor and the  $j$ -th source. In this framework, the sparse event monitoring problem reduces to estimating the sparse vector  $\mathbf{x}$  from (2) when the elements of  $\mathbf{A}$  as given in (27). Note that here  $\mathbf{A}$  is not a user defined random matrix satisfying RIP properties as desired by the standard CS framework. In particular, the randomness arises due to the random locations and fading coefficients. The authors in [183], have developed Bayesian algorithms exploiting marginal likelihood maximization for sparse event detection. In [184], the problem of sparse event detection has been addressed in an adaptive manner using sequential compressive sensing (SCS). SCS based event detection is shown to outperform the Bayesian approach considered in [183] in the low SNR region. The sparse event detection problem has been formulated from the perspective of coding theory by modeling the detection problem as a decoding of Analog Fountain Codes (AFCs) in [185]. The decentralized approach proposed in [168] for signal recovery exploiting spatial sparsity as discussed in Section III-B3 can also be used

to event detection when the events are assumed to be confined to sensor locations.

2) *Detection exploiting temporal sparsity*: Consider the following detection problem with the time samples collected at the  $j$ -th node given by

$$\begin{aligned}\mathcal{H}_1 : \mathbf{x}_j &= \boldsymbol{\theta}_j + \mathbf{v}_j \\ \mathcal{H}_0 : \mathbf{x}_j &= \mathbf{v}_j\end{aligned}\quad (28)$$

where  $\boldsymbol{\theta}_j \in \mathbb{R}^N$  is the (unknown) signal observed by the  $j$ -th node and  $\mathbf{v}_j$  is the additive noise for  $j = 1, \dots, L$ . The hypotheses  $\mathcal{H}_1$  denotes that the signal is present while  $\mathcal{H}_0$  denotes the signal is absent. Let the signal to be detected be sparse in the basis  $\boldsymbol{\Psi}$  so that  $\boldsymbol{\theta}_j = \boldsymbol{\Psi}\mathbf{s}_j$  with  $\mathbf{s}_j$  having only a few nonzero elements. With the common support set model, the coefficients  $\mathbf{s}_j$  for  $j = 1, \dots, L$  share the same support. Instead of transmitting  $\mathbf{x}_j$ 's, let the nodes transmit only a compressed version by applying random projections to the observations. When the detection problem is solved using compressed data, it is important to understand how to compute decision statistics along with their performance. After compression, the detection problem needs to be solved based on

$$\mathbf{y}_j = \mathbf{A}_j\mathbf{x}_j \quad (29)$$

for  $j = 1, \dots, L$ . In particular, the goal is to decide between hypotheses  $\mathcal{H}_1$  and  $\mathcal{H}_0$  based on (29). The detection problem in (29) can be expressed as:

$$\begin{aligned}\mathcal{H}_1 : \mathbf{y}_j &= \mathbf{B}_j\mathbf{s}_j + \tilde{\mathbf{v}}_j \\ \mathcal{H}_0 : \mathbf{y}_j &= \tilde{\mathbf{v}}_j\end{aligned}\quad (30)$$

for  $j = 1, \dots, L$  where  $\tilde{\mathbf{v}}_j = \mathbf{A}_j\mathbf{v}_j \sim (\mathbf{0}, \sigma_v^2\mathbf{I}_M)$  when  $\mathbf{A}\mathbf{A}^T = \mathbf{I}_M$  and  $\mathbf{v}_j \sim \sigma_v^2\mathbf{I}_N$ . When the support of  $\mathbf{s}_j$ 's denoted by  $\mathcal{U}$  is exactly known, (30) reduces to

$$\begin{aligned}\mathcal{H}_1 : \mathbf{y}_j &= \mathbf{B}_j(\mathcal{U})\mathbf{s}_j(\mathcal{U}) + \tilde{\mathbf{v}}_j \\ \mathcal{H}_0 : \mathbf{y}_j &= \tilde{\mathbf{v}}_j\end{aligned}\quad (31)$$

for  $j = 1, \dots, L$  where  $\mathbf{B}_j(\mathcal{U})$  denotes the  $M \times k$  submatrix of  $\mathbf{B}_j = \mathbf{A}_j\boldsymbol{\Psi}$  in which columns are indexed by the ones in  $\mathcal{U}$ , and  $\mathbf{s}_j(\mathcal{U})$  is a  $k \times 1$  vector containing nonzero elements in  $\mathbf{s}_j$  indexed by  $\mathcal{U}$  for  $j = 1, \dots, L$ . When  $\mathbf{B}_j(\mathcal{U})$  is known, (31) is the subspace detection problem which has been addressed previously [186]–[188]. Depending on how the unknown coefficient vector  $\mathbf{s}_j(\mathcal{U})$  is modeled, different detectors have been proposed. In [186], a generalized likelihood ratio test (GLRT) based detector has been proposed when  $\mathbf{s}_j(\mathcal{U})$  is assumed to be deterministic. In [187], the analysis has been extended to the case when  $\mathbf{s}_j(\mathcal{U})$  is modeled as random. The problem with multiple observation vectors has been addressed in [188] where the authors have proposed adaptive subspace detectors when the coefficients  $\{\mathbf{s}_j(\mathcal{U})\}_{j=1}^L$  follow first and second order Gaussian models.

In the case of sparse signal detection, it is unlikely that the exact knowledge of  $\mathcal{U}$  is available *a priori*. In other words, sparse signal detection needs to be performed when  $\mathcal{U}$  is unknown. When the sparsity prior is ignored, one of the

common approaches would be to consider the GLRT where ML estimator of  $\mathbf{s}_j$  is found as [189]

$$\hat{\mathbf{s}}_j = (\mathbf{B}_j^T\mathbf{B}_j)^{-1}\mathbf{B}_j^T\mathbf{y}_j. \quad (32)$$

When  $\mathbf{s}_j$  is sparse, the ML estimate is inaccurate since it is not capable of providing a sparse solution. Motivated by CS theory, some sparsity aware algorithms have been developed to detect sparse signals based on (30) by finding a better estimate for  $\hat{\mathbf{s}}_j$  for  $j = 1, \dots, L$  [135], [190]–[193] with enhanced performance compared to the ML based approach. In particular, the standard OMP algorithm has been modified in [191] to detect the presence of a sparse signal based on a SMV. In [193], the sparse signal detection problem has been addressed with MMV. The authors have derived the minimum fraction of the support set to be estimated to achieve a desired detection performance. Further, distributed algorithms for detection with only partial support set estimation via OMP are developed. In [135], a heuristic algorithm has been proposed for sparse signal detection in a decentralized manner based on partial support set estimation via OMP at individual nodes. Sparse detection problem in a Bayesian framework has been treated in [194] without complete signal reconstruction.

3) *Detection of non-sparse signals*: Let us revisit the detection problem presented in (28). When the signals to be detected,  $\boldsymbol{\theta}_j$ 's are known, the optimal detector which minimizes the average probability of error is given by the matched filter. Consider the same problem in the compressed domain based on (29). This problem has been treated with a single sensor in [195]. When  $\boldsymbol{\theta}_j$ 's are known and assuming  $\mathbf{v}_j \sim \mathcal{N}(0, \sigma_v^2\mathbf{I})$ , the decision statistic of the matched filter,  $\Lambda_c$ , in the compressed domain is given by

$$\Lambda_c = \frac{1}{\sigma_v^2} \sum_{j=1}^L \mathbf{y}_j^T (\mathbf{A}_j\mathbf{A}_j^T)^{-1} \mathbf{A}_j\boldsymbol{\theta}_j. \quad (33)$$

This results in the following probability of detection of the NP detector with probability of false alarm less than  $\alpha_0$  [196]:

$$P_d^c = Q \left( Q^{-1}(\alpha_0) - \frac{1}{\sigma_v} \sqrt{\sum_{j=1}^L \|\mathbf{P}_{\mathbf{A}_j^T}\boldsymbol{\theta}_j\|_2^2} \right) \quad (34)$$

where  $\mathbf{P}_{\mathbf{A}_j^T} = \mathbf{A}_j^T (\mathbf{A}_j\mathbf{A}_j^T)^{-1} \mathbf{A}_j$  and  $Q(\cdot)$  denotes the Gaussian Q-function. When  $\mathbf{A}_j$  is selected to be random and an orthoprojector so that  $\mathbf{A}_j\mathbf{A}_j^T = \mathbf{I}$ , (34) can be approximated by

$$P_d^c \approx Q \left( Q^{-1}(\alpha_0) - \sqrt{\frac{M}{N} \text{SNR}} \right) \quad (35)$$

where  $\text{SNR} = \frac{\sum_{j=1}^L \|\boldsymbol{\theta}_j\|_2^2}{\sigma_v^2}$ . With uncompressed observations, the matched filter results in the following probability of detection,  $P_d^u$ :

$$P_d^u = Q \left( Q^{-1}(\alpha_0) - \sqrt{\text{SNR}} \right). \quad (36)$$

Thus, the impact of performing known signal detection in the compressed domain appears on the probability of detection via the argument of the  $Q$  function. As discussed in [195], [196], when SNR is large, compressive detection is capable

TABLE VII: CS based solutions for detection in WSNs

Problem	Features	References
Sparse event detection	Formulate the sparse event detection problem as a sparse signal reconstruction problem, exploit spatial sparsity	[168], [169], [183]–[185]
Detection of temporal sparse signals	Compute decision statistics based on complete/partial signal reconstruction, compression at each node, exploit temporal sparsity	[135], [190], [191] [192], [193]
Detection of non-sparse signals	Compression at each node, no signal reconstruction	[195]–[198]
Detection of subspace signals	Compression at each node, known subspaces as well as unknown subspaces are considered	[199]–[201]
Design of measurement matrices	Optimize for measurement matrices to achieve a given detection performance	[202]–[204]

of providing similar performance as that of the uncompressed detector. In particular, transmitting only a compressed version of observations by each node does not, under certain conditions, result in performance loss compared to transmitting raw data. Thus, when the problem is detection (but not exact signal recovery), the CS measurement scheme can still be beneficial even without having the sparsity prior. In [196], the performance of the compressed detector when  $\theta_j$ 's are random has also been discussed. In [205], the performance analysis of detection in a Bayesian framework with unequal probabilities for hypotheses has been presented. In recent papers [197], [206], the authors have considered the problem of detection with multimodal dependent data analyzing the potential of CS in capturing the second order statistics of uncompressed data to compute decision statistics for detection. Performance analysis of sequential detection in the compressed domain has been considered in [198] with a single as well as multiple sensors.

4) *Detection of subspace signals*: Compressing time samples via random projections at each node to detect a variety of signals lying in a known low dimensional subspace (without complete signal reconstruction) has been investigated by several other authors. In [199], the detection performance of random sparse signals has been derived assuming that the subspace in which the signal is sparse is known. Subspace signal detection with compressed data under realistic scenarios has been treated in [200]. Decision statistics have been derived when in the presence of unknown noise variance and imprecise measurements. The results have been extended to the case when the signal of interest lies in a union of subspaces. The authors in [201] have considered the sparse signal detection problem assuming the signal to be detected lies in a known subspace. When the corresponding subspace is unknown, detection is performed after estimating the subspace using some training data.

5) *Design of measurement matrices for detection*: When exploiting CS in signal compression to solve detection problems, random matrices that satisfy RIP properties are widely employed. However, when the problem is to perform detection, it is interesting to see if the same conditions as required for complete signal reconstruction are necessary for the measurement matrices. Design of measurement matrices for compressive detection so that a given objective function is optimized has been considered in [202]–[204]. In [202], measurement matrices are designed so that the worst case SNR and the average minimum SNR are maximized. In [204],

the authors have considered the probability of detection of the NP detector as the objective function and shown that the optimal measurement matrices depend on the signal being detected. Detection with the designed measurement matrices in [202]–[204] is shown to outperform that with random measurement matrices satisfying RIP properties as used for signal reconstruction, however, at the expense of some additional computational cost.

CS based solutions for detection problems in WSNs are summarized in Table VII.

### B. Compressive Classification

CS based classification work treated thus far in the literature has mainly dealt with the temporal data. A classification problem with  $C$  classes can be formulated as a multiple hypothesis testing problem with  $C$  hypotheses. Let the observation vector at the  $j$ -th node under the  $i$ -th hypothesis be

$$\mathcal{H}_i : \mathbf{x}_j = \mathbf{s}_j^{(i)} + \mathbf{v}_j \quad (37)$$

for  $j = 1, \dots, L$  and  $i = 1, \dots, C$  where  $\mathbf{s}_j^{(i)} \in \mathbb{R}^N$  is the signal of interest under  $\mathcal{H}_i$ . If all the nodes transmit their length  $N$  observation vectors to the fusion center, the fusion center makes the classification decision based on  $\mathbf{x} = [\mathbf{x}_1^T, \dots, \mathbf{x}_L^T]^T$  (or its noisy version). With CS, the received compressed signal vector at the fusion center from the  $j$ -th node is given by

$$\mathbf{y}_j = \mathbf{A}_j \mathbf{x}_j + \mathbf{w}_j \quad (38)$$

where  $\mathbf{w}_j$  is the noise vector at the fusion center. Classification is then performed using  $\mathbf{y} = [\mathbf{y}_1^T, \dots, \mathbf{y}_L^T]^T$  instead of  $\mathbf{x} = [\mathbf{x}_1^T, \dots, \mathbf{x}_L^T]^T$ .

The specific classification method and the impact of the compression on the performance depend on how the signals  $\mathbf{s}_j^{(i)}$ 's and the noise vectors  $\mathbf{v}_j$ 's are modeled. For example, when  $\mathbf{s}_j^{(i)}$ 's are deterministic and known, and elements of each  $\mathbf{v}_j$  are iid Gaussian with mean zero and variance  $\sigma_v^2$ , the maximum likelihood classifier decides the true hypothesis (class) to be

$$\begin{aligned} \hat{i} &= \arg \max_i p(\mathbf{x} | \mathcal{H}_i) \\ &= \arg \min_i \sum_{j=1}^L \|\mathbf{x}_j - \mathbf{s}_j^{(i)}\|_2^2. \end{aligned} \quad (39)$$

based on  $\mathbf{x}$ . With compressed data in (38) and assuming that each projection matrix is an orthoprojector, the ML classifier

reduces to

$$\hat{i} = \arg \min_i \sum_{j=1}^L \|\mathbf{y}_j - \mathbf{A}_j \mathbf{s}_j^{(i)}\|_2^2. \quad (40)$$

Thus, as discussed in [207] (for the case of  $L = 1$ ), classification performance with compressed and uncompressed data depends only on how the distance measures are distorted by random projections. In particular, when  $\mathbf{A}_j$ 's are orthoprojectors, the distance between any two points in the compressed domain is reduced by approximately a factor of  $M/N$  compared to that with uncompressed data. In [208], the authors have established the relationships with several probabilistic distance measures with compressed as well as uncompressed data considering Gaussian as well as non-Gaussian distributions for uncompressed data. The distance measures can be used to evaluate how good the compressive classification is. In [209], design of projection matrices to improve the compressive classification performance is discussed. Nonparametric approaches for classification exploiting CS have been discussed in [210]–[212] although not directly focusing on sensor data.

### C. Compressive Estimation

Estimation is another important task performed by sensor networks in addition to detection and classification. In this section, we describe recent work on CS based estimation. CS in fact deals with an estimation problem using an underdetermined linear system to recover the projected high dimensional sparse signal. However, there are several applications where we are interested in estimating some parameters or functions without complete signal reconstruction. We first focus on the use of CS for parameter estimation in general and then discuss the CS based location estimation (or source localization) problem.

1) *Compressive parameter estimation*: Instead of estimating the complete projected signal, it is of interest to explore how CS can be used to estimate a parameter (or a set of parameters) that govern the high dimensional signal. These types of problems arise in several applications such as time delay estimation [213] and frequency estimation for a mixture of sinusoids [214]–[216]. Sparsity of the signal is not a necessary requirement in such problems. Similar to the detection and classification problems discussed earlier, we need to understand how much information is retained in the compressed domain so that a reliable estimator can be obtained.

In general form, consider that the signal of interest  $\mathbf{x}_j \in \mathbb{R}^N$  at the  $j$ -th node is parameterized by some  $K$ -dimensional parameter vector  $\boldsymbol{\omega} = [\omega_1, \dots, \omega_K]^T$  with  $K < N$ . The compressed observation vector at the  $j$ -th node (2) can be rewritten as

$$\mathbf{y}_j = \mathbf{A}_j \mathbf{x}_j(\boldsymbol{\omega}) + \mathbf{v}_j. \quad (41)$$

In order to quantify the information retained in the compressed domain, the authors in [216] evaluated the impact of the random projections on the estimation error. In particular, they have shown that the Cramér-Rao Lower Bound (CRLB),

which sets a lower bound on the variance of any unbiased estimator, is increased approximately by a factor of  $M/N$  with compressed data compared to its uncompressed counterpart when the noise is iid Gaussian. However, since the CRLB is a function of SNR, the performance of the CS based estimation can still be very close to that with uncompressed data when SNR is large. Estimation of time-difference-of-arrival (TDOA) using compressed data via the ML estimation method has been discussed in [213] without signal reconstruction. The TDOA estimates computed in the compressed domain can be used for source localization. These types of approaches are important when the sensors generate huge amounts of data and transmitting such large datasets is prohibitive due to communication constraints.

Another interesting formulation of compressive estimation is to estimate a function of the data based on compressed measurements as discussed in [195] where complete signal reconstruction is not necessary. In this framework with a SMV, the goal is to estimate a function of  $\mathbf{x}$ ,  $f(\mathbf{x})$ , based on  $\mathbf{y}$  in (2). In [195], the authors have considered the case where  $f(\mathbf{x}) = \langle \mathbf{g}, \mathbf{x} \rangle$  where  $\mathbf{g} \in \mathbb{R}^N$  where  $\langle \cdot \rangle$  denotes the inner product. The existing compressive parameter estimation techniques mostly focus on the SMV case. However, extensions to the MMV case are worth investigating so that they are applicable for WSN applications.

2) *Localization*: Source localization has been an active research area for a long time which has applications in diverse fields. In the literature, the source localization problem has been treated using both parametric as well as nonparametric approaches. In a parametric framework, one of the commonly considered methods is the ML method which shows excellent statistical properties. However, the ML approach is in general computationally complex since obtaining a closed-form solution is difficult. Nevertheless, there have been some approaches proposed to exploit CS in estimating parameters such as the TDOA in the ML framework using compressed data as discussed in the previous subsection which are used to perform source localization [213].

Among several other techniques for source localization, sparse representation (SR) based source localization has attracted much attention over the years due to its capability of achieving super-resolution compared to other suboptimal localization methods [99]. The problem of SR based source localization has a similar form as considered for sparse event monitoring in Section IV-A1. In particular, with redefined notation, let there be  $K$  sources and  $M$  sensors. The emitted signals by the  $K$  sources are given in  $\mathbf{s} = [s_1, \dots, s_K]^T$ . Further, let  $\mathbf{r} = [r_1, \dots, r_K]^T$  denote the source locations. The received signals at the  $M$  sensors can be represented as

$$\mathbf{y} = \boldsymbol{\Psi}(\mathbf{r})\mathbf{s} + \mathbf{v} \quad (42)$$

where the  $(i, j)$ -th element of the  $M \times K$  array manifold matrix  $\boldsymbol{\Psi}(\mathbf{r})$  contains the delay and gain information from the  $j$ -th source located at  $r_j$  to the  $i$ -th sensor. In the SR framework, (42) is represented as an overcomplete representation by constructing a fine grid, to account for all possible source locations, over the region of interest. Let  $\tilde{\mathbf{r}} = [\tilde{r}_1, \dots, \tilde{r}_L]^T$  denote the grid locations where  $L \gg K$ . Then, the matrix

TABLE VIII: CS based solutions for parameter estimation and source localization in WSNs

Problem	Features	References
Parameter estimation	Framework for estimating deterministic (scalar/vector) parameters based on compressed data, derive CRLB, SMV	[216]
	Estimation of TDOA based on compressed data, use ML approach	[213]
Source localization	SR with SMV, MMV, use $l_1$ norm minimization	[99], [217]
	SR with additional pre-/post- processing, use $l_1$ norm minimization	[218]
	SR with MMV, use OMP	[219]
	SR with SMV, use GMP	[220]
	SR MMV, use GMP	[221]
	SR with SMV, use VBEM	[222], [223]
	SR with SMV, use iterative BCS	[224]
	Signal sparsity and spatial SR with MMV, distributed BCS	[225]

$\Psi(\mathbf{r})$  is redefined as a  $M \times L$  matrix whose  $(i, j)$ -the element corresponds to the gain and delay information between the source location  $\tilde{r}_j$  and the  $i$ -th sensor. The signal field is given in  $\tilde{\mathbf{s}}$  where the  $n$ -th element of  $\tilde{\mathbf{s}}$  is nonzero if the  $n$ -th location has an active source while it is zero otherwise. With this representation, (42) can be rewritten as

$$\mathbf{y} = \Psi(\tilde{\mathbf{r}})\tilde{\mathbf{s}} + \mathbf{v} \quad (43)$$

where  $\tilde{\mathbf{s}}$  is a sparse vector. In this formulation, the sparse localization problem reduces to estimating a sparse signal  $\tilde{\mathbf{s}}$  based on  $\mathbf{y}$  where the elements of the  $\Psi(\tilde{\mathbf{r}})$  are determined by the particular signal model under consideration.

The works in [99], [217] have used  $l_1$  norm minimization to impose sparsity to solve the source localization problem with SMV as well as MMVs. It has been shown that the SR based approach outperforms the existing localization techniques such as MUSIC in terms of the resolution, robustness to noise, number of time samples needed, and existence of dependence among sources. However, the computational complexity of the  $l_1$  norm based approach is quite significant compared to other localization approaches. In [218], RSSI-based source localization problem has been considered using a similar spatial grid model used in (43) employing  $l_1$  norm minimization. Compared to the work in [99], [217], pre-processing is used to induce incoherence needed in CS theory, and post-processing is included to compensate for the spatial discretization caused by the grid assumption in [218]. Greedy techniques for SR based source localization have been utilized in [219]–[221] which have reduced computational complexities compared to  $l_1$  norm based approaches. In [220], a greedy matching pursuit algorithm (GMP), has been proposed for target counting and localization jointly using the SR framework. It has been shown that the GMP algorithm is capable of providing a good trade-off between the localization performance and the computational complexity compared to other SR-based and non SR-based approaches for localization. The GMP algorithm has been extended to take MMVs into account in [221] with RSSI measurements. In [219], OMP has been employed exploiting the SR framework using RSSI measurements. While promising results have been illustrated compared to non-SR based localization approaches, performance comparison with other SR-based approaches is missing in [219]. Bayesian

algorithms for SR based source localization have been explored in [222]–[225]. A multiple target counting and localization framework using the variational Bayesian expectation-maximization (VBEM) algorithm has been developed in [222], [223]. It has been shown that, in contrast to  $l_1$  norm minimization based and greedy algorithms, VBEM algorithm is more robust in localizing off-grid targets. In [224], the authors have proposed an adaptive BCS algorithm which selects the number of sensors to be participated in the localization process based on the feedback of estimated variances of noise at different nodes. In [225], a distributed source localization scheme have been proposed combining SR in spatial domain and signal sparsity at each node to reduce sampling cost. The algorithm has further been extended to take only 1-bit measurements of the compressed data in [225].

A summary of CS based general parameter estimation and SR based solutions for source localization is given in Table VIII. When analyzing existing SR based source localization techniques, simulation results have been provided in most of the work to analyze advantages and disadvantages over the performance and computational cost of different algorithms. However, theoretical analysis under practical conditions such as the presence of MMV, mismatches of spatial grid, and stability of estimates is lacking in most of the work which is worth further investigating.

#### D. Sparsity Aware Sensor Management

Sensor management, also dubbed as *sensor censoring*, is identified as one of the solutions for energy limitations in WSNs [226]. This involves in selecting the best subset of sensors that guarantees a certain inference performance. Finding the optimal solution for this problem is intractable in general and a wide class of sub optimal approaches, that fall into convex optimization, greedy and heuristic approaches, have been proposed in the literature [12], [226]–[228]. The sensor selection problem has gained much attention lately in the context of sparsity aware processing since efficient algorithms can be developed benefitting from the inherent sparsity in many WSN applications. In this subsection, we review the sensor management work that exploits sparsity aware techniques. Sensor management for jointly sparse signal recovery in WSNs is addressed in [229] when sparse

measurement vectors are used to compress observations at distributed nodes. The goal is to design a ternary protocol at the sensors to decide whether to transmit the compressed measurement vector, transmit a 1-bit hard decision, or not transmit based on a error criterion defined in terms of the overlap between the signal support and the support of the measurement vector. Centralized and distributed algorithms for sparsity aware sensor selection for the problem of estimation with a linear model have been proposed in [230]. In [231], the sensor selection problem for linear estimation has been formulated as a sparsity aware optimization problem considering two types of sensor collaboration; information constrained and energy constrained collaborations. The authors have employed reweighted  $l_1$  norm based ADM and the bisection algorithm to solve the optimization problem. In [232], the sensor selection problem has been formulated as the design of a sparse vector considering a nonlinear estimation framework. In [233], sensor selection for target tracking has been considered in which the selection is performed by designing a sparse gain matrix. A probabilistic sensor management scheme for target tracking has been proposed in [234] where the MAC model with distributed sparse random projections as discussed in III-B is used to compress the spatially sparse data. In [235], the authors have exploited the CS framework to develop a node selection mechanism for compressive sleeping WSNs to improve the performance of data reconstruction accuracy, network lifetime, and spectrum resource usage.

In Sections III and IV, exploitation of CS with and/or without reconstruction has been discussed categorizing the work by specific task of interest in WSNs. The following section is devoted to discuss approaches to cope with practical aspects when applying CS in WSNs. It is noted that, different aspects discussed below are applied to any given task in general.

## V. PRACTICAL ASPECTS

As discussed in the Introduction section, for CS based solutions to be practical in different WSN applications, it is important to investigate how well the CS based techniques perform in practical communication networks; i.e., in the presence of practical issues such as channel impairments, security related issues and measurement quantization.

### A. Impact of Fading Channel Impairments

In practical communication networks, the communication channels between the sensor nodes and the fusion center undergo fading. The presence of fading affects the recovery/inference capabilities of CS based techniques. For example, consider the CWS framework discussed in Section III-B. In the presence of fading, the observation at the fusion center after the  $i$ -th MAC transmission, (21), can be rewritten as

$$y_i = \sum_{k=1}^L h_{i,k} \mathbf{A}_{i,k} x_k + v_i \quad (44)$$

for  $i = 1, \dots, M$  where  $h_{i,k}$  is the fading coefficient for the channel between the  $k$ -th sensor and the fusion center during

the  $i$ -th transmission. In vector notation, (44) can be expressed as

$$\mathbf{y} = \mathbf{B}\mathbf{x} + \mathbf{v} \quad (45)$$

where  $\mathbf{B} = \mathbf{H} \odot \mathbf{A}$  where  $\mathbf{H}$  is the  $M \times L$  channel matrix with  $\mathbf{H}_{i,k} = h_{i,k}$  and  $\odot$  denotes the Hadamard (element-wise) product. With the model in (45), the effective measurement matrix,  $\mathbf{B}$ , has different properties compared to that of  $\mathbf{A}$ . Due to this, the recovery guarantees developed assuming AWGN channels may not be valid in the presence of fading since it leads to inhomogeneity and non Gaussian statistics in measurement matrices. In [153], [236], the problem of sparse signal recovery based on (45) has been addressed where the authors provide *uniform* recovery guarantees [237] based on RIP when  $\mathbf{A}$  is chosen as a sparse Bernoulli matrix (22). The authors in [154] have extended the work in [153] to derive *nonuniform* recovery guarantees [237] in the presence of Rayleigh fading in which the sparse Gaussian matrix (23) is used for distributed compression. In particular, the heterogeneity and the heavy tailed behavior of the projection matrix due to fading requires the sensors to take slightly more measurements than that required with AWGN channels to guarantee reliable recovery [154]. The robustness of the CS framework in the presence of nonideal channels has also been discussed in [238], [239]. The impact of fading and noisy communication channels in random access CS, an efficient method for data gathering [240], has been investigated in [241].

Another practical aspect to be dealt with is to understand the impact of security issues in WSNs on the CS framework.

### B. Physical Layer Secrecy Constraints

In WSNs, transmissions by distributed nodes may be observed by eavesdroppers. Further, the network may operate under malicious and Byzantine attacks. Thus, the secrecy of a networking system against eavesdropping attacks is of utmost importance [242]. In a fundamental sense, an eavesdropper can be selfish and malicious, to compromise the secrecy of a given inference network. In the recent past, there has been a significant interest in the research community in addressing eavesdropping attacks on distributed inference networks. However, while there are a few recent works [196], [204], [243]–[246], a detailed study with respect to CS based techniques has not yet been done thus far.

In [243], [244], the performance limits of secrecy of CS have been analyzed. The amplify-and-forward CS scheme is introduced in [245] as a physical layer secrecy solution for WSNs. The authors have studied the secrecy performance against a passive eavesdropper agent composed of several malicious and coordinated nodes. A CS encryption framework for resource-constrained WSNs has been proposed in [246]. The authors establish a secure sensing matrix, which is used as a key, by utilizing the intrinsic randomness of the wireless channel. In [196], the authors have considered the distributed compressive detection problem in the presence of eavesdroppers. The authors have derived the optimal system parameters to maximize detection performance at the fusion center while

ensuring perfect secrecy at the eavesdropper. In [204], the problem of designing measurement matrices for compressive detection so that the detection performance of the network is maximized while guaranteeing a certain level of secrecy has been discussed.

Next, we discuss the impact of measurement quantization on CS based processing.

### C. Sparse Signal Reconstruction with Quantized CS

Compression achieved via random projections at the sampling stage is desirable in resource constrained WSNs. However, further compression/quantization of the compressed measurements may be necessary in many WSN applications operating under severe resource constraints. Coarse quantization reduces the bandwidth requirements and computational costs at local nodes, and thus, is well motivated for practical WSNs. The traditional CS framework with real valued measurements has been extended to take quantization effect into account. In particular, one of the driving forces behind the development of a quantized CS framework is the motivation to further reduce the amount of information to be communicated in resource constrained WSNs. Consider the compressed observation model as given in (1) or (2). With quantized CS, one has access to  $\mathbf{z} = \mathcal{Q}(\mathbf{y})$  instead of  $\mathbf{y}$  where  $\mathcal{Q}(\cdot)$  is an entry-wise (scalar) quantizer which maps real valued measurements to a discrete quantized alphabet of size  $Q$ . In particular, each element of  $\mathbf{y}$  is quantized into  $Q$  levels so that

$$z_i = \begin{cases} 0, & \text{if } \tau_0 \leq y_i < \tau_1 \\ 1, & \text{if } \tau_1 \leq y_i < \tau_2 \\ \vdots & \\ \vdots & \\ Q-1, & \text{if } \tau_{Q-1} \leq y_i < \tau_Q \end{cases} \quad (46)$$

for  $i = 1, 2, \dots, M$ , where  $\tau_0, \tau_1, \dots, \tau_Q$  represent the quantizer thresholds with  $\tau_0 = -\infty$  and  $\tau_Q = \infty$ . With this approach,  $\lceil \log_2 Q \rceil$  bits per measurement are required to transmit each element of  $\mathbf{y}$ . In the special case with a 1-bit quantizer, the measurements are quantized into only two levels such that  $Q = 2$ . One example under this special case is to use only the sign information of the compressive measurements [86]–[90]. More specifically, the 1-bit CS scheme first proposed in [86] with sign measurements is given by

$$z_i = \begin{cases} 1, & \text{if } y_i \geq 0 \\ -1, & \text{otherwise} \end{cases} \quad (47)$$

for  $i = 1, 2, \dots, M$ . Equivalently, we may express (47) by

$$\mathbf{z} = \text{sign}(\mathbf{y}) \quad (48)$$

where  $\mathbf{z} = [z_1, \dots, z_M]^T$ , and  $\text{sign}(\cdot)$  denotes the element-wise sign operation. Sparse signal processing with 1-bit quantized CS is attractive since 1-bit CS techniques are robust under different kinds of non-linearities applied to measurements and have less sampling complexities at the hardware level because the quantizer takes the form of a comparator [86], [88].

Now, the goal is to perform sparse signal recovery or solve inference tasks based on  $\mathbf{z}$  instead of  $\mathbf{y}$ . There are several

factors that need to be taken into account when evaluating the performance and developing algorithms with quantized CS especially as applicable to resource constrained WSNs;

- Quantization introduces nonlinearity. Thus, the algorithms and the recovery guarantees developed for sparse signal processing with real valued CS may not be directly applicable for quantized CS. This provides the motivation to develop quantization schemes and reconstruction algorithms so that the performance with quantized CS is very close to (or even better than) that with the real valued CS.
- Coarse quantization can reduce the ability of signal reconstruction or performing inference tasks compared to real valued CS. This provides the impetus to take more measurements to compensate for the loss due to quantization. Thus, investigation of the trade-off between the cost for quantization and the cost for sampling is important.
- In distributed networks, MMVs appear naturally. This motivates us to extend the quantized CS based processing set-up to the distributed/decentralized settings with different communication architectures.

Over the past few years, there have been several research efforts that aim to consider quantized CS in different contexts. In the following, we first review the work on 1-bit CS.

1) *Algorithm development and performance guarantees with 1-bit CS*: Most of the early work related to 1-bit CS considers the SMV case. In [86], the authors have introduced the 1-bit CS problem with sign measurements (48) for the noiseless case (i.e.,  $\mathbf{y}$  is as in (1)). The authors have developed an optimization based algorithm for sparse signal recovery using a variation of the fixed point continuation (FPC) method [247]. In particular, they have considered solving

$$\min_{\mathbf{x}} \|\mathbf{x}\|_1 \text{ such that } \mathbf{Z}\mathbf{A}\mathbf{x} \geq 0 \text{ and } \|\mathbf{x}\|_2 = 1 \quad (49)$$

where  $\mathbf{Z} = \text{diag}(\mathbf{z})$ . It is noted that, for an  $N \times 1$  vector  $\mathbf{x}$ ,  $\text{diag}(\mathbf{x})$  denotes a  $N \times N$  diagonal matrix in which the main diagonal is composed of elements of  $\mathbf{x}$ . The authors have shown that the recovery performance can be significantly improved with the proposed algorithm compared to employing classical CS algorithms when the measurements are quantized to 1-bit. One problem in (49) is that it requires the solution of a non-convex optimization problem. In [248], the authors have presented a provable optimization algorithm to solve (49). A convex formulation of the signal recovery problem from 1-bit CS has been presented in [249] which solves for

$$\min_{\tilde{\mathbf{x}}} \|\tilde{\mathbf{x}}\|_1 \text{ such that } \text{sign}(\mathbf{A}\tilde{\mathbf{x}}) = \mathbf{z} \text{ and } \|\mathbf{A}\tilde{\mathbf{x}}\|_1 = M. \quad (50)$$

It has been shown in [249] that, (50) can provide an arbitrarily accurate estimation of every  $k$ -sparse signal  $\mathbf{x}$  with high probability when  $M = \mathcal{O}(k \log^2(N/k))$  1-bit measurements. According to their results, the required number of CS measurements matches the known results with real valued CS up to the exponent 2 of the logarithm and up to an absolute constant factor. In [250], [251], the log-sum penalty function, which has the potential to be much more sparsity-encouraging than the  $l_1$  norm, has been used for sparse signal recovery with 1-bit

CS. They have developed an iterative reweighted algorithm which consists of solving a sequence of convex differentiable minimization problems for sparse signal recovery.

Greedy and iterative algorithms developed for classical CS have been extended to the 1-bit CS case in [89], [90], [252]. Modification of the CoSAMP algorithm for the 1-bit case to produce Matching Sign Pursuit (MSP) has been presented in [90]. In [89], an extension of the IHT algorithm with 1-bit CS, called binary IHT (BIHT) has been developed. The BIHT algorithm to incorporate additional information on the partial support has been considered in [252]. The authors in [253] have presented a Bayesian approach for signal reconstruction with 1-bit CS, and analyzed its typical performance using statistical mechanics. In [254], a Bayesian algorithm based on generalized approximate message passing (GAMP) has been developed.

Recovery guarantees and consistency of the estimator for both Gaussian and sub-Gaussian random measurements have been established in [255] for 1-bit CS using the recently proposed  $k$ -support norm [256]. In [257], the sample complexity of vector recovery using 1-bit CS has been discussed. In a recent work presented in [258], the authors have shown that 1-bit measurements allow for exponentially decreasing error with adaptive thresholds. This framework is slightly different from the 1-bit CS model discussed with sign measurements in [86]. More specifically, the  $i$ -th element of  $\mathbf{z}$  is given by

$$z_i = \text{sign}(y_i - \nu_i) = \begin{cases} 1, & \text{if } y_i \geq \nu_i \\ -1, & \text{if } y_i < \nu_i \end{cases} \quad (51)$$

for  $i = 1, \dots, M$ . This scheme allows the quantizer to be adaptive, so that  $\nu_i$  in (51) of the  $i$ -th entry may depend on the 1st, 2nd,  $\dots$ ,  $(i-1)$ st quantized measurements. Adaptive one-bit quantization has also been considered in [259] where the authors have shown that when the number of one-bit measurements is sufficiently large, the sparse signal can be recovered with a high probability with a bounded error. The error bound is linearly proportional to the  $l_2$  norm of the difference between the thresholds and the original unquantized measurements. In another recent work by Knudson et.al. in [260], it has been shown that norm recovery is possible with sign measurements of the form  $\text{sign}(\mathbf{A}\mathbf{x} + \mathbf{b})$  for random  $\mathbf{A}$  and fixed  $\mathbf{b}$  which is impossible with  $\text{sign}(\mathbf{A}\mathbf{x})$ .

2) *Algorithm development and performance guarantees with quantized CS:* The authors in [261]–[264] have considered the sparse signal/support recovery problem with a given scalar quantizer where 1-bit CS appears as a special case. In scalar quantization, each element of  $\mathbf{y}$  is quantized independently as shown in (46). In [261], [262], several algorithms and performance bounds have been derived considering a SMV. More specifically, Zymnis et.al. in [261] have developed two algorithms for sparse signal recovery with quantized CS by minimizing a differentiable convex function plus an  $l_1$  regularization term. In [262], the authors have investigated the minimum number of CS measurements required for support recovery with a given quantizer (including 1-bit CS) with a SMV specifically focusing on support recovery. The effect of quantization has further been analyzed in [263]–[267]. The effects of precision in the measurements have been analyzed

in [265] by considering the syndrome decoding algorithm for Reed-Solomon codes when applied in the context of compressed sensing as a reconstruction algorithm for Vandermonde measurement matrices. Universal scalar quantization with exponential decay of the quantization error as a function of the oversampling rate has been considered in [267]. In particular, the author has shown that non-monotonic quantizers achieve exponential error decay in the oversampling rate using consistent reconstruction. However, reconstruction from such a quantization method is not straightforward, and the same author has proposed a practical algorithm for reconstruction using a hierarchical quantization approach in [266]. In [263], the authors have presented a variant of basis pursuit denoising, based on  $l_p$  norm rather than using the  $l_2$  norm. They have proved that the performance of the proposed algorithm improves with larger  $p$ . In [264], an adaptation of basis pursuit denoising and subspace sampling has been proposed for dealing with quantized measurements.

Design and analysis of vector quantizers (VQ) with CS measurements have been considered in [268], [269]. In [268], the authors have addressed the design of VQ for block sparse signals using block sparse recovery algorithms. Inspired by the Gaussian mixture model (GMM) for block sparse sources, optimal rate allocation has been designed for a GMM-VQ which aims to minimize quantization distortion. In [269], optimum joint source-channel VQ schemes have been developed for CS measurements. Necessary conditions for the optimality of vector quantizer encoder-decoder pair with respect to end-to-end MSE have been derived.

3) *Distributed and decentralized solutions with quantized CS:* While most of the existing works on quantized CS are restricted to the SMV case, there are a few recent works that have extended the quantized CS framework to the multiple sensor setting. In [270], sparse signal reconstruction using 1-bit CS has been considered modeling communication between sensors and the fusion center via a binary symmetric channel (BSC). Instead of using the sign measurements as in (47), local binary quantizers are designed to cope with the bit flipping caused by BSC. Several existing CS algorithms developed for real valued CS have been extended to the quantized CS setting in [271]–[273] considering centralized as well as distributed/decentralized implementations. Solving the support recovery problem in a decentralized setting with 1-bit CS (sign measurements) has been considered in [272], [273] where the authors have developed several decentralized versions of the BIHT algorithm. In [274], the authors employed a distributed variable-rate quantized CS methodology for acquiring correlated sparse sources in WSNs. Optimality conditions that minimize a weighted sum of the average MSE distortion for signal recovery with complexity-constrained encoders have been derived.

#### D. Other Issues

In addition to the practical issues discussed above, robustness of the CS scheme against missing or erroneous information, node failures, and other types of errors has been investigated by several researchers. It has been shown that the



multi-hop data gathering scheme proposed in [84] employing randomized gossip algorithms is robust to node failures and changes in network configurations. In [275], compression of spatio-temporal data with missing information and in the presence of anomalies has been addressed. As discussed in Section III-C1, the data matrix has a low rank structure in the presence of spatio-temporal sparsity. When there are missing information and/or anomalies, assumptions made in general CS theory may be violated leading to inaccurate/degraded performance if they are not properly taken care of. By proper decomposition of the data matrix to take the low-rank property, missing value interpolation and noise terms into account, the authors in [275] have developed a nuclear norm minimization based approach which is shown to be robust against missing information and anomalies. CS recovery techniques have also been used in [276] as a tool for estimating spatio-temporal data in the presence of missing information in WSNs without employing any data compression as discussed in Section III-C1.

While application of CS in WSNs has a quite rich literature as of now along most of the categories discussed above, there are still avenues for future research which will be discussed next.

## VI. LESSONS LEARNED AND FUTURE RESEARCH DIRECTIONS

With the emergence of new technologies such as IoT where heterogeneous networking architectures need to be integrated to perform a variety of tasks, handling and integration of a large amount of data generated by the interaction of multiple factors/sensors keeps continuously challenging. In particular, future WSNs are expected to integrate with a variety of other networks such as wireless mesh networks, Wi-Fi, and vehicular networks to make smart platforms for IoT applications. Understanding the role of CS, as a tool to cope with the problem of data deluge, is of great importance in making such applications realizable.

As reviewed in this paper specifically focusing on WSNs, there are several ways that CS techniques can be beneficial. While there has been quite significant amount of work done during last several years to make CS based techniques practically implementable in WSNs under network resource constraints focusing on different problems, there are still challenges and open issues worth further investigation in the areas discussed in Sections III, IV and V. In the following, we discuss such challenges and future research directions.

### A. Scalable Network Processing Exploiting Sparsity in Multiple Dimensions with Heterogeneous Data

As discussed in Section III, in CS based data gathering, the attention is mainly given to the case when sparsity is defined with respect to a single vector; temporal as in III-A and spatial as in III-B. To exploit spatio-temporal correlation in data gathering, there are a few approaches as discussed in Section III-C which define sparsity in 2-dimensions (2-D). Mainly, the ideas of Kronecker CS and matrix completion [174], [178] have been exploited under restricted assumptions such

as centralized processing. Further, when exploiting Kronecker CS ideas, reconstruction is performed after transforming 2-D (spatio-temporal) data to a single vector which requires large memory and computational costs. Such requirements are not desirable especially with on-line WSN applications. Thus, exploring approaches to reduce computational requirements when exploiting spatio-temporal sparsity is useful in many potential applications. One direction of research interest is to consider decentralized/cluster based settings where only partial information is processed at multiple sinks or clusters so that the overall computational burden is distributed. Further, ideas developed in [277], [278] can be utilized to solve these kind of problems in the matrix form with less computational cost without using the vector form.

Beyond WSNs, when integrating different network architectures for future IoT applications, large amount of data can be generated by the interaction of multiple factors/sensors and thus can be intrinsically represented by higher order tensors. Thus, exploitation of low dimensional properties of high order tensors in an efficient manner is needed to better employ CS based compression techniques to get a variety of tasks done. In CS theory, there has been quite significant attention to generalize the CS framework for high dimensional multi-linear models [279], [280]. Due to the same reasons discussed as in Section II-B, the direct use of such techniques may not be desirable and extensions to cope with the available network resources need to be explored.

### B. Distributed/Decentralized Processing with Quantized CS

While quantized CS (especially 1-bit CS), as discussed in Section V-C is appealing for WSN applications to further reduce the communication cost, most of the existing work on quantized CS is restricted to the SMV case. Recently, the works reported in [271]–[273] have extended the 1-bit CS framework to the multiple-sensor setting. However, its development is still in its infancy. Understanding the relationships among the network parameters, compression ratio (achieved via sampling with CS) and the quantization levels (achieved via quantizing CS samples) focusing on decentralized processing in both data gathering (signal reconstruction) and inference perspectives is necessary to better utilize the quantized CS framework in potential WSN applications. Further, quantifying the performance difference in terms of reconstruction and inference when using coarse quantized CS and real valued CS would help understand the trade-off between quantization and the performance. Thus, further efforts are required to evaluate the benefits of quantized CS in WSNs.

### C. CS Based Inference with Multi-Modal Data

When performing inference tasks from compressed data without complete signal reconstruction, it is of importance to understand how much information is retained in the compressed domain so that a reliable inference decision can be made. This depends on how the signal and noise are modeled. When the (uncompressed) multisensor data is independent and corrupted by additive Gaussian noise, performance metrics for CS based detection, classification, and parameter estimation

have been discussed in several recent works as reviewed in Section IV. Dependence is one of the common characteristics exhibited in multiple sensor data which is hard to model analytically with multimodal data unless the data is Gaussian. Further studying CS based inference in terms of deriving performance metrics, developing communication efficient algorithms, and designing projection matrices in the presence of inter-modal and intra-modal dependence will enable the efficient use of CS in many potential applications. While there exist several recent works that exploit spatial (or inter-modal) dependence in detection problems in the Bayesian CS framework under restricted assumptions [197], [206], CS based multi-sensor dependent data fusion especially in the presence of non-Gaussian pdfs and spatio-temporal dependence is not well understood. Thus, exploitation of higher order dependence and structured properties of high dimensional data in CS based multi-sensor fusion is worth investigating.

In addition to domain specific applications, when WSNs are used as a smart architecture for IoT applications, it is expected to process multi-modal data efficiently in dynamic, and heterogeneous environments to perform a variety of different tasks. Understanding how the CS framework can be beneficial in an adaptive manner to perform multiple tasks under such environments is essential in the realization of future IoT techniques.

#### *D. Further Developments Under Practical Considerations*

Understanding the robustness of the CS framework to practical systems in the presence of practical issues such as fading channels, interference, non-Gaussian noise impairments, synchronization errors, quantization errors, link failures, and missing data is important to make CS based techniques useful in WSNs. As discussed in Section V, many desirable conditions required to establish performance guarantees in the standard CS framework may not be satisfied in the presence of such practical issues. While some recent work exists in this area, further investigation of approaches to rectify the adverse impact of such practical aspects on the overall performance is needed.

#### *E. Testbed Experiments and Performance Evaluation*

So far, most research on CS in WSNs is restricted to theoretical and algorithmic development. There are some testbed experiments and demonstrations done to incorporate CS based techniques specifically focusing on data gathering. As discussed in Section III-B2, several testbed experiments analysis with real data have been reported for CS assisted data gathering exploiting spatial sparsity for different applications [164]–[167]. Further, in [171], testbed experiments have been performed for CS based spatio-temporal data collection and recovery. However, in order to bridge the theory and practice, further development is needed to validate the proposed techniques with real applications. In particular, testbed experiments with CS based techniques for a variety of applications with and/or without complete signal reconstruction, performance evaluation, and robustness analysis against practical considerations with real data will be useful.

## VII. CONCLUSION

In this survey paper, our goal was to describe the research trends and recent work on the use of CS in a variety of WSN applications. By discussing the motivational factors, we have identified several challenges that need to be addressed to enable practical implementation of CS based techniques in WSNs. To that end, we have reviewed the recent works that focus on developing centralized, distributed and decentralized solutions for data gathering and reconstruction exploiting temporal, spatial as well as spatio-temporal sparsity under communication resource constraints. We then described the work addressing the benefits of using the CS based techniques in solving several inference problems including detection, classification, estimation and tracking as desired by many WSN applications. We have further provided a discussion on incorporating practical considerations, such as channel fading, physical layer secrecy constraints and quantization, into the CS framework. Finally, potential future research directions in CS for resource constrained WSNs have been discussed. With this review paper, the readers are expected to gain useful insights on the applicability of various CS techniques in solving a variety of WSN related problems involving high dimensional data.

## REFERENCES

- [1] I. Akyildiz, W. Su, Y. Sankarasubramaniam, and E. Cayirci, "Wireless sensor networks: a survey," *Computer Networks*, vol. 38, no. 4, pp. 393–422, 2002.
- [2] L. Mainetti, L. Patrono, and A. Vilei, "Evolution of wireless sensor networks towards the internet of things: A survey," in *19th International Conference on Software, Telecommunications and Computer Networks (SoftCOM)*, 2011, pp. 1–6.
- [3] J. A. Stankovic, A. D. Wood, and T. He, "Realistic applications for wireless sensor networks," *Theoretical Aspects of Distributed Computing in Sensor Networks Springer*, pp. 853–863, 2011.
- [4] P. Rawat, K. D. Singh, H. Chaouchi, and J. M. Bonnin, "Wireless sensor networks: a survey on recent developments and potential synergies," *Journal of supercomputing*, vol. 68, no. 1, pp. 1–48, 2014.
- [5] B. Rashid and M. H. Rehmani, "Applications of wireless sensor networks for urban areas: A survey," *Journal of Network and Computer Applications*, vol. 60, pp. 192–219, 2016.
- [6] M. F. Othman and K. Shazali, "Wireless sensor network applications: A study in environment monitoring system," *Engineering Procedia*, vol. 41, pp. 1204–1210, 2012.
- [7] V. Raghunathan, S. Ganeriwal, and M. Srivastava, "Emerging techniques for long lived wireless sensor networks," *IEEE Commun. Mag.*, vol. 44, no. 4, pp. 108–114, Apr. 2006.
- [8] J.-F. Chamberland and V. V. Veeravalli, "Wireless sensors in distributed detection applications," *IEEE Signal Process. Mag.*, vol. 24, no. 3, pp. 16–25, May 2007.
- [9] R. Jiang and B. Chen, "Fusion of censored decisions in wireless sensor networks," *IEEE Trans. Wireless Commun.*, vol. 4, no. 6, pp. 2668–2673, Nov. 2005.
- [10] T. Wimalajeewa and S. K. Jayaweera, "Optimal power scheduling for correlated data fusion in wireless sensor networks via constrained PSO," *IEEE Trans. on Wireless Commun.*, vol. 7, no. 9, pp. 3608–3618, Sept. 2008.
- [11] M. Duarte and Y.-H. Hu, "Vehicle classification in distributed sensor networks," *Journal of Parallel and Distributed Computing*, vol. 64, no. 7, pp. 826–838, 2004.
- [12] L. Zuo, R. Niu, and P. K. Varshney, "Posterior CRLB based sensor selection for target tracking in sensor networks," in *Proc. Acoust., Speech, Signal Processing (ICASSP)*, vol. 2, Honolulu, Hawaii, USA, April 2007, pp. II–1041–II–1044.
- [13] O. Ozdemir, R. Niu, and P. K. Varshney, "Tracking in wireless sensor networks using particle filtering: physical layer considerations," *IEEE Trans. Signal Process.*, vol. 57, no. 5, pp. 1987–1999, May 2009.

- [14] R. Olfati-Saber, "Distributed tracking for mobile sensor networks with information-driven mobility," in *Proc. of American Control Conf.*, New York City, NY, July 2007, pp. 4606–4612.
- [15] Y. Zou and K. Chakrabarty, "Distributed mobility management for target tracking in mobile sensor networks," *IEEE Trans. on Mobile Computing*, vol. 6, no. 8, pp. 872–887, Aug. 2007.
- [16] P. M. Djurić, M. Vemula, and M. F. Bugallo, "Target tracking by particle filtering in binary sensor networks," *IEEE Trans. Signal Process.*, vol. 56, no. 6, pp. 2229–2238, June 2008.
- [17] A. Flemmini, P. Ferrari, D. Marioli, E. Sisinni, and A. Taroni, "Wired and wireless sensor networks for industrial applications," *Microelectronics Journal*, vol. 40, pp. 1322–1336, Sept. 2009.
- [18] V. C. Gungor and G. P. Hancke, "Industrial wireless sensor networks: Challenges, design principles, and technical approaches," *IEEE Trans. Ind. Electron.*, vol. 56, no. 10, pp. 4258–4265, Oct. 2009.
- [19] H. Alemdar and C. Ersoy, "Wireless sensor networks for healthcare: a survey," *Computer Networks*, vol. 54, no. 15, pp. 2688–2710, 2010.
- [20] I. Khan, F. Belqasmi, R. Glitho, N. Crespi, M. Morrow, and P. Polakos, "Wireless sensor network virtualization: A survey," *IEEE Commun. Surveys Tuts.*, vol. 18, no. 1, pp. 553–576, 2016.
- [21] S. M. Oteafy and H. S. Hassanein, "Big sensed data: Evolution, challenges, and a progressive framework," *IEEE Commun. Mag.*, vol. 56, no. 7, pp. 108–114, July 2018.
- [22] N. A. Pantazis, S. A. Nikolidakis, and D. D. Vergados, "Energy-efficient routing protocols in wireless sensor networks: A survey," *IEEE Commun. Surveys Tuts.*, vol. 15, no. 2, pp. 551–591, 2013.
- [23] R. Atat, L. Liu, H. Chen, J. Wu, H. Li, and Y. Yi, "Enabling cyber-physical communication in 5G cellular networks: challenges, spatial spectrum sensing, and cyber-security," *IET Cyber-Phys. Syst. Theory Appl.*, vol. 2, no. 1, pp. 49–54, 2017.
- [24] J. Wu, S. Guo, J. Li, and D. Zeng, "Big data meet green challenges: Big data toward green applications," *IEEE Syst. J.*, vol. 10, no. 3, pp. 888–900, Sep. 2016.
- [25] —, "Big data meet green challenges: Greening big data," *IEEE Syst. J.*, vol. 10, no. 3, pp. 873–887, Sep. 2016.
- [26] E. Candès and T. Tao, "Near-optimal signal recovery from random projections: Universal encoding strategies?" *IEEE Trans. Inf. Theory*, vol. 52, no. 12, pp. 5406–5425, Dec. 2006.
- [27] E. Candès and M. B. Wakin, "An introduction to compressive sampling," *IEEE Signal Process. Mag.*, pp. 21–30, Mar. 2008.
- [28] D. Donoho, "Compressed sensing," *IEEE Trans. Inf. Theory*, vol. 52, no. 4, pp. 1289–1306, Apr. 2006.
- [29] E. Candès, J. Romberg, and T. Tao, "Robust uncertainty principles: exact signal reconstruction from highly incomplete frequency information," *IEEE Trans. Inf. Theory*, vol. 52, no. 2, pp. 489–509, Feb. 2006.
- [30] A. Beck and M. Teboulle, "A fast iterative shrinkage-thresholding algorithm for linear inverse problems," *SIAM J. Imaging Sciences*, vol. 2, pp. 183–202, 2009.
- [31] J. Tropp and A. Gilbert, "Signal recovery from random measurements via orthogonal matching pursuit," *IEEE Trans. Inf. Theory*, vol. 53, no. 12, pp. 4655–4666, Dec. 2007.
- [32] T. Blumensath and M. E. Davies, "Iterative hard thresholding for compressed sensing," *Applied and Computational Harmonic Analysis*, vol. 27, no. 3, pp. 265–274, 2009.
- [33] Y. C. Eldar and G. Kutyniok, *Compressed Sensing: Theory and Applications*. Cambridge University Press, 2012.
- [34] J. Tropp, A. Gilbert, and M. Strauss, "Algorithms for simultaneous sparse approximation. part ii: Convex relaxation," *Signal Processing, special issue on Sparse approximations in signal and image processing*, vol. 86, no. 4, pp. 589–602, 2006.
- [35] —, "Algorithms for simultaneous sparse approximation. part i: Greedy pursuit," *Signal Processing, special issue on Sparse approximations in signal and image processing*, vol. 86, no. 4, pp. 572–588, 2006.
- [36] M. F. Duarte, M. A. Davenport, D. Takbar, J. N. Laska, T. Sun, K. F. Kelly, and R. G. Baraniuk, "Single-pixel imaging via compressive sampling," *IEEE Signal Process. Mag.*, vol. 25, no. 2, pp. 83–91, Mar. 2008.
- [37] M. Lustig, D. Donoho, J. M. Santos, and J. M. Pauly, "Compressed sensing MRI," *IEEE Signal Process. Mag.*, vol. 25, no. 2, pp. 72–82, Mar. 2008.
- [38] H. Jiang, S. Zhao, Z. Shen, W. Deng, P. A. Wilford, and R. Haimi-Cohen, "Surveillance video analysis using compressive sensing with low latency," *Bell Labs Technical Journal*, vol. 18, no. 4, pp. 63–74, 2014.
- [39] S. Pudlewski and T. Melodia, "A tutorial on encoding and wireless transmission of compressively sampled videos," *IEEE Commun. Surveys Tuts.*, vol. 15, no. 2, pp. 754–767, 2013.
- [40] S. K. Sharma, E. Lagunas, S. Chatzinotas, and B. Ottersten, "Application of compressive sensing in cognitive radio communications: A survey," *IEEE Commun. Surveys Tuts.*, vol. 18, no. 3, pp. 1838–1860, 2016.
- [41] Z. Qin, Y. Liu, Y. Gao, M. El-kashlan, and A. Nallanathan, "Wireless powered cognitive radio networks with compressive sensing and matrix completion," *IEEE Trans. Commun.*, vol. 65, no. 4, pp. 1464–1476, Apr. 2017.
- [42] N. Y. Yu, K. Lee, and J. Choi, "Pilot signal design for compressive sensing based random access in machine-type communications," in *IEEE Wireless Communications and Networking Conference (WCNC)*, San Francisco, CA, 2017.
- [43] Q. Liang, "Compressive sensing for radar sensor networks," in *IEEE Global Telecommunications Conference (GLOBECOM)*, Miami, FL, 2010, pp. 1–5.
- [44] C. Berger, Z. Wang, J. Huang, and S. Zhou, "Application of compressive sensing to sparse channel estimation," *IEEE Commun. Mag.*, vol. 48, no. 11, pp. 164–174, Nov. 2010.
- [45] Y. Peng, X. Yang, X. Zhang, W. Wang, and B. Wu, "Compressed MIMO-OFDM channel estimation," in *Proc. 12th IEEE Int. Conf. Commun. Technol. (ICCT)*, Nov. 2010, pp. 1291–1294.
- [46] R. Mohammadian, A. Amini, and B. H. Khalaj, "Compressive sensing-based pilot design for sparse channel estimation in OFDM systems," *IEEE Commun. Lett.*, vol. 21, no. 1, pp. 4–7, Jan. 2017.
- [47] P. Cheng, Z. Chen, Y. Rui, Y. J. Guo, L. Gui, M. Tao, and Q. T. Zhang, "Channel estimation for OFDM systems over doubly selective channels: A distributed compressive sensing based approach," *IEEE Trans. Commun.*, vol. 61, no. 10, pp. 4173–4185, Oct. 2013.
- [48] M. E. Eltayeb, T. Y. Al-Naffouri, and H. R. Bahrami, "Compressive sensing for feedback reduction in MIMO broadcast channels," *IEEE Trans. Commun.*, vol. 62, no. 9, pp. 3209–3222, Sep. 2014.
- [49] J. Choi, "Beam selection in mm-wave multiuser MIMO systems using compressive sensing," *IEEE Trans. Commun.*, vol. 63, no. 8, pp. 2936–2947, Aug. 2015.
- [50] W. Ding, Y. Lu, F. Yang, W. Dai, P. Li, S. Liu, and J. Song, "Spectrally efficient CSI acquisition for power line communications: A Bayesian compressive sensing perspective," *IEEE J. Sel. Areas Commun.*, vol. 34, no. 7, pp. 2022–2032, July 2014.
- [51] A. Gilbert and P. Indyk, "Sparse recovery using sparse matrices," *Proc. IEEE*, vol. 98, no. 6, pp. 937–947, 2010.
- [52] M. M. Abo-Zahhad, A. I. Hussein, and A. M. Mohamed, "Compressive sensing algorithms for signal processing applications: A survey," *Int. J. Communications, Network and System Sciences*, vol. 8, pp. 197–216, 2015.
- [53] Z. Zhang, Y. Xu, J. Yang, X. Li, and D. Zhang, "A survey of sparse representation: Algorithms and applications," *IEEE Access*, vol. 3, pp. 490–530, 2015.
- [54] A. Rakotomamonjy, "Surveying and comparing simultaneous sparse approximation (or group-Lasso) algorithms," *Signal Process.*, vol. 91, no. 7, pp. 1505–1526, 2011.
- [55] D. Baron, M. B. Wakin, M. F. Duarte, S. Sarvotham, and R. G. Baraniuk, "Distributed compressive sensing," *Rice Univ. Dept. Elect. Comput. Eng. Houston, TX, Tech. Rep. TREE0612*, Nov 2006.
- [56] D. Sundman, S. Chatterjee, and M. Skoglund, "Methods for distributed compressed sensing," *J. Sens. Actuator Netw.*, vol. 3, pp. 1–25, 2014.
- [57] S. Qaisar, R. M. Bilal, W. Iqbal, M. Naureen, and S. Lee, "Compressive sensing: From theory to applications, a survey," *Journal of Commun. and Netw.*, vol. 15, no. 5, pp. 443–456, Oct. 2013.
- [58] J. W. Choi, B. Shim, Y. Ding, B. Rao, and D. I. Kim, "Compressed sensing for wireless communications: Useful tips and tricks," *IEEE Commun. Surveys Tuts.*, vol. 19, no. 3, pp. 1527–1550, 2017.
- [59] M. A. RAZZAQUE, C. BLEAKLEY, and S. DOBSON, "Compression in wireless sensor networks: A survey and comparative evaluation," *ACM Transactions on Sensor Networks*, vol. 10, no. 1, pp. 5:1–5:44, Nov. 2013.
- [60] M. Balouchestani, K. Raahemifar, and S. Krishnan, "Compressed sensing in wireless sensor networks: Survey," *Canadian Journal on Multimedia and Wireless Networks*, vol. 2, no. 1, Feb. 2011.
- [61] H. Sun, A. Nallanathan, C. Wang, and Y. Chen, "Wideband spectrum sensing for cognitive radio networks: A survey," *IEEE Wireless Commun.*, vol. 20, no. 2, pp. 74–81, 2013.
- [62] F. Salahdine, N. Kaaboucha, and H. E. Ghazi, "A survey on compressive sensing techniques for cognitive radio networks," *Physical Communication*, vol. 20, pp. 61–73, 2016.

- [63] H. Huang, S. Misra, W. Tang, H. Barani, and H. Al-Azzawi, "Applications of compressed sensing in communications networks," *arXiv preprint arXiv:1305.3002*, 2013. [Online]. Available: <http://arxiv.org/abs/1305.3002>, 2013.
- [64] S. S. Chen, D. L. Donoho, and M. A. Saunders, "Atomic decomposition by basis pursuit," *SIAM J. Sci. Comput.*, vol. 20, pp. 33–61, 1998.
- [65] R. Tibshirani, "Regression shrinkage and selection via the Lasso," *J. Roy. Stat. Soc. Ser. B*, vol. 58, no. 1, pp. 267–288, 1996.
- [66] P. J. Bickel, Y. Ritov, and A. B. Tsybakov, "Simultaneous analysis of Lasso and dantzig selector," *Ann. Statist.*, vol. 37, no. 4, pp. 1705–1732, 2009.
- [67] E. J. Candès, M. B. Wakin, and S. Boyd, "Enhancing sparsity by reweighted  $l_1$  minimization," *J. Fourier Anal. Appl.*, vol. 14, no. 5–6, pp. 877–905, 2008.
- [68] W. Dai and O. Milenkovic, "Subspace pursuit for compressive sensing signal reconstruction," *IEEE Trans. Inf. Theory*, vol. 55, no. 5, pp. 2230–2249, May 2009.
- [69] D. Needell and J. Tropp, "CoSaMP: Iterative signal recovery from incomplete and inaccurate samples," *Appl. Comput. Harmon. Anal.*, vol. 26, pp. 301–321, 2009.
- [70] T. Blumensath and M. E. Davies, "Iterative thresholding for sparse approximations," *J. Fourier Anal. Appl.*, vol. 14, no. 5, pp. 629–654, 2008.
- [71] D. Needell and R. Vershynin, "Uniform uncertainty principle and signal recovery via regularized orthogonal matching pursuit," *Foundations Computational Math.*, vol. 9, no. 3, pp. 317–334, 2009.
- [72] D. L. Donoho, Y. Tsaig, I. Drori, and J.-L. Starck, "Sparse solution of underdetermined systems of linear equations by stagewise orthogonal matching pursuit," *IEEE Trans. Inf. Theory*, vol. 58, pp. 1094–1121, 2012.
- [73] T. Blumensath and M. Davies, "Normalized iterative hard thresholding: Guaranteed stability and performance," *IEEE J. Sel. Topics Signal Process.*, vol. 4, no. 2, pp. 298–309, Apr. 2010.
- [74] S. Foucart, "Hard thresholding pursuit: an algorithm for compressive sensing," *SIAM J. Numer. Anal.*, vol. 49, no. 6, pp. 2543–2563, 2011.
- [75] S. Ji, Y. Xue, and L. Carin, "Bayesian compressive sensing," *IEEE Trans. Signal Process.*, vol. 56, no. 6, pp. 2346–2356, Jun. 2008.
- [76] D. Wipf and B. Rao, "Sparse Bayesian learning for basis selection," *IEEE Trans. Signal Process.*, vol. 52, no. 8, pp. 2153–2164, Aug. 2004.
- [77] M. Tipping, "Sparse Bayesian learning and the relevance vector machine," *J. Mach. Learn. Res.*, vol. 1, pp. 211–244, 2001.
- [78] S. D. Babacan, R. Molina, and A. K. Katsaggelos, "Bayesian compressive sensing using laplace priors," *IEEE Trans. Image Process.*, vol. 19, no. 1, pp. 53–63, Jan. 2010.
- [79] D. Baron, S. Sarvotham, and R. Baraniuk, "Bayesian compressive sensing via belief propagation," *IEEE Trans. Signal Process.*, vol. 58, no. 1, pp. 269–280, Jan. 2010.
- [80] M. W. Seeger and H. Nickisch, "Compressed sensing and Bayesian experimental design," in *Proc. Int. Conf. Machine Learning (ICML)*, 2008, pp. 912–919.
- [81] T. Peleg, Y. C. Eldar, and M. Elad, "Exploiting statistical dependencies in sparse representations for signal recovery," *IEEE Trans. Signal Process.*, vol. 60, no. 5, pp. 2286–2303, May 2012.
- [82] M. A. Razzaque and S. Dobson, "Energy-efficient sensing in wireless sensor networks using compressed sensing," *Sensors*, vol. 14, pp. 2822–2859, 2014.
- [83] J. Cheng, H. Jiang, X. Ma, L. Liu, L. Qian, C. Tian, and W. Liu, "Efficient data collection with sampling in WSNs: Making use of matrix completion techniques," in *IEEE Global Communications Conference (GLOBECOM)*, Miami, FL, USA, Dec. 2010.
- [84] J. Haupt, W. U. Bajwa, M. Rabbat, and R. Nowak, "Compressed sensing for networked data," *IEEE Signal Process. Mag.*, vol. 25, no. 2, pp. 92–101, Mar. 2008.
- [85] R. Cristescu, B. Beferull-Lozano, and M. Vetterli, "On network correlated data gathering," in *Proc. IEEE Conf. Comput. Commun.*, 2004, pp. 2571–2582.
- [86] P. T. Boufounos and R. G. Baraniuk, "1-bit compressive sensing," in *42nd Annual Conf. on Information Sciences and Systems (CISS)*, Princeton, NJ, Mar. 2008, pp. 16–21.
- [87] A. Gupta, R. Nowak, and B. Recht, "Sample complexity for 1-bit compressed sensing and sparse classification," in *IEEE Int. Symp. on Information Theory (ISIT)*, Austin, TX, June 2010, pp. 1553–1557.
- [88] P. T. Boufounos, "Reconstruction of sparse signals from distorted randomized measurements," in *Proc. Acoust., Speech, Signal Processing (ICASSP)*, Dallas, TX, Mar. 2010, pp. 3998 – 4001.
- [89] L. Jacques, J. N. Laska, P. T. Boufounos, and R. G. Baraniuk, "Robust 1-bit compressive sensing via binary stable embeddings of sparse vectors," *IEEE Trans. Inf. Theory*, vol. 59, no. 4, pp. 2082–2102, 2013.
- [90] P. T. Boufounos, "Greedy sparse signal reconstruction from sign measurements," in *43rd Asilomar Conference on Signals, Systems and Computers*, Pacific Grove, CA, Nov. 2009, pp. 1305–1309.
- [91] J. Chen and X. Huo, "Theoretical results on sparse representations of multiple-measurement vectors," *IEEE Trans. Signal Process.*, vol. 54, no. 12, pp. 4634–4643, Dec. 2006.
- [92] C. Luo, F. Wu, J. Sun, and C. W. Chen, "Compressive data gathering for large-scale wireless sensor networks," in *ACM Mobicom*, Beijing, China, Sep. 2009, pp. 145–156.
- [93] W. Wang, M. Garofalakis, and K. Ramchandran, "Distributed sparse random projections for refinable approximation," in *6th International Symposium on Information Processing in Sensor Networks (IPSN)*, Cambridge, MA, April 2007, pp. 331–339.
- [94] A. Griffin and P. Tsakalides, "Compressed sensing of audio signals using multiple sensors," in *16th European Signal Processing Conference (EUSIPCO 2008)*, Lausanne, Switzerland, Aug 2008.
- [95] M. B. Wakin, M. F. Duarte, S. Sarvotham, D. Baron, and R. G. Baraniuk, "Recovery of jointly sparse signals from few random projections," in *Advances in Neural Information Processing Systems 18 (NIPS 2005)*, Vancouver, British Columbia, Canada, Dec. 2005, pp. 1433–1440.
- [96] M. F. Duarte, M. B. Wakin, D. Baron, S. Sarvotham, and R. G. Baraniuk, "Measurement bounds for sparse signal ensembles via graphical models," *IEEE Trans. Inf. Theory*, vol. 59, no. 7, pp. 4280–4289, Jul. 2013.
- [97] S. F. Cotter, B. D. Rao, K. Engan, and K. Kreutz-Delgado, "Sparse solutions to linear inverse problems with multiple measurement vectors," *IEEE Trans. Signal Process.*, vol. 53, no. 7, pp. 2477–2488, July 2005.
- [98] Q. Ling and Z. Tian, "Decentralized support detection of multiple measurement vectors with joint sparsity," in *Proc. Acoust., Speech, Signal Processing (ICASSP)*, Prague, Czech Republic, 2011, pp. 2996–2999.
- [99] D. Malioutov, M. Cetin, and A. Willsky, "A sparse signal reconstruction perspective for source localization with sensor arrays," *IEEE Trans. Signal Process.*, vol. 53, no. 8, pp. 3010–3022, Aug. 2005.
- [100] M. Stojnic, F. Parvaresh, and B. Hassibi, "On the reconstruction of block-sparse signals with an optimal number of measurements," *IEEE Trans. Signal Process.*, vol. 57, no. 8, pp. 3075–3085, Aug. 2009.
- [101] Y. C. Eldar and H. Rauhut, "Average case analysis of multichannel sparse recovery using convex relaxation," *IEEE Trans. Inf. Theory*, vol. 56, no. 1, pp. 505–519, Jan. 2010.
- [102] H. Lu, X. Long, and J. Lv, "A fast algorithm for recovery of jointly sparse vectors based on the alternating direction methods," *Journal of Machine Learning Research*, vol. 15, pp. 461–469, 2011.
- [103] M. Yuan and Y. Lin, "Model selection and estimation in regression with grouped variables," *Journal of Royal Statistics Society B*, vol. 68, pp. 49–67, 2006.
- [104] Z. Qin, K. Scheinberg, and D. Goldfarb, "Efficient block-coordinate descent algorithms for the group Lasso," *Mathematical Programming Computation*, pp. 1–27, 2010.
- [105] M. Fornasier and H. Rauhut, "Recovery algorithms for vector valued data with joint sparsity constraints," *SIAM J. Numer. Anal.*, vol. 46, no. 2, pp. 577–613, 2008.
- [106] L. Sun, J. Liu, J. Chen, and J. Ye, "Efficient recovery of jointly sparse vectors," in *Advances in Neural Information Processing Systems 22 (NIPS 2009)*, Vancouver, British Columbia, Canada, Dec. 2009, pp. 1812–1820.
- [107] J. D. Blanchard, M. Cermak, D. Hanle, and Y. Jing, "Greedy algorithms for joint sparse recovery," *IEEE Trans. Signal Process.*, vol. 62, no. 7, pp. 1694–1704, Apr. 2014.
- [108] A. Makhzani and S. Valaee, "Reconstruction of jointly sparse signals using iterative hard thresholding," in *IEEE Int. Conf. on Communications (ICC)*, Ottawa, ON, Canada, June 2012, pp. 3564 – 3568.
- [109] S. Foucart, "Recovering jointly sparse vectors via hard thresholding pursuit," in *SAMPTA*, 2011.
- [110] J.-M. Feng and C.-H. Lee, "Generalized subspace pursuit for signal recovery from multiple-measurement vectors," in *IEEE Wireless Communications and Networking Conference (WCNC)*, Shanghai, China, Apr. 2013, pp. 2874–2878.
- [111] D. Wipf and B. Rao, "An empirical Bayesian strategy for solving the simultaneous sparse approximation problem," *IEEE Trans. Signal Process.*, vol. 55, no. 7, pp. 3704–3716, July 2007.
- [112] J. Ziniel and P. Schniter, "Efficient high-dimensional inference in the multiple measurement vector problem," *IEEE J. Sel. Topics Signal Process.*, vol. 61, no. 2, pp. 340–354, 2013.

- [113] M. Al-Shoukairi and B. Rao, "Sparse Bayesian learning using approximate message passing," in *48th Asilomar Conference on Signals, Systems and Computers*, Pacific Grove, CA, Nov. 2014, pp. 1957–1961.
- [114] Z. Zhang and B. D. Rao, "Sparse signal recovery with temporally correlated source vectors using sparse Bayesian learning," *IEEE J. Sel. Topics Signal Process.*, vol. 5, no. 5, pp. 912–926, 2011.
- [115] S. Ji, D. Dunson, and L. Carin, "Multitask compressive sensing," *IEEE Trans. Signal Process.*, vol. 57, no. 1, pp. 92–106, Jan. 2009.
- [116] Q. Wu, Y. D. Zhang, M. G. Amin, and B. Himed, "Multi-task Bayesian compressive sensing exploiting intra-task dependency," *IEEE Signal Process. Lett.*, vol. 22, no. 4, pp. 430–434, Apr. 2015.
- [117] G. Tzagkarakis, D. Miliotis, and P. Tsakalides, "Multiple-measurement Bayesian compressed sensing using GSM priors for DOA estimation," in *Proc. Acoust., Speech, Signal Processing (ICASSP)*, Dallas, TX, Mar 2010, pp. 2610–2613.
- [118] M. E. Davies and Y. C. Eldar, "Rank awareness in joint sparse recovery," *IEEE Trans. Inf. Theory*, vol. 58, no. 2, pp. 1135–1146, Feb. 2012.
- [119] Y. C. Eldar and M. Mishali, "Robust recovery of signals from a structured union of subspaces," *IEEE Trans. Inf. Theory*, vol. 55, no. 11, pp. 5302–5316, Nov. 2009.
- [120] Z. Zhang and B. D. Rao, "Extension of SBL algorithms for the recovery of block sparse signals with intra-block correlation," *IEEE Trans. Signal Process.*, vol. 61, no. 8, pp. 2009–2015, Apr. 2013.
- [121] J. Matamoros, S. M. Fosson, E. Magli, and C. Antón-Haro, "Distributed admm for in-network reconstruction of sparse signals with innovations," *IEEE Trans. on Signal and Inf. Process. over Netw.*, vol. 1, no. 4, Dec. 2015.
- [122] W. Zhang, C. Ma, W. Wang, Y. Liu, and L. Zhang, "Side information based orthogonal matching pursuit in distributed compressed sensing," in *IEEE Int. Conf. Netw. Infrastruct. Digit. Content*, Beijing, China, Jan. 2010, pp. 80–84.
- [123] D. Valsesia, G. Coluccia, and E. Magli, "Joint recovery algorithms using difference of innovations for distributed compressed sensing," in *47th Asilomar Conference on Signals, Systems and Computers*, Pacific Grove, CA, Nov. 2013, pp. 414–417.
- [124] J.-F. Determe, J. Louveaux, L. Jacques, and F. Horlin, "On the noise robustness of simultaneous orthogonal matching pursuit," *IEEE Trans. Signal Process.*, vol. 65, no. 4, pp. 864–875, Feb. 2017.
- [125] C. Caione, D. Brunelli, and L. Benini, "Compressive sensing optimization for signal ensembles in WSNs," *IEEE Trans. Ind. Informat.*, vol. 10, no. 1, pp. 382–392, Feb. 2014.
- [126] Z. Chen, J. Ranieri, R. Zhang, and M. Vetterli, "DASS: Distributed adaptive sparse sensing," *IEEE Trans. Wireless Commun.*, vol. 14, no. 5, pp. 2571–2583, May 2015.
- [127] Q. Ling, Z. Wen, and W. Yin, "Decentralized jointly sparse optimization by reweighted  $l_q$  minimization," *IEEE Trans. Signal Process.*, vol. 61, no. 5, Mar. 2013.
- [128] S. M. Fosson, J. Matamoros, C. Antn-Haro, and E. Magli, "Distributed recovery of jointly sparse signals under communication constraints," *IEEE Trans. Signal Process.*, vol. 64, no. 13, July 2016.
- [129] N. Ramakrishnan, E. Ertin, and R. L. Moses, "Decentralized recovery of sparse signals for sensor network applications," in *IEEE Statistical Signal Processing Workshop (SSP)*, Nice, France, June 2011, pp. 233–236.
- [130] F. Zeng, C. Li, and Z. Tian, "Distributed compressive spectrum sensing in cooperative multihop cognitive networks," *IEEE J. Sel. Topics Signal Process.*, vol. 5, no. 1, pp. 37–48, Feb. 2011.
- [131] J. F. C. Mota, J. M. F. Xavier, P. M. Q. Aguiar, and M. Puschel, "Distributed basis pursuit," *IEEE Trans. Signal Process.*, vol. 60, no. 4, pp. 1942–1956, Apr. 2012.
- [132] J. A. Bazerque and G. B. Giannakis, "Distributed spectrum sensing for cognitive radio networks by exploiting sparsity," *IEEE Trans. Signal Process.*, vol. 58, no. 3, pp. 1847–1862, Mar. 2010.
- [133] G. Mateos, J. A. Bazerque, and G. B. Giannakis, "Distributed sparse linear regression," *IEEE Trans. Signal Process.*, vol. 58, no. 10, pp. 5262–5276, Oct. 2010.
- [134] D. Sundman, S. Chatterjee, and M. Skoglund, "Distributed greedy pursuit algorithms," *Signal Process.*, vol. 105, pp. 298–315, 2014.
- [135] T. Wimalajeewa and P. K. Varshney, "Cooperative sparsity pattern recovery in distributed networks via distributed-OMP," in *Proc. Acoust., Speech, Signal Processing (ICASSP)*, Vancouver, BC, May 2013, pp. 5288–5292.
- [136] —, "OMP based joint sparsity pattern recovery under communication constraints," *IEEE Trans. Signal Process.*, vol. 62, no. 19, pp. 5059–5072, Oct. 2014.
- [137] D. Sundman, S. Chatterjee, and M. Skoglund, "A greedy pursuit algorithm for distributed compressed sensing," in *Proc. Acoust., Speech, Signal Processing (ICASSP)*, Kyoto, Japan, Mar. 2012, pp. 2729–2732.
- [138] G. Li, T. Wimalajeewa, and P. K. Varshney, "Decentralized subspace pursuit for joint sparsity pattern recovery," in *Proc. Acoust., Speech, Signal Processing (ICASSP)*, May 2014, pp. 3365–3369.
- [139] —, "Decentralized and collaborative subspace pursuit: A communication-efficient algorithm for joint sparsity pattern recovery with sensor networks," *IEEE Trans. Signal Process.*, vol. 64, no. 3, pp. 556–566, Feb. 2016.
- [140] D. Sundman, S. Chatterjee, and M. Skoglund, "Design and analysis of a greedy pursuit for distributed compressed sensing," *IEEE Trans. Signal Process.*, vol. 64, no. 11, pp. 2803–2818, June 2016.
- [141] S. Patterson, Y. C. Eldar, and I. Keidar, "Distributed sparse signal recovery for sensor networks," in *Proc. Acoust., Speech, Signal Processing (ICASSP)*, Vancouver, Canada, May 2013.
- [142] A. Makhzani and S. Valaee, "Distributed spectrum sensing in cognitive radios via graphical models," in *Proc. Comput. Adv. Multi-Sens. Adaptive Process.*, 2013, pp. 376–379.
- [143] S. Khanna and C. R. Murthy, "Decentralized joint-sparse signal recovery: A sparse Bayesian learning approach," *IEEE Trans. on Signal and Inf. Process. over Netw.*, vol. 3, no. 1, Mar. 2017.
- [144] S. M. Fosson, J. Matamoros, C. Antn-Haro, and E. Magli, "Distributed support detection of jointly sparse signals," in *Proc. Acoust., Speech, Signal Processing (ICASSP)*, Florence, Italy, 2014, pp. 6434–6438.
- [145] S. Patterson, Y. C. Eldar, and I. Keidar, "Distributed compressed sensing for static and time-varying networks," *IEEE Trans. Signal Process.*, vol. 62, no. 19, pp. 4931–4946, Oct. 2014.
- [146] W. Chen and I. J. Wassell, "A decentralized Bayesian algorithm for distributed compressive sensing in networked sensing systems," *IEEE Trans. Wireless Commun.*, vol. 15, no. 2, pp. 1282–1292, 2016.
- [147] W. Bajwa, J. Haupt, A. Sayeed, and R. Nowak, "Joint sourcechannel communication for distributed estimation in sensor networks," *IEEE Trans. Inf. Theory*, vol. 53, no. 10, pp. 3629–3653, Oct. 2007.
- [148] C. Luo, F. Wu, J. Sun, and C. W. Chen, "Efficient measurement generation and pervasive sparsity for compressive data gathering," *IEEE Trans. Wireless Commun.*, vol. 9, no. 12, pp. 3728–3738, Dec. 2010.
- [149] H. Zheng, S. Xiao, X. Wang, X. Tian, and M. Guizani, "Capacity and delay analysis for data gathering with compressive sensing in wireless sensor networks," *IEEE Trans. Wireless Commun.*, vol. 12, no. 2, pp. 917–927, Feb. 2013.
- [150] X.-Y. Liu, Y. Zhu, L. Kong, C. Liu, Y. Gu, A. V. Vasilakos, and M.-Y. Wu, "CDC: Compressive data collection for wireless sensor networks," *IEEE Trans. Parallel Distrib. Syst.*, vol. 26, no. 8, pp. 2188–2197, Aug. 2015.
- [151] Y. Tang, B. Zhang, T. Jing, D. Wu, and X. Cheng, "Robust compressive data gathering in wireless sensor networks," *IEEE Trans. Wireless Commun.*, vol. 12, no. 6, pp. 2754–2761, June 2013.
- [152] Y. Shen, W. Hu, R. Rana, and C. T. Chou, "Nonuniform compressive sensing for heterogeneous wireless sensor networks," *IEEE Sensors Journal*, pp. 2120–2128, June 2013.
- [153] G. Yang, V. Y. F. Tan, C. K. Ho, S. H. Ting, and Y. L. Guan, "Wireless compressive sensing for energy harvesting sensor nodes," *IEEE Trans. Signal Process.*, vol. 61, no. 18, pp. 4491–4505, Sept. 2013.
- [154] T. Wimalajeewa and P. K. Varshney, "Wireless compressive sensing over fading channels with distributed sparse random projections," *IEEE Trans. Signal and Inf. Process. over Netw.*, vol. 1, no. 1, Mar. 2015.
- [155] W. Wang, M. J. Wainwright, and K. Ramchandran, "Information-theoretic limits on sparse signal recovery: Dense versus sparse measurement matrices," *IEEE Trans. Inf. Theory*, vol. 56, no. 6, pp. 2967–2979, Jun. 2010.
- [156] D. Achlioptas, "Database-friendly random projections: Johnson-lindenstrauss with binary coins," *Journal of Computer and System Sciences*, vol. 66, no. 4, pp. 671–687, 2003.
- [157] P. Li, T. Hastie, and K. Church, "Very sparse random projections," in *Proceedings of the 12th ACM SIGKDD international conference on Knowledge discovery and data mining (KDD)*, April 2006, pp. 287–296.
- [158] D. Ebrahimi and C. Assi, "Optimal and efficient algorithms for projection-based compressive data gathering," *IEEE Commun. Lett.*, vol. 17, no. 8, pp. 1572–1575, Aug. 2013.
- [159] X. Wu, Y. Xiong, P. Yang, S. Wan, and W. Huang, "Sparsest random scheduling for compressive data gathering in wireless sensor networks," *IEEE Trans. Wireless Commun.*, vol. 13, no. 10, pp. 5867–5877, Oct. 2014.

- [160] D. Ebrahimi and C. Assi, "On the interaction between scheduling and compressive data gathering in wireless sensor networks," *IEEE Trans. Wireless Commun.*, vol. 15, no. 4, pp. 2845–2858, Apr. 2016.
- [161] H. Zheng, W. Guo, X. Feng, and Z. Chen, "Design and analysis of in-network computation protocols with compressive sensing in wireless sensor networks," *IEEE Access*, vol. 5, pp. 11 015–11 029, 2017.
- [162] L. Xiang, J. Luo, and A. Vasilakos, "Compressed data aggregation for energy efficient wireless sensor networks," in *8th Annual IEEE Communications Society Conference on Sensor, Mesh and Ad Hoc Communications and Networks (SECON)*, Salt Lake City, UT, June 2011, pp. 46–54.
- [163] P. Indyk, E. Price, and D. P. Woodruff, "On the power of adaptivity in sparse recovery," *Proc. IEEE Foundat. Comput. Sci. (FOCS) Annu. Symp.*, pp. 285–294, Oct. 2011.
- [164] C. T. Chou, R. Rana, and W. Hu, "Energy efficient information collection in wireless sensor networks using adaptive compressive sensing," in *IEEE 34th Conference on Local Computer Networks (LCN 2009)*, Zürich, Switzerland, Oct. 2009, pp. 443–450.
- [165] J. Wang, S. Tang, B. Yin, and X.-Y. Li, "Data gathering in wireless sensor networks through intelligent compressive sensing," in *IEEE Proc. INFOCOM*, Orlando, FL, 2012, pp. 603–611.
- [166] F. A. Aderohunmu, D. Brunelli, J. D. Deng, and M. K. Purvis, "A data acquisition protocol for a reactive wireless sensor network monitoring application," *Sensors*, vol. 15, pp. 10 221–10 254, 2015.
- [167] J. Yin, Y. Yang, and L. Wang, "An adaptive data gathering scheme for Multi-Hop wireless sensor networks based on compressed sensing and network coding," *Sensors*, vol. 16, no. 462, pp. 1–22, 2016.
- [168] Q. Ling and Z. Tian, "Decentralized sparse signal recovery for compressive sleeping wireless sensor networks," *IEEE Trans. Signal Process.*, vol. 58, no. 7, pp. 3816–3827, July 2010.
- [169] K. Yuan, Q. Ling, and Z. Tian, "Communication-efficient decentralized event monitoring in wireless sensor networks," *IEEE Trans. Parallel Distrib. Syst.*, vol. 26, no. 8, pp. 2198–2207, Aug. 2015.
- [170] B. Q. Ali, N. Pissinou, and K. Makki, "Identification and validation of spatio-temporal associations in wireless sensor networks," in *Third Int. Conf. on Sensor Technologies and Applications (SENSORCOMM)*, Athens, Greece, June 2009, pp. 496–501.
- [171] J. Cheng, Q. Ye, H. Jiang, D. Wang, and C. Wang, "STCDG: An efficient data gathering algorithm based on matrix completion for wireless sensor networks," *IEEE Trans. Wireless Commun.*, vol. 12, no. 2, pp. 850–861, 2013.
- [172] L. Quan, S. Xiao, X. Xue, and C. Lu, "Neighbor-aided spatial-temporal compressive data gathering in wireless sensor networks," *IEEE Commun. Lett.*, vol. 20, no. 3, pp. 578–581, Mar. 2016.
- [173] M. Leinonen, M. Codreanu, and M. Juntti, "Sequential compressed sensing with progressive signal reconstruction in wireless sensor networks," *IEEE Trans. Wireless Commun.*, vol. 14, no. 3, pp. 1622–1635, Mar. 2015.
- [174] E. Candès and B. Recht, "Exact matrix completion via convex optimization," *Foundations of Computational Mathematics*, vol. 9, pp. 717–772, 2009.
- [175] M. Vuran, O. Akan, and I. Akyildiz, "Spatio-temporal correlation: Theory and applications for wireless sensor networks," *Comput. Networks (Elsevier)*, vol. 45, no. 3, pp. 245–259, 2004.
- [176] B. Recht, M. Fazel, and P. A. Parrilo, "Coherence pattern-guided compressive sensing with unresolved grids," *SIAM Review*, vol. 52, no. 3, pp. 471–501, 2010.
- [177] S. data from intel berkeley research lab, "http://db.lcs.mit.edu/labdata/labdata.html."
- [178] M. F. Duarte and R. G. Baraniuk, "Kronecker compressive sensing," *IEEE Trans. Image Process.*, vol. 21, no. 2, pp. 494–504, 2012.
- [179] B. Gong, P. Cheng, Z. Chen, N. Liu, L. Gui, and F. de Hoog, "Spatiotemporal compressive network coding for energy-efficient distributed data storage in wireless sensor networks," *IEEE Commun. Lett.*, vol. 19, no. 5, pp. 803–806, May 2015.
- [180] X. Li, X. Tao, and Z. Chen, "Spatio-temporal compressive sensing-based data gathering in wireless sensor networks," *IEEE Wireless Commun. Lett.*, vol. 7, no. 2, pp. 198–201, Apr. 2018.
- [181] P. K. Varshney, *Distributed Detection and Data Fusion*. Springer, New York, NY, USA, 1997.
- [182] G. Wittenburg, N. Dziengel, S. Adler, Z. Kismi, M. Ziegert, and J. Schiller, "Cooperative event detection in wireless sensor networks," *IEEE Commun. Mag.*, vol. 50, no. 12, pp. 124 – 131, Dec. 2012.
- [183] J. Meng, H. Li, and Z. Han, "Sparse event detection in wireless sensor networks using compressive sensing," in *43rd Annual Conf. on Information Sciences and Systems (CISS)*, Baltimore, MD, Mar. 2009, pp. 181 – 185.
- [184] A. Alwakeel, M. Abdelkader, K. G. Seddik, and A. Ghuniem, "Adaptive low power detection of sparse events in wireless sensor networks," in *IEEE Wireless Communication and Networking Conference (WCNC)*, Istanbul, Turkey, Apr. 2014, pp. 3414–3419.
- [185] M. Shirvanimoghaddam, Y. Li, and B. Vucetic, "Sparse event detection in wireless sensor networks using analog fountain codes," in *IEEE Global Communications Conference (GLOBECOM)*, Austin, TX, 2014, pp. 3520–3525.
- [186] L. L. Scharf and B. Friedlander, "Matched subspace detectors," *IEEE Tran. Signal Process.*, vol. 42, no. 8, pp. 2146 – 2157, Aug. 1994.
- [187] L. T. McWhorter and L. L. Scharf, "Matched subspace detectors for stochastic signals," in *11th Ann. Workshop on Adaptive Sensor Array Process. (ASAP)*, Lexington, MA, Mar. 2003.
- [188] Y. Jin and B. Friedlander, "A CFAR adaptive subspace detector for second-order gaussian signal," *IEEE Tran. Signal Process.*, vol. 53, no. 3, pp. 871 – 884, Mar. 2005.
- [189] S. M. Kay, *Fundamentals of Statistical Signal Processing Vol:II - Detection Theory*. Prentice Hall, 1998.
- [190] J. Haupt and R. Nowak, "Compressive sampling for signal detection," in *Proc. Acoust., Speech, Signal Processing (ICASSP)*, vol. 3, Honolulu, Hawaii, Apr. 2007, pp. III–1509 – III–1512.
- [191] M. F. Duarte, M. A. Davenport, M. B. Wakin, and R. G. Baraniuk, "Sparse signal detection from incoherent projections," in *Proc. Acoust., Speech, Signal Processing (ICASSP)*, vol. III, Toulouse, France, May 2006, pp. 305–308.
- [192] G. Li, H. Zhang, T. Wimalajeewa, and P. K. Varshney, "On the detection of sparse signals with sensor networks based on Subspace Pursuit," in *IEEE Global Conference on Signal and Information Processing (GlobalSIP)*, Atlanta, GA, Dec. 2014, pp. 438–442.
- [193] T. Wimalajeewa and P. K. Varshney, "Sparse signal detection with compressive measurements via partial support set estimation," *IEEE Trans. on Signal and Inf. Process. over Netw.*, vol. 3, no. 1, Mar. 2017.
- [194] A. Hariri and M. Babaie-Zadeh, "Compressive detection of sparse signals in additive white gaussian noise without signal reconstruction," *Signal Process.*, vol. 131, pp. 376–385, 2017.
- [195] M. A. Davenport, P. T. Boufounos, M. B. Wakin, and R. Baraniuk, "Signal processing with compressive measurements," *IEEE J. Sel. Topics Signal Process.*, vol. 4, no. 2, pp. 445 – 460, Apr. 2010.
- [196] B. Kailkhura, T. Wimalajeewa, and P. K. Varshney, "Collaborative compressive detection with physical layer secrecy constraints," *IEEE Trans. Signal Process.*, vol. 65, no. 4, pp. 1013–1025, Feb. 2017.
- [197] T. Wimalajeewa and P. K. Varshney, "Compressive sensing-based detection with multimodal dependent data," *IEEE Trans. Signal Process.*, vol. 66, no. 3, pp. 627–640, Feb.
- [198] H. Zheng, S. Xiao, and X. Wang, "Sequential compressive target detection in wireless sensor networks," in *IEEE Int. Conf. on Communications (ICC)*, Kyoto, Japan, June 2011, pp. 1 –5.
- [199] B. S. M. R. Rao, S. Chatterjee, and B. Ottersten, "Detection of sparse random signals using compressive measurements," in *Proc. Acoust., Speech, Signal Processing (ICASSP)*, Kyoto, Japan, 2012, pp. 3257–3260.
- [200] A. Razavi, M. Valkama, and D. Cabric, "Compressive detection of random subspace signals," *IEEE Trans. Signal Process.*, vol. 64, no. 16, pp. 4166–4179, Aug. 2016.
- [201] Z. Wang, G. Arce, and B. Sadler, "Subspace compressive detection for sparse signals," in *Proc. Acoust., Speech, Signal Processing (ICASSP)*, Las Vegas, NV, Mar. 2008, pp. 3873–3876.
- [202] R. Zahedi, A. Pezeshki, and E. K. Chong, "Measurement design for detecting sparse signals," *Physical Communication, Compressive Sensing in Communications*, vol. 5, no. 2, pp. 64–75, 2012.
- [203] H. Bai, Z. Zhu, G. Li, and S. Li, "Design of optimal measurement matrix for compressive detection," in *The Tenth International Symposium on Wireless Communication Systems*, Berlin, Germany, 2013, pp. 691–695.
- [204] B. Kailkhura, S. Liu, T. Wimalajeewa, and P. K. Varshney, "Measurement matrix design for compressed detection with secrecy guarantees," *IEEE Wireless Commun. Lett.*, vol. 5, no. 4, pp. 420–423, Aug. 2016.
- [205] J. Cao and Z. Lin, "Bayesian signal detection with compressed measurements," *Information Sciences*, pp. 241–253, 2014.
- [206] T. Wimalajeewa and P. K. Varshney, "Robust detection of random events with spatially correlated data in wireless sensor networks via distributed compressive sensing," in *Proc. Comput. Adv. Multi-Sens. Adaptive Process.*, Curacao, Dutch Antilles, 2017.
- [207] M. A. Davenport, M. F. Duarte, M. B. Wakin, J. N. Laska, D. Takhar, K. F. Kelly, and R. G. Baraniuk, "The smashed filter for compressive classification and target recognition," in *Proc. SPIE*, 2007.

- [208] T. Wimalajeewa, H. Chen, and P. K. Varshney, "Performance limits of compressive sensing-based signal classification," *IEEE Trans. on Signal Process.*, vol. 60, no. 6, pp. 2758–2770, June 2012.
- [209] J. Vila-Forcen, A. Artes-Rodriguez, and J. Garcia-Frias, "Compressive sensing detection of stochastic signals," in *42nd Annual Conf. on Information Sciences and Systems (CISS)*, Mar. 2008, pp. 956–960.
- [210] J. Wright, A. Yang, A. Ganesh, S. Sastry, and Y. Ma, "Robust face recognition via sparse representation," *IEEE Trans. on Pattern Anal. and Mach. Intell.*, vol. 31, no. 2, pp. 210–227, Feb. 2009.
- [211] T. N. Sainath, A. Carmi, D. Kanevsky, and B. Ramabhadran, "Bayesian compressive sensing for phonetic classification," in *Proc. Acoust., Speech, Signal Processing (ICASSP)*, Dallas, TX, Mar. 2010, pp. 4370–4373.
- [212] K. Huang and S. Aviyente, "Sparse representation for signal classification," in *Proceedings of the 19th International Conference on Neural Information Processing Systems (NIPS)*, Cambridge, MA, Dec. 2006, pp. 609–616.
- [213] H. Cao, Y. T. Chan, , and H. C. So, "Maximum likelihood TDOA estimation from compressed sensing samples without reconstruction," *IEEE Signal Process. Lett.*, vol. 24, no. 5, pp. 564–568, 2017.
- [214] A. Fannjiang and W. Liao, "Coherence pattern-guided compressive sensing with unresolved grids," *SIAM J. Imag. Sci.*, vol. 5, no. 1, pp. 179–202, 2012.
- [215] M. F. Duarte and R. G. Baraniuk, "Spectral compressive sensing," *Appl. and Computat. Harmonic Anal.*, vol. 35, no. 1, pp. 111–129, July 2013.
- [216] S. V. Dinesh Ramasamy and U. Madhow, "Compressive parameter estimation in AWGN," *IEEE Trans. on Signal Process.*, vol. 62, no. 8, pp. 2012–2027, Apr. 2014.
- [217] L. Liu, J.-S. Chong, X.-Q. Wang, and W. Hong, "Adaptive source location estimation based on compressed sensing in wireless sensor networks," *International Journal of Distributed Sensor Networks*, p. 15 pages, 2012.
- [218] C. Feng, S. Valaee, and Z. H. Tan, "Multiple target localization using compressive sensing," in *IEEE Global Telecommunications Conference (GLOBECOM)*, Honolulu, HI, Dec. 2009.
- [219] S. Nikitaki and P. Tsakalides, "Localization in wireless networks based on jointly compressed sensing," in *19th Eur. Signal Process. Conf.*, Barcelona, Spain, Aug. 2011, pp. 1–5.
- [220] B. Zhang, X. Cheng, N. Zhang, Y. Cui, Y. Li, and Q. Liang, "Sparse target counting and localization in sensor networks based on compressive sensing," in *IEEE Proc. INFOCOM*, Shanghai, China, Apr. 2011, pp. 2255–2263.
- [221] E. Lagunas, S. K. Sharma, S. Chatzinotas, and B. Ottersten, "Compressive sensing based target counting and localization exploiting joint sparsity," in *Proc. Acoust., Speech, Signal Processing (ICASSP)*, Shanghai, China, Mar. 2016, pp. 3231–3235.
- [222] B. Sun, Y. Guo, N. Li, and D. Fang, "Multiple target counting and localization using variational bayesian EM algorithm in wireless sensor networks," *IEEE Trans. Commun.*, vol. 65, no. 7, pp. 2985–2998, July 2017.
- [223] —, "An efficient counting and localization framework for off-grid targets in wsns," *IEEE Commun. Lett.*, vol. 21, no. 4, pp. 809–812, Apr. 2017.
- [224] Z. Xiahou and X. Zhang, "Adaptive localization in wireless sensor network through Bayesian compressive sensing," *International Journal of Distributed Sensor Networks*, vol. 11, no. 8, p. 13 pages, Aug. 2015.
- [225] V. Cevher, P. Boufounos, R. G. Baraniuk, A. C. Gilbert, and M. J. Strauss, "Near-optimal Bayesian localization via incoherence and sparsity," in *Int. Workshop on Information Processing in Sensor Networks (IPSN)*, San Francisco, CA, Apr. 2009, pp. 205–216.
- [226] S. Joshi and S. Boyd, "Sensor selection via convex optimization," *IEEE Trans. Signal Process.*, vol. 57, no. 2, pp. 451–462, Feb. 2009.
- [227] F. Zhao, J. Shin, and J. Reich, "Information-driven dynamic sensor collaboration," *IEEE Signal Process. Mag.*, vol. 19, no. 2, pp. 61–72, Mar. 2002.
- [228] A. Carmi and P. Gurfil, "Sensor selection via compressed sensing," *Automatica*, pp. 3304–3314, Nov. 2013.
- [229] J.-Y. Wu, M.-H. Yang, and T.-Y. Wang, "Energy-efficient sensor censoring for compressive distributed sparse signal recovery," *IEEE Trans. Commun.*, vol. 66, no. 5, pp. 2137–2152, May 2018.
- [230] H. Jamali-Rad, A. Simonetto, and G. Leus, "Sparsity-aware sensor selection: Centralized and distributed algorithms," *IEEE Signal Process. Lett.*, vol. 21, no. 2, pp. 217–220, 2014.
- [231] S. Liu, S. Kar, M. Fardad, and P. K. Varshney, "Sparsity-aware sensor collaboration for linear coherent estimation," *IEEE Trans. Signal Process.*, vol. 63, no. 10, pp. 2582–2596, May 2015.
- [232] S. P. Chepuri, , and G. Leus, "Sparsity-promoting sensor selection for non-linear measurement models," *IEEE Trans. Signal Process.*, vol. 63, no. 3, pp. 684–698, Feb. 2015.
- [233] E. Masazade, M. Fardad, and P. K. Varshney, "Sparsity-promoting extended kalman filtering for target tracking in wireless sensor networks," *IEEE Signal Process. Lett.*, vol. 19, no. 12, pp. 845–848, 2012.
- [234] Y. Zheng, N. Cao, T. Wimalajeewa, and P. K. Varshney, "Compressive sensing based probabilistic sensor management for target tracking in wireless sensor networks," *IEEE Trans. Signal Process.*, vol. 63, no. 22, pp. 6049–6060, Nov. 2015.
- [235] W. Chen and I. J. Wassell, "Optimized node selection for compressive sleeping wireless sensor networks," *IEEE Trans. Veh. Technol.*, vol. 65, no. 2, pp. 827–836, Feb. 2016.
- [236] G. Yang, V. Y. F. Tan, C. K. Ho, S. H. Ting, and Y. L. Guan, "Wireless compressive sensing for energy harvesting sensor nodes over fading channels," in *IEEE Int. Conf. on Communications (ICC)*, Budapest, Hungary, June 2013, pp. 4962–4967.
- [237] H. Rauhut, "Compressive sensing and structured random matrices," in *M. Fornasier, editor, Theoretical Foundations and Numerical Methods for Sparse Recovery, of Radon Series Comp. Appl. Math. deGruyter*, vol. 9, 2010.
- [238] F. Chen, F. Lim, O. Abari, A. Chandrakasan, and V. Stojanović, "Energy-aware design of compressed sensing systems for wireless sensors under performance and reliability constraints," *IEEE Trans. Circuits Syst.*, vol. 60, no. 3, pp. 650–661, Mar. 2013.
- [239] D. H. Chae, P. Sadeghi, and R. A. Kennedy, "Robustness of compressive sensing under multiplicative perturbations: The challenge of fading channels," in *Military Communication Conference, MILCOM*, Oct.-Nov. 2010.
- [240] F. Fazel, M. Fazel, and M. Stojanovic, "Random access compressed sensing for energy-efficient underwater sensor networks," *IEEE J. Sel. Areas Commun.*, vol. 29, no. 8, pp. 1660–1670, Sept. 2011.
- [241] —, "Random access compressed sensing over fading and noisy communication channels," *IEEE Trans. Wireless Commun.*, vol. 12, no. 5, pp. 2114–2125, May 2013.
- [242] J. Choi, J. Ha, and H. Jeon, "Physical layer security for wireless sensor networks," in *Proc. IEEE 24th Int. Symp. Pers. Indoor Mobile Radio Commun.*, Sep. 2013, pp. 1–6.
- [243] S. Agrawal and S. Vishwanath, "Secrecy using compressive sensing," in *IEEE Proc. Inf. Theory Workshop*, Paraty, Brazil, Oct. 2011, pp. 563–567.
- [244] Y. Rachlin and D. Baron, "The secrecy of compressed sensing measurements," in *Proc. 46th Annu. Allerton Conf. Commun. Control Comput.*, Sep. 2008, pp. 813–817.
- [245] J. E. Barceló-Lladó, A. Morell, and G. Seco-Granados, "Amplify-and-forward compressed sensing as a physical-layer secrecy solution in wireless sensor networks," *IEEE Trans. Inf. Forensics Security*, vol. 9, no. 5, pp. 839–850, May 2014.
- [246] R. Dautov and G. R. Tsouri, "Establishing secure measurement matrix for compressed sensing using wireless physical layer security," in *Int. Conf. on Computing, Networking and Communications (ICNC)*, 2013, pp. 354–358.
- [247] E. T. Hale, W. Yin, and Y. Zhang, "A fixed-point continuation method for  $l_1$ -regularized minimization with applications to compressed sensing," *Rice University, CAAM Tech. Report TR07-07*, July 2007.
- [248] J. N. Laska, Z. Wen, W. Yin, and R. G. Baraniuk, "Trust, but verify: Fast and accurate signal recovery from 1-bit compressive measurements," *IEEE Trans. Signal Process.*, vol. 59, no. 11, pp. 5289–5301, Nov. 2011.
- [249] Y. Plan and R. Vershynin, "One-bit compressed sensing by linear programming," *Comm. Pure Appl. Math.*, vol. 66, no. 8, pp. 1275–1297, 2013.
- [250] J. Fang, Y. Shen, H. Li, and Z. Ren, "Sparse signal recovery from one-bit quantized data: An iterative reweighted algorithm," *Signal Processing*, vol. 102, pp. 201–206, 2014.
- [251] Y. Shen, J. Fang, and H. L., "One-bit compressive sensing and source localization in wireless sensor networks," in *IEEE China Summit & International Conference on Signal and Information Processing (ChinaSIP)*, July 2013.
- [252] P. North and D. Needell, "One-bit compressive sensing with partial support," *arXiv preprint [Online]*. Available: <https://arxiv.org/abs/1506.00998v1>, 2015.
- [253] Y. Xu, Y. Kabashima, and L. Zdeborová, "Bayesian signal reconstruction for 1-bit compressed sensing," *Journal of Statistical Mechanics: Theory and Experiment*, vol. 11, 2014.



- [254] U. S. Kamilov, A. Bourquard, A. Amini, and M. Unser, "One-bit measurements with adaptive thresholds," *IEEE Signal Process. Lett.*, vol. 19, no. 10, pp. 607–610, Oct. 2012.
- [255] S. Chen and A. Banerjee, "One-bit compressed sensing with the k-support norm," in *In International Conference on Artificial Intelligence and Statistics (AISTATS)*, San Diego, CA, 2015, pp. 138–146.
- [256] M. P. A. M. McDonald and D. Stamos, "Spectral k-support norm regularization," in *Advances in Neural Information Processing Systems 27 (NIPS 2014)*, 2014, pp. 3644–3652.
- [257] L. Zhang, J. Yi, and R. Jin, "Efficient algorithms for robust one-bit compressive sensing," in *Proceedings of the 31st International Conference on Machine Learning (ICML)*, Beijing, China, 2014, pp. 820–828.
- [258] R. G. Baraniuk, S. Foucart, D. Needell, Y. Plan, and M. Wootters, "Exponential decay of reconstruction error from binary measurements of sparse signals," *IEEE Trans. Inf. Theory*, vol. 63, no. 6, pp. 3368–3385, June 2017.
- [259] J. Fang, Y. Shen, L. Yang, and H. Li, "Adaptive one-bit quantization for compressed sensing," *Signal Processing*, vol. 125, pp. 145–155, 2016.
- [260] K. Knudson, R. Saab, and R. Ward, "One-bit compressive sensing with norm estimation," *IEEE Trans. Inf. Theory*, vol. 62, no. 5, pp. 2748–2758, May 2016.
- [261] A. Zymnis, S. Boyd, and E. Candes, "Compressed sensing with quantized measurements," *IEEE Signal Process. Lett.*, vol. 17, no. 2, pp. 149–152, Feb. 2010.
- [262] T. Wimalajeewa and P. K. Varshney, "Performance bounds for sparsity pattern recovery with quantized noisy random projections," *IEEE J. Sel. Topics Signal Process.*, vol. 6, no. 1, pp. 43–57, Feb. 2012.
- [263] L. Jacques, D. K. Hammond, and J. M. Fadili, "Dequantizing compressed sensing: When oversampling and non-gaussian constraints combine," *IEEE Trans. Inf. Theory*, vol. 57, no. 1, pp. 3368–3385, Jan. 2011.
- [264] W. Dai, H. V. Pham, and O. Milenkovic, "A comparative study of quantized compressive sensing schemes," in *IEEE Int. Symp. on Information Theory (ISIT)*, Seoul, Korea, June 2009, pp. 11–15.
- [265] E. Ardestanizadeh, M. Cheraghchi, and A. Shokrollahi, "Bit precision analysis for compressed sensing," in *IEEE Int. Symp. on Information Theory (ISIT)*, June 2009, pp. 1–5.
- [266] P. T. Boufounos, "Hierarchical distributed scalar quantization," in *Proc. 9th Int. Conf. Sampling Theory Appl. (SampTA)*, 2011, pp. 2–6.
- [267] —, "Universal rate-efficient scalar quantization," *IEEE Trans. Inf. Theory*, vol. 58, no. 3, pp. 1861–1872, Mar. 2012.
- [268] A. Shirazinia, S. Chatterjee, and M. Skoglund, "Performance bounds for vector quantized compressive sensing," in *Int. Symp. Inf. Theory and App. (ISITA)*, Oct. 2012, pp. 289–293.
- [269] —, "Joint source-channel vector quantization for compressed sensing," *IEEE Trans. Signal Process.*, vol. 62, no. 14, pp. 3667–3681, July 2014.
- [270] C.-H. Chen and J.-Y. Wu, "Amplitude-aided 1-bit compressive sensing over noisy wireless sensor networks," *IEEE Wireless Commun. Lett.*, vol. 4, no. 5, pp. 479–476, Oct. 2015.
- [271] V. Gupta, B. Kailkhura, T. Wimalajeewa, S. Liu, and P. K. Varshney, "Joint sparsity pattern recovery with 1-bit compressive sensing in sensor networks," in *49th Asilomar Conference on Signals, Systems and Computers*, Pacific Grove, CA, Nov. 2015, pp. 1472–1476.
- [272] S. Kafle, V. Gupta, B. Kailkhura, T. Wimalajeewa, and P. K. Varshney, "Joint sparsity pattern recovery with 1-bit compressive sensing in distributed sensor networks," *IEEE Trans. on Signal and Inf. Process. over Netw.*, to appear 2018.
- [273] S. Kafle, B. Kailkhura, T. Wimalajeewa, and P. K. Varshney, "Decentralized joint sparsity pattern recovery using 1-bit compressive sensing," in *IEEE Conference on Global Signal and Information Processing (GlobalSIP)*, 2016, pp. 1354–1358.
- [274] M. Leinonen, M. Codreanu, and M. Juntti, "Distributed variable-rate quantized compressed sensing in wireless sensor networks," in *17th International Workshop on Signal Processing Advances in Wireless Communications (SPAWC)*, Edinburgh, UK, July 2016.
- [275] Y.-C. Chen, L. Qiu, Y. Zhang, Z. Hu, and G. Xue, "Robust network compressive sensing," in *Proc. ACM Mobicom*, Maui, Hawaii, USA, Sep. 2014, pp. 545–556.
- [276] L. Kong, M. Xia, X.-Y. Liu, G. Chen, Y. Gu, M.-Y. Wu, and X. Liu, "Data loss and reconstruction in wireless sensor networks," *IEEE Trans. Parallel Distrib. Sys.*, vol. 25, no. 11, pp. 2818–2828, Nov. 2014.
- [277] Y. Fang, J. Wu, and B. Huang, "2D sparse signal recovery via 2D orthogonal matching pursuit," *Science China: Inf. Sci.*, vol. 55, pp. 889–897, 2012.
- [278] T. Wimalajeewa, Y. C. Eldar, and P. K. Varshney, "Recovery of sparse matrices via matrix sketching," *CoRR*, vol. abs/1311.2448, 2013.
- [279] A. Cichocki, D. Mandic, L. D. Lathauwer, G. Zhou, Q. Zhao, and C. C. nad H. A. Phan, "Tensor decompositions for signal processing applications: From two-way to multiway component analysis," *IEEE Signal Process. Mag.*, vol. 32, no. 2, pp. 145–163, Mar. 2015.
- [280] D. Goldfarb and Z. Qin, "Robust low-rank tensor recovery: Models and algorithms," *preprint*, <http://arxiv.org/pdf/1311.6182.pdf>, 2012.