

Automaton (Semi)groups (Basic Concepts)

Jānis Buls, Līga Užule, Aigars Valainis

Department of Mathematics, University of Latvia, Zēļļu iela 25,
Rīga, LV-1002 Latvia, buls@mf.lu.lv; liga.kulesa@lu.lv; avalains@gmail.com

Abstract

In this paper, we give an introduction to basic concepts of automaton semigroups. While we must note that this paper does not contain new results, it is focused on extended introduction in the subject and detailed examples.

Keywords

automaton semigroups

1. Preliminaries

Let A be a finite non-empty set and A^* the free monoid generated by A . The set A is also called an *alphabet*, its elements are called *letters* and those of A^* are called *finite words*. The identity element of A^* is called an *empty word* and denoted by λ . We set $A^+ = A^* \setminus \{\lambda\}$.

A word $w \in A^+$ can be written uniquely as a sequence of letters as $w = w_1 w_2 \dots w_l$, with $w_i \in A$, $1 \leq i \leq l$, $l > 0$. The integer l is called the *length* of w and denoted by $|w|$. The length of λ is 0. We set $w^0 = \lambda$ and $\forall i \in \mathbb{N} w^{i+1} = w^i w$.

The word $w' \in A^*$ is a *factor* (or *subword*) of $w \in A^*$ if there exists $u, v \in A^*$ such that $w = uw'v$. The words u and v are called, respectively, a *prefix* and a *suffix*. A pair (u, v) is called an *occurrence* of w' in w . A factor w' is called *proper* if $w \neq w'$. We denote, respectively, by $F(w)$, $\text{Pref}(w)$ and $\text{Suff}(w)$ the sets of w factors, prefixes and suffixes.

An (indexed) infinite word x on the alphabet A is any total mapping $x : \mathbb{N} \rightarrow A$. We shall set for any $i \geq 0$, $x_i = x(i)$ and write

$$x = (x_i) = x_0 x_1 \dots x_n \dots$$

The set of all the infinite words over A is denoted by A^ω .

The word $w' \in A^*$ is a *factor* of $x \in A^\omega$ if there exists $u \in A^*$, $y \in A^\omega$ such that $x = uw'y$. The words u and y are called, respectively, a *prefix* and a *suffix*. We denote, respectively, by $F(x)$,

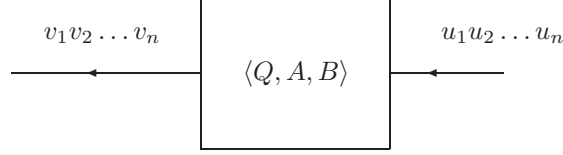

1. Figure: An abstract Mealy machine.

$\text{Pref}(x)$ and $\text{Suff}(x)$ the sets of x factors, prefixes and suffixes. For any $0 \leq m \leq n$, $x[m, n]$ denotes a factor $x_m x_{m+1} \dots x_n$. The word $x[m, n]$ is called an *occurrence* of w' in x if $w' = x[m, n]$. The suffix $x_n x_{n+1} \dots x_{n+i} \dots$ is denoted by $x[n, \infty)$.

If $v \in A^+$, then we denote by v^ω the infinite word

$$v^\omega = vv \dots v \dots$$

The *concatenation* of $u = u_1 u_2 \dots u_k \in A^*$ and $x \in A^\omega$ is the infinite word

$$ux = u_1 u_2 \dots u_k x_0 x_1 \dots x_n \dots$$

For denoting concatenation we sometimes use symbol $\#$. The word x is called *ultimately periodic* if there exists words $u \in A^*$, $v \in A^+$ such that $x = uv^\omega$. In this case, $|u|$ and $|v|$ are called, respectively, an *anti-period* and a *period*.

We use notation $\overline{0, n}$ to denote set $\{0, 1, \dots, n\}$.

2. Serial composition of Mealy machines

2.1. Definition. A 3-sorted algebra $V = \langle Q, A, B, \circ, * \rangle$ is called a Mealy machine if Q, A, B are finite, nonempty sets, the mapping $Q \times A \xrightarrow{\circ} Q$ is a total function and the mapping $Q \times A \xrightarrow{*} B$ is a total surjective function.

The set Q is called *state set*, sets A, B are called *input* and *output alphabet*, respectively. The mappings \circ and $*$ may be extended to $Q \times A^*$ by defining

$$\begin{aligned} q \circ \lambda &= q, & q \circ (ua) &= (q \circ u) \circ a, \\ q * \lambda &= \lambda, & q * (ua) &= (q * u) \# ((q \circ u) * a), \end{aligned}$$

for each $q \in Q$, $(u, a) \in A^* \times A$. See 1.fig. for interpretation of Mealy machine as a word transducer. Henceforth, we shall omit parentheses if there is no danger of confusion. So, for example, we will write $q \circ u * a$ instead of $(q \circ u) * a$. Similarly, we will write $q \circ q' * a$ instead of $q \circ (q' * a)$ where $q' \in Q$.

2.2. Definition. A 3-sorted algebra $V_0 = \langle Q, A, B, q_0, \circ, * \rangle$ is called an initial Mealy machine if $\langle Q, A, B, \circ, * \rangle$ is a Mealy machine and $q_0 \in Q$.

Let $(q, x, y) \in Q \times A^\omega \times B^\omega$. We write $y = q*x$ if $\forall n \in \mathbb{N} y[0, n] = q * x[0, n]$ and say machine V transforms x to y . We say initial machine V_0 transforms x to y if $q = q_0$. We refer to words x and y as machines *input* and *output*, respectively.

2.3. Examples. Look at 2. fig. for examples of machines V_{10} and V_{11} . There we have

$$V_{10} : a_0 = (0, 0), a_1 = (0, 1), a_2 = (1, 0);$$

$$V_{11} : q \circ a = q + a(\text{mod}2), q * a = q \cdot a(\text{mod}2).$$

We might refer to operations \circ and $*$ as machine *transition* and *output functions*, respectively. From now on we would use notation $\langle Q, A, B \rangle$ to denote Mealy machine without specifying operations \circ and $*$. Similarly we would use notation $\langle Q, A, B; q_0 \rangle$ to denote initial Mealy machine. Henceforth we would use terms machine and initial machine to refer to, respectively, Mealy machine and initial Mealy machine.

Suppose that we are given two initial machines $V = \langle Q, A, B; q_0, \circ, * \rangle$ and $V' = \langle Q', A', B'; q'_0, \acute{\circ}, \acute{*} \rangle$. Schematically it is shown in 3.a. fig.

We want to connect output of machine V to input of machine V' (shown in 3.b. fig.). Clearly, in this situation, we have $v = v'$.

Suppose that $B \subseteq A'$, then for machine V' input we always can use word $v = q_0 * u$. Therefore word w is correctly defined as

$$w = q'_0 \acute{*} (q_0 * u).$$

Our goal is to create initial machine $V'' = \langle Q'', A, B'; q''_0, \ddot{\circ}, \ddot{*} \rangle$ (shown 3.c. fig.) such as

$$\forall u \in A^* q''_0 \ddot{*} u = q'_0 \acute{*} (q_0 * u).$$

The new machine V'' is called a *serial* or *cascade composition* (or *connection*) of machines V and V' . To denote serial composition

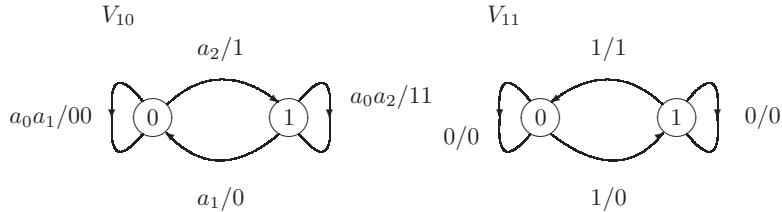

2. Figure: Machines V_{10} and V_{11} .

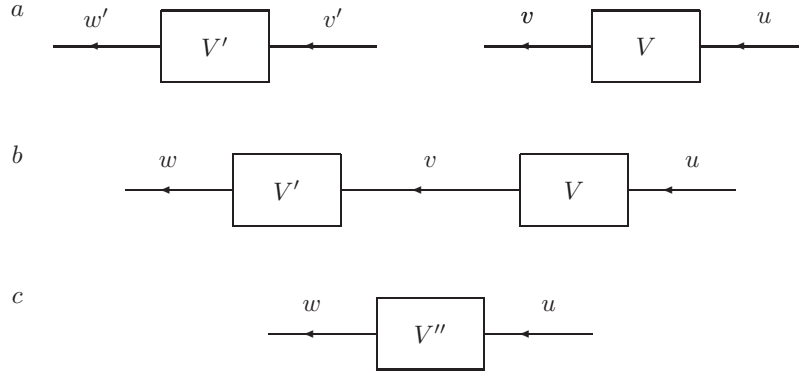

3. Figure: Serial composition.

we will use notation $V \rightsquigarrow V'$. Formally, lets define a class

$$V \rightsquigarrow V' \Leftarrow \{(Q'', A, B'; q_0'', \circ, \ast) \mid \forall u \in A^* q_0'' \ast u = q_0' \ast (q_0 \ast u)\}.$$

Assume that

- $Q'' \Leftarrow Q' \times Q$;
- $q_0'' \Leftarrow (q_0', q_0)$;
- $(q', q) \circ a \Leftarrow (q' \circ q \ast a, q \circ a)$;
- $(q', q) \ast a \Leftarrow q' \ast q \ast a$.

2.4. Lemma. For $\forall u \in A^*$

$$\begin{aligned} (q', q) \circ u &= (q' \circ q \ast u, q \circ u); \\ (q', q) \ast u &= q' \ast q \ast u. \end{aligned}$$

□ Proof of lemma is inductive. Let $v = ua$, where $u \in A^*$ and

$a \in A$, then

$$\begin{aligned}
(q', q)\ddot{o}v &= (q', q)\ddot{o}ua = (q', q)\ddot{o}u\ddot{o}a = (q'\acute{o}q * u, q \circ u)\ddot{o}a \\
&= ((q'\acute{o}q * u)\acute{o}((q \circ u) * a), (q \circ u) \circ a) \\
&= (q'\acute{o}(q * u)\acute{o}(q \circ u * a), q \circ u \circ a) \\
&= (q'\acute{o}((q * u)\#(q \circ u * a)), q \circ ua) \\
&= (q'\acute{o}q * ua, q \circ v) = (q'\acute{o}q * v, q \circ v); \\
(q', q)\ddot{*}v &= (q', q)\ddot{*}ua = ((q', q)\ddot{*}u)\#(q', q)\ddot{o}u\ddot{*}a \\
&= (q'\acute{*}q * u)\#(q'\acute{o}q * u, q \circ u)\ddot{*}a \\
&= (q'\acute{*}q * u)\#((q'\acute{o}q * u)\acute{*}((q \circ u) * a)) \\
&= (q'\acute{*}(q * u))\#((q'\acute{o}(q * u))\acute{*}(q \circ u * a)) \\
&= q'\acute{*}((q * u)\#(q \circ u * a)) \\
&= q'\acute{*}(q * ua) = q'\acute{*}q * v. \quad \blacksquare
\end{aligned}$$

2.5. Corollary. $V'' \in V \rightsquigarrow V'$.

3. Sequential functions

3.1. Definition. A total mapping $f : A^* \rightarrow B^*$ is called a sequential function if

- (i) $\forall u \in A^* |u| = |f(u)|$;
- (ii) $u \in \text{Pref}(v) \Rightarrow f(u) \in \text{Pref}(f(v))$.

3.2. Corollary. For all sequential functions, we have that if

$$u \in \text{Pref}(v) \cap \text{Pref}(w),$$

then

$$f(u) \in \text{Pref}(f(v)) \cap \text{Pref}(f(w)).$$

It states that if words u and v have matching prefixes of length k , then words $f(u)$ and $f(v)$ have matching prefixes of length k .

□ Suppose that $u \in \text{Pref}(v) \cap \text{Pref}(w)$, then accordingly with the definition of sequential function $f(u) \in \text{Pref}(f(v))$ and $f(u) \in \text{Pref}(f(w))$. ■

3.3. Definition. Let $f : A^* \rightarrow B^*$ be a sequential function and $u \in A^*$, then $f_u(v)$ define a prefix of mapping $f(v)$ with length $|v|$. The mapping f_u is called a quotient of sequential function f .

3.4. Corollary. $f(uv) = f(u)f_u(v)$.

3.5. Lemma. $uw \in \text{Pref}(uv) \Leftrightarrow w \in \text{Pref}(v)$.

□ \Rightarrow If $uw \in \text{Pref}(uv)$, then there exists word w' such as $uw' = uv$. Hence $ww' = v$ and therefore $w \in \text{Pref}(v)$.

\Leftarrow If $w \in \text{Pref}(v)$, then exists word w' such as $ww' = v$. Hence $uw' = uv$ and therefore $uw \in \text{Pref}(uv)$. ■

3.6. Proposition. *The quotient f_u is a sequential function.*

□ Accordingly with the definition of quotient $|v| = |f_u(v)|$. In the same time, if $w \in \text{Pref}(v)$, then [by lemma3.5.] $uw \in \text{Pref}(uv)$, therefore

$$f(u)f_u(w) = f(uw) \in \text{Pref}(f(uv)).$$

It holds that $\text{Pref}(f(uv)) = \text{Pref}(f(u)f_u(v))$, therefore $f(u)f_u(w) \in \text{Pref}(f(u)f_u(v))$. Hence [3.5. Lemma] $f_u(w) \in \text{Pref}(f_u(v))$. ■

3.7. Lemma. *If mapping $f : A^* \rightarrow B^*$ is a sequential function, then*

$$f_u(vw) = f_u(v)f_{uv}(w).$$

□ Suppose that $w \in A^*$, then we have

$$\begin{aligned} f(uvw) &= f(u)f_u(vw), \\ f(uvw) &= f(uv)f_{uv}(w) = f(u)f_u(v)f_{uv}(w). \end{aligned}$$

Hence $f_u(vw) = f_u(v)f_{uv}(w)$. ■

3.8. Proposition. *Let mapping $f : A^* \rightarrow B^*$ be a sequential function. If $f_u = f_{u'}$, then*

$$\forall v \in A^* f_{uv} = f_{u'v}.$$

□ Let $w \in A^*$, then

$$f_u(v)f_{uv}(w) = f_u(vw) = f_{u'}(vw) = f_{u'}(v)f_{u'v}(w).$$

We have if $|f_u(v)| = |f_{u'}(v)|$, then $f_{uv}(w) = f_{u'v}(w)$. Hence $f_{uv} = f_{u'v}$. ■

3.9. Proposition. *Let mappings $f : A^* \rightarrow B^*$ and $g : B^* \rightarrow C^*$ be sequential functions, then*

$$\forall u \in A^* (g \circ f)_u = g_{f(u)} \circ f_u.$$

□ We have

$$g(f(ux)) = g(f(u)f_u(x)) = g(f(u))\#g_{f(u)}(f_u(x)).$$

Hence $(g \circ f)_u(x) = g_{f(u)}(f_u(x))$. ■

4. Restricted sequential functions

4.1. Definition. Let mapping $f : A^* \rightarrow B^*$ be a sequential function. The function f defines set

$$Q_f = \{f_u | u \in A^*\},$$

where f_u is a quotient of f . The function f is called a restricted sequential function (or sequential function on restricted domain) if the set Q_f is finite.

4.2. Theorem. For each function $f : A^* \rightarrow B^*$ there exists a initial machine $V = \langle Q_f, A, B; q_0 \rangle$ such as

$$\forall v \in A^* f(v) = q_0 * v.$$

We might say that output function of machine V is equal with function f .

□ Let $Q_f = \{q_0, q_1, \dots, q_k\}$, where element q_0 is a set containing quotient f_λ . Suppose that $f_u \in q$, $a \in A$, $f_{ua} \in q'$ and $f_u(a) = b$, then

$$q \circ a = q', \quad q * a = b.$$

$$(i) \quad f_u \in q \Rightarrow f_{uv} \in q \circ v.$$

$$\nabla \text{ If } v = \lambda, \text{ then } f_{u\lambda} = f_u \in q = q \circ \lambda.$$

Further proof is inductive, given that $f_{uv} \in q \circ v$. Hence accordingly with the definition of the transition function \circ of machine

$$f_{uva} \in (q \circ v) \circ a = q \circ va. \quad \Delta$$

$$(ii) \quad f_u \in q \Rightarrow q * v = f_u(v).$$

$$\nabla \text{ If } v = \lambda, \text{ then } q * \lambda = \lambda = f_u(\lambda).$$

Further proof is inductive, given that $q * v = f_u(v)$. Since $f_{uv} \in q \circ v$, then accordingly with the definition of output function $*$ of machine $f_{uv}(a) = q \circ v * a$. Hence

$$q * va = q * v \# q \circ v * a = f_u(v) f_{uv}(a) = f_u(va). \quad \Delta$$

We note that $f_\lambda = f$ hence $f(v) = f(\lambda) f_\lambda(v) = f_\lambda(v)$. Accordingly with the definition of element q_0 we have $f_\lambda \in q_0$ hence

$$f(v) = f_\lambda(v) = q_0 * v. \quad \blacksquare$$

Let P^A be a set, elements of which are all possible restricted sequential functions $f : A^* \rightarrow A^*$. Serial composition of two Mealy machines is a Mealy machine, thereby composition $f(g(u))$ of two restricted sequential functions

$$f : A^* \rightarrow A^*, \quad g : A^* \rightarrow A^*$$

is restricted sequential function. Thereby we have proved that P^A is a semigroup. The operation of semigroup is composition of restricted sequential functions.

In particular, when $A = \overline{0, 1}^*$ we would use simpler notation P^1 for denoting semigroup $P^{\overline{0, 1}}$.

5. Group AS_2

Let $\langle G, \circ \rangle$ be a monoid. An element $x \in G$ has inverse (is invertible) if

$$\exists y \in G (y \circ x = \lambda = x \circ y);$$

where λ is neutral element of monoid G . Element y is called dual (or inverse) of element x and is usually denoted as x^{-1} .

5.1. Definition. A monoid G , each element of whom is invertible is called a group.

5.2. Proposition. The set

$$AS_2 \Leftarrow \{f \in P^1 \mid f \text{ is bijection}\}$$

is a group in which the group operation is composition of restricted sequential functions.

□ Let $f \in AS_2$, then there exists a Mealy machine

$$V = \langle Q, \overline{0, 1}, \overline{0, 1}; q_0, \circ, * \rangle$$

and for $\forall u \in \overline{0, 1}^*$ $f(u) = q_0 * u$.

We henceforth use following notation: $\bar{0} \Leftarrow 1$ and $\bar{1} \Leftarrow 0$. Let $V' = \langle Q, \overline{0, 1}, \overline{0, 1}; q_0, \acute{\circ}, \acute{*} \rangle$ be a new Mealy machine, where

$$\begin{aligned} q \acute{*} a &\Leftarrow q * a, \\ q \acute{\circ} a &\Leftarrow \begin{cases} q \circ a, & \text{if } q * a = a; \\ q \circ \bar{a}, & \text{if } q * a = \bar{a}. \end{cases} \end{aligned}$$

The Mealy machine V' define restricted sequential function $g(u) \Leftarrow q_0 \acute{*} u$.

We need to prove that $g = f^{-1}$, i.e., that g is inverse function of f .

(i) Suppose that $Q' \Leftarrow \{q \mid \exists u \in \overline{0, 1}^* q = q_0 \circ u\}$. Lets prove that

$$\forall q \in Q' \forall a \in \overline{0, 1} q * (q \acute{*} a) = a. \quad (1)$$

Let $q = q_0 \circ u$ and thus

$$\begin{aligned} f(ua) &= q_0 * ua = q_0 * u \# q_0 \circ u * a = q_0 * u \# q * a, \\ f(u\bar{a}) &= q_0 * u\bar{a} = q_0 * u \# q_0 \circ u * \bar{a} = q_0 * u \# q \acute{*} \bar{a}. \end{aligned}$$

Given that f is a bijection, we have that

$$q * a \neq q \acute{*} \bar{a}. \quad (2)$$

- If $q * a = a$, then $q * (q * a) = q * a = a$.
- If $q * a = \bar{a}$, then by (2) we have that $q * \bar{a} = a$. Hence $q * (q * a) = q * \bar{a} = a$.

This proves that $f g(a) = a$.

(ii) Suppose that $q \in Q'$ and $a \in \overline{0, 1}$.

- If $q * a = a$, then $q \acute{o} a = q \circ a$. Hence

$$q \acute{o}(q * a) = q \acute{o} a = q \circ a.$$

- If $q * a = \bar{a}$, then by (2) $q * \bar{a} = a$. Hence

$$q \acute{o}(q * a) = q \acute{o} \bar{a} = q \circ (q * \bar{a}) = q \circ a.$$

This proves that

$$q \acute{o}(q * a) = q \circ a. \quad (3)$$

(iii) Suppose that $q = q_0 \circ u$ and

$$f_q : \overline{0, 1}^* \rightarrow \overline{0, 1}^* : v \mapsto q * v,$$

then $f(uv) = q_0 * uv = q_0 * u \# q_0 \circ u * v = f(u)f_q(v)$. Suppose that $w \in \overline{0, 1}^*$ and we have that f is a surjection therefore there exists u_0 such as

$$f(u_0) = f(u)w.$$

Hence $u_0 = u_1 u_2$, where $|u_1| = |f(u)|$ and $|u_2| = |w|$. Then there exists u_2 such as $f(u_1 u_2) = f(u)w$. Then $u_1 = u$ because f is an injection. This proves $f(u)w = f(u u_2) = f(u)f_q(u_2)$. Hence $w = f_q(u_2)$, and f_q is a surjection.

If $f_q(u_3) = w$, then $f(u u_3) = f(u)w$. Function f is an injection, thereby $u_3 = u_2$. This proves that function f_q is an injection.

Finally, we conclude that f_q is a bijection for each $q \in Q'$.

(iv) Suppose that f'_q is a restricted sequential function defined by Mealy machine V' such as

$$f'_q : \overline{0, 1}^* \rightarrow \overline{0, 1}^* : u \mapsto q \acute{*} u.$$

In section (i) we proved (equation (7)), i.e., $f_q f'_q(a) = a$, if $a \in \overline{0, 1}$. Further proof is inductive, given that for all $q \in Q'$ and all words u of length n holds $f_q f'_q(u) = u$.

Suppose that $a \in \overline{0, 1}$, then

$$\begin{aligned} f_q f'_q(au) &= q * q \acute{*} a u = q * (q \acute{*} a \# q \acute{o} a \acute{*} u) = q * (q * a \# q \acute{o} a \acute{*} u) \\ &= q * q * a \# q \circ (q * a) * (q \acute{o} a \acute{*} u) \\ &= a \# q \acute{o} a * (q \acute{o} a \acute{*} u) = a \# f_{q \acute{o} a} f'_{q \acute{o} a}(u) = a u. \end{aligned}$$

We note that $q\acute{o}a = q \circ (q * a) \in Q'$. This concludes inductive part of the proof. We note that $f(u) = f_{q_0}(u)$ and $f^{-1}(u) = f'_{q_0}(u)$.

(v) Let f and g be restricted sequential functions from the set AS_2 , Then there exists Mealy machines

$$V = \langle Q, \overline{0}, \overline{1}, \overline{0}, \overline{1}; q_0, \circ, * \rangle, V' = \langle Q', \overline{0}, \overline{1}, \overline{0}, \overline{1}; q'_0, \acute{o}, \acute{*} \rangle$$

such that for $\forall u \in \overline{0}, \overline{1}^*$

$$f(u) = q_0 * u \wedge g(u) = q'_0 \acute{*} u$$

The serial composition $V \rightsquigarrow V'$ is machine, which realizes composition of functions f and g . In other words, if $\check{V} = \langle \check{Q}, \check{\overline{0}}, \check{\overline{1}}, \check{\overline{0}}, \check{\overline{1}}; \check{q}_0, \check{\acute{o}}, \check{\acute{*}} \rangle \in V \rightsquigarrow V'$, then

$$\forall u \in \overline{0}, \overline{1}^* \quad gf(u) = \check{q}_0 \acute{*} u.$$



4. Figure: Implementation of identity function.

(vi) The identity function $\mathbb{I} : \overline{0}, \overline{1}^* \rightarrow \overline{0}, \overline{1}^* : u \mapsto u$ is a restricted sequential function. The machine implementing identity function given as V_{15} (shown in 4.fig.).

(vii) We note that compositions of functions is associative. Finally, we have proven (in (iv) – (vi)) that AS_2 is a group. ■

Suppose that $X \subseteq G$, then

$$\langle X \rangle = \bigcap_{X \subseteq H \leq G} H,$$

i.e., we consider intersection of all subgroups of group G containing set X .

Notification. In this situation similarly as in case of the semi-groups we use notation $\langle X \rangle$.

5.3. Definition. The group $\langle X \rangle$ is called subgroup generated by set X .

If $\langle X \rangle = G$, then set X is called theset of generators of group G . Elements of set X are called generators. If $X = \{x_1, x_2, \dots, x_n\}$, then the following notification is used

$$\langle x_1, x_2, \dots, x_n \rangle = \langle X \rangle.$$

In this case (set X — finite), group G is *finitely generated*.

5.4. Definition. A group G is called cyclic group if

$$\exists g \in G \forall x \in G \exists n \in \mathbb{Z} \quad x = g^n.$$

In this case an element g is called a *generator* of cyclic group G .

5.5. Definition. Let $\langle G, \odot \rangle$ be group. The cardinality of set G , denoted as $|G|$, is called the order of group G .

A group G is called a *finite group* if its cardinality $|G|$ is a natural number, denoted $|G| < \aleph_0$. In opposite case, a group G is called an *infinite group* and denoted as $|G| \geq \aleph_0$.

5.6. Definition. Let a be an element of group G , then subgroups $\langle a \rangle$ order is called the order of element a .

We use notation $o(a)$ to denote order of element, i.e., $o(a) = |\langle a \rangle|$.

6. Elements of graph theory

6.1. Definition. A 2-sorted algebra $\langle V, E, s, t \rangle$ is called pseudograph if:

- (i) V is nonempty set;
- (ii) s, t are total mappings $E \xrightarrow{s} V, E \xrightarrow{t} V$, respectively.

The elements of the set V are called *vertices*, the elements of the set E are called *arcs*. If sets V and E are finite then the pseudograph G is called finite. In this case to denote a directed arc l we use notation $(s(l), t(l))$. The mapping s is called an *initial vertex*, while the mapping t is called a *terminal vertex*. We say that an arc l is *incident out* of the vertex $s(l)$ and *incident in* to the vertex $t(l)$.

6.2. Definition. A pseudograph $G' = \langle V', E', s', t' \rangle$ is called a sub-pseudograph of pseudograph $G = \langle V, E, s, t \rangle$ if :

- (i) $V' \subseteq V$;
- (ii) $E' \subseteq \{l \in E \mid s(l) \in V' \wedge t(l) \in V'\}$;
- (iii) $s' = s|_{E'} \wedge t' = t|_{E'}$.

6.3. Definition. a pseudograph $\langle V, E, s, t \rangle$ is called an oriented graph, if :

- (i) $\forall l \in E \quad s(l) \neq t(l)$
- (ii) $\forall l_1, l_2 \in E \quad (s(l_1) = s(l_2) \wedge t(l_1) = t(l_2)) \Rightarrow l_1 = l_2$.

This means that oriented graph can be given by two sets $V, E \subseteq V^2$. Usually in this case notation $G(V, E)$ is used.

6.4. Definition. An oriented graph is called a graph (non oriented graph), if $\forall l_1 \in E, \exists l_2 \in E : (s(l_1) = t(l_2) \wedge s(l_2) = t(l_1))$. In this case the pair of symmetrical arcs l_1, l_2 is identified by the set $\{s(l_1), s(l_2)\}$. This pair is called an edge connecting vertexes $s(l_1)$ and $s(l_2)$.

To denote edge $\{s(l_1), s(l_2)\}$ we use notation $[s(l_1), s(l_2)]$.

6.5. Definition. A $2n + 1$ tuple $c = (v_0, l_0, v_1, l_1, \dots, l_n, v_{n+1})$ is called a walk in pseudograph $\langle V, E, s, t \rangle$ if

- (i) $\forall i \in \overline{0, n+1}, v_i \in V$;
- (ii) $\forall j \in \overline{0, n}, l_j \in E$;
- (iii) $\forall j \in \overline{0, n}, s(l_j) = v_j \wedge t(l_j) = v_{j+1}$.

We say that a walk $c = (v_0, l_0, v_1, l_1, \dots, l_n, v_{n+1})$ of length starts at the vertex v_0 and ends at the vertex v_{n+1} , connecting vertex v_i with v_j , $i < j$, $i, j \in \overline{0, n+1}$. From the definition of graph, for each walk $c = (v_0, l_0, v_1, l_1, \dots, l_n, v_{n+1})$ there exists a reverse walk

$$c' = (v_{n+1}, l_n, v_n, l_{n-1}, \dots, l_0, v_0),$$

therefore we may say that the walks c connects vertices v_i and v_j , $i, j \in \overline{0, n+1}$.

Let $m = (m_1, m_2, \dots, m_k)$ be a walk, here the integer k is called extended length of walk m . A vertex v occurs in a walk m , if there $\exists j v = m_j$. An arc l occurs in a walk m if $\exists i l = m_i$. An edge $e = \{s(l_1), s(l_2)\}$ occurs in a walk if $\exists i l_1 = m_i \vee l_2 = m_i$. The walk $m' = (m_1, m_2, \dots, m_l)$ is a part of walk $m = (m_1, m_2, \dots, m_k)$ if $\exists j l \leq k - j \wedge \forall i \in \overline{1, l} m'_i = m_{j+i}$.

6.6. Definition. A walk is called

- closed, if it starts and ends at the same vertex;
- trail, if it is without repeated arcs (and edges);
- cycle, if it is nonempty closed trail;
- simple trail (or a path), if it is without repeated vertices.

6.7. Proposition. If there exists a walk connecting vertices v_1 and v_2 , then there exists a trail connecting v_1 and v_2 .

□ The proof is inductive by induction on extended length k of walk $m = (m_1, m_2, \dots, m_k)$. If the extended length of walk is 1 then it is a trail.

If m is not a trail, then there exists an edge l such that $l = m_i = m_{i+j}$, where $1 < i < i + j < k$. Then for vertices $m_{i-1} = m_{i+j-1}$, $m_{i+1} = m_{i+j+1}$. The extended length of walks

$$(m_1, \dots, m_{i-1}, l, m_{i+j+1}, m_{i+j+2}, \dots, m_k)$$

is less than k , therefore accordingly to the inductions hypothesis there exist a trail connecting v_1 and v_2 . ■

6.8. Proposition. If there exists two different trails connecting vertices v_1 and v_2 , then there exist a cycle.

□ Suppose that $(v_1, \alpha_1, \alpha_2, \dots, \alpha_k, v_2)$ and $(v_1, \beta_1, \beta_2, \dots, \beta_n, v_2)$ are two different trails connecting vertices v_1 and v_2 . Suppose that

$$\alpha_1 = \beta_1, \alpha_2 = \beta_2, \dots, \alpha_s = \beta_s, \alpha_{s+1} \neq \beta_{s+1},$$

then α_s is a vertex and

$$(\alpha_s, \alpha_{s+1}, \dots, \alpha_k, v_2), \quad (\beta_s, \beta_{s+1}, \dots, \beta_n, v_2)$$

are two different trails connecting vertex $\alpha_s = \beta_s$ and vertex v_2 .

Suppose that α_t is the first element of sequence

$$\alpha_{s+1}, \alpha_{s+2}, \dots, \alpha_k,$$

matching with some element β_τ in $\{\beta_{s+1}, \beta_{s+2}, \dots, \beta_n\}$. Then

$$(\alpha_s, \alpha_{s+1}, \dots, \alpha_t = \beta_\tau, \beta_{\tau-1}, \dots, \beta_{s+1}, \beta_s = \alpha_s)$$

is a cycle, otherwise

$$(\alpha_s, \alpha_{s+1}, \dots, \alpha_k, v_2, \beta_n, \dots, \beta_{s+1}, \beta_s)$$

is a cycle. ■

6.9. Definition. An edge $[v_1, v_2]$ of graph is called to be incident to vertex v_1 , and also to vertex v_2 . Such vertices v_1 and v_2 are called neighboring vertices. Thus vertex v_1 is a neighbor of vertex v_2 and vice versa. The number of edges incident to a vertex v is called the degree of vertex.

In this case we use notation $\deg(v)$. A vertex v is called *isolated vertex*, if $\deg(v) = 0$. A vertex v is called a *leaf* if $\deg(v) = 1$.

6.10. Proposition. Let $G(V, E)$ be a finite graph, then

$$\sum_{v \in V} \deg(v) = 2|E|$$

□ As each edge is incident to two vertices, the sum of all degrees of vertices is twice the number of edges $2|E|$. ■

6.11. Corollary. If $G(V, E)$ is a graph in which the degree of each vertex v is $\deg(v) \geq 2$, then for sets V, E holds $|E| \geq |V|$.

□ $2|E| = \sum_{v \in V} \deg(v) \geq 2|V|$. Hence $|E| \geq |V|$. ■

6.12. Definition. A graph is called *connected* if for each two vertices v_1, v_2 there exist a walk m starting at v_1 and ending at v_2 . Otherwise graph is called *disconnected*. An edge $[a, b]$ of connected graph $G(V, E)$ is called a *bridge* if graph $G(V, E \setminus \{[a, b]\})$ is disconnected. A connected graph $G(V_1, E_1)$ is called *connected component* of $G(V, E)$ if it is maximal connected subgraph.

6.13. Lemma. *If $|E| = |V| - 2$, then the graph $G(V, E)$ is disconnected.*

□ Proof done by induction on $n = |V|$. If $n = 2$, then $n - 2 = 0$ hence graph with two vertices and no edges is disconnected.

Let $G(V, E)$ be a graph with $n + 1$ vertices and $n - 1$ edges. By (corollary 6.11) there exist vertex v with degree 1 or 0. If vertex v is isolated then graph $G(V, E)$ is disconnected. Otherwise, if v is a leaf, we exclude vertex v and edge incident to it from the graph. The obtained graph G' has n vertices and $n - 2$ edges. From the induction hypothesis graph G' is not connected. Therefore there exist two vertices v_1 and v_2 for whom there is no trail connecting them. If such trail \varkappa would exist in the graph $G(V, E)$ then vertex v would occur in it. We have that $v_1 \neq v \neq v_2$ hence walk \varkappa can't be a trail because vertex v is a leaf. Hence graph $G(V, E)$ is disconnected. ■

6.14. Definition. *A graph P is called an underlying graph of oriented graph G , if its obtained by replacing all arcs of graph G with edges.*

Replacement operation involves assigning to each arc in the original graph an arc symmetrical to it.

6.15. Definition. *A connected graph without cycles is called a tree. An oriented graph is called an oriented tree, if its underlying graph is a tree. An oriented tree is called a rooted oriented tree, if there exist a vertex σ such that for every other vertex v there exist a walk connecting σ and v . Such vertex σ is called a root.*

6.16. Proposition. *The following properties of graph T are equivalent:*

1. $T = T(V, E)$ is a tree;
2. T is connected and each edge is a bridge;
3. T is connected and contains $n - 1$ edge;
4. T is without cycles and contains $n - 1$ edge;
5. Each two vertices of T are connected only one trail;
6. T is without cycles, but connecting any two non neighboring vertices with a new edge would create a cycle.

□ 1. \Rightarrow 2. The graph T is connected by definition, by the exclusion of an edge we cannot maintain connected graph, otherwise, there should be a cycle.

2. \Rightarrow 3. The proof is done by an induction on n . Let exclude one edge, say, $[v_1, v_2]$. We obtain a new graph $T(V, E_0)$, where

$E_0 \Leftarrow E \setminus \{[v_1, v_2]\}$. Let define a subset of vertex set of the graph $T(V, E_0)$:

$$\begin{aligned} V_1 &\Leftarrow \{v \mid \text{there exist a walk connecting vertex } v_1 \text{ and } v\}, \\ V_2 &\Leftarrow \{v \mid \text{there exist a walk connecting vertex } v_2 \text{ and } v\}. \end{aligned}$$

(i) The graph $T(V, E_0)$ is disconnected, therefore $V_1 \cap V_2 = \emptyset$. Otherwise there would exist a vertex $v \in V_1 \cap V_2$, implying existence of walks μ_1, μ_2 connecting vertex v_1 to v and, respectively, vertex v to v_2 . Therefore there would exist a walk $m = (m_1, m_2, \dots, m_s)$ connecting vertices v_1 and v_2 .

Let w_1, w_2 be two arbitrary chosen vertices of the graph $T(V, E)$. As the graph T is connected, there exist a walk connecting w_1 and w_2 . Therefore (by proposition 6.7) there exist a trail $\varkappa = (\varkappa_1, \varkappa_2, \dots, \varkappa_\nu)$ connecting w_1 and w_2 . If the edge $[v_1, v_2]$ is not occurring in the trail \varkappa , then \varkappa is a trail in graph $T(V, E_0)$ connecting vertices w_1 and w_2 . If trail \varkappa contains edge $[v_1, v_2]$, then exists index i such as $[v_1, v_2] = \varkappa_i$. Hence for the part of trail we have

$$(\varkappa_{i-1}, \varkappa_i, \varkappa_{i+1}) = (v_1, [v_1, v_2], v_2),$$

or

$$(\varkappa_{i-1}, \varkappa_i, \varkappa_{i+1}) = (v_2, [v_1, v_2], v_1).$$

In first case

$$(\varkappa_1, \dots, \varkappa_{i-1}, m_2, m_3, \dots, m_{s-1}, \varkappa_{i+1}, \varkappa_{i+2}, \dots, \varkappa_\nu)$$

is a walk in graph $T(V, E_0)$ connecting vertices w_1 and w_2 . In second case

$$(\varkappa_1, \dots, \varkappa_{i-1}, m_{s-1}, m_{s-2}, \dots, m_2, \varkappa_{i+1}, \varkappa_{i+2}, \dots, \varkappa_\nu)$$

is walk in graph $T(V, E_0)$ connecting vertices w_1 and w_2 . Therefore graph $T(V, E_0)$ is connected. Thus we have arrived at a contradiction!

(ii) Lets prove that $V_1 \cup V_2 = V$. Suppose that $v \in V_1 \cup V_2$, thee there exist a trail

$$\alpha = (\alpha_1, \alpha_2, \dots, \alpha_t),$$

in graph T connecting vertices v and v_2 . If edge $[v_1, v_2]$ occurs in trail α , then $v \in V_2$. If edge $[v_1, v_2]$ occurs in trail α , then there exist index i such that $\alpha_i = [v_1, v_2]$. Hence for the part of trail

$$(\alpha_{i-1}, \alpha_i, \alpha_{i+1}) = (v_1, [v_1, v_2], v_2),$$

or

$$(\alpha_{i-1}, \alpha_i, \alpha_{i+1}) = (v_2, [v_1, v_2], v_1).$$

In first case $(\alpha_1, \alpha_2, \dots, \alpha_{i-1})$ is a trail in graph $T(V, E_0)$ connecting v and v_1 , therefore $v \in V_1$. In second case $(\alpha_1, \alpha_2, \dots, \alpha_{i-1})$ is a trail in $T(V, E_0)$ connecting v and v_2 , therefore $v \in V_2$.

Hence graph $T(V, E_0)$ contains two connected components $T_1(V_1, E_1)$ and $T_2(V_2, E_2)$, $E_1 = E_0|_{V_1 \times V_1}$, $E_2 = E_0|_{V_2 \times V_2}$. As each edge in graph T is a bridge, then in graphs $T(V_1, E_1)$ and $T(V_2, E_2)$ all edges are bridges.

According to the induction hypothesis: $|E_1| = |V_1| - 1$ and $|E_2| = |V_2| - 1$. As a result we have

$$|E| = |E_1| + |E_2| + 1 = |V_1| - 1 + |V_2| - 1 + 1 = |V| - 1.$$

3. \Rightarrow 4. If graph would contain a cycle then excluding some edge belonging to this cycle would not make graph disconnected. The graph T_0 obtained in this way would be connected and would contain $n - 2$ edges and n vertices. This is in contradiction by lemma 6.13.

4. \Rightarrow 5. From given is clear that no two vertices are connected with more than one trail, otherwise there would exist a cycle. We need to prove that graph is connected. Suppose that graph is disconnected, and contains multiple connected components. Each connected component is without a cycles, therefore (by definition 6.15) they are trees. Hence 3. condition is true, i.e., each connected component $G(V_i, E_i)$ has property $|E_i| = |V_i| - 1$. Hence, if number of connected component are k :

$$\begin{aligned} \sum_{i=1}^k |E_i| &= \sum_{i=1}^k |V_i| - k, \\ n - 1 &= |E| = \sum_{i=1}^k |E_i| = \sum_{i=1}^k |V_i| - k = |V| - k = n - k. \end{aligned}$$

Therefore $k = 1$, i.e., we have only one connected component.

5. \Rightarrow 6. If there exist a cycle in graph T , then at least two distinct vertices could be connected with two different trails. This leads to contradiction and therefore graph T is without cycles.

Suppose that vertices v_1, v_2 aren't neighbors, then exists a trail

$$(v_2, \varkappa_1, \dots, \varkappa_k, v_1),$$

connecting v_2 and v_1 . Let add a edge $[v_1, v_2]$, then

$$(v_2, \varkappa_1, \dots, \varkappa_k, v_1, [v_1, v_2], v_2)$$

is a cycle.

6. \Rightarrow 1. Suppose that v_1, v_2 aren't neighbors, but adding edge $[v_1, v_2]$ create a cycle. Therefore $[v_1, v_2]$ occurs in a cycle. Let suppose that this new cycle is

$$(v_1, [v_1, v_2], v_2, \varkappa_1, \dots, \varkappa_k, v_1),$$

the $(v_2, \varkappa_1, \dots, \varkappa_k, v_1)$ is a walk connecting v_2 and v_1 . Therefore T is a connected graph, additionally T is without cycles. Hence, accordingly to the definition of tree, T is a tree. ■

6.17. Definition. The integer $\deg^-(v) \doteq |\{l | t(l) = v\}|$ is called the *indegree* of vertex v of pseudograph $\langle V, E, s, t \rangle$. The integer $\deg^+(v) \doteq |\{l | s(l) = v\}|$ is called the *outdegree* of vertex v of pseudograph $\langle V, E, s, t \rangle$.

A pseudograph is called *out- p -regular*, if outdegree of all vertices is p . Pseudograph G is *out-regular*, if there exists such integer p , that G is out- p -regular pseudograph. A rooted oriented tree is called *regular* (p -regular), if it is out- p -regular.

6.18. Corollary. $\sum_{v \in V} \deg^+(v) = |E|$.

□ Each arch starts with a vertex. ■

6.19. Definition. A graph $G(V, E)$ is called *vertex infinite*, if its vertex set V is infinite.

6.20. Corollary. If $p > 0$, then each out- p -regular rooted tree is infinite.

□ If infinite rooted tree $G(V, E)$ is out- p -regular, then

$$p|V| = \sum_{v \in V} \deg^+(v) \stackrel{S6.18}{=} |E|.$$

If $p > 0$, then $|V| \leq p|V| = |E|$, but for all finite trees holds $|E| = |V| - 1$. This is a contradiction! ■

6.21. Corollary. The indegree for root of an out- p -regular rooted tree is $\deg^-(\sigma) = 0$.

□ Suppose that σ is the root of a out- p -regular tree and $\deg^-(\sigma) > 0$, then there exist a vertex v and an arch l such as $s(l) = v$ and $t(l) = \sigma$. As σ is the root, then there exist a walk

$$(\sigma, c_1, c_2, \dots, c_n, v),$$

connecting σ with v . Hence

$$(\sigma, c_1, c_2, \dots, c_n, v, l, \sigma)$$

is a cycle. A contradiction! ■

6.22. Proposition. If there exist a trail connecting vertices v_1 and v_2 , then there exist a simple trail (path) connecting v_1 and v_2 .

□ Suppose that $c = (c_1, c_2, \dots, c_n)$ is a trail connecting v_1 and v_2 , i.e., $c_1 = v_1$ and $c_n = v_2$. If $v_1 = v_2$, then trail $c = (v_1)$ is simple.

Let $v_1 \neq v_2$. The proof is done by induction on length of trail c . If c length is 3, then it is a simple trail. Suppose that $n > 3$ and c is not a simple trail, then there exist vertex c_i such that $c_i = c_{i+j}$, where

$$1 \leq i < i + j \leq n.$$

We can not have both $1 = i$ and $i + j = n$ in the some time because $c_1 = v_1 \neq v_2 = c_n$. Trail

$$(c_1, c_2, \dots, c_i, c_{i+j+1}, \dots, c_{n-1}, c_n)$$

connects v_1 and v_2 . Length of the trail is less than n , therefore by the induction hypothesis exists a simple trail connecting v_1 and v_2 . If $i + j = n$, then trail (c_1, c_2, \dots, c_i) connects v_1 and v_2 . The length of this trail also is less than n , therefore by the induction hypothesis exists simple trail connecting v_1 and v_2 . ■

6.23. Corollary. *If v is a vertex of a out- p -regular rooted tree and v is not a root then $\deg^-(v) = 1$.*

□ Let G be a p -regular tree and P an underlying graph of G . Suppose that $\deg^-(v) > 1$, then exists at least 2 vertices v_1 and v_2 such that (v_1, v) and (v_2, v) are arcs. Suppose that σ is the root, then exists simple trails

$$(\sigma, \alpha_1, \alpha_2, \dots, \alpha_k, v_1) \quad \text{and} \quad (\sigma, \beta_1, \beta_2, \dots, \beta_n, v_2).$$

(i) Is the walk $c_1 = (\sigma, \alpha_1, \alpha_2, \dots, \alpha_k, v_1, (v_1, v), v)$ a simple trail?

If we assume contrary, then there exists a vertex α_i such as $\alpha_i = v$. Hence, if orientation of arcs is removed),

$$(\alpha_i, \alpha_{i+1}, \dots, \alpha_k, [v_1, v], v)$$

is a cycle in underlying graph P . This is a contradiction, since P is a tree. Therefore c_1 is a simple trail. Similarly is provable that $c_2 = (\sigma, \beta_1, \beta_2, \dots, \beta_n, v_2, (v_2, v), v)$ is a simple trail.

(ii) If the orientation of arcs is removed, then c_1 and c_2 are 2 distinct trails in the underlying graph P connecting vertices σ and v . This is a contradiction, since P is a tree. ■

6.24. Proposition. *For each vertex v of a p -regular tree there exist only one simple trail connecting root σ with vertex v .*

□ Let c_v be the shortest trail connecting root σ with vertex v , i.e., if c is a trail connecting σ with v , then trail c_v is not longer than c . As $\deg^-(\sigma) = 0$, then only trail connecting σ with σ is of length 0.

Further proof is inductive, given that for each vertex v such as $c_v \leq l$ exists only one simple trail connecting root σ with v . Suppose that w is vertex such as trail $c_w = (\sigma, \alpha_1, \alpha_2, \dots, \alpha_n, \alpha_{n+1}, w)$ is of length $l + 1$.

Here $c \Leftarrow (\sigma, \alpha_1, \alpha_2, \dots, \alpha_n)$ is a trail of length l , $\alpha_{n+1} = (\alpha_n, w)$ is an arc and α_n is a vertex. As $\deg^-(w) = 1$, then for each trail $(\sigma, \beta_1, \dots, \beta_k, \beta_{k+1}, w)$ connecting σ with w , arch $\beta_{k+1} = (\alpha_n, w)$ and vertex $\beta_k = \alpha_n$.

Therefore $(\sigma, \beta_1, \dots, \beta_k)$ is trail connecting σ with α_n , i.e.,

$$(\sigma, \beta_1, \dots, \beta_{k-1}, \beta_k) = (\sigma, \beta_1, \dots, \beta_{k-1}, \alpha_n).$$

The length of trail c is l , therefore length of c_{α_n} is not larger than l . From induction hypothesis, there exist only one trail connecting σ with α_n . Then

$$\begin{aligned} c_{\alpha_n} &= c = (\sigma, \alpha_1, \alpha_2, \dots, \alpha_n) \\ &= (\sigma, \beta_1, \dots, \beta_{k-1}, \alpha_n) \\ &= (\sigma, \beta_1, \dots, \beta_{k-1}, \beta_k). \end{aligned}$$

Hence

$$\begin{aligned} (\sigma, \beta_1, \dots, \beta_{k-1}, \beta_k, \beta_{k+1}, w) &= (\sigma, \alpha_1, \alpha_2, \dots, \alpha_n, \beta_{k+1}, w) \\ &= (\sigma, \alpha_1, \alpha_2, \dots, \alpha_n, (\alpha_n, w), w) \\ &= (\sigma, \alpha_1, \alpha_2, \dots, \alpha_n, \alpha_{n+1}, w) \\ &= c_w. \end{aligned}$$

Finally, we conclude that unity of trail is proved. ■

6.25. Definition. *The integer l is called level of vertex v if l is length of trail connecting root σ with vertex v .*

6.26. Corollary. *For each vertex v of a p -regular tree exists only one level.*

Suppose that $G(V, E)$ is a p -regular tree with root σ . Let $l(v)$ denote length of trail connecting root σ with vertex v .

$$L(n) \Leftarrow \{v \mid l(v) = n\}.$$

Elements of set $L(n)$ are called n -th level vertices. From collorary 6.26 set $L(n)$ is defined uniquely and correctly.

6.27. Definition. $|L(n)| = p^n$ for each p -regular tree $G(V, E)$.

□ As $G(V, E)$ is p -regular, then $|L(1)| = p$. Further proof is inductive, given that $|L(n)| = p^n$. Suppose that $v_1, v_2 \in L(n)$ and $(v_1, u_1), (v_2, u_2)$ are arcs of tree $G(V, E)$, then $u_1 \neq u_2$. Otherwise,

there would exist 2 distinct trails connecting root to vertex u_1 . This is in contradiction with proposition 6.24.

Suppose $G(V, E)$ is a p -regular, therefore for each vertex v of level n the outdegree $\deg^+(v) = p$. Hence

$$|L(n+1)| = |L(n)|p = p^n p = p^{n+1}. \quad \blacksquare$$

6.28. Definition. Pair of mappings $(f_1 : V_1 \rightarrow V_2, f_2 : E_1 \rightarrow E_2)$ is called a homomorphism of pseudographs

$$\langle V_1, E_1, s_1, t_1 \rangle \langle V_2, E_2, s_2, t_2 \rangle,$$

if for each arch l of pseudograph $\langle V_1, E_1, s_1, t_1 \rangle$ holds:

- (i) $f_1(s_1(l)) = s_2(f_2(l))$,
- (ii) $f_1(t_1(l)) = t_2(f_2(l))$.

If mappings f_1 and f_2 are bijections, then homomorphism is called an *isomorphism*. If $\langle V_1, E_1, s_1, t_1 \rangle = \langle V_2, E_2, s_2, t_2 \rangle$, then homomorphism is called an *endomorphism*. If additionally f_1, f_2 are bijections, then endomorphism is called an *automorphism*.

6.29. Definition. A 3-sorted algebra $\langle V, E, A, s, t, i \rangle$ is called a labeled pseudograph if :

- (i) $\langle V, E, s, t \rangle$ is a pseudograph,
- (ii) i is a total mapping $E \xrightarrow{i} A$.

Image $i(l) \in A$ is called a label of arc $l \in E$.

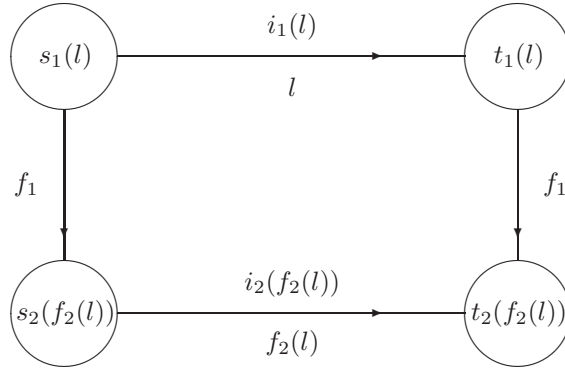

5. Figure: Isomorphism of labeled pseudographs.

6.30. Definition. Labeled pseudographs

$$\langle V_1, E_1, s_1, t_1, i_1 \rangle, \langle V_2, E_2, s_2, t_2, i_2 \rangle$$

are isomorph labeled pseudographs, if there exist bijections

$$f_1 : V_1 \rightarrow V_2, f_2 : E_1 \rightarrow E_2,$$

such that for each arch l of a labeled pseudograph $\langle V_1, E_1, s_1, t_1, i_1 \rangle$ holds:

- (i) $f_1(s_1(l)) = s_2(f_2(l))$,
- (ii) $f_1(t_1(l)) = s_2(f_2(l))$,
- (iii) $i_1(l) = i_2(f_2(l))$.

Look for illustration in 5. fig.

If pseudographs $\langle V_1, E_1, s_1, t_1 \rangle, \langle V_2, E_2, s_2, t_2 \rangle$ are oriented graphs $G(V_1, E_1), G(V_2, E_2)$, then mapping $f_1 : V_1 \rightarrow V_2$ uniquely defines mapping $f_2 : E_1 \rightarrow E_2$:

$$f_2 : E_1 \rightarrow E_2 : (u, v) \mapsto (f_1(u), f_1(v)).$$

Therefore for the definition of homomorphism of oriented graphs only one mapping is needed.

6.31. Definition. A mapping $f : V_1 \rightarrow V_2$ is called a *homomorphism of (oriented) graphs* $G(V_1, E_1), G(V_2, E_2)$, if for each arc $(u, v) \in E_1$ there exist $(f(u), f(v)) \in E_2$.

If $G(V_1, E_1) = G(V_2, E_2)$, then a homomorphism is called an *endomorphism* of oriented graph $G(V_1, E_1)$.

The situation is different with (oriented) graph isomorphism. Condition stating that $f : V_1 \rightarrow V_2$ is a bijection is not enough (look 6. fig.). Mapping

$$f : u_1 \mapsto v_1, u_2 \mapsto v_2, u_3 \mapsto v_3$$

is a bijection of vertex sets of graphs G_1, G_2 , therefore an homomorphism, but it does not define the bijection of sets of arcs.

6.32. Definition. A homomorphism f of (oriented) graphs G_1, G_2 is called an *isomorphism* if f is a bijection of the vertex sets and f^{-1} is a graph homomorphism of G_2, G_1 .

If $G_1 = G_2$, then isomorphism is called an *automorphism* of graph G_1 .

6.33. Definition. Let $G(V_1, E_1), G(V_2, E_2)$ be oriented rooted trees. Then a homomorphism f of oriented graphs $G(V_1, E_1), G(V_2, E_2)$ is called a *homomorphism of oriented rooted trees* $G(V_1, E_1), G(V_2, E_2)$, if $f(\sigma_1) = \sigma_2$, where σ_1, σ_2 are the roots of trees $G(V_1, E_1), G(V_2, E_2)$, respectively.

The homomorphism of oriented rooted trees f is called an *isomorphism* of oriented rooted trees, if f is an isomorphism of oriented

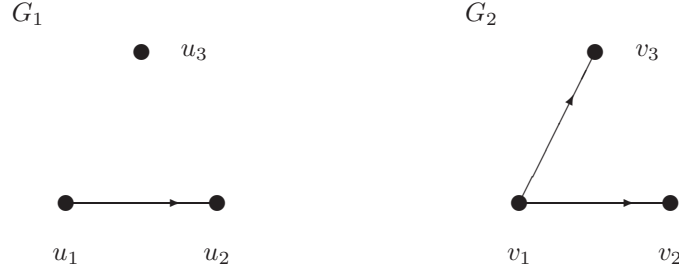

6. Figure: Nonisomorphic graphs.

graphs $G(V_1, E_1), G(V_2, E_2)$. If $G(V_1, E_1) = G(V_2, E_2)$, then homomorphism of oriented rooted trees f is called an *endomorphism* of oriented rooted trees. If endomorphism f is an isomorphism, then endomorphism f is called an *automorphism* of oriented rooted tree.

6.34. Proposition. *If mappings f, g are automorphisms of oriented rooted tree $G(V, E)$, then fg is an automorphism of tree $G(V, E)$.*

□ Suppose that f, g are automorphisms of oriented rooted tree $G(V, E)$ and s is the root of $G(V, E)$. Then we have $sf = fs = s$. If (u, v) is an arc of tree $G(V, E)$, then (uf, vf) also is an arc of tree $G(V, E)$ (by definitions 6.31 and 6.33) because f is an endomorphism. As (uf, vf) is an arc of tree $G(V, E)$, then (ufg, vfg) also is an arc of tree $G(V, E)$ because g also is an endomorphism. Therefore fg is endomorphism of tree $G(V, E)$.

As f, g are automorphisms of tree $G(V, E)$, then f^{-1}, g^{-1} are endomorphisms of the same tree (by definition 6.33). As f^{-1}, g^{-1} are endomorphisms, then $g^{-1}f^{-1}$ is an endomorphism. Therefore $(fg)^{-1}$ is an endomorphism, because, as f, g are bijections, we have $(fg)^{-1} = g^{-1}f^{-1}$.

Finally, we have proven that fg is an automorphism of oriented rooted tree $G(V, E)$. ■

By $\text{Aut}(G(V, E))$ we denote set of all automorphisms of oriented rooted tree $G(V, E)$.

6.35. Corollary. $\langle \text{Aut}(G(V, E)), \otimes \rangle$ is a group.

Here

$$\otimes : \text{Aut}(G(V, E)) \times \text{Aut}(G(V, E)) \rightarrow \text{Aut}G(V, E)$$

is the composition of mappings.

7. Machine semigroups

We would use notation $\mathfrak{M} = \langle Q, A, \circ, * \rangle$ to denote Mealy machine $\mathfrak{M} = \langle Q, A, A, \circ, * \rangle$. In this section the input and output alphabets of all Mealy machines are one and the same, additionally, we drop the requirement that function $Q \times A \xrightarrow{*} A$ must be surjective.

For each $q \in Q$ function $Q \times A \xrightarrow{*} A$ defines a restricted sequential function

$$\bar{q} : A^* \rightarrow A^* : u \mapsto q * u.$$

Following definition is inductive. Let $x \in Q^+$, then with \overline{xq} we denote function

$$\overline{xq} : A^* \rightarrow A^* : u \mapsto (u\bar{x})\bar{q} = \bar{q}(\bar{x}(u)).$$

7.1. Definition. Let $\mathfrak{M} = \langle Q, A, \circ, * \rangle$ be a Mealy machine, then semigroup generated by set $\{\bar{q} \mid q \in Q\}$ is called a machine semigroup \mathfrak{M} (automaton semigroup, semigroup of \mathfrak{M}).

We use notation $\langle \mathfrak{M} \rangle_+$ to denote the semigroup of machine \mathfrak{M} .

7.2. Corollary. $\langle \mathfrak{M} \rangle_+ = \{\bar{x} \mid x \in Q^+\}$

Why we are interested in machine semigroups?

The definition of machine semigroup implies that it is a convenient way for represent particular semigroup. In other words if we are given a Mealy machine $\mathfrak{M} = \langle Q, A, \circ, * \rangle$, then its machine semigroup is given as well.

Another question arises:

Is there a particular benefit from this representation? How informative is particular representation?

It turns out that even a very small size Mealy machine gives infinite semigroups.

7.3. Examples.

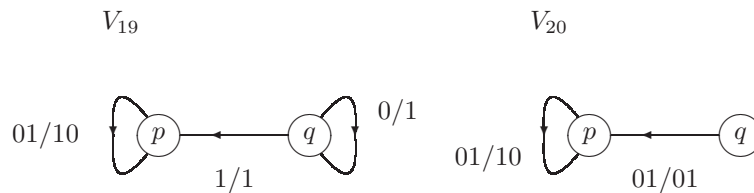

7. Figure: $|\langle V_{19} \rangle_+| = \infty$, $|\langle V_{20} \rangle_+| = 4$

First we prove that semigroup $\langle V_{19} \rangle_+ 0$ of machine V_{19} is infinite. We choose infinite word $(01)^\omega \in \overline{0, 1}^\omega$, it follows that

- $\bar{q}((01)^\omega) = 1^2(10)^\omega$ and $\overline{qp}((01)^\omega) = \bar{p}(1^2(10)^\omega) = 0^2(01)^\omega$

Further proof is inductive given

$$\overline{(qp)^{n-1}q}((01)^\omega) = 1^{2n}(10)^\omega \quad \text{and} \quad \overline{(qp)^n}((01)^\omega) = 0^{2n}(01)^\omega.$$

Hence

$$\begin{aligned} \overline{(qp)^n}q((01)^\omega) &= \bar{q}(\overline{(qp)^n}((01)^\omega)) = \bar{q}(0^{2n}(01)^\omega) \\ &= 1^{2n}1^2(10)^\omega = 1^{2(n+1)}(10)^\omega \end{aligned}$$

and

$$\begin{aligned} \overline{(qp)^{n+1}}((01)^\omega) &= \bar{p}(\overline{(qp)^n}((01)^\omega)) \\ &= \bar{p}(1^{2(n+1)}(10)^\omega) = 0^{2(n+1)}(01)^\omega. \end{aligned}$$

We have inductively proven that elements of semigroup $\langle V_{19} \rangle_+$

$$\bar{q}, \overline{qp}, \overline{qpq}, \dots, \overline{q(pq)^n}, \overline{(qp)^{n+1}}, \dots$$

are unique. Thereby semigroup $\langle V_{19} \rangle_+$ is infinite.

Now lets consider semigroup of machine V_{20} . Suppose that $a \in \overline{0, 1}$ and $x \in \overline{0, 1}^\omega$, then

- $\bar{p}(x) = \bar{x}$, $\overline{p^2}(x) = \bar{p}(\bar{p}(x)) = \bar{p}(\bar{x}) = x = \mathbb{I}(x)$
- $\bar{q}(ax) = a\bar{x}$, $\overline{q^2}(ax) = \bar{q}(\bar{q}(ax)) = \bar{q}(a\bar{x}) = x = \mathbb{I}(x)$
- $\overline{qp}(ax) = \bar{p}(\bar{q}(ax)) = \bar{p}(a\bar{x}) = a\bar{x}$, $\overline{pq}(ax) = \bar{q}(\bar{p}(ax)) = \bar{q}(a\bar{x}) = a\bar{x}$

Therefore we have $\overline{pq} = \overline{qp}$, t.i., $\bar{p}\bar{q} = \bar{q}\bar{p}$.

Hence

	\mathbb{I}	\bar{p}	\bar{q}	\overline{pq}
\mathbb{I}	\mathbb{I}	\bar{p}	\bar{q}	\overline{pq}
\bar{p}	\bar{p}	\mathbb{I}	\overline{pq}	\bar{q}
\bar{q}	\bar{q}	\overline{pq}	\mathbb{I}	\bar{p}
\overline{pq}	\overline{pq}	\bar{q}	\bar{p}	\mathbb{I}

It follows that $\langle V_{20} \rangle_+$ is the Klein 4-group $\mathbb{Z}_2 \times \mathbb{Z}_2$.

7.4. Example. Lets choose an alphabet $A = \{a_1, a_2, \dots, a_p\}$. Lets define a p -regular rooted tree $\bar{\mathfrak{K}}(A)$ as:

- the words A^* are vertices of the tree;
- the empty word λ is root of the tree;
- the set $\{(u, ua) \mid u \in A^* \wedge a \in A\}$ is the set of arcs.

From construction we have that $\deg^-(\lambda) = 0, \forall u \in A^+ \deg^-(u) = 1$ and $\forall u \in A^* \deg^+(u) = p$.

7.5. Lemma. *The underlying graph of graph $\bar{\mathfrak{K}}(A)$ is a tree.*

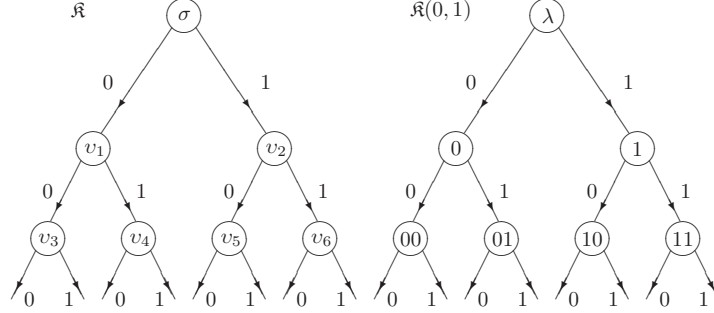

8. Figure: Labeled rooted trees \mathfrak{K} and $\mathfrak{K}(0,1)$.

□ For the underlying graph of $\bar{\mathfrak{K}}(A)$ the set of edges is $\{[u, ua] \mid u \in A^* \wedge a \in A\}$. Lets exclude an arbitrary edge $[u, ua]$. Let prove that for vertex w , which reachable from vertex ua , holds that $ua \in \text{Pref}(w)$. If length of walk is zero, then proposition holds. Suppose that proposition holds for all walks of length n starting at vertex ua .

Lets choose an arbitrary walk

$$(ua, l_1, v_1, l_2, v_2, \dots, l_n, v_n, l_{n+1}, v_{n+1})$$

of length $n+1$, then $(ua, l_1, v_1, l_2, v_2, \dots, l_n, v_n)$ is walk of length n , and accordingly to the induction hypothesis $ua \in \text{Pref}(v_n)$.

(i) If $v_n = ua$, then $l_{n+1} = [ua, uab]$ for some $b \in A$ because edge $[u, ua]$ is excluded. Hence

$$v_{n+1} = uab \quad \text{and} \quad ua \in \text{Pref}(uab) = \text{Pref}(v_{n+1}).$$

(ii) If $v_n \neq ua$, then accordingly with induction hypothesis $v_n = uavb$, where $v \in A^*$ and $b \in A$. Thus $p+1$ edge is incident to vertex v_n , i.e.,

$$[uavb, uav], [uavb, uavba_1], [uavb, uavba_2], \dots, [uavb, uava_p].$$

Therefore we have that

$$v_{n+1} \in \{uav, uavba_1, uavba_2, \dots, uava_p\}.$$

Hence $ua \in \text{Pref}(v_{n+1})$. This concludes inductive part of the proof.

We have proven that vertex u is not reachable. This means that each edge $[u, ua]$ is a bridge, therefore (proposition 6.16) the underlying graph is a tree. ■

As the underlying graph of $\bar{\mathfrak{K}}(A)$ is a tree, $\text{deg}^-(\lambda) = 0, \forall u \in A^+ \text{deg}^-(u) = 1$ and $\forall u \in A^* \text{deg}^+(u) = p$, thus we have proven, that $\bar{\mathfrak{K}}(A)$ is a p -regular rooted tree. In case when $|A| = 2$, the tree $\bar{\mathfrak{K}}(A)$ is called a *rooted binary tree*.

7.6. Proposition. *All rooted p -regular trees are isomorphic.*

□ Suppose that $G(V, E)$ is a p -regular rooted tree with root σ . Lets prove that $G(V, E)$ is isomorphic to tree $\bar{\mathfrak{K}}(\overline{0, p-1})$.

Suppose that $L(n)$ is set of n -th level vertices of graph $G(V, E)$. Lets inductively define bijection $f : V \rightarrow \overline{0, p-1}^*$. $f(\sigma) = \lambda$.

Suppose that f already is defined for all elements of set $\bigcup_{k=0}^n L(k)$, $v \in L(n)$ and $f(v) = u \in \overline{0, p-1}^n$, then $\deg^+(v) = p$. Suppose that

$$(v, v_0), (v, v_1), \dots, (v, v_{p-1})$$

are arcs of tree $G(V, E)$, then

$$f(v_0) = u0, f(v_1) = u1, \dots, f(v_{p-1}) = u(p-1).$$

From the definition follows that f and f^{-1} are bijections. We need to make sure that both mappings are homomorphisms. Suppose that $(v, w) \in E$, then there exist n such as $v \in L(n)$ and $w \in L(n+1)$. According to the definition of f

$$\exists u \in \overline{0, p-1}^n, f(v) = u \wedge \exists a \in \overline{0, p-1}, f(w) = ua.$$

Therefore

$$(f(v), f(w)) = (u, ua) \in \mathcal{U} = \{(u, ua) \mid u \in \overline{0, p-1}^* \wedge a \in \overline{0, p-1}\}.$$

We note that \mathcal{U} is the set of arcs of tree $\bar{\mathfrak{K}}(\overline{0, p-1})$.

Suppose that $(u, ua) \in \mathcal{U}$, then exists n and $v \in L(n)$ such as $f(v) = u$. According to the definition of f there exist $w \in L(n+1)$ such as $(v, w) \in E$ and $f(w) = ua$. Hence

$$(f^{-1}(u), f^{-1}(ua)) = (v, w) \in E.$$

■

As result with the precision up to isomorphism there exist only one p -regular rooted tree. For this reason, unless required otherwise, we choose tree $\bar{\mathfrak{K}}(\overline{0, p-1})$ as p -regular rooted tree.

Let

$$\sigma \xrightarrow{a_1} v_1 \xrightarrow{a_2} \dots \xrightarrow{a_n} v_n \tag{4}$$

be a walk in labeled tree $\bar{\mathfrak{K}}(\overline{0, 1})$ (look 8. fig.), then

$$v_1 = a_1, v_2 = a_1a_2, \dots, v_n = a_1a_2 \dots a_n.$$

Hence if we are interested only in those walks starting at root σ , we can restrict our attention to $\bar{\mathfrak{K}}(\overline{0, 1})$. Vertex v_n uniquely defines previously mentioned walk (4).

We will restrict our attention only on the endomorphisms of tree $\bar{\mathfrak{K}}(A)$. With $\text{End}(A^*)$ we denote the set of all endomorphisms of tree $\bar{\mathfrak{K}}(A)$. With $\text{Aut}(A^*)$ we denote the set of all automorphisms of tree $\bar{\mathfrak{K}}(A)$.

7.7. Lemma. *If $f \in \text{End}(A^*)$, then $\forall u \in A^* |f(u)| = |u|$.*

□ We have $f(\lambda) = \lambda$ because λ is a root. The set of arcs of tree $\bar{\mathfrak{K}}(A)$ is

$$\mathcal{U} = \{(u, ua) \mid u \in A^* \wedge a \in A\}.$$

As f is an endomorphism, then $\forall a \in A f(\lambda, f(a)) \in \mathcal{U}$. Hence

$$\exists b \in A (f(\lambda), f(a)) = (\lambda, f(a)) = (\lambda, \lambda b) = (\lambda, b).$$

Therefore $f(a) = b$ and $|f(a)| = |b| = 1 = |a|$.

Further proof is inductive, given $u \in A^n$, then $|f(u)| = |u| = n$. Suppose that $w \in A^{n+1}$, then $\exists u \in A^n \exists a \in A w = ua$. Hence $(u, w) = (u, ua) \in \mathcal{U}$. As f is an endomorphism, then $(f(u), f(w)) = (f(u), f(ua)) \in \mathcal{U}$. Hence $|f(ua)| = |f(u)| + 1$. Therefore

$$|f(w)| = |f(ua)| = |f(u)| + 1 = |u| + 1 = |ua| = |w|. \quad \blacksquare$$

7.8. Definition. $\langle \text{End}(A^*), \cdot \rangle$ is a monoid. Here

$$\text{End}(A^*) \times \text{End}(A^*) \rightarrow \text{End}(A^*)$$

is a composition of mappings.

□ The identity mapping $\mathbb{I} : A^* \rightarrow A^* : u \mapsto u$ is an endomorphism of tree $\bar{\mathfrak{K}}(A)$ and serves as neutral element. We need to prove, that the composition of endomorphisms is an endomorphism.

Suppose that $f, g \in \text{End}(A^*)$ and (u, v) is an arc of tree $\bar{\mathfrak{K}}(A)$, then $(f(u), f(v))$ is an arc of tree $\bar{\mathfrak{K}}(A)$, therefore $(g(f(u)), g(f(v)))$ is an arc of tree $\bar{\mathfrak{K}}(A)$. Finally, we have that $g(f(\lambda)) = g(\lambda) = \lambda$. Hence $g \cdot f$ is an endomorphism. ■

7.9. Proposition. *A mapping $f : A^* \rightarrow A^*$ is a sequential function, if and only if $f \in \text{End}(A^*)$.*

□ \Rightarrow Suppose that $f : A^* \rightarrow A^*$ is sequential function, then $f(\lambda) = \lambda$ because accordingly to the definition of sequential function $|f(\lambda)| = |\lambda| = 0$. Suppose that (u, ua) is arc of tree $\bar{\mathfrak{K}}(A)$, then $f(u) \in \text{Pref}(f(ua))$. Therefore $|u| = |f(u)|$ and $|ua| = |f(ua)|$. Hence there exist some $b \in A$ such as $f(ua) = f(u)b$. It means that $(f(u), f(ua)) = (f(u), f(u)b)$ is arc of tree $\bar{\mathfrak{K}}(A)$.

\Leftarrow Suppose that $f \in \text{End}(A^*)$, then (Lemma 7.7) $\forall u \in A^* |f(u)| = |u|$. Suppose that $u \in A^*$ and $a \in A$, then (u, ua) is arc of tree $\bar{\mathfrak{K}}(A)$, therefore $(f(u), f(ua))$ is an arc of tree $\bar{\mathfrak{K}}(A)$. Hence there exist some $b \in A$ such as $f(ua) = f(u)b$. Therefore $f(u) \in \text{Pref}(f(ua))$.

Further proof is inductive, given

$$u \in \text{Pref}(v) \Rightarrow f(u) \in \text{Pref}(f(v))$$

only if $|v| - |u| \leq n$.

Suppose that $u \in \text{Pref}(v)$ and $|v| - |u| = n + 1$, then exists $w \in A^*$ and $a \in A$ such as $v = uwa$ and $|w| = n$. As (uw, uwa) is an arc of tree $\bar{\mathfrak{R}}(A)$, then $f(uw) \in \text{Pref}(f(uwa))$. Accordingly with the induction hypothesis $f(u) \in \text{Pref}(f(uw))$, therefore $f(u) \in \text{Pref}(f(uwa)) = \text{Pref}(f(v))$. ■

7.10. Corollary. *If mapping $f : A^* \rightarrow A^*$ is a restricted sequential function, then $f \in \text{End}(A^*)$.*

Suppose that $q \in Q$, then mapping $\bar{q} : A^* \rightarrow A^*$ sometimes is called q action on tree $\bar{\mathfrak{R}}(A)$.

7.11. Lemma. *The mapping $\phi : Q^+ \rightarrow \text{End}(A^*) : x \mapsto \bar{x}$ is a homomorphism of semigroups.*

□ Suppose that $u \in A^*$ and $x, y \in Q^+$, then $u\phi(xy) = u\overline{xy} = (u\bar{x})\bar{y}$ and $(u\phi(x))\phi(y) = (u\bar{x})\bar{y}$. Hence $\phi(xy) = \phi(x)\phi(y)$ ■

Suppose that $u \in A^*$ and $x \in Q^+$, then we would use notation $ux \Leftarrow u\phi(x)$. For denoting semigroup $\text{Im}(\phi)$ we would use notation $\Sigma(\mathfrak{M})$, showing to which machine correspond given semigroup .

7.12. Definition. *A semigroup P is called a machine semigroup (automaton semigroup) if there exist a Mealy machine \mathfrak{M} such that $P \cong \Sigma(\mathfrak{M})$.*

As $\text{Ker}(\phi) = \{(x, y) \mid \phi(x) = \phi(y)\}$ is a congruence, then $Q^+/\text{Ker}(\phi)$ is semigroup and $Q^+/\text{Ker}(\phi) \cong \text{Im}(\phi) = \Sigma(\mathfrak{M})$. Accordingly to the $\text{Ker}(\phi)$ definition x and y belong to the same coset, if $\phi(x) = \phi(y)$. Hence

$$\forall u \in A^* \quad ux = u\phi(x) = u\phi(y) = uy.$$

Therefore $\forall \alpha \in A^\omega \quad \alpha x = \alpha y$, where $\alpha x \Leftarrow \lim_{n \rightarrow \infty} \alpha_n$, α_n is a prefix of ω -word α .

8. Machine groups

8.1. Definition. *Machine $\mathfrak{M} = \langle Q, A, \circ, * \rangle$ is called to be invertible if for $\forall q \in Q$ mapping $\bar{q}|A$ is a bijection.*

8.2. Proposition. *If $\mathfrak{M} = \langle Q, A, \circ, * \rangle$ is an invertible machine, then $\forall q \in Q \quad \bar{q} : A^* \rightarrow A^*$ is a bijection.*

□ (i) Accordingly to the definition $\bar{q}|A$ is a bijection. We need to prove that $\forall n \in \mathbb{N} \quad \bar{q}|A^n$ is a bijection. This in turn would prove that $\bar{q} : A^* \rightarrow A^*$ is a bijection.

(ii) The proof is done by induction on n . Let $w, w' \in A^{n+1}$, then exists words $v, v' \in A^n$ and $a, a' \in A$ such that

$$\begin{aligned} w\bar{q} &= q * w = q * va = q * v\#q \circ v * a, \\ w'\bar{q} &= q * w' = q * v'a' = q * v'\#q \circ v * a'. \end{aligned}$$

Suppose that $\forall q \in Q \bar{q}|A^n$ is a bijection and $v \neq v'$, then $q*v \neq q*v'$, and therefore $w\bar{q} \neq w'\bar{q}$.

Suppose that $v = v'$ and $a \neq a'$. As for $\forall q \in Q$ mapping $\bar{q}|A^n$ is a bijection, then $\overline{q \circ v}|A$ is a bijection. Hence $q \circ v * a \neq q \circ v * a'$, and therefore $w\bar{q} \neq w'\bar{q}$. Hence $\bar{q}|A^{n+1}$ is an injection.

(iii) Suppose that $w \in A^{n+1}$, then there exist words $v \in A^n$ and $b \in A$ such that $w = vb$. Suppose that $\forall q \in Q \bar{q}|A^n$ is a bijection, then there exist $u \in A^n$ such that $v = u\bar{q} = q * u$.

If $\forall q \in Q \bar{q}|A^n$ is a bijection, then $\overline{q \circ u}|A$ is a bijection, therefore exists $a \in A$ such that $q \circ u * a = b$. Hence

$$ua\bar{q} = q * ua = q * u \# q \circ u * a = vb = w.$$

Thus $\bar{q}|A^{n+1}$ is a surjection. ■

8.3. Corollary. *If $\mathfrak{M} = \langle Q, A, \circ, * \rangle$ is an invertible machine, then*

$$\forall q \in Q \forall v \in A^* \exists! u \in A^* q * u = v.$$

□ $\bar{q} : A^* \rightarrow A^*$ is bijection. ■

Lets define for each invertible machine $\mathfrak{M} = \langle Q, A, \circ, * \rangle$
 $Q^{-1} \Leftarrow \{q^{-1} | q \in Q\};$
 $\bar{q}^{-1} : A^* \rightarrow A^* : v \mapsto vq^{-1}$, where $vq^{-1} \Leftarrow u$, if $q * u = v$.

8.4. Corollary. $\forall q \in Q, \forall u \in A^*, uq^{-1} = uq^{-1}q = u$.

8.5. Lemma. *If $q \in Q$, then mapping $\bar{q}^{-1} \in \text{End}(A^*)$ for each invertible machine $\mathfrak{M} = \langle Q, A, \circ, * \rangle$.*

□ The arcs of tree $\mathfrak{R}(A)$ are (u, ua) , where $u \in A^*$ and $a \in A$. Mapping $\bar{q}^{-1} \in \text{End}(A^*)$ if (uq^{-1}, uaq^{-1}) is an arc of tree $\mathfrak{R}(A)$. As we are interested in endomorphisms of rooted oriented tree $\mathfrak{R}(A)$, then we need to prove that $\lambda q^{-1} = \lambda$. Last identity arises from the definition of mapping \bar{q}^{-1} , i.e., $\lambda q^{-1} = u'$, if $q * u' = \lambda$. The only word $u' \in A^*$, with property $q * u' = \lambda$, is $u' = \lambda$. Therefore $\lambda q^{-1} = \lambda$.

Suppose that $uq^{-1} = v$ and $uaq^{-1} = w$. According with definition of \bar{q}^{-1} follows that, $q * v = u$ and $q * w = ua$. Suppose that $w = v'b$, $v' \in A^*$ and $b \in A$, then

$$ua = q * w = q * v'b = q * v' \# q \circ v' * b.$$

Hence $q * v' = u = q * v$. As \bar{q} is a bijection, then $v = v'$. This means that $uaq^{-1} = w = v'b = vb$. Hence $(uq^{-1}, uaq^{-1}) = (v, w) = (v, vb)$, where (v, vb) is an arc in tree $\mathfrak{R}(A)$. ■

For each $q^{-1} \in Q^{-1}$ mapping $\bar{q}^{-1} \in \text{End}(A^*)$. We further would use notation $q^{-1} \Leftarrow \bar{q}^{-1}$.

Further definition is inductive. Suppose that $x \in (Q \cup Q^{-1})^+$, then with \overline{xq} we would denote function

$$\overline{xq} : A^* \rightarrow A^* : u \mapsto (u\bar{x})\bar{q} \Leftarrow \bar{q}(\bar{x}(u)),$$

if $q \in Q$. Contrary if $q^{-1} \in Q^{-1}$, then with $\overline{xq^{-1}}$ we denote function

$$\overline{xq^{-1}} : A^* \rightarrow A^* : u \mapsto (u\bar{x})\bar{q}^{-1} \stackrel{\text{def}}{=} \bar{q}^{-1}(\bar{x}(u)).$$

8.6. Lemma. *If $\mathfrak{M} = \langle Q, A, \circ, * \rangle$ is an invertible machine, then mapping*

$$\phi : (Q \cup Q^{-1})^+ \rightarrow \text{End}(A^*) : x \mapsto \bar{x}$$

is a homomorphism of semigroups.

□ Suppose that $u \in A^*$ and $x, y \in (Q \cup Q^{-1})^+$, then $u\phi(xy) = u\bar{x}\bar{y} = (u\bar{x})\bar{y}$ and $(u\phi(x))\phi(y) = (u\bar{x})\bar{y}$. Therefore $\phi(xy) = \phi(x)\phi(y)$. ■

8.7. Definition. *If $\mathfrak{M} = \langle Q, A, \circ, * \rangle$ is invertible machine, then homomorphism*

$$\phi : (Q \cup Q^{-1})^+ \rightarrow \text{End}(A^*) : x \mapsto \bar{x}$$

is called the natural homomorphism.

8.8. Corollary. *If $\mathfrak{M} = \langle Q, A, \circ, * \rangle$ is invertible machine, then $\forall x \in (Q \cup Q^{-1})^+$ mapping \bar{x} is automorphism of ordered rooted tree $\bar{\mathfrak{R}}(A)$.*

□ Suppose that $q \in Q$. We have already proved (by lemma 8.5), that $\bar{q}^{-1} \in \text{End}(A^*)$. By corollary 8.4 we have that $\bar{q}\bar{q}^{-1} = \bar{q}^{-1}\bar{q} = \mathbb{I}$, i.e., compositions of those mappings is the identity mapping. Therefore \bar{q}^{-1} is the inverse mapping of \bar{q} and an endomorphism. Hence $\bar{q}, \bar{q}^{-1} \in \text{Aut}(A^*)$.

Further proof is inductive. Let $x \in (Q \cup Q^{-1})^+$, $|x| = n$ and $\bar{x} \in \text{Aut}(A^*)$. If $q \in Q \cup Q^{-1}$, then $\bar{q} \in \text{Aut}(A^*)$. Hence $\overline{xq} = \bar{x}\bar{q} \in \text{Aut}(A^*)$ (Proposition 6.34). ■

8.9. Proposition. *Let $\mathfrak{M} = \langle Q, A, \circ, * \rangle$ be an invertible machine, then image $\text{Im}\phi$ of natural homomorphism*

$$\phi : (Q \cup Q^{-1})^+ \rightarrow \text{End}(A^*) : x \mapsto \bar{x}$$

is a subgroup of group $\text{Aut}(A^)$.*

□ Accordingly to corollary 8.4 we have $\mathbb{I} \in \text{Im}\phi$. If $f, g \in \text{Im}\phi$, then exists $x, y \in (Q \cup Q^{-1})^+$ such that $x\phi = f$ and $y\phi = g$. Hence (by lemma 8.6) $fg = (x\phi)(y\phi) = xy\phi \in \text{Im}\phi$.

If $|x| = 1$, then $x \in Q \cup Q^{-1}$. Then we have $x = q$ or $x = q^{-1}$ for some $q \in Q$.

(i) Suppose that $x = q$, then $q^{-1}\phi \in \text{Im}\phi$ and

$$f(q^{-1}\phi) = (x\phi)(q^{-1}\phi) = (q\phi)(q^{-1}\phi) = (qq^{-1}\phi) = \overline{qq^{-1}} \stackrel{\text{S8.4}}{=} \mathbb{I}.$$

Therefore $f^{-1} = q^{-1}\phi \in \text{Im}\phi$.

(ii) Suppose that $x = q^{-1}$, then $q\phi \in \text{Im}\phi$ and

$$fq\phi = (x\phi)(q\phi) = (q^{-1}\phi)(q\phi) = (q^{-1}q)\phi = \overline{q^{-1}q} \stackrel{\text{S8.4}}{=} \mathbb{I}.$$

Therefore $f^{-1} = q\phi \in \text{Im}\phi$.

(iii) Suppose that $g \in \text{Im}\phi$, $g = z\phi$, $z \in (Q \cup Q^{-1})^k$ and $k \leq n$, then exists $z' \in (Q \cup Q^{-1})^k$ such that $g^{-1} = z'\phi \in \text{Im}\phi$.

Further proof is inductive. Let $f \in \text{Im}\phi$ and there exist $x' \in (Q \cup Q^{-1})^{n+1}$ such that $x'\phi = f$. If so, then here exists $x \in (Q \cup Q^{-1})^n$ and $q \in Q \cup Q^{-1}$ such that $x' = xq$. Accordingly to the induction hypothesis here exists $y' \in (Q \cup Q^{-1})^n$ and $q' \in Q \cup Q^{-1}$ such that $(x\phi)^{-1} = y'\phi \in \text{Im}\phi$ and $(q\phi)^{-1} = q'\phi \in \text{Im}\phi$. Hence $q'y' \in (Q \cup Q^{-1})^{n+1}$ and $(q'y')\phi \in \text{Im}\phi$, and we have also

$$\begin{aligned} f((q'y')\phi) &= (x'\phi)((q'y')\phi) = ((xq)\phi)((q'y')\phi) = (xqq'y')\phi \\ &= (x\phi)((qq')\phi)y'\phi = (x\phi)((q\phi)(q'\phi))y'\phi \\ &= (x\phi)((q\phi)(q\phi)^{-1})y'\phi = (x\phi)\mathbb{I}y'\phi = (x\phi)y'\phi \\ &= (x\phi)(x\phi)^{-1} = \mathbb{I}. \end{aligned}$$

Therefore $f^{-1} = (q'y')\phi \in \text{Im}\phi$. This concludes the inductive proof. ■

For denoting a group $\text{Im}\phi$ we would use notation $\Gamma(\mathfrak{M})$ showing the corresponding machine .

8.10. Definition. A group G is called a machine group (automaton group), if there exist an invertible Mealy machine \mathfrak{M} such that $G \cong \Gamma(\mathfrak{M})$.

8.11. Proposition. The set

$$AS_A \Leftarrow \{f \in P^A \mid f \text{ is bijection}\}$$

is a group in which group operation is composition of restricted sequential functions.

□ Suppose that $f \in AS_A$, then exists Mealy machine

$$V = \langle Q, A, A; q_0, \circ, * \rangle,$$

such that $\forall u \in A^* f(u) = q_0 * u$.

Lets define a new Mealy machine $V' = \langle Q, A, A; q_0, \acute{\circ}, \acute{*} \rangle$, where

$$q\acute{*}a \Leftarrow b, \text{ ja } q * b = a, \tag{5}$$

$$q\acute{\circ}a \Leftarrow q \circ b, \text{ ja } q * b = a. \tag{6}$$

The new Mealy machine defines restricted sequential function $g(u) \Leftarrow q_0 \acute{*}u$.

We need to prove that $g = f^{-1}$, i.e., g is the inverse function of f .

(i) Suppose that $Q' = \{q \mid \exists u \in A^* q = q_0 \circ u\}$. Lets prove

$$\forall q \in Q' \forall a \in A q * (q \acute{*} a) = a. \quad (7)$$

Suppose that $q = q_0 \circ u$, then

$$f(ua) = q_0 * ua = q_0 * u \# q_0 \circ u * a = q_0 * u \# q * a.$$

Accordingly to the definition of $q \acute{*} a$ if $q * b = a$, then $q \acute{*} a = b$. As f is a bijection, therefore exists unique $b \in A$. Hence

$$q * (q \acute{*} a) = q * b = a. \quad (8)$$

We have proven, that $fg(a) = a$.

Accordingly to $q \acute{o} a$ we have that

$$q \circ (q \acute{*} a) = q \circ b = q \acute{o} a. \quad (9)$$

Further proof is inductive, given

$$\forall q' \in Q' \forall v \in A^n \quad q' * (q' \acute{*} v) = v. \quad (10)$$

Suppose that $w \in A^{n+1}$, then there exist $a \in A$ and $v \in A^n$ such that $w = av$. Hence

$$\begin{aligned} q * (q \acute{*} w) &= q * (q \acute{*} av) = q * (q \acute{*} a \# q \acute{o} a \acute{*} v) \\ &= q * (q \acute{*} a) \# q \circ (q \acute{*} a) * (q \acute{o} a \acute{*} v) \\ &\stackrel{(8)}{=} a \# q \circ (q \acute{*} a) * (q \acute{o} a \acute{*} v) \\ &\stackrel{(9)}{=} a \# q \acute{o} a * (q \acute{o} a \acute{*} v) \\ &\stackrel{(10)}{=} a \# v = w. \end{aligned}$$

This concludes the inductive part of the proof.

In a particular case we have $fg(w) = q_0 * (q_0 \acute{*} w) = w$. Therefore $g = f^{-1}$.

(ii) Suppose that f and g are two restricted sequential functions of the set AS_A , then there exist two Mealy machines $V = \langle Q, A, A; q_0, \circ, * \rangle$, $V' = \langle Q', A, A; q'_0, \acute{o}, \acute{*} \rangle$ such that

$$\forall u \in A^* (f(u) = q_0 * u \wedge g(u) = q'_0 \acute{*} u).$$

The serial composition of these machines $V \rightsquigarrow V'$ is a machine implementing the composition of functions f and g . To be more precise, if $\check{V} = \langle \check{Q}, A, A; \check{q}_0, \acute{\acute{o}}, \acute{\acute{*}} \rangle \in V \rightsquigarrow V'$, then

$$\forall u \in \overline{0, 1}^* \quad gf(u) = \check{q}_0 \acute{\acute{*}} u.$$

(iii) The identity function $\mathbb{I} : A^* \rightarrow A^* : u \mapsto u$ is restricted sequential function. Machine implementing identity function given as V_{15a} (shown in 8.fig.).

(iv) We note that the composition of functions is associative. Finally, we have proven that AS_A is a group. ■

V_{15a}

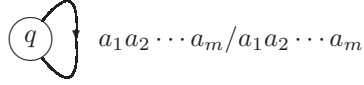

9. Figure: Implementation of identity function.

8.12. Corollary. *If $\mathfrak{M} = \langle Q, A, \circ, * \rangle$ is an invertible machine, then $\Gamma(\mathfrak{M})$ is a subgroup of group AS_A .*

8.13. Proposition. *If $|A| = |B|$, then $AS_A \cong AS_B$.*

□ If $|A| = |B|$, then exists bijection $\varphi : A \rightarrow B$. Suppose that $f \in AS_A$, then exists Mealy machine

$$V = \langle Q, A, A; q_0, \circ, * \rangle,$$

ka $\forall u \in A^* f(u) = q_0 * u$. Lets define a new Mealy machine $V' = \langle Q, B, B; q_0, \acute{\circ}, \acute{*} \rangle$, where

$$\begin{aligned} q\acute{\circ}\varphi(a) & \equiv q \circ a, \\ q\acute{*}\varphi(a) & \equiv \varphi(q * a). \end{aligned}$$

Machine V is invertible therefore $\bar{q}|A : A \rightarrow A : a \mapsto q * a$ is a bijection. A composition of bijections is a bijection therefore

$$\bar{q}|B \equiv \varphi(\bar{q}|A)\varphi^{-1} : B \rightarrow B : b \mapsto \varphi(q * \varphi^{-1}(b)) = q\acute{*}\varphi\varphi^{-1}(b) = q\acute{*}b$$

is a bijection, where $\forall v \in B^* \bar{q}(v) \equiv q\acute{*}v$. Hence V' is a invertible machine. This whole construction describes mapping

$$\psi : AS_A \rightarrow AS_B : f \mapsto \psi(f),$$

where $\psi(f)(v) = q_0\acute{*}v$ is a restricted sequential function. In present case $f = \bar{q}_0$ and $\psi(f) = \bar{q}_0$.

Suppose that $g \in AS_A$, then there exist a Mealy machine

$$W = \langle Q', A, A; t_0, \odot, \otimes \rangle,$$

such that $\forall u \in A^* g(u) = t_0 \otimes u$. Let define a new Mealy machine $W' \equiv \langle Q', A, A; t_0, \acute{\odot}, \acute{\otimes} \rangle$, where

$$\begin{aligned} q\acute{\odot}\varphi(a) & \equiv q \odot a, \\ q\acute{\otimes}\varphi(a) & \equiv \varphi(q \otimes a). \end{aligned}$$

From previous construction we have that $\bar{t}_0 = \psi(\bar{t}_0) = \psi(g)$.

The serial composition $V \rightsquigarrow W$ of machines V, W is a machine implementing the composition of functions f and g . Formally,

$$V_W \equiv \langle Q' \times Q, A, A; (t_0, q_0), \acute{\circ}, \acute{*} \rangle,$$

where

$$\begin{aligned}(t, q)\dot{\circ}a & \equiv (t \odot q * a, q \circ a); \\ (t, q)\dot{*}a & \equiv t \otimes q * a,\end{aligned}$$

then $\forall u \in A^*$ $gf(u) = t_0 \otimes q_0 * u$. By previously described construction machine

$$V'_W \equiv \langle Q' \times Q, B, B; (t_0, q_0), \ddot{\circ}, \ddot{*} \rangle,$$

where

$$\begin{aligned}(t, q)\ddot{\circ}\varphi(a) & \equiv (t, q)\dot{\circ}a, \\ (t, q)\ddot{*}\varphi(a) & \equiv \varphi((t, q)\dot{*}a) = \varphi(t \otimes q * a),\end{aligned}$$

implementing mapping $\psi(gf)$, i.e.,

$$\forall v \in B^* \quad \psi(gf)(v) = (t_0, q_0)\ddot{*}v = \varphi(t_0 \otimes q_0 * \varphi^{-1}(v)).$$

The mapping φ is inductively extended on set A^* , by a condition

$$\varphi(ua) \equiv \varphi(u)\# \varphi(a).$$

$$\begin{aligned}(\psi(g)\psi(f))(v) & = \tilde{t}_0(\tilde{q}_0(v)) = \tilde{t}_0(\varphi(q_0 * \varphi^{-1}(v))) \\ & = \varphi(t_0 \otimes \varphi^{-1}\varphi(q_0 * \varphi^{-1}(v))) \\ & = \varphi(t_0 \otimes (q_0 * \varphi^{-1}(v))) = \psi(gf)(v).\end{aligned}$$

Therefore mapping $\psi : AS_A \rightarrow AS_B$ is a group homomorphism.

Suppose that $f \neq g$, then $\exists u \in A^*$ $f(u) \neq g(u)$, i.e.,

$$\begin{aligned}q_0 * u & = \bar{q}_0(u) = f(u) \\ & \neq g(u) = \bar{t}_0(u) = t_0 \otimes u.\end{aligned}$$

Hence

$$\begin{aligned}\psi(f)(\varphi(u)) & = \tilde{q}_0(\varphi(u)) = q_0\dot{*}\varphi(u) = \varphi(q_0 * u) \\ & \neq \varphi(t_0 \otimes u) = t_0\dot{*}\varphi(u) = \tilde{t}_0(\varphi(u)) = \psi(g)(\varphi(u)).\end{aligned}$$

Therefore mapping ψ is an injection.

Suppose that $h \in AS_B$, then exists Mealy machine $\check{\mathfrak{M}} = \langle R, B, B; r_0, \check{\circ}, \check{*} \rangle$ such that $\forall v \in B^*$ $h(v) = r_0\check{*}v$. We define new machine $\hat{\mathfrak{M}} \equiv \langle R, A, A; r_0, \hat{\circ}, \hat{*} \rangle$, where

$$\begin{aligned}r\hat{\circ}\varphi^{-1}(b) & \equiv r\check{\circ}b, \\ r\hat{*}\varphi^{-1}(b) & \equiv \varphi^{-1}(r\check{*}b).\end{aligned}$$

For $\hat{\mathfrak{M}}$ we have $\forall u \in A^* \quad \bar{r}_0(u) \Leftarrow r_0 \hat{*} u$. By previously described construction we have that machine $\hat{\mathfrak{M}}$ is invertible, therefore $\bar{r}_0 \in AS_A$.

We apply previously described construction to machine $\hat{\mathfrak{M}}$ and create machine $\check{\mathfrak{M}} = \langle R, B, B; r_0, \check{\circ}, \check{*} \rangle$, where

$$\begin{aligned} r\check{\circ}\varphi(a) &\Leftarrow r\hat{\circ}a = r\hat{\circ}\varphi^{-1}\varphi(a) = r\check{\circ}\varphi(a), \\ r\check{*}\varphi(a) &\Leftarrow \varphi(r\hat{*}a) = \varphi(r\hat{*}\varphi^{-1}\varphi(a)) = \varphi\varphi^{-1}(r\check{*}\varphi(a)) = r\check{*}\varphi(a). \end{aligned}$$

Hence $\psi(\bar{r}_0) = h$. Therefore ψ is a surjection.

Finally, we have that mapping ψ is an isomorphism of groups AS_A, AS_B , therefore $AS_A \cong AS_B$. ■

8.14. Example.

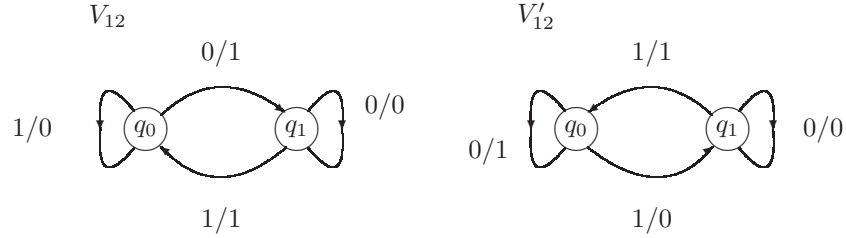

10. Figure: Invertible machine V_{12} .

Machine V_{12} (10.fig.) is invertible because \bar{q}_0 is a bijection. Machine V'_{12} (10.fig.) is constructed according to expressions (5), (6):

$$\begin{aligned} q_0 \hat{*} 0 &= 1, & j_0 \quad q_0 * 1 &= 0, \\ q_0 \hat{\circ} 0 &= q_0 \circ 1 = q_0, & j_0 \quad q_0 * 1 &= 0, \\ q_0 \hat{*} 1 &= 0, & j_0 \quad q_0 * 0 &= 1, \\ q_0 \hat{\circ} 1 &= q_0 \circ 0 = q_1, & j_0 \quad q_0 * 0 &= 1, \\ q_1 \hat{*} 0 &= 0, & j_0 \quad q_1 * 0 &= 0, \\ q_1 \hat{\circ} 0 &= q_1 \circ 0 = q_1, & j_0 \quad q_1 * 0 &= 0, \\ q_1 \hat{*} 1 &= 1, & j_0 \quad q_1 * 1 &= 1, \\ q_1 \hat{\circ} 1 &= q_1 \circ 1 = q_0, & j_0 \quad q_1 * 1 &= 1. \end{aligned}$$

Mapping $\tilde{q}_0(u) \Leftarrow q_0 \hat{*} u$ is inverse of mapping $\bar{q}_0(u) \Leftarrow q_0 * u$.

8.15. Definition. Let $\dot{V} = \langle \dot{Q}, \dot{A}, \dot{B}; \dot{\circ}, \dot{*} \rangle$, $\ddot{V} = \langle \ddot{Q}, \ddot{A}, \ddot{B}; \ddot{\circ}, \ddot{*} \rangle$ be Mealy machines. A total map

$$\mu = (\mu_1, \mu_2, \mu_3) : (\dot{Q}, \dot{A}, \dot{B}) \longrightarrow (\ddot{Q}, \ddot{A}, \ddot{B})$$

is called a homomorphism $\mu : \dot{V} \rightarrow \ddot{V}$ if

$$\mu_1(q\dot{\circ}a) = \mu_1(q)\ddot{\circ}\mu_2(a) \wedge \mu_3(q\dot{*}a) = \mu_1(q)\dot{*}\mu_2(a)$$

for $\forall(q, a) \in Q \times A$.

Lets consider machines V_{12} u V'_{12} (10.fig.) and consider mapping

$$\mu = (\mu_1, \mu_2, \mu_3) : V_{12} \rightarrow V'_{12},$$

where

$$\begin{aligned} \mu_1 : q_0 &\mapsto q_0, & q_1 &\mapsto q_0; \\ \mu_2 : 0 &\mapsto 0, & 1 &\mapsto 0; \\ \mu_3 : 0 &\mapsto 1, & 1 &\mapsto 1. \end{aligned}$$

$$\begin{aligned} \mu_1(q_0 \circ 0) &= \mu_1(q_1) = q_0 = q_0 \acute{\circ} 0 = \mu_1(q_0) \acute{\circ} \mu_2(0), \\ \mu_3(q_0 * 0) &= \mu_3(1) = 1 = q_0 \acute{*} 0 = \mu_1(q_0) \acute{*} \mu_2(0), \\ \mu_1(q_0 \circ 1) &= \mu_1(q_0) = q_0 = q_0 \acute{\circ} 0 = \mu_1(q_0) \acute{\circ} \mu_2(1), \\ \mu_3(q_0 * 1) &= \mu_3(0) = 1 = q_0 \acute{*} 0 = \mu_1(q_0) \acute{*} \mu_2(1), \\ \mu_1(q_1 \circ 0) &= \mu_1(q_1) = q_0 = q_0 \acute{\circ} 0 = \mu_1(q_1) \acute{\circ} \mu_2(0), \\ \mu_3(q_1 * 0) &= \mu_3(0) = 1 = q_0 \acute{*} 0 = \mu_1(q_1) \acute{*} \mu_2(0), \\ \mu_1(q_1 \circ 1) &= \mu_1(q_0) = q_0 = q_0 \acute{\circ} 0 = \mu_1(q_1) \acute{\circ} \mu_2(1), \\ \mu_3(q_1 * 1) &= \mu_3(1) = 1 = q_0 \acute{*} 0 = \mu_1(q_1) \acute{*} \mu_2(1). \end{aligned}$$

8.16. Proposition. *Let $\dot{V} = \langle \dot{Q}, \dot{A}, \dot{B}; \dot{\circ}, \dot{*} \rangle$ be a Mealy machine, and let there exist state $\dot{q} \in \dot{Q}$ and letter of input alphabet $\dot{a} \in \dot{A}$ such that $\dot{q}\dot{\circ}\dot{a} = \dot{q}$. If so, then for each Mealy machine $\langle Q, A, B; \circ, * \rangle$ there exist a morphism of machines $\mu : V \rightarrow \dot{V}$.*

□ Suppose that $\mu = (\mu_1, \mu_2, \mu_3) : Q \times A \times B \rightarrow \dot{Q} \times \dot{A} \times \dot{B}$ is a mapping defined by conditions

$$\begin{aligned} \forall q \in Q \quad \mu_1(q) &= \dot{q}, \\ \forall a \in A \quad \mu_2(a) &= \dot{a}, \\ \forall b \in B \quad \mu_3(b) &= \dot{q}\dot{*}\dot{a}, \end{aligned}$$

then

$$\begin{aligned} \mu_1(q \circ a) &= \dot{q} = \dot{q}\dot{\circ}\dot{a} = \mu_1(q)\dot{\circ}\mu_2(a), \\ \mu_3(b) &= \dot{q}\dot{*}\dot{a} = \mu_1(q)\dot{*}\mu_2(a). \end{aligned}$$

This shows that $\mu : V \rightarrow \dot{V}$ is a homomorphism of machines. ■

In general case this result is not true even for invertible machines. Moreover, as shown in next example, we can choose invertible machines

$$V_{13} = \langle Q, A, A; q_0, \circ, * \rangle, V'_{13} = \langle Q', A', A'; q'_0, \acute{\circ}, \acute{*} \rangle,$$

such that mapping $\acute{q} \acute{*} u$ is the inverse of mapping $q * u$, but there doesn't exist nether homomorphism $V \rightarrow V'$ nor homomorphism $V' \rightarrow V$.

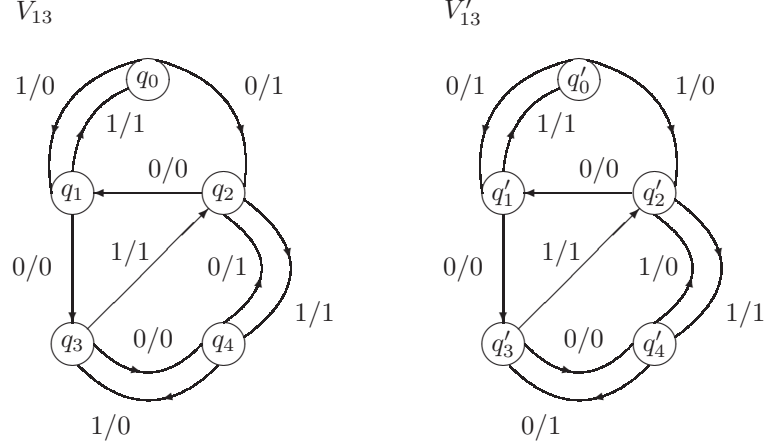

11. Figure: Invertible machine V_{13} .

8.17. Example.

Suppose that $\mu = (\mu_1, \mu_2, \mu_3) : V_{13} \rightarrow V'_{13}$ is a homomorphism.

(i) If $\mu_1(q_0) = q'_0$, then we have cases:

$$\begin{aligned} \mu_2 : \quad & 0 \mapsto 0, \quad 1 \mapsto 0; \\ & 0 \mapsto 0, \quad 1 \mapsto 1; \\ & 0 \mapsto 1, \quad 1 \mapsto 0; \\ & 0 \mapsto 1, \quad 1 \mapsto 1. \end{aligned}$$

(ia) $\mu_2 : 0 \mapsto 0, 1 \mapsto 0$.

$$\begin{aligned} \mu_1(q_1) &= \mu_1(q_0 \circ 1) = \mu_1(q_0) \acute{\circ} \mu_2(1) = q'_0 \acute{\circ} 0 = q'_1, \\ \mu_3(1) &= \mu_3(q_0 * 0) = \mu_1(q_0) \acute{*} \mu_2(0) = q'_0 \acute{*} 0 = 1, \\ \mu_3(1) &= \mu_3(q_1 * 1) = \mu_1(q_1) \acute{*} \mu_2(1) = q'_1 \acute{*} 0 = 0. \end{aligned}$$

Hence $0 = \mu_3(1) = 1$. A contradiction!

(ib) $\mu_2 : 0 \mapsto 0, 1 \mapsto 1$.

$$\begin{aligned} \mu_1(q_2) &= \mu_1(q_0 \circ 0) = q'_0 \acute{\circ} 0 = q'_1, \\ \mu_1(q_1) &= \mu_1(q_0 \circ 1) = q'_0 \acute{\circ} 1 = q'_2, \\ \mu_1(q_1) &= \mu_1(q_2 \circ 0) = q'_1 \acute{\circ} 0 = q'_3. \end{aligned}$$

Hence $q'_3 = \mu_1(q_1) = q'_2$. A contradiction!

(ic) $\mu_2 : 0 \mapsto 1, 1 \mapsto 0$.

$$\begin{aligned}\mu_1(q_2) &= \mu_1(q_0 \circ 0) = q'_0 \acute{\circ} 1 = q'_2, \\ \mu_1(q_1) &= \mu_1(q_0 \circ 1) = q'_0 \acute{\circ} 0 = q'_1, \\ \mu_1(q_1) &= \mu_1(q_2 \circ 0) = q'_2 \acute{\circ} 1 = q'_4.\end{aligned}$$

Hence $q'_4 = \mu_1(q_1) = q'_1$. A contradiction!

(id) $\mu_2 : 0 \mapsto 1, 1 \mapsto 1$.

$$\begin{aligned}\mu_1(q_2) &= \mu_1(q_0 \circ 0) = q'_0 \acute{\circ} 1 = q'_2, \\ \mu_1(q_1) &= \mu_1(q_0 \circ 1) = q'_0 \acute{\circ} 1 = q'_2, \\ \mu_1(q_1) &= \mu_1(q_2 \circ 0) = q'_2 \acute{\circ} 1 = q'_4.\end{aligned}$$

Hence $q'_4 = \mu_1(q_1) = q'_2$. A contradiction!

(ii) Suppose that $\mu_1(q_0) = q'_1$.

(iia) $\mu_2 : 0 \mapsto 0, 1 \mapsto 0$.

$$\begin{aligned}\mu_1(q_2) &= \mu_1(q_0 \circ 0) = q'_1 \acute{\circ} 0 = q'_3, \\ \mu_1(q_1) &= \mu_1(q_0 \circ 1) = q'_1 \acute{\circ} 0 = q'_3, \\ \mu_1(q_1) &= \mu_1(q_2 \circ 0) = q'_3 \acute{\circ} 0 = q'_4.\end{aligned}$$

Hence $q'_4 = \mu_1(q_1) = q'_3$. A contradiction!

(iib) $\mu_2 : 0 \mapsto 0, 1 \mapsto 1$.

$$\begin{aligned}\mu_1(q_2) &= \mu_1(q_0 \circ 0) = q'_1 \acute{\circ} 0 = q'_3, \\ \mu_1(q_1) &= \mu_1(q_0 \circ 1) = q'_1 \acute{\circ} 1 = q'_0, \\ \mu_1(q_1) &= \mu_1(q_2 \circ 0) = q'_3 \acute{\circ} 0 = q'_4.\end{aligned}$$

Hence $q'_4 = \mu_1(q_1) = q'_0$. A contradiction!

(iic) $\mu_2 : 0 \mapsto 1, 1 \mapsto 0$.

$$\begin{aligned}\mu_1(q_2) &= \mu_1(q_0 \circ 0) = q'_1 \acute{\circ} 1 = q'_0, \\ \mu_1(q_1) &= \mu_1(q_0 \circ 1) = q'_1 \acute{\circ} 0 = q'_3, \\ \mu_1(q_1) &= \mu_1(q_2 \circ 0) = q'_0 \acute{\circ} 1 = q'_2.\end{aligned}$$

Hence $q'_2 = \mu_1(q_1) = q'_3$. A contradiction!

(iid) $\mu_2 : 0 \mapsto 1, 1 \mapsto 1$.

$$\begin{aligned}\mu_1(q_2) &= \mu_1(q_0 \circ 0) = q'_1 \acute{\circ} 1 = q'_0, \\ \mu_3(0) &= \mu_3(q_0 * 1) = q'_1 \acute{*} 1 = 1, \\ \mu_3(0) &= \mu_3(q_2 * 0) = q'_0 \acute{*} 1 = 0.\end{aligned}$$

Hence $0 = \mu_3(0) = 1$. A contradiction!

(iii) Suppose that $\mu_1(q_0) = q'_2$.

(iii a) $\mu_2 : 0 \mapsto 0, 1 \mapsto 0$.

$$\begin{aligned}\mu_1(q_2) &= \mu_1(q_0 \circ 0) = q'_2 \acute{\circ} 0 = q'_1, \\ \mu_1(q_1) &= \mu_1(q_0 \circ 1) = q'_2 \acute{\circ} 0 = q'_1, \\ \mu_1(q_1) &= \mu_1(q_2 \circ 0) = q'_1 \acute{\circ} 0 = q'_3.\end{aligned}$$

Hence $q'_3 = \mu_1(q_1) = q'_1$. A contradiction!

(iii b) $\mu_2 : 0 \mapsto 0, 1 \mapsto 1$.

$$\begin{aligned}\mu_1(q_2) &= \mu_1(q_0 \circ 0) = q'_2 \acute{\circ} 0 = q'_1, \\ \mu_1(q_1) &= \mu_1(q_0 \circ 1) = q'_2 \acute{\circ} 1 = q'_4, \\ \mu_1(q_1) &= \mu_1(q_2 \circ 0) = q'_1 \acute{\circ} 0 = q'_3.\end{aligned}$$

Hence $q'_3 = \mu_1(q_1) = q'_4$. A contradiction!

(iii c) $\mu_2 : 0 \mapsto 1, 1 \mapsto 0$.

$$\begin{aligned}\mu_1(q_2) &= \mu_1(q_0 \circ 0) = q'_2 \acute{\circ} 1 = q'_4, \\ \mu_1(q_1) &= \mu_1(q_0 \circ 1) = q'_2 \acute{\circ} 0 = q'_1, \\ \mu_1(q_1) &= \mu_1(q_2 \circ 0) = q'_4 \acute{\circ} 0 = q'_3.\end{aligned}$$

Hence $q'_3 = \mu_1(q_1) = q'_1$. A contradiction!

(iii d) $\mu_2 : 0 \mapsto 1, 1 \mapsto 1$.

$$\begin{aligned}\mu_1(q_2) &= \mu_1(q_0 \circ 0) = q'_2 \acute{\circ} 1 = q'_4, \\ \mu_1(q_1) &= \mu_1(q_0 \circ 1) = q'_2 \acute{\circ} 1 = q'_4, \\ \mu_1(q_1) &= \mu_1(q_2 \circ 0) = q'_4 \acute{\circ} 1 = q'_3.\end{aligned}$$

Hence $q'_3 = \mu_1(q_1) = q'_4$. A contradiction!

(iv) Suppose that $\mu_1(q_0) = q'_3$.

(iv a) $\mu_2 : 0 \mapsto 0, 1 \mapsto 0$.

$$\begin{aligned}\mu_1(q_2) &= \mu_1(q_0 \circ 0) = q'_3 \acute{\circ} 0 = q'_4, \\ \mu_1(q_1) &= \mu_1(q_0 \circ 1) = q'_3 \acute{\circ} 0 = q'_4, \\ \mu_1(q_1) &= \mu_1(q_2 \circ 0) = q'_4 \acute{\circ} 0 = q'_3.\end{aligned}$$

Hence $q'_3 = \mu_1(q_1) = q'_4$. A contradiction!

(iv b) $\mu_2 : 0 \mapsto 0, 1 \mapsto 1$.

$$\begin{aligned}\mu_1(q_2) &= \mu_1(q_0 \circ 0) = q'_3 \acute{\circ} 0 = q'_4, \\ \mu_1(q_1) &= \mu_1(q_0 \circ 1) = q'_3 \acute{\circ} 1 = q'_2, \\ \mu_1(q_1) &= \mu_1(q_2 \circ 0) = q'_4 \acute{\circ} 0 = q'_3.\end{aligned}$$

Hence $q'_3 = \mu_1(q_1) = q'_2$. A contradiction!

(iv c) $\mu_2 : 0 \mapsto 1, 1 \mapsto 0$.

$$\begin{aligned}\mu_1(q_2) &= \mu_1(q_0 \circ 0) = q'_3 \acute{\circ} 1 = q'_2, \\ \mu_3(0) &= \mu_3(q_0 * 1) = q'_3 \acute{*} 0 = 0, \\ \mu_3(0) &= \mu_3(q_2 * 0) = q'_2 \acute{*} 1 = 1.\end{aligned}$$

Hence $1 = \mu_3(0) = 0$. A contradiction!

(ivd) $\mu_2 : 0 \mapsto 1, 1 \mapsto 1$.

$$\begin{aligned}\mu_1(q_2) &= \mu_1(q_0 \circ 0) = q'_3 \acute{\circ} 1 = q'_2, \\ \mu_1(q_1) &= \mu_1(q_0 \circ 1) = q'_3 \acute{\circ} 1 = q'_2, \\ \mu_1(q_1) &= \mu_1(q_2 \circ 0) = q'_2 \acute{\circ} 1 = q'_4.\end{aligned}$$

Hence $q'_4 = \mu_1(q_1) = q'_2$. A contradiction!

(v) Suppose that $\mu_1(q_0) = q'_4$.

(va) $\mu_2 : 0 \mapsto 0, 1 \mapsto 0$.

$$\begin{aligned}\mu_1(q_2) &= \mu_1(q_0 \circ 0) = q'_4 \acute{\circ} 0 = q'_3, \\ \mu_1(q_1) &= \mu_1(q_0 \circ 1) = q'_4 \acute{\circ} 0 = q'_3, \\ \mu_1(q_1) &= \mu_1(q_2 \circ 0) = q'_3 \acute{\circ} 0 = q'_4.\end{aligned}$$

Hence $q'_4 = \mu_1(q_1) = q'_3$. A contradiction!

(vb) $\mu_2 : 0 \mapsto 0, 1 \mapsto 1$.

$$\begin{aligned}\mu_1(q_2) &= \mu_1(q_0 \circ 0) = q'_4 \acute{\circ} 0 = q'_3, \\ \mu_1(q_1) &= \mu_1(q_0 \circ 1) = q'_4 \acute{\circ} 1 = q'_2, \\ \mu_1(q_1) &= \mu_1(q_2 \circ 0) = q'_3 \acute{\circ} 0 = q'_4.\end{aligned}$$

Hence $q'_4 = \mu_1(q_1) = q'_2$. A contradiction!

(vc) $\mu_2 : 0 \mapsto 1, 1 \mapsto 0$.

$$\begin{aligned}\mu_1(q_2) &= \mu_1(q_0 \circ 0) = q'_4 \acute{\circ} 1 = q'_2, \\ \mu_1(q_1) &= \mu_1(q_0 \circ 1) = q'_4 \acute{\circ} 0 = q'_3, \\ \mu_1(q_1) &= \mu_1(q_2 \circ 0) = q'_2 \acute{\circ} 1 = q'_4.\end{aligned}$$

Hence $q'_4 = \mu_1(q_1) = q'_3$. A contradiction!

(vd) $\mu_2 : 0 \mapsto 1, 1 \mapsto 1$.

$$\begin{aligned}\mu_1(q_2) &= \mu_1(q_0 \circ 0) = q'_4 \acute{\circ} 1 = q'_2, \\ \mu_1(q_1) &= \mu_1(q_0 \circ 1) = q'_4 \acute{\circ} 1 = q'_2, \\ \mu_1(q_1) &= \mu_1(q_2 \circ 0) = q'_2 \acute{\circ} 1 = q'_4.\end{aligned}$$

Hence $q'_4 = \mu_1(q_1) = q'_2$. A contradiction!

In all cases we have arrived at contradictions. This proves that there doesn't exist a homomorphism $\mu = (\mu_1, \mu_2, \mu_3) : V_{13} \rightarrow V'_{13}$.

Suppose that $\mu = (\mu_1, \mu_2, \mu_3) : V'_{13} \rightarrow V_{13}$ is a homomorphism.

(i) If $\mu_1(q'_0) = q_0$, then we have cases:

$$\begin{aligned}\mu_2 : \quad & 0 \mapsto 0, \quad 1 \mapsto 0; \\ & 0 \mapsto 0, \quad 1 \mapsto 1; \\ & 0 \mapsto 1, \quad 1 \mapsto 0; \\ & 0 \mapsto 1, \quad 1 \mapsto 1.\end{aligned}$$

(ia) $\mu_2 : 0 \mapsto 0, 1 \mapsto 0$.

$$\mu_1(q'_2) = \mu_1(q'_0 \acute{o} 1) = q_0 \circ 0 = q_2,$$

$$\mu_1(q'_1) = \mu_1(q'_2 \acute{o} 0) = q_2 \circ 0 = q_1,$$

$$\mu_1(q'_1) = \mu_1(q'_0 \acute{o} 0) = q_0 \circ 0 = q_2.$$

Hence $q_2 = \mu_1(q'_1) = q_1$. A contradiction!

(ib) $\mu_2 : 0 \mapsto 0, 1 \mapsto 1$.

$$\mu_1(q'_2) = \mu_1(q'_0 \acute{o} 1) = q_0 \circ 1 = q_1,$$

$$\mu_1(q'_1) = \mu_1(q'_2 \acute{o} 0) = q_1 \circ 0 = q_3,$$

$$\mu_1(q'_1) = \mu_1(q'_0 \acute{o} 0) = q_0 \circ 0 = q_2.$$

Hence $q_2 = \mu_1(q'_1) = q_3$. A contradiction!

(ic) $\mu_2 : 0 \mapsto 1, 1 \mapsto 0$.

$$\mu_1(q'_2) = \mu_1(q'_0 \acute{o} 1) = q_0 \circ 0 = q_2,$$

$$\mu_1(q'_1) = \mu_1(q'_2 \acute{o} 0) = q_2 \circ 1 = q_4,$$

$$\mu_1(q'_1) = \mu_1(q'_0 \acute{o} 0) = q_0 \circ 1 = q_1.$$

Hence $q_1 = \mu_1(q'_1) = q_4$. A contradiction!

(id) $\mu_2 : 0 \mapsto 1, 1 \mapsto 1$.

$$\mu_1(q'_2) = \mu_1(q'_0 \acute{o} 1) = q_0 \circ 1 = q_1,$$

$$\mu_1(q'_1) = \mu_1(q'_2 \acute{o} 0) = q_1 \circ 1 = q_0,$$

$$\mu_1(q'_1) = \mu_1(q'_0 \acute{o} 0) = q_0 \circ 1 = q_1.$$

Hence $q_1 = \mu_1(q'_1) = q_0$. A contradiction!

(ii) Suppose that $\mu_1(q'_0) = q_1$.

(iia) $\mu_2 : 0 \mapsto 0, 1 \mapsto 0$.

$$\mu_1(q'_2) = \mu_1(q'_0 \acute{o} 1) = q_1 \circ 0 = q_3,$$

$$\mu_1(q'_1) = \mu_1(q'_2 \acute{o} 0) = q_3 \circ 0 = q_4,$$

$$\mu_1(q'_1) = \mu_1(q'_0 \acute{o} 0) = q_1 \circ 0 = q_3.$$

Hence $q_3 = \mu_1(q'_1) = q_4$. A contradiction!

(iib) $\mu_2 : 0 \mapsto 0, 1 \mapsto 1$.

$$\mu_1(q'_2) = \mu_1(q'_0 \acute{o} 1) = q_1 \circ 1 = q_0,$$

$$\mu_1(q'_1) = \mu_1(q'_2 \acute{o} 0) = q_0 \circ 0 = q_2,$$

$$\mu_1(q'_1) = \mu_1(q'_0 \acute{o} 0) = q_1 \circ 0 = q_3.$$

Hence $q_3 = \mu_1(q'_1) = q_2$. A contradiction!

(iic) $\mu_2 : 0 \mapsto 1, 1 \mapsto 0$.

$$\mu_1(q'_2) = \mu_1(q'_0 \acute{o} 1) = q_1 \circ 0 = q_3,$$

$$\mu_1(q'_1) = \mu_1(q'_2 \acute{o} 0) = q_3 \circ 1 = q_4,$$

$$\mu_1(q'_1) = \mu_1(q'_0 \acute{o} 0) = q_1 \circ 1 = q_0.$$

Hence $q_0 = \mu_1(q'_1) = q_4$. A contradiction!

(iid) $\mu_2 : 0 \mapsto 1, 1 \mapsto 1$.

$$\begin{aligned}\mu_1(q'_2) &= \mu_1(q'_0 \acute{o} 1) = q_1 \circ 1 = q_0, \\ \mu_1(q'_1) &= \mu_1(q'_2 \acute{o} 0) = q_0 \circ 1 = q_1, \\ \mu_1(q'_1) &= \mu_1(q'_0 \acute{o} 0) = q_1 \circ 1 = q_0.\end{aligned}$$

Hence $q_0 = \mu_1(q'_1) = q_1$. A contradiction!

(iii) Suppose that $\mu_1(q'_0) = q_2$.

(iii a) $\mu_2 : 0 \mapsto 0, 1 \mapsto 0$.

$$\begin{aligned}\mu_1(q'_2) &= \mu_1(q'_0 \acute{o} 1) = q_2 \circ 0 = q_1, \\ \mu_1(q'_1) &= \mu_1(q'_2 \acute{o} 0) = q_1 \circ 0 = q_3, \\ \mu_1(q'_1) &= \mu_1(q'_0 \acute{o} 0) = q_2 \circ 0 = q_1.\end{aligned}$$

Hence $q_1 = \mu_1(q'_1) = q_3$. A contradiction!

(iii b) $\mu_2 : 0 \mapsto 0, 1 \mapsto 1$.

$$\begin{aligned}\mu_1(q'_2) &= \mu_1(q'_0 \acute{o} 1) = q_2 \circ 1 = q_4, \\ \mu_1(q'_1) &= \mu_1(q'_2 \acute{o} 0) = q_4 \circ 0 = q_2, \\ \mu_1(q'_1) &= \mu_1(q'_0 \acute{o} 0) = q_2 \circ 0 = q_1.\end{aligned}$$

Hence $q_1 = \mu_1(q'_1) = q_2$. A contradiction!

(iii c) $\mu_2 : 0 \mapsto 1, 1 \mapsto 0$.

$$\begin{aligned}\mu_1(q'_2) &= \mu_1(q'_0 \acute{o} 1) = q_2 \circ 0 = q_1, \\ \mu_1(q'_1) &= \mu_1(q'_2 \acute{o} 0) = q_1 \circ 1 = q_0, \\ \mu_1(q'_1) &= \mu_1(q'_0 \acute{o} 0) = q_2 \circ 1 = q_4.\end{aligned}$$

Hence $q_4 = \mu_1(q'_1) = q_0$. A contradiction!

(iii d) $\mu_2 : 0 \mapsto 1, 1 \mapsto 1$.

$$\begin{aligned}\mu_1(q'_2) &= \mu_1(q'_0 \acute{o} 1) = q_2 \circ 1 = q_4, \\ \mu_1(q'_1) &= \mu_1(q'_2 \acute{o} 0) = q_4 \circ 1 = q_3, \\ \mu_1(q'_1) &= \mu_1(q'_0 \acute{o} 0) = q_2 \circ 1 = q_4.\end{aligned}$$

(iv) Suppose that $\mu_1(q'_0) = q_3$.

(iv a) $\mu_2 : 0 \mapsto 0, 1 \mapsto 0$.

$$\begin{aligned}\mu_1(q'_2) &= \mu_1(q'_0 \acute{o} 1) = q_3 \circ 0 = q_4, \\ \mu_1(q'_1) &= \mu_1(q'_2 \acute{o} 0) = q_4 \circ 0 = q_2, \\ \mu_1(q'_1) &= \mu_1(q'_0 \acute{o} 0) = q_3 \circ 0 = q_4.\end{aligned}$$

Hence $q_4 = \mu_1(q'_1) = q_2$. A contradiction!

(ivb) $\mu_2 : 0 \mapsto 0, 1 \mapsto 1$.

$$\mu_1(q'_2) = \mu_1(q'_0 \acute{o} 1) = q_3 \circ 1 = q_2,$$

$$\mu_1(q'_1) = \mu_1(q'_2 \acute{o} 0) = q_2 \circ 0 = q_1,$$

$$\mu_1(q'_1) = \mu_1(q'_0 \acute{o} 0) = q_3 \circ 0 = q_4.$$

Hence $q_4 = \mu_1(q'_1) = q_3$. A contradiction!

(ivc) $\mu_2 : 0 \mapsto 1, 1 \mapsto 0$.

$$\mu_1(q'_2) = \mu_1(q'_0 \acute{o} 1) = q_3 \circ 0 = q_4,$$

$$\mu_1(q'_1) = \mu_1(q'_2 \acute{o} 0) = q_4 \circ 1 = q_3,$$

$$\mu_1(q'_1) = \mu_1(q'_0 \acute{o} 0) = q_3 \circ 1 = q_2.$$

Hence $q_2 = \mu_1(q'_1) = q_3$. A contradiction!

(ivd) $\mu_2 : 0 \mapsto 1, 1 \mapsto 1$.

$$\mu_1(q'_2) = \mu_1(q'_0 \acute{o} 1) = q_3 \circ 1 = q_2,$$

$$\mu_1(q'_1) = \mu_1(q'_2 \acute{o} 0) = q_2 \circ 1 = q_4,$$

$$\mu_1(q'_1) = \mu_1(q'_0 \acute{o} 0) = q_3 \circ 1 = q_2.$$

Hence $q_2 = \mu_1(q'_1) = q_4$. A contradiction!

(v) Suppose that $\mu_1(q'_0) = q_4$.

(va) $\mu_2 : 0 \mapsto 0, 1 \mapsto 0$.

$$\mu_1(q'_2) = \mu_1(q'_0 \acute{o} 1) = q_4 \circ 0 = q_2,$$

$$\mu_1(q'_1) = \mu_1(q'_2 \acute{o} 0) = q_2 \circ 0 = q_1,$$

$$\mu_1(q'_1) = \mu_1(q'_0 \acute{o} 0) = q_4 \circ 0 = q_2.$$

Hence $q_2 = \mu_1(q'_1) = q_1$. A contradiction!

(v b) $\mu_2 : 0 \mapsto 0, 1 \mapsto 1$.

$$\mu_1(q'_2) = \mu_1(q'_0 \acute{o} 1) = q_4 \circ 1 = q_3,$$

$$\mu_1(q'_1) = \mu_1(q'_2 \acute{o} 0) = q_3 \circ 0 = q_4,$$

$$\mu_1(q'_1) = \mu_1(q'_0 \acute{o} 0) = q_4 \circ 0 = q_2.$$

Therefore $q_2 = \mu_1(q'_1) = q_4$. A contradiction!

(v c) $\mu_2 : 0 \mapsto 1, 1 \mapsto 0$.

$$\mu_1(q'_2) = \mu_1(q'_0 \acute{o} 1) = q_4 \circ 0 = q_2,$$

$$\mu_1(q'_1) = \mu_1(q'_2 \acute{o} 0) = q_2 \circ 1 = q_0,$$

$$\mu_1(q'_1) = \mu_1(q'_0 \acute{o} 0) = q_4 \circ 1 = q_3.$$

Therefore $q_3 = \mu_1(q'_1) = q_0$. A contradiction!

(v d) $\mu_2 : 0 \mapsto 1, 1 \mapsto 1$.

$$\mu_1(q'_2) = \mu_1(q'_0 \acute{o} 1) = q_4 \circ 1 = q_3,$$

$$\mu_1(q'_1) = \mu_1(q'_2 \acute{o} 0) = q_3 \circ 1 = q_2,$$

$$\mu_1(q'_1) = \mu_1(q'_0 \acute{o} 0) = q_4 \circ 1 = q_3.$$

Therefore $q_3 = \mu_1(q'_1) = q_2$. A contradiction!

In all cases we have arrived at contradictions. This proves that there doesn't exist a homomorphism $\mu = (\mu_1, \mu_2, \mu_3) : V'_{13} \rightarrow V_{13}$.

8.18. Definition. We say that machine $'V$ simulates machine V if there exist mappings

$$Q \xrightarrow{h_1} 'Q, \quad A \xrightarrow{h_2} 'A, \quad 'B \xrightarrow{h_3} B$$

such that the diagram

$$\begin{array}{ccccc} Q & \times & A^* & \xrightarrow{*} & B^* \\ h_1 \downarrow & & \downarrow h_2 & & \uparrow h_3 \\ 'Q & \times & 'A^* & \xrightarrow{*} & 'B^* \end{array}$$

commutes. That is if $\forall (q, u) \in Q \times A^* \quad q * u = h_3(h_1(q) * h_2(u))$.

As it turns out (consider next example), we can choose such invertible machines

$$V_{12} = \langle Q, A, A; q_0, \circ, * \rangle, \quad V'_{12} = \langle Q', A', A'; q_0, \acute{\circ}, \acute{*} \rangle,$$

that $q \acute{*} u$ is the inverse mapping of $q * u$, but machine V'_{12} doesn't simulate machine V_{12} , and V_{12} doesn't simulate V'_{12} .

8.19. Example.

Suppose that machine V'_{12} simulates machine V_{12} (10. fig.), i.e., exists mappings h_1, h_2, h_3 , that

$$q * u = h_3(h_2(q) \acute{*} h_2(u))$$

for $\forall u \in \overline{0, 1}^*$ and for all states q of machine V_{12} . Therefore

$$\begin{aligned} 0 &= q_0 * 1 = h_3(h_1(q_0) \acute{*} h_2(1)), \\ 1 &= q_0 * 0 = h_3(h_1(q_0) \acute{*} h_2(0)). \end{aligned}$$

This shows that mappings h_2 and h_3 are bijections. Therefore exists inverse mapping (a bijection) h of mapping h_3 . Hence

$$h(q * u) = h(h_3(h_1(q) \acute{*} h_2(u))) = h_1(q) \acute{*} h_2(u).$$

We also have that

$$\begin{aligned} h(1) = h(q_0 * 0) &= h_1(q_0) \acute{*} h_2(0), \\ h(0) = h(q_1 * 0) &= h_1(q_1) \acute{*} h_2(0). \end{aligned}$$

As h is bijection, then we have that h_1 also is bijection. Hence all mappings h, h_1, h_2 are bijections.

(i) Suppose that $h_1 : q_0 \mapsto q_0, q_1 \mapsto q_1$, then

$$h(10) = h(q_0 * 00) = h_1(q_0) * h_2(00) = q_0 * h_2(00).$$

As h is bijection, then $h_2(0) = 1$. Mapping h_2 also is a bijection, therefore $h_2(1) = 0$. Hence

$$h(10) = h(q_1 * 11) = h_1(q_1) * h_2(11) = q_1 * 00 = 00.$$

Contradiction because h is a bijection.

(ii) Suppose that $h_1 : q_0 \mapsto q_1, q_1 \mapsto q_0$, then

$$h(10) = h(q_0 * 00) = h_1(q_0) * h_2(00) = q_1 * h_2(00).$$

As h is a bijection, then $h_2(0) = 1$. Mapping h_2 also is a bijection, therefore $h_2(1) = 0$. Hence

$$h(10) = h(q_1 * 11) = h_2(q_1) * h_2(11) = q_0 * 00 = 11.$$

This is a contradiction because h is a bijection.

We have obtained contradictions in both cases, consequentially machine V'_{12} is not capable of simulating machine V_{12} .

Suppose that machine V_{12} is simulating machine V'_{12} (look at 10. fig.), i.e., there exist mappings h_1, h_2, h_3 such that

$$q * u = h_3(h_2(q) * h_2(u))$$

for all $u \in \overline{0,1}^*$ and for all states q of machine V'_{12} . Therefore

$$\begin{aligned} 0 &= q_0 * 1 = h_3(h_1(q_0)) * h_2(1), \\ 1 &= q_0 * 0 = h_3(h_1(q_0) * h_2(0)). \end{aligned}$$

This shows that h_2 and h_3 are bijections. Hence there exist a inverse mapping h of mapping h_3 , which also is a bijection. Hence

$$h(q * u) = h(h_3(h_1(q) * h_2(u))) = h_1(q) * h_2(u).$$

We also have that

$$\begin{aligned} h(1) = h(q_0 * 0) &= h_1(q_0) * h_2(0), \\ h(0) = h(q_1 * 0) &= h_1(q_1) * h_2(0). \end{aligned}$$

Therefore h is a bijection, consequentially we have, that h_1 is a bijection. Hence all mappings h, h_1, h_2 are bijections.

(i) Suppose that $h_1 : q_0 \mapsto q_0, q_1 \mapsto q_1$, then

$$h(01) = h(q_0 * 11) = h_1(q_0) * h_2(11) = q_0 * h_2(11).$$

As h is a bijection, then $h_2(1) = 0$. Hence

$$h(10) = h(q_1 * 11) = h_1(q_1) * h_2(11) = q_1 * 00 = 00.$$

This is a contradiction because h is a bijection.

(ii) Suppose that $h_1 : q_0 \mapsto q_1, q_1 \mapsto q_0$, then

$$h(10) = h(q_1 * 11) = h_1(q_1) * h_2(11) = q_0 * h_2(11).$$

As h is a bijection, then $h_2(1) = 0$. The mapping h_2 also is a bijection, therefore $h_2(1) = 0$. Hence

$$h(01) = h(q_0 * 11) = h_2(q_0) * h_2(11) = q_1 * 00 = 00.$$

This is a contradiction because h is a bijection.

Thus we have obtained contradictions in both cases, consequentially the machine V_{12} is not capable of simulating V'_{12} .

References

- [1] Кудрявцев В. Б., Алешин С. В., Подколзин А. С. (1985) *Введение в теорию автоматов*. [An Introduction to the Theory of Automata.] Москва «Наука». (Russian)
- [2] Ruohonen K. (2008) *Graph Theory*. <https://archive.org/details/flooved3467> (accessed 26. december, 2017)
- [3] Bollobas B. (1998) *Modern Graph Theory*. Springer-Verlag.
- [4] Cohn P.M. (1981) *Universal Algebra*. Springer-Verlag.
- [5] Lang S. (2005) *Undergraduate Algebra*. Springer-Verlag.
- [6] Pin J.E. (2016) *Mathematical Foundations of Automata Theory*. <https://www.irif.fr/~jep/PDF/MPRI/MPRI.pdf> (accessed 14. january, 2018)