

System Design in the Era of IoT — Meeting the Autonomy Challenge

(Invited paper)

Joseph Sifakis

University Grenoble Alpes and CNRS / Verimag
Grenoble, France

Joseph.Sifakis@univ-grenoble-alpes.fr

The advent of IoT is a great opportunity to reinvigorate Computing by focusing on autonomous system design. This certainly raises technology questions but, more importantly, it requires building new foundation that will systematically integrate the innovative results needed to face increasing environment and mission complexity.

A key idea is to compensate the lack of human intervention by adaptive control. This is instrumental for system resilience: it allows both coping with uncertainty and managing mixed criticality services. Our proposal for knowledge-based design seeks a compromise: preserving rigorousness despite the fact that essential properties cannot be guaranteed at design time. It makes knowledge generation and application a primary concern and aims to fully and seamlessly incorporate the adaptive control paradigm in system architecture.

1 Introduction

1.1 The IoT vision

The IoT vision promises increasingly interconnected smart systems providing autonomous services for the optimal management of resources and enhanced quality of life. These are used in smart grids, smart transport systems, smart health care services, automated banking services, smart factories, etc. Their coordination should be achieved using a unified network infrastructure, in particular to collect data and send them to the cloud which in return should provide intelligent services and ensure global monitoring and control.

The IoT vision raises a lot of expectations and in our opinion, some over-optimism about its short-term outcome and impact. According to analysts, the IoT consists of two segments of uneven difficulty. One segment is the Human IoT which will be a significant improvement of Internet where the dominant type of interaction will be client-server: increasingly intelligent services to satisfy semantically rich requests.

The other segment is the so-called Industrial IoT which would coordinate autonomous services and systems. The big difference with Human IoT is that the latter involves fast closed loops of cooperating agents where human intervention is external to normal behavior. For instance, human operators might intervene to change parameters of autonomous agents or to mitigate potentially dangerous situations. It goes without saying that autonomous agents in the Industrial IoT will be critical as they will be the core of complex systems such as, Intelligent Transport Systems, Smart Grids and other critical infrastructure, e-health and financial services.

It is well understood that under the current state of the art the Industrial IoT vision cannot be reached for several reasons. The first and main reason is *poor trustworthiness* of infrastructures and systems

deployed over the Internet. It is practically impossible to guarantee safety and security of services and systems for the simple reason that they have been built in an ad hoc manner. Safety and security are cross cutting issues. They differ from performance in that they cannot be improved through controlled experiments and tuning of system parameters. A second obstacle is the impossibility to guarantee reasonably short response times in communications. Most protocols in large scale systems are not time-predictable. Thus they cannot support reliable closed-loop interaction of autonomous agents. Finally, the reliability of rigorously designed critical systems may be impacted by flaws of large systems to which they are connected.

It is important to note that over the past decades almost no progress has been made to resolve these problems. The Industrial Internet Consortium¹ has been established since March 2014 “*in order to accelerate market adoption and drive down the barriers to entry*”. Despite the fact that it gathers together hundreds of important industrial partners, to the best of our knowledge it has not delivered any results that could even slightly move the mentioned roadblocks.

It is also important to note that these obstacles and limitations do not discourage key industrial players from developing ambitious projects challenging the current state of the art. This is particularly visible in automotive industry where the business stakes and technological risks are huge. In this race for increasingly autonomous cars, the temptation is big to “jump ahead” and disrupt to a large extent the standard rigorous systems engineering practice. A typical example is customization by software updates on a monthly basis for Tesla cars. Such a practice breaches the rules of critical systems standards which do not allow any modification of a product after commercialization. These standards require that the trustworthiness of a product be fully established at design time. Typically, an aircraft is certified as a product that cannot be modified including all its HW components — aircraft makers purchase and store an advance supply of the microprocessors that will run the software, sufficient to last for the estimated 50 year production!

There is currently a striking contrast between the ambition for increasingly large autonomous systems in the framework of IoT and the lack of adequate rigorous design methods and supported by tools. This makes impossible the application of the current safety standards which as a rule require *conclusive evidence* that the built system can cope with any type of critical mishap.

1.2 What happened to the promise of rigorous, disciplined systems engineering?

The fulfilment of the vision for increasingly autonomous integrated systems is not only a matter of maturity of the state of the art. It also depends on the degree of risks that society accepts to take in exchange of considerable anticipated benefits. The old ambition that computing systems engineering should be as predictable as civil or electrical engineering has drastically evolved within the Computing community and the broader public.

We believe that this observed shift of opinion is largely due to the lack of relevant theory enabling rigorous and disciplined design. Theory has had a decreasing impact on software and systems engineering over the past decades. Formal methods failed to deliver results that would raise computing systems engineering to the status of mature engineering disciplines. It turned out that such an ambition is totally wrong and misleading. Physical systems engineering relies on theory allowing predictability and constructivity; and there are good reasons to believe that no such a “nice theory” could exist for computing systems.

A very common attitude of researchers is to work on mathematically clean theoretical frameworks

¹<https://www.iiconsortium.org/>

no matter how relevant they can be. Mathematical clarity and beauty attracts the most brilliant who develop “low-level theory” that often has no point of contact with real practice. The results are usually structure-agnostic and cannot be applied to real-languages, architectures and complex systems built from components and protocols.

Contrary to theoretical, practically-oriented research has developed frameworks for programming, modeling and building complex systems in an ad hoc manner — involving a large number of constructs and primitives, with little concern about rigorousness and semantics (minimality, expressiveness). These frameworks are badly amenable to formalization.

The gap between theory and practice in systems engineering and the huge push for system integration fueled by market needs and by aspiration for innovation, have resulted in a dramatic change of the opinion of IT professionals and by extension of the public opinion. This is characterized by the following three synergizing positions.

One expresses a kind of “resigned realism” by adopting the idea that we have to move forward and accept the risks because the benefits resulting from the increasing automation of services and systems would be much larger. In an article by Vinton Cerf with the eloquent title “Take two aspirin and call me in the morning” [7] one can read: *“So where does this leave us? I am fascinated by the metaphor of cyber security as a public health problem. Our machines are infected and they are sometimes also contagious. Our reactions in the public health world involve inoculation and quarantine and we tolerate this because we recognize our health is at risk if other members of society fail to protect themselves from infection.”* Clearly this “cyber-hygiene” metaphor suggests that the current situation is a fatality we cannot escape. It gets us very far from the vision of the engineer who designs buildings that will not collapse with a very high probability for centuries. More recently, Warren Buffet talking about cyber insurance, has warned that [18] *“there’s about a 2% risk of a \$400 billion disaster occurring as a result of a cyber-attack or of other issue”*. Buffett also explains that when he speaks to cybersecurity experts, they tell him that *“the offense is always ahead of the defense, and that will continue to be the case.”* And he adds that *“After all, the world runs on software, and software is written by humans who are just as flawed as you and me.”* No doubt, such statements open the way for accepting the imponderable risks induced by the ubiquitous and extensive use of poorly engineered systems and applications of unmanaged complexity.

A second position consists in showing a non-justified over-optimism claiming that things will improve just by magic without drastically changing the way we design systems and the network infrastructure. The quote below is from a technology analyst at Davos WEF 2016: ***“There is no such thing as a secure system, [...] As we give access to devices around us, from drones to thermostats, we need to make sure they cannot be easily hijacked. There will be a learning curve before we make them robust, but we’ll learn.”*** Similar opinions can be found in many articles discussing the future of IoT in both the technical and broad public press.

Furthermore, fallacious arguments about AI come to the aid of over-optimists: *“I really consider autonomous driving a solved problem. [...] I think we are probably less than two years away.”* — Elon Musk, June 2, 2016. Although AI will be key for achieving autonomy, it does not help with making system design as flawless as possible.

A third increasingly widespread opinion openly questions the interest of theoretical foundations for software and system design. Large-scale systems developers (e.g. web-based systems) privilege purely empirical approaches.

In an article published in CACM and entitled “A new software engineering” one can read amongst others [19]: *“One might suggest computer science provides the underlying theory for software engineering — and this was, perhaps, the original expectation when software engineering was first conceived. In reality, however, computer science has remained a largely academic discipline, focused on the science of*

computing in general but mostly separated from the creation of software-engineering methods in industry. While “formal methods” from computer science provide the promise of doing some useful theoretical analysis of software, practitioners have largely shunned such methods (except in a few specialized areas such as methods for precise numerical computation).” Such positions, especially when published in a flagship ACM journal, are likely to have a deep and irreversible impact. They strikingly contrast with the Formal Methods vision advocated forty years ago by pioneers of Computing.

1.3 The Way Forward

The purpose of this paper is to discuss to what extent the IoT vision is reachable under the current state of the art. Starting from the premise that current critical system practice and standards are not applicable to autonomous systems in the context of IoT, we identify the new factors of difficulty/complexity and propose novel avenues for overcoming them.

It is well-understood that systems engineering comes to a turning point moving: 1) from small size centralized non evolvable systems, to large distributed evolvable systems; 2) from strictly controlled system interaction with its external environment, to non-predictable dynamically changing environments; 3) from correctness at design time to correctness ensured through adaptation.

It is urgent that research in Computing refocuses on the so many open problems raised by modern system design, breaking with the “positivist” spirit of Formal Methods and working on real problems maybe at the detriment of “theoretical purity”. This is the only way to refute statements such as “*system design is a definitely a-scientific activity driven by predominant subjective factors that preclude rational treatment*”. Similar positions are promoted by influential “guilds” of gurus, craftsmen and experts within big SW companies as well as by the whole ecosystem of technology consulting companies. The development of a booming market in cybersecurity, and vested interests of consulting companies are hindering public awareness for more trustworthy systems and infrastructure.

We need to reassess existing methods in the light of the needs as they have changed over the past decades. Clearly, verification and formal methods should be applied to small systems whenever it is realistic (cost-effective and tractable). We should investigate alternative methods for achieving correctness not suffering complexity limitations, e.g. by construction.

We should admit that in the context of IoT, even critical systems cannot be guaranteed exempt of flaws at design time. Without giving up the requirement for rigorousness, we should seek tradeoffs for deciding if a system is trustworthy enough for the intended use.

The focus should be on autonomous system design, addressing related specific needs. It is essential to study the concept of autonomy and identify the key theoretical and technical results for taking up the autonomy challenge.

Autonomy is understood as the capacity of an agent (service or system) to achieve a set of coordinated goals by its own means (without human intervention) by adapting to environment variations. It covers three different aspects: 1) autonomy of decisions i.e. choosing among possible goals; 2) autonomy of operations planned to achieve the goals; 3) autonomy of adaptation e.g. by learning.

The degree of autonomy of a system can be captured as the product of three independent factors: 1) Complexity of the environment; 2) complexity of mission and its implementation as a sequence of feasible tasks; 3) non-intervention of human operators.

The interplay between these three factors is illustrated by the six SAE autonomy levels shown in Table 1 varying from Level 0, for no automation, to Level 5, for full automation. Level 4 brings restrictions to the environment as self-driving is supported only in limited areas or under special circumstances, like traffic jams. Level 3 is a critical level as the human driver must be prepared to respond to a “request

Table 1: SAE vehicle autonomy levels [23, 30]

Level 0	No automation
Level 1	Driver assistance required (“hands on”): The driver still needs to maintain full situational awareness and control of the vehicle, e.g. cruise control.
Level 2	Partial automation options available (“hands off”): Autopilot manages both speed and steering under certain conditions, e.g. highway driving.
Level 3	Conditional Automation (“eyes off”): The car, rather than the driver, takes over actively monitoring the environment when the system is engaged. However, human drivers must be prepared to respond to a “request to intervene”.
Level 4	High automation (“mind off”): Self driving is supported only in limited areas (geofenced) or under special circumstances, like traffic jams.
Level 5	Full automation (“steering wheel optional”): No human intervention is required, e.g. a robotic taxi.

to intervene”. This type of interaction with a passive driver suddenly solicited to take over, raises some issues as attested by the recent accident of an Uber car [14].

In this paper, we propose research directions for each one of the three factors characterizing the degree of system autonomy:

- To cope with environment complexity we should seek a tighter integration of computing elements and their environment, in particular through the use of *cyber-physical components*.
- To cope with mission complexity we need dynamic reconfiguration of resources and self-organization in particular through the use of adequate *architectures*;
- To compensate the lack of direct human intervention, we advocate extensive use of *adaptive control techniques*.

The paper is structured as follows. Section 2 summarizes well-known facts about system design. It discusses current limitations of critical system design as it is enforced by standards, and its failure to satisfy current needs. Section 3 presents research avenues for coping with the complexity stemming from the need for increasingly high autonomy. Section 4 advocates Knowledge-Based Design as an alternative to existing critical system design techniques. Section 5 concludes with a discussion about scientific, technological and societal stakes of the autonomy challenge.

2 System Design

2.1 About system correctness

System correctness is characterized as the conjunction of two types of properties: trustworthiness and optimization properties [27]. Trustworthiness means that the system can be trusted, and that it will behave as expected despite: 1) software design and implementation errors; 2) failures of the execution infrastructure; 3) interaction with potential users including erroneous actions and threats; and 4) interaction with the physical environment including disturbances and unpredictable events. Optimization requirements demand the optimization of functions subject to constraints on resources such as time, memory, and energy, dealing with performance and cost-effectiveness.

System designers should ensure trustworthiness without disregarding optimization as the two types of requirements are often antagonistic. For small size critical systems, emphasis is put on trustworthiness, while for large systems the emphasis is on optimization, provided that system availability remains above some threshold. Thus comes the well-known concept of levels of criticality going from critical systems to best-effort systems. This distinction reflects a big difference in development methods and costs. Critical systems development is subject to standards defining evaluation criteria enforced by certification authorities. According to standards currently in effect, the reliability of an aircraft should be of the order of 10^{-9} failures per hour. Note that the reliability of best-effort systems may be as low as 10^{-4} failures per hour while the reliability of a rocket is around 10^{-6} failures per hour. Existing empirical laws regarding the evolution of development costs of high confidence systems show that multiplying the reliability of a system by some factor may require exponentially higher development costs. Furthermore, the increase of the size of a system for the same reliability level has a similar effect.

These facts explain the current gap between critical and best effort system design discussed later.

To summarize, critical system design, as enforced by standards and methodologies, costs a lot and is applicable only to small size systems (e.g. some hundreds of thousands of lines of code).

2.2 Rigorous system design — The principles

System design is the engineering process that leads from requirements to a mixed HW/SW system meeting the requirements. The process follows a flow organized in steps, some of which are iterative. At each step, the designer enriches a model of the designed system assisted by tools allowing him to check that the properties derived from the requirements are met.

As achieving formal correctness seems practically impossible for real-life systems, we have proposed rigorousness as a minimal requirement for guaranteeing trustworthiness in system design [4, 27]. Rigorous system design is model-based and accountable.

Model-Based Even if different languages are used by designers, all these languages should be embedded in a common *host model* in order to guarantee the overall coherency of the flow [26] (Figure 1). In practice, there is no need of a distinct semantic model. The host model can be software written in a general purpose programming language adequately structured and annotated.

A key idea is that the application software model is “composed” with an abstract execution platform model to get a *nominal system model* that describes the behavior of the software running on the platform. The composition operation is specified through a deployment consisting of 1) a mapping assigning processes to processing elements and data to memories of the platform; 2) an associated scheduling algorithm.

The nominal system model is progressively enriched by application of property-preserving model-to-model transformations to obtain a *general system model*. The transformations are local and do not suffer any complexity limitations. They should be proven correct in the sense that they should preserve essential properties such as invariants and deadlock-freedom. They consist in adding, first, timing information provided by an execution time estimation tool. Then, other transformations add mechanisms for resilience to failures, attacks or any kind of critical hazards. The so enriched model sufficiently validated is used to generate implementations.

Accountable Accountability concerns two aspects: 1) evidence that the designer’s choices are justified by the need to meet properties implied by requirements; 2) guarantees that properties already established at some design step, will still hold in subsequent steps. In practice, accountability can be eased

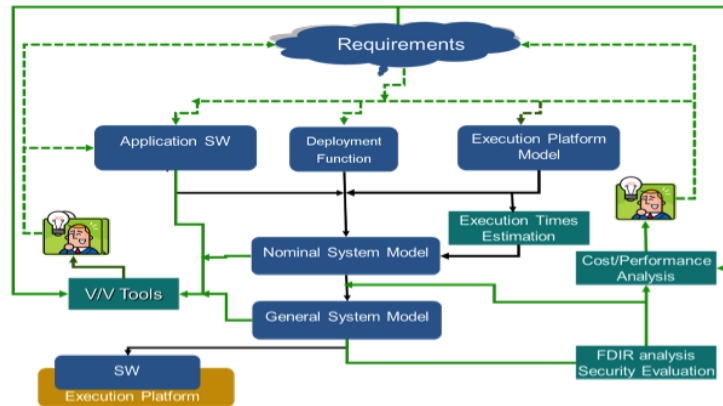

Figure 1: The principle of a rigorous system design flow

through the use of assurance case methodologies. These allow structuring the designer’s reasoning to gain confidence that systems would work as expected [1].

Note that there exist only a few rigorous system design approaches dedicated to the development of safety-critical real-time systems. Some approaches are based on the synchronous programming paradigm [17]. Others are represented mainly by flows based on the ADA standard [29]. In both, rigorousness is achieved at the price of severe restrictions regarding the programming and the execution model [27].

We explain below why current rigorous system design methodologies cannot meet the demand for increasing autonomy in the framework of IoT.

2.3 The two pillars of rigorous system design

2.3.1 Verification

Verification is a process used to provide conclusive evidence that a system is correct with respect to a given property. This can be achieved by checking in some exhaustive and rigorous manner that a system model or the system development process model meets the property. Verification differs from testing in that it seeks exhaustivity. It requires special care in the elaboration of the model and the formalization of the properties to be verified. The properties should be derived from requirements usually expressed in natural language. The models should be faithful: whatever property holds for the real system should also hold for the model.

Verification and model checking in particular, constitutes one of the main breakthroughs for quality assurance in both hardware and software development. It has drastically contributed to gaining mathematical confidence in system correctness [8]. Nonetheless, a key limitation of automated verification methods is that they are applied to *global* models. Despite intensive research efforts, it was not possible to develop automated compositional verification methods (inferring global system properties from properties of the constituent components at reasonable computational cost). This is a serious limitation of automated verification techniques.

Another limitation concerns the possibility of building faithful general system models as defined in Section 2.2. These models should account for the system behavior in the presence of critical events that may compromise correctness (Figure 2). Modeling the impact of such events requires a very good knowledge of both the system and its environment, in particular of the dynamics of their interaction. As system complexity and openness increase, the number of potentially critical events explodes. Note that

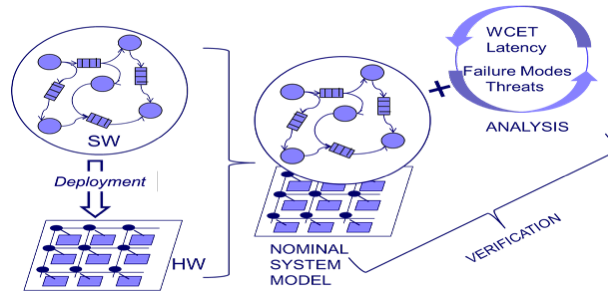

Figure 2: Building the general system model

the degree of difficulty is much higher for security analysis. While some methodologies exist for fault detection, isolation and recovery (FDIR) analysis [32] there is no systematic approach to global security analysis as it is hard to figure out how human ingenuity can exploit system vulnerability. The recently discovered Intel’s security flaw is a remarkable illustration of this fact [24].

The second roadblock to system verification is system openness requiring the formalization of the interaction dynamics between the system and some abstraction of its environment. It is very hard to formalize requirements involving human behavior, computers and electromechanical devices.

Table 2 provides a list of high-level requirements (behavioral competencies) for self-driving cars proposed by the California PATH project [23]. Their decomposition into formalized properties to be checked on autonomous driving systems seems to be an unsurmountable problem. To formally verify each one of these requirements, it is necessary to decompose it into a set of properties involving physical quantities, discrete system events as well as relevant information about the geometry of the external environment, e.g. coming from analysis of sensory information.

All the above limitations are even worsened by the fact that modern machine learning techniques, essential components of autonomous systems, cannot be verified. The simple and obvious reason is that they are not developed based on requirements, e.g. that specify how a dog looks different from a cat. They learn just like children learn the differences between cats and dogs. So, establishing their safety according to existing standards is problematic.

Finally, we should not neglect some non-technical obstacles that have to do with the social acceptance of the truthfulness of verification processes: it is not sufficient to prove that a system is correct by some possibly sophisticated method. It is even much more important to convince institutions, e.g. certification authorities [11]. This requires special care in the development of verification technology with the possibility to check that also the whole verification process is exempt of error.

2.3.2 The V-model

Systems engineering standards often recommend the so-called “V model”, which consists in decomposing system development into two flows. The first is top-down, starts from requirements and involves a hierarchical decomposition of the system into components and a coordinating architecture. The other flow is bottom-up and consists in progressively assembling, integrating, and testing the designed components. This model has been criticized for several reasons [26]:

1. It assumes that all the system requirements are initially known, can be clearly formulated and understood. Anyone with minimal experience in system design realizes that such an assumption is not realistic. It is very often necessary to revise initial requirements.

Table 2: Behavioral competencies for self-driving cars proposed by the California Path Project

1.	Detect and Respond to Speed Limit Changes and Speed Advisories
2.	Perform High-Speed Merge (e.g. Freeway)
3.	Perform Low-Speed Merge
4.	Move Out of the Travel Lane and Park (e.g. to the Shoulder for Minimal Risk)
5.	Detect and Respond to Encroaching Oncoming Vehicles
6.	Detect Passing and No Passing Zones and Perform Passing Maneuvers
7.	Perform Car Following (Including Stop and Go)
8.	Detect and Respond to Stopped Vehicles
9.	Detect and Respond to Lane Changes
10.	Detect and Respond to Static Obstacles in the Path of the Vehicle
11.	Detect Traffic Signals and Stop/Yield Signs
12.	Respond to Traffic Signals and Stop/Yield Signs
13.	Navigate Intersections and Perform Turns
14.	Navigate Roundabouts
15.	Navigate a Parking Lot and Locate Spaces
16.	Detect and Respond to Access Restrictions (One-Way, No Turn, Ramps, etc.)
17.	Detect and Respond to Work Zones and People Directing Traffic in Unplanned or Planned Events
18.	Make Appropriate Right-of-Way Decisions
19.	Follow Local and State Driving Laws
20.	Follow Police/First Responder Controlling Traffic (Overriding or Acting as Traffic Control Device)
21.	Follow Construction Zone Workers Controlling Traffic Patterns (Slow/Stop Sign Holders).
22.	Respond to Citizens Directing Traffic After a Crash
23.	Detect and Respond to Temporary Traffic Control Devices
24.	Detect and Respond to Emergency Vehicles
25.	Yield for Law Enforcement, EMT, Fire, and Other Emergency Vehicles at Intersections, Junctions, and Other Traffic Controlled Situations
26.	Yield to Pedestrians and Bicyclists at Intersections and Crosswalks
27.	Provide Safe Distance From Vehicles, Pedestrians, Bicyclists on Side of the Road
28.	Detect/Respond to Detours and/or Other Temporary Changes in Traffic Patterns

2. It assumes that system development is top-down driven by refining the requirements and projecting them on components. This assumption does not seem realistic too. First, modern systems are never designed from scratch; they are often built by incrementally modifying existing systems and by extensive component reuse. Second, it considers that global system requirements can be broken down into properties satisfied by system components, which is a non-trivial problem.
3. It relies mainly on correctness-by-checking (verification or testing) which takes place bottom-up only after the implementation is completed.



Figure 3: Autonomous system design complexity

For all these reasons the V-model has been abandoned in modern software engineering in favor of the so-called Agile methodologies. These consider that coding and designing should go hand in hand: designs should be modified to reflect adjustments made to the requirements. So, design ideas are shared and improved on during a project “in a spiral manner”.

In our opinion, the main merit of Agile methodologies is their criticism of the V-model rather than a disciplined and well-structured way for tackling system development.

3 Trends and Challenges in Autonomous System Design

We have seen that system autonomy can be characterized as the interplay between three complexity factors: environment, mission and non-intervention of humans. These factors do not impact autonomous system design in the same manner. While hardness increases for increasing environment and mission complexity, increasing the degree of automation may sometimes ease the design problem.

We discuss these three trends and show work directions and associated challenges.

3.1 System Design Complexity

We first analyze the role of the two factors directly impacting design complexity. Increasing autonomy requires tighter integration of computers and their physical environment as well as self-organization of system resources. Figure 3 illustrates this observation. As we move away from the origin, autonomy increases from purely functional components to cyber physical components and from static to self-organizing architectures. The dashed line separating functional and streaming components from embedded and cyber physical components, marks the border between the Human and the Industrial IoT. Increasing architecture complexity reflects increasing autonomy for services and systems respectively.

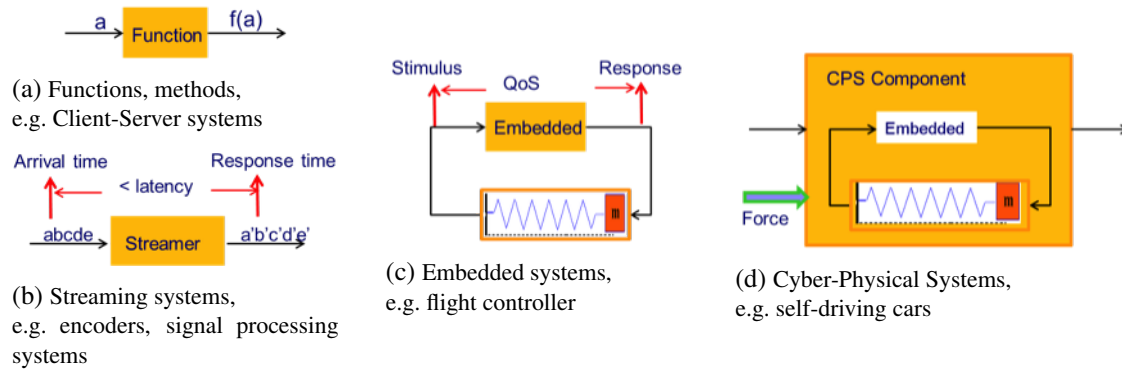

Figure 4: Classification of system components

3.1.1 Component Complexity — Cyber Physical Systems

Figure 4 illustrates different types of components for increasing intricacy of interaction with their environment. The simplest components are functional. They compute some function f by delivering, for any input datum x a corresponding output $f(x)$. Streamers compute functions on streams. For a given input stream of values, they compute a corresponding output stream. The output value at some time t depends on the history of the input value received by t . Encoders/decoders or in general data-flow systems involve streamers. The requirements for such components are functional correctness and specific time-dependent properties such as latency.

Embedded components continuously interact with a physical environment so as to ensure global properties. Such components are mixed HW/SW components, where the real-time behavior and dynamic properties are essential for correctness. Finally, cyber-physical components integrate embedded and physical components. They combine discrete and continuous dynamics. Cyber and physical aspects are deeply intertwined and their composition requires multi-scale and multi-domain integration of theories.

The study of cyber-physical systems has been the object of a rich literature over the past decade. Nonetheless, key problems raised by their rigorous design remain open. These have to do with the faithful modeling of complex electromechanical systems with discrete events, as well as the discretization of hybrid models in view of their implementation. We currently lack theory and supporting tools for component-based modeling, as the concepts of composition of physical and cyber models are radically different. Physical systems models are inherently declarative, synchronous, parallel and the interaction between components is data-flow; on the contrary, computation is inherently procedural, sequential and interaction is natively event-driven.

Discretization of hybrid models raises semantic problems about how to detect and precisely simulate converging system dynamics. We also lack theory for safe and efficient discretization as well as for deciding whether a hybrid model is executable. The interested reader can find a detailed discussion of these issues in [5].

3.1.2 Architecture complexity — Self-organizing architectures

Architectures depict principles of coordination, paradigms that can be understood by all, allow thinking on a higher plane and avoiding low-level mistakes. They are a means for ensuring correctness by construction, as they enforce specific global properties characterizing the coordination between the composed components. System developers extensively use libraries of reference architectures such as time-

triggered architectures, security architectures and fault-tolerant architectures.

Architectures can be considered as generic operators that can take as arguments arbitrary numbers of instances of component types. The resulting system of coordinated components satisfies by construction a characteristic property. For instance, Client-Server architectures are used to coordinate arbitrary numbers of instances of clients and servers. The ensured characteristic properties include atomicity of transactions and fault-tolerance.

An architecture can be characterized by the three following attributes:

1. The type of the coordinated components specified by their interfaces including port (function) names and rules regarding the way they are handled by the component's environment;
2. The type of the supported interactions, which may vary from point-to-point to multiparty interaction including rendezvous, broadcast, synchronous or asynchronous interaction;
3. The topology of the architecture which reflects the structure of the connections between components as well as between components and their environment. Simple topologies include centralized architectures (components interacting through a single coordinator), hierarchical architectures, ring architectures and clique architectures.

We characterize the complexity of architectures by the degree to which all these attributes may dynamically change and be organized, as illustrated in Figure 5. This classification distinguishes five types of architectures and has been carried out based on technical criteria presented in [12, 13].

1. Static architectures involve a predefined number of components and interconnections, e.g. HW architectures.
2. Parametric architectures take as arguments any number of instances of components of the appropriate type. Protocols, SW architectures, distributed algorithms are parametric architectures.
3. Dynamic architectures are parametric architectures supporting component dynamism — components may be created and deleted as in a Client-Server system.
4. Mobile architectures are dynamic architectures where additionally the system's external environment can dynamically change, as in mobile telecommunication systems.
5. Finally, self-organizing architectures allow reconfiguration between modes, where each mode has its own coordination rules. Such architectures are instrumental for modeling complex autonomous systems, e.g. swarms of robots and platooning vehicles.

Although architectures are of paramount importance in systems engineering, their formal study has not attracted so far the deserved attention. Hardware engineering relies on the concept of architecture as a means of building systems that satisfy essential properties by construction. In software engineering the focus has mainly been on the development of specific Architecture Description Languages. Unfortunately, most of the effort deals with syntactic aspects. More than 100 such languages have been proposed over the past twenty years but none of them has been adopted by practitioners [22].

We believe that research in architectures should focus on modeling techniques for self-organizing architectures by studying basic structuring principles and mechanisms and evaluating their expressiveness. Additionally, architectures should be used as a means for building systems that are by construction correct. The idea is quite simple and straightforward. Putting it into practice requires work in the following two directions.

First, we should study architectures as parametric behavior transformers and develop basic results for checking their correctness. Existing results on parametric verification put emphasis on limitations

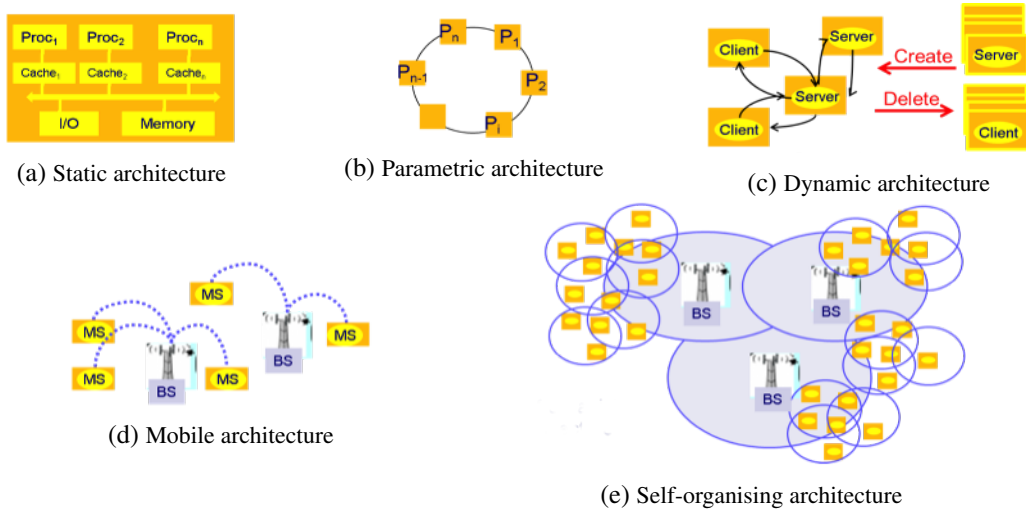

Figure 5: Classification of architectures

[6, 15]. The parametric verification of very simple parametric systems, even with finite-state components, is intractable. Nonetheless, we believe that it is worthwhile seeking practically relevant results in this direction, e.g. by developing semi-decision methods as we did for infinite state systems.

Second, we need composability theory for architectures allowing to combine two architectural solutions meeting each one a characteristic property, into a single solution meeting the conjunction of the properties [3]. Such results can be of tremendous practical relevance. Architectures can be implemented as software into which components can be plugged. Composability results simply guarantee the interference-free composition of two architecture softwares preserving respectively the enforced characteristic properties.

3.2 Non-human intervention — Adaptivity

When humans cooperate with semi-automated systems to achieve a mission, e.g. Level 2 and 3 in autonomous cars, they are mainly responsible for handling uncertain situations. It is well understood that computers are not good enough when dealing with such situations, while they perform better than humans specific well-defined tasks. An important question is how to design systems that exhibit adaptive behavior in real-time exactly as humans do.

3.2.1 Uncertainty in system design

Uncertainty in system design can be understood as the difference between average and extreme system behavior. System design must cope with increasing uncertainty from two origins:

1. Uncertainty from the system’s external environment exhibiting non-deterministic behavior, e.g. time-varying load, dynamic change due to mobility and attacks. How to figure out all possible security threats devised by an experienced hacker?
2. Uncertainty from the hardware execution platform which has inherently non-deterministic behavior owing to manufacturing errors or aging. It also exhibits time non-determinism since execution times of even simple instructions cannot be precisely estimated due to the use of memory hierarchies and speculative execution.

Uncertainty directly affects predictability, the degree to which qualitative or quantitative system properties can be asserted (see the discussion in Section 4.1).

Current state of the art in automated (and thus critical) system design consists in making a detailed analysis of all the potentially dangerous situations by clearly distinguishing between the ones the system can cope with and confiding all the rest in human operators. The analysis considers possible worst-case critical situations for which the designer should implement corresponding mitigation mechanisms and foresee the needed resources, e.g. using redundancy. This often results in over-provisioned, over-engineered systems, with high production and operation costs.

For modern critical systems it is practically impossible to foresee at design time all the possible hazards in system's lifetime due to poor predictability. Even if the sought degree of automation for a car is the same as for an aircraft, the openness of car systems makes impossible the static prediction of all potentially bad situations. An additional reason for breaking with this design paradigm is that the current divide with critical and best engineering effort is not any more affordable both technically and economically: it is an obstacle to increasing system integration [27].

3.2.2 The principle of adaptive control

In the face of this situation, it is necessary to give up the objective of guaranteeing trustworthiness at design time and seek a better integration between critical and less critical features. An alternative, more realistic avenue comes from the concept of adaptivity. It consists in enforcing properties through the use of intelligent controllers that continuously monitor the behavior of the system and when a mishap is detected, they steer the system so as to mitigate catastrophic effects. Adaptive control has originated in control theory [2].

An adaptive controller combines in a hierarchical manner three basic functions (Figure 6):

1. The central function is *objective management* that consists in choosing for a given state the best objective by applying a multi-criteria optimization algorithm. This algorithm is applied to a predictive model of the controlled system.
2. The *planning function* is activated by the objective management in order to execute a mission for achieving an objective.
3. The *learning function* is used to continuously update knowledge about the controlled system. In particular, based on the monitored behavior it estimates parameter values of the objective manager.

Adaptive control finds numerous applications in systems engineering to enhance system trustworthiness and optimality. For instance, to ensure security, early warning mechanisms are used to learn and build profiles of system users. So, they can detect abnormal situations caused by attacks or spyware and take adequate measures to mitigate their effect [16].

We have applied adaptive control to systems integrating both critical and best effort services. The controller handles a provably sufficient amount of global resources to: 1) satisfy first and foremost critical properties; and 2) secondarily, to handle optimally the available resources for best-effort services [10, 9].

We believe that adaptivity is the technical answer to the demand for both integrated mixed criticality systems and for trustworthiness despite uncertain/unpredictable environments.

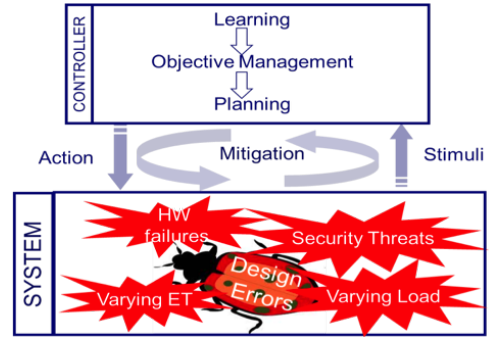

Figure 6: The principle of adaptive control

4 Knowledge-Based Design

The idea is to design a system with adaptivity in mind by incorporating the principle in the overall system architecture. Not only run-time knowledge, but also knowledge about the designed system is applied for the detection of critical events and the enforcement of properties. Such an approach should be more effective than using adaptive controllers external to the system. Knowledge-based design takes special care for accountability: at each design step we should know which essential properties hold. So, for the designed system we know which properties are guaranteed at design time and which ones are left to be monitored and possibly enforced at run time.

A system is deemed correct if knowledge both at design time and run time about the system allows inferring satisfaction of its requirements.

4.1 The concept of knowledge

Knowledge is “truthful” information that can be used to understand/predict a situation or to solve a problem. Truthfulness cannot always be asserted in a rigorous manner. Nonetheless, we can distinguish degrees between fully justifiable knowledge and empirical knowledge. Mathematical knowledge has definitely the highest degree of truthfulness. A theorem, e.g. the Pythagorean theorem, is true forever — modulo acceptance of the axioms of Euclidian geometry. Scientific knowledge is a generalization of experimental facts, e.g. Newton’s laws, and as such it is falsifiable. Then comes empirical knowledge, which is not theoretically substantiated but is found to be useful by experience. Most common human knowledge is empirical, e.g. common sense knowledge, but also knowledge from machine learning can be considered to a large extent as empirical.

Furthermore, knowledge may be declarative or procedural, regarding the form it can take. Declarative knowledge is a relation (property) involving entities of a domain, whereas procedural knowledge describes information transformation in a stepwise manner. Typical examples of declarative knowledge are the law of conservation of energy, a program invariant or an architecture pattern. Examples of procedural knowledge are algorithms, design techniques, cooking recipes.

4.2 Generated and applied knowledge in system design

We discuss the principle of knowledge generation and application in systems design (Figure 7).

Designers study systems to generate knowledge about their behavior e.g. verification, performance evaluation. The produced knowledge may be invariants, performance evaluation measures, knowledge from learning or statistical methods.

Rigorous knowledge generation from a system involves two steps.

1. The first step consists in modeling aspects of the system to be studied. Models may be mathematical, e.g. equations, or executable, e.g. a piece of software.
2. The second step consists in analyzing the model to extract usable knowledge. Analysis is often carried out using computers and can lead to either declarative or procedural knowledge. For instance, declarative knowledge may be the fact that “The door is always closed when the cabin moves” or estimated latency. An example of procedural knowledge is a testing scenario generated to validate a given system property.

Consequently, our ability to predict system properties is limited by two factors: 1) the ability to model the studied system; 2) the ability to analyze models using computationally tractable methods.

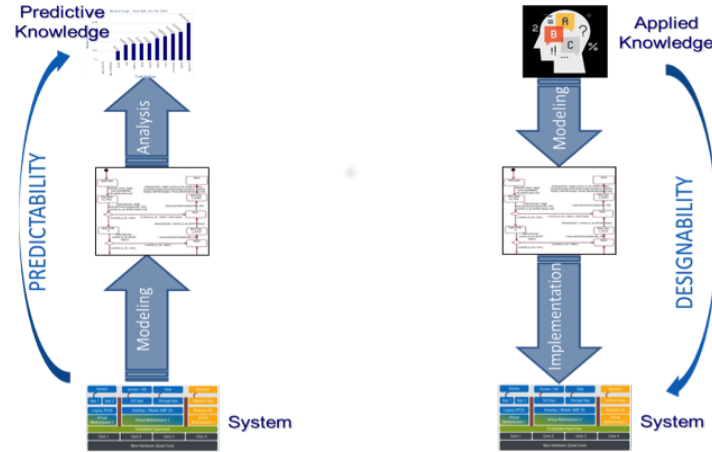

Figure 7: Bottom-up knowledge generation and the top-down knowledge application process

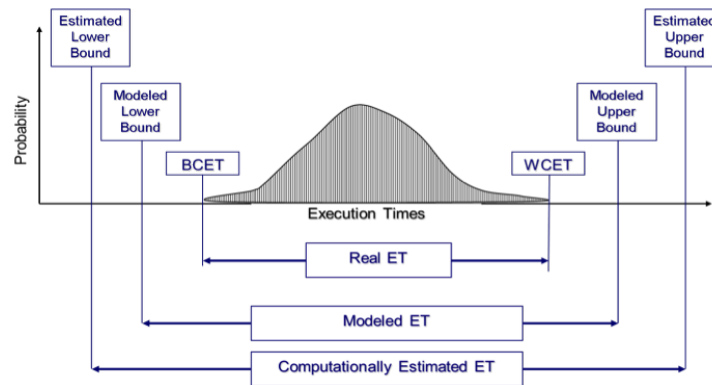

Figure 8: Real, modeled and computationally estimated execution times

Note that the terms *descriptive* and *predictive knowledge* are often used to distinguish between the knowledge of the model and the knowledge extracted by analysis. Uncertainty is directly related to our ability to build faithful models while predictability depends on both the degree of uncertainty and the ability to extract usable knowledge.

An important issue often overlooked by engineers, is to what extent we can predict system properties and how their prediction is impacted by modeling and computational limitations.

Consider for example a central problem in critical systems engineering that is the prediction of WCET (Worst Case Execution Times) and BCET (Best Case Execution Times) for a software running on a given hardware platform. The rigorous process consists in building a model of the mixed hardware/software system and then analyzing it to estimate execution times [31]. As already explained, tractable models can represent only some faithful abstraction of the real system. This means that execution times of a model are safe approximations of the actual execution times. Additionally, when analysis techniques are applied, e.g. by abstract interpretation, their effective application requires further approximation. So, as shown in Figure 8, the precision of the computed WCET and BCET depends on the precision of both modeling and analysis. It is important to note that the application of such a rigorous approach to sophisticated architectures may result in poor precision and practically useless results.

Often the knowledge generation process can be simplified when the model is a conceptual one and/or the analysis is simply by reasoning. For instance, by reading a program and analyzing assignments of variables one can find that if some condition holds a variable takes a certain value. These “superficial invariants” prove to be useful knowledge for proving other “deeper” properties.

Designers successively apply knowledge at each step of a design flow. System design can be seen as a knowledge application/transformation process starting from requirements and usable knowledge. Knowledge is progressively enriched with new knowledge generated by reasoning, by construction or by analysis in order to obtain an implementable model.

As a rule, knowledge application in design involves two main steps.

1. The first step consists in building from some specification a system model meeting the requirements. The main difficulty in this step may come from translating ambiguous specifications expressed in a natural language into a rigorous system model.
2. The second step involves computational complexity; it consists in extracting from the system model sufficient knowledge for an implementation meeting the requirements.

Consequently, our ability to design systems is limited by two factors: 1) the ability to build models meeting the requirements; 2) the ability to generate from these models, using computationally tractable methods, sufficient knowledge for implementing a system. Thus comes the concept of *designability*: to what extent is it possible to rigorously build systems?

System engineers often overlook designability issues. For complex systems, requirements elicitation is probably the most critical design step. But even when we come up with adequate system models, determining correct implementations may require significant analysis effort as illustrated by the following example.

Consider the problem of finding trustworthy and optimal deployments of some application software on a given multicore platform (Figure 2). As explained in Section 2.2, a deployment is a mapping and an associated scheduling algorithm.

Note that deployment trustworthiness and optimization can be assessed only for known WCET. However, WCET can be estimated only for known deployments. The WCET for a statement of a given task is the sum of the WCET for execution in isolation and of the waiting time of the task. The latter depends on the deployment function due to resource sharing with other tasks. Thus, there is a cyclic interdependency between deployments and WCET making the search for trustworthy and optimal deployments an extremely hard problem for multicore platforms [28]. This cyclic dependency can be broken for simple monolithic systems, e.g. flight control software for most Airbus types runs on bare metal.

Note that the general knowledge application process may be simplified when specifications are well understood or the implementation follows a well-defined pattern. This is the case when we apply a theorem, an algorithm or we reuse a component in the design process.

Figure 9 illustrates the three different kinds of knowledge presented in this section. Awareness that design is a knowledge generation/application process should allow a more unified and appropriate use of knowledge to achieve trustworthiness and optimality.

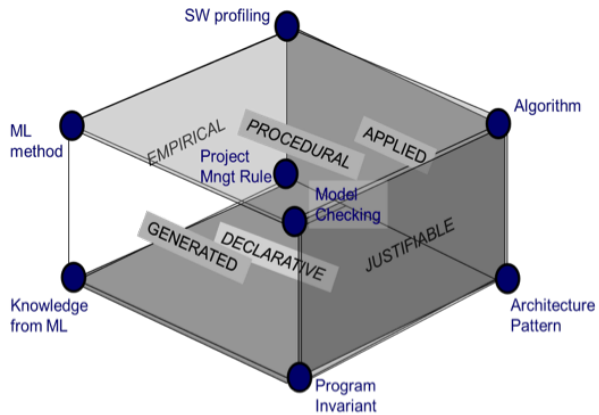

Figure 9: Types of knowledge used in system design

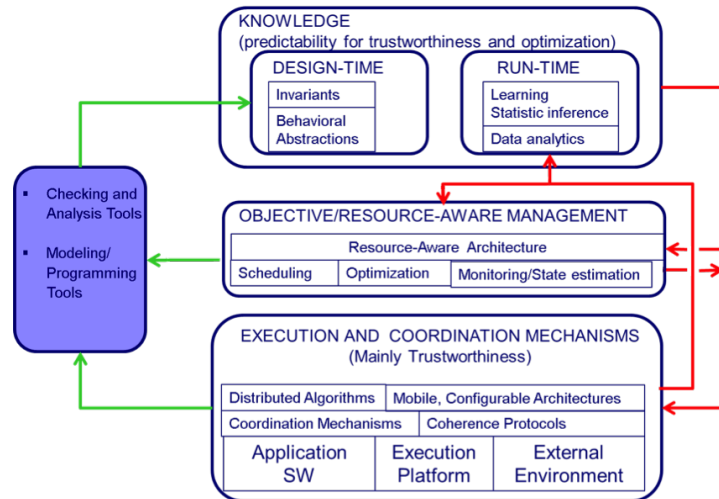

Figure 10: The principle of a knowledge-based logical architecture diagram

4.3 The Principle of Knowledge-Based Architecture

We define the two types of knowledge combined in a knowledge-based architecture.

- *Design-time knowledge* is essentially declarative knowledge about the properties of the designed system. These properties may be established at some design step, using verification/analysis or by construction, e.g. by reusing components or provably correct architecture patterns. Accountability of the design flow allows knowing which system properties hold for the designed system
- *Run-time knowledge* is generated by monitoring system execution and deducing facts about the running system such as the violation of some property or knowledge generated by application of learning techniques.

Figure 10 depicts the principle of a knowledge-based logical architecture diagram. The decomposition into three layers is inspired from adaptive architectures. The upper layer is a repository for both design-time and run-time knowledge. It keeps updated the run-time knowledge and combines the two types of knowledge to support the management process of the second layer.

The middle layer includes execution and coordination mechanisms with associated methods used by the application software to interact with the platform and the external environment. It is equipped with a predictive system model. It receives relevant knowledge from the upper layer so as to manage objectives and resources. Critical objectives deal with meeting hard real-time constraints and coping with critical failures and security threats.

The bottom layer integrates basic execution and coordination mechanisms with associated methods. It is important that their functional correctness is established at design time. This layer receives orders mainly from the middle layer and sends back information to both middle and upper layers (in red lines).

This schematic architecture leaves many issues open.

Some issues have to do with striking the right balance between design-time and run-time knowledge in order to achieve correctness. It is preferable that predictable critical properties be established at design time. On the contrary, violation of properties involving a high degree of uncertainty should be detected on-line and mitigated. Of course, other criteria may influence this balance, such as cost effectiveness and

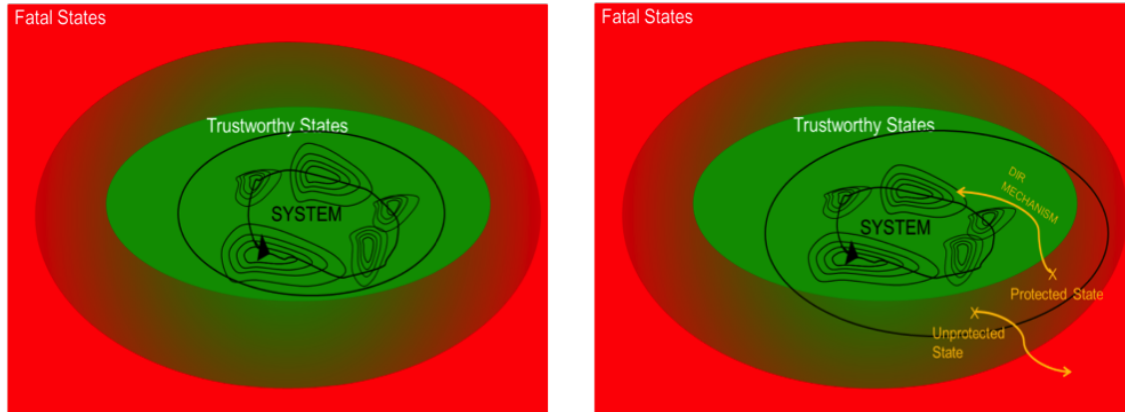

Figure 11: Correctness at design time vs. partial correctness

the sought degree of availability. Runtime enforcement of a property may require interruption of service, e.g. using a fail-safe mechanism.

Figure 11 illustrates two extreme cases: correctness at design time and partial correctness. The system state space is partitioned between trustworthy states (green region) and non-trustworthy states. The latter can be either 1) fatal states, i.e. states at which system trustworthiness is definitely compromised, or 2) non-fatal states that can be detected early enough so that a timely recovery into a trustworthy state is enforced at run-time using some DIR (Detection, Isolation and Recovery) mechanism. Correctness at design time corresponds to the ideal case where all the possible system states are proven to be trustworthy. In practice, avoidance of fatal states is achieved thanks to enhanced predictability in order to detect as early as possible flawed states and determine isolation and recovery strategies. A system is deemed correct if it always remains in trustworthy or non fatal states from which timely recovery is assured.

Other architectural issues have to do with performance and, in particular, the ability to meet hard real-time constraints. Determining which objective to choose in order to cope with a critical situation and planning the associated mission, may require non negligible computational power and time. It is important to find trade-offs between response times and precision of the management and planning processes. A crude and fast response is often better than a refined and slow one.

Finally, practical issues will ultimately weigh the relevance of the approach. These include the implementation of knowledge-based architectures and the integration of the two types of knowledge in a platform. For selected application areas, we need scalable knowledge management techniques allowing enhanced predictability as well as online control methods with sufficiently low overhead footprint.

5 Discussion

We have amply explained why future autonomous systems cannot be designed as classical critical systems. Current trends require novel rigorous design methodologies for open autonomous interconnected systems involving embedded supercomputers, AI algorithms and receiving data from the Cloud. We also need new trustworthiness assessment techniques and standards for third party certification.

Stringent predictability requirements of safety standards such as ISO 26262 and DO 178B preclude their application to IoT autonomous systems. Although they cannot guarantee absence of bugs, these standards allow checking the quality of the development process and provide model-based guarantees

that the system can cope with predictable mishaps compromising its safety. Clearly, they cannot handle machine learning software as it cannot be checked against requirements.

We currently lack standards for autonomous systems. Although certification by independent labs is mandatory, even for home appliances like toasters, the automotive and medical device industry are exempted from third-party certification. Robocars are self-certified by their manufacturers following guidelines and recommendations issued by authorities. Some autonomous car manufacturers consider that safety can be guaranteed only through testing an extremely large number of scenarios.

Interestingly enough, a recent article by Mobileye [25] advocates model-based safety as the only realistic approach for validating autonomous vehicles. Furthermore, it adheres to the well-understood position that testing-based approaches will require exorbitant time and money to achieve sufficient evidence of reliability [20]. Although the article only very partially tackles the multitude of issues raised by model-based design, it has the merit of posing the problem of rigorous safety evaluation and has already initiated controversial discussion in the media, e.g. [21]. It is a pity that the current debate focuses on the reliability of learning techniques and associated sensory devices while it completely overlooks key system design issues pertaining to global trustworthiness.

We believe that there is a risk that under the market and business pressure, the competent authorities accept the generalized deployment and use of self-certified autonomous systems without any conclusive evidence about their trustworthiness. A strong argument in favor of this can be that fully autonomous systems may be statistically safer than semi-autonomous systems (*“In the distant future, I think people may outlaw driving cars because it’s too dangerous”* — Elon Musk, May 18, 2015).

The advent of IoT is a great opportunity to reinvigorate Computing by focusing on autonomous system design. This certainly raises technology questions but, more importantly, it requires building new foundation that will systematically integrate the innovative results needed to face increasing environment and mission complexity. A key idea is to compensate the lack of human intervention by adaptive control. This is instrumental for system resilience: it allows both coping with uncertainty and managing mixed criticality services. Our proposal for knowledge-based design seeks a compromise: preserving rigorously despite the fact that essential properties cannot be guaranteed at design time. It makes knowledge generation and application a primary concern and aims to fully and seamlessly incorporate the adaptive control paradigm in system architecture.

Acknowledgement

The author thanks Dr Simon Bliudze for his valuable comments and suggestions for improving the paper.

References

- [1] Adelard, London, United Kingdom (1998): *The Adelard safety case development (ASCAD)*. Available at <https://www.adelard.com/resources/ascad.html>. [Available upon request].
- [2] Karl J. Åström & Björn Wittenmark (2013): *Adaptive Control*, 2nd edition. Dover Books on Electrical Engineering, Dover Publications.
- [3] Paul Attie, Eduard Baranov, Simon Bliudze, Mohamad Jaber & Joseph Sifakis (2016): *A general framework for architecture composability*. *Formal Aspects of Computing* 28(2), pp. 207–231, doi:10.1007/s00165-015-0349-8.

- [4] Ananda Basu, Saddek Bensalem, Marius Bozga, Jacques Combaz, Mohamad Jaber, Thanh-Hung Nguyen & Joseph Sifakis (2011): *Rigorous Component-Based System Design Using the BIP Framework*. *IEEE Software* 28(3), pp. 41–48, doi:10.1109/MS.2011.27.
- [5] Simon Bliudze, Sébastien Furic, Joseph Sifakis & Antoine Viel (2017): *Rigorous design of cyber-physical systems*. *Software & Systems Modeling*, pp. 1–24, doi:10.1007/s10270-017-0642-5.
- [6] Roderick Bloem, Swen Jacobs, Ayrat Khalimov, Igor Konnov, Sasha Rubin, Helmut Veith & Josef Widder (2015): *Decidability of Parameterized Verification*. *Synthesis Lectures on Distributed Computing Theory*, Morgan & Claypool Publishers, doi:10.2200/S00658ED1V01Y201508DCT013.
- [7] Vinton G. Cerf (2017): *Take Two Aspirin and Call Me in the Morning*. *Commun. ACM* 60(9), pp. 6–6, doi:10.1145/3130331.
- [8] Edmund M. Clarke, E. Allen Emerson & Joseph Sifakis (2009): *Model Checking: Algorithmic Verification and Debugging*. *Commun. ACM* 52(11), pp. 74–84, doi:10.1145/1592761.1592781.
- [9] Jacques Combaz, Jean-Claude Fernandez, Thierry Lepley & Joseph Sifakis (2005): *QoS Control for Optimality and Safety*. In: *Proceedings of the 5th ACM International Conference on Embedded Software, EMSOFT '05*, ACM, New York, NY, USA, pp. 90–99, doi:10.1145/1086228.1086247.
- [10] Jacques Combaz, Jean-Claude Fernandez, Joseph Sifakis & Loïc Strus (2008): *Symbolic quality control for multimedia applications*. *Real-Time Systems* 40(1), pp. 1–43, doi:10.1007/s11241-008-9049-2.
- [11] Richard A. De Millo, Richard J. Lipton & Alan J. Perlis (1979): *Social Processes and Proofs of Theorems and Programs*. *Commun. ACM* 22(5), pp. 271–280, doi:10.1145/359104.359106.
- [12] Rocco De Nicola, Alessandro Maggi & Joseph Sifakis (2018): *DReAM: Dynamic Reconfigurable Architecture Modeling (full paper)*. *ArXiv e-prints* (arXiv:1805.03724 [cs:FL]). Available at <https://arxiv.org/abs/1805.03724>.
- [13] Rim El Ballouli, Saddek Bensalem, Marius Bozga & Joseph Sifakis (2018): *DR-BIP — Programming Dynamic Reconfigurable Systems*. Technical Report TR-2018-3, Verimag Research Report.
- [14] Darrell Etherington (2018): *Uber self-driving test car involved in accident resulting in pedestrian death*. TechCrunch article. Available at <http://tcrn.ch/2GJjrYT>. [Online; accessed 03-June-2018].
- [15] Steven M. German & A. Prasad Sistla (1992): *Reasoning About Systems with Many Processes*. *J. ACM* 39(3), pp. 675–735, doi:10.1145/146637.146681.
- [16] Samuel Greengard (2016): *Cybersecurity Gets Smart*. *Commun. ACM* 59(5), pp. 29–31, doi:10.1145/2898969.
- [17] Nicolas Halbwachs (1993): *Synchronous Programming of Reactive Systems*. Springer, Boston, MA, doi:10.1007/978-1-4757-2231-4.
- [18] Daniel Howley (2018): *Warren Buffett: 'Cyber is uncharted territory and it's going to get worse, not better'*. Yahoo Finance article. Available at <https://finance.yahoo.com/news/warren-buffett-cyber-uncharted-territory-going-get-worse-not-better-164025140.html>. [Online; accessed 03-June-2018].
- [19] Ivar Jacobson & Ed Seidewitz (2014): *A New Software Engineering*. *Commun. ACM* 57(12), pp. 49–54, doi:10.1145/2677034.
- [20] Nidhi Kalra & Susan M. Paddock (2016): *Driving to Safety: How Many Miles of Driving Would It Take to Demonstrate Autonomous Vehicle Reliability?* Technical Report RR-1478-RC, RAND Corporation, Santa Monica, Calif., doi:10.7249/RR1478. Available at https://www.rand.org/pubs/research_reports/RR1478.html. [Online; accessed 03-June-2018].
- [21] Timothy B. Lee (2018): *Intel's Mobileye wants to dominate driverless cars — but there's a problem*. Ars Technica article. Available at https://arstechnica.com/?post_type=post&p=1310863. [Online; accessed 03-June-2018].

- [22] Ivano Malavolta, Patricia Lago, Henry Muccini, Patrizio Pelliccione & Antony Tang (2013): *What Industry Needs from Architectural Languages: A Survey*. *IEEE Transactions on Software Engineering* 39(6), pp. 869–891, doi:10.1109/TSE.2012.74.
- [23] National Highway Traffic Safety Administration (2016): *Federal Automated Vehicles Policy, Accelerating the Next Revolution In Roadway Safety*. United States Department of Transportation, Washington, D.C., United States. Available at http://www.safetyresearch.net/Library/Federal_Automated_Vehicles_Policy.pdf.
- [24] Alfred Ng (2018): *Google, Microsoft find another Spectre, Meltdown flaw*. CNET article. Available at <https://cnet.co/2kf1edW>. [Online; accessed 03-June-2018].
- [25] Shai Shalev-Shwartz, Shaked Shammah & Amnon Shashua (2017): *On a Formal Model of Safe and Scalable Self-driving Cars*. *ArXiv e-prints* (arXiv:1708.06374v2 [cs.RO]). Available at <https://arxiv.org/abs/1708.06374v2>.
- [26] Joseph Sifakis (2013): *Rigorous System Design. Foundations and Trends® in Electronic Design Automation* 6(4), pp. 293–362, doi:10.1561/10000000034.
- [27] Joseph Sifakis (2015): *System Design Automation: Challenges and Limitations*. *Proceedings of the IEEE* 103(11), pp. 2093–2103, doi:10.1109/JPROC.2015.2484060.
- [28] Stefanos Skalistis & Alena Simalatsar (2017): *Near-optimal deployment of dataflow applications on many-core platforms with real-time guarantees*. In: *Design, Automation and Test in Europe Conference Exhibition (DATE), 2017*, pp. 752–757, doi:10.23919/DATE.2017.7927090.
- [29] David A. Watt, Brian A. Wichmann & William Findlay (1987): *Ada Language and Methodology*. Prentice Hall International (UK) Ltd., Hertfordshire, UK.
- [30] Wikipedia contributors (2018): *Autonomous car — Wikipedia, The Free Encyclopedia*. Available at https://en.wikipedia.org/w/index.php?title=Autonomous_car&oldid=843974758. [Online; accessed 03-June-2018].
- [31] Reinhard Wilhelm, Jakob Engblom, Andreas Ermedahl, Niklas Holsti, Stephan Thesing, David Whalley, Guillem Bernat, Christian Ferdinand, Reinhold Heckmann, Tulika Mitra, Frank Mueller, Isabelle Puaut, Peter Puschner, Jan Staschulat & Per Stenström (2008): *The Worst-case Execution-time Problem — Overview of Methods and Survey of Tools*. *ACM Trans. Embed. Comput. Syst.* 7(3), pp. 36:1–36:53, doi:10.1145/1347375.1347389.
- [32] Ali Zolghadri (2012): *Advanced model-based FDIR techniques for aerospace systems: Today challenges and opportunities*. *Progress in Aerospace Sciences* 53, pp. 18–29, doi:10.1016/j.paerosci.2012.02.004.