

Ricci-flat graphs with girth four

Weihua He^a, Jun Luo^b, Chao Yang^{b,*}, Wei Yuan^b

^a*Department of Applied Mathematics, Guangdong University of Technology, Guangzhou, China*

^b*School of Mathematics, Sun Yat-Sen University, Guangzhou, China*

Abstract

Lin-Lu-Yau introduced an interesting notion of Ricci curvature for graphs and obtained a complete characterization for all Ricci-flat graphs with girth at least five [1]. In this paper, we propose a concrete approach to construct an infinite family of distinct Ricci-flat graphs of girth four with edge-disjoint 4-cycles and completely characterize all Ricci-flat graphs of girth four with vertex-disjoint 4-cycles.

Keywords: Ricci curvature, Ricci-flat graph, vertex-disjoint

2010 MSC: 05C75

1. Introduction

A manifold is Ricci-flat if the Ricci curvature vanishes everywhere. Calabi-Yau manifolds are a special type of Ricci-flat manifolds, which provide a potential model to describe the physical world [2]. The study of Ricci curvature on manifolds has inspired several attempts to bring the concept of Ricci curvature to graphs. Ollivier introduced the Ricci curvature of Markov chains on metric spaces, including graphs [3]. By modifying Ollivier's definition, Lin-Lu-Yau proposed a slightly different definition for Ricci curvature of graphs [4]. These new concepts have received considerable discussions. See for example [5, 6]. These new notions even find applications within combinatorics and computer science. Among others, we refer to [7] for the relation between Ollivier's Ricci curvature and the coloring of graphs and [8] for the employment of Ricci curvature in understanding the Internet topology.

This paper considers the Ricci curvature in the sense of Lin-Lu-Yau. We are especially interested in *Ricci-flat* graphs, whose Ricci curvature vanishes on every edge. A very recent pioneering work by Lin-Lu-Yau [1] completely characterizes all Ricci-flat graphs with girth at least five.

Theorem 1. *A Ricci-flat graph with girth at least five is isomorphic to: (1) the infinite path, (2) a cycle of length at least six, (3) the dodecahedral graph, (4) the half-dodecahedral graph, or (5) the Petersen graph.*

^{*}This work was supported by the National Natural Science Foundation of China (No. 11201496 and No. 11601093).

*Corresponding author: yangchao0710@gmail.com, yangch8@mail.sysu.edu.cn.

The authors of [1] also gave infinitely many examples of Ricci-flat graphs with girth four. We note that, in all their examples, the 4-cycles have common edges. Even if 4-cycles having common edges are not allowed, we can still construct infinitely many Ricci-flat graphs with edge-disjoint 4-cycles, see Figure 1.

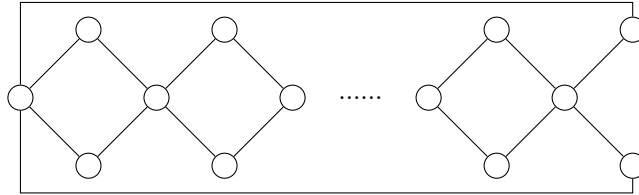

Figure 1: A family of Ricci-flat graphs with edge-disjoint 4-cycles

Then, the remaining Ricci-flat graphs with girth four are those in which every two 4-cycles are vertex-disjoint, *i.e.* having no common vertices. For those graphs, we obtain the following simple characterization, which is the main result of this paper.

Theorem 2. *A Ricci-flat graph with girth four such that no vertex is shared by two 4-cycles is isomorphic to one of the following two graphs.*

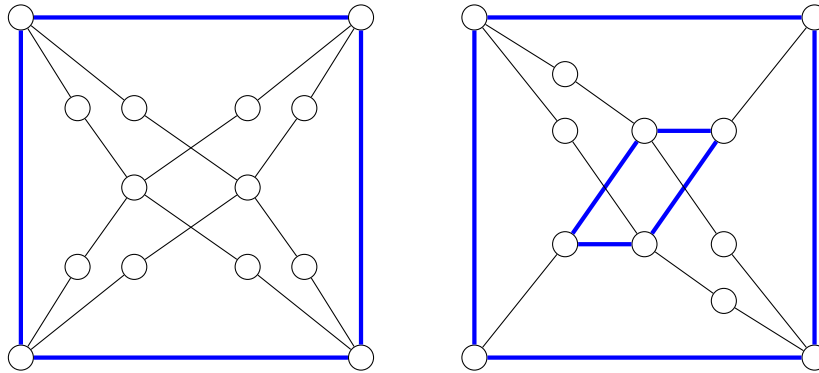

Figure 2: The graphs R_1 (left) and R_2 (right)

The rest of this paper is arranged as follows. Section 2 recalls the notion of Ricci curvature on graphs. Section 3 reviews the local structures of Ricci-flat graphs. And Section 4 presents the proof of Theorem 2.

2. Preliminaries

We follow Lin-Lu-Yau for the definition of Ricci curvature [4, 1]. Let G be a simple undirected graph with vertex set V and edge set E . For $x, y \in V$, let $N(x)$ be the set of neighbors of x , $d_x = |N(x)|$ be the degree of vertex x , and $d(x, y)$ be the distance between x and y in G .

A probability distribution is a function $m : V \rightarrow [0, 1]$ with $\sum_{x \in V} m(x) = 1$. To define Ricci curvature for each edge of the graph, we only consider distributions m_x^α in the following form,

$$m_x^\alpha(v) = \begin{cases} \alpha, & v = x; \\ \frac{1-\alpha}{d_x}, & x \in N(x); \\ 0, & \text{otherwise,} \end{cases}$$

where $\alpha \in [0, 1]$ and $x \in V$.

Let $xy \in E$, and let m_x^α and m_y^α be two distributions. A transportation problem between the two distributions can be stated as a linear programming problem. That is, to find the minimum transportation distance

$$\min \sum_{u,v \in V} d(u,v) X_{uv},$$

subject to the constraints

$$\begin{cases} \sum_{v \in V} X_{uv} = m_x^\alpha(u), & u \in V; \\ \sum_{u \in V} X_{uv} = m_y^\alpha(v), & v \in V; \\ X_{uv} \geq 0, \end{cases}$$

35 where the variable X_{uv} denotes the amount transferred from vertex u to vertex v .

Define the transportation distance between m_x^α and m_y^α to be optimal solution to the above linear programming problem, namely

$$W(m_x^\alpha, m_y^\alpha) = \min \sum_{u,v \in V} d(u,v) X_{uv}.$$

Ricci curvature is definable on any unordered pair of vertices x and y , but for our purpose, we only need the case that x and y are adjacent. For any edge $xy \in E$, the Ricci curvature $\kappa(x, y)$ is defined to be

$$\kappa(x, y) = \lim_{\alpha \rightarrow 1} \frac{1 - W(m_x^\alpha, m_y^\alpha)}{1 - \alpha}.$$

Recall that a graph G is Ricci-flat if $\kappa(x, y) = 0$ for all edges $xy \in E$.

A function f over the vertex set V of G is said to be c -Lipschitz if $|f(u) - f(v)| \leq c \cdot d(u, v)$ for all $u, v \in V$. By the theory of linear programming, the dual problem of the above defined transportation problem between m_x^α and m_y^α is to find the maximum value

$$\max \sum_{u \in V} f(u)(m_x^\alpha(u) - m_y^\alpha(u))$$

subject to

$$|f(u) - f(v)| \leq d(u, v), u, v \in V.$$

In other words, the maximum is taken over all 1-Lipschitz function f . Because the optimal solution of a linear programming problem is equal to that of its dual problem, we have

$$W(m_x^\alpha, m_y^\alpha) = \max \sum_{u \in V} f(u)(m_x^\alpha(u) - m_y^\alpha(u)).$$

Thus, we have the following lemma.

Lemma 1 ([1]). *Let f be any 1-Lipschitz function, then*

$$W(m_x^\alpha, m_y^\alpha) \geq \sum_{u \in V} f(u)(m_x^\alpha(u) - m_y^\alpha(u)).$$

3. Local Structures

Before our discussion on the local structure of Ricci-flat graphs of girth 4, we recall a lemma
 40 from [1].

Lemma 2 ([1]). *Suppose that an edge xy in a graph G is not in any 3-cycles or 4-cycles, and assume $d_x \leq d_y$, then one of the following statements holds.*

1. $d_x = d_y = 2$, and xy is not in any 5-cycle.
2. $d_x = d_y = 3$, and xy is shared by two 5-cycles.
- 45 3. $d_x = 2, d_y = 3$. Let x_1 be the other neighbor of x besides y , and let y_1 and y_2 be the two neighbors of y besides x , then $\{d(x_1, y_1), d(x_1, y_2)\} = \{2, 3\}$.
4. $d_x = 2, d_y = 4$. Let x_1 be the other neighbor of x besides y , and let y_1, y_2 and y_3 be the three neighbors of y besides x , then at least two of y_1, y_2, y_3 have distance 2 from x_1 .

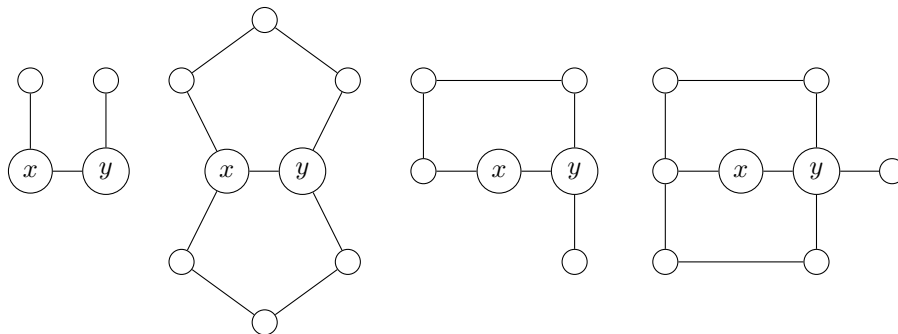

Figure 3: Local Structures for girth at least five

The above lemma lends us important ideas in analyzing the the local structure of Ricci-flat
 50 graphs of girth 4. Actually, we will obtain the following very useful lemmas.

Lemma 3. *Let xy be an edge of a graph G , and xy is in exactly one 4-cycle but is not in any 3-cycle. Then $\kappa(x, y) \leq \frac{2}{d_x} + \frac{2}{d_y} - 1$.*

PROOF. Since the edge xy is in a unique 4-cycle, let z be the other neighbor of x in this cycle.

Let

$$f(u) = \begin{cases} 0 & \text{if } u \in N[x] \setminus \{y, z\}, \\ 2 & \text{if } u \in N(y) \setminus \{x\}, \\ 1 & \text{otherwise.} \end{cases}$$

Obviously, f is a 1-Lipschitz function over graph G . By lemma 1,

$$\begin{aligned} W(m_x^\alpha, m_y^\alpha) &\geq \sum_{u \in V} f(u)[m_y^\alpha(u) - m_x^\alpha(u)] \\ &= \left(\alpha - \frac{1-\alpha}{d_x}\right) + \left(0 - \frac{1-\alpha}{d_x}\right) + 2(d_y - 1)\left(\frac{1-\alpha}{d_y} - 0\right) \\ &= (2 - \alpha) - (1 - \alpha)\left(\frac{2}{d_x} + \frac{2}{d_y}\right). \end{aligned}$$

55 So

$$\kappa(x, y) = \lim_{\alpha \rightarrow 1} \frac{1 - W(m_x^\alpha, m_y^\alpha)}{1 - \alpha} \leq \frac{2}{d_x} + \frac{2}{d_y} - 1.$$

□

The next lemma characterizes the local structures for edges in a 4-cycle of a Ricci-flat graph G with girth 4 and disjoint 4-cycles.

Lemma 4. *Suppose that G is a graph with girth 4, and the 4-cycles of G are mutually vertex-*
60 *disjoint. Let xy be an edge of G in a 4-cycle with Ricci curvature $\kappa(x, y) = 0$. Without loss of*
generality, we assume $d_x \leq d_y$, then one of the following statements holds.

1. $d_x = 2, d_y = 4$, and xy is not in any 5-cycle.
2. $d_x = d_y = 3$, and xy is not in any 5-cycle.
3. $d_x = 3, d_y = 4$. Let x_1 and x_2 be the two neighbors of x besides y with x_1 in the 4-cycle, and
65 let y_1 and y_2 be the two neighbors of y not in the 4-cycle, then either $d(x_1, y_1) = d(x_2, y_2) = 2$
(Type A), or $d(x_2, y_1) = d(x_2, y_2) = 2$ (Type B).
4. $d_x = d_y = 4$. Let x_1 and x_2 be the two neighbors of x not in the 4-cycle, and let y_1 and y_2
be the two neighbors of y not in the 4-cycle, then $d(x_1, y_1) = d(x_2, y_2) = 2$.

Remark 1. Lemma 4 claims that under certain conditions, for each edge xy with Ricci curvature
70 0, there are four possible degree combinations $\{d_x, d_y\}$. But there are two possible local structures
in the $\{3, 4\}$ combination, which are denoted by type A and type B, resulting in five local structures
in all.

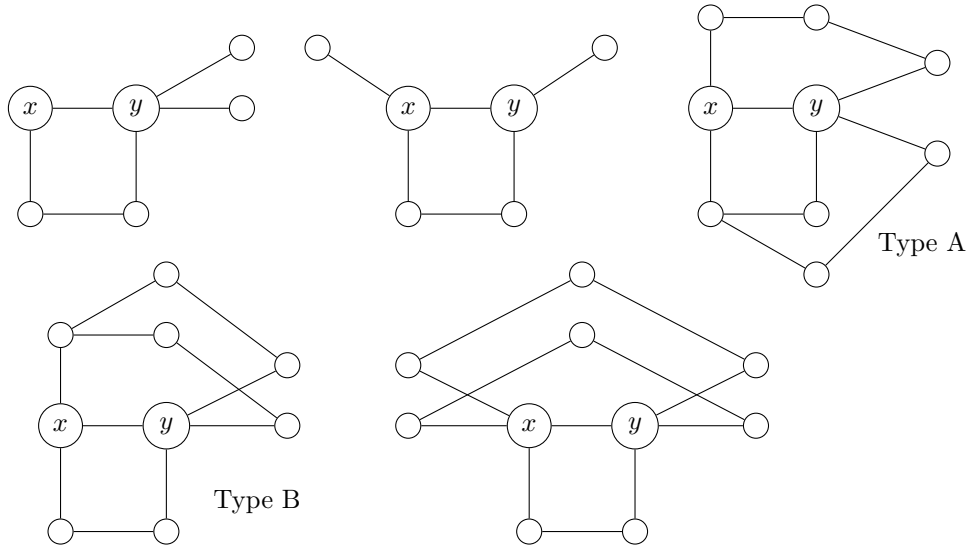

Figure 4: Local Structures in 4-cycle

PROOF. By Lemma 3 and the hypothesis that $\kappa(x, y) = 0$, we have $0 \leq \frac{2}{d_x} + \frac{2}{d_y} - 1$. Solving this inequality, we have the following solutions.

- 75 (A) $d_x = 2, d_y \geq 2$.
- (B) $d_x = 3, d_y = 3, 4, 5, 6$.
- (C) $d_x = d_y = 4$.

Because the 4-cycles of G are disjoint, the vertex y must be incident to another edge which is not in any 3-cycles or 4-cycles, if $d_y \geq 3$. By Lemma 2, $d_y \leq 4$. So the possible values of d_x and d_y become the following.

- 80 (A) $d_x = 2, d_y = 2, 3, 4$.
- (B) $d_x = 3, d_y = 3, 4$.
- (C) $d_x = d_y = 4$.

Simple calculation shows that if $d_x = d_y = 2$, then $\kappa(x, y) = 1$. So no local structure is possible for this degree combination.

If $d_x = 2$ and $d_y = 3$, let x_1 be the other neighbor of x besides y , and let y_1 be the neighbor of y that is not in the 4-cycle. Because the 4-cycles of G are disjoint, $d(x_1, y_1) \geq 2$. If $d(x_1, y_1) = 2$, we have $\kappa(x, y) = \frac{1}{2}$. If $d(x_1, y_1) \geq 3$, we have $\kappa(x, y) = \frac{1}{3}$.

If $d_x = 2$ and $d_y = 4$, let x_1 be the other neighbor of x besides y , and let y_1 and y_2 be the two neighbors of y that is not in the 4-cycle. If $d(x_1, y_1) = 2$ or $d(x_1, y_2) = 2$, then $\kappa(x, y) = \frac{1}{4}$. If $d(x_1, y_1) \geq 3$ and $d(x_1, y_2) \geq 3$, then $\kappa(x, y) = 0$. Therefore, the edge xy is not in any 5-cycle.

d_x	d_y	$d(x_1, y_1)$	$d(x_1, y_1), d(x_1, y_2)$	κ
2	2	-	-	1
2	3	2	-	$\frac{1}{2}$
2	3	≥ 3	-	$\frac{1}{3}$
2	4	-	$2, \geq 2$ or $\geq 2, 2$	$\frac{1}{4}$
2	4	-	$\geq 3, \geq 3$	0

Table 1: $d_x = 2$

$d(x_1, y_1), d(x_1, y_2)$	$d(x_2, y_1), d(x_2, y_2)$	κ
3, 3	3, 3	$-\frac{1}{3}$
3, 3	2, 3	$-\frac{1}{12}$
3, 3	2, 2	0
$2, \geq 2$	3, 3	$-\frac{1}{4}$
2, 2	2, 3	0
2, 3	2, 3	$-\frac{1}{12}$
$2, \geq 2$	3, 2	0
$2, \geq 2$	2, 2	$\frac{1}{12}$

Table 2: $d_x = 3, d_y = 4$

The above calculations for the case (A) $d_x = 2$ and $d_y = 2, 3, 4$ can be summarized in Table 1.

If $d_x = 3$ and $d_y = 3$, let x_1 and x_2 be the other neighbors of x besides y , with x_1 in the 4-cycle. And let y_1 and y_2 be the two neighbors of y besides x , with y_1 in the 4-cycle. If $d(x_2, y_2) = 2$, then $\kappa(x, y) = \frac{1}{3}$. If $d(x_2, y_2) \geq 3$, then $\kappa(x, y) = 0$.

If $d_x = 3$ and $d_y = 4$, let x_1 and x_2 be the other neighbors of x besides y , with x_1 in the 4-cycle. And let y_1 and y_2 be the two neighbors of y not in the 4-cycle. Note that either $d(x_i, y_j) = 2$ or $d(x_i, y_j) = 3$ for all $i, j = 1, 2$, so the complete calculations are divided into 8 subcases according to the distances between x_1, x_2 and y_1, y_2 . The result are listed in Table 2. In three of the subcases (Lines 4,6,8 of the table), the Ricci curvature of edge xy vanishes. Line 4 is Type B. Since the vertices y_1 and y_2 are interchangeable, line 6 and line 8 of the table can be combined to obtain the local structure of Type A.

If $d_x = 4$ and $d_y = 4$, let x_1 and x_2 be the two neighbors of x not in the 4-cycle. And let y_1 and y_2 be the two neighbors of y not in the 4-cycle. Table 3 shows the Ricci curvature of edge xy for different subcases. The unique subcase that the Ricci curvature vanishes is illustrated in bottom right of Figure 4.

□

$d(x_1, y_1), d(x_1, y_2)$	$d(x_2, y_1), d(x_2, y_2)$	κ
3, 3	3, 3	$-\frac{1}{2}$
2, 3	$\geq 2, 3$	$-\frac{1}{4}$
$2, \geq 2$	$\geq 2, 2$	0

Table 3: $d_x = 4, d_y = 4$

Lemma 2 and Lemma 4 will be applied repeatedly in proving the main result in the next section.

110 4. The Main Result

This section proves Theorem 2 by exhausting all possible cases.

PROOF OF THEOREM 2. We start by investigating a 4-cycle of G . By Lemma 4, the degree sequence of a 4-cycle of G in cyclic order can be only one of the following cases.

1. (2,4,2,4)
- 115 2. (2,4,4,4)
3. (3,3,3,3)
4. (3,3,3,4)
5. (3,3,4,4)
6. (3,4,4,4)
- 120 7. (3,4,3,4)
8. (4,4,4,4)

We will show that in the first six cases, the graph G could not exist. And in the last two cases, exactly one graph is possible for each case.

Case 1. (2,4,2,4). Let a, b, c, d be the four vertices of the 4-cycle, in the order of the degree sequence. That is $d(a) = d(c) = 2$ and $d(b) = d(d) = 4$. Let b_1 and b_2 the other two neighbors of b , and let d_1 and d_2 be the other two neighbors of d . Obviously, b_i and d_j ($1 \leq i, j \leq 2$) are distinct vertices, otherwise there would be 4-cycles with common edges. In the remaining cases, we will denote and refer to the vertices in the 4-cycle and their neighbors in a similar manner.

Because the edge bb_1 does not lie in any 4-cycle by the hypothesis of the theorem, so it must satisfy the local structure of Lemma 2. Since $d(b) = 4$, so $d(b_1) = 2$. By the same reason 130 $d(b_2) = d(d_1) = d(d_2) = 2$. Let z be the other neighbor of b_1 besides b . See Figure 5. Note that z

must be distinct from d_1 or d_2 . Suppose to the contrast that the other neighbor of b_1 is d_1 , then the edge b_1d_1 does not satisfy Lemma 2.

Now we apply Lemma 2 to edge bb_1 , at least two vertices of a, c, b_2 have distance 2 from z . But this is impossible (because there is no way to form a 2-path from z to either a or c), so no graph exists for this case.

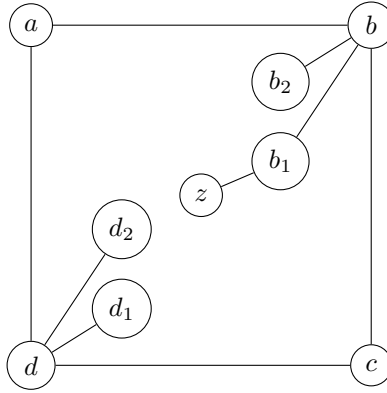

Figure 5: Case 1. (2,4,2,4)

Case 2. (2,4,4,4). See Figure 6. The same as Case 1, because the degree of vertices b, c, d are 4, the degree of vertices b_i, c_i, d_i ($i = 1, 2$) are all 2. By applying Lemma 4 to edge bc , without loss of generality, let z_i be the common neighbor of b_i and c_i ($i = 1, 2$). By applying Lemma 4 again to edge cd , we know that the vertices c_i and d_i have a common neighbor, for $i = 1, 2$. But since all the vertices c_1, c_2, d_1, d_2 have degree 2, the common neighbor of c_i and d_i has to be z_i , for $i = 1, 2$. Now, all vertices in Figure 6 cannot be extended except z_1 and z_2 . Therefore, the edge bb_1 does not satisfy Lemma 2 (the edge bb_1 does not lie in two 5-cycles), no graph exists for this case, either.

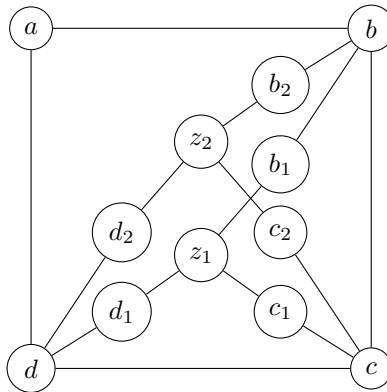

Figure 6: Case 2. (2,4,4,4)

Case 3. (3,3,3,3). In this case, each vertex of the 4-cycle, a, b, c and d , has exactly one

neighbor outside the 4-cycle, denoted by a_1, b_1, c_1 and d_1 , respectively. By Lemma 2, the degree of a_1, b_1, c_1 and d_1 can be either 2 or 3.

If $d(b_1) = 3$, by Lemma 2, the edge bb_1 is shared by two 5-cycles, this contradicts with the fact the the edge ab cannot lie in any 5-cycles. If $d(b_1) = 2$, by Lemma 2, the edge bb_1 need to form a
150 5-cycle with either ab or bc , which is also a contradiction. So no graph exists for this case.

Case 4. (3,3,3,4). The same as Case 3, by applying Lemma 2 to edge bb_1 , there will be a contradiction. So no graphs exists for this case.

Case 5. (3,3,4,4). See Figure 7. Both a_1 and b_1 must have degree 2, otherwise by the same argument in Case 3 the edge ab lies in a 5-cycle, a contradiction. Also, the degree of c_1, c_2, d_1 and
155 d_2 are all 2. By applying Lemma 4 to edge cd , let z_i be the common neighbor of c_i and d_i , for $i = 1, 2$. Thus the edges bc and da have no way to satisfy the local condition. Again, no graph exists for this case.

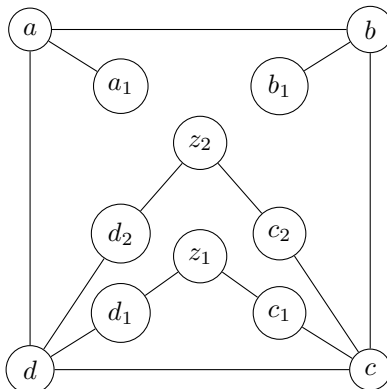

Figure 7: Case 5. (3,3,4,4)

Case 6. (3,4,4,4). The structure of the graph is similar to that of Case 2, except that a will have a neighbor a_1 . To satisfy the local condition for edges ab and da , the vertex a_1 must
160 be adjacent to both z_1 and z_2 , see Figure 8. But then the edge a_1z_1 does not satisfy the local condition. So no graph exists for this case.

Case 7. (3,4,3,4). The degree combination for the two vertices of each edge in the 4-cycle is $\{3, 4\}$. There are two types of local structures for the $\{3, 4\}$ combination, namely type A and type B. It is easy to show that the four edges in the 4-cycle must satisfy the same type of local
165 condition. If all of them are type A, no graph is possible. If all of them are type B, we obtain the graph R_2 , see Figure 2.

Case 8. (4,4,4,4). By applying Lemma 4 to edge ab , let z_i be the common vertex of a_i and b_i ($i = 1, 2$), respectively (See Figure 9). Then by applying Lemma 2 to edge bb_1 , the degree of b_1 must be two. In other words, b_1 has no other neighbors besides b and z_1 . Now by applying Lemma
170 4 to edges bc and cd , we obtain the graph R_1 , see Figure 2.

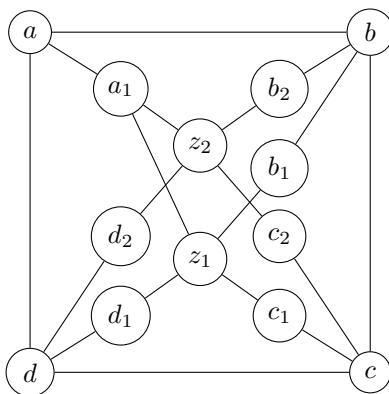

Figure 8: Case 6. (3,4,4,4)

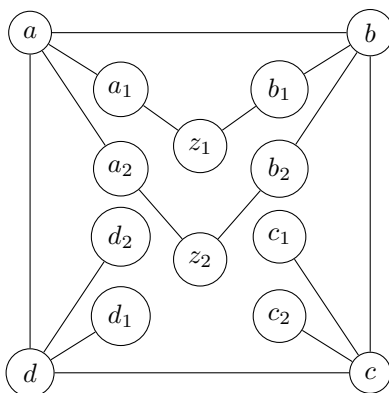

Figure 9: Case 8. (8,4,4,4)

Finally, it is easy to check that the graphs R_1 and R_2 are indeed Ricci-flat. □

Remark 2 (Further Study). Our method in proving Theorem 2 might be extended further to study the Ricci-flat graphs of girth 4 and with edge-disjoint 4-cycles. In such an extension, more involved discussions are expected, especially when one wants to generalize the result of Lemma 4 so that more local degree combinations for an edge xy in a 4-cycle are included. By the examples given in Figure 1, we see that any characterization of Ricci-flat graphs of girth 4 and with edge-disjoint 4-cycles must contain infinitely many types.

References

References

- [1] Y. Lin, L. Lu, S.-T. Yau, Ricci-flat graphs with girth at least five, *Communications in Analysis and Geometry* 22 (4) (2014) 671–687. doi:10.4310/CAG.2014.v22.n4.a3.
 URL <http://www.intlpress.com/site/pub/pages/journals/items/cag/content/vols/0022/0004/a003/>

- [2] S.-T. Yau, S. Nadis, *The Shape of Inner Space : String Theory and the Geometry of the Universe's Hidden Dimensions*, Basic Books, 2010.
- 185 [3] Y. Ollivier, Ricci curvature of markov chains on metric spaces, *Journal of Functional Analysis* 256 (3) (2009) 810 – 864. doi:<https://doi.org/10.1016/j.jfa.2008.11.001>.
URL <http://www.sciencedirect.com/science/article/pii/S002212360800493X>
- [4] Y. Lin, L. Lu, S.-T. Yau, Ricci curvature of graphs, *Tohoku Math. J. (2)* 63 (4) (2011) 605–627.
doi:[10.2748/tmj/1325886283](https://doi.org/10.2748/tmj/1325886283).
190 URL <https://doi.org/10.2748/tmj/1325886283>
- [5] B. B. Bhattacharya, S. Mukherjee, Exact and asymptotic results on coarse ricci curvature of graphs, *Discrete Mathematics* 338 (1) (2015) 23 – 42. doi:<http://dx.doi.org/10.1016/j.disc.2014.08.012>.
URL <http://www.sciencedirect.com/science/article/pii/S0012365X14003252>
- [6] F. Bauer, F. Chung, Y. Lin, Y. Liu, Curvature aspects of graphs, *Proceedings of the American*
195 *Mathematical Society* 145 (5) (2017) 2033–2042. doi:[10.1090/proc/13145](https://doi.org/10.1090/proc/13145).
URL <http://www.ams.org/journals/proc/2017-145-05/S0002-9939-2017-13145-1/>
- [7] H. J. Cho, S.-H. Paeng, Olliviers ricci curvature and the coloring of graphs, *European Journal of Combinatorics* 34 (5) (2013) 916 – 922.
doi:<http://dx.doi.org/10.1016/j.ejc.2013.01.004>.
200 URL <http://www.sciencedirect.com/science/article/pii/S0195669813000127>
- [8] C. C. Ni, Y. Y. Lin, J. Gao, X. D. Gu, E. Saucan, Ricci curvature of the internet topology, in: *2015 IEEE Conference on Computer Communications (INFOCOM)*, 2015, pp. 2758–2766.
doi:[10.1109/INFOCOM.2015.7218668](https://doi.org/10.1109/INFOCOM.2015.7218668).