

Abstract

New methods for finding submatrices of (locally) maximal volume and large projective volume are proposed and studied. Detailed analysis is also carried out for existing methods. The effectiveness of the new methods is shown in the construction of cross approximations, and estimates are also proved in the case of their application for the search for a strongly nondegenerate submatrix. Much attention is also paid to the choice of the starting submatrix.

Keywords: Low-rank approximations; Pseudoskeleton approximations; Maximum volume principle

Rectangular maximum volume and projective volume search algorithms.

Osinsky A.I. ^{*1,2,3}

¹Moscow Institute of Physics and Technology, Dolgoprudny, Institutsky per.,
9, Russia

²Institute of Numerical Mathematics RAS, Moscow, Gubkina str., 8, Russia

³Skolkovo Institute of Science and Technology Bolshoy Boulevard 30, bld. 1
Moscow, Russia

April 12, 2019

1 Introduction

In this paper, we study algorithms aimed at finding submatrices of large volume and projective volume. The volume and the projective (r -projective) volume for an arbitrary matrix $A \in \mathbb{C}^{M \times N}$ are defined as follows:

$$V(A) = \text{vol}(A) = \mathcal{V}_2(A) = \prod_{i=1}^{\min(M,N)} \sigma_i(A),$$

$$\mathcal{V}_2^r(A) = \prod_{i=1}^r \sigma_i(A),$$

where $\sigma_i(A)$ are singular values of A in descending order (see Notations subsection).

The submatrices with close to the maximum volume (or projective volume) are known to yield precise cross approximations [1, 2, 3]. Especially we pay attention to the projective volume, which guarantees better cross approximation accuracy estimates. High accuracy is confirmed in the numerical experiments.

An essential feature of the cross approximations is the use of a small part of matrix elements. This requires efficient algorithms for large volume (or large projective volume) submatrix search.

Since the maximum volume submatrix search is an NP-complete problem, in practice much simpler computational algorithms are used. One such algorithm is called maxvol [5]

*a.osinskiy@skoltech.ru

(see algorithm 2). It finds a square submatrix of locally maximal volume [4] also called dominant [5]. We will use the same definition for the rectangular submatrices.

Definition 1 ([4], [5]). A submatrix $\hat{A} \in \mathbb{C}^{m \times n}$ at the intersection of the rows $R \in \mathbb{C}^{M \times n}$ and columns $C \in \mathbb{C}^{m \times N}$ of the matrix $A \in \mathbb{C}^{M \times N}$ is called dominant or said to have a locally maximum volume if the volume of \hat{A} does not increase by swapping one of its rows with another row from C or one of its columns with another column from R .

The notion of locally maximum projective volume is defined the same way: the projective volume should not increase with any single swap of rows or columns.

In practice, dominant submatrices are often in “good” rows and columns for the cross approximation. Moreover, there are estimates on the norm of the pseudoinverse matrix guaranteeing that dominant submatrices are relatively well conditioned.

Our algorithm `maxvol-rect` (algorithm 6) finds a dominant rectangular submatrix and it produces the same results as `maxvol` when searching for a square submatrix. This is the main difference of our algorithm from rectangular greedy maximum volume search algorithm `maxvol2` [11] (see also algorithm 3 in section 2) later renamed as `rect_maxvol` [12], which adds rows to increase the 2-volume (thus the original name) and never swaps them. We will stick to the original name when discussing this algorithm.

It was already used to construct cross approximations based on large projective volume in [3], and we will also use it that way. Later, in [12], another approach was proposed, but it requires the knowledge of SVD and leads to an additional factor of two in the estimates, so we will not use it.

We also derive a faster version of `maxvol2`, which uses Householder reflections for the updates (Algorithm 9 in the Appendix). We will refer to the new version as “Householder-based `maxvol2`” while saying “original `maxvol2`” when referring to the original update formulas.

In this paper, we also consider another generalization of the `maxvol` algorithm called `maxvol-proj` (algorithm 7), which searches for large projective volume submatrices.

The main idea of the proposed algorithm for large projective volume is to search for “good” rows and columns separately. Since the sought-for $m \times n$ submatrix is expected to be “good” only in the sense of its largest r singular values, it is possible to start with $r \times n$ and $m \times r$ submatrices of large volume.

A choice of the starting submatrix is studied in detail, which provides a restriction on the number of row or column exchanges in the algorithms.

In the current section, we introduce the necessary notation and give Lemmas concerning the volume, projective volume, and dominant submatrices.

In section 2, the algorithms are constructed and briefly described. Detailed versions can be found in the appendix.

In section 3, the numerical experiments on random matrices are carried out. The results confirm the hypothesis of high low-rank approximation accuracy in the Frobenius norm.

1.1 Notations

Before proceeding further, we formulate the basic notation concerning column and cross approximations.

A usually denotes the original matrix. Its size is $M \times N$, unless otherwise specified.

\hat{A} is used to denote a submatrix of A , whose rows and columns generate a CGR-approximation (also called CUR [17]).

Definition 2. An approximation of the matrix $A \in \mathbb{C}^{M \times N}$ is called CGR if it is described as a product of some of the columns $C \in \mathbb{C}^{M \times n}$ and rows $R \in \mathbb{C}^{m \times N}$ of the matrix A and an arbitrary matrix $G \in \mathbb{C}^{m \times n}$ called a generator:

$$A \approx CGR.$$

Matrices U and V everywhere further contain orthonormal rows or columns. Although they can be rectangular, we shall also call them “unitary”. They often arise from the singular value decomposition for a matrix $A \in \mathbb{C}^{M \times N}$ of rank R as follows:

$$\begin{aligned} A &= U\Sigma V, \\ U &\in \mathbb{C}^{M \times R}, \\ \Sigma &= \text{diag}(\sigma_1, \dots, \sigma_R), \quad \sigma_1 \geq \sigma_2 \geq \dots \geq \sigma_R, \\ V &\in \mathbb{C}^{R \times N}. \end{aligned}$$

Then $\hat{U} \in \mathbb{C}^{n \times R}$ and $\hat{V} \in \mathbb{C}^{R \times n}$ denote some submatrices corresponding to n rows R and columns C of A . $\sigma_i = \sigma_i(A)$ are singular values of the matrix A in the descending order.

The approximation rank is denoted by r .

For an arbitrary matrix B of rank at least r , the matrices B_r and B_r^+ (the latter is called r -pseudoinverse of B) are defined in terms of the singular value decomposition $B = U\Sigma V$ as follows:

$$\begin{aligned} B_r &= U\Sigma_r V, \quad \sigma_i(\Sigma_r) = \begin{cases} \sigma_i(\Sigma), & \text{if } i \leq r, \\ 0, & \text{otherwise.} \end{cases} \\ B_r^+ &= V^* \Sigma_r^+ U^*, \quad \sigma_i(\Sigma_r^+) = \begin{cases} \sigma_i^{-1}(\Sigma), & \text{if } i \leq r, \\ 0, & \text{otherwise.} \end{cases} \end{aligned}$$

Thus B_r is the best rank- r approximation of B with respect to the 2-norm and the Frobenius norm. If r coincides with the rank of B , we can write B^+ (exact pseudoinverse) instead of B_r^+ . r -pseudoinversion is further mainly used for submatrices of a large projective volume to construct a pseudo-skeleton approximation.

The range of natural numbers $\{1, 2, 3, \dots, n\}$ is denoted by $\overline{1, n}$. The equality $\forall i = \overline{1, n}$ means that i is an arbitrary value from the range.

1.2 Properties of extreme submatrices

This subsection describes the main properties of submatrices with a locally maximal volume or projective volume, proved in [3]. Naturally, properties of the projective volume are also valid for volume.

Lemma 1 ([3]). *For an arbitrary $r \leq \min(m, n)$, the submatrix $\hat{A} \in \mathbb{C}^{m \times n}$ of the matrix $A = \begin{bmatrix} \hat{A} & \mathbf{b} \end{bmatrix} \in \mathbb{C}^{m \times (n+1)}$ with the locally maximal r -projective volume in A and the submatrix $\hat{U} \in \mathbb{C}^{m \times n}$ of the matrix $U \in \mathbb{C}^{m \times N}$, $UU^* = I$ with the locally maximal r -projective volume in U , the following properties hold:*

1. *For the r -projective volume of \hat{A}*

$$\mathcal{V}_2^r(\hat{A}) \sqrt{1 + \|\hat{A}_r^+ \mathbf{b}\|_2^2} \leq \mathcal{V}_2^r(A) \leq \mathcal{V}_2^r(\hat{A}) \sqrt{\frac{n+1}{n-r+1}}.$$

This implies

$$\|\hat{A}_r^+ \mathbf{b}\|_2^2 \leq \frac{r}{n-r+1}.$$

2. *For the norms of the r -pseudoinverse*

$$\|\hat{U}_r^+\|_2 \leq \sqrt{1 + \frac{r(N-n)}{n-r+1}},$$

$$\|\hat{U}_r^+\|_F \leq \sqrt{r + \frac{r(N-n)}{n-r+1}},$$

The second property is especially important since the cross approximation accuracy is affected by the properties of some submatrices of unitary matrices.

The next theorem shows that the locally maximal volume of long rectangular submatrices is close to the globally maximal volume, which may be false for square submatrices.

Theorem 1. *Let $\hat{A} \in \mathbb{C}^{n \times r}$ be a submatrix of $A \in \mathbb{C}^{N \times r}$ with the maximal (nonzero) volume among all the submatrices, which differ from \hat{A} in a single row. Let $A_M \in \mathbb{C}^{n \times r}$ be a submatrix with the maximal volume in A . Then*

$$\mathcal{V}_2(A_M) \leq \mathcal{V}_2(\hat{A}) \cdot \left(\frac{n+1}{n-r+1} \right)^{r/2}. \quad (1)$$

Proof. Without loss of generality let the rows of \hat{A} coincide with the first n rows of A . In justifying the Dominant-C algorithm (algorithm 4) in section 2, we show the following. If the j -th row of \hat{A} is replaced by the i -th row of A then the ratio of the new volume V_{new} to the old one $V_{\text{old}} = \mathcal{V}_2(\hat{A})$ equals

$$V_{\text{new}}/V_{\text{old}} = |C_{i,j}|^2 + (1 + \|C_i\|_2^2)(1 - \|C_j\|_2^2), \quad (2)$$

where $C = A\hat{A}^+ \in \mathbb{C}^{N \times n}$.

Every submatrix of C now has rank r , so it is natural to search for the maximal r -projective volume submatrix in C . Moreover, it corresponds to the maximal volume submatrix in A . Let an arbitrary submatrix $\tilde{C} \in \mathbb{C}^{n \times n}$ of C correspond to the submatrix $\tilde{A} \in \mathbb{C}^{n \times r}$ in A . With QR factorization of \hat{A} : $\hat{A} = QR \in \mathbb{C}^{n \times r}$, $R \in \mathbb{C}^{r \times r}$, we see that

$$\mathcal{V}_2^r(\tilde{C}) = \mathcal{V}_2^r(\tilde{A}\hat{A}^+) = \mathcal{V}_2^r(\tilde{A}R^{-1}Q^*) = \mathcal{V}_2^r(\tilde{A}R^{-1}) = \mathcal{V}_2(\tilde{A}R^{-1}) = \mathcal{V}_2(\tilde{A})\mathcal{V}_2(R^{-1}) = \mathcal{V}_2(\tilde{A})\mathcal{V}_2(\hat{A}^+).$$

So all volumes are just multiplied by $\mathcal{V}_2(\hat{A}^+)$. We denote the submatrices in C , corresponding to \hat{A} and A_M as \hat{C} and C_M .

So now we have some matrix C , which contains submatrix \hat{C} with locally maximum projective volume and submatrix C_M with the maximum projective volume. Our task will be to estimate $\|C_M\|_F$ in this matrix. We are not going to make any swaps of the rows in A or C and so will not change C in any way.

First, we estimate the squared 2-norm of the j -th row of C , denoted by l_j . Let $x = \max_i l_i$. Since we start from the locally maximum volume submatrix, the right hand side in (2) does not exceed 1, which means the second term $(1 + \|C_i\|_2^2)(1 - \|C_j\|_2^2) = (1 + l_i)(1 - l_j)$ is also not greater than one. With substitution $l_i = x$ we find that

$$\forall j = \overline{1, n}: (1 - l_j)(1 + x) \leq 1$$

and therefore

$$\forall j = \overline{1, n}: l_j \geq \frac{x}{1 + x}. \quad (3)$$

Let A_M contain $k > 0$ rows from \hat{A} . The sum of the squared lengths of all rows in C corresponding to \hat{A} (that is, rows of \hat{C}) equals r . On the other hand, the sum of squared 2-norms of the rest $n - k$ rows, according to (3) is at least $(n - k)\frac{x}{1 + x}$. So the Frobenius norm of the shared rows is at most

$$r - (n - k)\frac{x}{1 + x}.$$

Then the squared Frobenius norm of C_M is bounded by

$$\|C_M\|_F^2 \leq (n - k)x + (r - (n - k)\frac{x}{1 + x}) = r - (n - k)\frac{x^2}{1 + x}.$$

The maximum of this expression is achieved at $k = 1$. Then

$$\|C_M\|_F^2 \leq r + \frac{x^2(n - 1)}{1 + x}.$$

This expression grows with increasing x . Choosing the maximum according to item 1 of the Lemma 1 value $x = \frac{r}{n - r + 1}$, we get

$$\|C_M\|_F^2 \leq r + \frac{r^2(n - 1)}{(n - r + 1)(n + 1)} \leq r \frac{n + 1}{n - r + 1}.$$

In the case $k = 0$, using item 1 of the Lemma 1 again for n rows of C , we obtain

$$\|C_M\|_F^2 \leq n \frac{r}{n - r + 1},$$

which is lower than the previous estimate.

The maximum projective volume is achieved in case of equal r singular values. This means they are all equal to $\sqrt{\frac{n+1}{n-r+1}}$, which proves (1). \square

Corollary 1. For $n \geq \frac{r^2}{2} + r - 1$, the volume ratio of the maximum volume submatrix to any locally maximum volume submatrix is bounded by $(1 + 2/r)^{r/2} \leq e = \text{const.}$

At last, we give one more significant property.

Lemma 2 ([6]). *For an arbitrary matrix $A \in \mathbb{C}^{M \times N}$ and any $r \leq \min(M, N)$, the following identity holds*

$$\sum_{T, |T|=r} \mathcal{V}^2(A_T) = \sum_{1 \leq t_1 < t_2 < \dots < t_r \leq \min\{M, N\}} \sigma_{t_1}^2 \sigma_{t_2}^2 \dots \sigma_{t_r}^2 \geq (\mathcal{V}_2^r(A))^2, \quad (4)$$

where the sum is taken over all sets of r indices $T = \{t_1, \dots, t_r\}$. A_T are the rows of the matrix A with indices from T , and $\sigma_1 \geq \sigma_2 \geq \dots \geq \sigma_{\min\{M, N\}}$ are the singular values of the matrix A .

The inequality in (4) is obtained by taking into account only the first summand.

2 Algorithms

The primary intention of this section is to obtain and to justify new algorithms. In particular, an algorithm for finding dominant rectangular submatrices is discussed. We estimate the iteration numbers and the computational complexity of each algorithm. The complete descriptions with update formulas are given in the Appendix.

All the basic algorithms use fast updates to replace one of the rows or columns of the current submatrix. The replacements are performed to increase the volume. The criteria for such exchanges are given in the current section.

Figure 1 shows the general scheme for large volume and projective volume submatrix search. All the algorithms are enumerated according to the sequence of their execution. In practice, of course, some of the steps (algorithms) can be omitted. However, additional steps can improve approximation quality and provide guarantees on the total complexity. These guarantees and estimates are discussed in the corresponding subsections. Also, algorithms on the bottom of the diagram are derived similarly to the simpler algorithms before them, so it is convenient to talk about simpler approaches first and then move on to more complex ones.

Let us briefly describe the general approach. We start from some r nondegenerate columns (which can be chosen randomly), and we want to start from a highly nondegenerate $k \times r$ submatrix in these columns to reduce the number of steps for further algorithms. This is the purpose of pre-maxvol (algorithm 1), described in subsection 2.1. Essentially, it just uses QR with pivoting. Then we can find $r \times r$ locally maximum volume submatrix with maxvol [5] (algorithm 2), described in the subsection 2.2.

If we want to find a locally maximum volume rectangular submatrix, then we, first of all, need to add some rows or columns using maxvol2 [11] (algorithm 3), described in the subsection 2.3. Note also, that we present an asymptotically faster analog in the Appendix.

Next we move on to the new algorithms.

To find locally maximum volume rectangular submatrix, we use maxvol-rect (algorithm 6), described in the subsection 2.4. It uses different criteria for updates along smaller and larger size, described in Dominant-C (algorithm 4) and Dominant-R (algorithm 5). Note that

Dominant-R uses the same criterion and similar updates to the strong rank revealing QR, described in [8].

Finally, in the subsection 2.5, rectangular locally maximum volume submatrices are used to find large projective volume submatrix of arbitrary size (see `maxvol-proj`, algorithm 7).

After all the algorithms are presented, we discuss possible improvements and simplifications in the subsection 2.6 and make a comparison with other subset selection algorithms in the subsection 2.7.

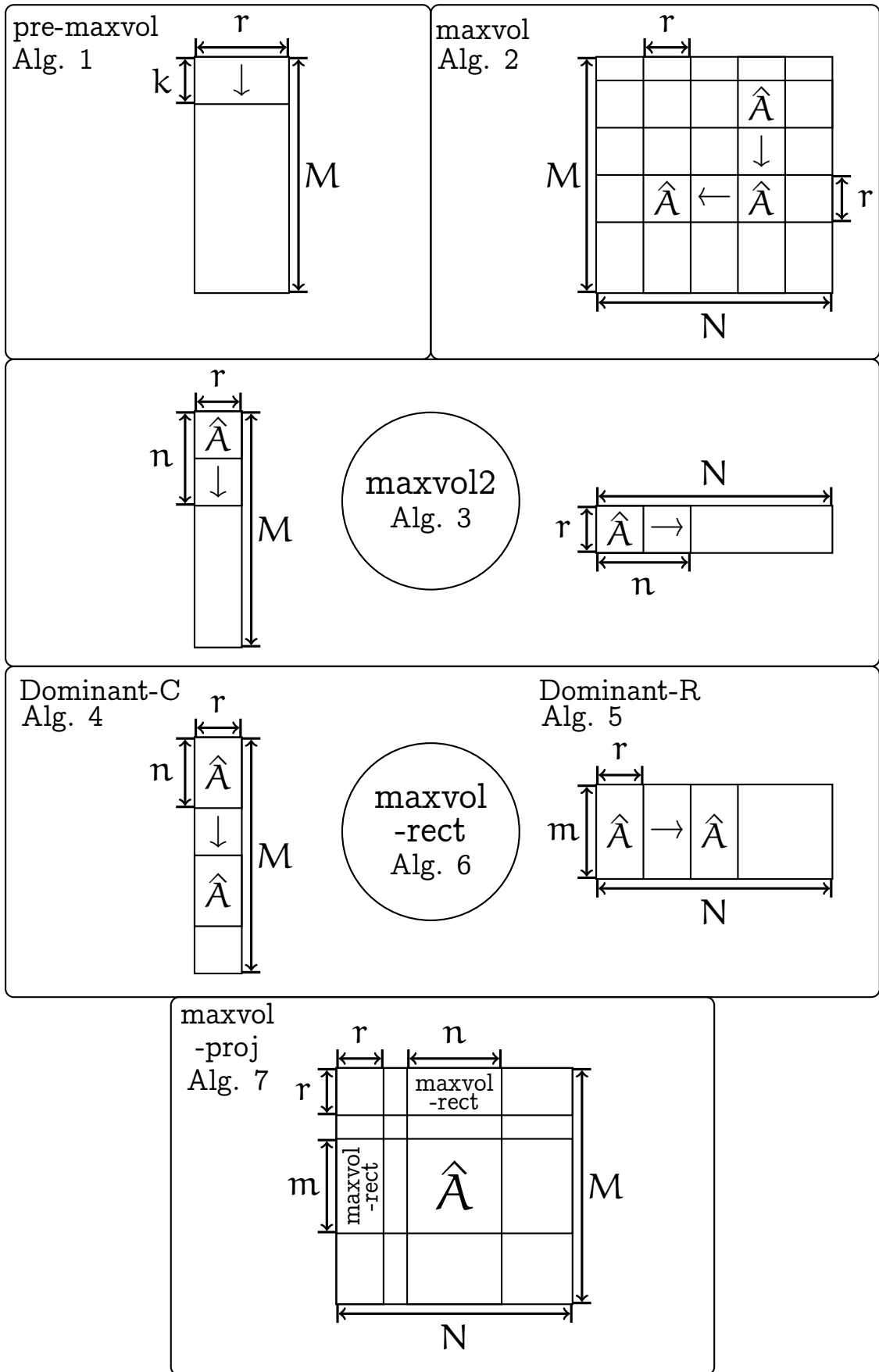

Figure 1: General maximum volume and projective volume search scheme. Algorithms are enumerated according to the execution order and appearance in the text. Arrows show the new (appended) rows or columns (pre-maxvol, maxvol2) or changes of the current submatrix \hat{A} (maxvol, maxvol-rect).

2.1 How to start

Our first task is to select some rows, corresponding to a submatrix with a sufficiently large volume so that we can decrease the number of steps for further algorithms (see figure 2). To do it, we can construct RRQR (rank-revealing QR) via Householder reflections with column pivoting. This algorithm, called QRP, iteratively adds a new row/column corresponding to the row/column of the current error with the largest 2-norm (for a detailed description, see [7], page 278). An alternative version of this algorithm, which we call *pre-maxvol*, is presented in the Appendix. *Pre-maxvol* is sufficient to obtain a submatrix with a volume that differs from the maximum volume submatrix by no more than $r!$ times (see proposition 1).

The ratio of the new volume to the old one is equal to the length of the new row in the orthogonal complement to the already selected rows. These squared lengths will be stored in a vector γ .

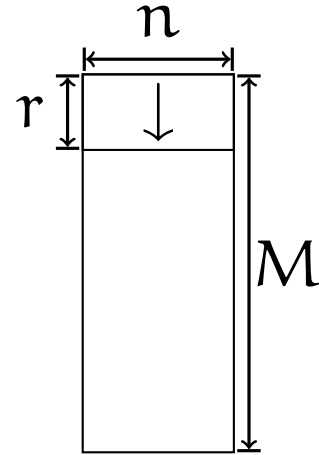

Figure 2: *pre-maxvol*: construction of $\hat{A} = A_{\mathcal{I},:}$. Pay attention to the notations for the number of rows and columns.

Algorithm 1 *pre-maxvol* (The full version is a modification of the addition of rows in RRQR from [8])

Input: Matrix $A \in \mathbb{R}^{M \times n}$, required rank r .

Output: Set of row indices \mathcal{I} of cardinality r , containing a submatrix with volume no more than $r!$ less than the maximum.

- 1: $\mathcal{I} := \emptyset$
 - 2: **for** $i := 1$ to M **do**
 - 3: $\gamma_i := \|A_{i,:}\|_2^2$
 - 4: **end for**
 - 5: **for** $k := 1$ to r **do**
 - 6: Select j , corresponding to $\max_j \gamma_j$
 - 7: $\mathcal{I} := \mathcal{I} \cup \{j\}$
 - 8: Update elements of γ : squared lengths of rows of A after projection on the orthogonal complement to the rows in \mathcal{I}
 - 9: **end for**
-

The complexity of *pre-maxvol* is $O(Mnr)$ for $A \in \mathbb{C}^{M \times n}$.

The following statement was first proved in [9], where the greedy addition of rows was also investigated. Here we give a simpler proof using the projective volume.

Proposition 1 ([9]). *The algorithm pre-maxvol finds a submatrix with the volume not more than $r!$ times smaller than the maximum.*

Proof. We yield a proof by induction on r . The base $r = 1$ is obvious. Let us suppose that the proposition is true for an algorithm with $r - 1$ rows and prove the induction step.

Let \mathbf{a} be the longest row in A . Then there is a submatrix in $\hat{A} \in \mathbb{C}^{r \times n}$, which contains \mathbf{a} and such that

$$\frac{\mathcal{V}(\hat{A})}{\mathcal{V}(A_M)} \geq \frac{1}{r}, \quad (5)$$

where $A_M \in \mathbb{C}^{r \times n}$ is the maximum volume submatrix. If \mathbf{a} is contained in A_M , then (5) is true for $\hat{A} = A_M$. Otherwise consider a submatrix $A' = \begin{bmatrix} \mathbf{a} \\ A_M \end{bmatrix} \in \mathbb{C}^{(r+1) \times n}$, which is obtained by adding \mathbf{a} to A_M . From item 1 of Lemma 1 we have

$$\frac{(\mathcal{V}_2^r(A'))^2}{(\mathcal{V}_2^r(A_M))^2} \geq 1 + \|A_M^+ \mathbf{a}\|_2^2,$$

where we have pseudoinverse instead of r -pseudoinverse, because $\text{rank } A_M = r$. On the other hand, from Lemma 2

$$\sum_{T, |T|=r} (\mathcal{V}_2(A_T))^2 \geq (\mathcal{V}_2^r(A'))^2,$$

so

$$\frac{\sum_{T, |T|=r} (\mathcal{V}_2(A_T))^2}{(\mathcal{V}_2^r(A_M))^2} \geq \frac{(\mathcal{V}_2^r(A'))^2}{(\mathcal{V}_2^r(A_M))^2} \geq 1 + \|A_M^+ \mathbf{a}\|_2^2.$$

Next,

$$1 + \|A_M^+ \mathbf{c}\|_2^2 \geq 1 + \frac{\|\mathbf{c}\|_2^2}{\|A_M\|_F^2} \geq 1 + \frac{\|\mathbf{c}\|_2^2}{\|A_M\|_F^2} \geq 1 + \frac{1}{r},$$

since \mathbf{c} is not smaller than any row of A_M . Thus, the sum of the squared volumes of all the submatrices in A' is not less than $1 + 1/r$. By subtracting the volume of A_M , the sum of squared volumes of the remaining r submatrices is estimated as at least $1/r$. This fact implies that the squared volume of some submatrix is at least $1/r^2$ and proves (5).

It remains to use the induction hypothesis to see that the algorithm eventually finds a submatrix $A_a \in \mathbb{C}^{r \times n}$ containing \mathbf{a} , such that

$$\frac{\mathcal{V}(A_a)}{\mathcal{V}(\hat{A})} \geq \frac{1}{(r-1)!}. \quad (6)$$

Indeed, let us follow the algorithm and change A by replacing all the rows, starting from the second with their orthogonal complements to \mathbf{a} . Any $r \times n$ submatrix containing \mathbf{a} has a volume, equal to $\|\mathbf{a}\|_2$ times the volume of the remaining $r-1$ rows of this submatrix. $\frac{\mathcal{V}_2(\hat{A})}{\|\mathbf{a}\|_2}$ is not greater than maximum volume in the orthogonal complement, so the volume of these $r-1$ rows is bounded from below by $\frac{\mathcal{V}_2(\hat{A})}{(r-1)! \|\mathbf{a}\|_2}$ by the induction hypothesis, which proves (6). Combining (5) and (6) proves the proposition. \square

2.2 Square locally maximum volume search

We move on to the maxvol algorithm (see figure 3). It selects the $r \times r$ submatrix of large volume.

The main idea of `maxvol` is to find a dominant submatrix. We remind that a submatrix is called dominant if replacing any single row (column) by another row (column) of the matrix does not increase its volume. The criterion for submatrix dominance comes from the following Lemma.

Lemma 3 (see proof of Lemma 1 in [5]). *Let $\hat{A} \in \mathbb{C}^{r \times r}$ be a submatrix in the first r rows of the matrix $A \in \mathbb{C}^{M \times r}$. Then, replacing the j -th row of the submatrix \hat{A} with the i -th row of A ($i > r$) changes the squared volume of \hat{A} equal to $V_{\text{old}} = \mathcal{V}_2(\hat{A})$ as*

$$V_{\text{new}}^2/V_{\text{old}}^2 = |C_{ij}|^2,$$

$$C = A\hat{A}^{-1} \in \mathbb{C}^{M \times r}.$$

It immediately follows that the $r \times r$ submatrix in fixed r columns is dominant if and only if all absolute values of the elements in C do not exceed 1, that is, $\|C\|_C \leq 1$. If this inequality is not satisfied, one can replace the rows.

Algorithm 2 `maxvol` [5]

Input: Matrix $A \in \mathbb{C}^{M \times N}$, starting sets of row indices \mathcal{I} and column indices \mathcal{J} of cardinality r . For example, $\mathcal{I} = \mathcal{J} = \{1, \dots, r\}$.

Output: The row and column indices of the dominant submatrix of rank r written in \mathcal{I} and \mathcal{J} .

```

1: while replacements occur do
2:   for changes_in in in  $\{\mathcal{I}, \mathcal{J}\}$  do
3:      $C := A_{:, \mathcal{J}} A_{\mathcal{I}, \mathcal{J}}^{-1}$  if we change the selected set of rows  $\mathcal{I}$ 
4:      $C := (A_{\mathcal{I}, \mathcal{J}}^{-1} A_{\mathcal{I}, :})^*$  if we change the selected set of columns  $\mathcal{J}$ 
5:     Select  $i$  and  $j$  corresponding to  $\max_{i,j} |C_{i,j}|$ 
6:     while  $|C_{i,j}| > 1$  do
7:       Update  $C$ 
8:       Replace index  $j$  with  $i$  in the set  $\text{changes\_in}$  (in either  $\mathcal{I}$  or  $\mathcal{J}$ )
9:       Select  $i$  and  $j$  corresponding to  $\max_{i,j} |C_{i,j}|$ 
10:    end while
11:   end for
12: end while

```

The algorithm complexity is $O((M+N)r \cdot \text{iter} + (M+N)r^2 \cdot \text{IT})$ operations. Here `iter` denotes the total number of replacements of rows and columns, that is, the number of iterations of “while” loop on the line 6; and `IT` is the number of passes through rows and columns, that is, the total number of iterations of the “for” loop (line 2).

In practice $|C_{i,j}|$ is compared to $c = 1 + \varepsilon$ for small ε . This avoids instability and, as we will see below, allows to limit the number of row/column replacements.

So, let $|C_{i,j}|$ be compared with some constant $c > 1$ in the line 6. In this case, the algorithm no longer produces a dominant submatrix. However, the volume of the resulting submatrix differs by no more than c times from the volume of any submatrices that differs in a single row or column.

Let us denote by Γ the ratio of the maximum volume to the volume of the starting submatrix. Then for $\Gamma = (\alpha^2 r)^{r/2}$ we can guarantee the convergence to locally maximum volume submatrix within the corresponding rows or columns in

$$k = \left\lceil \frac{\ln \Gamma}{\ln c} \right\rceil - 1$$

steps. Indeed, the C-norm of rows of the matrix C cannot be greater than the ratio of the current volume to the maximum one, and this ratio for each iteration drops by at least c times.

If $\alpha \leq c$, we need no more than

$$k_1 = \left\lceil r \frac{\ln c^2 r}{2 \ln c} \right\rceil - 1 \leq \left\lceil r \left(1 + \frac{\ln r}{2 \ln c} \right) \right\rceil - 1$$

steps.

Let $\alpha > c$. Let us denote Γ_k the volume ratio after k steps and $\alpha_k = \frac{\Gamma_k^{1/r}}{\sqrt{r}}$. Then the C-norm of some row is at least α_k , because otherwise the 2-norms of all the rows are less than $\alpha_k \sqrt{r}$ and the volume ratio is less than $(\alpha_k \sqrt{r})^r = \Gamma_k$. By Lemma 3

$$\begin{aligned} \Gamma_{k+1} &\leq \Gamma_k / \alpha_k, \\ \alpha_{k+1}^r &\leq \alpha_k^r / \alpha_k, \\ \alpha_{k+1} &\leq \alpha_k / \alpha_k^{1/r} = \alpha_k^{1 - \frac{1}{r}}. \end{aligned}$$

If we start from $\alpha_0 = \alpha$, then after k steps

$$\alpha_k \leq \alpha^{(1 - \frac{1}{r})^k}.$$

Assume α becomes less or equal to c after k_2 iterations. Then we get the following condition:

$$\begin{aligned} \alpha^{(1 - \frac{1}{r})^{k_2}} &\leq c, \\ k_2 &= \left\lceil \frac{\ln \frac{\ln c}{\ln \alpha}}{\ln(1 - \frac{1}{r})} \right\rceil = \left\lceil \frac{\ln \frac{\ln \alpha}{\ln c}}{\ln(\frac{r}{r-1})} \right\rceil \leq \left\lceil r \ln \frac{\ln \frac{r^{2/r}}{r}}{\ln c} \right\rceil. \end{aligned} \quad (7)$$

Adding k_1 , in view of the rounding, we obtain

$$k \leq r \left(1 + \frac{\ln r}{2 \ln c} + \max \left(0, \ln \frac{\ln \frac{r^{2/r}}{r}}{\ln c} \right) \right). \quad (8)$$

Let's consider how big the ratio Γ can be for a randomly selected starting submatrix. Let us apply the maxvol algorithm to a matrix with randomly distributed matrices of left and

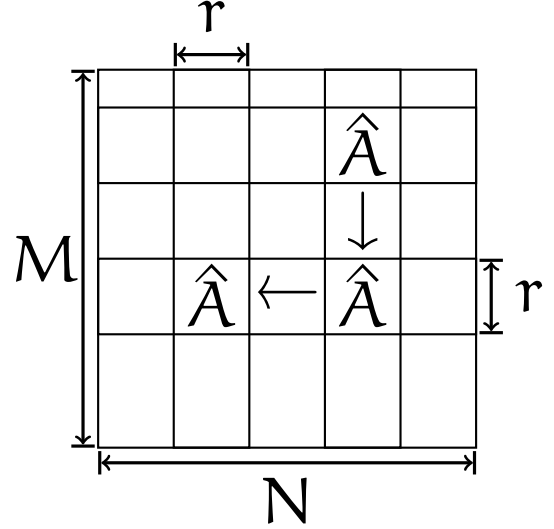

Figure 3: Change of the current submatrix $\hat{A} = A_{\mathcal{I}, \mathcal{J}}$ when the algorithm maxvol is executed.

right singular vectors. Since the Gaussian matrices are unitary invariant and Γ equals the volume ratio, the current matrix C can be considered Gaussian, multiplied by some $r \times r$ matrix, which does not affect the volume ratios.

The probability of the volume of a random Gaussian matrix to differ from its expectation is exponentially small. Even though the maximum is taken over $M^r N^r$ different matrices, we obtain with a high probability $\Gamma = O(r^r \ln^r MN)$. If $c = \text{const} > 1$, the substitution in (8) yields

$$k = O(r(\ln r + \ln \ln \ln MN)) \approx O(r \ln r)$$

and $\text{iter} \approx O(r \ln r \cdot IT)$.

Of course, it is better to have a guarantee on Γ . We already have a guarantee $\Gamma \leq r!$ from the proposition 1.

Thus if we apply `pre-maxvol` beforehand,

$$k_2 \leq \left\lceil r \ln \frac{\ln r}{\ln c} \right\rceil.$$

The asymptotics of the number of steps `maxvol` takes is then dominated by k_1 , so

$$\text{iter} = O(r \ln r \cdot IT)$$

is guaranteed when $c = \text{const} > 1$.

In practice, the starting submatrix for `maxvol` is instead often chosen using the Bebdorf cross algorithm [10], which is equivalent to incomplete Gaussian elimination with partial pivoting. Although the upper bound for elements in C in this algorithm is 2^r , it is usually enough. Indeed, we have $\Gamma \leq r^{r/2} \cdot 2^{r^2}$ and the expression for the additional number of steps k_2 (7) provides that for $c = O(1)$ even such an estimate on the starting submatrix does not spoil the asymptotics for the number of permutations in `maxvol`.

2.3 How to add more rows or columns

Now consider the addition of rows after r -th one, which is performed by [11] (see figure 4). As in `pre-maxvol`, the row lengths provide the addition criterion.

Lemma 4 ([11]). *Let $\hat{A}_0 \in \mathbb{C}^{n \times r}$ be a submatrix in the first n rows of the matrix $A \in \mathbb{C}^{M \times r}$. Then adding i -th row of A to the submatrix \hat{A}_0 changes the squared volume of \hat{A}_0 as*

$$\mathcal{V}_2(\hat{A})^2 / \mathcal{V}_2(\hat{A}_0)^2 = 1 + (l_0)_i = 1 + \|(C_0)_{i,:}\|_2^2,$$

where

$$C_0 = A \hat{A}_0^+ \in \mathbb{C}^{M \times n}.$$

The original `maxvol2` algorithm [11] is presented below including the derivation of the update formulas.

We start with the notation. Again, we deal with the matrix $A \in \mathbb{C}^{M \times r}$. Its submatrix $\hat{A} \in \mathbb{C}^{(n+1) \times r}$ expands the submatrix $\hat{A}_0 \in \mathbb{C}^{n \times r}$ by appending a row $\mathbf{a}^* = A_{i,:}$.

$$\hat{A} = \begin{bmatrix} \hat{A}_0 \\ \mathbf{a}^* \end{bmatrix}.$$

In order to add a row maximizing the volume, we should be able to update the matrix $C_0 \in \mathbb{C}^{M \times n}$ and the squared 2-norms of its rows. They are stored in a vector $l_0 \in \mathbb{C}^M$. For this we define a matrix $C \in \mathbb{C}^{M \times n}$ and a column $C' \in \mathbb{C}^M$ as follows:

$$A\hat{A}^+ = \begin{bmatrix} C & C' \end{bmatrix}, \quad \hat{A} = \begin{bmatrix} \hat{A}_0 \\ \mathbf{a}^* \end{bmatrix}.$$

They can also be expressed as

$$C = A(\hat{A}^* \hat{A})^{-1} \hat{A}_0^*, \quad C' = A(\hat{A}^* \hat{A})^{-1} \mathbf{a} \quad (9)$$

Our task is to calculate C and C' on the basis of C_0 . The expression (9) shows that it is sufficient to find $(\hat{A}^* \hat{A})^{-1}$. Since

$$\hat{A}^* \hat{A} = \hat{A}_0^* \hat{A}_0 + \mathbf{a} \mathbf{a}^* = (\hat{A}_0^* \hat{A}_0) \left(I + (\hat{A}_0^* \hat{A}_0)^{-1} \mathbf{a} \mathbf{a}^* \right),$$

then for the inverse

$$\begin{aligned} (\hat{A}^* \hat{A})^{-1} &= (\hat{A}_0^* \hat{A}_0)^{-1} \left(I + (\hat{A}_0^* \hat{A}_0)^{-1} \mathbf{a} \mathbf{a}^* \right)^{-1} \\ &= (\hat{A}_0^* \hat{A}_0)^{-1} \left(I - \frac{(\hat{A}_0^* \hat{A}_0)^{-1} \mathbf{a} \mathbf{a}^*}{1 + \mathbf{a}^* (\hat{A}_0^* \hat{A}_0)^{-1} \mathbf{a}} \right). \end{aligned} \quad (10)$$

The expression in the brackets can be simplified by introducing the notation $\mathbf{c}^* = C_{i,:}$. Indeed,

$$\begin{aligned} \mathbf{c}^* &= C_{0i,:} = A_{i,:} \hat{A}_0^+ = \mathbf{a}^* (\hat{A}_0^* \hat{A}_0)^{-1} \hat{A}_0^*, \\ \mathbf{c}^* \mathbf{c} &= \mathbf{a}^* (\hat{A}_0^* \hat{A}_0)^{-1} \hat{A}_0^* \hat{A}_0 (\hat{A}_0^* \hat{A}_0)^{-1} \mathbf{a} = \mathbf{a}^* (\hat{A}_0^* \hat{A}_0)^{-1} \mathbf{a}. \end{aligned}$$

Also,

$$(\hat{A}_0^* \hat{A}_0)^{-1} \mathbf{a} \mathbf{a}^* = \mathbf{a} \mathbf{a}^* (\hat{A}_0^* \hat{A}_0)^{-1}.$$

Substituting into (10) gives

$$(\hat{A}^* \hat{A})^{-1} = (\hat{A}_0^* \hat{A}_0)^{-1} \left(I - \frac{\mathbf{a} \mathbf{a}^* (\hat{A}_0^* \hat{A}_0)^{-1}}{1 + \mathbf{c}^* \mathbf{c}} \right).$$

Taking into account

$$C_0 \mathbf{c} = A(\hat{A}_0^* \hat{A}_0)^{-1} \hat{A}_0^* \hat{A}_0 (\hat{A}_0^* \hat{A}_0)^{-1} \mathbf{a} = A(\hat{A}_0^* \hat{A}_0)^{-1} \mathbf{a},$$

one can calculate C' from (9):

$$\begin{aligned} C' &= A(\hat{A}_0^* \hat{A}_0)^{-1} \left(I - \frac{\mathbf{a}^* \mathbf{a} (\hat{A}_0^* \hat{A}_0)^{-1}}{1 + \mathbf{c}^* \mathbf{c}} \right) \mathbf{a} \\ &= A(\hat{A}_0^* \hat{A}_0)^{-1} \left(\mathbf{a} - \frac{\mathbf{a} \mathbf{c}^* \mathbf{c}}{1 + \mathbf{c}^* \mathbf{c}} \right) \mathbf{a} \\ &= A(\hat{A}_0^* \hat{A}_0)^{-1} \frac{\mathbf{a}}{1 + \mathbf{c}^* \mathbf{c}} \\ &= \frac{C_0 \mathbf{c}}{1 + \mathbf{c}^* \mathbf{c}} \\ &= C_0 C_{0i,:}^* / (1 + l_i). \end{aligned}$$

We compute C similarly:

$$C = A(\hat{\Lambda}_0^* \hat{\Lambda}_0)^{-1} \left(I - \frac{\mathbf{a} \mathbf{a}^* (\hat{\Lambda}_0^* \hat{\Lambda}_0)^{-1}}{1 + \mathbf{c}^* \mathbf{c}} \right) \hat{\Lambda}_0^* \quad (11)$$

$$\begin{aligned} &= C_0 - C' \mathbf{a}^* (\hat{\Lambda}_0^* \hat{\Lambda}_0)^{-1} \hat{\Lambda}_0^* \\ &= C_0 - C' \mathbf{c}^* \\ &= C_0 - C' C_{0i,:}. \end{aligned} \quad (12)$$

Now we can directly calculate the lengths of the new rows. The updated l_0 is denoted by l .

$$\begin{aligned} l_j &= C_{j,:} C_{j,:}^* + C_j' C_j^* \\ &= (C_{0j,:} - C_j' C_{0i,:}) (C_{0j,:} - C_j' C_{0i,:})^* + |C_j'|^2 \\ &= l_{0j} - 2C_j'^* C_{0j,:} C_{0i,:}^* + |C_j'|^2 C_{0i,:} C_{0i,:}^* + |C_j'|^2 \\ &= l_{0j} - 2C_j'^* C_j' (1 + l_{0i}) + |C_j'|^2 l_{0i} + |C_j'|^2 \\ &= l_{0j} - |C_j'|^2 (1 + l_{0i}) \end{aligned}$$

We present here full version of the original `maxvol2` algorithm from [11]. We also derive a new version in the Appendix, which is based on the Householder reflections. It has a complexity $O(Mr(n-r))$ instead of $O(M(n^2-r^2))$ [12].

This algorithm extends the submatrix by greedily chosen rows to maximize the volume. The matrix C can be obtained from `maxvol` (algorithm 2) or `pre-maxvol` (algorithm 1). The transposed version can be applied to select columns in some rows R .

Also, `maxvol2` provides some guarantees on the resulting submatrix volume.

Proposition 2. *If the algorithm `maxvol2` is applied to $r \times r$ submatrix that differs in volume from the maximum among all $r \times r$ submatrices by no more than $\Gamma = c^r r^{r/2}$ times, where $c \geq 1$ (for example, after the algorithm `maxvol` with the parameter c), then after applying `maxvol2` the ratio of the maximum 2-volume V_{\max} among all $n \times r$ submatrices to the 2-volume of the found by `maxvol2` submatrix $\hat{A} \in \mathbb{C}^{n \times r}$ does not exceed*

$$V_{\max} / \mathcal{V}_2(\hat{A}) \leq \max \left(\left(e \frac{n}{r} \right)^{r/2}, (c^2 r)^{r/2} \right). \quad (13)$$

Proof. The volume ratio of each $r \times r$ submatrix to the maximum volume among $n \times r$ submatrices is not greater than $c^r r^{r/2}$ and there are $C_n^r \leq (n/r)^r$ of $r \times r$ different submatrices inside any $n \times r$ submatrix. By the Cauchy-Binet formula squared volume of $n \times r$ submatrix is equal to the sum of squared volumes of all $r \times r$ submatrices. So the volume ratio of the initial $r \times r$ submatrix to $n \times r$ submatrix of maximum volume is not greater than $c^r n^{r/2}$.

Let $x \geq 1/\sqrt{r}$. If the ratio of the current $k \times r$ ($r \leq k < n$) submatrix volume to the maximum volume among $n \times r$ submatrices is equal to $x^r n^{r/2}$, at each step the ratio of the

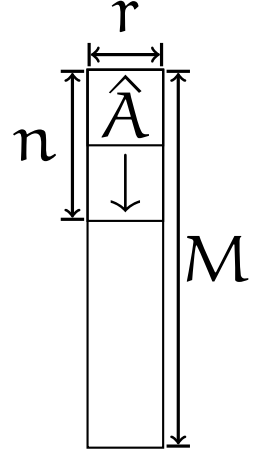

Figure 4: Extension of $\hat{A} = A_{\mathcal{I},:}$ by `maxvol2`.

Algorithm 3 Original maxvol2 [11]

Input: Matrix $A \in \mathbb{C}^{M \times r}$, the starting set of row indices \mathcal{I} of cardinality r , the required final size n .

Output: \mathcal{I} , supplemented by $n - r$ row indices chosen greedily to maximize the volume.

```
1:  $C := A[A_{\mathcal{I},:}^{-1}, 0_{r \times (n-r)}]$ 
2:  $\text{current\_order} = \{1, \dots, M\}$ 
3:  $C.\text{swap}(\mathcal{I}, \{1, \dots, r\}, \text{current\_order})$  { $C.\text{swap}(A, B, \text{order})$  swaps the elements of  $C$ , corresponding to indexes from  $A$  and  $B$  ( $A_i$  swaps with  $B_i$ ) and changes the order of corresponding indexes in order. }
4:  $l := 0_M$ 
5: for  $i := r + 1$  to  $M$  do
6:    $l_i := \|C_{i,:}\|_2^2$ 
7: end for
8: for  $\text{new\_size} := r + 1$  to  $n$  do
9:    $i := \arg \max_i l_i$ 
10:   $l'_i := 1 + l_i$ 
11:   $l_i := 0$ 
12:   $C'_i := C_{i,:}^* / l'_i$ 
13:   $C' := CC'_i$ 
14:   $C := C - C' C_{i,:}$ 
15:  for  $j := \text{new\_size}$  to  $M$  do
16:     $l_j := l_j - l'_i |C'_{ij}|^2$ 
17:  end for
18:   $C_{:, \text{new\_size}} := C'$ 
19:   $C.\text{swap}(\text{new\_size}, i, \text{current\_order})$ 
20:   $l.\text{swap}(\text{new\_size}, i)$ 
21: end for
22:  $\mathcal{I} := \text{current\_order}[1..n]$ 
```

current volume to the maximum volume decreases by no less than

$$\sqrt{1 + x^2 r} \geq x \sqrt{r}$$

times, since it is possible to take rows from the maximum volume submatrix. Hence

$$x^r n^{r/2} \leq \frac{c^r n^{r/2}}{(x \sqrt{r})^{n-r}},$$
$$c^r \geq x^n r^{\frac{n-r}{2}}.$$

If the ratio of volumes turns out to be larger than $c^r r^{r/2}$, then

$$x^r n^{r/2} > c^r r^{r/2} \geq x^n r^{n/2},$$
$$x^{n-r} < n^{r/2} / r^{n/2},$$

$$xn^{1/2} < \frac{n}{r} \cdot \left(\frac{n}{r}\right)^{\frac{r}{n-r}} \leq e \frac{n}{r},$$

which proves (13). □

2.4 Rectangular locally maximum volume search

Now we are ready to move on to the new algorithms, and we start with Dominant-C (see figure 5). The main idea is to find a dominant rectangular submatrix. Technically it is done by generalizing the updates in the original maxvol2 algorithm [11]. Because the Dominant-C searches for a locally maximum volume, it has similar properties to maxvol. For instance, the 2-norm of any row of $C \in \mathbb{C}^{M \times n}$ outside the selected ones does not exceed $\sqrt{\frac{r}{n-r+1}}$. It also makes the item 2 of Lemma 1 and the Corollary 1 true for the submatrix, found by Dominant-C.

The following Lemma provides the replacement criterion.

Lemma 5. *Let $\hat{A}_0 \in \mathbb{C}^{n \times r}$ be a submatrix in the first n rows of the matrix $A \in \mathbb{C}^{M \times r}$. Then, replacing j -th row of \hat{A}_0 by the i -th row of A (for $i > n$) changes the squared volume of \hat{A}_0 by a factor*

$$B_{ij} = |C_{0ij}|^2 + (1 + l_{0i})(1 - l_{0j}),$$

where the matrix C_0 and the vector l_0 denote the same as in the Lemma 4.

Proof. To prove the Lemma, we need to derive the fast update formulas. For this, we use the update formulas from the original maxvol2 (algorithm 3).

The update is done in 2 steps. First, we append the i -th row, and then remove j -th row. Since we already know how to append, let us only focus on the removal.

Firstly, note that appending the i -th row reduces its elements $1 + l_{0i}$ times. To check this, substitute i in the update formula for C (line 14 in the original maxvol2 algorithm). Removing the j -th row increases the elements $1 + \tilde{l}_j$ times (the tilde denotes the value after the removal).

$$\tilde{C}_{j,:} = C_{j,:}(1 + \tilde{l}_j) \tag{14}$$

From the update formula for l , we get that

$$\begin{aligned} l_j &= \tilde{l}_j - |C'_j|^2(1 + \tilde{l}_j) \\ &= \tilde{l}_j - |C_{j,:} C_{j,:}^*|^2 / (1 + \tilde{l}_j) \\ &= \tilde{l}_j - \tilde{l}_j^2 / (1 + \tilde{l}_j) \\ &= \frac{\tilde{l}_j}{1 + \tilde{l}_j}, \end{aligned}$$

which means

$$1 + \tilde{l}_j = 1 / (1 - l_j). \tag{15}$$

Using (14) and (15) we obtain a formula for the update of C :

$$\begin{aligned} C &:= \tilde{C} - C' \tilde{C}_{j,:} = \tilde{C} - C' C_{j,:} (1 + \tilde{l}_j) \\ \tilde{C} &:= C + C' C_{j,:} / (1 - l_j) \end{aligned}$$

Similarly, the update of l is calculated as

$$\begin{aligned} l_k &:= \tilde{l}_k - |C'|^2(1 + \tilde{l}_j) \\ \tilde{l}_k &:= l_k + |C'|^2/(1 - l_j) \end{aligned}$$

After adding i -th row, l_j depends on l_{0j} as:

$$l_j = l_{0j} - |C'|^2(1 + l_{0i}) = l_{0j} - |C_{0i,:}C_{0j,:}^*|^2/(1 + l_{0i}). \quad (16)$$

The product $C_{i,:}C_{j,:}^*$ is written in the element C_{ij} . Indeed,

$$C_{0i,:}C_{0j,:}^* = A_{i,:}\hat{A}_0^+(\hat{A}_0^+)^*A_{j,:}^* = A_{i,:}(\hat{A}_0^*\hat{A}_0)^{-1}A_{j,:}^* = A_{i,:}\hat{A}_{0j,:}^+ = C_{0ij}.$$

Therefore, the addition of the i -th row changes the j -th row length as

$$l_j = l_{0j} - |C_{0ij}|^2/(1 + l_{0i}). \quad (17)$$

With the help of the update formulas, we can calculate the ratio of the volumes after the interchange. From the Lemma 4, we know that adding the i -th row increases the volume $1 + l_{0i}$ times. The expression (15) shows that removing the j -th row results in the volume decrease $1/(1 - l_j)$ times. The total change considering (17) is equal to

$$B_{ij} := (1 + l_{0i})(1 - l_j) = |C_{0ij}|^2 + (1 + l_{0i})(1 - l_{0j}).$$

□

The use of the matrix B_{ij} for the decision to replace the columns leads us to the next algorithm.

The complexity of the algorithm is $O(Mn \cdot \text{iter})$.

Let's estimate the number of iterations after `pre-maxvol`.

After appending $n - r$ arbitrary rows, we get a starting $\hat{A} \in \mathbb{C}^{n \times r}$ submatrix for `Dominant-C` with the volume which differs from the maximum not more than $\Gamma = (rn)^{r/2}$ times (by the same reasoning as at the beginning of the proposition 2 proof). The use of `maxvol` or `maxvol2` does not improve the asymptotics, since we take logarithm from Γ , like in `maxvol` algorithm (7).

Let the maximum row length in C be x . The same is true for $C' = CQ_{\hat{A}} = AR_{\hat{A}}^{-1}$, where $Q_{\hat{A}} \in \mathbb{C}^{n \times r}$ and $R_{\hat{A}} \in \mathbb{C}^{r \times r}$ are the QR decomposition of \hat{A} . We further deal with C' , since it has only r columns.

The volume of the extended submatrix is $1 + x^2$ times greater. The sum of 2-volumes of all $n \times r$ submatrices is $(n - r + 1)(1 + x^2)$. Among these submatrices, there exists one with a volume not less than

$$\frac{(n - r + 1)(1 + x^2) - 1}{n} \geq x^2 \frac{n - r + 1}{n}.$$

Algorithm 4 Dominant-C

Input: Matrix $A \in \mathbb{C}^{M \times r}$, the starting set of row indices \mathcal{I} of cardinality n . For example, $\mathcal{I} = \{1, \dots, n\}$.

Output: The updated set \mathcal{I} , corresponding to a dominant submatrix.

```

1:  $C := AA_{\mathcal{I}}^+$ 
2: for  $i := 1$  to  $M$  do
3:    $l_i := \|C_{i,:}\|_2^2 + 1$ 
4: end for
5: for  $i := n + 1$  to  $M$  do
6:   for  $j := 1$  to  $n$  do
7:      $B_{i,j} := |C_{i,j}|^2 + l_i(1 - C_{j,j})$ 
8:   end for
9: end for
10:  $\{i, j\} := \arg \max_{i,j} B_{i,j}$ 
11: while  $B_{i,j} > 1$  do
12:   Update  $C$ ,  $l$  and  $B$ 
13:   Replace  $j$  with  $i$  in  $\mathcal{I}$   $\{i, j\} := \arg \max_{i,j} B_{i,j}$ 
14: end while

```

Thus, if the initial volume ratio of the current submatrix to the maximal volume submatrix without common rows is equal to $V = \left(\alpha^2 \frac{n^2}{r(n-r+1)}\right)^{r/2}$, then with each step this ratio decreases in α times. So, until $\alpha = c$ (the calculation is the same as for maxvol)

$$k_2 \leq \left\lceil r \ln \frac{\ln \frac{r(n-r+1)^{r/2}}{n^2}}{\ln c} \right\rceil \leq \left\lceil r \ln \frac{2 \ln r}{\ln c} \right\rceil$$

steps are required.

After that, the volume is reduced by c times at each step. So, no more than

$$k_1 \leq \left\lceil r \frac{\ln c^2 \frac{n^2}{r(n-r+1)}}{2 \ln c} \right\rceil \leq \left\lceil r \left(1 + \frac{\ln n}{2 \ln c}\right) \right\rceil - 1$$

additional steps are required. Summarizing and taking into account that one rounding is enough, we obtain

$$k \leq r \left(1 + \frac{\ln n}{2 \ln c}\right) + r \ln \left(\frac{2 \ln r}{\ln c}\right).$$

If $c = \text{const} > 1$, then

$$\text{it} = O(r \ln n).$$

In addition to being an intermediate step in the cross approximation, Dominant-C is interesting in itself. Firstly, it allows to guarantee the cross approximation accuracy estimates

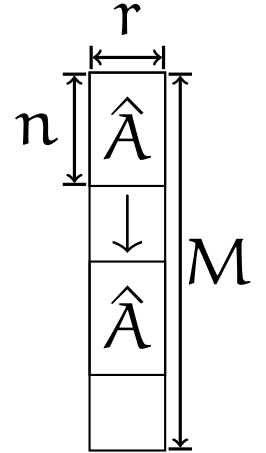

Figure 5: Update of $\hat{A} = A_{\mathcal{I}}$; through the algorithm Dominant-C.

in the 2-norm (if used in the first r left and right singular vectors, see Theorem 2 of [3]) and in the C-norm (Theorem 4.7 of [12]), because these estimates are based on Lemma 1 and require locally maximum volume submatrices. Such estimates are not guaranteed by the `maxvol2` algorithm even if some approximation of rank r is known. Moreover, the limited step number makes the algorithm competitive with many algorithms from [13] for finding a submatrix with a small norm of the pseudoinverse. The comparison is presented in subsection 2.7.

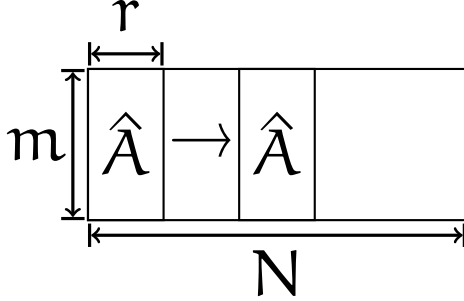

Figure 6: Update of $\hat{A} = A_{:,j}$ through the algorithm Dominant-R.

Now, to find the dominant rectangular submatrix, it only remains to present the algorithm Dominant-R (see figure 6). We need to maximize the volume by replacing one of the r columns. It can be done with the RRQR algorithm from [8]. We call this RRQR algorithm GEQR by the first letters of the authors' surnames. Dominant-R is its modification with the same asymptotics, but with the reduced coefficient due to the specifics of the matrix size ($N \gg r$). We use the same notation as in [8] for the Lemma and the algorithm.

Lemma 6 ([8], Lemma 3.1). *Let*

$$M = Q \begin{bmatrix} A & B \\ & C^T \end{bmatrix} \in \mathbb{R}^{m \times N},$$

where QA is a QR decomposition of the submatrix $\hat{A} \in \mathbb{R}^{m \times r}$ of the matrix M . Then, replacing the j -th column of \hat{A} by the i -th column of M changes the squared volume of \hat{A} by a factor of

$$m_{ij} = |(A^{-1}B)_{ij}|^2 + \gamma_i \omega_j.$$

Here γ denotes the vector of the squared 2-norms of the columns of C^T , and ω is the vector of the squared 2-norms of the rows of A^{-1} .

We set the approximation rank, and perform column replacements. The new columns can be appended by `pre-maxvol`.

Similar to `maxvol` we get that Dominant-R has complexity (see the notation in the algorithm) $O(Nmr^2 \frac{\ln r}{\ln f})$ if applied after `pre-maxvol`. This improves the original GEQR [8] complexity of $O(Nmr^2 \frac{\ln N}{\ln f})$.

Theorem 2. *Let (transposed) pre-maxvol and Dominant-R be successively applied to the matrix $A \in \mathbb{R}^{m \times N}$. Then after $O(r \log_f r)$ steps Dominant-R outputs a submatrix $\hat{A} \in \mathbb{R}^{m \times r}$ with QR decomposition $\hat{A} = \tilde{Q}\tilde{R}$ such that $Q = \tilde{Q}$ and $R = \tilde{Q}^T A$ are a strong rank-revealing QR decomposition with a factor f (see definition in [8]) up to column permutation.*

Proof. If Dominant-R with the parameter f stops, then the output submatrix \hat{A} indeed produces a strong rank-revealing QR decomposition, because the update criteria is the same as in GEQR [8].

Algorithm 5 Dominant-R (The full version is a modification of the column replacement in RRQR algorithm from [8])

Input: Matrix $M \in \mathbb{R}^{m \times N}$, the starting set of column indices \mathcal{I} of cardinality r (for example, $\mathcal{I} = \{1, \dots, r\}$), threshold parameter $f \geq 1$.

Output: The updated set \mathcal{I} , corresponding to a dominant rectangular submatrix.

```

1:  $Q, A := \text{QR}(M_{:, \mathcal{I}})$ 
2:  $Q := Q_{:, 1:r}$ 
3: for  $i := 1$  to  $N - r$  do
4:    $\gamma_i := \|M_{:, i+r}\|_2^2 - \|(Q^T M)_{:, i+r}\|_2^2$ 
5: end for
6: for  $i := 1$  to  $r$  do
7:    $\omega_i := \|A_{i,:}^{-1}\|_2^2$ 
8: end for
9:  $A^{-1}B := A^{-1} \cdot B$ 
10:  $m := \omega^T \gamma$ 
11: for  $i := 1$  to  $r$  do
12:   for  $j := 1$  to  $N - r$  do
13:      $m_{i,j} := m_{i,j} + |(A^{-1}B)_{i+r, j+r}|^2$ 
14:   end for
15: end for
16:  $\{i1, j1\} := \arg \max_{i1, j1} m_{i1, j1}$ 
17: while  $m_{i1, j1} > f$  do
18:   Replace  $i1$  with  $j1$  in  $\mathcal{I}$ 
19:   Update  $Q$  and  $A$ 
20:   Update  $\gamma$ ,  $\omega$  and  $A^{-1}B$ 
21:    $m := \omega^T \gamma$ 
22:   for  $i := 1$  to  $r$  do
23:     for  $j := 1$  to  $N - r$  do
24:        $m_{i,j} := m_{i,j} + |(A^{-1}B)_{i+r, j+r}|^2$ 
25:     end for
26:   end for
27:    $\{i1, j1\} := \arg \max_{i1, j1} m_{i1, j1}$ 
28: end while

```

The number of steps is limited, because pre-maxvol outputs a submatrix with the volume ratio $\Gamma \leq r!$ to the maximum volume among all $m \times r$ (we apply pre-maxvol to A^T , so $m \geq r$) submatrices and the squared volume ratio is decreased at least by a factor f at each step, so the number of iterations is bounded by

$$\text{iter} \leq \log_f \Gamma^2 \leq \log_f (r!)^2 = O(r \log_f r).$$

□

The total complexity follows from $O(Nmr)$ complexity of each Dominant-R iteration (see full version description in the Appendix). And the complexity of pre-maxvol is lower.

Now we combine the algorithms Dominant-C and Dominant-R into a form similar to the one for maxvol. This combination allows us to search for the dominant rectangular submatrix in the entire matrix.

The algorithm maxvol-rect consists of two parts. We search for a large volume submatrix in the fixed rows and a large volume submatrix in the fixed columns (see figure 7). Without loss of generality, we assume that there are more rows than columns. Otherwise, the algorithm differs only in transposition.

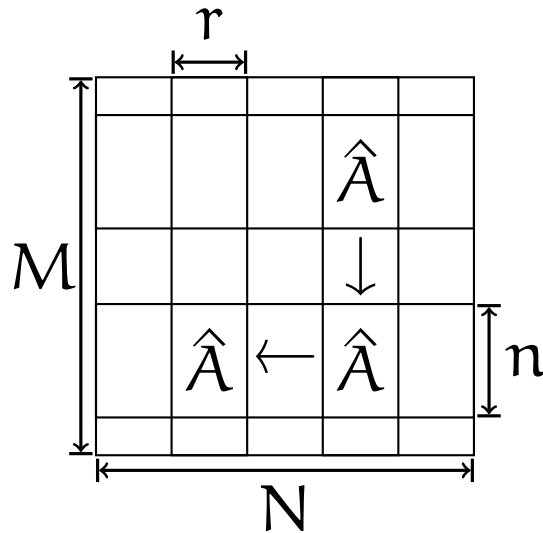

Figure 7: Update of current $\hat{A} = A_{\mathcal{I},\mathcal{J}}$ through the algorithm maxvol-rect.

Algorithm 6 maxvol-rect

Input: Matrix $A \in \mathbb{R}^{M \times N}$, the starting sets of row indices \mathcal{I} and column indices \mathcal{J} of cardinality n and r respectively.

Output: The updated sets \mathcal{I} and \mathcal{J} , corresponding to the dominant rectangular submatrix of rank r .

```
1: {In the beginning pre-maxvol can be applied.}
2: changed := true
3: old_changed := true
4: while changed do
5:   changed := false
6:   for changes_in in  $\{\mathcal{I}, \mathcal{J}\}$  do
7:     if changes_in =  $\mathcal{I}$  then
8:        $C := A_{:, \mathcal{J}}$ 
9:       changed := Dominant-C( $C, \mathcal{I}$ ) {Here a small addition to the algorithm is needed,
10:        which returns whether there were exchanges}
11:       old_changed := changed
12:     else
13:        $R := A_{\mathcal{I}, :}$ 
14:       changed := Dominant-R( $R, \mathcal{J}$ )
15:     end if
16:     if ((not changed) and (changes_in =  $\mathcal{J}$ )) then
17:       changed = false
18:       break
19:     end if
20:     if ((not old_changed) and (changes_in =  $\mathcal{I}$ )) then
21:       changed = false
22:       break
23:     end if
24:   end for
25: end while
```

2.5 Large projective volume search

Finally, we search for $m \times n$ submatrix of large r -projective volume by using $r \times n$ and $m \times r$ submatrices of large volume. This is the maxvol-proj algorithm. The construction idea is illustrated in figure 8.

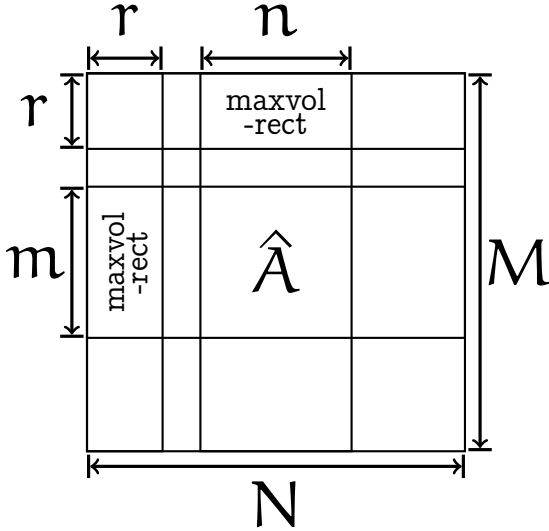

Figure 8: Submatrix $\hat{A} = A_{\mathcal{I}, \mathcal{J}}$ returned by maxvol-proj algorithm.

Algorithm 7 maxvol-proj

Input: Matrix $A \in \mathbb{R}^{M \times N}$, starting sets of row indices \mathcal{I} and column indices \mathcal{J} columns r and final sizes of C and R (n and m , respectively).

Output: The set \mathcal{I} of the row indices of R and the set \mathcal{J} of the column indices of C that contain a submatrix of a large projective volume.

- 1: maxvol-rect($A, \mathcal{I}, -$)
 - 2: maxvol-rect($A^T, \mathcal{J}, -$)
-

The informal justification is as follows. Suppose that $\text{rank } A = r$ and some $r \times n$ and $m \times r$ submatrices are submatrices of maximal volume. Then it is easy to see that a submatrix \hat{A} at the intersection of the m rows and n columns is indeed a submatrix of the maximal r -projective volume.

Thus, we reduced the problem of finding a submatrix of a large projective volume to the search for two smaller submatrices of large 2-volume. Thankfully, we already know how to find rectangular submatrices of large 2-volume by using maxvol-rect.

2.6 Improvements and simplifications

Algorithms Dominant-C and Dominant-R can work several times slower than maxvol. Firstly, n appears instead of r in the asymptotics. Secondly, the constant factor increases. Below we present an algorithm to find the large projective volume submatrix without Dominant-R (see figure 9). It can be used either after maxvol-proj or independently.

Algorithm maxvol-proj without Dominant-R

Input: Matrix $A \in \mathbb{C}^{M \times N}$, the starting sets of row indices \mathcal{I} and column indices \mathcal{J} of cardinality r , and final sizes n and m of C and R respectively.

Output: The updated sets \mathcal{I} (of the row indices of R) and \mathcal{J} (of the column indices of C) corresponding to a submatrix of a large projective volume.

```

1: changed := true
2: old_changed := true
3: while changed do
4:   changed := false
5:   for changes_in in {I, J} do
6:     U, S, V := SVD(AI,J)
7:     if changes_in = I then
8:       C := A·,J(V{1,...,r};·)T
9:       changed := Dominant-C(C, I) {Here a small addition to the algorithm is needed,
                                     which returns whether there were exchanges}
10:      old_changed := changed
11:     else
12:       R := (U·,{1,...,r}})TAI,·
13:       changed := Dominant-C(RT, J)
14:     end if
15:     if ((not changed) and (changes_in = J)) then
16:       changed = false
17:       break
18:     end if
19:     if ((not old_changed) and (changes_in = I)) then
20:       changed = false
21:       break
22:     end if
23:   end for
24: end while

```

Multiplication of the columns by the first r right singular vectors of \hat{A} leads to the problem of finding the large r -projective volume submatrix in $C\hat{A}_r^+$. At the same time, the projective volume increases. Indeed, if

$$\nu_2^r(\hat{A}'\hat{A}_r^+) > \nu_2^r(\hat{A}\hat{A}_r^+) = 1,$$

then since

$$\nu_2^r(\hat{A}')\nu_2^r(\hat{A}_r^+) \geq \nu_2^r(\hat{A}\hat{A}_r^+),$$

we get

$$\nu_2^r(\hat{A}') > 1/\nu_2^r(\hat{A}_r^+) = \nu_2^r(\hat{A}).$$

For the rows, the situation is similar. If $m = r$ or $n = r$, this algorithm is a simplified version of `maxvol-rect`. In this case the row replacements occur only if $|(A^{-1}B)_{ij}| > 1$, but not under the condition $m_{ij} > 1$, which holds more frequently.

Another version of the projective volume maximization [3] is based on the application of the algorithm `maxvol2`.

Algorithm 8 Fast CGR approximation search (2 maxvol2)

Input: Matrix $A \in \mathbb{C}^{M \times N}$, the starting sets of row indices \mathcal{I} and column indices \mathcal{J} of cardinality r , and final sizes n and m of C and R respectively.

Output: The updated sets \mathcal{I} (of the row indices of R) and \mathcal{J} (of the column indices of C) corresponding to a submatrix of a large projective volume.

- 1: $\text{maxvol}(A, \mathcal{I}, \mathcal{J})$
 - 2: $C := A_{:, \mathcal{J}}$
 - 3: $R := A_{\mathcal{I}, :}$
 - 4: $\text{maxvol2}(C, \mathcal{I}, n)$
 - 5: $\text{maxvol2}(R^T, \mathcal{J}, m)$
-

Combining all the estimates together, and taking into account the low probability to start from a low volume submatrix, we obtain the following overall complexity if we use Householder-based version of maxvol2 (algorithm 9 in the Appendix)

$$\approx O((M + N)r^2 \cdot \text{IT} + (M + N)r \cdot \text{iter}_{\text{maxvol}} + (M + N)(m + n)r)$$

Let's require the condition with $c = \text{const} > 1$ instead of the submatrix dominance (although even for $c = 1$ the number of the row replacements in maxvol is of order r). Then the complexity estimate becomes

$$\approx O((M + N)r^2 \ln r \cdot \text{IT} + (M + N)(m + n)r)$$

This algorithm works faster because all the row and column replacements are produced by the algorithm maxvol , and not by Dominant-C and Dominant-R. Also, appending a single row or column is cheaper than replacing. Nevertheless, numerical experiments show that the approximation by this algorithm is worse than by maxvol-proj .

Let us shortly mention some other ways to simplify and speed up the algorithm. The number of switches between rows and columns can be restricted (high approximation accuracy and large volume are already achieved in step 4). The choice $c \gg 1$ can guarantee a small number of replacements (although in practice $c = 1$ works fast enough). The criterion for substitutions can be simplified (through the replace of the condition $B_{ij} > 1$ by $|C_{ij}| > 1$ or $(1 + l_i)(1 - l_j) > 1$, thus avoiding the calculation of B). The number of replacements can be limited directly (for example, by the number n , which also does not greatly aggravate the accuracy).

In addition, the maxvol algorithm can be replaced by analogs. For example, one can obtain a set of rows and columns with just pre-maxvol or the Bebedorf algorithm [10]. The

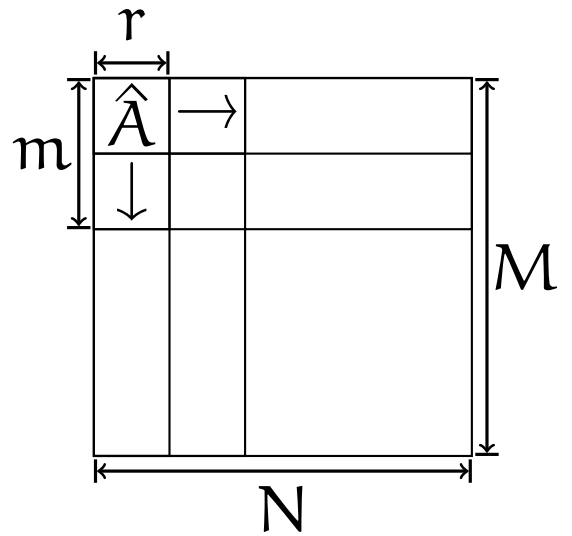

Figure 9: Fast CGR: extending $\hat{A} = A_{\mathcal{I}, \mathcal{J}}$ (obtained by maxvol) by two executions of maxvol2 .

use of the latter also gives the necessary rank (estimated from above) that guarantees the required accuracy.

2.7 Application to the subset selection problem

Algorithms `maxvol` and `Dominant-C` can be used to search for the columns containing a strongly nondegenerate submatrix. The obtained estimates of the step number allow to compare them with algorithms from [13]. By the item 2 of Lemma 1, choice of the submatrix $\hat{A} \in \mathbb{C}^{r \times n}$ in the rows $R \in \mathbb{C}^{r \times N}$ guarantees the inequality

$$\|\hat{A}^+ R\|_2 \leq \sqrt{1 + \frac{r(N-n)}{n-r+1}}.$$

It immediately follows that

$$\sigma_k(\hat{A}^+) \leq \sigma_k(R^+) \sqrt{1 + \frac{r(N-n)}{n-r+1}}.$$

For the Frobenius norm, using another expression from item 2 of the Lemma 1, we obtain

$$\|\hat{A}^+\|_F \leq \|R^+\|_2 \sqrt{r + \frac{r(N-n)}{n-r+1}}. \quad (18)$$

The table 1 contains the estimates of $\|\hat{A}^+\|_2$ and $\|\hat{A}^+\|_F$ for `maxvol` and `Dominant-C`, and the estimates for the algorithms from [13]. Note that the algorithm `GEQR` [8], equivalent to `maxvol` in case of $k = r$ columns, has already been mentioned in [13]. However, we proved a better estimate on the step number.

The algorithms are sorted by the number of operations.

In order to simplify the comparison for `Dominant-C`, we give the case $n = 2r - 1$ and $c = 2$. It is assumed that the `pre-maxvol` algorithm is used before `maxvol` or `Dominant-C`, thus we can estimate the number of operations.

The last two algorithms are based on column removals. Since their complexities depend on N quadratically, the application is possible only for small matrices.

Only the algorithms which are at least about r times slower give better estimates of $\|\hat{A}^+\|_2$ and $\|\hat{A}^+\|_F$ than `maxvol` and `Dominant-C`. For the Frobenius norm, `maxvol` and `Dominant-C` have worse guarantees only if the ratio $\frac{r\|R^+\|_2}{\|R^+\|_F}$ is not close to 1. In addition, if `maxvol` or `Dominant-C` selects a submatrix with almost equal singular values, then the factor r in the 2-norm estimate disappears (see (18)).

When comparing the complexity, we see that the only algorithm from [13] that can compete with `Dominant-C` in speed, leads to a larger error and requires significantly more columns, while its number of operations is only $O(\log r)$ times smaller.

3 Numerical experiments

In this section, we study the efficiency of the above algorithms on the cross approximation problem.

Table 1: Methods for finding a strongly nondegenerate rectangular submatrix $\hat{A} \in \mathbb{C}^{r \times n}$ in the rows $R \in \mathbb{C}^{r \times N}$.

Method	$\ \hat{A}^+\ _F^2 / \ R^+\ _F^2$	$\ \hat{A}^+\ _2^2 / \ R^+\ _2^2$	Complexity
Theorem 3.7 ($\delta = 1/2$) from [13], $n \geq 32k \ln(4k)$	$4N$	$4N$	$O(Nr^2 + n \log n)$
maxvol [5], $n = r$	$(1 + c(N - r)) \frac{r\ R^+\ _2}{\ R^+\ _F}$	$1 + cr(N - r)$	$O(Nr^2 \log r / \log c)$
Dominant-C $n = 2r - 1, c = 2$	$(2 \frac{N+1}{r} - 4) \frac{r\ R^+\ _2}{\ R^+\ _F}$	$2(N - 2r) + 3$	$O(Nr^2 \log r)$
Dominant-C $n \geq r$	$(1 + \frac{N-n}{n-r+1}) \frac{r\ R^+\ _2}{\ R^+\ _F}$	$1 + r \frac{N-n}{n-r+1}$	$O(Nnr \log n / \log c)$
Theorem 3.11 ($\delta = 1/2$) from [13], $n = r$	$c(N - r + 1)$	$cr(N - r + 1)$	$O(Nr^3 / \log c)$
Theorem 3.5 from [13], $n > r$	$\frac{(1 + \sqrt{\frac{N}{n}})^2}{(1 - \sqrt{\frac{r}{n}})^2}$	$\frac{(1 + \sqrt{\frac{N}{n}})^2}{(1 - \sqrt{\frac{r}{n}})^2}$	$O(Nnr^2)$
Theorem 3.1 from [13], $n \geq r$	$\frac{N-r+1}{n-r+1}$	$r \frac{N-r+1}{n-r+1}$	$O(Nr^2 + N(N - n)r)$
Cons. 3.3 from [13], $n \geq r$	$\frac{N-r+1}{n-r+1} \cdot \frac{r\ R^+\ _2}{\ R^+\ _F}$	$1 + r \frac{N-n}{n-r+1}$	$O(Nr^2 + N(N - n)r)$

In matrix $A \in \mathbb{C}^{M \times N}$ we select $n \geq r$ columns $C \in \mathbb{C}^{M \times n}$ and $m \geq r$ rows $R \in \mathbb{C}^{m \times N}$, and the cross approximation has the form CGR , with the *approximation generator* $G \in \mathbb{C}^{n \times m}$, of rank at most r .

Generally, the errors for cross approximations are calculated in the 2-norm and the Frobenius norm. The existing lower bounds [14] do not allow to guarantee the high approximation accuracy in the 2-norm. For the Frobenius norm, the result has been recently obtained with the same coefficient as for the C-norm in [3]. Unfortunately, it does not apply to the maximum volume submatrices.

Theorem 3 ([15]). *For any matrix $A \in \mathbb{C}^{M \times N}$ there exists a skeleton approximation $C\hat{A}^{-1}R$ such that*

$$\|A - C\hat{A}^{-1}R\|_F \leq (r + 1) \|A - A_r\|_F \quad (19)$$

Still, we hope that this estimate and its analog for the projective volume are often achieved on the matrices obtained by the algorithms maximizing the volume and the projective volume. This is the hypothesis, which we will try to check numerically.

The rest of this section is split into subsections, where we make a statement about the quality of the approximations and show the corresponding numerical results.

3.1 Projective volume can lead to approximations, arbitrary close to SVD

The complexity of maxvol-proj is linear in matrix size, while SVD is cubic, so the ability to replace SVD by maxvol-proj with a small multiplicative error can be very useful.

Let us represent the cross approximation error in the form

$$\|A - \text{CGR}\|_F = (1 + \varepsilon)\|A - A_r\|_F. \quad (20)$$

The question is, how many rows and columns and how much time it takes to achieve (20)?

We will show, that maxvol-proj can produce approximations with the error $(1 + \varepsilon)\|A - A_r\|_F$ in $O(Nr^2/\varepsilon^2)$ time. Fast CGR-approximation construction (algorithm 8) with Householder-based maxvol2 (algorithm 9 in the Appendix) has complexity $O(Nr^2/\varepsilon)$, but should be used with caution, because maxvol2 provides fewer guarantees than maxvol-rect. Nevertheless, we will see that it still works almost as well as maxvol-proj.

We hypothesize the expected ratio of the obtained error to the best approximation error (in Frobenius norm) to be the same as for the case of the C-norm in [3]

$$\mathbb{E}_{U,V}\|A - C\hat{A}_r^+R\|_F \leq \sqrt{\left(1 + \frac{r}{m-r+1}\right)\left(1 + \frac{r}{n-r+1}\right)}\|A - A_r\|_F \quad (21)$$

in the same notations as before. Hereinafter U and V in the expectation denote random unitary matrices. They are also left and right singular vectors of A . We hope that by increasing n and m we can reach arbitrary small ε and that $1/\varepsilon$ depends linearly on the size of the submatrix. Hereinafter we limit the number of swaps by $2n = 2m$, so there is no logarithmic factor in complexity.

It is important to note that all the algorithms in this paper do not observe the entire matrix and thus there are no guarantees for the worst case.

Figure 10 shows that the value $1/\varepsilon$ indeed depends linearly on the submatrix size on the average, and even is larger than expected ($\varepsilon \approx \frac{r}{n-r+1}$ in (21)). However, there are still cases when the error coefficient $1 + \varepsilon$ is larger than $1 + \frac{r}{n-r+1}$ (when $1/\varepsilon$ is smaller than $\frac{n-r+1}{r}$), which is also expected. Nevertheless, they appear only in the case, when singular values of the matrix quickly decrease. We discuss how to significantly decrease the error in this case at the end of this section. Finally, fast CGR (2 maxvol2) also shows linear dependence, which means it often successfully finds large projective volume submatrices, in spite of fewer guarantees.

As we see, the hypothetical estimate (21) is rather rough for the average case. However, it is possible to construct an estimate much closer to reality, but less justified.

3.2 Average error estimates

Hereinafter in numerical experiments we consider 3 cases: $m = n = r$, $m = 2r, n = r$ and $m = n = 2r$, denoted on the figures by $r * r$, $2r * r$ and $2r * 2r$. According to our hypothesis,

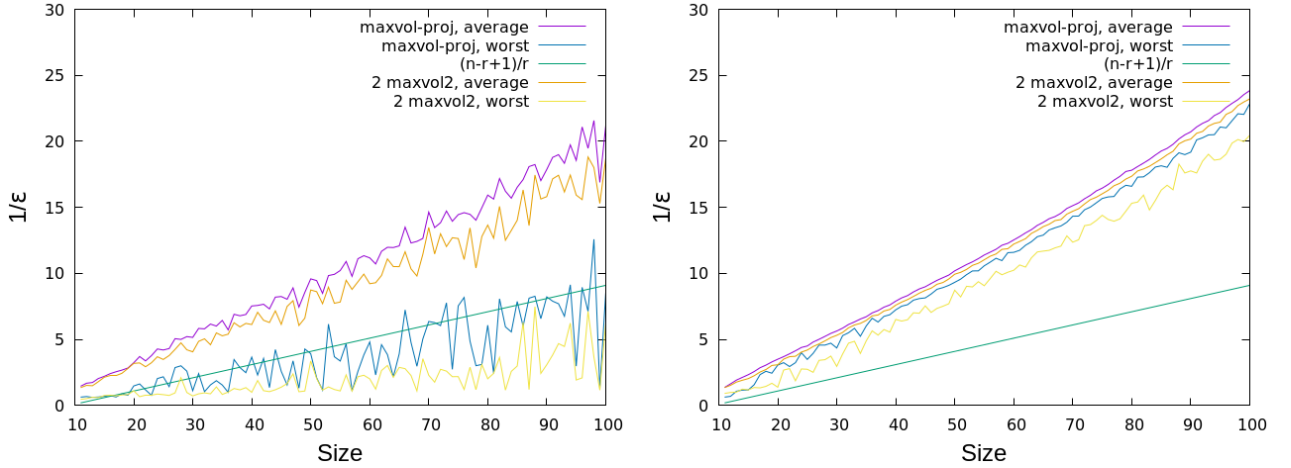

(a) The k -th singular value of the matrix equals $1/2^k$. (b) First r singular values are equal to 20, the rest are 1.

Figure 10: Dependence of $1/\varepsilon$ (20) on the number of rows and columns in the submatrix, used in different projective volume search algorithms. Matrix size 400×400 , rank $r = 10$, matrix singular values are described under the figures. The results are averaged over 100 random matrix generations. Note that $1/\varepsilon$ is plotted, so larger values mean smaller error. $1/\varepsilon$ for largest error (“worst” case) among these 100 random matrices is also plotted.

the corresponding errors are estimated as

$$\begin{aligned} \mathbb{E}_{\mathbf{U}, \mathbf{V}} \|\mathbf{A} - \mathbf{C}\hat{\mathbf{A}}^{-1}\mathbf{R}\|_{\mathbb{F}} &\leq (r+1)\|\mathbf{A} - \mathbf{A}_r\|_{\mathbb{F}}, \\ \mathbb{E}_{\mathbf{U}, \mathbf{V}} \|\mathbf{A} - \mathbf{C}\hat{\mathbf{A}}^+\mathbf{R}\|_{\mathbb{F}} &\leq \sqrt{2r+1}\|\mathbf{A} - \mathbf{A}_r\|_{\mathbb{F}}, \\ \mathbb{E}_{\mathbf{U}, \mathbf{V}} \|\mathbf{A} - \mathbf{C}\hat{\mathbf{A}}_r^+\mathbf{R}\|_{\mathbb{F}} &\leq \left(1 + \frac{r}{r+1}\right)\|\mathbf{A} - \mathbf{A}_r\|_{\mathbb{F}}. \end{aligned}$$

By item 2 of Lemma 1, the coefficients like $\sqrt{\frac{n+1}{n-r+1}}$ come from the the Frobenius norm of the pseudoinverse of some submatrix $\hat{\mathbf{U}} \in \mathbb{C}^{n \times r}$. For the 2-norm estimates, we use the 2-norm of the pseudoinverse. Using the equations from item 2 of the Lemma 1 to replace $\sqrt{\frac{n+1}{n-r+1}}$, we obtain the following estimate:

$$\mathbb{E}_{\mathbf{U}, \mathbf{V}} \|\mathbf{A} - \mathbf{C}\hat{\mathbf{A}}_r^+\mathbf{R}\|_{\mathbb{F}} \approx \mathbb{E}_{\mathbf{U}', \mathbf{V}'} \sqrt{\left(1 + \frac{1}{M-r}(\|\hat{\mathbf{U}}'\|_{\mathbb{F}}^2 - r)\right) \left(1 + \frac{1}{N-r}(\|\hat{\mathbf{V}}'\|_{\mathbb{F}}^2 - r)\right)} \|\mathbf{A} - \mathbf{A}_r\|_{\mathbb{F}} \quad (22)$$

$\hat{\mathbf{U}}' \in \mathbb{C}^{m \times r}$ and $\hat{\mathbf{V}}' \in \mathbb{C}^{r \times n}$ here are the dominant submatrices of some random unitary matrices $\mathbf{U}' \in \mathbb{C}^{M \times r}$ and $\mathbf{V}' \in \mathbb{C}^{r \times N}$. Their sizes for each of the three cases correspond to the sizes of $\hat{\mathbf{A}}$. For $M = N = 100$, the values of the coefficients are shown in figure 11.

As one can see, the difference is significant. The following figures do not have an upper bound to avoid chaos.

Let’s compare our estimates to practice. In the figure 12, the submatrices are constructed by maxvol [5], maxvol-rect and maxvol-proj.

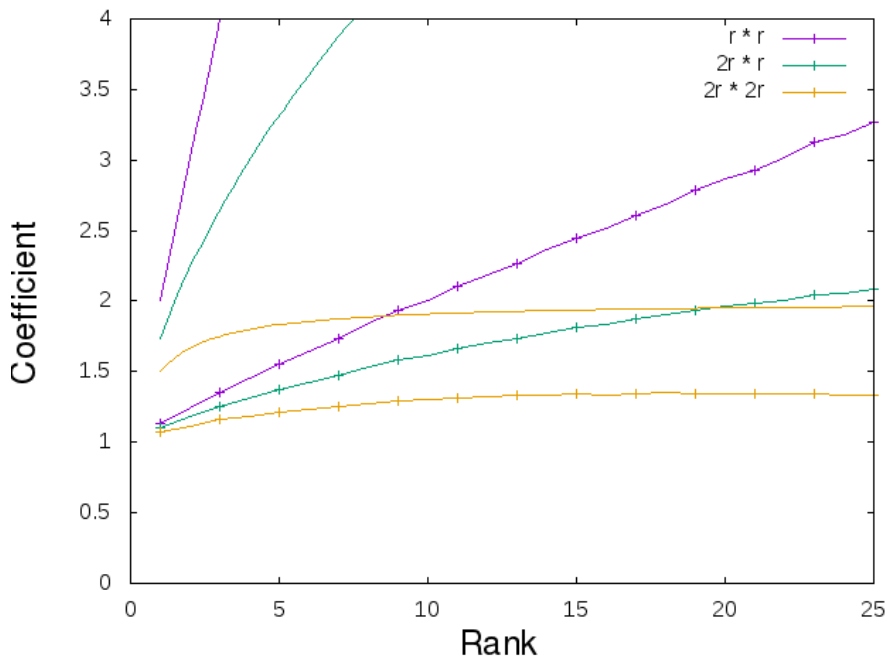

Figure 11: The coefficients before the Frobenius norm error in (22) presented as a function of rank for various sub-matrix sizes (lines with crosses). The corresponding estimates from (21) (lines without crosses). The sizes of unitary matrices are $100 \times r$. The results are averaged over 100 random matrix generations.

The upper bound estimate always holds, and the estimate (22) is reasonably accurate. We note that the relative error is less in the case of equal singular values of the error. The approximation is accurate even though in both cases the Frobenius norm of the error is comparable with the minimum singular value of the approximation. Note that the average error coefficient of the algorithms does not depend on the singular values of the error. The quality of the approximation is the same, whether the singular values of $A - A_r$ are small and quickly decrease, or they are large (compared to the singular values of A_r) and do not decrease after r -th at all.

If the ratio of singular values becomes about $1/1000$, the graphs visually coincide.

Of course, the average case scenario is not too informative and we should also look at how bad the error can get and how often.

3.3 Larger size means smaller variance

Here we show that using more rows and columns also significantly decreases the variance and thus large errors become much rarer. To do it, we plot the distributions of the cross approximation error.

The error distribution histograms are shown in figures 13 and 14. It is indeed easy to see that not only the average error but also the error variance is less for maxvol-proj.

Figures 15 and 16 show the similar histograms for the 2-norm. If the 2-norm and the Frobenius norm of the error are close, the CGR approximation also has a small error. And in the case of a large difference between the error norms the approximation is much less accurate.

The C-norm of the error was studied in detail in [3]. Figure 17 shows that the distributions of the C-norm and of the Frobenius norm are close, which coincides with our hypothesis that the coefficients should be similar.

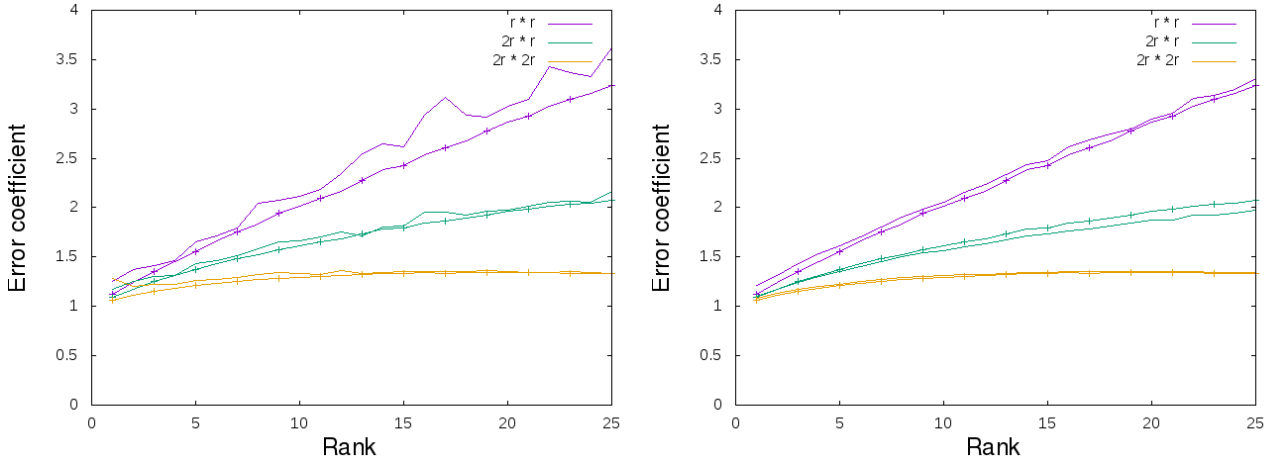

(a) The k -th singular value of the matrix equals $1/2^k$. (b) First r singular values are equal to 10, the rest are 1.

Figure 12: The ratio of the cross approximation error to the best Frobenius norm error presented as a function of rank for various submatrix sizes (lines without crosses). Estimates from (22) (lines with crosses). Matrix size 100×100 , matrix singular values are described under the figures. The results are averaged over 100 random matrix generations.

It is also noticeable that in the case of methods with r -projective volume maximization, the error does not heavily depend on the particular maximization approach. As already mentioned, instead of `maxvol-proj`, one can quite quickly apply `maxvol2` twice to the found submatrix of size $r \times r$.

3.4 Comparison of different projective volume maximization methods

In this subsection, we compare different algorithms for large projective volume search to see if the exact algorithm of choosing more rows and columns is important or we can use any intuitively reasonable approach.

In addition to already presented algorithms, we examine two more methods that work asymptotically slower:

1. `maxvol` of rank $2r$: The `maxvol` algorithm is used for the size $2r \times 2r$, and then the resulting submatrix is r -pseudoinversed;

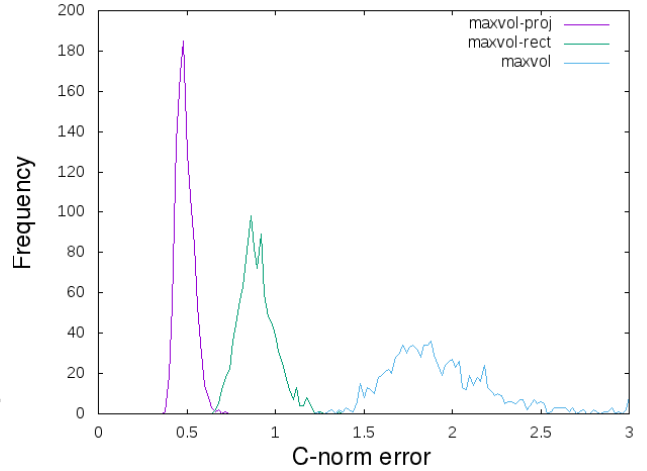

Figure 17: Distributions of the C-norm error for different cross approximation algorithms. Matrix size 100×100 , approximation rank $r = 10$, $n = 20$. First 10 singular values are equal to 10, the rest are 1. The distribution is based on 2000 random matrix generations.

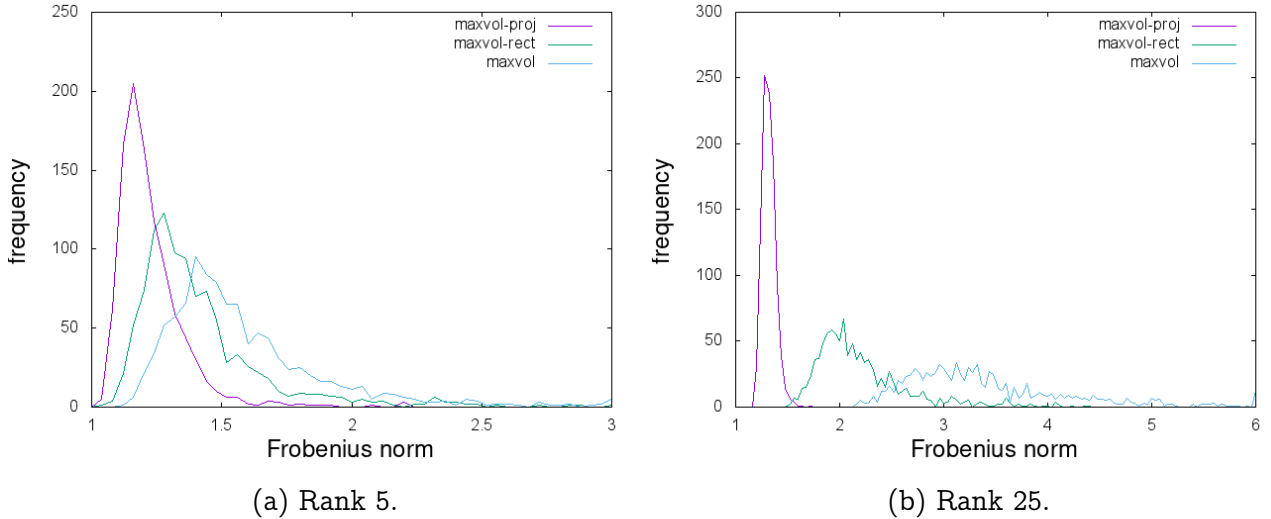

Figure 13: Distributions of the Frobenius norms of the error for different cross approximation algorithms. Matrix size 100×100 , different values of rank r , `maxvol-rect` uses $2r$ rows. The k -th singular value equals $1/2^k$. The distribution is based on 1000 random matrix generations.

2. `maxvol2r`: instead of the second applying of `maxvol2`, the matrix is expanded by the column c containing the maximum value of $\|\hat{A}_r^+ c\|_2$ (the efficiency justification can be found in [3]).

Note that instead of the exact singular value decomposition of a submatrix, we can use an approximate technique (for example, `RRQR`). Often (but not always!) the error does not increase much.

As figure 18 shows, `maxvol-proj` yields the best mean error and the best variance, although the difference is not too large.

3.5 Truncated SVD can improve the approximation in particular cases.

Previously we have seen that the coefficient for the approximation error does not depend on the singular values of A_r . It must be noted, however, that in the case, when singular values decrease very quickly, the approximation quality can be further improved.

Let us consider a non-random matrix example. Let

$$(A_1)_{i,j} = (i^{1/3} + j^{1/3})^2 \sqrt{\frac{1}{i} + \frac{1}{j}}; \quad i, j = \overline{1, n}. \quad (23)$$

It is the so-called “ballistic core” used in the coagulation and fragmentation problems [16]. Results for several matrix sizes are presented in the table 2. The approximation accuracy is of the order $10^{-5} - 10^{-6}$. As always, `maxvol-rect` uses $2r$ rows. The starting columns and rows are selected randomly.

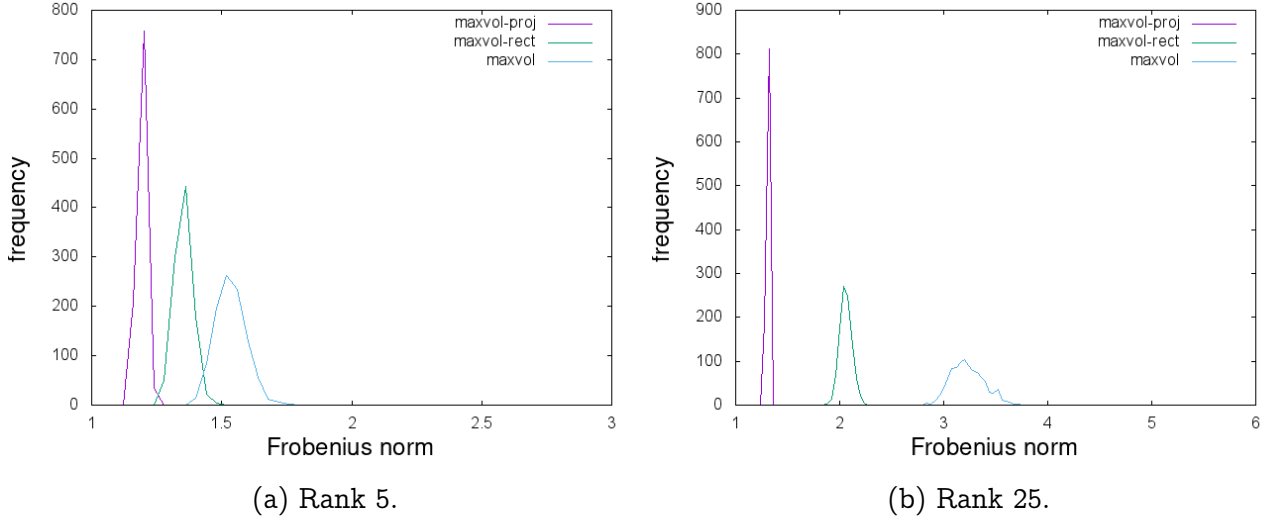

Figure 14: Distributions of the Frobenius norms of the error for different cross approximation algorithms. Matrix size 100×100 , different values of rank r , maxvol-rect uses $2r$ rows. The singular values of the error are 1000 times less than the singular values of the best approximation. The distribution is based on 1000 random matrix generations.

Table 2: The cross approximation errors for the matrix A_1 (23).

Size and rank	SVD	maxvol	maxvol-rect	maxvol-proj	TSVD after maxvol of rank $r + 2$
$n = 800, r = 12$	$1.01 \cdot 10^{-5}$	$5.40 \cdot 10^{-5}$	$5.15 \cdot 10^{-5}$	$3.23 \cdot 10^{-5}$	$1.02 \cdot 10^{-5}$
$n = 400, r = 11$	$6.09 \cdot 10^{-6}$	$2.64 \cdot 10^{-5}$	$2.25 \cdot 10^{-5}$	$1.59 \cdot 10^{-5}$	$6.13 \cdot 10^{-6}$
$n = 200, r = 10$	$3.59 \cdot 10^{-6}$	$1.23 \cdot 10^{-5}$	$1.04 \cdot 10^{-5}$	$7.09 \cdot 10^{-6}$	$3.59 \cdot 10^{-6}$
$n = 100, r = 9$	$2.01 \cdot 10^{-6}$	$5.41 \cdot 10^{-6}$	$4.87 \cdot 10^{-6}$	$3.35 \cdot 10^{-6}$	$2.01 \cdot 10^{-6}$

In the last column we use truncated singular value decomposition (TSVD) of the $C\hat{A}^{-1}R$ approximation of A_1 with rank $r + 2$ (which takes $O(Nr^2)$), so that

$$A_1 \approx (C\hat{A}^{-1}R)_r, \quad \hat{A} \in \mathbb{R}^{(r+2) \times (r+2)}.$$

We see that with this approach

$$\|A_1 - (C\hat{A}^{-1}R)\|_F \leq 1.01 \|A_1 - (A_1)_r\|_F,$$

though we used only $r + 2$ rows and columns. The reason for this fact lies in the fast decrease of singular values of A_1 .

Suppose we want to construct some rank- r approximation of A with another arbitrary matrix \tilde{A} . Let P_r be an orthogonal projection on the first left singular vectors of A , so that

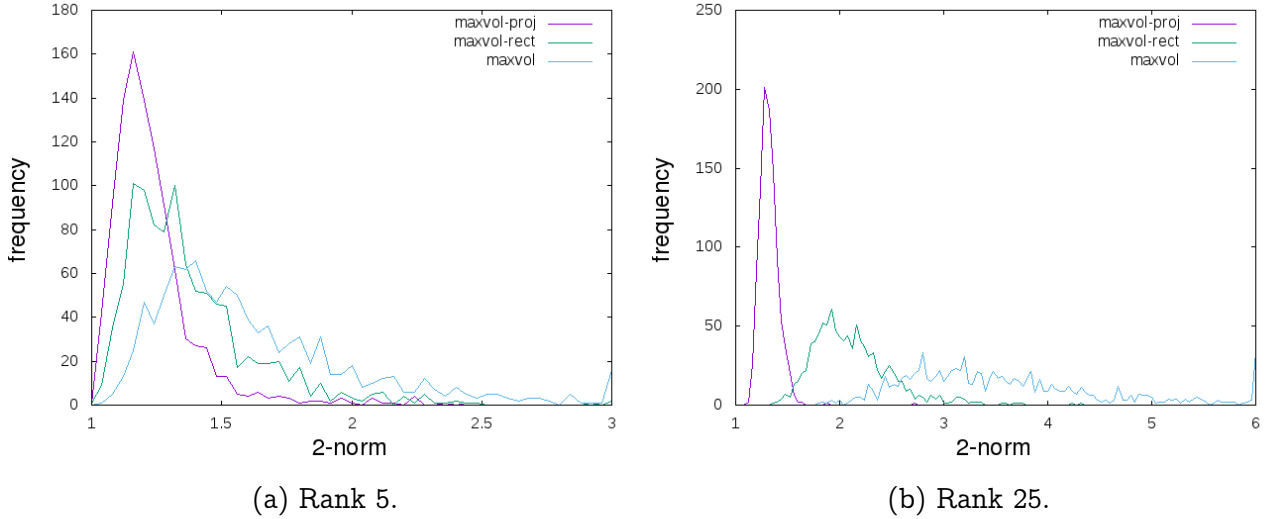

Figure 15: Distributions of the error 2-norm for different cross approximation algorithms. Matrix size 100×100 , different values of rank r , `maxvol-rect` uses $2r$ rows. The k -th singular value equals $1/2^k$. The distribution is based on 1000 random matrix generations.

$P_r A = A_r$. Then

$$\begin{aligned}
 \|A - (\tilde{A})_r\|_F &\leq \|A - \tilde{A}\|_F + \|\tilde{A} - (\tilde{A})_r\|_F \\
 &\leq \|A - \tilde{A}\|_F + \|(I - P_r) \tilde{A}\|_F \\
 &\leq \|A - \tilde{A}\|_F + \|(I - P_r) A\|_F + \|(I - P_r) (A - \tilde{A})\|_F \\
 &\leq 2\|A - \tilde{A}\|_F + \|A - A_r\|_F.
 \end{aligned}$$

For $\tilde{A} = \text{CGR}$ with rank $r + k$ approximation error $\|A - \tilde{A}\|_F \|A - A_{r+k}\|_F$ is much smaller than $\|A - A_r\|_F$ when singular values quickly decrease, so we get the error close to $\|A - A_r\|_F$ with only a few additional rows and columns.

Nevertheless, for the closely distributed singular values, the truncated SVD of the constructed approximation no longer gives any advantages, and `maxvol-proj` becomes more efficient. For such an example, we replace the singular values of the error of A_1 by equal numbers. That is, consider a matrix

$$A_2 = U_1 \Sigma_2 V_1, \quad (24)$$

such that

$$A_1 = U_1 \Sigma_1 V_1$$

and

$$\begin{aligned}
 \sigma_i(\Sigma_2) &= \sigma_i(\Sigma_1), \quad i = \overline{1, r}, \\
 \sigma_i(\Sigma_2) &= \sigma_j(\Sigma_2), \quad i, j > r, \\
 \|(A_1) - (A_1)_r\|_F &= \|(A_2) - (A_2)_r\|_F.
 \end{aligned}$$

Thus, SVD-based approximation gives the same error for A_1 and A_2 .

Table 3 shows how the algorithms approximate A_2 . One can see that the best results are given by `maxvol-proj`. Truncated SVD after `maxvol` of higher rank $n = 2r$ is much less useful than for A_1 . In this case simple `maxvol` also performs better. However, its error still grows

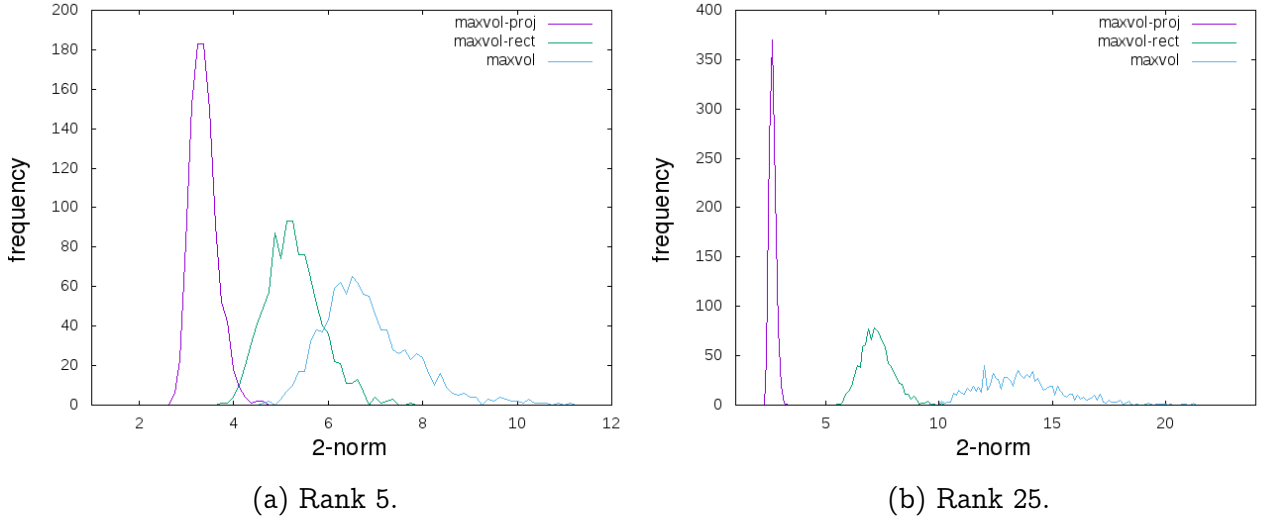

Figure 16: Distributions of the error 2-norm for different cross approximation algorithms. Matrix size 100×100 , different values of rank r , `maxvol-rect` uses $2r$ rows. The singular values of the error are 1000 times less than the singular values of the best approximation. The distribution is based on 1000 random matrix generations.

Table 3: The cross approximation errors for the matrix A_2 (24).

Size and rank	SVD	maxvol	maxvol-rect	maxvol-proj	TSVD after maxvol of rank $2r$
$n = 800, r = 12$	$1.01 \cdot 10^{-5}$	$2.02 \cdot 10^{-5}$	$1.71 \cdot 10^{-5}$	$1.44 \cdot 10^{-5}$	$1.59 \cdot 10^{-5}$
$n = 400, r = 11$	$6.09 \cdot 10^{-6}$	$1.19 \cdot 10^{-5}$	$9.63 \cdot 10^{-6}$	$9.01 \cdot 10^{-6}$	$9.94 \cdot 10^{-6}$
$n = 200, r = 10$	$3.59 \cdot 10^{-6}$	$6.86 \cdot 10^{-6}$	$6.03 \cdot 10^{-6}$	$5.03 \cdot 10^{-6}$	$5.57 \cdot 10^{-6}$
$n = 100, r = 9$	$2.01 \cdot 10^{-6}$	$3.84 \cdot 10^{-6}$	$3.30 \cdot 10^{-6}$	$2.71 \cdot 10^{-6}$	$3.11 \cdot 10^{-6}$

with size and rank. For `maxvol-proj`, the error never exceeds the SVD-based error more than 1.5 times.

It is also worth noting that the use of Truncated SVD still improves the accuracy: the direct application of `maxvol` of rank $2r$ gives a more significant error. Thus, for the slowly decaying singular values, the use of `maxvol` of higher rank may not yield any advantages. To improve accuracy, one must reduce the rank of the approximation.

If one doesn't know in advance that singular values quickly decrease, it can still be checked in the constructed approximation, and the rank can be reduced the same way after `maxvol-proj`.

4 Conclusion

In general, low-rank approximations based on the maximum volume principle require very few operations and show high accuracy of the approximation.

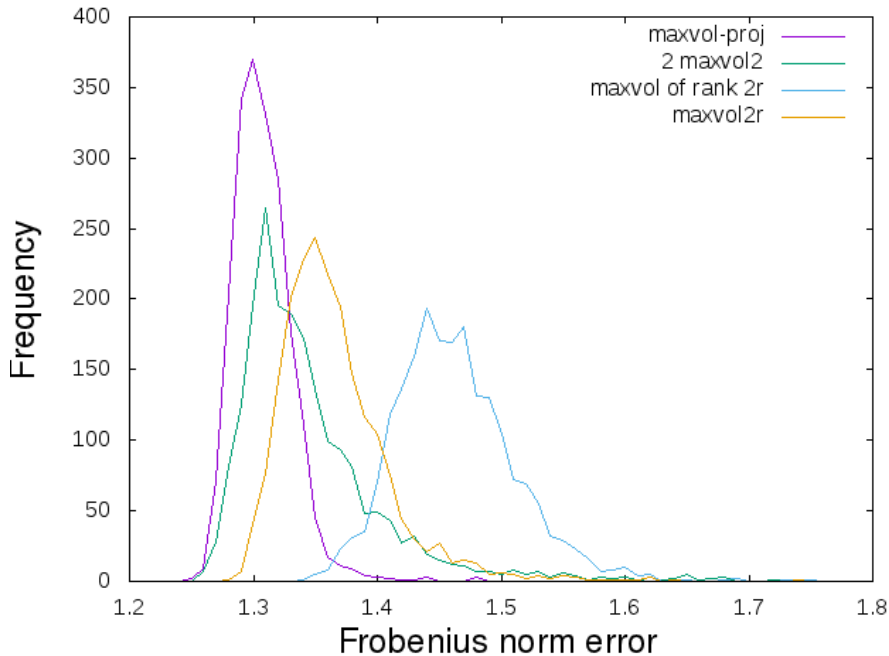

Figure 18: Distributions of the Frobenius norms of the error for different methods of r -projective volume maximization. Matrix size 100×100 , approximation rank $r = 10$, $n = 20$. First r singular values are equal to 10, the rest are 1. The distribution is based on 2000 random matrix generations.

When we need to choose between the speed and the accuracy, we can use the algorithm `maxvol-proj`, its version without `Dominant-R`, or its simplifications. At the same time, the necessary rank can be estimated from above, starting with the `Bebendorf` algorithm [10]. If necessary, one can reduce it by applying `Truncated SVD` to the constructed cross approximation. In the case of a fast singular values decay, `Truncated SVD` can be applied to an approximation of a larger rank, and thus significantly improve the accuracy (compared to the direct rank r approximations). Sometimes, this makes it possible to achieve better accuracy without `maxvol-proj`. However, `maxvol-proj` is a universal method in the sense that the accuracy in the Frobenius norm does not depend (on average) on the distribution of singular values.

The numerical experiments show that averaging over random matrices of left and right singular vectors gives the Frobenius norm error with the coefficient of the same order as in the C -norm. This fact is directly related to the Frobenius norm of pseudoinverse to some submatrices of unitary matrices. Moreover, the hypothesized coefficient upper bound (21) is similar to the best known upper bounds [17] and with the lower bounds both for $n = r$ and for $n \rightarrow \infty$ [18, 6].

5 Appendix

A Full versions of algorithms

Below we present the detailed algorithm descriptions and the derivations for some new update formulas. The justifications of the update formulas for `maxvol` [5] and `GEQR` [8] are in the corresponding articles. References are given in the algorithm headings. The update formula for `Dominant-C` is provided in the Algorithms section, Lemma 5.

We tried to formulate the algorithms to make the coding in any programming language as close as possible to simple copying.

Algorithm maxvol [5]

Input: Matrix $A \in \mathbb{C}^{M \times N}$, the starting sets of row indices \mathcal{I} and column indices \mathcal{J} of cardinality r . For example, $\mathcal{I} = \mathcal{J} = \{1, \dots, r\}$.

Output: The updated sets \mathcal{I} and \mathcal{J} corresponding to the rank- r dominant submatrix.

```

1:  $C := A_{:, \mathcal{J}} A_{\mathcal{I}, \mathcal{J}}^{-1}$ 
2:  $\text{current\_order} := \{1, \dots, M\}$ 
3:  $C.\text{swap}(\mathcal{I}, \{1, \dots, r\}, \text{current\_order})$  { $C.\text{swap}(A, B, \text{order})$  swaps the elements of  $C$ , corresponding to indexes from  $A$  and  $B$  ( $A_i$  swaps with  $B_i$ ) and changes the order of corresponding indexes in order. }
4:  $\{i, j\} := \arg \max_{i,j} |C_{i,j}|$ 
5:  $\text{changed} := \text{true}$ 
6:  $\text{old\_changed} := \text{true}$ 
7: while  $\text{changed}$  do
8:    $\text{changed} := \text{false}$ 
9:   for  $\text{changes\_in}$  in  $\{\mathcal{I}, \mathcal{J}\}$  do
10:     {Here, we assign the pointer, so no copies of the sets are made. }
11:     while  $|C_{i,j}| > 1$  do
12:       if  $i = j$  then
13:         break
14:       end if
15:        $C := C - C_{:,j} (C_{i,:} - e_j) / C_{i,j}$ 
16:        $C.\text{swap}(i, j, \text{current\_order})$ 
17:        $\text{changed} := \text{true}$ 
18:        $\text{old\_changed} := \text{true}$ 
19:     end while
20:     if  $((\text{not } \text{changed}) \text{ and } (\text{changes\_in} = \mathcal{J}))$  then
21:        $\text{changed} := \text{false}$ 
22:       break
23:     end if
24:     if  $((\text{not } \text{old\_changed}) \text{ and } (\text{changes\_in} = \mathcal{I}))$  then
25:        $\text{changed} := \text{false}$ 
26:       break
27:     end if
28:      $\text{changes\_in} := \text{current\_order}[1..r]$  {The numbering starts at 1.}
29:     if  $\text{changes\_in} = \mathcal{J}$  then
30:        $\text{old\_changed} := \text{false}$ 
31:        $C := A_{:, \mathcal{J}} A_{\mathcal{I}, \mathcal{J}}^{-1}$ 
32:        $\text{current\_order} := \{1, \dots, M\}$ 
33:        $C.\text{swap}(\mathcal{I}, \{1, \dots, r\}, \text{current\_order})$ 

```

```

34:   else
35:     C := AI,T AI,J-T
36:     current_order := {1, ..., N}
37:     C.swap(J, {1, ..., r}, current_order)
38:   end if
39:   {i, j} := arg maxi,j |Ci,j|
40: end for
41: end while

```

Householder-based **maxvol2** algorithm

Here we derive and present a faster algorithm for greedy row selection. The idea is the same as in the original **maxvol2** [11], but the complexity is lower.

Let some k rows be selected. Matrix $A \in \mathbb{C}^{M \times r}$ can be represented in the form

$$A = \begin{bmatrix} \hat{A} \\ \tilde{A} \end{bmatrix}, \quad \hat{A} \in \mathbb{C}^{k \times r} \text{ -- current submatrix.}$$

For the fast update it is required to know the 2-norms of the rows from $\tilde{A}\hat{A}^+ \in \mathbb{C}^{(M-k) \times k}$. This matrix is of rank $r \leq k$, and therefore can be represented in the form

$$\tilde{A}\hat{A}^+ = \tilde{A}M^{-1}Q, \quad Q^*M = \hat{A}, \quad Q \in \mathbb{C}^{r \times k}, \quad QQ^* = I, \quad M \in \mathbb{C}^{r \times r}.$$

For $k = r$, we can take $Q = I$. Next, we need to recalculate the matrix

$$C = \tilde{A}M^{-1} \in \mathbb{C}^{M \times r}.$$

Only the permutations of the rows occur in the matrix \tilde{A} , so let's concentrate on the matrix M recalculation. By appending the i -th row to the matrix \hat{A} , we obtain the matrix $\hat{A}' \in \mathbb{C}^{(k+1) \times r}$ of the form

$$\hat{A}' = \begin{bmatrix} Q^* \\ C_{i,:} \end{bmatrix} M.$$

Matrix $\begin{bmatrix} Q^* \\ C_{i,:} \end{bmatrix} \in \mathbb{C}^{(k+1) \times r}$ can be made unitary with the aid of the Householder reflector $HC^{r \times r}$ such that

$$C_{i,:}H = \begin{bmatrix} \|C_{i,:}\|_2 & 0 & \dots & 0 \end{bmatrix} = \begin{bmatrix} \sqrt{l_i} & 0 & \dots & 0 \end{bmatrix}$$

and through normalization of the first column by the matrix

$$D = \text{diag}\left(\frac{1}{\sqrt{1+l_i}}, 1, \dots, 1\right) \in \mathbb{C}^{r \times r}.$$

Eventually

$$\begin{aligned} \hat{A}' &= \begin{bmatrix} Q^* \\ C_{i,:} \end{bmatrix} HDD^{-1}HM = Q'D^{-1}HM = Q'M', \\ (M')^{-1} &= M^{-1}HD, \\ C' &= \tilde{A}'(M')^{-1} = \tilde{A}'M^{-1}HD, \end{aligned}$$

that is, we only need to rearrange the columns, make the reflection and multiply the first column by a number. The change in the 2-norm of the rows occurs only at the last multiplication and can easily be calculated in terms of the 2-norm of the first column.

Algorithm 9 Householder-based maxvol2

Input: Matrix $A \in \mathbb{C}^{M \times r}$, the starting set of row indices \mathcal{I} of cardinality r , the required final size n .

Output: \mathcal{I} , supplemented by $n - r$ row indices chosen greedily to maximize the volume.

```

1:  $C := A[A_{\mathcal{I},:}^{-1}, 0_{r \times (n-r)}]$ 
2:  $\text{current\_order} := \{1, \dots, M\}$ 
3:  $C.\text{swap}(\mathcal{I}, \{1, \dots, r\}, \text{current\_order})$ 
4:  $C := C_{\{r+1, \dots, M\}, :}$ 
5:  $l := 0_{M-r}$ 
6: for  $i := 1$  to  $M - r$  do
7:    $l_i := \|C_{i+r, :}\|_2^2$ 
8: end for
9: for  $\text{new\_size} := 1$  to  $n - r$  do
10:   $i := \arg \max_i l_i$ 
11:   $\text{current\_order}.\text{swap}(\text{new\_size} + r, i + r)$ 
12:   $l'_i := 1 + l_i$ 
13:   $l_i := l_{\text{new\_size}}$ 
14:   $l_{\text{new\_size}} := 0$ 
15:   $C_I := C_{i, :}$ 
16:   $\tau, v := \text{Householder}(C_I)$ 
17:   $C_{i, :} := C_{\text{new\_size}, :}$ 
18:   $C_{\text{new\_size}, :} := 0_r$ 
19:   $C := C - \tau \left( C \begin{bmatrix} 1 \\ v \end{bmatrix} \right) \begin{bmatrix} 1 & v^* \end{bmatrix}$ 
20:  for  $j := \text{new\_size}$  to  $M$  do
21:     $l_j := l_j - \left(1 - \frac{1}{l'_i}\right) |C'_{j,1}|^2$ 
22:  end for
23:   $C_{:,1} := C_{:,1} / \sqrt{l'_i}$ 
24: end for
25:  $\mathcal{I} := \text{current\_order}[1..n]$ 

```

Algorithm Dominant-C

Input: Matrix $A \in \mathbb{C}^{M \times r}$, the starting set of row indices \mathcal{I} of cardinality n . For example, $\mathcal{I} = \{1, \dots, n\}$.

Output: The updated set \mathcal{I} corresponding to a dominant rectangular submatrix.

```

1:  $C := AA_{\mathcal{I},:}^+$ 
2:  $\text{current\_order} := \{1, \dots, M\}$ 

```

```

3: C.swap( $\mathcal{I}, \{1, \dots, n\}, \text{current\_order}$ )
4:  $l := 0_M$ 
5: for  $i := 1$  to  $M$  do
6:    $l_i := \|C_{i,:}\|_2^2$ 
7: end for
8:  $B := 0_{M \times n}$ 
9: for  $i := n + 1$  to  $M$  do
10:  for  $j := 1$  to  $n$  do
11:     $B_{i,j} := |C_{i,j}|^2 + (1 + l_i)(1 - l_j)$ 
12:  end for
13: end for
14:
15:  $\{i, j\} := \arg \max_{i,j} B_{i,j}$ 
16: while  $B_{i,j} > 1$  do
17:   $C'_I := C_{i,:}^*/(1 + l_i)$ 
18:   $C' := CC'_I$ 
19:  for  $k := 1$  to  $M$  do
20:     $l'_k := l_k - |C'_k|^2(1 + l_i)$ 
21:  end for
22:   $C := C - C'C_{i,:}$ 
23:  C.swap( $i, j, \text{current\_order}$ )
24:   $C'.\text{swap}(i, j)$ 
25:   $l'.\text{swap}(i, j)$ 
26:  swap( $C_{:,j}, C'$ )
27:  for  $k := 1$  to  $M$  do
28:     $l_k := l'_k + |C'_k|^2/(1 - l'_i)$ 
29:  end for
30:   $C := C + C'(C_{i,:}/(1 - l'_i))$ 
31:  for  $i := n + 1$  to  $M$  do
32:    for  $j := 1$  to  $n$  do
33:       $B_{i,j} := |C_{i,j}|^2 + (1 + l_i)(1 - l_j)$ 
34:    end for
35:  end for
36:   $\{i, j\} := \arg \max_{i,j} B_{i,j}$ 
37: end while
38:  $\mathcal{I} := \text{current\_order}[1..n]$ 

```

Algorithm **Dominant-R** (modified RRQR from [8])

As in [8], the matrix sizes are denoted by m and n . The approximation rank is k . In our case $n \gg m$, while [8] considers the case $m \geq n$. A small value of n allows us not to worry about the update of $Q \in \mathbb{R}^{m \times r}$, and not to store it as a product of reflections.

Some changes in the notation:

vector γ contains squared lengths of the columns of C^T .

vector ω contains squared lengths of the rows of A^{-1} .

Input: Matrix $M \in \mathbb{R}^{m \times n}$, the starting set of column indices \mathcal{I} of cardinality r , threshold parameter $f \geq 1$. For example, $\mathcal{I} = \{1, \dots, r\}$.

Output: The updated set \mathcal{I} , corresponding to the dominant rectangular submatrix.

```
1: current_order := {1, ..., n}
2: M.swap_columns( $\mathcal{I}$ , {1, ..., k}, current_order) {the same as swap, but for columns.}
3: Q, A := QR( $M_{:, \mathcal{I}}$ )
4:  $\gamma := 0_{n-k}$ 
5: for i := 1 to n - k do
6:    $\gamma_i := \|M_{:, i+k}\|_2^2$ 
7: end for
8: B :=  $Q_{:, k}^T M$ 
9: for i := 1 to n - k do
10:   $\gamma_i := \gamma_i - \|B_{:, i+k}\|_2^2$ 
11: end for
12:  $\omega := 0_k$ 
13: for i := 1 to k do
14:   $\omega_i := \|A_{i,:}^{-1}\|_2^2$ 
15: end for
16:  $A^{-1}B := A^{-1} \cdot B$ 
17:  $m := \omega^T \gamma$ 
18: for i := 1 to k do
19:   for j := 1 to n - k do
20:     $m_{i,j} := m_{i,j} + |(A^{-1}B)_{i+k, j+k}|^2$ 
21:   end for
22: end for
23:  $\{i_1, j_1\} := \arg \max_{i_1, j_1} m_{i_1, j_1}$ 
24:  $\rho := m_{i_1, j_1}$ 

25: while  $\rho > f$  do

    {Exchange of  $i_1$  and k}
26: for i :=  $i_1$  to k - 1 do
27:    $\omega$ .swap(i, i + 1)
28:    $(A^{-1}B)$ .swap_columns(i, i + 1)
29:   A.swap(i, i + 1)
30:   M.swap_columns(i, i + 1, current_order)
31: end for
32: for i :=  $i_1$  to k - 1 do
33:    $\alpha, \beta := \text{givens}(A_{i,i}, A_{i+1,i})$  {see [7], page 240}
```

```

34:    $A_{i:i+1,i:k} := \begin{bmatrix} \alpha & -\beta \\ \beta & \alpha \end{bmatrix} A_{i:i+1,i:k}$ 
35:    $Q_{:,i:i+1} := Q_{:,i:i+1} \begin{bmatrix} \alpha & \beta \\ -\beta & \alpha \end{bmatrix}$ 
36: end for

      {Exchange k, k + 1, i1 => j1, k, k + 1}
37:    $b_c := M_{:,j1}$ 
38:    $M.swap\_columns(j1, k + 1, current\_order)$ 
39:    $\gamma.swap(j1, k + 1)$ 
40:    $(A^{-1}B).swap\_columns(j1, k + 1)$ 
41:    $c_1^T := A_{k,k}(A^{-1}B)_{k,k+2:n}$ 
42:    $A_{:,k} := A(A^{-1}B)_{:,k+1}$ 
43:    $\gamma v := \sqrt{c_{k+1}}$ 
44:    $\gamma := A_{k,k}$ 
45:    $b_1 := A_{1:k-1,k}$ 
46:    $q := (b_c - M_{:,1:k}(A^{-1}B)_{:,k+1})/(\gamma v)$ 
47:    $M.swap\_columns(k, k + 1, current\_order)$ 
48:    $c_2^T := q^T M_{:,k+2:n}$ 

      {Nullification of k-th column under the diagonal}
49:    $\alpha, \beta := \text{givens}(A_{k,k}, \gamma v)$ 
50:    $\begin{bmatrix} \gamma \mu / \rho & \bar{c}_1^T \\ \gamma v / \rho & \bar{c}_2^T \end{bmatrix} := \begin{bmatrix} \alpha & -\beta \\ \beta & \alpha \end{bmatrix} \begin{bmatrix} \gamma & c_1^T \\ 0 & c_2^T \end{bmatrix}$ 
51:    $A_{k,k} := \sqrt{(\gamma v)^2 + A_{k,k}^2}$ 

      {Update of  $\gamma$ }
52:    $\gamma_{k+1} := (\gamma v / \rho)^2$ 
53:   for  $i := k + 2$  to  $n$  do
54:      $\gamma_i := \gamma_i + |\bar{c}_2^T_{i-k-1}|^2 - |c_2^T_{i-k-1}|^2$ 
55:   end for

      {Update of  $\omega$ }
56:    $u := A_{k-1,k-1}.RTsolve(b_1)$  {Solving the system with the upper triangular matrix}
57:    $\omega_k := 1/A_{k,k}^2$ 
58:    $\mu := (A^{-1}B)_{k,k+1}$ 
59:    $\bar{\mu} := (A^{-1}B)_{1:\text{rank}-1,\text{rank}+1} + \mu u$ 
60:   for  $i := 1$  to  $k - 1$  do
61:      $\omega_i := \omega_i + \omega_k |\bar{\mu}_i|^2 - |u_i / \gamma|^2$ 
62:   end for

      {Update of  $A^{-1}B$ }

```

```

63:   $\mathbf{u}_1 := (\mathbf{A}^{-1}\mathbf{B})_{1:k-1,k+1}$ 
64:   $(\mathbf{A}^{-1}\mathbf{B})_{k,k+1} := (\gamma\mu/\rho)/A_{k,k}$ 
65:   $(\mathbf{A}^{-1}\mathbf{B})_{k,k+2:n} := \bar{\mathbf{c}}_1^\top/A_{k,k}$ 
66:   $(\mathbf{A}^{-1}\mathbf{B})_{1:k-1,k+1} := (1 - \mu(\mathbf{A}^{-1}\mathbf{B})_{k,k+1})\mathbf{u} - (\mathbf{A}^{-1}\mathbf{B})_{k,k+1}\mathbf{u}_1$ 
67:   $(\mathbf{A}^{-1}\mathbf{B})_{1:k-1,k+2:n} := (\mathbf{A}^{-1}\mathbf{B})_{1:k-1,k+2:n} + \mathbf{u}(\mathbf{c}_1^\top/\gamma - \mu\bar{\mathbf{c}}_1^\top/A_{k,k}) - \mathbf{u}_1\bar{\mathbf{c}}_1^\top/A_{k,k}$ 

68:   $\mathbf{m} := \omega^\top\gamma$ 
69:  for  $i := 1$  to  $k$  do
70:    for  $j := 1$  to  $n - k$  do
71:       $m_{i,j} := m_{i,j} + |(\mathbf{A}^{-1}\mathbf{B})_{i+k,j+k}|^2$ 
72:    end for
73:  end for
74:   $\{i_1, j_1\} := \arg \max_{i_1, j_1} m_{i_1, j_1}$ 
75:   $\rho := m_{i_1, j_1}$ 
76: end while
77:  $\mathcal{I} := \text{current\_order}[1..k]$ 

```

This is a modification of GEQR [8] without recalculation of the matrices $\mathbf{Q} \in \mathbb{R}^{m \times r}$, $\mathbf{B} \in \mathbb{R}^{r \times (n-r)}$ and $\mathbf{C}^\top \in \mathbb{R}^{(m-r) \times (n-r)}$. Thus in the complexity estimate of a single iteration, the coefficient of mn is reduced by two times.

All notations and updates are the same as in the original article [8]. We focus only on the main changes: removing the updates of \mathbf{B} and \mathbf{C} .

Getting rid of updating \mathbf{B} is quite simple: we need only the first row and the last column of \mathbf{B} , which are easily computed through $\mathbf{A} \in \mathbb{R}^{r \times r}$ and $\mathbf{A}^{-1}\mathbf{B} \in \mathbb{R}^{r \times (n-r)}$ (lines 41 and 42).

For the \mathbf{C}^\top , we only need to know the first row. Since unitary transformations were performed in GEQR [8] for the matrix \mathbf{C}^\top , the first element of this row is equal to the 2-norm of the first column (line 43). The other elements are obtained as scalar products with the $k+1$ -st column of \mathbf{Q} (q) (48).

To rotate, we still need to know $q = \mathbf{Q}_{:,k+1} \in \mathbb{R}^m$ (line 46). It is easily obtained from the column $\mathbf{b}_c \in \mathbb{R}^m$ of $\mathbf{M} \in \mathbb{R}^{m \times n}$ as a product of \mathbf{Q} by the last column of the extension of \mathbf{A} :

$$\mathbf{b}_c = \begin{bmatrix} \mathbf{Q}_{:,1:k} & \mathbf{Q}_{:,k+1} \end{bmatrix} \begin{bmatrix} \mathbf{A}_{:,k} \\ \gamma\mathbf{v} \end{bmatrix}.$$

Then we use the equality

$$\mathbf{Q}_{:,1:k}\mathbf{A}_{:,k} = \mathbf{M}_{:,1:k}(\mathbf{A}^{-1}\mathbf{B})_{:,k+1}$$

Compared to GEQR [8] we save one product of vectors of size $m - k$ and $n - k$ and one addition with $(m - k) \times (n - k)$ matrix. Update of \mathbf{C} also contains a matrix by vector multiplication. In Dominant-R we multiply the $m \times (n - k)$ matrix by a vector.

We can apply the same approach to append the columns. We do not repeat the derivation; the description of the original algorithm is in [8]. Here the benefit is even greater if we use $\mathbf{A}^{-1}\mathbf{B}$ later in Dominant-R or in maxvol.

As before, $k = 1$ is not considered separately, although many operations disappear in this case. The maximum k is denoted by r .

Algorithm pre-maxvol (modification of the column addition in RRQR from [8])

Input: Matrix $M \in \mathbb{R}^{m \times n}$, the required rank r .

Output: Set of column indices \mathcal{I} of cardinality r , corresponding to the submatrix, whose volume differs from the maximum by no more than $r!$ times.

```

1:  $\mathcal{I} := \emptyset$ 
2:  $A^{-1}B := 0_{r \times n}$ 
3:  $\gamma := 0_n$ 
4: for  $i := 1$  to  $n$  do
5:    $\gamma_i := \|M_{:,i}\|_2^2$ 
6: end for
7:  $j := \arg \max_j \gamma_j$ 
8: for  $k := 1$  to  $r$  do
9:    $\mathcal{I} := \mathcal{I} \cup \{j\}$ 

   {Exchange of  $j$  and  $k$ }
10:   $b_c := M_{:,j}$ 
11:   $M.swap\_columns(j, k, current\_order)$ 
12:   $\gamma.swap(j, k)$ 
13:   $(A^{-1}B).swap\_columns(j, k)$ 
14:   $\gamma v := \sqrt{c_k}$ 
15:   $q := (b_c - M_{:,1:k-1}(A^{-1}B)_{1:k-1,k})/(\gamma v)$ 
16:   $c_2^T := q^T M_{:,k+1:n}$ 

   {Update of  $\gamma$ }
17:   $\gamma_k := 0$ 
18:  for  $i := k + 1$  to  $n$  do
19:     $\gamma_i := \gamma_i - |(c_2^T)_{i-k}|^2$ 
20:  end for

   {Update of  $A^{-1}B$ }
21:   $(A^{-1}B)_{k,k+1:n} := c_2^T/A_{k,k}$ 
22:   $(A^{-1}B)_{1:k-1,k+1:n} := (A^{-1}B)_{1:k-1,k+1:n} - (A^{-1}B)_{1:k-1,k+1}(A^{-1}B)_{k,k+1:n}$ 

23:   $j := \arg \max_j \gamma_j$ 
24: end for

```

B Acknowledgments

The work was supported by the Russian Science Foundation, Grant 14-11-00806.

References

- [1] Goreinov S.A., Tyrtyshnikov E.E. The maximal-volume concept in approximation by low-rank matrices // Contemporary Mathematics. — 2001. — Vol. 268. — P. 47–51.
- [2] Goreinov S.A., Tyrtyshnikov E.E. Quasioptimality of skeleton approximation of a matrix in the Chebyshev norm // Doklady Mathematics. — 2011. — Vol. 83, no. 3. — P. 1–2.
- [3] A.I. Osinsky, N.L. Zamarashkin. Pseudo-skeleton approximations with better accuracy estimates // Linear Algebra and its Applications — 2018. — Vol. 537. — P. 221-249.
- [4] C.-T. Pan, On the existence and computation of rank revealing LU factorizations // Linear Algebra and its Applications — 2000. — Vol. 316. — P. 199–222.
- [5] How to find a good submatrix / S.A. Goreinov, I.V. Oseledets, D.V. Savostyanov et al. // Matrix Methods: Theory, Algorithms, Applications / Ed. by V. Olshevsky, E. Tyrtyshnikov. — World Scientific Publishing, 2010. — P. 247-256.
- [6] A. Deshpande and S. Vempala. Adaptive sampling and fast low-rank matrix approximation // Approximation, randomization and combinatorial optimization — 2006. — Vol. 4110 of LNCS, Springer, Berlin. — P. 292–303.
- [7] G. H. Golub and C. F. Van Loan. Matrix Computations. — 4th ed. — The Johns Hopkins University Press, Baltimore, MD, 2013.
- [8] M. Gu, S. C. Eisenstat, efficient algorithms for computing a strong rank-revealing qr factorization // SIAM J. Sci. COMPUT. — 1996. — Vol. 17, no. 4. — P. 848-869.
- [9] Ali Çivril, Malik Magdon-Ismail. On selecting a maximum volume sub-matrix of a matrix and related problems // Theoretical Computer Science. — 2009. — Vol. 410, no. 47-49. — P. 4801–4811.
- [10] M. Bebendorf. Approximation of boundary element matrices // Numerische Mathematic. — 2000. — Vol. 86. — P. 565–589.
- [11] Mikhalev A.Y., Oseledets I.V. Rectangular submatrices of maximum volume and their computation // Doklady Mathematics — 2015. — Vol. 91, no. 3. — P. 267-268.
- [12] Mikhalev A.Y., Oseledets I.V. Rectangular maximum-volume submatrices and their applications // Linear Algebra and its Applications. — 2018. — Vol. 538. — P. 187–211.
- [13] H. Avron and C. Boutsidis. Faster Subset Selection for Matrices and Applications // SIAM J. Matrix Anal. Appl. — 2011. — Vol. 34, no. 4.
- [14] C. Boutsidis, P. Drineas, M. Magdon-Ismail. Near-optimal column-based matrix reconstruction // SIAM Journal on Computing — 2013.

- [15] Zamarashkin N.L., Osinsky A.I. On the Existence of a Nearly Optimal Skeleton Approximation of a Matrix in the Frobenius Norm // *Doklady Mathematics* — 2018. — Vol. 97, no. 2. — P. 164-166.
- [16] S. Matveev, A.P. Smirnov, E. E. Tyrtysnikov. A fast numerical method for the Cauchy problem for the Smoluchowski equation // *Journal of Computational Physics* — 2014. — Vol. 282, no. FEB. — P. 23–32.
- [17] C. Boutsidis and D. P. Woodruff. Optimal cur matrix decompositions // *Proceedings of the 46th Annual ACM Symposium on Theory of Computing, ACM.* — 2014 — P. 353–362.
- [18] A. Deshpande, L. Rademacher et al. Matrix Approximation and Projective Clustering via Volume Sampling // *Theory of Computing.* — 2006. — Vol. 2. — P. 225–247.