

From Lagrangian mechanics to nonequilibrium thermodynamics: a variational perspective

François Gay-Balmaz
 CNRS - Ecole Normale Supérieure
 Laboratoire de météorologie dynamique
 24 Rue Lhomond 75005 Paris, France
 francois.gay-balmaz@lmd.ens.fr

Hiroaki Yoshimura
 School of Science and Engineering
 Waseda University
 Okubo, Shinjuku, Tokyo 169-8555, Japan
 yoshimura@waseda.jp

Abstract

In this paper, we survey our recent results on the variational formulation of nonequilibrium thermodynamics for the finite dimensional case of discrete systems as well as for the infinite dimensional case of continuum systems. Starting with the fundamental variational principle of classical mechanics, namely, Hamilton's principle, we show, with the help of thermodynamic systems with gradually increasing level complexity, how to systematically extend it to include irreversible processes. In the finite dimensional cases, we treat systems experiencing the irreversible processes of mechanical friction, heat and mass transfer, both in the adiabatically closed and in the open cases. On the continuum side, we illustrate our theory with the example of multicomponent Navier-Stokes-Fourier systems.

Contents

1	Introduction	2
2	Variational principles in Lagrangian mechanics	4
2.1	Classical mechanics	4
2.2	Continuum mechanics	7
2.3	Lagrangian reduction by symmetry	9
3	Variational formulation for discrete thermodynamic systems	10
3.1	Adiabatically closed simple thermodynamic systems	12
3.2	Adiabatically closed non-simple thermodynamic systems	19
3.3	Open thermodynamic systems	27
4	Variational formulation for continuum thermodynamic systems	33
4.1	Variational formulation in the Lagrangian description	34
4.2	Variational formulation in the Eulerian description	35
5	Concluding remarks	37

1 Introduction

This paper makes a review of our recent results on the development of a variational formulation of nonequilibrium thermodynamics, as established in [Gay-Balmaz and Yoshimura \[2017a,b, 2018a,b\]](#). This formulation is an extension to nonequilibrium thermodynamics of the Lagrangian formulation of classical and continuum mechanics which includes irreversible processes such as friction, heat and mass transfer, chemical reactions, and viscosity.

Some history of the variational approaches to thermodynamics. Thermodynamics was first developed to treat exclusively equilibrium states and the transition from one equilibrium state to another in which change in temperature plays an important role. In this context, thermodynamics appeared mainly as a theory of heat and is viewed today as a branch of *equilibrium thermodynamics*. Such a classical theory, *which does not aim to describe the time evolution* of the system, can be developed in a well-established setting ([Gibbs \[1902\]](#)), governed by the well-known first and second laws, e.g., [Callen \[1985\]](#), [Landau and Lifshitz \[1969\]](#). It is worth noting that classical mechanics, fluid dynamics and electromagnetism, being essentially dynamical theories, *cannot* be treated in the context of equilibrium thermodynamics. Although much effort has been done in the theoretical investigation of nonequilibrium thermodynamics in relation with physics, chemistry, biology and engineering, the theory of nonequilibrium thermodynamics has not reached a level of completeness. This is in part due to the lack of a general variational formulation for nonequilibrium thermodynamics that would reduce to the classical Lagrangian variational formulation of mechanics in absence of irreversible processes. So far, various variational approaches have been proposed in relation with nonequilibrium thermodynamics such as the *principle of least dissipation of energy* introduced in [Onsager \[1931\]](#) later extended in [Onsager and Machlup \[1953\]](#) and [Machlup and Onsager \[1953\]](#) that underlies the reciprocal relations in linear phenomenological laws, and the *principle of minimum entropy production* by [Prigogine \[1947\]](#) and [Glansdorff and Prigogine \[1971\]](#) that gives conditions on steady state processes. Onsager’s approach was generalized in [Ziegler \[1968\]](#) to the case of systems with nonlinear phenomenological laws. We refer to [Gyarmati \[1970\]](#) for reviews and developments of Onsager’s variational principles, and for a study of the relation between Onsager’s and Prigogine’s principles. We also refer to [Lavenda \[1978, §6\]](#) and [Ichiyanagi \[1994\]](#) for overviews on variational approaches to irreversible processes. Note that, however, the variational principles developed in these past works are not natural extensions of Hamilton’s principle of classical mechanics, because they do not recover Hamilton’s principle for the case in which irreversible processes are not included. Another important work was done by [Biot \[1975, 1984\]](#) in conjunction with thermoelasticity, viscoelasticity and heat transfer, where a *principle of virtual dissipation* in a generalized form of d’Alembert principle was used with various applications to nonlinear irreversible thermodynamics. In particular, [Biot \[1975\]](#) mentioned that the relations between the rate of entropy production and state variables may be given as *nonholonomic constraints*. Nevertheless, this variational approach was restricted to *weakly irreversible systems* or *thermodynamically holonomic and quasi-holonomic*. More recently, it was noteworthy that [Fukagawa and Fujitani \[2012\]](#) showed a variational formulation for viscoelastic fluids, in which the internal conversion of mechanical power into heat power due to frictional forces was written as a nonholonomic constraint. However, it should be noted that the approaches mentioned above do not present a systematic and general variational formulation of nonequilibrium thermodynamics and hence are restricted to some class of thermodynamic systems.

The geometry of *equilibrium* thermodynamics has been mainly studied via contact geometry, following the initial works of [Gibbs \[1873a,b\]](#) and [Carathéodory \[1909\]](#), by [Hermann \[1973\]](#) and further developments by [Mrugala \[1978, 1980\]](#); [Mrugala, Nulton, Schon, and Sala-](#)

mon [1991]. In this geometric setting, thermodynamic properties are encoded by Legendre submanifolds of the thermodynamic phase space. A step towards a geometric formulation of irreversible processes was made in Eberard, Maschke, and van der Schaft [2007] by lifting port Hamiltonian systems to the thermodynamic phase space. The underlying geometric structure in this construction is again a contact form. A description of irreversible processes using modifications of Poisson brackets has been initiated in Grmela [1984]; Kaufman [1984]; Morrison [1984]. This has been further developed for instance in Edwards and Beris [1991a,b] and Morrison [1986]; Grmela and Öttinger [1997]; Öttinger and Grmela [1997]. A systematic construction of such brackets from the variational formulation given in the present paper was presented in Eldred and Gay-Balmaz [2018] for the thermodynamics of multicomponent fluids.

Main features of our variational formulation. The variational formulation for nonequilibrium thermodynamics developed in Gay-Balmaz and Yoshimura [2017a,b, 2018a,b] is distinct from the earlier variational approaches mentioned above, both in its physical meaning and in its mathematical structure, as well as in its goal. Roughly speaking, while most of the earlier variational approaches mainly underlie the equation for the rate of entropy production, in order to justify the expression of the phenomenological laws governing the irreversible processes involved, our variational approach aims to underlie the *complete set of time evolution equations of the system*, in such a way that it extends the classical Lagrangian formulation in mechanics to nonequilibrium thermodynamic systems including irreversible processes.

This is accomplished by constructing a generalization of the *Lagrange-d'Alembert principle* of nonholonomic mechanics, where the entropy production of the system, written as the sum of the contribution of each of the irreversible processes, is incorporated into a *nonlinear nonholonomic constraint*. As a consequence, all the *phenomenological laws* are encoded in the nonlinear nonholonomic constraints, to which we naturally associate a *variational constraint* on the allowed variations of the action functional. A natural definition of the variational constraint in terms of the phenomenological constraint is possible thanks to the introduction of the concept of *thermodynamic displacement*, which generalizes the concept of thermal displacement given by Green and Naghdi [1991] to all the irreversible processes.

More concretely, if the system involves internal irreversible processes, denoted α , and irreversible process at the ports, denoted β , with thermodynamic fluxes J_α, J_β and thermodynamic affinities X^α, X^β together with a thermodynamic affinity X_{ext}^β associated with the exterior, then the thermodynamic displacements $\Lambda^\alpha, \Lambda^\beta$ are such that $\dot{\Lambda}^\alpha = X^\alpha$ and $\dot{\Lambda}^\beta = X^\beta$. This allows us to formulate the variational constraint associated to the phenomenological constraint in a systematic way, namely, by replacing all the velocities by their corresponding virtual displacement and by removing the external thermodynamic affinity X_{ext}^β at the exterior of the system as follows:

$$J_\alpha \dot{\Lambda}^\alpha + J_\beta (\dot{\Lambda}^\beta - X_{\text{ext}}^\beta) \rightsquigarrow J_\alpha \delta \Lambda^\alpha + J_\beta \delta \Lambda^\beta.$$

Our variational formulation has thus a clear and systematic structure that appears to be common for the macroscopic description of the nonequilibrium thermodynamics of physical systems. It can be applied to the finite dimensional case of discrete systems such as classical mechanics, electric circuits, chemical reactions, and mass transfer. Further, our variational approach can be naturally extended to the infinite dimensional case of continuum systems; for instance, it can be applied to some nontrivial example such as the *multicomponent Navier-Stokes-Fourier equations*. Again, it is emphasized that our variational formulation consistently recovers Hamilton's principle in classical mechanics when irreversible processes are not taken into account.

Organization of the paper. In §2, we start with a very elementary review of Hamilton’s variational principle in classical mechanics and its extension to the case of mechanical systems with external forces. We also make a brief review of the variational formulation of mechanical systems with linear nonholonomic constraints by using the Lagrange-d’Alembert principle. Furthermore, we review the extension of Hamilton’s principle to continuum systems and illustrate it with the example of compressible fluids in the Lagrangian description. The variational principle in the Eulerian description is then deduced in the context of *symmetry reduction*. In §3, we recall the two laws of thermodynamics as formulated by [Stueckelberg and Scheurer \[1974\]](#), and we present the variational formulation of nonequilibrium thermodynamics for the finite dimensional case of discrete systems. We first consider adiabatically closed simple systems and illustrate the variational formulation with the case of a movable piston containing an ideal gas and with a system consisting of a chemical species experiencing diffusion between several compartments. We then consider adiabatically closed non-simple systems such as the adiabatic piston with two cylinders and a system with a chemical species experiencing both diffusion and heat conduction between two compartments. Further we consider the variational formulation for open systems and illustrate it with the example of a piston device with ports and heat sources. In §4, we extend the variational formulation of nonequilibrium thermodynamics to the infinite dimensional case of continuum systems and consider a multicomponent compressible fluid subject to the irreversible processes due to viscosity, heat conduction, and diffusion. The variational formulation is first given in the Lagrangian description, from which the variational formulation in the Eulerian description is deduced. This is illustrated with the multicomponent Navier-Stokes-Fourier equations. In §5, we make some concluding remarks and mention further developments based on the variational formulation of nonequilibrium thermodynamics such as variational discretizations, Dirac structures in thermodynamics, reduction by symmetries, and thermodynamically consistent modeling.

2 Variational principles in Lagrangian mechanics

2.1 Classical mechanics

One of the most fundamental statement in classical mechanics is the principle of critical action or Hamilton’s principle, according to which the motion of a mechanical system between two given positions is given by a curve that makes the integral of the Lagrangian of the system to be critical (see, for instance, [Landau and Lifshitz \[1969\]](#)).

Let us consider a mechanical system with configuration manifold Q . For instance, for a system of N particles moving in the Euclidean 3-space, the configuration manifold is $Q = \mathbb{R}^{3N}$, whereas for a rigid body moving freely in space, $Q = \mathbb{R}^3 \times SO(3)$, the product of the Euclidean 3-space and the rotation group. Let us denote by (q^1, \dots, q^n) the local coordinates of the manifold Q , also known as generalized coordinates of the mechanical system. Let L be a given Lagrangian of the system, which usually depends only on the position q and velocity v of the system and is hence defined on the tangent bundle¹, or *velocity phase space*, TQ of the manifold Q . The Lagrangian L is usually given by the kinetic minus the potential energy of the system as $L(q, v) = K(q, v) - U(q)$.

Hamilton’s principle is written as follows. Suppose that the system occupies the positions q_1 and q_2 at the time t_1 and t_2 , then the motion $q(t)$ of the mechanical system between

¹The *tangent bundle* of a manifold Q is the manifold TQ given by the collection of all tangent vectors in Q . As a set it is given by the disjoint union of the *tangent spaces* of Q , that is, $TQ = \sqcup_{q \in Q} T_q Q$, where $T_q Q$ is the tangent space to Q at q . The elements in $T_q Q$ are denoted (q, v) .

these two positions is a solution of the critical point condition

$$\frac{d}{d\epsilon} \Big|_{\epsilon=0} \int_{t_1}^{t_2} L(q(t, \epsilon), \dot{q}(t, \epsilon)) dt = 0, \quad (2.1)$$

where $q(t, \epsilon)$, $t \in [t_1, t_2]$, $\epsilon \in [-a, a]$, is an arbitrary variation of the curve $q(t)$ with fixed endpoints, i.e., $q(t, \epsilon)|_{\epsilon=0} = q(t)$ and $q(t_1, \epsilon) = q(t_1)$, $q(t_2, \epsilon) = q(t_2)$, for all ϵ . The infinitesimal variation associated to a given variation $q(t, \epsilon)$ is denoted by

$$\delta q(t) := \frac{d}{d\epsilon} \Big|_{\epsilon=0} q(t, \epsilon).$$

From the fixed endpoint conditions, we have $\delta q(t_1) = \delta q(t_2) = 0$.

The Hamilton principle (2.1) is usually written shortly as

$$\delta \int_{t_1}^{t_2} L(q, \dot{q}) dt = 0, \quad (2.2)$$

for arbitrary infinitesimal variations δq with $\delta q(t_1) = \delta q(t_2) = 0$. Throughout this paper, we shall always use this short notation for the variational principles and also simply refer to δq as variations.

A direct application of (2.1) gives, in local coordinates $q = (q^1, \dots, q^n)$,

$$\begin{aligned} \delta \int_{t_1}^{t_2} L(q, \dot{q}) dt &= \int_{t_1}^{t_2} \left[\frac{\partial L}{\partial q^i} \delta q^i + \frac{\partial L}{\partial \dot{q}^i} \delta \dot{q}^i \right] dt \\ &= \int_{t_1}^{t_2} \left[\frac{\partial L}{\partial q^i} - \frac{d}{dt} \frac{\partial L}{\partial \dot{q}^i} \right] \delta q^i dt + \left[\frac{\partial L}{\partial \dot{q}^i} \delta q^i \right]_{t_1}^{t_2}, \end{aligned} \quad (2.3)$$

where we employ Einstein's summation convention. Since δq is arbitrary and since the boundary term vanishes because of the fixed endpoint conditions, we get from (2.3) the *Euler-Lagrange equations*

$$\frac{d}{dt} \frac{\partial L}{\partial \dot{q}^i} - \frac{\partial L}{\partial q^i} = 0, \quad i = 1, \dots, n. \quad (2.4)$$

We recall that L is called *regular*, when the Legendre transform $\mathbb{F}L : TQ \rightarrow T^*Q$, locally given by $(q^i, v^i) \mapsto (q^i, \frac{\partial L}{\partial v^i})$, is a local diffeomorphism, where T^*Q denotes the cotangent bundle², or *momentum phase space*, of Q . When L is regular, the Euler-Lagrange equations (2.4) yield a second-order differential equation for the curve $q(t)$.

The energy of a mechanical system with Lagrangian L is defined on TQ by

$$E(q, v) = \left\langle \frac{\partial L}{\partial v}, v \right\rangle - L(q, v), \quad (2.5)$$

where $\langle \cdot, \cdot \rangle$ denotes a dual pairing between the elements in T_q^*Q and T_qQ . It is easy to check that E is conserved along the solutions of the Euler-Lagrange equations (2.4), namely,

$$\frac{d}{dt} E(q, \dot{q}) = \left(\frac{d}{dt} \frac{\partial L}{\partial \dot{q}^i} - \frac{\partial L}{\partial q^i} \right) \dot{q}^i = 0.$$

²The cotangent bundle of a manifold Q is the manifold $T^*Q = \cup_{q \in Q} T_q^*Q$, where T_q^*Q is the *cotangent space* at each q given as the dual space to T_qQ . The elements in T_q^*Q are covectors, denoted by (q, p) .

Let us assume that the mechanical system is subject to an external force, given by a map $F^{\text{ext}} : TQ \rightarrow T^*Q$ assumed to be fiber preserving, i.e. $F^{\text{ext}}(q, v) \in T_q^*Q$ for all $(q, v) \in T_qQ$. The extension of (2.2) to forced mechanical systems is given by

$$\delta \int_{t_1}^{t_2} L(q, \dot{q}) dt + \int_{t_1}^{t_2} \langle F^{\text{ext}}(q, \dot{q}), \delta q \rangle dt = 0, \quad (2.6)$$

for arbitrary variations δq with $\delta q(t_1) = \delta q(t_2) = 0$. The second term in (2.6) is the time integral of the virtual work $\langle F^{\text{ext}}(q, \dot{q}), \delta q \rangle$ done by the force field $F^{\text{ext}} : TQ \rightarrow T^*Q$ with a virtual displacement δq in TQ . The principle (2.6) gives the *forced Euler-Lagrange equations*

$$\frac{d}{dt} \frac{\partial L}{\partial \dot{q}^i} - \frac{\partial L}{\partial q^i} = F_i^{\text{ext}}. \quad (2.7)$$

Systems with nonholonomic constraints. Hamilton's principle recalled above is only valid for *holonomic* systems, i.e., systems without constraints or whose constraints are given by functions of the coordinates only, not the velocities. In geometric terms, such constraints are obtained by the specification of a submanifold N of the configuration manifold Q . In this case, the equations of motion are still given by Hamilton's principle for the Lagrangian L restricted to the tangent bundle TN of the submanifold $N \subset Q$.

When the constraints cannot be reduced to relations between the coordinates only, they are called *nonholonomic*. Here, we restrict the discussion to nonholonomic constraints that are linear in velocity. Such constraints are locally given in the form

$$\omega_i^\alpha(q) \dot{q}^i = 0, \quad \alpha = 1, \dots, k < n, \quad (2.8)$$

where ω_i^α are functions of local coordinates $q = (q^1, \dots, q^n)$ on Q . Intrinsically the functions ω_i^α are the components of k independent one-forms ω^α on Q , i.e., $\omega^\alpha = \omega_i^\alpha dq^i$, for $\alpha = 1, \dots, k$. Typical examples of linear nonholonomic constraints are those imposed on the motion of rolling bodies, namely that the velocities of the points in contact should be identical.

For systems with nonholonomic constraints (2.8), the corresponding equations of motion can be derived from a modification of the Hamilton principle called the *Lagrange-d'Alembert principle*, which is given by

$$\delta \int_{t_1}^{t_2} L(q, \dot{q}) dt = 0, \quad (2.9)$$

for variations δq subject to the condition

$$\omega_i^\alpha(q) \delta q^i = 0, \quad \alpha = 1, \dots, k < n, \quad (2.10)$$

together with the fixed endpoint conditions $\delta q(t_1) = \delta q(t_2) = 0$. Note the occurrence of two constraints with distinct roles. First there is the constraint (2.8) on the solution curve called the *kinematic constraint*. Second, there is the constraint (2.10) on the variations used in the principle, referred to as the *variational constraint*. Later, we show that this distinction becomes more noticeable in nonequilibrium thermodynamics.

A direct application of (2.9)–(2.10) yields the *Lagrange-d'Alembert equations*

$$\frac{d}{dt} \frac{\partial L}{\partial \dot{q}^i} - \frac{\partial L}{\partial q^i} = \lambda_\alpha \omega_i^\alpha. \quad (2.11)$$

These equations, together with the constraints equations (2.8), form a complete set of equations for the unknown curves $q^i(t)$ and $\lambda_\alpha(t)$.

For more information on nonholonomic mechanics, the reader can consult [Neimark and Fufaev \[1969\]](#), [Arnold, Kozlov, and Neishtadt \[1988\]](#), or [Bloch \[2003\]](#). Note that the Lagrange-d'Alembert principle (2.9) is *not* a critical curve condition for the action integral *restricted to the space of curve satisfying the constraints*. Such a principle, which imposes the constraint via a Lagrange multiplier, gives equations that are in general not equivalent to the Lagrange-d'Alembert equations (2.11), see, e.g., [Lewis and Murray \[1995\]](#), [Bloch \[2003\]](#). Such equations are sometimes referred to as the vakonomic equations.

2.2 Continuum mechanics

Hamilton's principle admits a natural extension to continuum systems such as fluid and elasticity. For such systems the configuration manifold Q is typically a manifold of maps. We shall restrict here to fluid mechanics in a fixed domain $\mathcal{D} \subset \mathbb{R}^3$, assumed to be bounded with smooth boundary $\partial\mathcal{D}$. Hamilton's principle for fluid mechanics in the Lagrangian description has been discussed at least since the works of [Herivel \[1955\]](#), for an incompressible fluid and [Serrin \[1959\]](#) and [Eckart \[1960\]](#) for compressible flows, see also [Truesdell and Toupin \[1960\]](#) for further references on these early developments. Hamilton's principle has since then been an important modelling tool in continuum mechanics.

Configuration manifolds. For fluid mechanics in a fixed domain, and before the occurrence of any shocks, the configuration space can be taken as the manifold $Q = \text{Diff}(\mathcal{D})$ ³ of diffeomorphisms of \mathcal{D} . The tangent bundle to $\text{Diff}(\mathcal{D})$ is formally given by the set of vector fields on \mathcal{D} covering a diffeomorphism φ and tangent to the boundary, i.e., for each $\varphi \in \text{Diff}(\mathcal{D})$, we have

$$T_\varphi \text{Diff}(\mathcal{D}) = \{\mathbf{V} : \mathcal{D} \rightarrow T\mathcal{D} \mid \mathbf{V}(X) \in T_{\varphi(X)}\mathcal{D}, \forall X \in \mathcal{D}, \mathbf{V}(X) \in T_{\varphi(X)}\partial\mathcal{D}, \forall X \in \partial\mathcal{D}\}.$$

The motion of the fluid is fully described by a curve $\varphi_t \in \text{Diff}(\mathcal{D})$ giving the position $x = \varphi_t(X)$ at time t of a fluid particle with label $X \in \mathcal{D}$. The vector field $\mathbf{V}_t \in T_{\varphi_t} \text{Diff}(\mathcal{D})$ defined by $\mathbf{V}_t(X) = \frac{d}{dt}\varphi_t(X)$ is the material velocity of the fluid. In local coordinates, we write $x^a = \varphi_t^a(X^A)$ and $\mathbf{V}_t^a(X^A) = \frac{d}{dt}\varphi_t^a(X^A)$.

Hamilton's principle. Given a Lagrangian $L : TQ \rightarrow \mathbb{R}$ defined on the tangent bundle of the infinite dimensional manifold $Q = \text{Diff}(\mathcal{D})$, Hamilton's principle takes formally the same form as (2.2), namely

$$\delta \int_{t_1}^{t_2} L(\varphi, \dot{\varphi}) dt = 0, \quad (2.12)$$

for variations $\delta\varphi$ such that $\delta\varphi_{t_1} = \delta\varphi_{t_2} = 0$.

Let us consider a Lagrangian of the general form

$$L(\varphi, \dot{\varphi}) = \int_{\mathcal{D}} \mathcal{L}(\varphi(X), \dot{\varphi}(X), \nabla\varphi(X)) d^3X,$$

with \mathcal{L} the Lagrangian density and $\nabla\varphi$ the Jacobian matrix of φ , known as the deformation

³In this paper, we do not describe the functional analytic setting needed to rigorously work in the framework of infinite dimensional manifolds. For example, one can assume that the diffeomorphisms are of some given Sobolev class, regular enough (at least of class C^1), so that $\text{Diff}(\mathcal{D})$ is a smooth infinite dimensional manifold and a topological group with smooth right translation.

gradient in continuum mechanics. The variation of the integral yields

$$\begin{aligned} \delta \int_{t_1}^{t_2} L(\varphi, \dot{\varphi}) dt &= \int_{t_1}^{t_2} \int_{\mathcal{D}} \left[\frac{\partial \mathcal{L}}{\partial \varphi^a} \delta \varphi^a + \frac{\partial \mathcal{L}}{\partial \dot{\varphi}^a} \delta \dot{\varphi}^a + \frac{\partial \mathcal{L}}{\partial \varphi_{,A}^a} \delta \varphi_{,A}^a \right] d^3 X dt \\ &= \int_{t_1}^{t_2} \int_{\mathcal{D}} \left[\frac{\partial \mathcal{L}}{\partial \varphi^a} \delta \varphi^a - \frac{\partial}{\partial t} \frac{\partial \mathcal{L}}{\partial \dot{\varphi}^a} - \frac{\partial}{\partial A} \frac{\partial \mathcal{L}}{\partial \varphi_{,A}^a} \right] \delta \varphi^a d^3 X dt \\ &\quad + \int_{\mathcal{D}} \left[\frac{\partial \mathcal{L}}{\partial \dot{\varphi}^a} \delta \varphi^a \right]_{t_1}^{t_2} d^3 X + \int_{t_1}^{t_2} \int_{\partial \mathcal{D}} \frac{\partial \mathcal{L}}{\partial \varphi_{,A}^a} \mathbf{N}_A \delta \varphi^a dS dt, \end{aligned}$$

where \mathbf{N} is the outward pointing unit normal vector field to the boundary $\partial \mathcal{D}$ and dS denotes the area element on the surface $\partial \mathcal{D}$. Hamilton's principle thus yields the Euler-Lagrange equations and the boundary condition

$$\frac{\partial}{\partial t} \frac{\partial \mathcal{L}}{\partial \dot{\varphi}} + \text{DIV} \frac{\partial \mathcal{L}}{\partial \nabla \varphi} = \frac{\partial \mathcal{L}}{\partial \varphi} \quad \text{and} \quad \frac{\partial \mathcal{L}}{\partial \nabla \varphi} \cdot \mathbf{N} \Big|_{T\partial \mathcal{D}} = 0 \quad \text{on } \partial \mathcal{D}, \quad (2.13)$$

where the divergence operator is defined as $(\text{DIV} \frac{\partial \mathcal{L}}{\partial \nabla \varphi})_a = \frac{\partial}{\partial A} \frac{\partial \mathcal{L}}{\partial \varphi_{,A}^a}$. The tensor field

$$\mathbf{P} := -\frac{\partial \mathcal{L}}{\partial \nabla \varphi}, \quad \text{i.e.} \quad \mathbf{P}_a^A = -\frac{\partial \mathcal{L}}{\partial \varphi_{,A}^a} \quad (2.14)$$

is called the *first Piola-Kirchhoff stress tensor*, see, e.g., [Marsden and Hughes \[1983\]](#).

The Lagrangian of the compressible fluid. For a compressible fluid, the Lagrangian has the standard form

$$\begin{aligned} L(\varphi, \dot{\varphi}) &= K(\varphi, \dot{\varphi}) - U(\varphi) \\ &= \int_{\mathcal{D}} \left[\frac{1}{2} \varrho_{\text{ref}}(X) |\dot{\varphi}(X)|^2 - \mathcal{E}(\varrho_{\text{ref}}(X), S_{\text{ref}}(X), \nabla \varphi(X)) \right] d^3 X, \end{aligned} \quad (2.15)$$

with $\varrho_{\text{ref}}(X)$ and $S_{\text{ref}}(X)$ the mass density and entropy density in the reference configuration. The two terms in (2.15) are, respectively, the total kinetic energy of the fluid and minus the total internal energy of the fluid. The function \mathcal{E} is a general expression for the internal energy density written in terms of $\varrho_{\text{ref}}(X)$, $S_{\text{ref}}(X)$, and the deformation gradient $\nabla \varphi(X)$. For fluids \mathcal{E} depends on the deformation gradient only through the Jacobian of φ denoted J_φ . This fact is compatible with the material covariance property of \mathcal{E} , written as

$$\mathcal{E}(\psi^* \varrho_{\text{ref}}, \psi^* S_{\text{ref}}, \nabla(\varphi \circ \psi)) = \psi^* [\mathcal{E}(\varrho_{\text{ref}}, S_{\text{ref}}, \nabla \varphi)], \quad \text{for all } \psi \in \text{Diff}(\mathcal{D}), \quad (2.16)$$

where the pull-back notation is defined as

$$\varphi^* f = (f \circ \varphi) J_\varphi \quad (2.17)$$

for some function f defined on \mathcal{D} . From (2.16) we deduce the existence of a function ϵ such that

$$\mathcal{E}(\varrho_{\text{ref}}, S_{\text{ref}}, \nabla \varphi) = \varphi^* [\epsilon(\rho, s)], \quad \text{for } \rho = \varphi_* \varrho_{\text{ref}}, \quad s = \varphi_* S_{\text{ref}}, \quad (2.18)$$

see [Marsden and Hughes \[1983\]](#), [Gay-Balmaz, Marsden, and Ratiu \[2012\]](#). The function $\epsilon = \epsilon(\rho, s)$ is the internal energy density in the spatial description, expressed in terms of the mass density ρ and entropy density s in the spatial description.

For the Lagrangian (2.15) and with the assumption (2.16), the first Piola-Kirchhoff stress tensor (2.14) and its divergence are computed as

$$\mathbf{P}_a^A = \frac{\partial \mathcal{E}}{\partial \varphi^a_{,A}} = -p J_\varphi (\varphi^{-1})_{,a}^A \quad \text{and} \quad \text{DIV } \mathbf{P} = (\nabla p \circ \varphi) J_\varphi, \quad (2.19)$$

where $p = \frac{\partial \epsilon}{\partial \rho} \rho + \frac{\partial \epsilon}{\partial s} s - \epsilon$ is the pressure. Note that for all $\delta \varphi^a$ parallel to the boundary, we have $\mathbf{P}_a^A \mathbf{N}_A \delta \varphi^a = -p J_\varphi (\varphi^{-1})_{,a}^A \mathbf{N}_A \delta \varphi^a = 0$, since $(\varphi^{-1})_{,a}^A \delta \varphi^a$ is parallel to the boundary. Hence the boundary condition in (2.13) is always satisfied. From (2.19) the Euler-Lagrange equations (2.13) become

$$\varrho_{\text{ref}} \ddot{\varphi} = (\nabla p \circ \varphi) J_\varphi. \quad (2.20)$$

Equations (2.20) are the equations of motion for a compressible fluid in the *material (or Lagrangian) description*, which directly follows from the Hamilton principle (2.12) applied to the Lagrangian (2.15). It is however highly desirable to have a variational formulation that directly produces the equations of motion in the standard spatial (or Eulerian) description. This is recalled below in §2.3 by using Lagrangian reduction by symmetry.

2.3 Lagrangian reduction by symmetry

When a symmetry is available in a mechanical system, it is often possible to exploit it in order to reduce the dimension of the system and thereby facilitating its study. This process, called *reduction by symmetry*, is today well understood both on the Lagrangian and Hamiltonian sides, see Marsden and Ratiu [1999] for an introduction and references.

While on the Hamiltonian side, this process is based on the reduction of symplectic or Poisson structures, on the Lagrangian side it is usually based on the reduction of variational principles, see Marsden and Scheurle [1993a,b], Cendra, Marsden, and Ratiu [2001]. Consider a mechanical system with configuration manifold Q and Lagrangian $L : TQ \rightarrow \mathbb{R}$ and consider also the action of a Lie group G on Q , denoted here simply as $q \mapsto g \cdot q$, for $g \in G$, $q \in Q$. This action naturally induces an action on the tangent bundle TQ , denoted here simply as $(q, v) \mapsto (g \cdot q, g \cdot v)$, called the *tangent lifted action*. We say that the action is a symmetry for the mechanical system if the Lagrangian L is invariant under this tangent lifted action. In this case, L induces a *symmetry reduced Lagrangian* $\ell : (TQ)/G \rightarrow \mathbb{R}$ defined on the quotient space $(TQ)/G$ of the tangent bundle with respect to the action. The goal of the Lagrangian reduction process is to derive the equations of motion directly on the reduced space $(TQ)/G$. Under standard hypotheses on the action, this quotient space is a manifold and one obtains the *reduced Euler-Lagrange equations* by computing the *reduced variational principle* for the action integral $\int_{t_1}^{t_2} \ell \, dt$ induced by Hamilton's principle (2.2) for the action integral $\int_{t_1}^{t_2} L \, dt$. The main difference between the reduced variational principle and Hamilton's principle is the occurrence of constraints on the variations to be considered when computing the critical curves for $\int_{t_1}^{t_2} \ell \, dt$. These constraints are uniquely associated to the reduced character of the variational principle and are not due to physical constraints as in (2.10) earlier.

We now quickly recall the application of Lagrangian reduction for the treatment of fluid mechanics in a fixed domain, see §2.2, by following the Euler-Poincaré reduction approach in Holm, Marsden, and Ratiu [1998]. In this case the Lagrangian reduction process encodes the passing from the material (or Lagrangian) description to the spatial (or Eulerian) description.

As we recalled above, in the material description the motion of the fluid is described by a curve of diffeomorphisms φ_t in the configuration manifold $Q = \text{Diff}(\mathcal{D})$ and the evolution equations (2.20) for φ_t follow from the standard Hamilton principle.

In the spatial description, the dynamics is described by the Eulerian velocity $\mathbf{v}(t, x)$, the mass density $\rho(t, x)$ and the entropy density $s(t, x)$ defined in terms of φ_t as

$$\mathbf{v}_t = \dot{\varphi}_t \circ \varphi_t^{-1}, \quad \rho_t = (\varphi_t)_* \varrho_{\text{ref}}, \quad s_t = (\varphi_t)_* S_{\text{ref}}. \quad (2.21)$$

Using these relations and (2.18), the Lagrangian (2.15) in material description induces the following expression in the spatial description

$$\ell(\mathbf{v}, \rho, s) = \int_{\mathcal{D}} \left[\frac{1}{2} \rho |\mathbf{v}|^2 - \varepsilon(\rho, s) \right] d^3x.$$

The symmetry group underlying the Lagrangian reduction process is the subgroup

$$\text{Diff}(\mathcal{D})_{\varrho_{\text{ref}}, S_{\text{ref}}} \subset \text{Diff}(\mathcal{D})$$

of diffeomorphisms that preserve both the mass density ϱ_{ref} and entropy density S_{ref} in the reference configuration. So, we have $Q = \text{Diff}(\mathcal{D})$ and $G = \text{Diff}(\mathcal{D})_{\varrho_{\text{ref}}, S_{\text{ref}}}$ in the general Lagrangian reduction setting described above.

From the relations (2.21) we obtain that the variations $\delta\varphi$ used in Hamilton's principle (2.12) induce the variations

$$\delta\mathbf{v} = \partial_t \boldsymbol{\zeta} + \mathbf{v} \cdot \nabla \boldsymbol{\zeta} - \boldsymbol{\zeta} \cdot \nabla \mathbf{v}, \quad \delta\rho = -\text{div}(\rho\boldsymbol{\zeta}), \quad \delta s = -\text{div}(s\boldsymbol{\zeta}), \quad (2.22)$$

where $\boldsymbol{\zeta} = \delta\varphi \circ \varphi^{-1}$ is an arbitrary time dependent vector field parallel to $\partial\mathcal{D}$. From Lagrangian reduction theory the Hamilton principle (2.12) induces, in the Eulerian description, the (reduced) variational principle

$$\delta \int_{t_1}^{t_2} \ell(\mathbf{v}, \rho, s) dt = 0, \quad (2.23)$$

for variations $\delta\mathbf{v}$, $\delta\rho$, δs constrained by the relations (2.22) with $\boldsymbol{\zeta}(t_1) = \boldsymbol{\zeta}(t_2) = 0$. This principle yields the compressible fluid equations $\rho(\partial_t \mathbf{v} + \mathbf{v} \cdot \nabla \mathbf{v}) = -\nabla p$ in the Eulerian description, while the continuity equations $\partial_t \rho + \text{div}(\rho \mathbf{v}) = 0$ and $\partial_t s + \text{div}(s \mathbf{v}) = 0$ follow from the definition of ρ and s in (2.21), see Holm, Marsden, and Ratiu [1998]. We refer to Gay-Balmaz, Marsden, and Ratiu [2012] for extension of this Lagrangian reduction approach to the case of fluids with a free boundary.

The variational formulation (2.22)–(2.23) are extended in §4 to include irreversible processes and are illustrated using the Navier-Stokes-Fourier system as an example.

3 Variational formulation for discrete thermodynamic systems

In this section we present a variational formulation for the finite dimensional case of discrete thermodynamic systems that reduces to Hamilton's variational principle (2.2) in absence of irreversible processes. The form of this variational formulation is similar to that of nonholonomic mechanics recalled earlier, see (2.8)–(2.10), in the sense that the critical curve condition is subject to two constraints: a *kinematic constraints* on the solution curve and a *variational constraint* on the variations to be considered when computing the criticality condition. A major difference however, with the Lagrange-d'Alembert principle recalled above, is that the constraints are *nonlinear* in velocities. This formulation is extended to continuum systems in §4.

Before presenting the variational formulation, we recall below the two laws of thermodynamics as formulated in Stueckelberg and Scheurer [1974].

The two laws of thermodynamics. Let us denote by Σ a physical system and by Σ^{ext} its exterior. The state of the system is defined by a set of mechanical variables and a set of thermal variables. State functions are functions of these variables. Stueckelberg's formulation of the two laws is given as follows.

First law: For every system Σ , there exists an extensive scalar state function E , called *energy*, which satisfies

$$\frac{d}{dt}E(t) = P_W^{\text{ext}}(t) + P_H^{\text{ext}}(t) + P_M^{\text{ext}}(t),$$

where P_W^{ext} is the *power associated to the work*⁴ done on the system, P_H^{ext} is the *power associated to the transfer of heat into the system*, and P_M^{ext} is the *power associated to the transfer of matter into the system*.⁵

Given a *thermodynamic system*, the following terminology is generally adopted:

- A system is said to be **closed** if there is no exchange of matter, i.e., $P_M^{\text{ext}}(t) = 0$. When $P_M^{\text{ext}}(t) \neq 0$ the system is said to be **open**.
- A system is said to be **adiabatically closed** if it is closed and there is no heat exchanges, i.e., $P_M^{\text{ext}}(t) = P_H^{\text{ext}}(t) = 0$.
- A system is said to be **isolated** if it is adiabatically closed and there is no mechanical power exchange, i.e., $P_M^{\text{ext}}(t) = P_H^{\text{ext}}(t) = P_W^{\text{ext}}(t) = 0$.

From the first law, it follows that the *energy of an isolated system is constant*.

Second law: For every system Σ , there exists an extensive scalar state function S , called *entropy*, which obeys the following two conditions

(a) Evolution part:

If the system is adiabatically closed, the entropy S is a non-decreasing function with respect to time, i.e.,

$$\frac{d}{dt}S(t) = I(t) \geq 0,$$

where $I(t)$ is the *entropy production rate* of the system accounting for the irreversibility of internal processes.

(b) Equilibrium part:

If the system is isolated, as time tends to infinity the entropy tends towards a finite local maximum of the function S over all the thermodynamic states ρ compatible with the system, i.e.,

$$\lim_{t \rightarrow +\infty} S(t) = \max_{\rho \text{ compatible}} S[\rho].$$

By definition, the evolution of an isolated system is said to be *reversible* if $I(t) = 0$, namely, the entropy is constant. In general, the evolution of a system Σ is said to be *reversible*, if the evolution of the total isolated system with which Σ interacts is reversible.

Based on this formulation of the two laws, Stueckelberg and Scheurer [1974] developed a systematic approach for the derivation of the equations of motion for thermodynamic systems, especially well suited for the understanding of nonequilibrium thermodynamics as

⁴Here *work* includes not only *mechanical work* by the action of forces but also other physical work such as the one by the action of electric voltages, etc.

⁵As we recall below, to a transfer of matter into the system is associated a transfer of work and heat. By convention, P_W^{ext} and P_H^{ext} denote uniquely the power associated to a transfer of work and heat into the system that is *not associated to a transfer of matter*. The power associated to a transfer of heat or work due to a transfer of matter is included in P_M^{ext} .

an extension of classical mechanics. We refer, for instance, to Gruber [1999], Ferrari and Gruber [2010], Gruber and Brechet [2011] for the applications of Stueckelberg's approach to the derivation of equations of motion for thermodynamical systems.

We shall present our approach by considering systems with gradually increasing level of complexity. First we treat *adiabatically closed* systems, which have only one entropy variable or, equivalently, one temperature. Such systems, called *simple systems*, may involve the irreversible processes of mechanical friction and internal matter transfer. Then we treat a more general class of finite dimensional adiabatically closed thermodynamic systems with several entropy variables, which may also involve the irreversible process of heat conduction. We then consider *open* finite dimensional thermodynamic systems, which can exchange heat and matter with the exterior. Finally, we explain how chemical reactions can be included in the variational formulation.

3.1 Adiabatically closed simple thermodynamic systems

We present below the definition of finite dimensional and simple systems following Stueckelberg and Scheurer [1974]. A *finite dimensional thermodynamic system* Σ is a collection $\Sigma = \cup_{A=1}^P \Sigma_A$ of a finite number of interacting simple thermodynamic systems Σ_A . By definition, a *simple thermodynamic system* is a macroscopic system for which one (scalar) thermal variable and a finite set of non thermal variables are sufficient to describe entirely the state of the system. From the second law of thermodynamics, we can always choose the entropy S as a thermal variable. A typical example of such a simple system is the one-cylinder problem. We refer to Gruber [1999] for a systematic treatment of this system via Stueckelberg's approach.

(A) Variational formulation for mechanical systems with friction. We consider here a simple system in which the system can be described only by a single entropy as a thermodynamic variable, beside mechanical variables. As in §2.1 above, let Q be the configuration manifold associated to the mechanical variables of the simple system. The Lagrangian of the simple thermodynamic system is thus a function

$$L : TQ \times \mathbb{R} \rightarrow \mathbb{R}, \quad (q, v, S) \mapsto L(q, v, S),$$

where $S \in \mathbb{R}$ is the entropy. We assume that the system involves external and friction forces given by fiber preserving maps $F^{\text{ext}}, F^{\text{fr}} : TQ \times \mathbb{R} \rightarrow T^*Q$, i.e., such that $F^{\text{fr}}(q, v, S) \in T_q^*Q$, similarly for F^{ext} . As stated in Gay-Balmaz and Yoshimura [2017a], the variational formulation for this simple system is given as follows:

Find the curves $q(t), S(t)$ which are critical for the *variational condition*

$$\delta \int_{t_1}^{t_2} L(q, \dot{q}, S) dt + \int_{t_1}^{t_2} \langle F^{\text{ext}}(q, \dot{q}, S), \delta q \rangle dt = 0, \quad (3.1)$$

subject to the *phenomenological constraint*

$$\frac{\partial L}{\partial S}(q, \dot{q}, S) \dot{S} = \langle F^{\text{fr}}(q, \dot{q}, S), \dot{q} \rangle, \quad (3.2)$$

and for variations subject to the *variational constraint*

$$\frac{\partial L}{\partial S}(q, \dot{q}, S) \delta S = \langle F^{\text{fr}}(q, \dot{q}, S), \delta q \rangle, \quad (3.3)$$

with $\delta q(t_1) = \delta q(t_2) = 0$.

Taking variations of the integral in (3.1), integrating by parts, and using $\delta q(t_1) = \delta q(t_2) = 0$, it follows

$$\int_{t_1}^{t_2} \left[\left(\frac{\partial L}{\partial q^i} - \frac{d}{dt} \frac{\partial L}{\partial \dot{q}^i} + F_i^{\text{ext}} \right) \delta q^i + \frac{\partial L}{\partial S} \delta S \right] dt.$$

From the variational constraint (3.3), the last term in the integrand of the above equation can be replaced by $F_i^{\text{fr}} \delta q^i$. Hence, using (3.2), we get the following system of evolution equations for the curves $q(t)$ and $S(t)$:

$$\begin{cases} \frac{d}{dt} \frac{\partial L}{\partial \dot{q}} - \frac{\partial L}{\partial q} = F^{\text{fr}}(q, \dot{q}, S) + F^{\text{ext}}(q, \dot{q}, S), \\ \frac{\partial L}{\partial S} \dot{S} = \langle F^{\text{fr}}(q, \dot{q}, S), \dot{q} \rangle. \end{cases} \quad (3.4)$$

This variational formulation is a generalization of Hamilton's principle in Lagrangian mechanics in the sense that it can yield the irreversible processes in addition to the Lagrange-d'Alembert equations with external and friction forces. In this generalized variational formulation, the temperature is defined as minus the derivative of L with respect to S , i.e., $T = -\frac{\partial L}{\partial S}$, which is assumed to be positive. When the Lagrangian has the standard form

$$L(q, v, S) = K(q, v) - U(q, S),$$

where the kinetic energy K is assumed to be independent on S and $U(q, S)$ is the internal energy, then $T = -\frac{\partial L}{\partial S} = \frac{\partial U}{\partial S}$, recovers the standard definition of the temperature in thermodynamics.

When the friction force vanishes, the entropy is constant from the second equation in (3.4), and hence the system (3.4) reduces to the forced Euler-Lagrange equations in classical mechanics, for a Lagrangian depending parametrically on a given constant entropy S_0 .

The total energy associated with the Lagrangian is still defined with the same expression as in (2.5) except that now it depends on S , i.e., we define the total energy $E : TQ \times \mathbb{R} \rightarrow \mathbb{R}$ by

$$E(q, v, S) = \left\langle \frac{\partial L}{\partial v}, v \right\rangle - L(q, v, S). \quad (3.5)$$

Along the solution curve of (3.4), we have

$$\frac{d}{dt} E = \left(\frac{d}{dt} \frac{\partial L}{\partial \dot{q}^i} - \frac{\partial L}{\partial q^i} \right) \dot{q}^i - \frac{\partial L}{\partial S} \dot{S} = F_i^{\text{ext}} \dot{q}^i = P_W^{\text{ext}},$$

where P_W^{ext} is the power associated to the work done on the system. This is nothing but the statement of the first law for the thermodynamic system as in (3.4).

The rate of entropy production of the system is

$$\dot{S} = -\frac{1}{T} \langle F^{\text{fr}}, \dot{q} \rangle.$$

The second law states that the internal entropy production is always positive, from which the friction force is dissipative, i.e., $\langle F^{\text{fr}}(q, \dot{q}, S), \dot{q} \rangle \leq 0$ for all (q, \dot{q}, S) . This suggests the phenomenological relation $F_i^{\text{fr}} = -\lambda_{ij} \dot{q}^j$, where λ_{ij} , $i, j = 1, \dots, n$ are functions of the state variables with the symmetric part of the matrix λ_{ij} positive semi-definite, which are determined by experiments.

Remark 3.1 (Phenomenological and variational constraints). The explicit expression of the constraint (3.2) involves phenomenological laws for the friction force F^{fr} , this is why we refer to it as a *phenomenological constraint*. The associated constraint (3.3) is called a *variational constraint* since it is a condition on the variations to be used in (3.1). Note that the constraint (3.2) is nonlinear and also that one passes from the variational constraint to the phenomenological constraint by formally replacing the time derivatives \dot{q} , \dot{S} by the variations δq , δS :

$$\frac{\partial L}{\partial S} \dot{S} = \langle F^{\text{fr}}, \dot{q} \rangle \rightsquigarrow \frac{\partial L}{\partial S} \delta S = \langle F^{\text{fr}}, \delta q \rangle.$$

Such a systematic correspondence between the phenomenological and variational constraints will hold, in general, for our variational formulation of thermodynamics, as we present in detail below.

Remark 3.2. In our macroscopic description, it is assumed that the macroscopically “slow” or collective motion of the system can be described by $q(t)$, while the time evolution of the entropy $S(t)$ is determined from the microscopically “fast” motions of molecules through statistical mechanics under the assumption of *local equilibrium*. It follows from statistical mechanics that the internal energy $U(q, S)$, given as a potential energy at the macroscopic level, is essentially coming from the total kinetic energy associated with the microscopic motion of molecules, which is directly related to the temperature of the system.

Example: piston. Consider a gas confined by a piston in a cylinder as in Fig. 3.1. This is an example of a simple adiabatically closed system, whose state can be characterized by (q, v, S) . The Lagrangian is given by $L(q, v, S) = \frac{1}{2}mv^2 - U(q, S)$, where m is the mass of

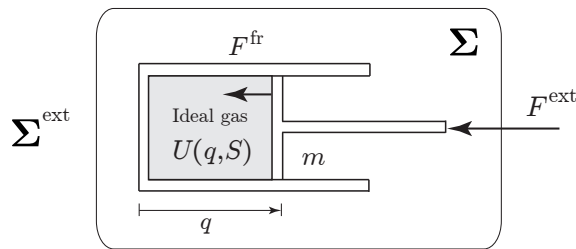

Figure 3.1: One-cylinder.

the piston, $U(q, S) := U(S, V = Aq, N_0)$, with $U(S, V, N)$ the internal energy of the gas, N_0 is the constant number of moles, $V = \alpha q$ is the volume, and α is the constant area of the cylinder. Note that we have

$$\frac{\partial U}{\partial S}(q, S) = T(q, S) \quad \text{and} \quad \frac{\partial U}{\partial q}(q, S) = -p(q, S)\alpha,$$

where T is temperature and $p = -\frac{\partial U}{\partial V}$ is the pressure. The friction force reads $F^{\text{fr}}(q, \dot{q}, S) = -\lambda(q, S)\dot{q}$, where $\lambda(q, S) \geq 0$ is the phenomenological coefficient, determined experimentally.

Following (3.1)–(3.3), the variational formulation is given by

$$\delta \int_{t_1}^{t_2} \left[\frac{1}{2}m\dot{q}^2 - U(q, S) \right] dt + \int_{t_1}^{t_2} F^{\text{ext}}(q, \dot{q}, S) \delta q dt = 0,$$

subject to the phenomenological constraint

$$\frac{\partial U}{\partial S}(q, S)\dot{S} = \lambda(q, S)\dot{q}^2.$$

and for variations subject to the variational constraint

$$\frac{\partial U}{\partial S}(q, S)\delta S = \lambda(q, S)\dot{q}\delta q.$$

From this principle, we get the equations of motion for the piston-cylinder system as

$$m\ddot{q} = p(q, S)\alpha + F^{\text{ext}} - \lambda(q, S)\dot{q}, \quad T(q, S)\dot{S} = \lambda(q, S)\dot{q}^2,$$

consistently with the equations derived by Gruber [1999, §4]. We can verify the energy balance, i.e., the first law, as $\frac{d}{dt}E = F^{\text{ext}}\dot{q}$, where $E = \frac{1}{2}m\dot{q}^2 + U$ is the total energy.

(B) Variational formulation for systems with internal mass transfer. We here extend the previous variational formulation to the finite dimensional case of discrete systems experiencing internal diffusion processes. Diffusion is particularly important in biology where many processes depend on the transport of chemical species through bodies. For instance, the setting that we develop is well appropriate for the description of diffusion across composite membranes, e.g., composed of different elements arranged in a series or parallel array, which occur frequently in living systems and have remarkable physical properties, see Kedem and Katchalsky [1963a,b,c]; Oster, Perelson, Katchalsky [1973].

As illustrated in Fig. 3.2, we consider a thermodynamic system consisting of K compartments that can exchange matter by diffusion across walls (or membranes) of their common boundaries. We assume that the system has a single species and denote by N_k the number of moles of the species in the k -th compartment, $k = 1, \dots, K$. We assume that the thermodynamic system is simple; i.e., a uniform entropy S , the entropy of the system, is attributed to all the compartments.

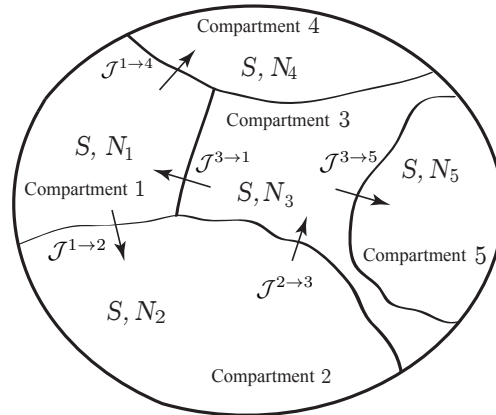

Figure 3.2: Simple adiabatically closed system with a single chemical species, experiencing diffusion between several compartments.

For each compartment $k = 1, \dots, K$, the mole balance equation is

$$\frac{d}{dt}N_k = \sum_{\ell=1}^K \mathcal{J}^{\ell \rightarrow k},$$

where $\mathcal{J}^{\ell \rightarrow k} = -\mathcal{J}^{k \rightarrow \ell}$ is the molar flow rate from compartment ℓ to compartment k due to diffusion of the species. We assume that the simple system also involves mechanical variables, friction and exterior forces F^{fr} and F^{ext} , as in (A). The Lagrangian of the system is thus a function

$$L : TQ \times \mathbb{R} \times \mathbb{R}^K \rightarrow \mathbb{R}, \quad (q, v, S, N_1, \dots, N_K) \mapsto L(q, v, S, N_1, \dots, N_K).$$

Thermodynamic displacements associated to matter exchange. The variational formulation involves the new variables W^k , $k = 1, \dots, K$, which are examples of *thermodynamic displacements* and play a central role in our formulation. In general, we define the *thermodynamic displacement associated to a irreversible process* as the primitive in time of the thermodynamic force (or affinity) of the process. This force (or affinity) thus becomes the rate of change of the thermodynamic displacement. In the case of matter transfer, \dot{W}^k corresponds to the chemical potential of N_k .

The variational formulation for a simple system with internal diffusion process is stated as follows.

Find the curves $q(t)$, $S(t)$, $W^k(t)$, $N_k(t)$ which are critical for the *variational condition*

$$\delta \int_{t_1}^{t_2} \left[L(q, \dot{q}, S, N_1, \dots, N_K) + \dot{W}^k N_k \right] dt + \int_{t_1}^{t_2} \langle F^{\text{ext}}, \delta q \rangle dt = 0, \quad (3.6)$$

subject to the *phenomenological constraint*

$$\frac{\partial L}{\partial S} \dot{S} = \langle F^{\text{fr}}, \dot{q} \rangle + \sum_{k, \ell=1}^K \mathcal{J}^{\ell \rightarrow k} \dot{W}^k, \quad (3.7)$$

and for variations subject to the *variational constraint*

$$\frac{\partial L}{\partial S} \delta S = \langle F^{\text{fr}}, \delta q \rangle + \sum_{k, \ell=1}^K \mathcal{J}^{\ell \rightarrow k} \delta W^k, \quad (3.8)$$

with $\delta q(t_1) = \delta q(t_2) = 0$ and $\delta W^k(t_1) = \delta W^k(t_2) = 0$, $k = 1, \dots, K$.

Taking variations of the integral in (3.6), integrating by parts, and using $\delta q(t_1) = \delta q(t_2) = 0$ and $\delta W^k(t_1) = \delta W^k(t_2) = 0$, it follows

$$\int_{t_1}^{t_2} \left[\left(\frac{\partial L}{\partial q^i} - \frac{d}{dt} \frac{\partial L}{\partial \dot{q}^i} + F_i^{\text{ext}} \right) \delta q^i + \frac{\partial L}{\partial S} \delta S + \left(\frac{\partial L}{\partial N_k} + \dot{W}^k \right) \delta N_k - \dot{N}_k \delta W^k \right] dt.$$

Then, using the variational constraint (3.8), we get the following conditions:

$$\begin{aligned}\delta q^i &: \frac{d}{dt} \frac{\partial L}{\partial \dot{q}^i} - \frac{\partial L}{\partial q^i} = F_i^{\text{fr}} + F_i^{\text{ext}}, \quad i = 1, \dots, n, \\ \delta N_k &: \frac{d}{dt} W^k = -\frac{\partial L}{\partial N_k}, \quad k = 1, \dots, K, \\ \delta W^k &: \frac{d}{dt} N_k = \sum_{\ell=1}^K \mathcal{J}^{\ell \rightarrow k}, \quad k = 1, \dots, K.\end{aligned}\tag{3.9}$$

These conditions, combined with the phenomenological constraint (3.7), yield the system of evolution equations for the curves $q(t)$, $S(t)$, and $N^k(t)$:

$$\begin{cases} \frac{d}{dt} \frac{\partial L}{\partial \dot{q}} - \frac{\partial L}{\partial q} = F^{\text{fr}} + F^{\text{ext}}, \\ \frac{d}{dt} N_k = \sum_{\ell=1}^K \mathcal{J}^{\ell \rightarrow k}, \quad k = 1, \dots, K, \\ \frac{\partial L}{\partial S} \dot{S} = \langle F^{\text{fr}}, \dot{q} \rangle - \sum_{k < \ell} \mathcal{J}^{\ell \rightarrow k} \left(\frac{\partial L}{\partial N_k} - \frac{\partial L}{\partial N_\ell} \right). \end{cases}\tag{3.10}$$

The total energy is defined as in (2.5) and (3.5) and depends here on the mechanical variables $(q, v) \in TQ$, the entropy S , and the number of moles N_k , $k = 1, \dots, K$, i.e., we define $E : TQ \times \mathbb{R} \times \mathbb{R}^K \rightarrow \mathbb{R}$ as

$$E(q, v, S, N_1, \dots, N_K) = \left\langle \frac{\partial L}{\partial v}, v \right\rangle - L(q, v, S, N_1, \dots, N_K).\tag{3.11}$$

On the solutions of (3.10), we have

$$\frac{d}{dt} E = \left(\frac{d}{dt} \frac{\partial L}{\partial \dot{q}^i} - \frac{\partial L}{\partial q^i} \right) \dot{q}^i - \frac{\partial L}{\partial S} \dot{S} - \frac{\partial L}{\partial N_k} \dot{N}_k = F_i^{\text{ext}} \dot{q}^i = P_W^{\text{ext}},$$

where P_W^{ext} is the power associated to the work done on the system. This is the statement of the first law for the thermodynamic system (3.10).

For a given Lagrangian L , the temperature and chemical potentials of each compartment are defined as

$$T := -\frac{\partial L}{\partial S} \quad \text{and} \quad \mu^k := -\frac{\partial L}{\partial N_k}, \quad k = 1, \dots, K.$$

The last equation in (3.10) yields the rate of entropy production of the system as

$$\dot{S} = -\frac{1}{T} \langle F^{\text{fr}}, \dot{q} \rangle + \frac{1}{T} \sum_{k < \ell} \mathcal{J}^{k \rightarrow \ell} (\mu^k - \mu^\ell),$$

where the two terms correspond, respectively, to the rate of entropy production due to mechanical friction and to matter transfer. The second law suggests the phenomenological relations

$$F_i^{\text{fr}} = -\lambda_{ij} \dot{q}^j \quad \text{and} \quad \mathcal{J}^{k \rightarrow \ell} = G^{k\ell} (\mu^k - \mu^\ell),$$

where λ_{ij} , $i, j = 1, \dots, n$ and $G^{k\ell}$, $k, \ell = 1, \dots, K$ are functions of the state variables, with the symmetric part of the matrix λ_{ij} positive semi-definite and with $G^{k\ell} \geq 0$, for all k, ℓ .

Example: mass transfer associated to nonelectrolyte diffusion through a homogeneous membrane. We consider a *system with diffusion due to internal matter transfer* through a homogeneous membrane separating two reservoirs. We suppose that the system is simple (so it is described by a single entropy variable) and involves a single chemical species. We assume that the membrane consists of three regions; namely, the central layer denotes the membrane capacitance in which energy is stored without dissipation, while the outer layers indicate transition regions in which dissipation occurs with no energy storage. We denote by N_m the number of mole of this chemical species in the membrane and by N_1 and N_2 the numbers of mole in the reservoirs 1 and 2, as shown in Fig. 3.3. Define the Lagrangian by $L(S, N_1, N_2, N_m) = -U(S, N_1, N_2, N_m)$, where $U(S, N_1, N_2, N_m)$ denotes the internal energy of the system and assume that the volumes are constant and the system is isolated. We denote by $\mu^k = \frac{\partial U}{\partial N_k}$ the chemical potential of the chemical species in the reservoirs ($k = 1, 2$) and in the membrane ($k = m$). We denote by $\mathcal{J}^{1 \rightarrow m}$ the flux from the reservoir 1 into the membrane and $\mathcal{J}^{m \rightarrow 2}$ the flux from the membrane into the reservoir 2.

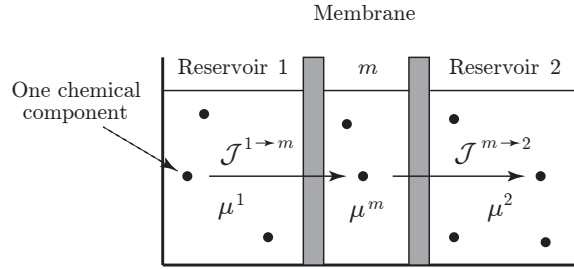

Figure 3.3: Nonelectrolyte diffusion through a homogeneous membrane.

The variational condition for the diffusion process is provided by

$$\delta \int_{t_1}^{t_2} \left[L(S, N_1, N_2, N_m) + \dot{W}^1 N_1 + \dot{W}^2 N_2 + \dot{W}^m N_m \right] dt = 0, \quad (3.12)$$

subject to the phenomenological constraint

$$\frac{\partial L}{\partial S} \dot{S} = \mathcal{J}^{m \rightarrow 1} (\dot{W}^1 - \dot{W}^m) + \mathcal{J}^{m \rightarrow 2} (\dot{W}^2 - \dot{W}^m) \quad (3.13)$$

and for variations subject to the variational constraint

$$\frac{\partial L}{\partial S} \delta S = \mathcal{J}^{m \rightarrow 1} (\delta W^1 - \delta W^m) + \mathcal{J}^{m \rightarrow 2} (\delta W^2 - \delta W^m), \quad (3.14)$$

with $\delta W^k(t_i) = 0$, for $k = 1, 2, m$ and $i = 1, 2$.

Thus, it follows

$$\dot{N}_1 = \mathcal{J}^{m \rightarrow 1}, \quad \dot{N}_m = \mathcal{J}^{1 \rightarrow m} + \mathcal{J}^{2 \rightarrow m}, \quad \dot{N}_2 = \mathcal{J}^{m \rightarrow 2} \quad (3.15)$$

and $\dot{W}^1 = \mu^1$, $\dot{W}^2 = \mu^2$, $\dot{W}^m = \mu^m$. The constraint in (3.13) becomes

$$-T \dot{S} = \mathcal{J}^{m \rightarrow 1} (\mu^1 - \mu^m) + \mathcal{J}^{m \rightarrow 2} (\mu^2 - \mu^m), \quad (3.16)$$

where $T = -\frac{\partial L}{\partial S}$. Equations (3.15) and (3.16) are equivalent with those derived in Oster, Perelson, Katchalsky [1973, §2.2]. From the equations (3.15) and (3.16), we have the energy conservation $\frac{d}{dt} U = 0$, which is consistent with the fact that the system is isolated.

3.2 Adiabatically closed non-simple thermodynamic systems

We now consider a general finite dimensional system $\Sigma = \cup_{A=1}^P \Sigma_A$, composed of interconnected simple thermodynamic systems Σ_A , as illustrated in Fig. 3.4. This class of non-simple interconnected systems extends the class of *interconnected mechanical systems* (see, [Jacobs and Yoshimura \[2014\]](#)) to include the irreversible processes. In addition to the irreversible processes of friction and mass transfer described earlier, these systems can also involve the process of heat conduction.

The main difference with the previous cases is the occurrence of several entropy variables, namely, each subsystem Σ_A has an entropy denoted S_A , $A = 1, \dots, P$. Besides the variables S_A , each subsystem Σ_A may also be described by mechanical variables $q^A \in Q_A$ and number of moles $(N_{A,1}, \dots, N_{A,K_A}) \in \mathbb{R}^{K_A}$, where Q_A are the configuration manifolds for the mechanical variables associated to Σ_A and where K_A are the numbers of compartments in the simple systems Σ_A . For simplicity, we shall assume that independent mechanical coordinates $q \in Q$ have been chosen to represent the mechanical configuration of the interconnected system Σ . The state variables needed to describe this system are

$$(q, v) \in TQ, \quad S_A, \quad A = 1, \dots, P, \quad N_{A,k}, \quad k = 1, \dots, K_A, \quad A = 1, \dots, P. \quad (3.17)$$

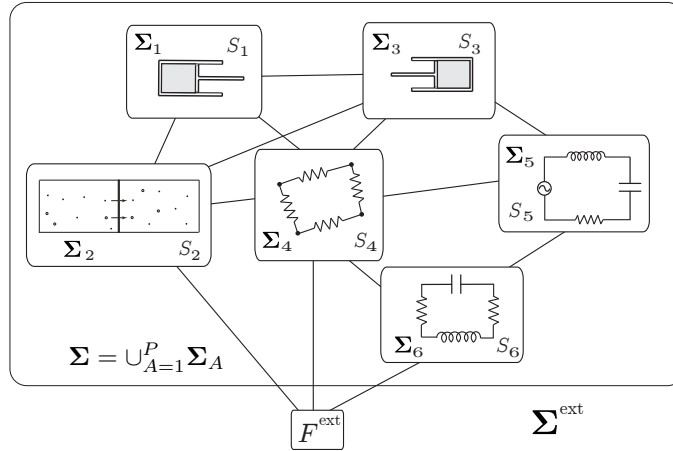

Figure 3.4: Non-simple interconnected system.

We shall present the variational formulation for these systems in two steps, exactly as in §3.1 by first considering the case without any transfer of mass.

(A) Variational formulation for systems with friction and heat conduction. Beside the entropies S_A , $A = 1, \dots, P$, these systems only involve mechanical variables. The Lagrangian of the system is thus a function

$$L : TQ \times \mathbb{R}^P \rightarrow \mathbb{R}, \quad (q, v, S_1, \dots, S_P) \mapsto L(q, v, S_1, \dots, S_P).$$

We denote by $F^{\text{ext} \rightarrow A} : T^*Q \times \mathbb{R}^P \rightarrow T^*Q$ the external force acting on subsystem Σ_A . Consistently with the fact that the mechanical variables $q = (q^1, \dots, q^n)$ describe the configuration of the entire interconnected system Σ , only the total exterior force $F^{\text{ext}} = \sum_{A=1}^P F^{\text{ext} \rightarrow A}$ appears explicitly in the variational condition (3.19). We denote by $F^{\text{fr}(A)}$:

$T^*Q \times \mathbb{R}^P \rightarrow T^*Q$ the friction forces experienced by subsystem Σ_A . This friction force is at the origin of an entropy production for subsystem Σ_A and appears explicitly in the phenomenological constraint (3.20) and the variational constraint (3.21) of the variational formulation. We also introduce the fluxes J_{AB} , $A \neq B$ associated to the heat exchange between subsystems Σ_A and Σ_B and such that $J_{AB} = J_{BA}$. The relation between the fluxes J_{AB} and the heat power exchange $P_H^{A \rightarrow B}$ is given later. For the construction of variational structures, it is convenient to define the flux J_{AB} for $A = B$ as

$$J_{AA} := - \sum_{B \neq A} J_{AB},$$

so that we have

$$\sum_{A=1}^P J_{AB} = 0, \quad \text{for all } B. \quad (3.18)$$

Thermodynamic displacements associated to heat exchange. To incorporate heat exchange into our variational formulation, the new variables Γ^A , $A = 1, \dots, P$ are introduced. These are again examples of *thermodynamic displacements* in the same way as we defined W^k before. For the case of heat exchange, $\dot{\Gamma}^A$ corresponds to the temperature of the subsystem Σ_A , where Γ^A is identical to the *thermal displacement* employed in Green and Naghdi [1991], which was originally introduced by von Helmholtz [1884]. The introduction of Γ^A is accompanied with the introduction of an entropy variable Σ_A whose meaning will be clarified later.

Now, the variational formulation for a system with friction and heat conduction is stated as follows:

Find the curves $q(t)$, $S_A(t)$, $\Gamma^A(t)$, $\Sigma_A(t)$ which are critical for the *variational condition*

$$\delta \int_{t_1}^{t_2} \left[L(q, \dot{q}, S_1, \dots, S_K) + \dot{\Gamma}^A (S_A - \Sigma_A) \right] dt + \int_{t_1}^{t_2} \langle F^{\text{ext}}, \delta q \rangle dt = 0, \quad (3.19)$$

subject to the *phenomenological constraint*

$$\frac{\partial L}{\partial S_A} \dot{\Sigma}_A = \langle F^{\text{fr}(A)}, \dot{q} \rangle + J_{AB} \dot{\Gamma}^B, \quad \text{for } A = 1, \dots, P, \quad (3.20)$$

and for variations subject to the *variational constraint*

$$\frac{\partial L}{\partial S_A} \delta \Sigma_A = \langle F^{\text{fr}(A)}, \delta q \rangle + J_{AB} \delta \Gamma^B, \quad \text{for } A = 1, \dots, P, \quad (3.21)$$

with $\delta q(t_1) = \delta q(t_2) = 0$ and $\delta \Gamma^A(t_1) = \delta \Gamma^A(t_2) = 0$, $A = 1, \dots, P$.

Taking variations of the integral in (3.19), integrating by parts, and using $\delta q(t_1) = \delta q(t_2) = 0$ and $\delta \Gamma^A(t_1) = \delta \Gamma^A(t_2) = 0$, it follows

$$\int_{t_1}^{t_2} \left[\left(\frac{\partial L}{\partial q^i} - \frac{d}{dt} \frac{\partial L}{\partial \dot{q}^i} + F_i^{\text{ext}} \right) \delta q^i + \frac{\partial L}{\partial S_A} \delta S_A - (\dot{S}_A - \dot{\Sigma}_A) \delta \Gamma^A + \dot{\Gamma}^A (\delta S_A - \delta \Sigma_A) \right] dt = 0.$$

Then, using the variational constraint (3.21), we get the following conditions:

$$\begin{aligned} \delta q^i &: \frac{\partial L}{\partial q^i} - \frac{d}{dt} \frac{\partial L}{\partial \dot{q}^i} - \sum_{A=1}^P \frac{\dot{\Gamma}^A}{\partial S_A} F_i^{\text{fr}(A)} + F_i^{\text{ext}} = 0, \quad i = 1, \dots, n, \\ \delta S_A &: \frac{\partial L}{\partial S_A} + \dot{\Gamma}^A = 0, \quad A = 1, \dots, P, \\ \delta \Gamma^A &: -\dot{S}_A + \dot{\Sigma}_A - \sum_{B=1}^P \frac{\dot{\Gamma}^A}{\partial S_A} J_{BA} = 0, \quad A = 1, \dots, P. \end{aligned}$$

The second equation yields

$$\dot{\Gamma}^A = -\frac{\partial L}{\partial S_A} =: T^A, \quad (3.22)$$

where T^A is the temperature of the subsystem Σ_A . This implies that Γ_A is a thermal displacement. Because of (3.18), the last equation yields $\dot{S}_A = \dot{\Sigma}_A$. Hence, using (3.20), we get the following system of evolution equations for the curves $q(t)$ and $S_A(t)$:

$$\begin{cases} \frac{d}{dt} \frac{\partial L}{\partial \dot{q}} - \frac{\partial L}{\partial q} = \sum_{A=1}^P F^{\text{fr}(A)} + F^{\text{ext}}, \\ \frac{\partial L}{\partial S_A} \dot{S}_A = \langle F^{\text{fr}(A)}, \dot{q} \rangle - \sum_{B=1}^P J_{AB} \left(\frac{\partial L}{\partial S_B} - \frac{\partial L}{\partial S_A} \right), \quad A = 1, \dots, P. \end{cases} \quad (3.23)$$

As before, we have $\frac{d}{dt} E = \langle F^{\text{ext}}, \dot{q} \rangle = P_W^{\text{ext}}$, where the total energy E is defined in the same way as before. Since the system is *non-simple*, it is instructive to analyze the energy behavior of each subsystem. This can be done if the Lagrangian is given by the sum of the Lagrangians of the subsystems, i.e.,

$$L(q, v, S_1, \dots, S_P) = \sum_{A=1}^P L_A(q, v, S_A).$$

The mechanical equation for Σ_A is given as

$$\frac{d}{dt} \frac{\partial L_A}{\partial \dot{q}} - \frac{\partial L_A}{\partial q} = F^{\text{fr}(A)} + F^{\text{ext} \rightarrow A} + \sum_{B=1}^P F^{B \rightarrow A},$$

where $F^{B \rightarrow A} = -F^{A \rightarrow B}$ is the internal force exerted by Σ_B on Σ_A . Denoting E_A the total energy of Σ_A , we have

$$\begin{aligned} \frac{d}{dt} E_A &= \langle F^{\text{ext} \rightarrow A}, \dot{q} \rangle + \sum_{B=1}^P \langle F^{B \rightarrow A}, \dot{q} \rangle + \sum_{B=1}^P J_{AB} \left(\frac{\partial L}{\partial S_B} - \frac{\partial L}{\partial S_A} \right) \\ &= P_W^{\text{ext} \rightarrow A} + \sum_{B=1}^P P_W^{B \rightarrow A} + \sum_{B=1}^P P_H^{B \rightarrow A}, \end{aligned} \quad (3.24)$$

where $P_W^{\text{ext} \rightarrow A}$ and $P_W^{B \rightarrow A}$ denote the power associated to the work done on Σ_A by the exterior and that by the subsystem Σ_B respectively, and where $P_H^{B \rightarrow A}$ is the power associated to the heat transfer from Σ_B to Σ_A . The link between the flux J_{AB} and the power exchange is thus

$$P_H^{B \rightarrow A} = J_{AB}(T^A - T^B).$$

Since entropy is an extensive variable, the total entropy of the system is $S = \sum_{A=1}^P S_A$. From (3.23), it follows that the rate of total entropy production $\dot{S} = \sum_{A=1}^P \dot{S}_A$ of the system is given by

$$\dot{S} = - \sum_{A=1}^P \frac{1}{T^A} \langle F^{\text{fr}(A)}, \dot{q} \rangle + \sum_{A < B}^K J_{AB} \left(\frac{1}{T^B} - \frac{1}{T^A} \right) (T^B - T^A). \quad (3.25)$$

The second law suggests the phenomenological relations

$$F_i^{\text{fr}(A)} = -\lambda_{ij}^A \dot{q}^j \quad \text{and} \quad J_{AB} \frac{T^A - T^B}{T^A T^B} = \mathcal{L}_{AB} (T^B - T^A), \quad (3.26)$$

where λ_{ij}^A and \mathcal{L}_{AB} are functions of the state variables, with the symmetric part of the matrices λ_{ij}^A positive semi-definite and with $\mathcal{L}_{AB} \geq 0$, for all A, B . From the second relation, we deduce $J_{AB} = -\mathcal{L}_{AB} T^A T^B = -\kappa_{AB}$, with $\kappa_{AB} = \kappa_{AB}(q, S_A, S_B)$ the heat conduction coefficients between subsystem Σ_A and subsystem Σ_B .

Example: the adiabatic piston. We consider a piston-cylinder system composed of two cylinders connected by a rod, each of which contains a fluid (or an ideal gas) and is separated by a movable piston, as shown in Fig. 3.5. We assume that the system is isolated. Despite its apparent simplicity, this system has attracted a lot of attention in the literature because there has been some controversy about the final equilibrium state of this system when the piston is adiabatic. We refer to Gruber [1999] for a review of this challenging problem and for the derivation of the time evolution of this system, based on the approach of Stueckelberg and Scheurer [1974]. The system Σ may be regarded as an interconnected

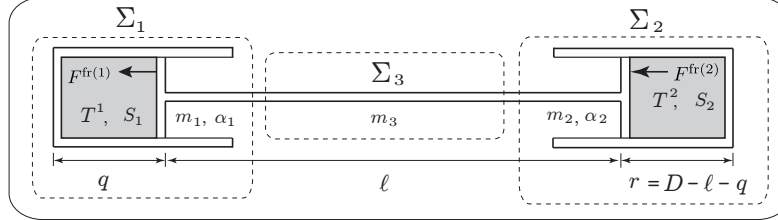

Figure 3.5: The two-cylinder problem.

system consisting of three simple systems; namely, the two pistons Σ_1, Σ_2 of mass m_1, m_2 and the connecting rod Σ_3 of mass m_3 . As illustrated in Fig. 3.5, q and $r = D - \ell - q$ denote respectively the distance between the bottom of each piston to the top, where D is a constant. In this setting, we choose the variables (q, v, S_1, S_2) (the entropy associated to Σ_3 is constant) to describe the dynamics of the interconnected system and the Lagrangian is given by

$$L(q, v, S_1, S_2) = \frac{1}{2} M v^2 - U_1(q, S_1) - U_2(q, S_2), \quad (3.27)$$

where $M := m_1 + m_2 + m_3$, and

$$U_1(q, S_1) := U_1(S_1, V_1 = \alpha_1 q, N_1), \quad U_2(q, S_2) := U_2(S_2, V_2 = \alpha_2 r, N_2),$$

with $U_i(S_i, V_i, N_i)$, the internal energies of the fluids, N_i the constant number of moles, and α_i are the constant areas of the cylinders, $i = 1, 2$.

As in (3.26) we have $F^{\text{fr}(A)}(q, \dot{q}, S_A) = -\lambda^A \dot{q}$, with $\lambda^A = \lambda^A(q, S^A) \geq 0$, $A = 1, 2$ and $J_{AB} = -\kappa_{AB} =: -\kappa$, where $\kappa = \kappa(S_1, S_2, q) \geq 0$ is the heat conductivity of the connecting rod.

From the variational formulation (3.19)–(3.21), we get the following system for $q(t)$, $S_1(t)$, $S_2(t)$, in view of (3.23), as

$$\begin{cases} M\ddot{q} = p_1(q, S_1)\alpha_1 - p_2(q, S_2)\alpha_2 - (\lambda^1 + \lambda^2)\dot{q}, \\ T^1(q, S_1)\dot{S}_1 = \lambda^1 \dot{q}^2 + \kappa (T^2(q, S_2) - T^1(q, S_1)), \\ T^2(q, S_2)\dot{S}_2 = \lambda^2 \dot{q}^2 + \kappa (T^1(q, S_1) - T^2(q, S_2)), \end{cases}$$

where we used $\frac{\partial U_i}{\partial S_i}(q, S_i) = T^i(q, S_i)$, $\frac{\partial U_1}{\partial q} = -p_1(q, S_1)\alpha_1$, and $\frac{\partial U_2}{\partial q} = p_2(q, S_2)\alpha_2$.

These equations recover those derived in Gruber [1999], (51)–(53). We have $\frac{d}{dt}E = 0$, where $E = \frac{1}{2}M\dot{q}^2 + U_1(q, S_1) + U_2(q, S_2)$, consistently with the fact that the system is isolated. The rate of total entropy production is

$$\frac{d}{dt}S = \left(\frac{\lambda^1}{T^1} + \frac{\lambda^2}{T^2} \right) \dot{q}^2 + \kappa \frac{(T^2 - T^1)^2}{T^1 T^2} \geq 0.$$

The equations of motion for the adiabatic piston are obtained by setting $\kappa = 0$.

(B) Variational formulation for systems with friction, heat conduction, and internal mass transfer. We extend the previous case to the case in which the subsystems Σ_A not only exchange work and heat, but also matter. In general, each subsystem may itself have several compartments, in which case the variables are those listed in (3.17). For simplicity, we shall assume that each subsystem has only one compartment. The reader can easily extend this approach to the general case. The Lagrangian is thus a function

$$L : TQ \times \mathbb{R}^P \times \mathbb{R}^P \rightarrow \mathbb{R}, \quad (q, v, S_1, \dots, S_P, N_1, \dots, N_P) \mapsto L(q, v, S_1, \dots, S_P, N_1, \dots, N_P),$$

where S_A and N_A are the entropy and number of moles of subsystem Σ_A , $A = 1, \dots, P$. Since the previous cases have been already presented in details earlier, we shall here just present the variational formulation and the resulting equations of motion.

Find the curves $q(t)$, $S_A(t)$, $\Gamma^A(t)$, $\Sigma_A(t)$, $W^A(t)$, $N_A(t)$ which are critical for the *variational condition*

$$\delta \int_{t_1}^{t_2} \left[L(q, \dot{q}, S_1, \dots, S_P, N_1, \dots, N_P) + \dot{W}^A N_A + \dot{\Gamma}^A (S_A - \Sigma_A) \right] dt + \int_{t_1}^{t_2} \langle F^{\text{ext}}, \delta q \rangle dt = 0, \quad (3.28)$$

subject to the *phenomenological constraint*

$$\frac{\partial L}{\partial S_A} \dot{\Sigma}_A = \langle F^{\text{fr}(A)}, \dot{q} \rangle + J_{AB} \dot{\Gamma}^B + \mathcal{J}^{B \rightarrow A} \dot{W}^A, \quad \text{for } A = 1, \dots, P, \quad (3.29)$$

and for variations subject to the *variational constraint*

$$\frac{\partial L}{\partial S_A} \delta \Sigma_A = \langle F^{\text{fr}(A)}, \delta q \rangle + J_{AB} \delta \Gamma^B + \mathcal{J}^{B \rightarrow A} \delta W^A, \quad \text{for } A = 1, \dots, P, \quad (3.30)$$

with $\delta q(t_i) = \delta W^A(t_i) = \delta \Gamma^A(t_i) = 0$, $i = 1, 2$, $A = 1, \dots, P$.

From (3.28)–(3.30), we obtain the following system of evolution equations for the curves $q(t)$, $S_A(t)$, and $N_A(t)$:

$$\left\{ \begin{array}{l} \frac{d}{dt} \frac{\partial L}{\partial \dot{q}} - \frac{\partial L}{\partial q} = \sum_{A=1}^P F^{\text{fr}(A)} + F^{\text{ext}}, \\ \frac{d}{dt} N_A = \sum_{B=1}^P \mathcal{J}^{B \rightarrow A}, \quad A = 1, \dots, P, \\ \frac{\partial L}{\partial S_A} \dot{S}_A = \langle F^{\text{fr}(A)}, \dot{q} \rangle - \sum_{B=1}^P J_{AB} \left(\frac{\partial L}{\partial S_B} - \frac{\partial L}{\partial S_A} \right) - \sum_{B=1}^P \mathcal{J}^{B \rightarrow A} \frac{\partial L}{\partial N_A}, \quad A = 1, \dots, P. \end{array} \right. \quad (3.31)$$

We also obtain the conditions

$$\dot{\Gamma}^A = -\frac{\partial L}{\partial S_A} =: T^A, \quad \dot{W}^A = -\frac{\partial L}{\partial N_A} =: \mu^A, \quad \dot{\Sigma}_A = \dot{S}_A, \quad A = 1, \dots, P,$$

where we defined the temperature T^A and the chemical potential μ^A of the subsystem Σ_A . The variables Γ^A and W^A are again the thermodynamic displacements associated to the processes of heat and matter transfer.

The total energy satisfies $\frac{d}{dt} E = P_W^{\text{ext}}$ and the detailed energy balances can be carried out as in (3.24) and yields here

$$P_{H+M}^{B \rightarrow A} = J_{AB}(T^A - T^B).$$

The rate of total entropy production of the system is computed as

$$\dot{S} = -\sum_{A=1}^P \frac{1}{T^A} \langle F^{\text{fr}(A)}, \dot{q} \rangle + \sum_{A < B} J_{AB} \left(\frac{1}{T^B} - \frac{1}{T^A} \right) (T^B - T^A) + \sum_{A < B} \mathcal{J}^{B \rightarrow A} \left(\frac{\mu^B}{T^B} - \frac{\mu^A}{T^A} \right).$$

From the second law of thermodynamics, the total entropy production must be positive and hence suggests the phenomenological relations

$$F_i^{\text{fr}(A)} = -\lambda_{ij}^A \dot{q}^j, \quad \begin{bmatrix} \frac{T^A - T^B}{T^A T^B} J_{AB} \\ \mathcal{J}^{B \rightarrow A} \end{bmatrix} = \mathcal{L}_{AB} \begin{bmatrix} T^B - T^A \\ \frac{\mu^B}{T^B} - \frac{\mu^A}{T^A} \end{bmatrix}, \quad (3.32)$$

where the symmetric part of the $n \times n$ matrices λ^A and of the 2×2 matrices \mathcal{L}_{AB} are positive. The entries of these matrices are phenomenological coefficients determined experimentally, which may in general depend on the state variables. From Onsager's reciprocal relations, the 2×2 matrix

$$\mathcal{L}_{AB} = \begin{bmatrix} \mathcal{L}_{AB}^{HH} & \mathcal{L}_{AB}^{HM} \\ \mathcal{L}_{AB}^{MH} & \mathcal{L}_{AB}^{MM} \end{bmatrix}$$

is symmetric, for all A, B . The matrix elements \mathcal{L}_{AB}^{HH} and \mathcal{L}_{AB}^{MM} are related to the processes of heat conduction and diffusion between Σ_A and Σ_B . The coefficients \mathcal{L}_{AB}^{MH} and \mathcal{L}_{AB}^{HM} describe the cross-effects, and hence are associated to discrete versions of the process of thermal diffusion and the Dufour effect. Thermal diffusion is the process of matter diffusion due to the temperature difference between the compartments. The Dufour effect is the process of heat transfer due to difference of chemical potentials between the compartments.

Example: heat conduction and diffusion between two compartments. We consider a closed system consisting of two compartments as illustrated in Fig. 3.6. The compartments are separated by a permeable wall through which heat conduction and diffusion is possible. The system is closed and therefore there is no matter transfer with exterior, while we have heat and mass transfer between the compartments.

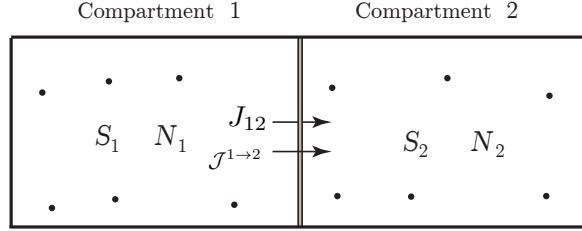

Figure 3.6: Non-simple closed system with a single chemical species, experiencing diffusion and heat conduction between two compartments.

The Lagrangian of this system is

$$L(S_1, S_2, N_1, N_2) = -U_1(S_1, N_1) - U_2(S_2, N_2),$$

where $U_i(S_i, N_i)$ is the internal energy of the i -th chemical species and the volume is assumed to be constant. In this case, the system (3.31) specifies to

$$\begin{cases} \dot{N}_1 = \mathcal{J}^{2 \rightarrow 1}, & \dot{N}_2 = \mathcal{J}^{1 \rightarrow 2}, \\ T^1 \dot{S}_1 = -J^{12}(T^2 - T^1) - \mathcal{J}^{2 \rightarrow 1} \mu^1, \\ T^2 \dot{S}_2 = -J^{12}(T^1 - T^2) - \mathcal{J}^{1 \rightarrow 2} \mu^2, \end{cases} \quad (3.33)$$

where

$$T^A = \frac{\partial U}{\partial S_A}, \quad \mu^A = \frac{\partial U}{\partial N_A}, \quad A = 1, 2$$

are the temperatures and chemical potentials of the A -th compartments. From (3.33) it follows that the equation for the total entropy $S = S_1 + S_2$ of the system is

$$\dot{S} = J^{12}(T^1 - T^2) \left(\frac{1}{T^1} - \frac{1}{T^2} \right) + \mathcal{J}^{1 \rightarrow 2} \left(\frac{\mu^1}{T^1} - \frac{\mu^2}{T^2} \right) \geq 0,$$

from which the phenomenological relations are obtained as in (3.32). The energy balance in each compartment is

$$\frac{d}{dt} U_1 = -J^{12}(T^2 - T^1), \quad \frac{d}{dt} U_2 = -J^{12}(T^1 - T^2),$$

which shows the relation between the flux J^{12} and the power $P^{1 \rightarrow 2} = J^{12}(T^2 - T^1)$ exchanged between the two compartments, due to heat conduction, diffusion, and their cross-effects. The total energy $E = U_1 + U_2$ is conserved.

Remark 3.3 (General structure of the variational formulation for adiabatically closed systems). In each of the situation considered, the variational constraint can be systematically obtained from the phenomenological constraint by replacing the time derivative by the delta

variation, for each process. For the most general case treated above, we have the following correspondence:

$$\frac{\partial L}{\partial S_A} \dot{\Sigma}_A = \langle F^{\text{fr}(A)}, \dot{q} \rangle + J_{AB} \dot{\Gamma}^B + \mathcal{J}^{B \rightarrow A} \dot{W}^A \rightsquigarrow \frac{\partial L}{\partial S_A} \delta \Sigma_A = \langle F^{\text{fr}(A)}, \delta q \rangle + J_{AB} \delta \Gamma^B + \mathcal{J}^{B \rightarrow A} \delta W^A.$$

In the above, the quantities to be determined from the state variables by phenomenological laws are $F^{\text{fr}(A)}$, J_{AB} , and $\mathcal{J}^{B \rightarrow A}$.

The structure of our variational formulation is better explained by adopting a general point of view. If we denote by \mathcal{Q} the thermodynamic configuration manifold and by $x \in \mathcal{Q}$ the collection of all the variables of the thermodynamic system, for instance $x = (q, S_A, N_A, W^A, \Gamma^A, \Sigma_A)$, $A = 1, \dots, P$ in the preceding case, then the variational formulation for adiabatically closed system falls into the following abstract setting. Given a Lagrangian $\mathcal{L} : T\mathcal{Q} \rightarrow \mathbb{R}$, an external force $\mathcal{F}^{\text{ext}} : T\mathcal{Q} \rightarrow T^*\mathcal{Q}$, and fiber preserving maps $A^\alpha : T\mathcal{Q} \rightarrow T^*\mathcal{Q}$, $A^\alpha(x, v) \in T_x^*\mathcal{Q}$, $\alpha = 1, \dots, k$, the variational formulation reads as follows:

$$\delta \int_{t_1}^{t_2} \mathcal{L}(x(t), \dot{x}(t)) dt + \int_{t_1}^{t_2} \langle \mathcal{F}^{\text{ext}}(x(t), \dot{x}(t)), \delta x(t) \rangle dt = 0, \quad (3.34)$$

where the curve $x(t)$ satisfies the *phenomenological constraint*

$$A^\alpha(x, \dot{x}) \cdot \dot{x} = 0, \quad \text{for } \alpha = 1, \dots, k, \quad (3.35)$$

and for variations δx subject to the *variational constraint*

$$A^\alpha(x, \dot{x}) \cdot \delta x = 0, \quad \text{for } \alpha = 1, \dots, k, \quad (3.36)$$

with $\delta x(t_1) = \delta x(t_2) = 0$.

This yields the system of equations

$$\begin{cases} \frac{d}{dt} \frac{\partial \mathcal{L}}{\partial \dot{x}} - \frac{\partial \mathcal{L}}{\partial x} - \mathcal{F}^{\text{ext}} = \lambda_\alpha A^\alpha(x, \dot{x}), \\ A^\alpha(x, \dot{x}) \cdot \dot{x} = 0, \quad \alpha = 1, \dots, k. \end{cases} \quad (3.37)$$

It is clear that all the variational formulations for adiabatically closed system considered above fall into this category, by appropriate choice for x , $\mathcal{L}(x, \dot{x})$, $\mathcal{F}^{\text{ext}}(x, \dot{x})$, and $A^\alpha(x, \dot{x})$. The energy defined by $\mathcal{E}(x, v) = \langle \frac{\partial \mathcal{L}}{\partial v}, v \rangle - \mathcal{L}(x, v)$ satisfies $\frac{d}{dt} \mathcal{E} = \langle \mathcal{F}^{\text{ext}}, \dot{x} \rangle$.

The constraints involved in this variational formulation admit an intrinsic geometric description. The variational constraint (3.36) defines the subset $C_V \subset T\mathcal{Q} \times_{\mathcal{Q}} T\mathcal{Q}$ given by

$$C_V = \{(x, v, \delta x) \in T\mathcal{Q} \times_{\mathcal{Q}} T\mathcal{Q} \mid A^\alpha(x, v) \cdot \delta x = 0, \quad \text{for } \alpha = 1, \dots, k\},$$

so that $C_V(x, v) := C_V \cap (\{(x, v)\} \times T_x\mathcal{Q})$ is a vector subspace of $T_x\mathcal{Q}$ for all $(x, v) \in T\mathcal{Q}$. The phenomenological constraint (3.35) defines the subset $C_K \subset T\mathcal{Q}$ given by

$$C_K = \{(x, v) \in T\mathcal{Q} \mid A^\alpha(x, v) \cdot v = 0, \quad \text{for } \alpha = 1, \dots, k\}.$$

Then, one notes that the constraint C_K can be *intrinsically defined* from C_V as

$$C_K = \{(x, v) \in T\mathcal{Q} \mid (x, v) \in C_V(x, v)\}.$$

Constraints C_V and C_K related in this way are called *nonlinear nonholonomic constraints of thermodynamic type*, see Gay-Balmaz and Yoshimura [2017a, 2018c].

3.3 Open thermodynamic systems

The thermodynamic systems that we considered so far are restricted to the adiabatically closed cases. For such systems, the interaction with the exterior is only through the exchange of mechanical work, and hence the first law for such systems reads

$$\frac{d}{dt}E = \langle F^{\text{ext}}, \dot{q} \rangle = P_W^{\text{ext}}.$$

We now consider the more general case of open systems exchanging work, heat, and matter with the exterior. In this case, the first law reads

$$\frac{d}{dt}E = P_W^{\text{ext}} + P_H^{\text{ext}} + P_M^{\text{ext}},$$

where P_H^{ext} is the power associated to the transfer of heat into the system and P_M^{ext} is the power associated to the transfer of matter into the system. As we recall below, to the transfer of matter into or out of the system is associated a transfer of work and heat. By convention, P_W^{ext} and P_H^{ext} denote uniquely the power associated to work and heat that is not associated to a transfer of matter. The power associated to a transfer of heat or work due to a transfer of matter is included in P_M^{ext} .

In order to get a concrete expression for P_M^{ext} , let us consider an open system with several ports, $a = 1, \dots, A$, through which matter can flow into or out of the system. We suppose, for simplicity, that the system involves only one chemical species and denote by N the number of moles of this species. The mole balance equation is

$$\frac{d}{dt}N = \sum_{a=1}^A \mathcal{J}^a,$$

where \mathcal{J}^a is the molar flow rate *into* the system through the a -th port, so that $\mathcal{J}^a > 0$ for flow into the system and $\mathcal{J}^a < 0$ for flow out of the system.

As matter enters or leaves the system, it carries its internal, potential, and kinetic energy. This energy flow rate at the a -th port is the product $E^a \mathcal{J}^a$ of the energy per mole (or molar energy) E^a and the molar flow rate \mathcal{J}^a at the a -th port. In addition, as matter enters or leaves the system it also exerts work on the system that is associated with pushing the species into or out of the system. The associated energy flow rate is given at the a -th port by $\mathcal{J}^a p^a V^a$, where p^a and V^a are the pressure and the molar volume of the substance flowing through the a -th port. From this we get the expression

$$P_M^{\text{ext}} = \sum_{a=1}^A \mathcal{J}^a (E^a + p^a V^a). \quad (3.38)$$

We refer, for instance, to [Sandler \[2006\]](#), [Klein and Nellis \[2011\]](#) for the detailed explanations of the first law for open systems.

We present below an extension of the variational formulation to the case of open systems. In order to motivate the form of the constraints that we use, we first consider a particular case of simple open system, namely, the case of a system with a single chemical species N in a single compartment with constant volume V and without mechanical effects. In this particular situation, the energy of the system is given by the internal energy written as $U = U(S, N)$, since $V = V_0$ is constant. The balance of mole and energy are respectively given by

$$\frac{d}{dt}N = \sum_{a=1}^A \mathcal{J}^a, \quad \frac{d}{dt}U = \sum_{a=1}^A \mathcal{J}^a (U^a + p^a V^a) = \sum_{a=1}^A \mathcal{J}^a H^a,$$

see (3.38), where $H^a = U^a + p^a V^a$ is the molar enthalpy at the a -th port and where U^a , p^a , and V^a are respectively the molar internal energy, the pressure and the molar volume at the a -th port. From these equations and the second law, one obtains the equations for the rate of change of the entropy of the system as

$$\frac{d}{dt}S = I + \sum_{a=1}^A \mathcal{J}^a S^a, \quad (3.39)$$

where S^a is the molar entropy at the a -th port and I is the rate of internal entropy production of the system given by

$$I = \frac{1}{T} \sum_{a=1}^A \mathcal{J}^a (H^a - TS^a - \mu), \quad (3.40)$$

with $T = \frac{\partial U}{\partial S}$ the temperature and $\mu = \frac{\partial U}{\partial N}$ the chemical potential. For our variational treatment, it is useful to rewrite the rate of internal entropy production as

$$I = \frac{1}{T} \sum_{a=1}^A \left[\mathcal{J}_S^a (T^a - T) + \mathcal{J}^a (\mu^a - \mu) \right],$$

where we defined the entropy flow rate $\mathcal{J}_S^a := \mathcal{J}^a S^a$ and also used the relation $H^a = U^a + p^a V^a = \mu^a + T^a S^a$. The thermodynamic quantities known at the a -th port are usually the pressure p^a and the temperature T^a , from which the other thermodynamic quantities, such as $\mu^a = \mu^a(p^a, T^a)$ or $S^a = S^a(p^a, T^a)$ are deduced in view of the state equations of the gas.

Here, we only show the variational formulation for a simplified case of open systems, namely, an open system with only one entropy variable and one compartment with a single species. So, the open system is a simple system. The reader is referred to [Gay-Balmaz and Yoshimura \[2018a\]](#) for the more general cases of open systems, such as the extensions of (3.6)–(3.8) and (3.28)–(3.30) to open systems, as well as for the case when the mechanical energy of the species is taken into account.

The state variables needed to describe the system are $(q, v, S, N) \in TQ$ and the Lagrangian is a map

$$L : TQ \times \mathbb{R} \times \mathbb{R} \rightarrow \mathbb{R}, \quad (q, v, S, N) \mapsto L(q, v, S, N),$$

We assume that the system has A ports, through which species can flow out or into the system and B heat sources. As above, μ^a and T^a denote the chemical potential and temperature at the a -th port and T^b denotes the temperature of the b -th heat source.

Find the curves $q(t)$, $S(t)$, $\Gamma(t)$, $\Sigma(t)$, $W(t)$, $N(t)$ which are critical for the *variational condition*

$$\delta \int_{t_1}^{t_2} \left[L(q, \dot{q}, S, N) + \dot{W}N + \dot{\Gamma}(S - \Sigma) \right] dt + \int_{t_1}^{t_2} \langle F^{\text{ext}}, \delta q \rangle dt = 0, \quad (3.41)$$

subject to the *phenomenological constraint*

$$\frac{\partial L}{\partial S} \dot{\Sigma} = \langle F^{\text{fr}}, \dot{q} \rangle + \sum_{a=1}^A \left[\mathcal{J}^a (\dot{W} - \mu^a) + \mathcal{J}_S^a (\dot{\Gamma} - T^a) \right] + \sum_{b=1}^B \mathcal{J}_S^b (\dot{\Gamma} - T^b), \quad (3.42)$$

and for variations subject to the *variational constraint*

$$\frac{\partial L}{\partial S} \delta \Sigma = \langle F^{\text{fr}}, \delta q \rangle + \sum_{a=1}^A \left[\mathcal{J}^a \delta W + \mathcal{J}_S^a \delta \Gamma \right] + \sum_{b=1}^B \mathcal{J}_S^b \delta \Gamma, \quad (3.43)$$

with $\delta q(t_1) = \delta q(t_2) = 0$, $\delta W(t_1) = \delta W(t_2) = 0$, and $\delta \Gamma(t_1) = \delta \Gamma(t_2) = 0$.

We note that the variational constraint (3.43) follows from the phenomenological constraint (3.42) by formally replacing the time derivatives $\dot{\Sigma}$, \dot{q} , \dot{W} , $\dot{\Gamma}$ by the corresponding virtual displacements $\delta \Sigma$, δq , δW , $\delta \Gamma$, and by removing all the terms that depend uniquely on the exterior, i.e., the terms $\mathcal{J}^a \mu^a$, $\mathcal{J}_S^a T^a$, and $\mathcal{J}_S^b T^b$. Such a systematic correspondence between the phenomenological and variational constraints, extends to open system the correspondence for adiabatically closed systems verified in (3.2) \rightsquigarrow (3.3), (3.7) \rightsquigarrow (3.8), (3.20) \rightsquigarrow (3.21), (3.29) \rightsquigarrow (3.30), see also Remarks 3.1 and 3.3. Note that the action functional in (3.41) has the same form as that in the case of adiabatically closed systems.

Taking variations of the integral in (3.41), integrating by parts, and using $\delta q(t_1) = \delta q(t_2) = 0$, $\delta W(t_1) = \delta W(t_2) = 0$, and $\delta \Gamma(t_1) = \delta \Gamma(t_2) = 0$ and using the variational constraint (3.43), we obtain the following conditions:

$$\begin{aligned} \delta q : \quad & \frac{d}{dt} \frac{\partial L}{\partial \dot{q}^i} - \frac{\partial L}{\partial q^i} = F_i^{\text{fr}} + F_i^{\text{ext}}, \quad i = 1, \dots, n, \\ \delta S : \quad & \dot{\Gamma} = - \frac{\partial L}{\partial S}, \\ \delta W : \quad & \dot{N} = \sum_{a=1}^A \mathcal{J}^a, \\ \delta N : \quad & \dot{W} = - \frac{\partial L}{\partial N}, \\ \delta \Gamma : \quad & \dot{S} = \dot{\Sigma} + \sum_{a=1}^A \mathcal{J}_S^a + \sum_{b=1}^B \mathcal{J}_S^b. \end{aligned} \quad (3.44)$$

By the second and fourth equations the variables Γ and W are thermodynamic displacements as before. The main difference with the earlier cases is that now \dot{S} and $\dot{\Sigma}$ are no more equal. The physical interpretation of Σ is given below. From (3.42), it follows the system of evolution equations for the curves $q(t)$, $S(t)$, $N(t)$:

$$\left\{ \begin{aligned} \frac{d}{dt} \frac{\partial L}{\partial \dot{q}} - \frac{\partial L}{\partial q} &= F^{\text{fr}} + F^{\text{ext}}, & \frac{d}{dt} N &= \sum_{a=1}^A \mathcal{J}^a, \\ \frac{\partial L}{\partial S} \left(\dot{S} - \sum_{a=1}^A \mathcal{J}_S^a - \sum_{b=1}^B \mathcal{J}_S^b \right) & & & \\ &= \langle F^{\text{fr}}, \dot{q} \rangle - \sum_{a=1}^A \left[\mathcal{J}^a \left(\frac{\partial L}{\partial N} + \mu^a \right) + \mathcal{J}_S^a \left(\frac{\partial L}{\partial S} + T^a \right) \right] - \sum_{b=1}^B \mathcal{J}_S^b \left(\frac{\partial L}{\partial S} + T^b \right). \end{aligned} \right. \quad (3.45)$$

The energy balance for this system is computed as

$$\frac{d}{dt} E = \underbrace{\langle F^{\text{ext}}, \dot{q} \rangle}_{=P_W^{\text{ext}}} + \underbrace{\sum_{b=1}^B \mathcal{J}_S^b T^b}_{=P_H^{\text{ext}}} + \underbrace{\sum_{a=1}^A (\mathcal{J}^a \mu^a + \mathcal{J}_S^a T^a)}_{=P_M^{\text{ext}}}.$$

From the last equation in (3.45), the rate of entropy equation of the system is found as

$$\dot{S} = I + \sum_{a=1}^A \mathcal{J}_S^a + \sum_{b=1}^B \mathcal{J}_S^b, \quad (3.46)$$

where I is the rate of internal entropy production given by

$$I = \underbrace{-\frac{1}{T} \langle F^{\text{fr}}, \dot{q} \rangle}_{\text{mechanical friction}} + \underbrace{\frac{1}{T} \sum_{a=1}^A \left[\mathcal{J}^a (\mu^a - \mu) + \mathcal{J}_S^a (T^a - T) \right]}_{\text{mixing of matter flowing into the system}} + \underbrace{\frac{1}{T} \sum_{b=1}^B \mathcal{J}_S^b (T^b - T)}_{\text{heating}}.$$

From the last equation (3.44) and (3.46) we notice that $\dot{\Sigma} = I$ is the rate of internal entropy production. The second and third terms in (3.46) represent the entropy flow rate into the system associated to the ports and the heat sources. The second law requires $I \geq 0$, whereas the sign of the rate of entropy flow into the system is arbitrary.

Example: A piston device with ports and heat sources. We consider a piston with mass m moving in a cylinder containing a species with internal energy $U(S, V, N)$. We assume that the cylinder has two external heat sources with entropy flow rates \mathcal{J}^{b_i} , $i = 1, 2$, and two ports through which the species is injected into or flows out of the cylinder with molar flow rates \mathcal{J}^{a_i} , $i = 1, 2$. The entropy flow rates at the ports are given by $\mathcal{J}_S^{a_i} = \mathcal{J}^{a_i} S^{a_i}$.

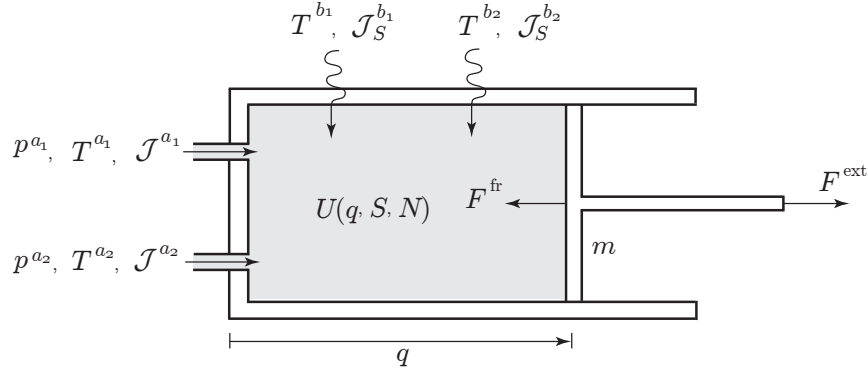

Figure 3.7: A piston device with ports and heat sources.

The variable q characterizes the one-dimensional motion of the piston, such that the volume occupied by the species is $V = \alpha q$, with α the sectional area of the cylinder. The Lagrangian of the system is

$$L(q, \dot{q}, S, N) = \frac{1}{2} m \dot{q}^2 - U(S, \alpha q, N).$$

The variational formulation (3.41)–(3.43) yields the evolution equations for $q(t)$, $S(t)$, $N(t)$

$$m\ddot{q} = p(q, S, N)\alpha + F^{\text{fr}} + F^{\text{ext}}, \quad \dot{N} = \sum_{a=1}^A \mathcal{J}^a, \quad \dot{S} = I + \sum_{i=1}^2 \mathcal{J}_S^{a_i} + \sum_{j=1}^2 \mathcal{J}_S^{b_j},$$

where $p(q, S, N) = -\frac{\partial U}{\partial V}$ is the pressure and $I = \dot{\Sigma}$ is the internal entropy production given by

$$I = -\frac{1}{T} F^{\text{fr}} \dot{q} + \frac{1}{T} \sum_{i=1}^2 \left[(\mu^{a_i} - \mu) + S^{a_i} (T^{a_i} - T) \right] \mathcal{J}^{a_i} + \frac{1}{T} \sum_{j=1}^2 \mathcal{J}_S^{b_j} (T^{b_j} - T).$$

The first term represents the entropy production associated to the friction experiencing by the moving piston, the second term is the entropy production associated to the mixing of gas flowing into the cylinder at the two ports a_1, a_2 , and the third term denotes the entropy production due to the external heating. The second law requires that each of these terms is positive. The energy balance holds as

$$\frac{d}{dt} E = \underbrace{F^{\text{ext}} \dot{q}}_{=P_W^{\text{ext}}} + \underbrace{\sum_{j=1}^2 \mathcal{J}_S^{b_j} T^{b_j}}_{=P_H^{\text{ext}}} + \underbrace{\sum_{i=1}^2 (\mathcal{J}^{a_i} \mu^{a_i} + \mathcal{J}_S^{a_i} T^{a_i})}_{=P_M^{\text{ext}}}.$$

Remark 3.4 (Inclusion of chemical reactions). The variational formulations presented so far, can be extended to include several chemical species, undergoing chemical reactions. Let us denote by $I = 1, \dots, R$ the chemical species and by $a = 1, \dots, r$ the chemical reactions. Chemical reactions may be represented by

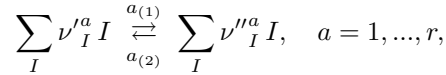

where $a(1)$ and $a(2)$ are the forward and backward reactions associated to the reaction a , and $\nu_I^a, \nu_I''^a$ are the forward and backward stoichiometric coefficients for the component I in the reaction a . Mass conservation during each reaction is given by

$$\sum_I m_I \nu_I^a = 0 \quad \text{for } a = 1, \dots, r \text{ (Lavoisier law),}$$

where $\nu_I^a := \nu_I''^a - \nu_I^a$ and m_I is the molecular mass of species I . The affinity of reaction a is the state function defined by $\mathcal{A}^a = -\sum_{I=1}^R \nu_I^a \mu^I$, $a = 1, \dots, r$, where μ^I is the chemical potential of the chemical species I . The thermodynamic flux associated with reaction a is the rate of extent denoted J_a .

The thermodynamic displacements are W^I and ν^a , such that

$$\dot{W}^I = \mu^I, \quad I = 1, \dots, R \quad \text{and} \quad \dot{\nu}^a = -\mathcal{A}^a, \quad a = 1, \dots, r. \quad (3.47)$$

For chemical reactions in a single compartment assumed to be adiabatically closed and without mechanical components, the variational formulation is given as follows.

Find the curves $S(t), N_I(t), W^I(t), \nu^a(t), I = 1, \dots, R, a = 1, \dots, r$, which are critical for the variational condition

$$\delta \int_{t_1}^{t_2} \left[L(N_1, \dots, N_R, S) + \dot{W}^I N_I \right] dt = 0, \quad (3.48)$$

subject to the *phenomenological and chemical constraints*

$$\frac{\partial L}{\partial S} \dot{S} = J_a \dot{\nu}^a \quad \text{and} \quad \dot{\nu}^a = \nu_I^a \dot{W}^I, \quad a = 1, \dots, r, \quad (3.49)$$

and for variations subject to the *variational constraints*

$$\frac{\partial L}{\partial S} \delta S = J_a \delta \nu^a \quad \text{and} \quad \delta \nu^a = \nu_I^a \delta W^I, \quad a = 1, \dots, r, \quad (3.50)$$

with $\delta W^I(t_1) = \delta W^I(t_2) = 0$, $I = 1, \dots, R$.

The variational formulation (3.48)–(3.50) yields the evolution equations for chemical reactions

$$\dot{N}_I = J_a \nu_I^a, \quad I = 1, \dots, R \quad \text{and} \quad T \dot{S} = J_a \mathcal{A}^a,$$

together with the conditions (3.47).

Chemical reactions can be included in all the thermodynamic systems considered previously by combining the variational formulation (3.48)–(3.50) for chemical reactions with the variational formulations (3.6)–(3.8), (3.28)–(3.30), and (3.41)–(3.43).

Remark 3.5 (General structure of the variational formulation for open systems). As opposed to the adiabatically closed case, the phenomenological and variational constraints depend explicitly on time $t \in \mathbb{R}$ for the case of open systems. In addition, the phenomenological constraint involves an affine term that depends only on the properties at the ports. From a general point of view, letting \mathcal{Q} be the configuration manifold, these constraints are defined by the maps $A^\alpha : \mathbb{R} \times T\mathcal{Q} \rightarrow T^*\mathcal{Q}$, $A(t, x, v) \in T_x^*\mathcal{Q}$, with $A^\alpha(t, x, v) \in T_x^*\mathcal{Q}$, and $B^\alpha : \mathbb{R} \times T\mathcal{Q} \rightarrow \mathbb{R}$, $\alpha = 1, \dots, k$, where $t \in \mathbb{R}$ and $(x, v) \in T\mathcal{Q}$.

Given a time dependent Lagrangian $\mathcal{L} : \mathbb{R} \times T\mathcal{Q} \rightarrow \mathbb{R}$ and an external force $\mathcal{F}^{\text{ext}} : \mathbb{R} \times T\mathcal{Q} \rightarrow T^*\mathcal{Q}$, the variational formulation (3.34)–(3.36) is extended as follows.

$$\delta \int_{t_1}^{t_2} \mathcal{L}(t, x(t), \dot{x}(t)) dt + \int_{t_1}^{t_2} \langle \mathcal{F}^{\text{ext}}(t, x(t), \dot{x}(t)), \delta x(t) \rangle dt = 0, \quad (3.51)$$

where the curve $x(t)$ satisfies the *phenomenological constraint*

$$A^\alpha(t, x, \dot{x}) \cdot \dot{x} + B^\alpha(t, x, \dot{x}) = 0, \quad \text{for } \alpha = 1, \dots, k. \quad (3.52)$$

and for variations δx subject to the *variational constraint*

$$A^\alpha(t, x, \dot{x}) \cdot \delta x = 0, \quad \text{for } \alpha = 1, \dots, k. \quad (3.53)$$

with $\delta x(t_1) = \delta x(t_2) = 0$.

This yields the system of equations

$$\begin{cases} \frac{d}{dt} \frac{\partial \mathcal{L}}{\partial \dot{x}} - \frac{\partial \mathcal{L}}{\partial x} - \mathcal{F}^{\text{ext}} = \lambda_\alpha A^\alpha(t, x, \dot{x}) \\ A^\alpha(t, x, \dot{x}) \cdot \dot{x} + B^\alpha(t, x, \dot{x}) = 0, \quad \alpha = 1, \dots, k. \end{cases} \quad (3.54)$$

The variational formulation for open system falls into this category, by appropriate choice for x and \mathcal{L} . For instance, for (3.41)–(3.43) one has $x = (q, S, N, W, \Gamma, \Sigma)$ and \mathcal{L} is the integrand in (3.41). Note that in (3.51) we choose the Lagrangian to be time dependent for the sake of generality. In fact all the variational formulations for thermodynamics presented above generalize easily to time dependent Lagrangians. We refer to [Gay-Balmaz and Yoshimura \[2018a\]](#) for a full treatment.

The energy defined by $\mathcal{E}(t, x, v) = \langle \frac{\partial \mathcal{L}}{\partial v}, v \rangle - \mathcal{L}(t, x, v)$ satisfies the energy balance equation

$$\frac{d}{dt} \mathcal{E} = \langle \mathcal{F}^{\text{ext}}, \dot{x} \rangle - \lambda_\alpha B^\alpha - \frac{\partial \mathcal{L}}{\partial t}. \quad (3.55)$$

In the application to open thermodynamic systems, the first term is identified with P_W^{ext} , the second term is identified with P_{H+M}^{ext} , while the third term is due to the explicit dependence of the Lagrangian on the time.

4 Variational formulation for continuum thermodynamic systems

In this section we extend Hamilton's principle of continuum mechanics (2.12) to nonequilibrium continuum thermodynamics, in the same way as Hamilton's principle of classical mechanics (2.2) was extended to the finite dimensional case of discrete thermodynamic systems in §3.

We consider a multicomponent compressible fluid subject to the irreversible processes of viscosity, heat conduction, and diffusion. In presence of irreversible processes, we impose no-slip boundary conditions, hence the configuration manifold for the fluid motion is the manifold $Q = \text{Diff}_0(\mathcal{D})$ of diffeomorphisms that keep the boundary $\partial\mathcal{D}$ pointwise fixed.

We assume that the fluid has P components with mass densities $\varrho_A(t, X)$, $A = 1, \dots, P$ in the material description, and denote by $S(t, X)$ the entropy density in the material description. The motion of the multicomponent fluid is given as before by a curve of diffeomorphisms $\varphi_t \in \text{Diff}_0(\mathcal{D})$ but now $\dot{\varphi}_t$ is interpreted as the barycentric material velocity of the multicomponent fluid. The Lagrangian of the multicomponent fluid with irreversible processes is

$$L : T\text{Diff}_0(\mathcal{D}) \times \mathcal{F}(\mathcal{D}) \times \mathcal{F}(\mathcal{D})^P \rightarrow \mathbb{R}, \quad (\varphi, \dot{\varphi}, S, \varrho_1, \dots, \varrho_P) \mapsto L(\varphi, \dot{\varphi}, S, \varrho_1, \dots, \varrho_P),$$

where $\mathcal{F}(\mathcal{D})$ denote a space of functions on \mathcal{D} , and is given by

$$\begin{aligned} L(\varphi, \dot{\varphi}, S, \varrho_1, \dots, \varrho_P) &= K(\varphi, \dot{\varphi}, \varrho_1, \dots, \varrho_P) - U(\varphi, S, \varrho_1, \dots, \varrho_P) \\ &= \int_{\mathcal{D}} \left[\frac{1}{2} \varrho(X) |\dot{\varphi}(X)|^2 - \mathcal{E}(\varrho_1(X), \dots, \varrho_P(X), S(X), \nabla\varphi(X)) \right] d^3X. \end{aligned} \quad (4.1)$$

The first term is the total kinetic energy of the fluid, where $\varrho := \sum_{A=1}^P \varrho_A$ is the total mass density. The second term is minus the total internal energy of the fluid, with \mathcal{E} a general expression for the internal energy density written in terms of $\varrho_A(X)$, $S(X)$, and the deformation gradient $\nabla\varphi(X)$. As in (2.16) \mathcal{E} satisfies the material covariance assumption and depends on the deformation gradient only through the Jacobian J_φ . As in (2.18), there is a function ϵ , the internal energy density in the spatial representation, such that

$$\mathcal{E}(\varrho_1, \dots, \varrho_P, \nabla\varphi) = \varphi^* [\epsilon(\rho_1, \dots, \rho_P, s)], \quad \text{for } \rho_A = \varphi_* \varrho_A, \quad s = \varphi_* S. \quad (4.2)$$

In the spatial description, the Lagrangian (4.1) reads

$$\ell(\mathbf{v}, s, \rho_1, \dots, \rho_P) = \int_{\mathcal{D}} \left[\frac{1}{2} \rho |\mathbf{v}|^2 - \epsilon(\rho_1, \dots, \rho_P, s) \right] d^3x.$$

Note that in absence of irreversible process, the Lagrangian (4.1) would just be defined on the tangent bundle $T\text{Diff}(\mathcal{D})$ with $\varrho_A = \varrho_{\text{ref}A}$, $A = 1, \dots, P$ and $S = S_{\text{ref}}$ seen as fixed parameters, exactly as in (2.15) for the single component case.

Remark 4.1 (Material VS spatial variational principle). As we present below, the variational formulation for continuum thermodynamical systems in the *material description* is the natural continuum (infinite dimensional) version of that of discrete (finite dimensional)

thermodynamical systems described in §3. This is in analogy with the conservative reversible case recalled earlier, namely, the Hamilton principle (2.12), associated to the material description of continuum systems, is the natural continuum version of the classical Hamilton principle (2.2). This is why we shall first consider below in §4.1 the variational formulation of continuum systems in the material description, and *deduce* from it the variational formulation in the spatial description later in §4.2. The latter is more involved since it contains additional constraints, as we have seen in conservative reversible case in §2.3.

4.1 Variational formulation in the Lagrangian description

The variational formulation of a multicomponent fluid subject to the irreversible processes of viscosity, heat conduction, and diffusion, is the continuum version of the variational formulation (3.28)–(3.30) for finite dimensional thermodynamic systems with friction, heat and mass transfer. The analogues to the thermodynamic fluxes F^{fr} , J_{AB} , $\mathcal{J}^{B \rightarrow A}$ are the viscous stress, the entropy flux density, and the diffusive flux density given by \mathbf{P}^{fr} , \mathbf{J}_S , \mathbf{J}_A in the material description. Total mass conservation imposes the condition $\sum_{A=1}^P \mathbf{J}_A = 0$.

We give below the variational formulation for a general Lagrangian with density \mathcal{L} , i.e.,

$$L(\varphi, \dot{\varphi}, S, \varrho_1, \dots, \varrho_P) = \int_{\mathcal{D}} \mathcal{L}(\varphi, \dot{\varphi}, \nabla \varphi, S, \varrho_1, \dots, \varrho_P) d^3 X. \quad (4.3)$$

The continuum version of the variational formulation (3.28)–(3.30) that we propose is the following.

Find the curves $\varphi(t)$, $S(t)$, $\Gamma(t)$, $\Sigma(t)$, $W^A(t)$, $\varrho_A(t)$ which are critical for the *variational condition*

$$\int_0^T \int_{\mathcal{D}} \left[\mathcal{L}(\varphi, \dot{\varphi}, \nabla \varphi, S, \varrho_1, \dots, \varrho_P) + \dot{W}^A \varrho_A + \dot{\Gamma}(S - \Sigma) \right] d^3 X dt = 0 \quad (4.4)$$

subject to the *phenomenological constraint*

$$\frac{\partial \mathcal{L}}{\partial S} \dot{\Sigma} = -\mathbf{P}^{\text{fr}} : \nabla \dot{\varphi} + \mathbf{J}_S \cdot \nabla \dot{\Gamma} + \mathbf{J}_A \cdot \nabla \dot{W}^A \quad (4.5)$$

and for variations subject to the *variational constraint*

$$\frac{\partial \mathcal{L}}{\partial S} \delta \Sigma = -\mathbf{P}^{\text{fr}} : \nabla \delta \varphi + \mathbf{J}_S \cdot \nabla \delta \Gamma + \mathbf{J}_A \cdot \nabla \delta W^A \quad (4.6)$$

with $\delta \varphi(t_i) = \delta \Gamma(t_i) = \delta W^A(t_i) = 0$, $i = 1, 2$, and with $\delta \varphi|_{\partial \mathcal{D}} = 0$.

Taking variations of the integral in (4.4), integrating by parts, and using $\delta \varphi(t_i) = \delta \Gamma(t_i) = \delta W^A(t_i) = 0$, $i = 1, 2$, and $\delta \varphi|_{\partial \mathcal{D}} = 0$, it follows

$$\int_{t_1}^{t_2} \int_{\mathcal{D}} \left[\left(\frac{\partial \mathcal{L}}{\partial \varphi^a} \delta \varphi^a - \frac{\partial}{\partial t} \frac{\partial \mathcal{L}}{\partial \dot{\varphi}^a} - \frac{\partial}{\partial A} \frac{\partial \mathcal{L}}{\partial \varphi_{,A}^a} \right) \delta \varphi^a + \frac{\partial \mathcal{L}}{\partial S} \delta S + \left(\frac{\partial \mathcal{L}}{\partial \varrho_A} + \dot{W}^A \right) \delta \varrho_A - \dot{\varrho}_A \delta W^A - (\dot{S} - \dot{\Sigma}) \delta \Gamma + \dot{\Gamma}(\delta S - \delta \Sigma) \right] d^3 X dt = 0.$$

Using the variational constraint (4.6) integrating by parts and collecting the terms proportional to $\delta\varphi$, $\delta\Gamma$, δS , δW^A , and $\delta\varrho_A$, we get

$$\begin{aligned} \delta\varphi: \quad & \frac{d}{dt} \frac{\partial \mathcal{L}}{\partial \dot{\varphi}} + \text{DIV} \left(\frac{\partial \mathcal{L}}{\partial \nabla \varphi} + \dot{\Gamma} \frac{\partial \mathcal{L}^{-1}}{\partial S} \mathbf{P}^{\text{fr}} \right) - \frac{\partial \mathcal{L}}{\partial \varphi} = 0 \\ \delta\Gamma: \quad & \dot{S} = \text{DIV} \left(\dot{\Gamma} \frac{\partial \mathcal{L}^{-1}}{\partial S} \mathbf{J}_S \right) + \dot{\Sigma}, \quad \delta S: \quad \dot{\Gamma} = -\frac{\partial \mathcal{L}}{\partial S}, \\ \delta W_A: \quad & \dot{\varrho}_A = \text{DIV} \left(\dot{\Gamma} \frac{\partial \mathcal{L}^{-1}}{\partial S} \mathbf{J}_A \right), \quad \delta\varrho_A: \quad \dot{W}^A = -\frac{\partial \mathcal{L}}{\partial \varrho_A}, \end{aligned} \quad (4.7)$$

together with the boundary conditions

$$\int_{\partial \mathcal{D}} \mathbf{P}^{\text{fr}B}_a \mathbf{N}_B \delta\varphi^a dS = 0, \quad \int_{\partial \mathcal{D}} \mathbf{J}_S \cdot \mathbf{N} \delta\Gamma dS = 0, \quad \int_{\partial \mathcal{D}} \mathbf{J}_A \cdot \mathbf{N} \delta W^A dS = 0,$$

where \mathbf{N} is the outward pointing unit normal vector field to $\partial \mathcal{D}$. The first boundary term vanishes since $\delta\varphi|_{\partial \mathcal{D}} = 0$ from the no-slip boundary condition. The second and third conditions give

$$\mathbf{J}_S \cdot \mathbf{N} = 0 \quad \text{and} \quad \mathbf{J}_A \cdot \mathbf{N} = 0, \quad A = 1, \dots, P, \quad \text{on} \quad \partial \mathcal{D},$$

i.e., the fluid is adiabatically closed.

From the third and fifth conditions in (4.7), we have $\dot{\Gamma} = -\frac{\partial \mathcal{L}}{\partial S} = \mathfrak{T}$, the temperature in material representation, and $\dot{W}^A = -\frac{\partial \mathcal{L}}{\partial \varrho_A} = \Upsilon^A$, a generalization of the chemical potential of component A in material representation. The second equation in (4.7) thus reads $\dot{S} + \text{DIV} \mathbf{J}_S = \dot{\Sigma}$ and attributes to Σ the meaning of *entropy generation rate density*. From the first and fourth equation and the constraint, we get the system

$$\begin{cases} \frac{d}{dt} \frac{\partial \mathcal{L}}{\partial \dot{\varphi}} + \text{DIV} \left(\frac{\partial \mathcal{L}}{\partial \nabla \varphi} - \mathbf{P}^{\text{fr}} \right) - \frac{\partial \mathcal{L}}{\partial \varphi} = 0 \\ \dot{\varrho}_A + \text{DIV} \mathbf{J}_A = 0, \quad A = 1, \dots, P \\ \mathfrak{T}(\dot{S} + \text{DIV} \mathbf{J}_S) = \mathbf{P}^{\text{fr}} : \nabla \dot{\varphi} - \mathbf{J}_S \cdot \nabla \mathfrak{T} - \mathbf{J}_A \cdot \nabla \Upsilon^A, \end{cases} \quad (4.8)$$

for the fields $\varphi(t, X)$, $\varrho_A(t, X)$, and $S(t, X)$. The parameterization of the thermodynamic fluxes \mathbf{P}^{fr} , \mathbf{J}_S , \mathbf{J}_A in terms of the thermodynamic forces are discussed in the Eulerian description below.

4.2 Variational formulation in the Eulerian description

While the variational formulation is simpler in the material description, the resulting equations of motion are usually written and studied in the spatial description. It is therefore useful to have an Eulerian version of the variational formulation (4.4)–(4.6). In order to obtain such a variational formulation, all the variables used in (4.4)–(4.6) must be converted to their Eulerian analogue. We have already seen the relations $s = \varphi_* S$ and $\rho_A = \varphi_* \varrho_A$ between the Eulerian and Lagrangian mass densities and entropy densities, where the pull-back notation has been defined in (2.17). The Eulerian quantities associated to Σ , Γ , and W^A are defined as follows

$$\sigma = \varphi_* \Sigma, \quad \gamma = \Gamma \circ \varphi^{-1}, \quad w^A = W^A \circ \varphi^{-1}.$$

The Eulerian version of the Piola-Kirchhoff viscous stress tensor \mathbf{P}^{fr} is the viscous stress tensor $\boldsymbol{\sigma}^{\text{fr}}$ obtained via the Piola transform, see Marsden and Hughes [1983], Gay-Balmaz and Yoshimura [2017b].

From the material covariance assumption, the Lagrangian (4.3) can be rewritten exclusively in terms of spatial variables as

$$\ell(\mathbf{v}, s, \rho_1, \dots, \rho_P) = \int_{\mathcal{D}} \mathcal{L}(\mathbf{v}, s, \rho_1, \dots, \rho_P) d^3x,$$

where the Lagrangian density is defined by

$$\mathcal{L}(\mathbf{v}, s, \rho_1, \dots, \rho_P) = \varphi_* [\mathcal{L}(\mathbf{v} \circ \varphi, \varphi^* \rho_1, \dots, \varphi^* \rho_P, \varphi^* s)].$$

Using all the preceding relations between Lagrangian and Eulerian variables, we can rewrite the variational formulation (4.4)–(4.6) in the following purely Eulerian form.

Find the curves $\mathbf{v}(t)$, $s(t)$, $\gamma(t)$, $\sigma(t)$, $w^A(t)$, $\rho_A(t)$ which are critical for the *variational condition*

$$\int_0^T \int_{\mathcal{D}} \left[\mathcal{L}(\mathbf{v}, s, \rho_1, \dots, \rho_P) + D_t w^A \rho_A + D_t \gamma (s - \sigma) \right] d^3x dt = 0 \quad (4.9)$$

subject to the *phenomenological constraint*

$$\frac{\partial \mathcal{L}}{\partial s} \bar{D}_t \sigma = -\boldsymbol{\sigma}^{\text{fr}} : \nabla \mathbf{v} + \mathbf{j}_S \cdot \nabla D_t \gamma + \mathbf{j}_A \cdot \nabla D_t w^A \quad (4.10)$$

and for variations $\delta \mathbf{v} = \partial_t \boldsymbol{\zeta} + \mathbf{v} \cdot \nabla \boldsymbol{\zeta} - \boldsymbol{\zeta} \cdot \nabla \mathbf{v}$, $\delta \rho_A$, δw^A , δs , $\delta \sigma$, and $\delta \gamma$ subject to the *variational constraint*

$$\frac{\partial \mathcal{L}}{\partial s} \bar{D}_\delta \sigma = -\boldsymbol{\sigma}^{\text{fr}} : \nabla \boldsymbol{\zeta} + \mathbf{j}_S \cdot \nabla D_\delta \gamma + \mathbf{j}_A \cdot \nabla D_\delta w^A \quad (4.11)$$

with $\boldsymbol{\zeta}(t_i) = \delta \gamma(t_i) = \delta w^A(t_i) = 0$, $i = 1, 2$, and with $\boldsymbol{\zeta}|_{\partial \mathcal{D}} = 0$.

In (4.9)–(4.11) we have used the notations $D_t f = \partial_t f + \mathbf{v} \cdot \nabla f$, $\bar{D}_t f = \partial_t f + \text{div}(f \mathbf{v})$, $D_\delta f = \delta f + \boldsymbol{\zeta} \cdot \nabla f$, and $\bar{D}_\delta f = \delta f + \text{div}(f \boldsymbol{\zeta})$ for the Lagrangian time derivatives and variations of functions and densities.

The variational formulation (4.9)–(4.11) yields the system

$$\begin{cases} (\partial_t + \mathcal{L}_{\mathbf{v}}) \frac{\partial \mathcal{L}}{\partial \mathbf{v}} = \rho_A \nabla \frac{\partial \mathcal{L}}{\partial \rho_A} + s \nabla \frac{\partial \mathcal{L}}{\partial s} + \text{div} \boldsymbol{\sigma}^{\text{fr}} \\ \bar{D}_t \rho_A + \text{div} \mathbf{j}_A = 0, \quad A = 1, \dots, P \\ \frac{\partial \mathcal{L}}{\partial s} (\bar{D}_t s + \text{div} \mathbf{j}_s) = -\boldsymbol{\sigma}^{\text{fr}} : \nabla \mathbf{v} - \mathbf{j}_s \cdot \nabla \frac{\partial \mathcal{L}}{\partial s} - \mathbf{j}_A \cdot \nabla \frac{\partial \mathcal{L}}{\partial \rho_A}, \end{cases} \quad (4.12)$$

together with the conditions

$$\bar{D}_t \sigma = \bar{D}_t s + \text{div} \mathbf{j}_s, \quad D_t \gamma = -\frac{\partial \mathcal{L}}{\partial s}, \quad D_t w^A = -\frac{\partial \mathcal{L}}{\partial \rho_A}.$$

In (4.12) $\mathcal{L}_{\mathbf{v}}$ denotes the Lie derivative defined as $\mathcal{L}_{\mathbf{v}} \mathbf{m} = \mathbf{v} \cdot \nabla \mathbf{m} + \nabla \mathbf{v}^T \cdot \mathbf{m} + \mathbf{m} \text{div} \mathbf{v}$. We refer to Gay-Balmaz and Yoshimura [2017b] a detailed derivation of these equations from the variational formulation (4.9)–(4.11).

The multicomponent Navier-Stokes-Fourier equations. For the Lagrangian

$$\ell(\mathbf{v}, s, \rho_1, \dots, \rho_P) = \int_{\mathcal{D}} \left[\frac{1}{2} \rho |\mathbf{v}|^2 - \epsilon(\rho_1, \dots, \rho_P, s) \right] d^3x$$

we get

$$\begin{cases} \rho(\partial_t \mathbf{v} + \mathbf{v} \cdot \nabla \mathbf{v}) = -\nabla p + \operatorname{div} \boldsymbol{\sigma}^{\text{fr}} \\ \bar{D}_t \rho_A + \operatorname{div} \mathbf{j}_A = 0, \quad A = 1, \dots, P \\ T(\bar{D}_t s + \operatorname{div} \mathbf{j}_s) = \boldsymbol{\sigma}^{\text{fr}} : \nabla \mathbf{v} - \mathbf{j}_s \cdot \nabla T - \mathbf{j}_A \cdot \nabla \mu^A \end{cases} \quad (4.13)$$

with $\mu^A = \frac{\partial \epsilon}{\partial \rho_A}$, $T = \frac{\partial \epsilon}{\partial s}$, and $p = \mu^A \rho_A + T s - \epsilon$.

The system of equations (4.13) needs to be supplemented with phenomenological expressions for the *thermodynamic fluxes* $\boldsymbol{\sigma}^{\text{fr}}$, \mathbf{j}_S , \mathbf{j}_A in terms of the *thermodynamic affinities* $\operatorname{Def} \mathbf{v}$, ∇T , $\nabla \mu^A$ compatible with the second law. It is empirically accepted that for a large class of irreversible processes and under a wide range of experimental conditions, the thermodynamic fluxes J_α are linear functions of the thermodynamic affinities X^α , i.e., $J_\alpha = \mathcal{L}_{\alpha\beta} X^\beta$, where the transport coefficients $\mathcal{L}_{\alpha\beta}(\dots)$ are state functions that must be determined by experiments or if possible by kinetic theory. Besides defining a positive quadratic form, the coefficients $\mathcal{L}_{\alpha\beta}(\dots)$ must also satisfy *Onsager's reciprocal relations* (Onsager [1931]) due to the microscopic time reversibility and the *Curie principle* associated to material invariance (see, for instance, de Groot and Mazur [1969], Kondepudi and Prigogine [1998], Landau and Lifshitz [1969], Woods [1975]). In the case of the multicomponent fluid, writing the traceless part of $\boldsymbol{\sigma}^{\text{fr}}$ and $\operatorname{Def} \mathbf{v}$ as $(\boldsymbol{\sigma}^{\text{fr}})^{(0)} = \boldsymbol{\sigma}^{\text{fr}} - \frac{1}{3}(\operatorname{Tr} \boldsymbol{\sigma}^{\text{fr}})\delta$ and $(\operatorname{Def} \mathbf{v})^{(0)} = \operatorname{Def} \mathbf{v} - \frac{1}{3}(\operatorname{div} \mathbf{v})\delta$, we have the following phenomenological linear relations

$$-\begin{bmatrix} \mathbf{j}_S \\ \mathbf{j}_A \end{bmatrix} = \begin{bmatrix} \mathcal{L}_{SS} & \mathcal{L}_{SB} \\ \mathcal{L}_{AS} & \mathcal{L}_{AB} \end{bmatrix} \begin{bmatrix} \nabla T \\ \nabla \mu^B \end{bmatrix}, \quad \frac{1}{3} \operatorname{Tr} \boldsymbol{\sigma}^{\text{fr}} = \zeta \operatorname{div} \mathbf{v}, \quad (\boldsymbol{\sigma}^{\text{fr}})^{(0)} = 2\mu(\operatorname{Def} \mathbf{v})^{(0)},$$

where all the coefficients may depend on $(s, \rho_1, \dots, \rho_P)$. The first linear relation describes the vectorial phenomena of heat conduction (Fourier law), diffusion (Fick law) and their cross effects (Soret and Dufour effects), the second relation describes the scalar processes of bulk viscosity with coefficient $\zeta \geq 0$, and the third relation is the tensorial process of shear viscosity with coefficient $\mu \geq 0$. The associated friction stress reads

$$\boldsymbol{\sigma}^{\text{fr}} = 2\mu \operatorname{Def} \mathbf{v} + \left(\zeta - \frac{2}{3}\mu \right) (\operatorname{div} \mathbf{v})\delta.$$

All these phenomenological considerations take place in the phenomenological constraint (4.10) and the associated variational constraints (4.11), but they are not involved in the variational condition (4.9). Note that our variational formulation holds independently on the linear character of the phenomenological laws.

Remark 4.2. For simplicity, we chose the fluid domain \mathcal{D} as a subset of \mathbb{R}^3 endowed with the Euclidean metric. More generally, the variational formulation can be intrinsically written on Riemannian manifolds, see Gay-Balmaz and Yoshimura [2017b]. Making the dependence of the Riemannian metric explicit, even if it is given by the standard Euclidean metric, is important for the study of the covariance properties, Gay-Balmaz, Marsden, and Ratiu [2012].

5 Concluding remarks

In this paper, we made a survey of our recent developments on the Lagrangian variational formulation for nonequilibrium thermodynamics developed in Gay-Balmaz and Yoshimura

[2017a,b, 2018a], which is a natural extension of Hamilton's principle in mechanics to include irreversible processes.

Before going into details, we made a brief review of Hamilton's principle as it applies to (finite dimensional) discrete systems in classical mechanics as well as to (infinite dimensional) continuum systems. Then, in order to illustrate our variational formulation for nonequilibrium thermodynamics, we first started with the finite dimensional case of adiabatically closed systems together with representative examples such as a piston containing an ideal gas, a system with a chemical species experiencing diffusions between several compartments, an adiabatic piston with two cylinders, and a system with a chemical species experiencing diffusion and heat conduction between two compartments. Then, we extended the variational formulation to open finite dimensional systems that can exchange heat and matter with the exterior. This case was illustrated with the help of a piston device with ports and heat sources. We also demonstrated how chemical reactions can be naturally incorporated into our variational formulation.

Second, we illustrated the variational formulation with the infinite dimensional case of continuum systems by focusing on a compressible fluid with the irreversible processes due to viscosity, heat conduction, and diffusion. The formulation is first given in the Lagrangian (or material) description because it is in this description that the variational formulation is a natural continuum extension of the one for discrete systems. The variational formulation in the Eulerian (or spatial) description is then deduced by Lagrangian reduction and yields the multicomponent Navier-Stokes-Fourier equations.

One of the key issue of our variational formulation is the introduction and the use of the concept of thermodynamic displacement, whose time derivative corresponds to the affinity of the process. The thermodynamic displacement allows to systematically develop the variational constraints associated to the nonlinear phenomenological constraints. The variational formulations presented in this paper use the entropy as an independent variable, but a variational approach based on the temperature can be also developed by considering free energy Lagrangians, see [Gay-Balmaz and Yoshimura \[2018b\]](#).

Further developments. Associated with our variational formulation of nonequilibrium thermodynamics, there are the following interesting and important topics, which we have not described here due to lack of space but are quite relevant with the variational formulation of nonequilibrium thermodynamics, reviewed in this paper.

- **Dirac structures and Dirac systems:** It is well-known that when the Lagrangian is regular, the equations of classical mechanics can be transformed into the setting of Hamiltonian systems. The underlying geometric object for this formulation is the canonical symplectic form on the phase space T^*Q of the configuration manifold. When irreversible processes are included, this geometric formulation is lost because of the degeneracy of the Lagrangians and the presence of the nonlinear nonholonomic constraints. Hence one may ask what is the appropriate geometric object that generalizes the canonical symplectic form in the formulation of thermodynamics. In [Gay-Balmaz and Yoshimura \[2018c,e\]](#) it was shown that the evolution equations for both adiabatically closed and open systems can be geometrically formulated in terms of various classes of Dirac structures induced from the phenomenological constraint and from the canonical symplectic form on T^*Q or on $T^*(Q \times \mathbb{R})$.
- **Reduction by symmetry:** When symmetries are available, reduction processes can be applied to the variational formulation of thermodynamics, thereby extending the process of Lagrangian reduction from classical mechanics to thermodynamics. This has been already illustrated in §4.2 for the Navier-Stokes-Fourier equation, but can be carried out in general for all the variational formulations presented in this paper.

For instance, we refer to Couéraud and Gay-Balmaz [2018] for the case of simple thermodynamic systems on Lie groups with symmetries.

- **Variational discretization:** Associated to the variational formulation in this paper, there exist variational integrators for the nonequilibrium thermodynamics of simple adiabatically closed systems, see Gay-Balmaz and Yoshimura [2018d], Couéraud and Gay-Balmaz [2018]. These integrators are structure preserving numerical schemes that are obtained by a discretization of the variational formulation. The structure preserving property of the flow of such systems is an extension of the symplectic property of the flow of variational integrators for Lagrangian mechanics.
- **Modelling of thermodynamically consistent models:** The variational formulation for thermodynamics can be also used to derive new models, which are automatically thermodynamically consistent. We refer to Gay-Balmaz [2018] for an application of the variational formulation to atmospheric thermodynamics and its pseudoincompressible approximation.

Acknowledgments. F.G.B. is partially supported by the ANR project GEOMFLUID, ANR-14-CE23-0002-01; H.Y. is partially supported by JSPS Grant-in-Aid for Scientific Research (16KT0024, 24224004), the MEXT “Top Global University Project” and Waseda University (SR 2018K-195).

References

- Arnold, V.I., V.V. Kozlov, and A.I. Neishtadt [1988], *Dynamical Systems III*, Springer-Verlag, Encyclopedia of Math., **3**.
- Biot, M. A. [1975], A virtual dissipation principle and Lagrangian equations in non-linear irreversible thermodynamics, *Acad. Roy. Belg. Bull. Cl. Sci.* **5** (61), 6–30.
- Biot, M. A. [1984], New variational-Lagrangian irreversible thermodynamics with application to viscous flow, reaction-diffusion, and solid mechanics. *Adv. Appl. Mech.* **24**, 1–91.
- Bloch, A. M. [2003], *Nonholonomic Mechanics and Control*, volume 24 of *Interdisciplinary Applied Mathematics*, Springer-Verlag, New York. With the collaboration of J. Baillieul, P. Crouch and J. Marsden, and with scientific input from P. S. Krishnaprasad, R. M. Murray and D. Zenkov.
- Callen, H. B. [1985], *Thermodynamics and an Introduction to Thermostatistics*, John Wiley & Sons Inc; 2nd Ed.
- Carathéodory, C. [1909], Untersuchungen über die Grundlagen der Thermodynamik, *Math. Ann.*, **67**, 355–386.
- Cendra, H., A. Ibort, M. de León, and D. Martín de Diego [2004], A generalization of Chetaev’s principle for a class of higher order nonholonomic constraints, *J. Math. Phys.* **45**, 2785.
- Cendra, H., J.E. Marsden, and T.S. Ratiu [2001], *Lagrangian reduction by stages*, *Memoirs of the Amer. Math. Soc.* **152**, Providence, R.I.
- Couéraud B. and F. Gay-Balmaz [2018], Variational discretization of simple thermodynamical systems on Lie groups, *Disc. Cont. Dyn. Syst. Series S.*, **13**(4). <https://arxiv.org/pdf/1806.09897.pdf>

- de Groot, S. R and P. Mazur [1969], *Nonequilibrium Thermodynamics*, North-Holland.
- Eberard, D., B. M. Maschke, and A. J. van der Schaft [2007], An extension of Hamiltonian systems to the thermodynamic phase space: Towards a geometry of nonreversible processes, *Reports on Mathematical Physics* **60**(2), 175–198.
- Edwards, B. J. and A. N. Beris [1991a], Noncanonical Poisson bracket for nonlinear elasticity with extensions to viscoelasticity, *Phys. A: Math. Gen.*, **24**, 2461–2480.
- Edwards, B. J. and A. N. Beris [1991b], Unified view of transport phenomena based on the generalized bracket formulation, *Ind. Eng. Chem. Res.*, **30**, 873–881.
- Eckart, C. [1960], Variation principles of hydrodynamics, *Phys. Fluids*, **3**, 421–427.
- Eldred, C. and F. Gay-Balmaz [2018], Single and double generator bracket formulations of geophysical fluids with irreversible processes. <https://arxiv.org/pdf/1811.11609.pdf>
- Ferrari, C. and C. Gruber [2010], Friction force: from mechanics to thermodynamics, *Eur. J. Phys.* **31**(5), 1159–1175.
- Fukagawa, H. and Y. Fujitani [2012], A variational principle for dissipative fluid dynamics, *Prog. Theor. Phys.* **127**(5), 921–935.
- Gay-Balmaz, F. [2018], A variational derivation of the nonequilibrium thermodynamics of a moist atmosphere with rain process and its pseudoincompressible approximation, *Geophys. Astr. Fluid. Dyn.*, to appear. <https://arxiv.org/pdf/1701.03921.pdf>
- Gay-Balmaz, F., J. E. Marsden, and T. S. Ratiu [2012], Reduced variational formulations in free boundary continuum mechanics, *J. Nonlinear Sci.* **22** 553–597.
- Gay-Balmaz, F. and H. Yoshimura [2015], Dirac reduction for nonholonomic mechanical systems and semidirect products, *Advances in Applied Mathematics*, **63**, 131–213.
- Gay-Balmaz, F. and H. Yoshimura [2017a], A Lagrangian variational formulation for nonequilibrium thermodynamics. Part I: Discrete systems, *J. Geom. Phys.*, **111**, 169–193.
- Gay-Balmaz, F. and H. Yoshimura [2017b], A Lagrangian variational formulation for nonequilibrium thermodynamics. Part II: Continuum systems, *J. Geom. Phys.*, **111**, 194–212.
- Gay-Balmaz, F. and H. Yoshimura [2018a], A variational formulation of nonequilibrium thermodynamics for discrete open systems with mass and heat transfer, *Entropy*, **20**(3), 163.
- Gay-Balmaz, F. and H. Yoshimura [2018b], A free energy Lagrangian variational formulation of the Navier-Stokes-Fourier system, *Int. J. Geom. Methods Mod. Phys.*, **16**, to appear. <https://arxiv.org/pdf/1706.09010.pdf>
- Gay-Balmaz, F. and H. Yoshimura [2018c], Dirac structures in nonequilibrium thermodynamics, *J. Math. Phys.*, **59**, 012701.
- Gay-Balmaz, F. and H. Yoshimura [2018d], Variational discretization for the nonequilibrium thermodynamics of simple systems, *Nonlinearity*, **31**(4), 1673.
- Gay-Balmaz, F. and H. Yoshimura [2018e], Dirac structures in nonequilibrium thermodynamics for open systems, preprint.

- Gibbs, J. W. [1873a], Graphical methods in the thermodynamics of fluids, *Trans. Connecticut Acad.* **2**, 309–342.
- Gibbs, J. W. [1873b], A method of geometrical representation of the thermodynamic properties of substances by means of surfaces, *Trans. Connecticut Acad.* **2**, 382–404.
- Gibbs, J. W. [1902], *Collected Works*, Scribner, New-York.
- Glandsdorff, P. and I. Prigogine [1971], *Thermodynamic Theory of Structure, Stability, and Fluctuations*, Wiley-Interscience.
- Green, A. E. and P. M. Naghdi, A re-examination of the basic postulates of thermomechanics, *Proc. R. Soc. London. Series A: Mathematical, Physical and Engineering Sciences*, **432**, 171–194.
- Grmela, M. [1984], Bracket formulation of dissipative fluid mechanics equations, *Phys. Lett. A*, **102**, 355–358.
- Grmela, M. and H.-C. Öttinger [1997], Dynamics and thermodynamics of complex fluids. I. Development of a general formalism, *Phys. Rev. E*, **56**, 6620–6632.
- Gruber, C. [1999], Thermodynamics of systems with internal adiabatic constraints: time evolution of the adiabatic piston, *Eur. J. Phys.* **20**, 259–266.
- Gruber, C. and S. D. Brechet [2011], Lagrange equation coupled to a thermal equation: mechanics as a consequence of thermodynamics, *Entropy* **13**, 367–378.
- Gyarmati, I. [1970], *Nonequilibrium Thermodynamics: Field Theory and Variational Principles*, Springer-Verlag, New York.
- Herivel, J. W. [1955], The derivation of the equations of motion of an ideal fluid by Hamilton's principle, *Proc. Cambridge Philos. Soc.* **51**, 344–349.
- Hermann, R. [1973], *Geometry, physics and systems*, Dekker, New York.
- Holm, D. D., J. E. Marsden and T. S. Ratiu [1998], The Euler-Poincaré equations and semidirect products with applications to continuum theories, *Adv. in Math.*, **137**, 1–8.
- Ichiyangi M. [1994], Variational principles in irreversible processes, *Phys. Rep.* **243**, 125–182.
- Jacobs, H. and H. Yoshimura [2014], Tensor products of Dirac structures and interconnection in Lagrangian mechanics, *J. Geom. Mech.* **6**(1), 67–98.
- Kaufman, A. [1984], Dissipative Hamiltonian systems: A unifying principle, *Phys. Lett. A*, **100**, 419–422.
- Kedem O. and A. Katchalsky [1963], Permeability of composite membranes. Part 1. Electric current, volume flow and flow of solute through membranes, *Transactions of the Faraday Society*, **59**, 1918–1930.
- Kedem O. and A. Katchalsky [1963], Permeability of composite membranes. Part 2. Parallel elements, *Transactions of the Faraday Society*, **59**, 1931–1940.
- Kedem O. and A. Katchalsky [1963], Permeability of composite membranes. Part 3. Series array of elements, *Transactions of the Faraday Society*, **59**, 1941–1953.
- Klein, S., and G. Nellis [2011], *Thermodynamics*, Cambridge University Press.

- Kondepudi, D. and I. Prigogine [1998], *Modern Thermodynamics*, John Wiley & Sons.
- Landau, L.D. and E. M. Lifshitz [1969], *Mechanics*, Volume 1 of A Course of Theoretical Physics, Pergamon Press.
- Landau, L. D. and E. M. Lifshitz [1969], *Statistical Physics*, Volume 5 of A Course of Theoretical Physics, Pergamon Press.
- Landau, L. D. and E. M. Lifshitz [1969], *Fluid Mechanics*, Volume 6 of A Course of Theoretical Physics, Pergamon Press.
- Lavenda, B. H. [1978], *Thermodynamics of Irreversible Processes*, Macmillan, London.
- Lewis, A. and R. M. Murray [1995], Variational principles in constrained systems: theory and experiments, *Int. J. Nonlinear Mech.* **30**, 793–815.
- Onsager, L. and S. Machlup [1953], Fluctuations and irreversible processes II. Systems with kinetic energy. *Phys. Rev.* **91**, 1512–1515.
- Marle, C.-M. [1998], Various approaches to conservative and nonconservative non-holonomic systems, *Rep. Math. Phys.* **42**, 1/2, 211–229.
- Marsden, J. E. and T. J. R. Hughes [1983], *Mathematical Foundations of Elasticity*, Prentice Hall, New York.
- Marsden, J. E. and T. S. Ratiu [1999], *Introduction to Mechanics and Symmetry*, Springer-Verlag, Texts in Applied Mathematics, **17**; Second Edition.
- Marsden, J. E. and J. Scheurle [1993a], Lagrangian reduction and the double spherical pendulum, *ZAMP*, **44**, 17–43.
- Marsden, J. E. and J. Scheurle [1993b], The reduced Euler–Lagrange equations, *Fields Inst. Commun.*, **1**, 139–164.
- Morrison, P. [1984], Bracket formulation for irreversible classical fields, *Phys. Lett. A*, **100**, 423–427.
- Morrison, P. [1986], A paradigm for joined Hamiltonian and dissipative systems, *Physica D*, **18**, 410–419.
- Mrugala, R. [1978], Geometrical formulation of equilibrium phenomenological thermodynamics, *Rep. Math. Phys.* **14**, 419–427.
- Mrugala, R. [1980], A new representation of Thermodynamic Phase Space, *Bull. Polish Acad. Sci.* **28**, 13–18.
- Mrugala, R., J. D. Nulton, J. C. Schon, and P. Salamon [1991], Contact structure in thermodynamic theory, *Rep. Math. Phys.* **29**, 109–121.
- Neimark, Ju.I and N.I. Fufaev [1972], *Dynamics of Nonholonomic Systems*, Volume 33 of Translations of mathematical monographs, Amer. Math. Society: Providence, RI, USA.
- Onsager, L. [1931], Reciprocal relations in irreversible processes I, *Phys. Rev.* **37**, 405–426; Reciprocal relations in irreversible processes II, *Phys. Rev.* **38**, 2265–2279.
- Onsager, L. and S. Machlup [1953], Fluctuations and irreversible processes, *Phys. Rev.* **91**, 1505–1512.

- Oster, G. F., A. S. Perelson, A. Katchalsky [1973], Network thermodynamics: dynamic modelling of biophysical systems, *Quarterly Reviews of Biophysics*, **6**(1), 1–134.
- Öttinger, H. C. and M. Grmela [1997], Dynamics and thermodynamics of complex fluids. II. Illustrations of a general formalism, *Phys. Rev. E*, **56**, 6633–6655.
- Poincaré, H. [1901], Sur une forme nouvelle des équations de la mécanique, *C.R. Acad. Sci.* **132**, 369–371.
- Prigogine [1947], *Etude thermodynamique des phénomènes irréversibles*, Thesis, Paris: Dunod and Liège: Desoer.
- Sandler, S. I. [2006], *Chemical, Biochemical, and Engineering Thermodynamics*, John Wiley & Sons.
- Serrin, J. [1959], Mathematical principles of classical fluid mechanics, *Handbuch der Physik VIII-I*, 125–263, Berlin, Springer-Verlag.
- Simo, J. C., J. E. Marsden, and P. S. Krishnaprasad [1988], The Hamiltonian structure of nonlinear elasticity: The material, spatial and convective representations of solids, rods and plates, *Arch. Ration. Mech. Anal.* **104**, 125–183.
- Stueckelberg, E. C. G. and P. B. Scheurer [1974], *Thermocinétique phénoménologique galiléenne*, Birkhäuser.
- Truesdell, C. and R. Toupin [1960], The classical field theories, *Handbuch der Physik III-I*, 226–790, Berlin, Springer-Verlag.
- von Helmholtz, H., Studien zur Statik monocyclischer Systeme [1884], *Sitzungsberichte der Königlich Preussischen Akademie der Wissenschaften zu Berlin*, 159–177.
- Woods, L. C. [1975], *The Thermodynamics of Fluid Systems*, Clarendon Press Oxford.
- Ziegler, H. [1968], A possible generalization of Onsager's theory, in H. Barkus and L. I. Sedov (eds.), *Irreversible Aspects of Continuum Mechanics*, Springer, New York.