

Magnetic Quivers, Higgs Branches, and 6d $\mathcal{N} = (1, 0)$ Theories

Santiago Cabrera¹, Amihay Hanany¹, and Marcus Sperling²

¹*Theoretical Physics Group, Imperial College London
Prince Consort Road, London, SW7 2AZ, UK
Email: santiago.cabrera13@imperial.ac.uk,
a.hanany@imperial.ac.uk*

²*Yau Mathematical Sciences Center, Tsinghua University
Haidian District, Beijing, 100084, China
Email: marcus.sperling@univie.ac.at*

Abstract

The physics of M5 branes placed near an M9 plane on an A -type ALE singularity exhibits a variety of phenomena that introduce additional massless degrees of freedom. There are tensionless strings whenever two M5 branes coincide or whenever an M5 brane approaches the M9 plane. These systems do not admit a low-energy Lagrangian description so new techniques are desirable to shed light on the physics of these phenomena. The 6-dimensional $\mathcal{N} = (1, 0)$ world-volume theory on the M5 branes is composed of massless vector, tensor, and hyper multiplets, and has two branches of the vacuum moduli space where either the scalar fields in the tensor or hyper multiplets receive vacuum expectation values. Focusing on the Higgs branch of the low-energy theory, previous works suggest the conjecture that a new Higgs branch arises whenever a BPS-string becomes tensionless. Consequently, a single theory admits a multitude of Higgs branches depending on the types of tensionless strings in the spectrum. The two main phenomena *discrete gauging* and *small E_8 instanton transition* can be treated in a concise and effective manner by means of Coulomb branches of 3-dimensional $\mathcal{N} = 4$ gauge theories. In this paper, a formalism is introduced that allows to derive a novel object from a brane configuration, called the *magnetic quiver*. The main features are as follows: (i) the 3d Coulomb branch of the magnetic quiver yields the Higgs branch of the 6d system, (ii) all discrete gauging and E_8 instanton transitions have an explicit brane realisation, and (iii) exceptional symmetries arise directly from brane configurations. The formalism facilitates the description of Higgs branches at finite and infinite gauge coupling as spaces of dressed monopole operators.

Contents

1	Introduction	2
2	Magnetic quivers	4
2.1	Set-up	4
2.2	Electric and magnetic quiver	5
2.3	Discrete gauging: M5 branes on A-type singularity	6
2.4	Small E_8 instanton transition: M5 branes near M9 plane	9
2.5	Derivation rules	12
2.6	Phases and their geometry	13
3	Multiple M5 branes near an M9 plane on A_{k-1} singularity	14
3.1	Embedding of \mathbb{Z}_k into E_8	14
3.2	Case $k = 1$	15
3.3	Case $k = 2$	15
3.3.1	Symmetry $SU(2) \times E_8$ — case $m_1 = 2$	15
3.3.2	Symmetry $SU(2) \times (E_7 \times U(1))$ — case $m_2 = 1$	16
3.3.3	Symmetry $SU(2) \times SO(16)$ — case $m'_2 = 1$	17
3.4	Case $k = 3$	18
3.4.1	Symmetry $SU(3) \times E_8$ — case $m_1 = 3$	18
3.4.2	Symmetry $SU(3) \times (U(1) \times E_7)$ — case $m_1 = m_2 = 1$	19
3.4.3	Symmetry $SU(3) \times (SU(3) \times E_6)$ — case $m_3 = 1$	19
3.4.4	Symmetry $SU(3) \times (U(1) \times SO(14))$ — case $m_1 = m'_2 = 1$	20
3.4.5	Symmetry $SU(3) \times SU(9)$ — case $m'_3 = 1$	21
3.5	Case $k = 4$	22
3.5.1	Symmetry $SU(4) \times E_8$ — case $m_1 = 4$	22
3.5.2	Symmetry $SU(4) \times (U(1) \times E_7)$ — case $m_1 = 2, m_2 = 1$	23
3.5.3	Symmetry $SU(4) \times (U(1) \times SO(14))$ — case $m_1 = 2, m'_2 = 1$	24
3.5.4	Symmetry $SU(4) \times (U(1) \times SU(2) \times SO(12))$ — case $m_2 = m'_2 = 1$	25
3.5.5	Symmetry $SU(4) \times (SU(2) \times E_7)$ — case $m_2 = 2$	26
3.5.6	Symmetry $SU(4) \times SO(16)$ — case $m'_2 = 2$	26
3.5.7	Symmetry $SU(4) \times (U(1) \times SU(2) \times E_6)$ — case $m_1 = m_3 = 1$	27
3.5.8	Symmetry $SU(4) \times (U(1) \times SU(8))$ — case $m_1 = m'_3 = 1$	28
3.5.9	Symmetry $SU(4) \times (SU(4) \times SO(10))$ — case $m_4 = 1$	29
3.5.10	Symmetry $SU(4) \times (SU(8) \times SU(2))$ — case $m'_4 = 1$	29
3.6	General case	30
3.6.1	$m'_4 \geq m'_3, m'_4 \pm m'_3 = \text{even}$	32
3.6.2	$m'_4 \geq m'_3, m'_4 \pm m'_3 = \text{odd}$	34
3.6.3	$m'_3 \geq m'_4, m'_3 - m'_4 \leq 2m'_2, m'_3 \pm m'_4 = \text{even}$	35
3.6.4	$m'_3 \geq m'_4, m'_3 - m'_4 \leq 2m'_2, m'_3 \pm m'_4 = \text{odd}$	36
3.6.5	$m'_3 \geq m'_4, m'_3 - m'_4 \geq 2m'_2$	37
3.7	Observations	40
3.7.1	6d Theta angle	40
3.7.2	Comments	41
3.8	From finite coupling to infinite coupling	42

4 Conclusion	42
A Symmetries	45
A.1 6d Higgs branches	45
A.2 3d Coulomb branches	45

1 Introduction

The world-volume theories of M5 branes have led to interesting 6-dimensional theories. A stack of coincident M5 branes gives rise to world-volume theories with $\mathcal{N} = (2, 0)$ supersymmetry, which more generally admit an ADE classification [1, 2]. A larger class of 6-dimensional supersymmetric theories has $\mathcal{N} = (1, 0)$ and their anomalies have been studied in works like [3–5]. An example are the Type IIA constructions with D6-D8-NS5 branes of [6–8]. These brane constructions hinted at the existence of non-trivial conformal fixed-points at the origin of the tensor branch, i.e. when all NS5 branes coincide. Subsequently, a classification of 6-dimensional superconformal field theories has been proposed in [9, 10]. Although these are local quantum field theories, no Lagrangian description is known and tensionless strings contribute to the low-energy degrees of freedom.

The degrees of freedom of 6-dimensional $\mathcal{N} = (1, 0)$ supersymmetric theory are given by vector multiplets, hypermultiplets, and tensor multiplets as well as other massless degrees of freedom which arise due to tensionless strings [11]. Among others, the gravitational anomaly cancellation [12] for such a theory requires [13, 14]

$$\#\{\text{hypers}\} + 29\#\{\text{tensors}\} - \#\{\text{vectors}\} = \text{constant} . \tag{1.1}$$

In 6d theories the gauge coupling is a dynamical object as it is inversely related to a scalar field of a tensor multiplet which simultaneously serves as tension of a BPS string. At a generic point of the tensor branch, the 6d $\mathcal{N} = (1, 0)$ theory may admit a low-energy effective description as all gauge couplings are finite. The corresponding Higgs branch at finite coupling is understood as a hyper-Kähler quotient due to the amount of supersymmetry [15]. At non-generic points of the tensor branch, the 6-dimensional theory is generically strongly coupled and a description of the corresponding Higgs branch is not straightforward. Since some BPS strings become tensionless whenever a gauge coupling is tuned to infinity, new massless degrees of freedom are expected to contribute to the Higgs branch such that it is still a hyper-Kähler space of larger dimension, but not a hyper-Kähler quotient any more. Since these theories are non-Lagrangian, an alternative approach is desirable to investigate Higgs branches at infinite coupling. Fortunately, another physical construction of hyper-Kähler singularities is known: the Coulomb branch of a 3-dimensional $\mathcal{N} = 4$ gauge theory. In fact, Coulomb branches have already been utilised to describe Higgs branches of 4-dimensional Argyres-Douglas theories [16], 5-dimensional gauge theories [17–19], and 6-dimensional gauge theories [20–22] at infinite coupling.

The focus of this paper lies on a particular class of 6d $\mathcal{N} = (1, 0)$ supersymmetric gauge theories obtained from the world-volume theories of multiple M5 branes near an M9 plane on an A -type ALE singularity. This class has already been studied in some detail. As discussed in [11], a system of multiple M5 branes on an ALE singularity \mathbb{C}^2/Γ , where $\Gamma \subset \text{SU}(2)$ is a (discrete) ADE subgroup, undergoes a phase transition at the fixed point of the ALE space with new massless tensor multiplets appearing for D and E -type, but not for A -type singularities. The jumps in Higgs branch dimension at a generic point and the origin of the tensor branch for these theories has been computed in [23]. The inclusion of the end-of-the-world M9 plane with its global E_8 symmetry leads to the possibility of the small E_8 instanton transition [24], see also [6, 25–27]. In particular, the Higgs branches exhibit an intimate relationship with the E_8 instanton moduli space on the A -type ALE space [20], see also [10, 11, 28–30].

The common feature of all the phenomena is the appearance of tensionless strings. Previous works indicate the following conjecture:

Conjecture 1. *Whenever a BPS-string becomes tensionless there is a singularity on the tensor branch and the associated massless degrees of freedom give rise to a new, finitely generated Higgs branch.*

The multitude of Higgs branches can be understood as *phases* \mathcal{P}_i of the theory in the sense that the inverse gauge couplings and, hence, the scalar fields in the tensor multiplets serve as order parameters. Whenever at least one order parameter approaches zero, the Higgs branch changes discontinuously either due to a gauging of a discrete group or due to a jump in dimension induced by the small E_8 instanton transition¹.

Here for a given phase \mathcal{P}_i of the 6d $\mathcal{N} = (1, 0)$ theory, the emphasis lies on a systematic derivation of an associated *magnetic quiver* $\mathcal{Q}(\mathcal{P}_i)$ such that their data considered as 3d $\mathcal{N} = 4$ Coulomb branch does correctly describe the 6d $\mathcal{N} = (1, 0)$ Higgs branch at the point \mathcal{P}_i of the tensor branch, i.e.

$$\mathcal{H}^{6d}(\text{phase } \mathcal{P}_i) = \mathcal{C}^{3d}(\text{magnetic quiver } \mathcal{Q}(\mathcal{P}_i)). \quad (1.2)$$

Since there are no gauge degrees of freedom on the M5 brane there is the challenge to read off the low-energy gauge dynamics. It is useful to consider the dual Type IIA or Type I' description [6, 7] such that 6d $\mathcal{N} = (1, 0)$ gauge dynamics can be deduced from the brane system involving D6, D8 and NS5 branes, possibly in the presence of orientifolds. The latter is known to be T-dual to the Type IIB construction [31] of 3d $\mathcal{N} = 4$ theories via D3-D5-NS5 brane configurations.

The key tool to establish the objective (1.2) is to find a generalisation of the *electric* and *magnetic* theories within the Type IIB D3-D5-NS5 brane configurations of 3d $\mathcal{N} = 4$ theories. The derivation of the *magnetic quiver* for the different phases of the 6d theory can be summarised in the following two steps:

- (i) Change to the phase of the D6-D8-NS5 brane system where all D6s are suspended between D8 branes. This is analogous to the magnetic phase in D3-D5-NS5 brane system, where the D3 branes are in between D5 branes and the D1 branes are the *fundamental objects*.
- (ii) Deduce the *magnetic quiver* from this phase of the brane system by suspending D4 branes, which are the higher-dimensional analogous of the D-string.

As a consequence, this procedure establishes a *description of 6d $\mathcal{N} = (1, 0)$ Higgs branches as space of dressed monopole operators* as originally proposed in 3d $\mathcal{N} = 4$ Coulomb branch set-up [32]. The analysis of the phases as well as the transitions between the different phases requires many of the 3d Coulomb branch techniques that have been developed recently. Starting from the realisation of the Coulomb branch as a space of dressed monopole operators and its description via the *Hilbert series* [32], useful techniques include: Kraft-Procesi transitions and transverse slices [21, 33, 34], quiver subtraction [35], and discrete quotients [22, 36, 37].

It is worth pointing out that the Hilbert series is not an invariant quantity of the theory, in the sense that it varies between finite and infinite gauge coupling. In other words, the (Higgs branch) Hilbert series is not constant along the tensor branch. However, precisely this fact allows to utilise the Hilbert series as a tool to analyse the Higgs branch of vacuum moduli spaces as they vary along the tensor branch, see Conjecture 1. This has to be contrasted with quantities which are invariant under the choice of vacuum, i.e. constant along the tensor branch, because these would be insensitive to the different phases of the Higgs branch.

The outline of the remainder is as follows: After introducing the set-up, the concept of *electric and magnetic quiver* is explained in Section 2 alongside with two paramount examples. Thereafter,

¹More phenomena show up in cases where the ALE singularity is not of A -type.

M-theory	x^0	x^1	x^2	x^3	x^4	x^5	x^6	x^7	x^8	x^9	x^{10}
M5	×	×	×	×	×	×					
M9	×	×	×	×	×	×		×	×	×	×
$\mathbb{C}^2/\mathbb{Z}_k$	×	×	×	×	×	×	×				
Type IIA	x^0	x^1	x^2	x^3	x^4	x^5	x^6	x^7	x^8	x^9	
NS5	×	×	×	×	×	×					
O8 ⁻ , D8	×	×	×	×	×	×		×	×	×	
D6	×	×	×	×	×	×	×				
F1	×			×							
D4	×			×	×	×		×			

Table 1: Upper part: Occupation of space-time directions by M5, M9, and A_{k-1} singularity in M-theory. Lower part: Occupation of space-time directions by NS5, O8⁻, D8, and D6 in Type IIA. The fundamental string F1 and the D4 branes are virtual objects which are used to read off the electric and magnetic quivers.

in Section 3 the embedding of $\mathbb{Z}_k \hookrightarrow E_8$ is recalled and the cases of multiple M5 branes near an M9 plane on a $\mathbb{C}^2/\mathbb{Z}_k$ singularity are elaborated on for $k = 1, 2, 3, 4$. The general case is presented in Section 3.6. An observation regarding the discrete 6d Theta-angle is discussed in Section 3.7. A conclusion and outlook is provided in Section 4. Moreover, Appendix A provides details of background material.

2 Magnetic quivers

2.1 Set-up

Consider M5 branes and an M9 plane as well as an A_{k-1} ALE singularity stretching the space-time dimensions as indicated in Table 1. The singularity at the origin of $\mathbb{C}^2/\mathbb{Z}_k$ is localized in directions x^7, x^8, x^9 , and x^{10} , and spans directions x^0, x^1, \dots, x^6 . Therefore, it is represented as a horizontal line that ends on M9 in the diagram below. The M-theory picture can be presented as

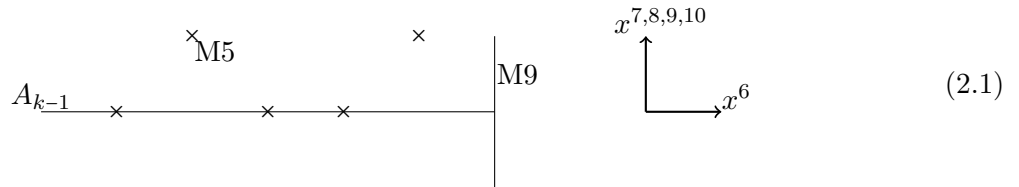

The corresponding description in Type IIA is obtained by an identification as follows: the NS5 originates from the M5 which is point-like in the x^{10} direction. The E_8 end-of-the-world 9-plane M9 gives rise to an O8⁻ orientifold together with 8 D8s on top of it. Lastly, the A_{k-1} ALE space $\mathbb{C}^2/\mathbb{Z}_k$ in M-theory provides a local description of k coincident D6 branes in Type IIA on flat space. In particular, the directions x^7, x^8, \dots, x^{10} in which the singular origin of the ALE singularity is localised become in the three directions transverse to the D6s and the direction of the M-theory circle. The corresponding Type IIA diagram is:

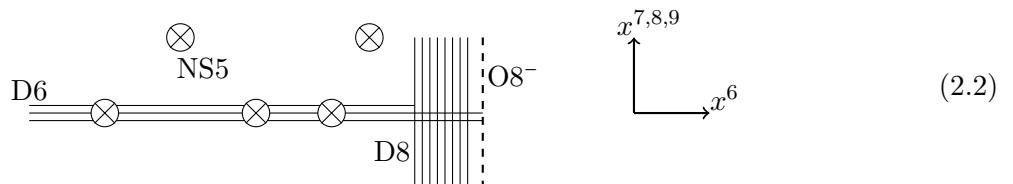

Type IIB	x^0	x^1	x^2	x^3	x^4	x^5	x^6	x^7	x^8	x^9
NS5	×	×	×	×	×	×				
D5	×	×	×					×	×	×
D3	×	×	×				×			
F1	×			×						
D1	×							×		

Table 2: Occupation of space-time directions by NS5, D5, and D3 in Type IIB. The fundamental string F1 induces the electric theory, while the D-string D1 induces the magnetic theory.

Note that the D6 branes have been assigned different boundary conditions along the x^6 direction. This is an essential part of our analysis and will be developed in full detail in Section 3.

As an aside, some theories considered in later sections can admit D6, D8, and NS5 branes and additionally include $O8^*$ planes, which occupy the same space-time dimensions as the $O8^-$.

2.2 Electric and magnetic quiver

As a detour, consider the D3-D5-NS5 brane configurations of [31] as summarised in Table 2. A D3 brane suspended between two NS5s gives rise to an electric gauge group with a vector multiplet, whose gauge coupling is inversely proportional to the distance between the NS5s; while a D3 between D5 branes leads to an electric hypermultiplet. Consequently, the electric quiver gauge theory for the low-energy effective theory on the D3 world-volume is read off from the phase of the brane system in which all D3s are suspended between NS5 branes. In particular, the way fundamental strings can end on the branes gives rise to the low-energy degrees of freedom. On the other hand, the magnetic theory can be considered equally well: here, the D3s between two D5 branes give rise to a magnetic gauge group with twisted vector multiplet [38], whose gauge coupling is inversely proportional to the distance between the D5s. The magnetic hypermultiplet or twisted hypermultiplet [38] originates from D3 branes in between NS5 branes. Taking this a step further, one can apply S-duality such that D5 and NS5 branes are interchanged, while the D3 branes are invariant. Notably, the fundamental string is exchanged with the D-string, which is the fundamental object at large string coupling. Therefore, the degrees of freedom encoded on the magnetic quiver gauge theory are due to the way D1 branes stretch between D3 and NS5 branes.

Returning to 6-dimensional theories and D6-D8-NS5 brane configurations of [6], one notices that these are obtained from the D3-D5-NS5 configuration by three T-dualities along x^3 , x^4 , and x^5 . In the following, two phases of the Type IIA brane setting are important. Firstly, consider the phase in which all D6s are suspended between NS5s. Then the conventional 6-dimensional low-energy effective field theory description is read off from fundamental strings stretching between D6s. The resulting theory can be expressed as a 6-dimensional quiver gauge theory which is denoted as *electric quiver* in what follows. Secondly, consider the phase in which all D6s are suspended between D8s and the NS5s are moved away from the D6s. In this phase one may suspend D4 branes between the D6s as well as between D6s and NS5s or NS5s and NS5s. The D4 suspension pattern is conveniently summarised in a quiver graph which one may call *magnetic quiver*. The reason that D4 branes arise can be seen by following the T-dualities from the corresponding phase in the D3-D5-NS5 configuration where D1 branes give rise to the magnetic quiver gauge theory. Thus, applying T-dualities along x^3 , x^4 , and x^5 to D1 branes naturally results in D4 branes. Nevertheless, a crucial difference arises in 6d: since the NS5 branes and the suspended D6 branes share the same world-volume, the NS5s do contribute to the dynamics. Hence, lead to gauge nodes in the magnetic quiver as opposed to flavour nodes.

The main point of this paper is to argue that by taking the magnetic quiver data as input for the 3-dimensional $\mathcal{N} = 4$ Coulomb branch description in terms of dressed monopole operators one can capture all phases of the 6-dimensional Higgs branches in a systematic and concise fashion. Therefore, it is imperative to distinguish the moduli spaces associated with the two kinds of quivers: the electric quiver data serves as definition of a low-energy effective 6d $\mathcal{N} = (1, 0)$ theory and, in particular, its classical Higgs branch; whereas the magnetic quiver data defines a Coulomb branch of a 3d $\mathcal{N} = 4$ gauge theory describing the Higgs branch of the strongly coupled 6d $\mathcal{N} = (1, 0)$ theory. Both moduli spaces are hyper-Kähler singularities (symplectic singularities, see [39]) with certain symmetries, as recalled in Appendix A.

Before considering the M5 branes near the end-of-the world M9 plane on an A_{k-1} singularity, it is instructive to understand the two extreme cases: M5 branes on a A_{k-1} singularity and M5 branes near an M9 plane.

Notation. In order to distinguish the electric from the magnetic quiver, the following conventions are used: gauge nodes in the electric quiver are denoted explicitly by the gauge groups; whereas gauge nodes in the magnetic quiver are only labelled by the ranks r_i of unitary gauge nodes $U(r_i)$.

2.3 Discrete gauging: M5 branes on A-type singularity

A system of multiple M5 branes and an A_{k-1} singularity can exhibit many phases

$$\begin{array}{c}
 \times \text{M5} \qquad \qquad \times \\
 \times \qquad \qquad \times \qquad \times \\
 A_{k-1} \times \text{---} \times \text{---} \times \text{---} \times
 \end{array}
 \begin{array}{c}
 x^{7,8,9,10} \\
 \uparrow \\
 \times^6
 \end{array}
 \tag{2.3}$$

depending on whether the M5s are on the singularity or away from it. Restricting to the phase where all M5s are on the singularity (i.e. they are at the origin of coordinates x^7, x^8, x^9 and x^{10}), there exist multiple phases describing the positions of the M5 along the x^6 direction. In other words, if the M5s are separated or some of them coincide.

Consider n M5 branes on an A_{k-1} singularity, in the phase where all M5 are located at the singularity, but are separated along the x^6 direction:

$$\begin{array}{c}
 A_{k-1} \times \text{---} \times \text{---} \dots \text{---} \times \text{---} \times \\
 \underbrace{\hspace{10em}}_{n \text{ M5}}
 \end{array}
 \begin{array}{c}
 x^{7,8,9,10} \\
 \uparrow \\
 \times^6
 \end{array}
 \tag{2.4}$$

The Type IIA description yields the following:

$$\begin{array}{c}
 \text{---} \times \text{---} \times \text{---} \times \text{---} \dots \text{---} \times \text{---} \times \text{---} \\
 \text{D6} \quad \underbrace{\hspace{10em}}_{n \text{ NS5}} \\
 \text{k} \quad \text{k} \quad \text{k} \quad \dots \quad \text{k} \quad \text{k}
 \end{array}
 \begin{array}{c}
 x^{7,8,9} \\
 \uparrow \\
 \times^6
 \end{array}
 \tag{2.5}$$

where the k indicates that there are k D6 branes stacked together. The *electric quiver* is read off

from this brane system to be

(2.6)

Note in particular, that the quiver describes a 6d $\mathcal{N} = (1,0)$ low energy effective field theory in which all gauge and flavour nodes denote $SU(k)$ groups.

One may move to a different phase of the brane system by, firstly, pulling in D8 branes from infinity and, secondly, rearranging the brane system such that all D6 branes are suspended between D8 branes. As a result, one obtains

(2.7)

As aforementioned, one may now consider the possibility to suspend D4 branes between the D6 and the NS5 branes. In an interval between two D8s with m D6s in between, the different ways to connect D4 branes between the D6s naturally furnishes the adjoint representation of $U(m)$. This is analogous to Chan-Paton factors of an open string ending on D-branes. Hence, this is a $\frac{1}{4}$ BPS configuration which induces a magnetic vector multiplet. Likewise, the D4 branes stretching between two adjacent intervals with m and l D6 branes furnish the bifundamental representation of $U(m) \times U(l)$ such that this $\frac{1}{4}$ BPS system contributes a bifundamental magnetic hypermultiplet.

For lower dimensional settings, like in Table 2, this would be the end of the discussion, but here there are further possibilities. Recall that both the NS5 and the suspended D6 branes have 6-dimensional world volumes; hence, the NS5s contribute to the dynamics too. More concretely, one may also stretch D4 branes between NS5 branes. Since the NS5 branes are not subject to boundary conditions on any other brane, they are $\frac{1}{2}$ BPS and as such contribute a magnetic vector multiple together with an adjoint magnetic hypermultiplet. If there are multiple NS5s in the same interval, but they are separated in x^6 direction then the D4 stretched between the NS5 branes does not contribute massless degrees of freedom. In that case, each NS5 contributes with a single $U(1)$ gauge node and the corresponding adjoint hypermultiplet. Furthermore, a D4 stretched between a NS5 and a D6 can only contribute massless degrees of freedom if they are in the same interval. consequently, a single NS5 and stack of m D6 give rise to a bifundamental of $U(m) \times U(1)$. Following these observations results in the *magnetic quiver* of the form

(2.8)

Note that there is a bouquet of n separate $U(1)$ nodes at the top, which results from the n separated NS5 branes². If the data underlying the *magnetic quiver* is understood as defining a 3d $\mathcal{N} = 4$ quiver

²Since the attention is directed towards the Coulomb branch, the neutral adjoint hypermultiplet from any single NS5 brane is neglected.

gauge theory, then the significance of this construction is

$$\mathcal{H}^{6d}(\text{electric quiver (2.6)}) = \mathcal{C}^{3d}(\text{magnetic quiver (2.8)}) , \quad (2.9)$$

as equality of moduli spaces. For consistency one may verify that the symmetries and dimensions agree, see Appendix A; indeed, one finds

$$G_F = \text{SU}(k)^2 \times \text{U}(1)^n = G_J \quad \text{and} \quad \dim \mathcal{H}^{6d} = k^2 + n - 1 = \dim \mathcal{C}^{3d} . \quad (2.10)$$

In fact, the equality (2.9) has been shown to arise in two steps in [22]: firstly, S-duality or 3d mirror symmetry for the quiver (2.6) where all special unitary nodes are replaced by unitary nodes. Secondly, employing the concept of *implosion* [40] on the 3d mirror to arrive at the magnetic quiver (2.8).

As discussed in [22,36,37], the 6d Higgs branch exhibits many more phases. The phases originate when some M5 branes become coincident along the x^6 direction. Clearly, there exists no 6d low-energy effective quiver description as the distance between two neighbouring NS5 branes determines the inverse gauge coupling of the corresponding gauge group. Therefore, there exists no *electric quiver* for any of these strongly coupled phases. In contrast, the magnetic phase can be readily applied to this setting. Suppose that from the n M5 branes n_i ($i = 1, \dots, l$ such that $\sum_{i=1}^l n_i = n$) of these coincide at x_i^6 , then the corresponding brane picture becomes

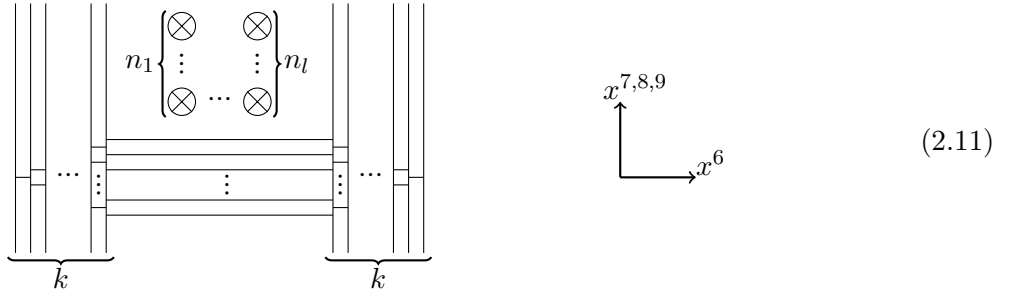

To determine the magnetic quiver for this brane system, one has to apply the above considerations to D4 branes stretched between coincident NS5 branes. Since a stack of m coincident NS5 branes is a $\frac{1}{2}$ BPS configuration, there are two contributions: firstly, a magnetic vector multiplet for a $\text{U}(m)$ gauge node; secondly, a magnetic hypermultiplet in the adjoint representation of $\text{U}(m)$, which is denoted by a loop attached to the gauge node. From the brane configuration, the magnetic vector multiplet is associated with the motion in x^7, x^8, x^9 direction, while motions in x^6 direction give rise to the additional magnetic hypermultiplet. In other words, from the 3d $\mathcal{N} = 4$ perspective each stack of n_i NS5 branes contributes an $\text{U}(n_i)$ together with an adjoint-valued hyper multiplet. Equipped with these rules, the magnetic quiver associated to the brane configuration (2.11) is read off to be

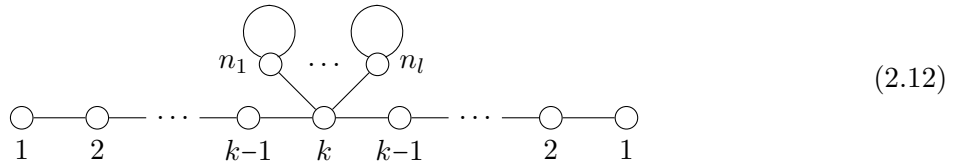

Some comments are in order. Firstly, the magnetic quiver prescription provides a systematic description of all the (weakly and strongly coupled) phases of the 6d Higgs branches. The underlying 3d Coulomb branch quiver has already been discussed in [22,36,37]. Secondly, the novel perspective in the present paper is the brane realisation of these magnetic quivers via suspended D4s. Thirdly,

the use of branes makes the *discrete gauging* relation between the various Higgs branches manifest. In more detail, the conjecture of [22] asserts that the 6d Higgs branches corresponding to (2.8) and (2.12) are related via gauging of discrete permutation groups. The Type IIA picture in phase (2.7) exhibits an S_n symmetry due to the indistinguishable nature of the NS5s. When the NS5 branes are coincident as in (2.11) the discrete $\prod_i S_{n_i}$ group is gauged.

2.4 Small E_8 instanton transition: M5 branes near M9 plane

The other extreme is a system of M5 branes near an M9 plane which do also exhibit various phases

(2.13)

depending on whether the M5 branes are outside the M9 or inside. Here, \mathbb{C}^2 is conveniently treated as $\mathbb{C}^2/\mathbb{Z}_1$, i.e. the A_0 singularity. Correspondingly, in the Type IIA picture there is a single D6 brane.

Single M5. Consider a single M5 near an M9. The phase where the M5 is outside the M9 has the following brane system:

(2.14)

It can be described in Type IIA as follows³:

(2.15)

Note that there is no choice of boundary condition involved. Since there is only one D6 and all eight D8 are strictly speaking on top of the $O8^-$ orientifold, one may connect the D6 to any of the D8s. In addition, the brane system in (2.15) only displays one side of the entire brane content as all the mirror objects outside the $O8^-$ behave identical to their counterparts. That being said, note that the depicted NS5s are technically half NS5 branes.

Similar to above, one can move to the phase of the brane system where all D6s are suspended between D8s by pulling one D8 from infinity, one obtains

(2.16)

³In the remaining brane diagrams we will omit the labels for the different branes. The brane diagrams are either M-theory or Type IIA diagrams and follow the conventions established in diagrams (2.1) and (2.2) respectively.

Note again that one $U(1)$ gauge node originates from the D6 suspended between two D8s, while the other $U(1)$ stems from the NS5 (once again the neutral hypermultiplet that also corresponds to the NS5 has been omitted in the depiction of the magnetic quiver, since it does not contribute to the 3d Coulomb branch). The relation between the electric and magnetic quiver is given in terms of their associated moduli spaces

$$\mathcal{H}^{6d}(\text{electric}_{\text{quiver}}(2.15)) = \mathcal{C}^{3d}(\text{magnetic}_{\text{quiver}}(2.16)) = \mathbb{C}^2 = \mathbb{H}. \quad (2.17)$$

However, there is another phase of the 6d system which is reached when the M5 approaches the M9 plane. In Type IIA the half NS5 can be moved towards the $O8^-$ through the D8s via a transition with brane creation [8, Sec. 3.2]. As first step, one moves the half NS5 behind the last D8 and takes care of brane creation as follows:

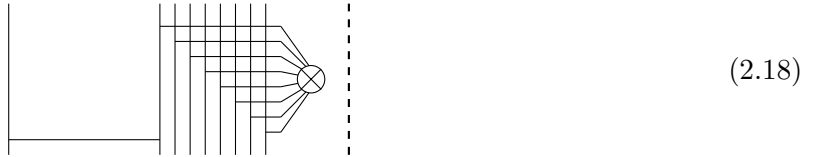

Next, one merges the half NS5 on the orientifold with its mirror image, then splits them along the $O8^-$ such that these are free to move vertically. All the newly created D6s become unfrozen and are now free to move along the vertical directions as well. Recalling that a D6 stretched between a D8 and its mirror image does not lead to a massless BPS state, the D6s in the last two segments closest to the $O8^-$ need to be rearranged as follows:

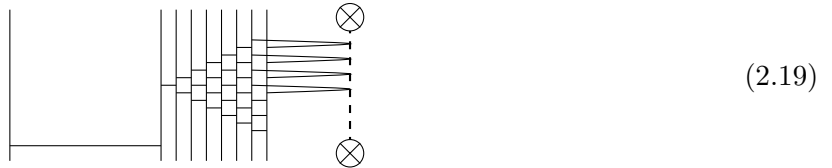

In the last brane system the 8 D6s in the interval between the rightmost D8 and the $O8^-$ have been connected with their mirror images. From this, one can read off the magnetic quiver using the rules established before

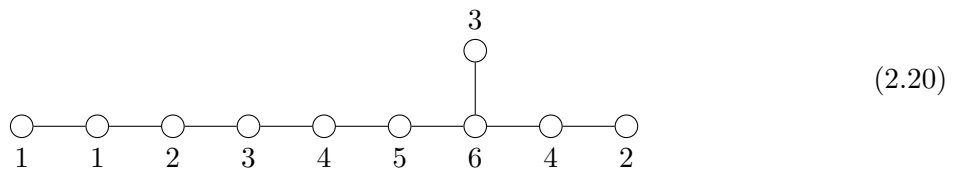

This result deserves some comments. Firstly, the bifurcation in the magnetic quiver is a direct consequence of the brane picture (2.19). In more detail, there is a stack of three D6s between the 7th and 8th D8s starting from the left, as well as a stack of four D6s between the 8th and the 7th D8s, but these D6s go all the way through the $O8^-$. By the previous arguments, the stack of three and four D6 give rise to an $U(3)$ and an $U(4)$ magnetic vector multiplets, respectively, which are both connected via magnetic bifundamental hypermultiplets to the $U(6)$ gauge node from the stack of six D6s in between the 6th and 7th D8s. Secondly, the $U(2)$ node at the very right of the quiver results from the two half NS5 branes that can move freely along the $O8^-$. The setting is similar to the discrete gauging argument of (2.11): the two half NS5 branes on the $O8^-$ are coincident with the difference that the magnetic adjoint hypermultiplet is frozen due to the orientifold projection; we would like to relate this effect also to the fact that the NS5s on the $O8^-$ cannot move in the x^6 direction. The resulting $U(2)$ magnetic gauge node is connected via a magnetic bifundamental

hypermultiplet due to D4 branes stretching between the stack of four D6s and the stuck NS5 branes. Thirdly, treating the magnetic quiver from (2.16) and (2.20) as 3d $\mathcal{N} = 4$ Coulomb branch quiver, one observes that the difference in dimension is 29 and the symmetry of (2.20) is enhanced to E_8 in contrast to (2.16). This effect is known as small E_8 instanton transition, as discussed in [21].

It is important for later discussion that the same quiver can be read off from a different (but also maximal) subdivision of the D6s of the brane system

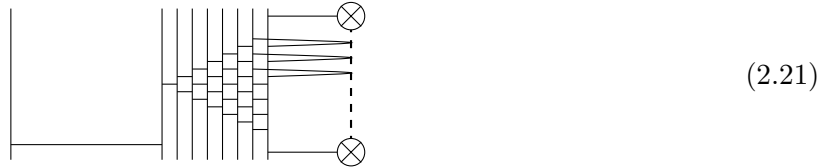

from which one would read off

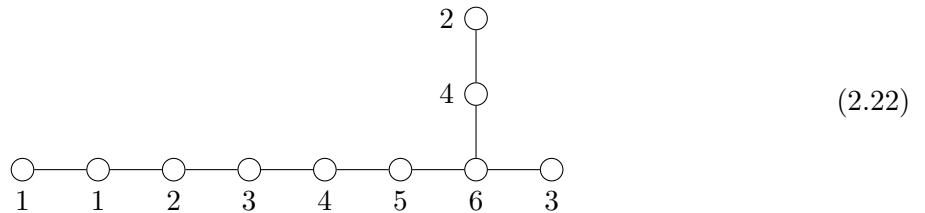

i.e. the difference between (2.19) and (2.21) is that the gauge nodes after the bifurcation are interchanged. Moreover, the two half NS5 branes on the $O8^-$ have each a D6 ending on them. These D6s do not contribute any degrees of freedom as they are frozen between a D8 and a NS5. However, the NS5s still contribute the gauge degrees as these are free to move along the $O8^-$.

The point to appreciate here is that the prescription of *magnetic quiver* is capable to produce a quiver that contains an affine E_8 Dynkin diagram in its balanced set of nodes. Therefore, the moduli naturally has an E_8 symmetry. Again, the relevant 3d $\mathcal{N} = 4$ Coulomb branch quiver has been proposed before [21], but the proposal of this paper provides an explicit brane realisation.

Remark. The two brane configurations (2.19) and (2.21) deserve to be commented on. At first glance, there are two different brane systems in which the numbers of freely moving D6 branes are identical. The corresponding magnetic quivers differ only by an exchange of $(4')$ — $(2')$ and $(3')$ legs, using the Dynkin labels of the affine E_8 Dynkin diagram. Therefore, the Coulomb branches of (2.19) and (2.21) are isomorphic.

It is not clear whether these two brane systems do hint on a geometric phenomenon. One possibility might be *moduli spaces which are the union of two cones*, as observed in 4d $\mathcal{N} = 2$ $SU(2)$ gauge theory with 2 flavours [41], in 3d $\mathcal{N} = 4$ $USp(2n)$ gauge theory with $2n$ flavours [42], or in 5d SQCD [19]. However, the remainder of this paper consists of a detailed study of the brane configurations of type (2.19) since they provide novel insights on many of the physical features already presented in [20–22]. The possibility of a geometric significance of the two configurations (2.19) and (2.21) is interesting, but further analysis is required and postponed to future work.

Multiple M5 branes on A_0 . One can readily repeat the analysis for multiple M5s near an M9. There are multiple phases that can be realised: M5s outside can either be coincident or separated along the x^6 direction, while one may also move M5s into the M9. Suppose there are n M5 in total from which n_0 moved inside the M9 and from the remaining M5s there are n_i coincident at position x_i^6 , for $i = 1, \dots, l$. Of course $\sum_{i=0}^l n_i = n$. The relevant *magnetic quiver* can be extracted

from the previous arguments: each M5 that moves inside the M9 creates branes in the pattern of (2.19). Moreover, the coincident branes outside the M9 affect the brane picture as in (2.11) for $k = 1$. Hence, the magnetic quiver reads

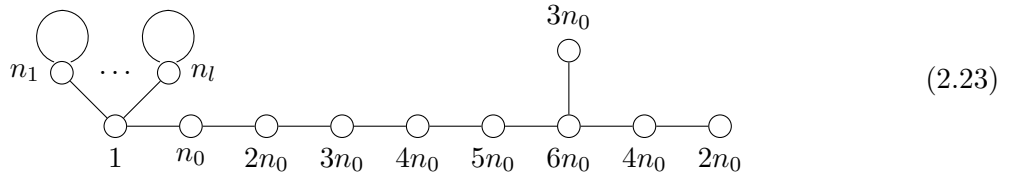

Again, the symmetry contains an E_8 factor which is recognised by the pattern of balanced nodes. Consequently, the magnetic quivers provide a systematic description for all (weakly and strongly coupled) phases of the 6d Higgs branch.

2.5 Derivation rules

Following the discussion of Sections 2.3–2.4, the procedure for deriving the magnetic quiver can be formalised by a few rules.

Conjecture 2 (Magnetic quiver). *For a D6-D8-NS5 brane system, cf. Table 1, in which all D6 branes are suspended between D8 branes, the massless BPS states, deduced from stretching virtual D4 branes, arise from the following configurations:*

- (i) *Stack of m D6 branes suspended between two D8s in a finite x^6 interval: the vertical motion along the x^7, x^8, x^9 directions gives rise to a $U(m)$ magnetic vector multiplet due to D4s stretched between them.*

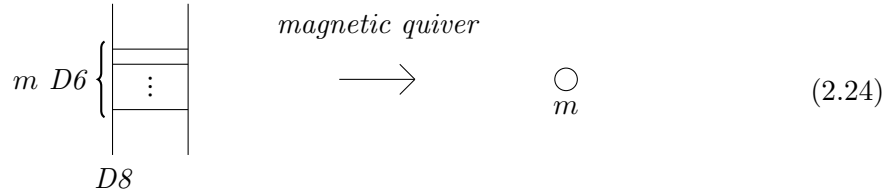

- (ii) *Stacks of m D6 and l D6 branes in adjacent D8 intervals along the x^6 direction: the D4 branes suspended between D6s of different intervals induce a magnetic bifundamental hypermultiplet of $U(m) \times U(l)$.*

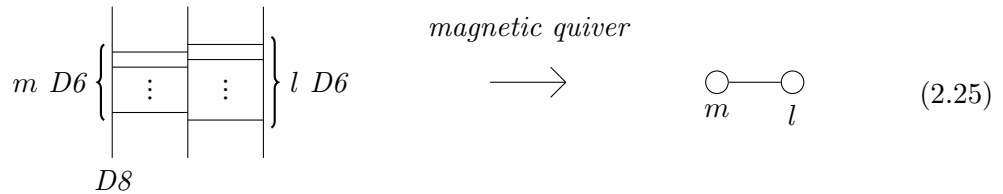

- (iii) *Stack of m NS5 branes at coincident x^6 position: the vertical motion along the x^7, x^8, x^9 directions gives rise to a $U(m)$ magnetic vector multiplet due to D4s stretched between. If the NS5s are free to move along the x^6 direction, there is an additional hypermultiplet in the adjoint representation of $U(m)$ (this is in contrast to the NS5s being stacked at the $O8^-$ plane, where there is no adjoint hypermultiplet in the magnetic quiver).*

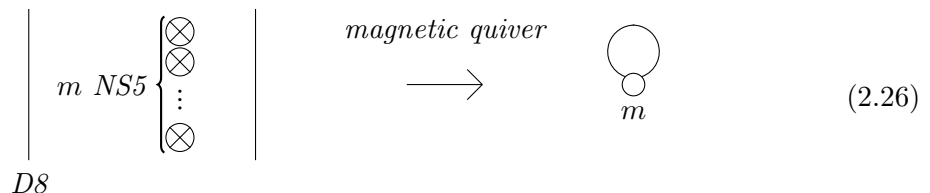

(iv) Stacks of l D6 and m NS5 branes between two D8 in a finite x^6 interval: the vertical distance in the x^7, x^8, x^9 directions leads to a magnetic bifundamental hypermultiplet of $U(l) \times U(m)$.

$$(2.27)$$

The massless degrees of freedom can be encoded in a quiver diagram in the familiar way.

2.6 Phases and their geometry

The two fundamental cases of Section 2.3 and 2.4 are sufficient to treat all cases of n M5 branes near an M9 plane on $\mathbb{C}^2/\mathbb{Z}_k$, provided the embeddings $\mathbb{Z}_k \hookrightarrow E_8$ are known, see Section 3.1. Before proceeding to the general case, some remarks are in order.

Firstly, two Higgs branches $\mathcal{H}_{1,2}^{6d}$ which are related via discrete gauging of a discrete S_l permutation group satisfy

$$\mathcal{H}_1^{6d} = \mathcal{C}_1^{3d} = \mathcal{C}_2^{3d}/S_l = \mathcal{H}_2^{6d}/S_l \quad \Rightarrow \quad \mathcal{R}(\mathcal{H}_1^{6d}) \subset \mathcal{R}(\mathcal{H}_2^{6d}), \quad (2.28)$$

where \mathcal{R} denotes the associated chiral rings. Note both moduli spaces have the same dimension as only a discrete group has been gauged in the electric theory or quotient by in the magnetic theory [22, 36, 37]. However, the inclusion holds only on the space of functions or, equivalently, the space of protected operators.

Secondly, two Higgs branches $\mathcal{H}_{1,2}^{6d}$ which are related via a small E_8 instanton transition satisfy the following *quiver subtraction* relation on their magnetic quivers

$$\mathcal{H}_i^{6d} = \mathcal{C}^{3d}(\text{magnetic quiver } \mathbf{Q}_i), \quad i = 1, 2, \quad \overline{\mathcal{O}}_{\min}^{E_8} = \mathcal{C}^{3d}(\mathbf{Q}_{E_8}) \quad (2.29)$$

$$\Rightarrow \quad \mathbf{Q}_1 - \mathbf{Q}_2 = \mathbf{Q}_{E_8}. \quad (2.30)$$

Note in particular that $\mathcal{H}_2^{6d} \subset \mathcal{H}_1^{6d}$ and that the transverse slice of \mathcal{H}_2^{6d} inside \mathcal{H}_1^{6d} is given by the closure of the minimal nilpotent orbit $\overline{\mathcal{O}}_{\min}^{E_8}$ of E_8 . As simplest example, consider the quivers (2.16), (2.20) and perform the quiver subtraction [21, 35] as follows:

$$(2.31)$$

such that

$$\mathcal{H}_1^{6d} = \mathcal{C}^{3d} \left(\begin{array}{c} \text{magnetic} \\ \text{quiver} \end{array} \text{ (2.16)} \right) = \mathbb{H} \subset \mathcal{H}_2^{6d} = \mathcal{C}^{3d} \left(\begin{array}{c} \text{magnetic} \\ \text{quiver} \end{array} \text{ (2.20)} \right) = \mathbb{H} \times \overline{\mathcal{O}}_{\min}^{E_8} \quad (2.32)$$

and the transverse slice $\overline{\mathcal{O}}_{\min}^{E_8}$ becomes apparent in this example.

This highlights and clarifies the interplay between the size of the U(1)-bouquet and the E_8 transition, because it originates from motions of NS5 branes in the brane configuration. Moreover, all phase transitions that were originally derived from the brane setting can be equally well understood from operations on the magnetic quivers.

3 Multiple M5 branes near an M9 plane on A_{k-1} singularity

After establishing the usefulness of magnetic quivers and the phase of the Type IIA brane setup in which all D6s are suspended between D8 branes, the generic case of M5 branes near an M9 plane on a $\mathbb{C}^2/\mathbb{Z}_k$ singularity can be approached. The arising difficulty is the need to specify the embedding of \mathbb{Z}_k into the E_8 symmetry of the end-of-the-world M9 or, put differently, to assign boundary conditions of the D6 on the D8 branes in the Type IIA or Type I' set-up.

3.1 Embedding of \mathbb{Z}_k into E_8

Following [10, 43], the embedding of $\mathbb{Z}_k \hookrightarrow E_8$ can be labelled by non-negative integer fluxes

$$\left(\begin{array}{cccccccc} & & & & & m'_3 & & \\ m_1 & m_2 & m_3 & m_4 & m_5 & m_6 & m'_4 & m'_2 \end{array} \right). \quad (3.1)$$

Using the Dynkin labels a_i of affine E_8

$$\begin{array}{ccccccccccc} & & & & & & \textcircled{3} & & & & \\ & & & & & & | & & & & \\ \textcircled{1} & - & \textcircled{2} & - & \textcircled{3} & - & \textcircled{4} & - & \textcircled{5} & - & \textcircled{6} & - & \textcircled{4} & - & \textcircled{2} \end{array}, \quad (3.2)$$

the fluxes determine the order k of the A_{k-1} singularity via

$$k = \sum_{i=1}^6 a_i m_i + \sum_{i=2,3,4} a'_i m'_i, \quad (3.3)$$

such that $a_i = i$ and $a'_i = i$. The particular choice of embedding has an immediate physical consequence on the 6d theory: the commutant of the image of \mathbb{Z}_k inside E_8 is isomorphic to the global symmetry. In fact, the commutant can be read off from the affine E_8 Dynkin diagram by deleting the nodes that take non-trivial flux (3.1).

Most of the considerations will be within the Type IIA framework; hence, it is useful to reformulate the embeddings $\mathbb{Z}_k \hookrightarrow E_8$ via partitions $\vec{\lambda} = (\lambda_1, \dots, \lambda_9)$ which determine the boundary conditions of the k D6 ending on the 8 D8 branes on top of the $O8^-$ orientifold. The following choice is useful:

$$\begin{aligned} m_i &= \lambda_i - \lambda_{i+1}, & \text{for } i &= 1, \dots, 6 & \text{and} \\ m'_3 &= \lambda_7 + \lambda_8, & m'_4 &= \lambda_7 - \lambda_8, & m'_2 &= \lambda_8 - \lambda_9. \end{aligned} \quad (3.4)$$

Note that this parametrisation suggests that m_i together with m'_3 and m'_4 form the simple roots of $SO(16)$, which is natural since there are 8 D8 present. Similarly, the m_i together with m'_4 and m'_2

furnish the simple roots of $SU(9)$. Alternatively, one can think in terms of linking numbers l_i for the i -th D8 branes, which are defined as

$$l_i := \#\{\text{D6 ending from the left}\} - \#\{\text{D6 ending from the right}\} + \#\{\text{NS5 to the right}\} \quad (3.5)$$

such that $l_i = \lambda_i$ for all i . As a comment, if the λ_i are such that only the first eight linking numbers are non-negative, then Type IIA with 8 D8 branes is the useful setting. If, however, all nine linking numbers are non-negative then Type I' with 9 D8 branes becomes convenient.

Given the embedding $\mathbb{Z}_k \hookrightarrow E_8$, one can now consider the first few cases and finally present the general result.

3.2 Case $k = 1$

There is only one possibility: $m_1 = 1$ and all other fluxes (3.1) vanish. The linking numbers are $(1, 0^7)$ and the Type IIA setting has already been discussed in Section 2.4.

3.3 Case $k = 2$

There exist three possibilities, cf. [20, Sec. 5.1]:

$$m_1 = 2, \quad m_2 = 1, \quad \text{or} \quad m_2' = 1, \quad (3.6)$$

which will be discussed in turn below. The details of the discrete gauging phase transitions or small E_8 instanton transition will not be spelled out, as these are straight forward operations on the brane picture that manifest themselves either as local operations on the associated bouquet or as inverse operations of quiver subtraction.

3.3.1 Symmetry $SU(2) \times E_8$ — case $m_1 = 2$

The linking numbers read $l = (2, 0^7)$ and the Type IIA brane system is given by

$$(3.7)$$

$$(3.8)$$

which gives rise to the electric quiver

$$(3.9)$$

The last step is needed as there is no $U(1)$ gauge symmetry in 6 dimensions. The resulting 6d quiver gauge theory has flavour symmetry and Higgs branch dimension given by

$$G_F = (\text{SO}(4))^2 \times \text{USp}(2)^{n-3} \cong \text{SU}(2)^{n+1} \quad \text{and} \quad \dim \mathcal{H}^{6d} = n + 2. \quad (3.10)$$

Likewise, one may change to the brane system in which all D6s are suspended between D8 branes and reads off the magnetic quiver

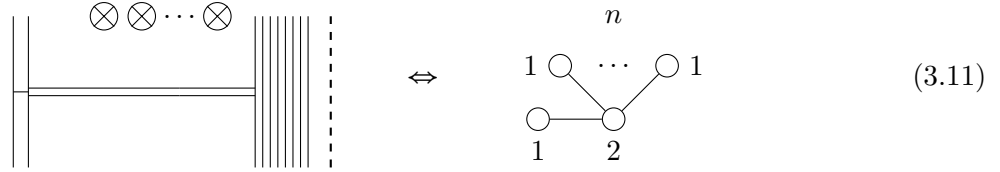

$$(3.11)$$

where the topological symmetry and Coulomb branch dimension of the magnetic quiver are

$$G_J = \text{SU}(2)^{n+1} \quad \text{and} \quad \dim \mathcal{C}^{3d} = n + 2. \quad (3.12)$$

The electric and magnetic quiver for the weakly coupled phase are related via their associated moduli spaces: $\mathcal{H}^{6d}(\text{electric quiver}) = \mathcal{C}^{3d}(\text{magnetic quiver})$.

3.3.2 Symmetry $\text{SU}(2) \times (E_7 \times U(1))$ — case $m_2 = 1$

The linking numbers read $l = (1^2, 0^6)$ and the Type IIA brane system is given by

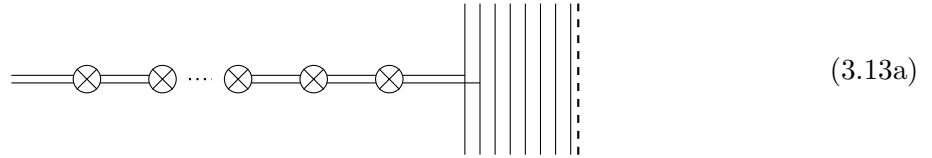

$$(3.13a)$$

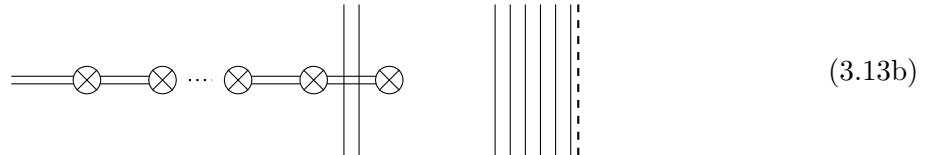

$$(3.13b)$$

from which one can read off the electric quiver

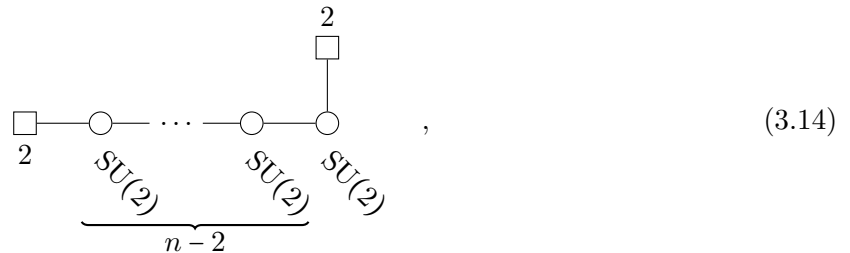

$$(3.14)$$

with flavour symmetry and Higgs branch dimension

$$G_F = \text{SO}(4)^2 \times \text{USp}(2)^{n-2} \cong \text{SU}(2)^{n+2} \quad \text{and} \quad \dim \mathcal{H}^{6d} = n + 3. \quad (3.15)$$

Likewise, one may change to the phase of the brane system which yields the magnetic quiver

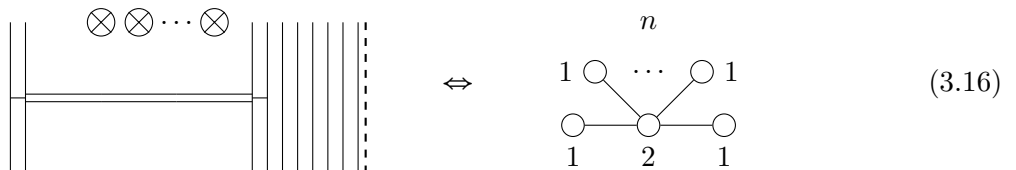

$$(3.16)$$

where the topological symmetry and Coulomb branch dimension read

$$G_J = \text{SU}(2)^{n+2} \quad \text{and} \quad \dim \mathcal{C}^{3d} = n + 3. \quad (3.17)$$

Again, the electric and magnetic quiver for the weakly coupled phase are related via $\mathcal{H}^{6d}(\text{electric quiver}) = \mathcal{C}^{3d}(\text{magnetic quiver})$.

3.3.3 Symmetry $\text{SU}(2) \times \text{SO}(16)$ — case $m'_2 = 1$

The linking numbers read $l = (0^8)$ and the Type IIA brane system is given by

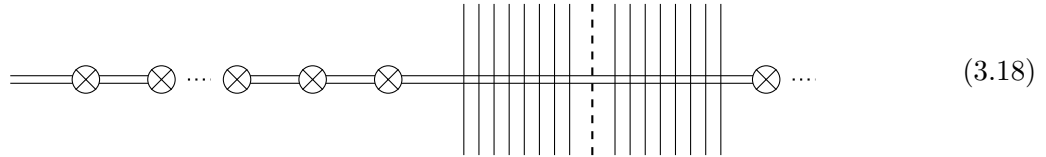

which gives rise to the electric quiver

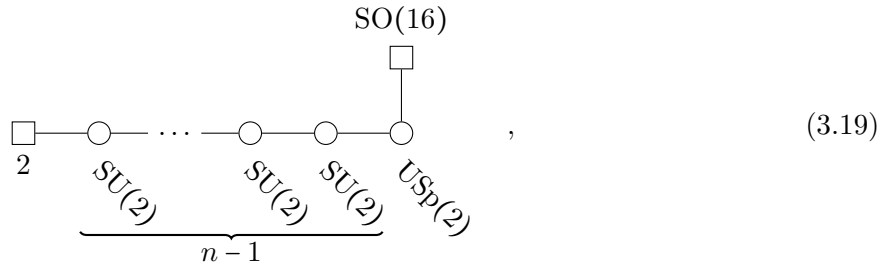

with flavour symmetry and Higgs branch dimension

$$G_F = \text{SO}(4) \times \text{USp}(2)^{n-1} \times \text{SO}(16) \cong \text{SU}(2)^{n+1} \times \text{SO}(16) \quad \text{and} \quad \dim \mathcal{H}^{6d} = n + 16. \quad (3.20)$$

Note that the theory is anomaly free as $\text{USp}(N_c)$ is equipped with $N_f = N_c + 8$ flavours. As before, one may change to the following phase of the brane system

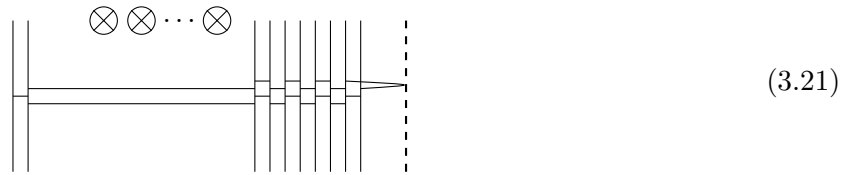

which yields the magnetic quiver

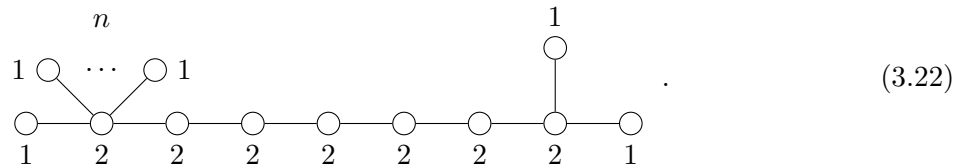

The dimensions and symmetries of the magnetic quiver are

$$G_J = \text{SU}(2)^{n+1} \times \text{SO}(16) \quad \text{and} \quad \dim \mathcal{C}^{3d} = n + 16. \quad (3.23)$$

3.4 Case $k = 3$

There exist five possibilities to embed \mathbb{Z}_3 into E_8 :

$$m_1 = 3, \quad m_1 = 1, m_2 = 1, \quad m_1 = 1, m'_2 = 1, \quad m_3 = 1, \quad \text{or} \quad m'_3 = 1. \quad (3.24)$$

This will be discussed in detail below. Again, discrete gauging or small E_8 instanton transitions will not be elaborated on. The focus is put on deriving the associated magnetic quiver for the electric quiver using the rules of Conjecture 2.

3.4.1 Symmetry $SU(3) \times E_8$ — case $m_1 = 3$

The linking numbers read $l = (3, 0^7)$ and the Type IIA brane system is given by

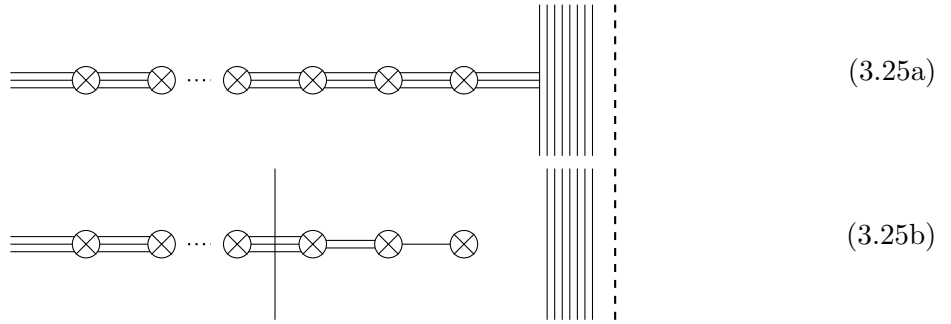

which gives rise to the electric quiver

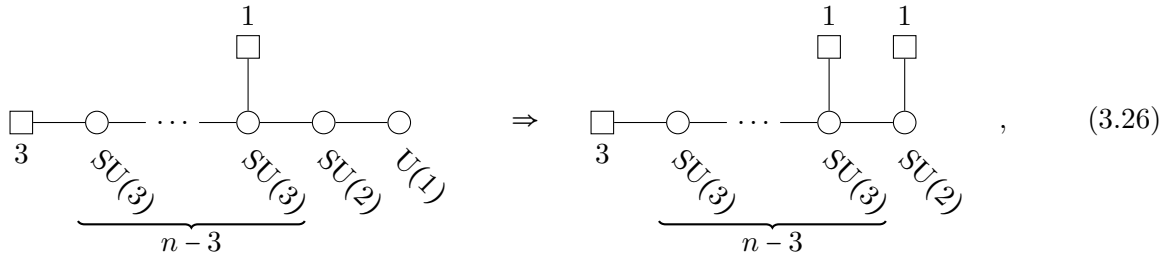

wherein the last step is necessary as there are no $U(1)$ gauge nodes in 6d. The flavour symmetry and Higgs branch dimension of the electric quiver are

$$G_F = SU(3) \times U(1)^n \quad \text{and} \quad \dim \mathcal{H}^{6d} = n + 5. \quad (3.27)$$

Changing the brane system to the phase where D6s are suspended between D8 branes leads to the magnetic quiver

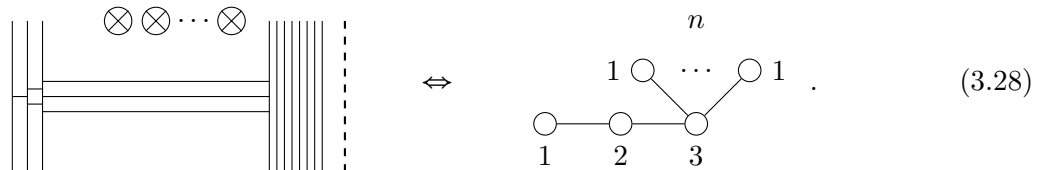

The Coulomb branch dimension and symmetries are

$$G_J = SU(3) \times U(1)^n \quad \text{and} \quad \dim \mathcal{C}^{3d} = n + 5. \quad (3.29)$$

3.4.2 Symmetry $SU(3) \times (U(1) \times E_7)$ — case $m_1 = m_2 = 1$

The linking numbers read $l = (2, 1, 0^6)$ and the Type IIA brane system is given by

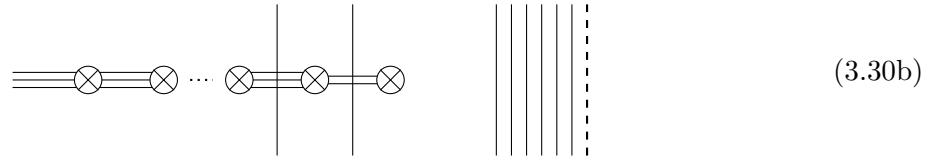
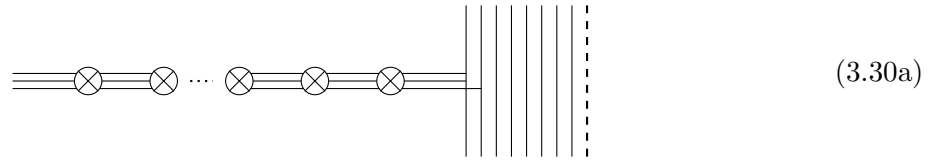

which gives rise to the electric quiver

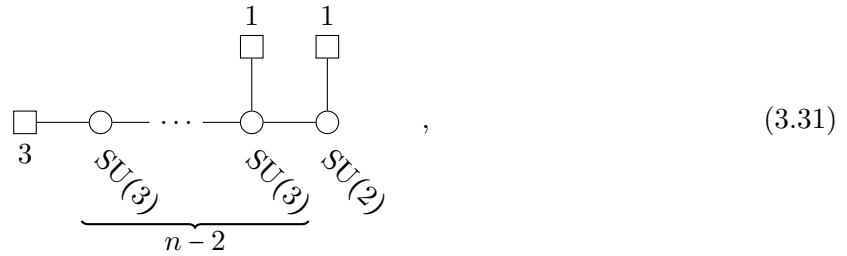

with flavour symmetry and Higgs branch dimension

$$G_F = SU(3) \times U(1)^{n+1} \quad \text{and} \quad \dim \mathcal{H}^{6d} = n + 6. \quad (3.32)$$

Passing to the brane system for the magnetic quiver, one obtains

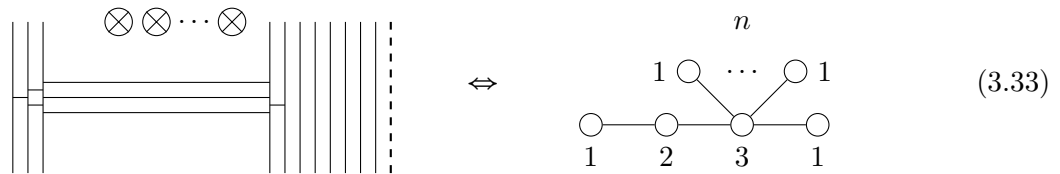

and the dimensions and symmetries of the magnetic quiver are

$$G_J = SU(3) \times U(1)^{n+1} \quad \text{and} \quad \dim \mathcal{C}^{3d} = n + 6. \quad (3.34)$$

3.4.3 Symmetry $SU(3) \times (SU(3) \times E_6)$ — case $m_3 = 1$

The linking numbers read $l = (1^3, 0^5)$ and the Type IIA brane system is given by

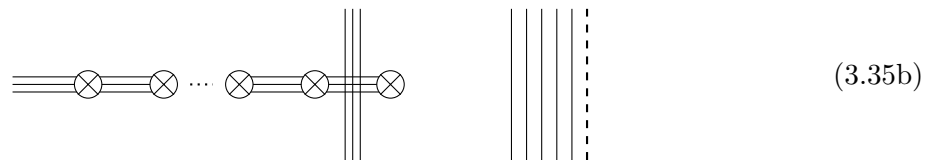
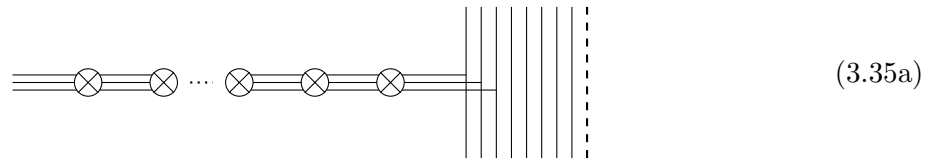

which gives rise to the electric quiver

$$\begin{array}{c}
 \square \\
 | \\
 \square \text{---} \circ \text{---} \dots \text{---} \circ \text{---} \circ \\
 \text{3} \quad \text{SU(3)} \quad \text{SU(3)} \quad \text{SU(3)} \\
 \underbrace{\hspace{10em}}_{n-1}
 \end{array} , \tag{3.36}$$

with flavour symmetry and Higgs branch dimension

$$G_F = \text{SU}(3)^2 \times \text{U}(1)^n \quad \text{and} \quad \dim \mathcal{H}^{6d} = n + 8 . \tag{3.37}$$

To derive the magnetic quiver, one passes to the following phase of the brane system:

$$\begin{array}{c}
 \otimes \otimes \dots \otimes \\
 \Leftrightarrow \\
 \begin{array}{c}
 n \\
 \circ \\
 | \\
 \circ \text{---} \circ \text{---} \circ \text{---} \circ \text{---} \circ \\
 1 \quad 2 \quad 3 \quad 2 \quad 1
 \end{array}
 \end{array} \tag{3.38}$$

where the dimensions and symmetries are

$$G_J = \text{SU}(3)^2 \times \text{U}(1)^n \quad \text{and} \quad \dim \mathcal{C}^{3d} = n + 8 . \tag{3.39}$$

3.4.4 Symmetry $\text{SU}(3) \times (\text{U}(1) \times \text{SO}(14))$ — case $m_1 = m'_2 = 1$

The linking numbers read $l = (1, 0^7)$ and the Type IIA brane system is given by

$$\begin{array}{c}
 \dots \otimes \otimes \dots \otimes \otimes \dots \\
 \dots \otimes \otimes \dots \otimes \otimes \dots
 \end{array} \tag{3.40a}$$

$$\begin{array}{c}
 \dots \otimes \otimes \dots \otimes \otimes \dots \\
 \dots \otimes \otimes \dots \otimes \otimes \dots
 \end{array} \tag{3.40b}$$

which gives rise to the electric quiver

$$\begin{array}{c}
 \square \text{---} \circ \text{---} \dots \text{---} \circ \text{---} \circ \\
 \text{3} \quad \text{SU(3)} \quad \text{SU(3)} \quad \text{SU(3)} \quad \text{USp(2)} \\
 \underbrace{\hspace{10em}}_{n-1} \\
 \square \text{---} \square \\
 \text{1} \quad \text{SO(14)}
 \end{array} , \tag{3.41}$$

with flavour symmetry and Higgs branch dimension

$$G_F = \text{SU}(3) \times \text{U}(1)^{n+1} \times \text{SO}(14) \quad \text{and} \quad \dim \mathcal{H}^{6d} = n + 19 . \tag{3.42}$$

Note that the theory is anomaly free as $\mathrm{USp}(N_c)$ is equipped with $N_f = N_c + 8$ flavours. Changing to the brane system for the magnetic quiver results in

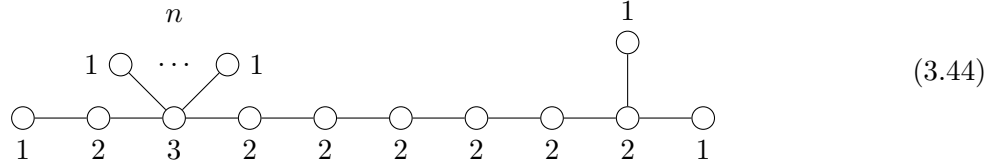
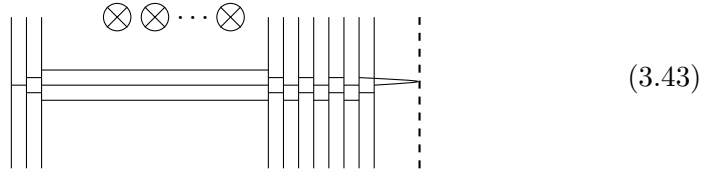

and the symmetry and Coulomb branch dimension are

$$G_J = \mathrm{SU}(3) \times \mathrm{U}(1)^{n+1} \times \mathrm{SO}(14) \quad \text{and} \quad \dim \mathcal{C}^{3d} = n + 19. \quad (3.45)$$

3.4.5 Symmetry $\mathrm{SU}(3) \times \mathrm{SU}(9)$ — case $m'_3 = 1$

The linking numbers read $l = (\frac{1}{2}^8)$ and the Type IIA brane system is given by

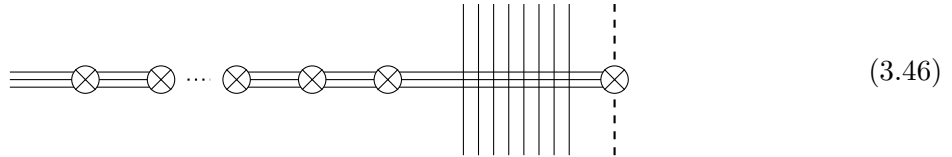

Here, the linking number of $\frac{1}{2}$ has been realised by a stuck half NS5 on the orientifold. This gives rise to the following electric quiver:

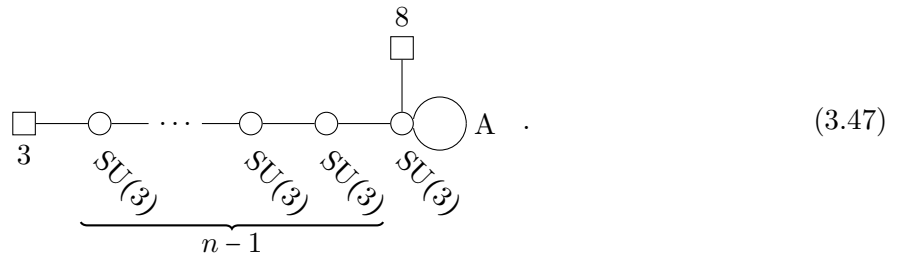

Here, the anti-symmetric loop at the last gauge node is necessary for anomaly cancellation; this is a clear consequence of the brane picture, cf. [6, Sec. 2.1]. Nonetheless, for $\mathrm{SU}(3)$ one has $\Lambda^2[1, 0] = [0, 1] \cong [1, 0]$. Consequently, the quiver is equivalent to

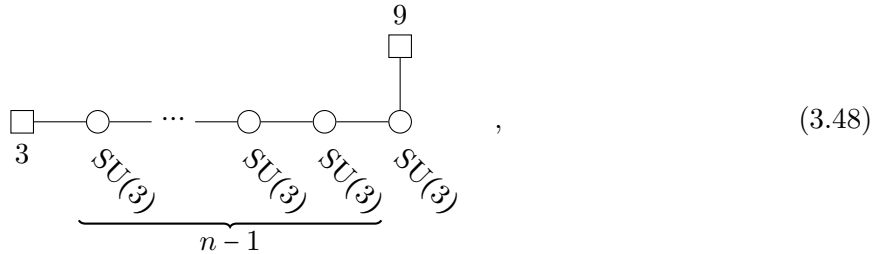

with flavour symmetry and Higgs branch dimension

$$G_F = \mathrm{SU}(3) \times \mathrm{U}(1)^{n+1} \times \mathrm{SU}(9) \quad \text{and} \quad \dim \mathcal{H}^{6d} = n + 27. \quad (3.49)$$

As usual, one may change to the phase of the brane system for the magnetic quiver

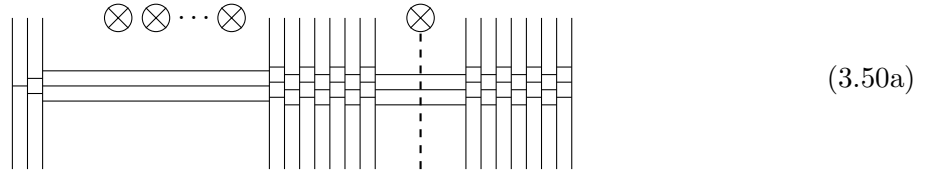

which can be rearranged by connecting the D6s in the interval between the last D8 and the $O8^-$ with their mirror images. In addition, one D6 will be stretched between the stuck half NS5 and the last D8 such that the brane system becomes

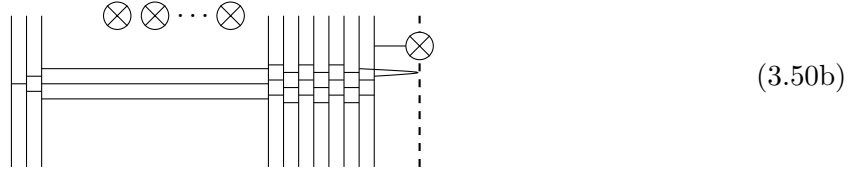

and the magnetic quiver reads

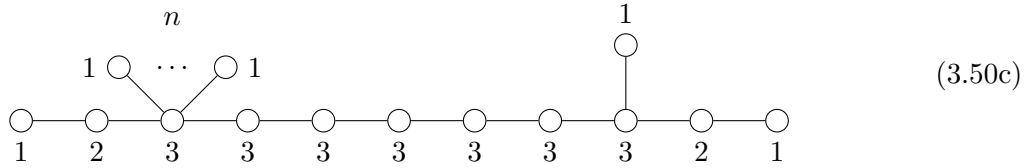

with Coulomb branch dimension and symmetry given by

$$G_J = \text{SU}(3) \times \text{U}(1)^{n+1} \times \text{SU}(9) \quad \text{and} \quad \dim \mathcal{C}^{3d} = n + 27. \quad (3.51)$$

3.5 Case $k = 4$

For the A_3 singularity $\mathbb{C}^2/\mathbb{Z}_4$, there exist ten possibilities for the embedding $\mathbb{Z}_4 \hookrightarrow E_8$, cf. [20, Sec. 5.3]:

$$\begin{aligned} m_1 = 4, & & m_1 = 2, m_2 = 1, & & m_1 = 2, m'_2 = 1, & & m_2 = 1, m'_2 = 1, & & m_2 = 2, \\ m'_2 = 2, & & m_1 = 1, m_3 = 1, & & m_1 = 1, m'_3 = 1, & & m_4 = 1, & \text{or} & m'_4 = 1. \end{aligned} \quad (3.52)$$

As before, the brane systems and the electric as well as magnetic quivers will be provided. Since discrete gauging and E_8 transitions are straightforwardly derived from the discussion above, these transitions will not be detailed any further. It is sufficient to specify the derivation of the magnetic quiver in the weakly coupled phase by means of Conjecture 2.

3.5.1 Symmetry $\text{SU}(4) \times E_8$ — case $m_1 = 4$

The linking numbers are $l = (4, 0^7)$ such that the brane system reads

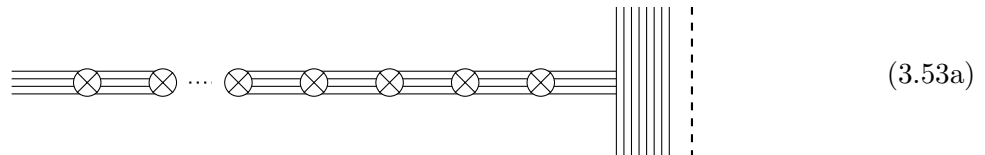

(3.53b)

with associated electric quiver

(3.54)

as there is no $U(1)$ gauge symmetry in 6d. The flavour symmetry and Higgs branch dimension become

$$G_F = SU(4) \times U(1)^n \quad \text{and} \quad \dim \mathcal{H}^{6d} = n + 9. \quad (3.55)$$

The phase of the brane system for the magnetic quiver is derived as

(3.56)

and the symmetry and Coulomb branch dimension are

$$G_J = SU(4) \times U(1)^n \quad \text{and} \quad \dim \mathcal{C}^{3d} = n + 9. \quad (3.57)$$

3.5.2 Symmetry $SU(4) \times (U(1) \times E_7)$ — case $m_1 = 2, m_2 = 1$

The linking numbers are $l = (3, 1, 0^6)$ such that the Type IIA brane system becomes

(3.58a)

(3.58b)

and the electric quiver is read off to be

(3.59)

with flavour symmetry and Higgs branch dimension

$$G_F = \text{SU}(4) \times \text{U}(1)^{n+1} \quad \text{and} \quad \dim \mathcal{H}^{6d} = n + 10. \quad (3.60)$$

Passing to the phase of the brane system for the magnetic quiver yields

$$(3.61)$$

and symmetry and Coulomb branch dimension are as follows

$$G_J = \text{SU}(4) \times \text{U}(1)^{n+1} \quad \text{and} \quad \dim \mathcal{C}^{3d} = n + 10. \quad (3.62)$$

3.5.3 Symmetry $\text{SU}(4) \times (\text{U}(1) \times \text{SO}(14))$ — case $m_1 = 2, m'_2 = 1$

Here, the linking numbers are $l = (2, 0^7)$ such that the brane system looks like

$$(3.63a)$$

$$(3.63b)$$

with corresponding electric quiver

$$(3.64)$$

which has flavour symmetry and Higgs branch dimension

$$G_F = \text{SU}(4) \times \text{U}(1)^{n+1} \times \text{SO}(14) \quad \text{and} \quad \dim \mathcal{H}^{6d} = n + 23. \quad (3.65)$$

Note that the 6d theory is anomaly free as $\text{USp}(N_c)$ is equipped with $N_f = N_c + 8$ flavours. Next, the phase of the brane system that allows to deduce the magnetic quiver reads

$$(3.66)$$

$$(3.67)$$

and Coulomb branch dimension and symmetry are

$$G_J = \text{SU}(4) \times \text{U}(1)^{n+1} \times \text{SO}(14) \quad \text{and} \quad \dim \mathcal{C}^{3d} = n + 23. \quad (3.68)$$

3.5.4 Symmetry $\text{SU}(4) \times (\text{U}(1) \times \text{SU}(2) \times \text{SO}(12))$ — case $m_2 = m'_2 = 1$

One computes to linking numbers to be $l = (1^2, 0^6)$ such that the brane picture becomes

$$(3.69a)$$

$$(3.69b)$$

such that the electric quiver reads

$$(3.70)$$

with flavour symmetry and Higgs branch dimension

$$G_F = \text{SU}(4) \times \text{U}(1)^{n+1} \times \text{SU}(2) \times \text{SO}(12) \quad \text{and} \quad \dim \mathcal{H}^{6d} = n + 24. \quad (3.71)$$

Note that the 6d theory is anomaly free as $\text{USp}(N_c)$ is equipped with $N_f = N_c + 8$ flavours. Passing to the brane system for the magnetic quiver yields

$$(3.72)$$

$$(3.73)$$

where the Coulomb branch dimension and symmetry are

$$G_J = \text{SU}(4) \times \text{U}(1)^{n+1} \times \text{SU}(2) \times \text{SO}(12) \quad \text{and} \quad \dim \mathcal{C}^{3d} = n + 24. \quad (3.74)$$

3.5.5 Symmetry $SU(4) \times (SU(2) \times E_7)$ — case $m_2 = 2$

The linking numbers $l = (2^2, 0^6)$ imply the following brane system:

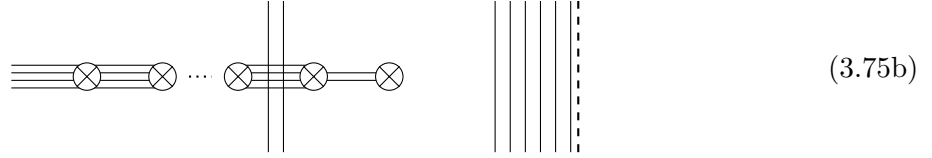
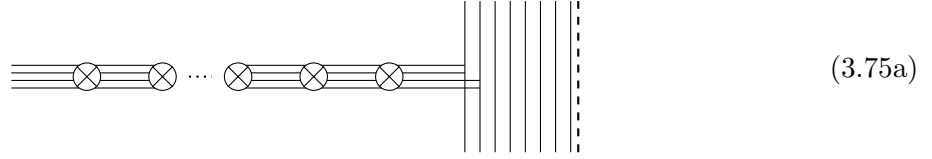

such that the electric quiver reads

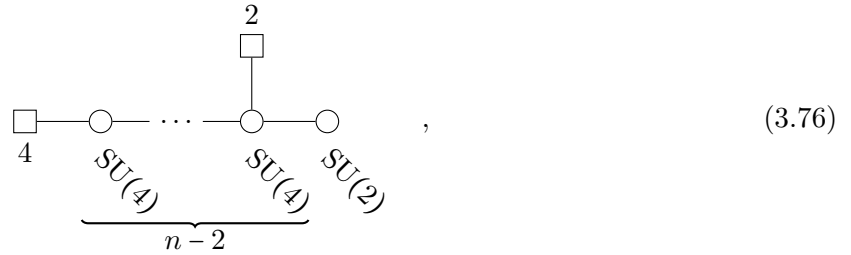

which has flavour symmetry and Higgs branch dimension

$$G_F = SU(4) \times U(1)^n \times SU(2) \quad \text{and} \quad \dim \mathcal{H}^{6d} = n + 11. \quad (3.77)$$

Passing to the phase of the brane system for the magnetic quiver results in

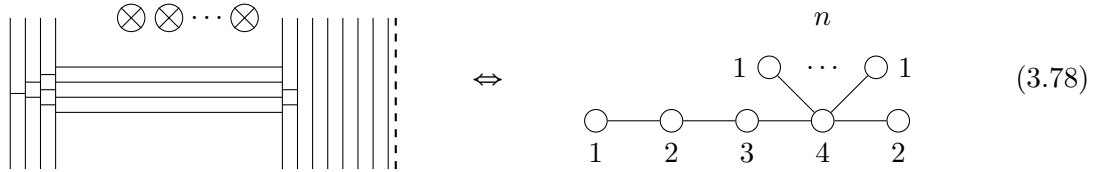

where the Coulomb branch dimension and symmetry are

$$G_J = SU(4) \times U(1)^n \times SU(2) \quad \text{and} \quad \dim \mathcal{C}^{3d} = n + 11. \quad (3.79)$$

3.5.6 Symmetry $SU(4) \times SO(16)$ — case $m'_2 = 2$

For linking numbers $l = (0^8)$ the corresponding brane system becomes

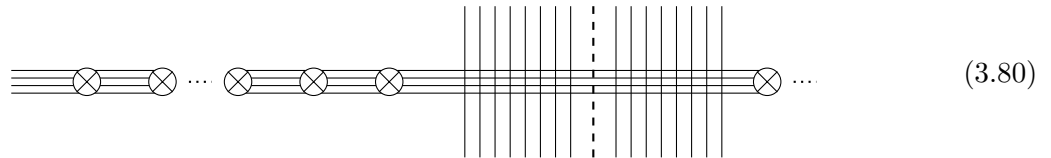

and the electric quiver reads

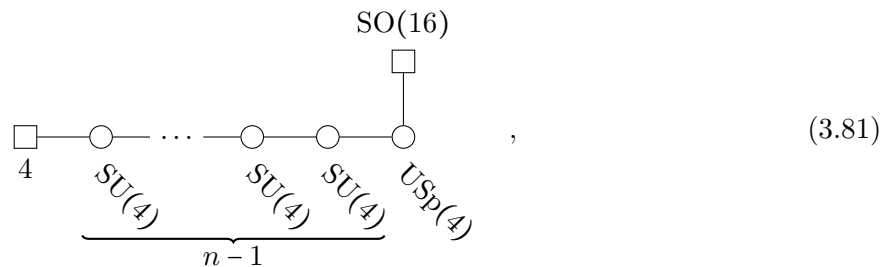

with flavour symmetry and Higgs branch dimension

$$G_F = \text{SU}(4) \times \text{U}(1)^n \times \text{SO}(16) \quad \text{and} \quad \dim \mathcal{H}^{6d} = n + 37. \quad (3.82)$$

Note that the 6d theory is anomaly free as $\text{USp}(N_c)$ is equipped with $N_f = N_c + 8$ flavours. Next, changing to the brane system for the magnetic quiver results in

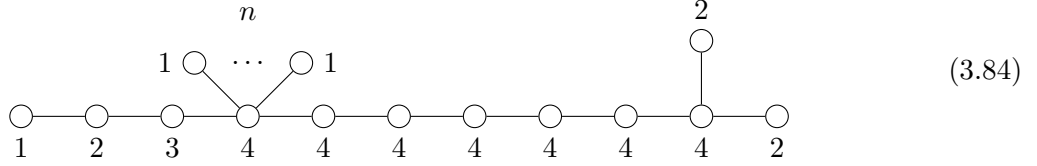
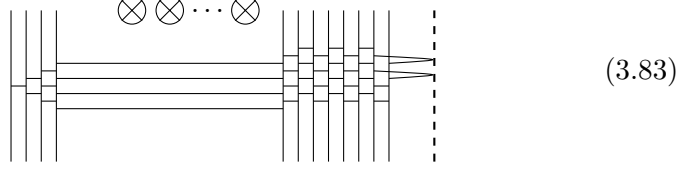

where the Coulomb branch dimension and symmetry are

$$G_J = \text{SU}(4) \times \text{U}(1)^n \times \text{SO}(16) \quad \text{and} \quad \dim \mathcal{C}^{3d} = n + 37. \quad (3.85)$$

3.5.7 Symmetry $\text{SU}(4) \times (\text{U}(1) \times \text{SU}(2) \times E_6)$ — case $m_1 = m_3 = 1$

Here, the linking numbers read $l = (2, 1^2, 0^5)$ and imply the following system

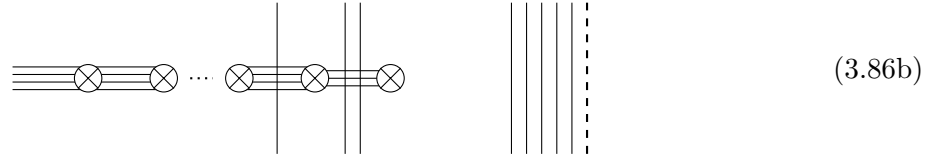
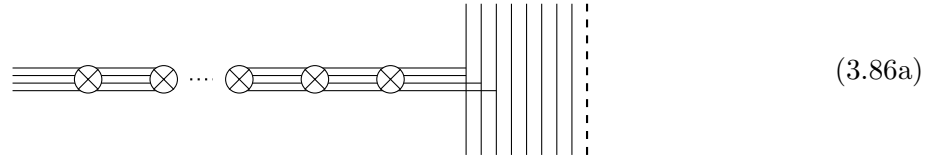

with associated electric quiver

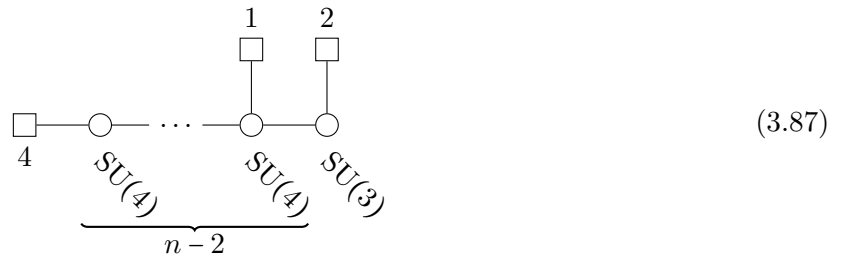

which has flavour symmetry and Higgs branch dimension

$$G_F = \text{SU}(4) \times \text{U}(1)^{n+1} \times \text{SU}(2) \quad \text{and} \quad \dim \mathcal{H}^{6d} = n + 12. \quad (3.88)$$

Changing the phase of the brane system to be able to read off the magnetic quiver results in

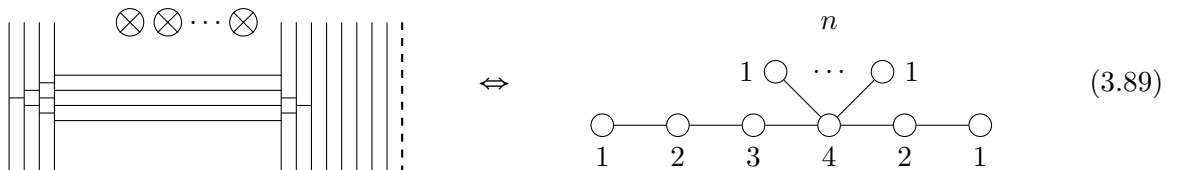

where Coulomb branch dimension and symmetry are

$$G_J = \text{SU}(4) \times \text{U}(1)^{n+1} \times \text{SU}(2) \quad \text{and} \quad \dim \mathcal{C}^{3d} = n + 12. \quad (3.90)$$

3.5.8 Symmetry $\text{SU}(4) \times (\text{U}(1) \times \text{SU}(8))$ — case $m_1 = m'_3 = 1$

In this case, the linking numbers are $l = (\frac{3}{2}, \frac{1}{2}^7)$ and the Type IIA brane realisation becomes

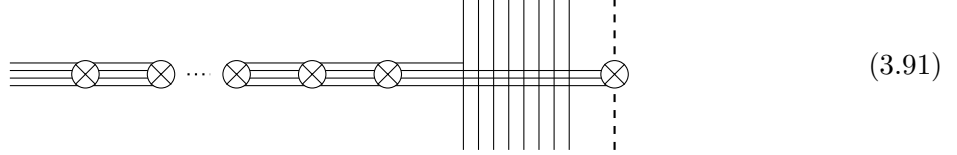

As before, the linking number of $\frac{1}{2}$ has been realised by a stuck half NS5 on the orientifold. The brane system allows to derive the electric quiver

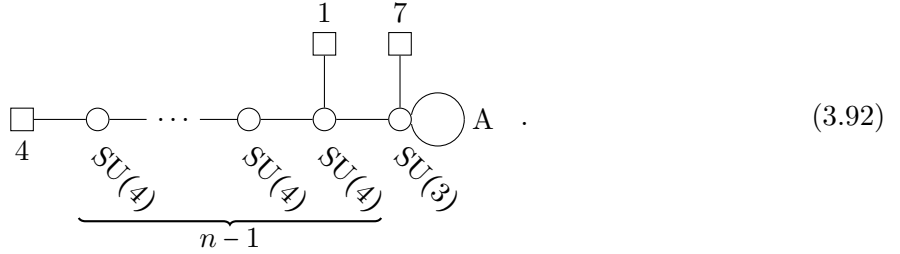

Here, the anti-symmetric loop at the last gauge node is necessary for anomaly cancellation in 6 dimensions, but clearly follows from the brane construction, cf. [6, Sec. 2.1]. Nonetheless, for $\text{SU}(3)$ one has $\Lambda^2[1, 0] = [0, 1] \cong [1, 0]$. Consequently, the electric quiver is equivalent to

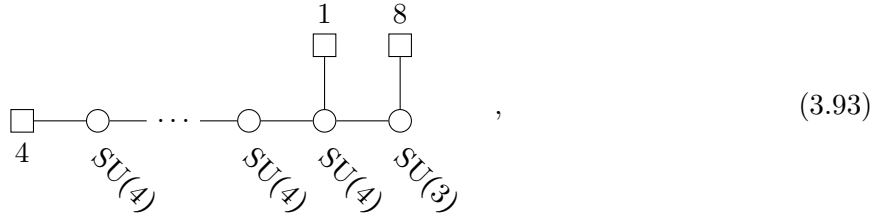

with flavour symmetry and Higgs branch dimension

$$G_F = \text{SU}(4) \times \text{U}(1)^{n+2} \times \text{SU}(8) \quad \text{and} \quad \dim \mathcal{H}^{6d} = n + 31. \quad (3.94)$$

Passing to the brane system for the magnetic quiver proceeds as

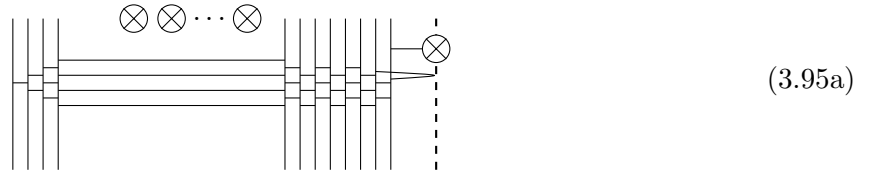

such that the magnetic quiver is read off to be

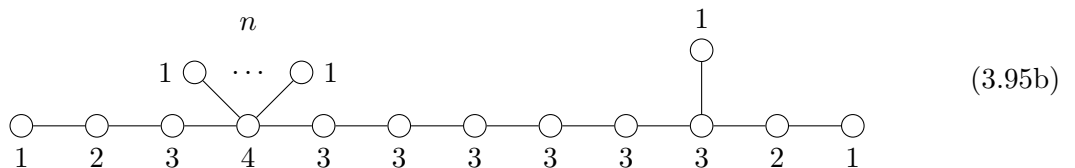

and the Coulomb branch dimension and symmetry are

$$G_J = \text{SU}(4) \times \text{U}(1)^{n+2} \times \text{SU}(8) \quad \text{and} \quad \dim \mathcal{C}^{3d} = n + 31. \quad (3.96)$$

3.5.9 Symmetry $SU(4) \times (SU(4) \times SO(10))$ — case $m_4 = 1$

One computes the linking numbers as $l = (1^4, 0^4)$ such that the brane configuration becomes

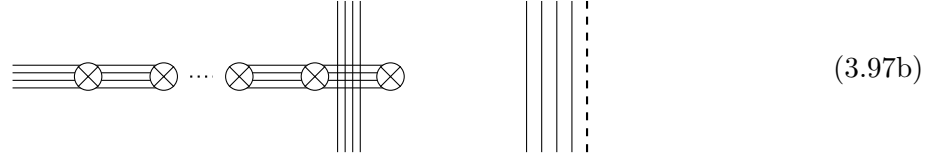
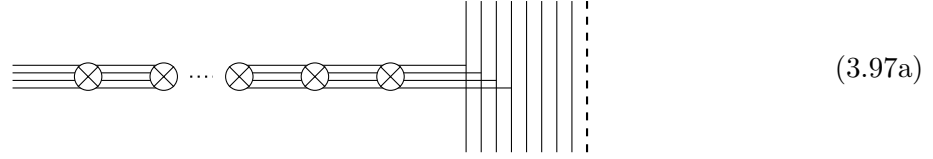

and the electric quiver reads

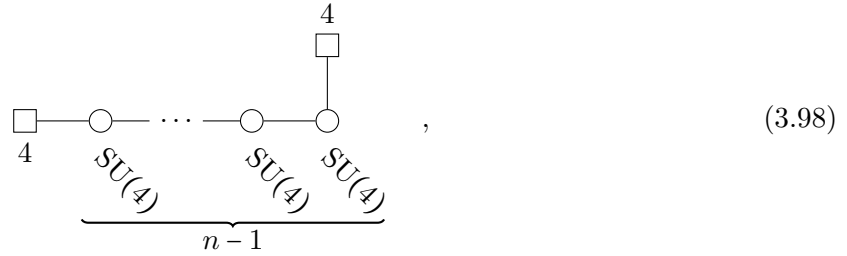

with flavour symmetry and Higgs branch dimension

$$G_F = SU(4)^2 \times U(1)^n \quad \text{and} \quad \dim \mathcal{H}^{6d} = n + 15. \quad (3.99)$$

Proceeding to the brane system for magnetic quiver leads to

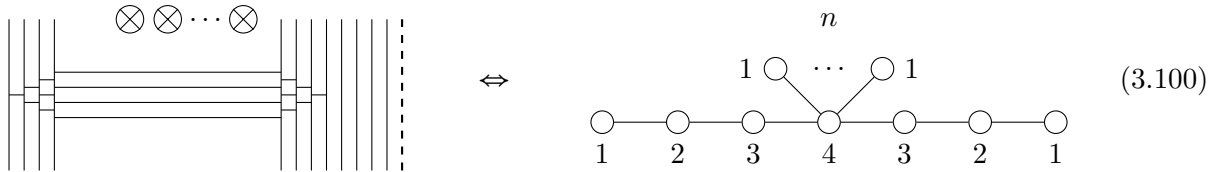

and Coulomb branch dimension and symmetry are

$$G_J = SU(4)^2 \times U(1)^n \quad \text{and} \quad \dim \mathcal{C}^{3d} = n + 15. \quad (3.101)$$

3.5.10 Symmetry $SU(4) \times (SU(8) \times SU(2))$ — case $m'_4 = 1$

The linking numbers read $l = (\frac{1}{2}^7, -\frac{1}{2})$, and we observe that λ_8 is negative, which can be realised in a Type IIA brane configuration as follows:

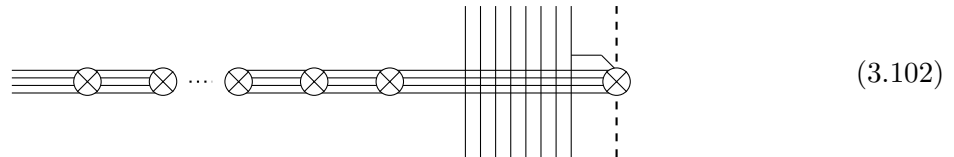

Here, the linking number of $\frac{1}{2}$ has been realised by a stuck half NS5 on the orientifold. However, one may perform a transition with brane creation / annihilation by pushing the 8th D8 through

the orientifold and the stuck half NS5. Then the mirror of the original D8 appears, but has no D6 ending on it, i.e. the brane configuration becomes

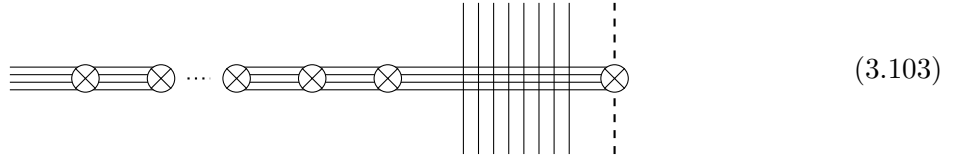

The linking numbers of this configuration are $l' = (\frac{1}{2}^8)$, but the system is equivalent to the original. The corresponding electric quiver reads

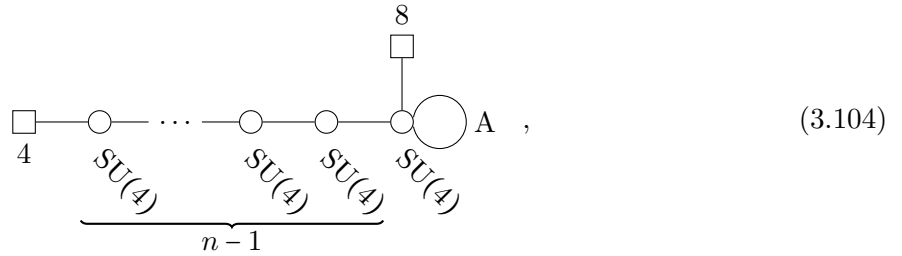

with flavour symmetry and Higgs branch dimension

$$G_F = \text{SU}(4) \times \text{U}(1)^{n+1} \times \text{SU}(8) \times \text{SU}(2) \quad \text{and} \quad \dim \mathcal{H}^{6d} = n + 38. \quad (3.105)$$

Here, the anti-symmetric loop at the last gauge node is necessary for anomaly cancellation, but is clearly derived from the brane system, cf. [6, Sec. 2.1]. The corresponding hypermultiplet in the second anti-symmetric representation of $\text{SU}(4)$, which is a real representation, contributes a $\text{USp}(2) \cong \text{SU}(2)$ flavour symmetry. Passing to the brane system for the magnetic quiver yields

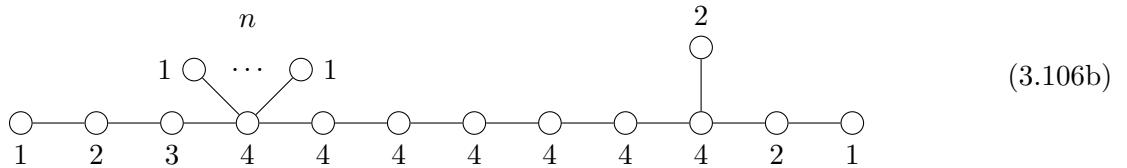
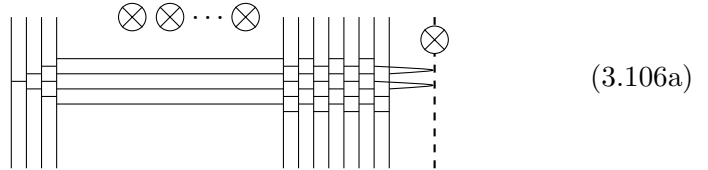

and the Coulomb branch dimension and symmetry are

$$G_J = \text{SU}(4) \times \text{U}(1)^{n+1} \times \text{SU}(8) \times \text{SU}(2) \quad \text{and} \quad \dim \mathcal{C}^{3d} = n + 38. \quad (3.107)$$

As a remark, pulling up the stuck NS5 on the O8^- orientifold and reconnecting the D6 branes with their mirrors reduces the system the $m'_2 = 2$ configuration. On the field theory side, one Higgses the anti-symmetric hypermultiplet of the $\text{SU}(4)$ such that the gauge group is broken to $\text{USp}(4)$.

3.6 General case

Having discussed multiple examples, one can approach the general construction. From the examples considered, a case study of the linking numbers seems the best way to proceed. To begin with,

inverting the relations (3.4) yields

$$\begin{aligned} \lambda_i &= m_i + \lambda_{i+1} = \sum_{j=i}^6 m_j + \lambda_7, \quad i = 1, \dots, 6 \\ \lambda_7 &= \frac{1}{2}(m'_3 + m'_4), \quad \lambda_8 = \frac{1}{2}(m'_3 - m'_4), \quad \lambda_9 = \frac{1}{2}(m'_3 - m'_4 - 2m'_2), \end{aligned} \quad (3.108)$$

from which one observes

- (i) $\lambda_1 \geq \lambda_2 \geq \dots \geq \lambda_6 \geq \lambda_7 \geq 0$,
- (ii) $\lambda_7 \geq \lambda_8 \geq \lambda_9$, but λ_8 and / or λ_9 may become negative,
- (iii) either $\lambda_i \in \mathbb{Z}$ for all $i = 1, \dots, 9$ or $\lambda_i \in \mathbb{Z} + \frac{1}{2}$ for all $i = 1, \dots, 9$.

For reasons that become clear later, define the following quantities

$$p := \min \left\{ \left\lfloor \frac{m'_3 + m'_4}{2} \right\rfloor, \left\lfloor \frac{m'_2 + m'_3 + 2m'_4}{3} \right\rfloor \right\} = \min \left\{ \lfloor \lambda_7 \rfloor, \left\lfloor \lambda_7 - \frac{1}{3} \lambda_9 \right\rfloor \right\}, \quad r := \lambda_7 - p. \quad (3.109)$$

Therefore, as long as $\lambda_9 \leq 0$ it follows that $p = \lfloor \lambda_7 \rfloor$ and r is either zero or a half. Consequently, the discussion is split in several cases, cf. [20],

- (1) For $m'_4 \geq m'_3, m'_4 \pm m'_3 = \text{even}$ it follows

$$\lambda_1 \geq \dots \geq \lambda_7 \geq 0 \geq \lambda_8 \geq \lambda_9 \in \mathbb{Z}, \quad p = \lambda_7, r = 0. \quad (3.110)$$

- (2) For $m'_4 \geq m'_3, m'_4 \pm m'_3 = \text{odd}$ one finds

$$\lambda_1 \geq \dots \geq \lambda_7 \geq 0 \geq \lambda_8 \geq \lambda_9 \in \mathbb{Z} + \frac{1}{2}, \quad p = \lfloor \lambda_7 \rfloor, r = \frac{1}{2}. \quad (3.111)$$

- (3) For $m'_3 \geq m'_4, m'_3 - m'_4 \leq 2m'_2, m'_3 \pm m'_4 = \text{even}$ one has

$$\lambda_1 \geq \dots \geq \lambda_7 \geq \lambda_8 \geq 0 \geq \lambda_9 \in \mathbb{Z}, \quad p = \lambda_7, r = 0. \quad (3.112)$$

- (4) For $m'_3 \geq m'_4, m'_3 - m'_4 \leq 2m'_2, m'_3 \pm m'_4 = \text{odd}$ one obtains

$$\lambda_1 \geq \dots \geq \lambda_7 \geq \lambda_8 \geq 0 \geq \lambda_9 \in \mathbb{Z} + \frac{1}{2}, \quad p = \lfloor \lambda_7 \rfloor, r = \frac{1}{2}. \quad (3.113)$$

- (5) For $m'_3 \geq m'_4, m'_3 - m'_4 \geq 2m'_2$ it follows

$$\lambda_1 \geq \dots \geq \lambda_7 \geq \lambda_8 \geq \lambda_9 \geq 0, \quad p = \left\lfloor \lambda_7 - \frac{1}{3} \lambda_9 \right\rfloor. \quad (3.114)$$

Strategy. For cases (1)–(4), one may employ the known Type IIA constructions [6–8] with non-vanishing cosmological constant that yield 6-dimensional $\mathcal{N} = (1, 0)$ theories.

The numbers $2p$ and $2r$ are interpreted as total number of stuck half NS5 branes on the $O8^-$. The difference is that the $2p$ NS5 can leave the $O8^-$ in pairs, while the $2r$ NS5 cannot. Note that $2r$ can be larger than one due to the cosmological constant outside the orientifold plane. These numbers are determined from the brane picture by charge conservation, in the sense that the RR-charge and cosmological constant determine how many D6 branes are in each interval. The number of stuck NS5 branes is then determined by the linking numbers.

The remaining case (5) can be treated by Type I' constructions [44–46] which includes an $O8^*$ instead of an $O8^-$ orientifold, see also [29]. The arguments imply that there are two ways to split a single D8 from out of a system of coincident $O8^-$ and D8. Firstly, the stack of $O8^-$ and D8 can turn into a separate $O8^-$ and D8. Secondly, a stack of $O8^-$ and D8 can emanate a additional D8 while tuning into a stack of coincident $O8^*$ and D8. The latter can then be separated as usual such that there are a single $O8^*$ and two separate D8s.

In all cases, once the brane configuration is known for the electric theory, one can straightforwardly apply the rules of Conjecture 2 to derive the associated magnetic quiver.

3.6.1 $m'_4 \geq m'_3, m'_4 \pm m'_3 = \text{even}$

Electric quiver. Construct a Type IIA brane realisation for the linking number (3.110) and interpret $2p$ as the number half NS5 branes that are stuck on the $O8^-$ orientifold.

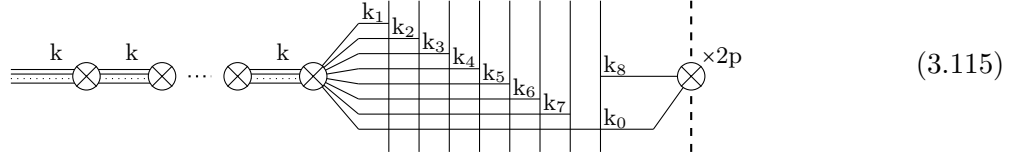

From the linking numbers (3.110) one readily computes

$$k_j = \sum_{i=j}^6 m_i, \quad j = 1, \dots, 6, \quad k_7 = 0, \quad k_8 = m'_4, \quad k_0 = 2m'_2 + 3m'_3 + 4m'_4, \quad (3.116)$$

$$p = \frac{1}{2}(m'_3 + m'_4).$$

However, one may perform a brane transition of the last D8 through the $O8^-$ to obtain a brane configuration with non-negative linking numbers only. In other words, pushing the D8 with linking number $\lambda_8 \leq 0$ through the $O8^-$ the mirror D8 reappears with linking number $|\lambda_8|$. The effects of brane creation and annihilation modify (3.115) to

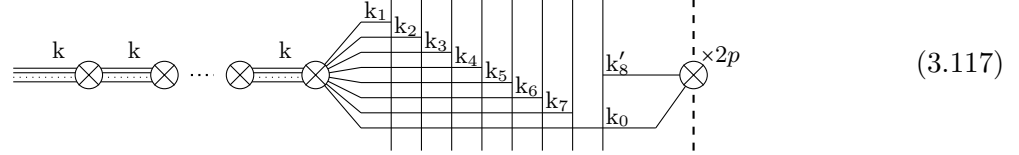

Such that the linking numbers of the D8 become $(\lambda_1, \dots, \lambda_7, |\lambda_8|)$, which are ordered and non-negative integer numbers. A computation shows:

$$k'_8 = 2p - k_8 = m'_3 + m'_4 - m'_4 = m'_3. \quad (3.118)$$

Next, one may remove the $2p$ stuck half NS5 branes from the $O8^-$ pairwise, i.e. there will be p pairs. This leads to

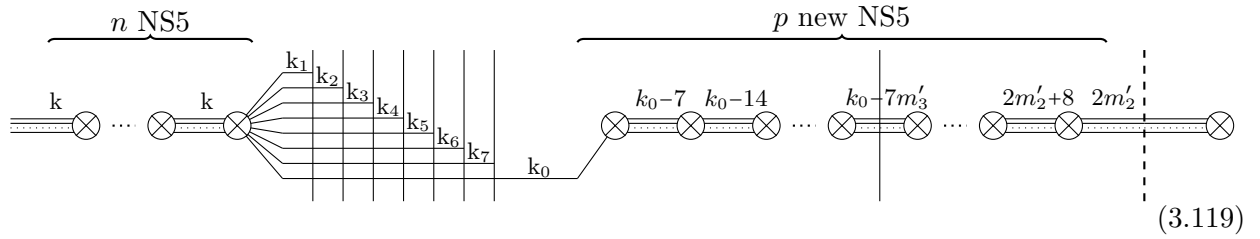

The tail of the resulting electric quiver looks like

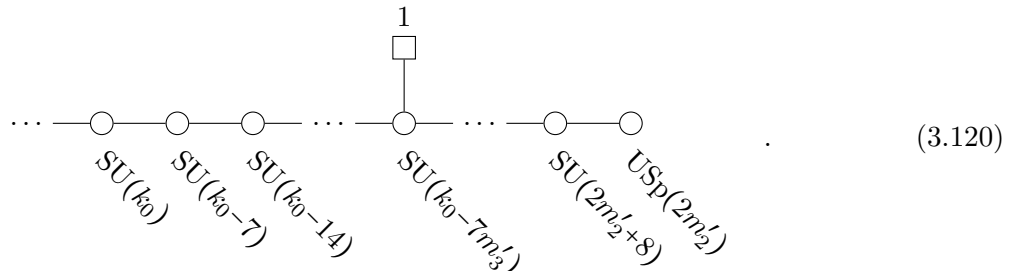

Magnetic quiver. Moreover, the brane picture (3.117) allows to change to the phase where all D6s are suspended between D8s in order to read off the magnetic quiver. The brane picture in this phase becomes

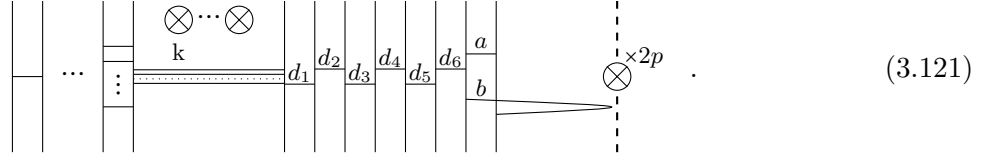

From the linking numbers (3.110) or (3.116) one computes the number of D6 branes to be

$$d_j = \sum_{i=1}^{6-j} i m_{i+j} + k_0, \quad \text{for } j = 1, \dots, 6, \quad (3.122a)$$

$$a = m'_2 + m'_3 + 2m'_4, \quad b = m'_2 + 2m'_3 + 2m'_4. \quad (3.122b)$$

In particular, note that $k_0 = a + b$ and $a + m'_3 = b$, which allows to rearrange the D6 branes in the last two segments compared to (3.117). Hence, the magnetic quiver becomes

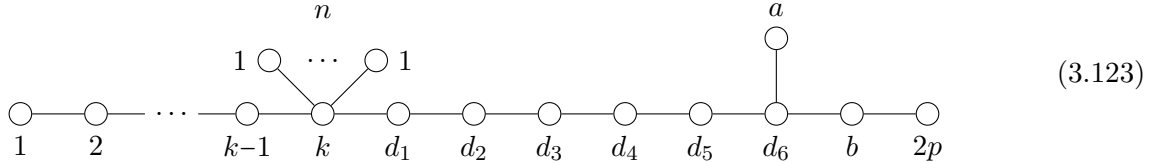

and it is apparent that one can perform p additional small E_8 instanton transitions.

This additional E_8 transitions should not come as a surprise, because the brane phase (3.121) corresponds to the original brane configuration (3.117). The electric quiver, however, is associated to the brane configuration (3.119) in which the additional p NS5 branes have been pulled off the orientifold. Inspecting the linking numbers in (3.119) shows that the p new half NS5 branes need to be moved to the left of all eight D8 of the M9 system such that the D6 branes can be suspended between D8 branes only. Fortunately, this is nothing else than the brane transition associated to the E_8 transition displayed in (2.19) and (2.21). Hence, one arrives at the following magnetic quiver

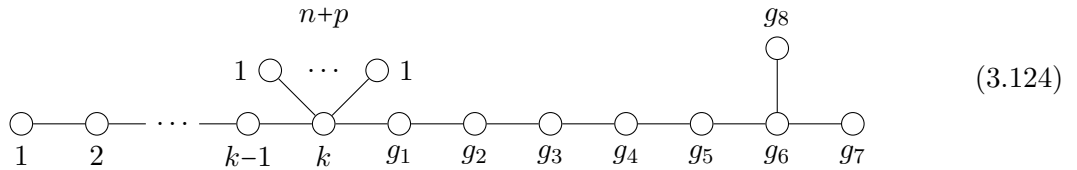

with unitary nodes of rank

$$g_j = \sum_{i=1}^{6-j} i m_{i+j} + 2m'_2 + m'_4 + \frac{6-j}{2}(m'_3 + m'_4), \quad \text{for } j = 1, \dots, 6 \quad (3.125a)$$

$$g_7 = m'_2, \quad g_8 = m'_2 + \frac{1}{2}(m'_4 - m'_3). \quad (3.125b)$$

Note that all ranks are non-negative integers by definition of the considered case. As a special case, consider $m_i = 0$ for all $i = 1, \dots, 6$ as well as $m'_3 = m'_4 = 0$ then one recognises the $SO(16)$ Dynkin diagram from the balanced nodes of the quiver. Finally, the important result is

$$\mathcal{H}^{6d}(\text{electric quiver (3.120)}) = \mathcal{C}^{3d}(\text{magnetic quiver (3.124)}). \quad (3.126)$$

3.6.2 $m'_4 \geq m'_3, m'_4 \pm m'_3 = \text{odd}$

Electric quiver. Construct a Type IIA brane realisation for the linking number (3.111) and interpret $2p + 1$ as the number half NS5 branes that are stuck on the $O8^-$ orientifold. The half-integer character of the linking numbers is a consequence of the odd number of half NS5 branes on the orientifold. Then much of the analysis from (3.115) and (3.117) carries over, with the suitable replacement of $2p$ to $2p + 1$. (Note that $p = \frac{1}{2}(m'_3 + m'_4 - 1)$.) Hence, the negative linking number of the 8th D8 can be traded for its positive version via pushing the 8th D8 (and its mirror) through the orientifold and the stuck NS5. As a consequence, one can again remove $2p$ of the stuck half NS5 branes from the $O8^-$, but one half NS5 inevitably remains on the orientifold. This leads to the brane picture

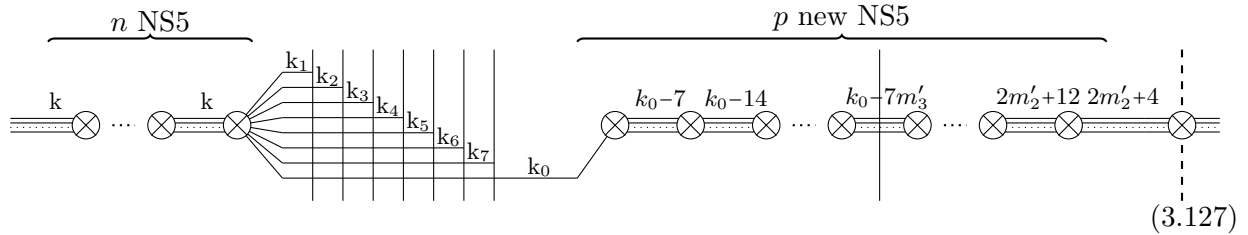

The tail of the resulting electric quiver looks like

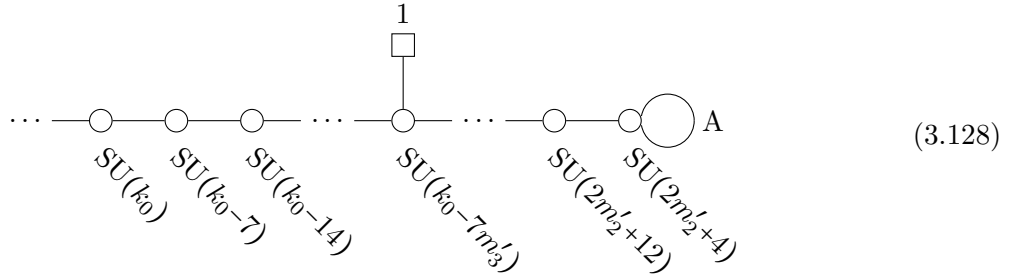

Magnetic quiver. Analogously to the previous case, above brane picture (3.127) allows to change to the phase where all D6 are suspended between D8 in order to read off the magnetic quiver. The brane picture in this phase becomes a small adaptation of (3.121), i.e.

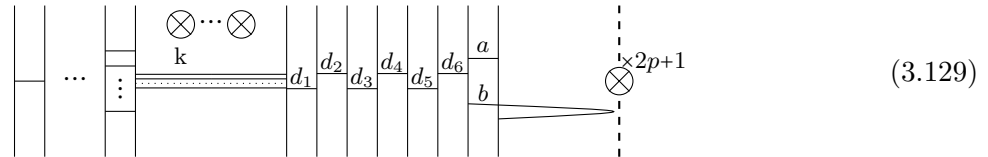

From the linking numbers (3.111) one computes the number of D6s to be as in (3.122). As before, relations $k_0 = a + b$ and $a + m'_3 = b$ allow to rearrange the D6 branes in the last two segments compared to (3.127). Hence, the magnetic quiver becomes

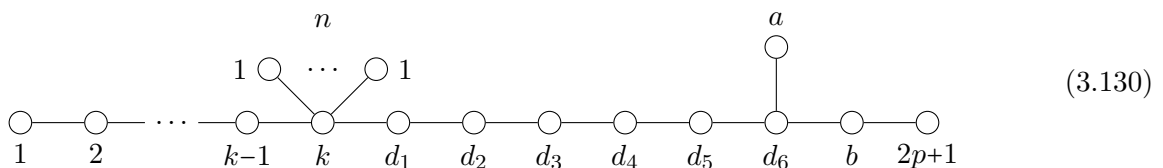

and it is apparent that one can perform p additional small E_8 instanton transitions. Again, this quiver results from the magnetic brane configuration given by (3.129). In order to obtain the

magnetic quiver for the electric quiver (3.128) with brane configuration (3.127), one needs to reverse the p additional E_8 instanton transitions. The resulting magnetic quiver looks as follows:

$$(3.131)$$

with unitary nodes of rank

$$g_j = \sum_{i=1}^{6-j} i m_{i+j} + 2m'_2 + m'_4 + \frac{6-j}{2}(m'_3 + m'_4 - 1) + 3, \text{ for } j = 1, \dots, 6, \quad (3.132a)$$

$$g_7 = m'_2 + 2, \quad g_8 = m'_2 + 1 + \frac{1}{2}(m'_4 - m'_3 + 1). \quad (3.132b)$$

All ranks are non-negative integers by definition of the considered case. Finally, the important result is

$$\mathcal{H}^{6d}(\text{electric quiver (3.128)}) = \mathcal{C}^{3d}(\text{magnetic quiver (3.131)}). \quad (3.133)$$

3.6.3 $m'_3 \geq m'_4, m'_3 - m'_4 \leq 2m'_2, m'_3 \pm m'_4 = \text{even}$

Electric quiver. Construct a Type IIA brane realisation for the linking number (3.112) and interpret $2p$ as the number half NS5 branes that are stuck on the $O8^-$ orientifold.

$$(3.134)$$

From the linking numbers (3.112) one readily computes the number of D6s to be as in (3.116). Next, one may remove the $2p$ stuck half NS5 branes from the $O8^-$ pairwise, i.e. there will be p pairs. This leads to

$$(3.135)$$

with $a_0 = 2m'_2 - (m'_3 - m'_4)$. The tail of the resulting electric quiver becomes

$$(3.136)$$

Magnetic quiver. Next, the brane configuration (3.134) allows to change to the phase where all D6 are suspended between D8 in order to derive the magnetic quiver. The brane configuration in this phase becomes

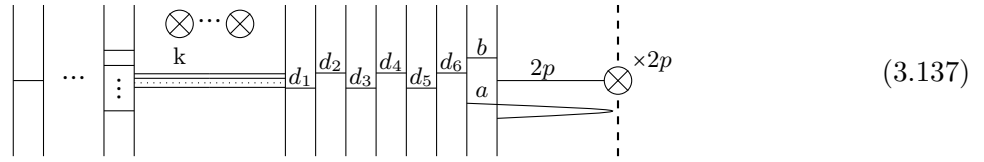

From the linking numbers (3.112) one computes the number of D6 to be as in (3.122). Here, the relations $k_0 = 2a + m'_3$ and $2p = m'_3 + m'_4$ allow to rearrange the D6 branes in the last two segments compared to (3.134). Thus, the magnetic quiver becomes

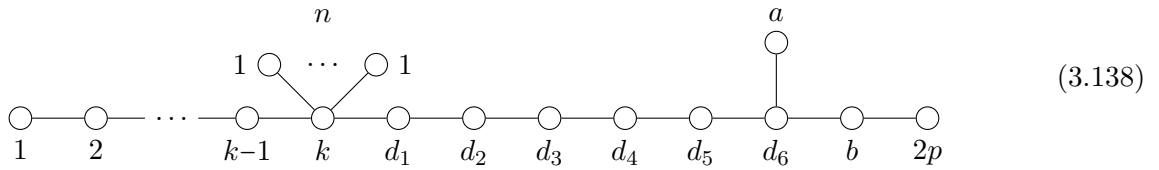

and it is apparent that one can perform p additional small E_8 instanton transitions. The possibility of p additional small instanton transition is the unsurprising indication that (3.137) is not the magnetic phase of (3.134). As before, to obtain the magnetic quiver associated to the electric quiver (3.136) one needs to reverse the p E_8 transitions. The result is readily obtained as

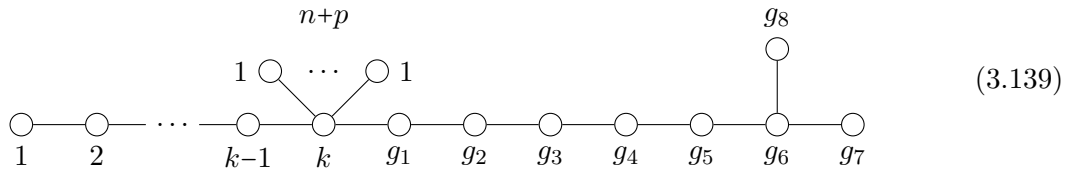

where the ranks of the unitary nodes are identical to (3.125). Note that all ranks are non-negative integer by definition of the considered case. Finally, the important result is

$$\mathcal{H}^{6d}(\text{electric quiver (3.136)}) = \mathcal{C}^{3d}(\text{magnetic quiver (3.139)}) . \quad (3.140)$$

3.6.4 $m'_3 \geq m'_4, m'_3 - m'_4 \leq 2m'_2, m'_3 \pm m'_4 = \text{odd}$

Electric quiver. Construct a Type IIA brane realisation for the linking number (3.113) and interpret $2p + 1$ as the number half NS5 branes that are stuck on the $O8^-$ orientifold. The half-integer character of the linking numbers is a consequence of the odd number of half NS5 branes on the orientifold. Then much of the analysis from (3.134) carries over, with the suitable replacement of $2p$ to $2p + 1$. (Note that $p = \frac{1}{2}(m'_3 + m'_4 - 1)$.) As a consequence, one can again remove $2p$ of the stuck half NS5 branes from the $O8^-$, but one half NS5 inevitably remains on the orientifold. This leads to the brane picture

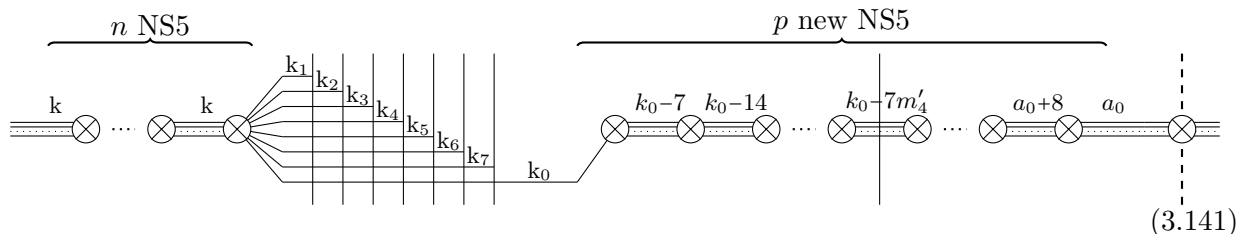

with $a_0 = 2m'_2 - (m'_3 - m'_4) + 4$. The tail of the resulting electric quiver looks as follows:

(3.142)

Magnetic quiver. Next, the brane picture (3.141) allows to change to the phase where all D6 are suspended between D8 in order to read off the magnetic quiver. The brane configuration in this phase becomes an adaptation of (3.137)

(3.143)

From the linking numbers (3.113) one computes the number of D6 to be as in (3.122). Here, the relations $k_0 = 2a + m'_3$ and $2p = m'_3 + m'_4$ allow to rearrange the D6 branes in the last two segments compared to (3.141). Hence, the magnetic quiver becomes

(3.144)

and it is apparent that one can perform p additional small E_8 instanton transitions. Reversing the p small instanton transition reveals the magnetic quiver associated to the electric quiver (3.142). A straightforward computations yields

(3.145)

and the ranks of the unitary nodes are given by (3.132). All ranks are non-negative integers by definition of the considered case. Finally, the important result is

$$\mathcal{H}^{6d}(\text{electric quiver (3.142)}) = \mathcal{C}^{3d}(\text{magnetic quiver (3.145)}) . \quad (3.146)$$

3.6.5 $m'_3 \geq m'_4, m'_3 - m'_4 \geq 2m'_2$

Electric quiver. For convenience of computing the quiver, one works with 9 D8 branes and one $O8^*$ plane. Moreover, choose the parametrisation

$$m'_3 - m'_4 - 2m'_2 \equiv 3x + l , \quad \text{for } x \in \mathbb{N}_{>0} , l \in \{0, 1, 2\} , \quad (3.147)$$

such that

$$p = m'_2 + m'_4 + x, \quad r = \frac{1}{2}(x + l). \quad (3.148)$$

Then the Type I' brane set-up becomes

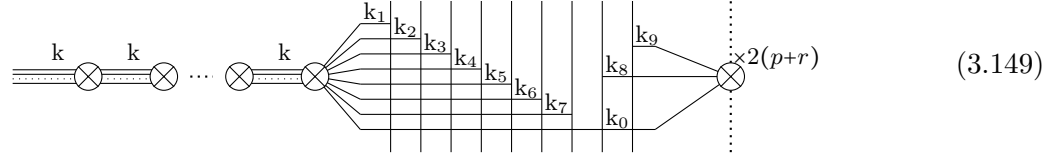

where the dotted vertical line denotes the $O8^*$ plane. From the linking numbers (3.114) one computes

$$k_9 = \lambda_7 - \lambda_9 = m'_2 + m'_4, \quad k_8 = \lambda_7 - \lambda_8 = m'_4, \quad k_7 = \lambda_7 - \lambda_7 = 0, \quad (3.150a)$$

$$k_i = \lambda_i - \lambda_7 = \sum_{j=i}^6 m_j, \quad i = 1, \dots, 6, \quad k_0 = \sum_{i=2,3,4} a'_i m'_i. \quad (3.150b)$$

As in the cases above, one can remove p pairs of half NS5 from the $O8^*$ and obtains

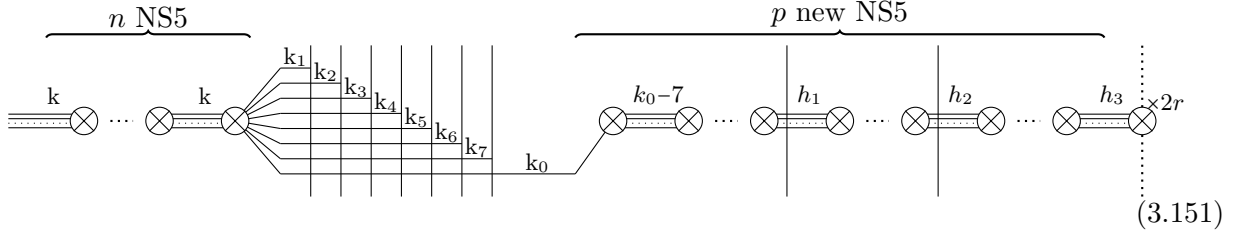

The numbers h_1, h_2, h_3 of D6 spanned between neighbouring NS5 branes can be computed to

$$h_1 = k_0 - 7k_8 = 2m'_2 + 3(m'_3 - m'_4) \geq 0, \quad (3.152a)$$

$$h_2 = h_1 - 8(k_9 - k_8) = 3(m'_3 - m'_4 - 2m'_2) = 9x + 3l \geq 0, \quad (3.152b)$$

$$h_3 = 3l. \quad (3.152c)$$

Therefore, the tail of the electric quiver looks like [28, 30]

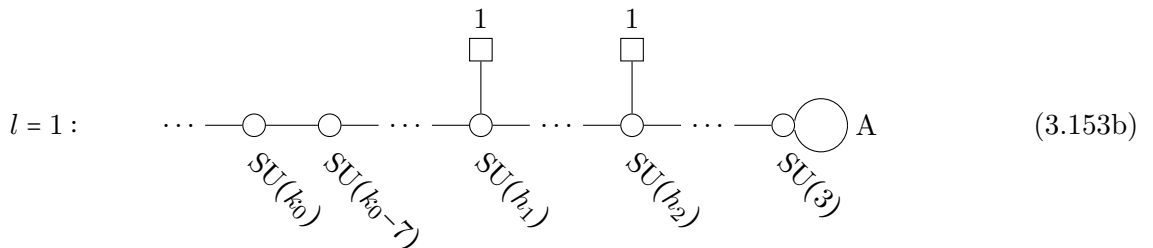
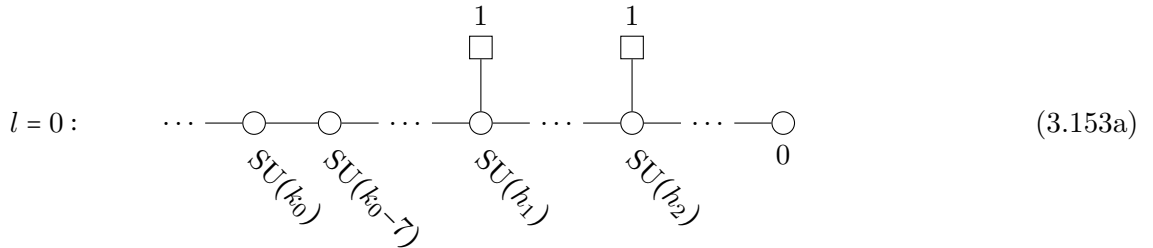

for $I \in \{A, B\}$ and with

$$d_i^A = d_i^B, \quad \forall i = 1, \dots, 6, \quad 2p^A = m'_3 + m'_4 = 2p^B, \quad (3.163a)$$

$$a^A = m'_2 + m'_3 + 2m'_4, \quad b^A = m'_2 + 2m'_3 + 2m'_4, \quad (3.163b)$$

$$a^B = m'_2 + \frac{3}{2}(m'_3 + m'_4), \quad b^B = m'_2 + \frac{3}{2}m'_3 + \frac{5}{2}m'_4. \quad (3.163c)$$

Hence, $a^B - a^A = \frac{1}{2}(m'_3 - m'_4) = b^A - b^B \geq 0$, and really only a and b do change. Similarly, the magnetic quivers (3.124) or (3.139) associated to the electric quiver read as follows:

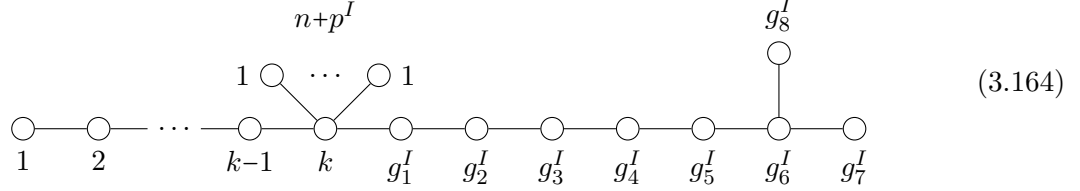

for $I \in \{A, B\}$ and with

$$g_i^A = g_i^B, \quad \forall i = 1, \dots, 6, \quad 2p^A = m'_3 + m'_4 = 2p^B, \quad (3.165a)$$

$$g_7^A = m'_2, \quad g_8^A = m'_2 + \frac{1}{2}(m'_4 - m'_3), \quad (3.165b)$$

$$g_7^B = m'_2 + \frac{1}{2}(m'_4 - m'_3), \quad g_8^B = m'_2. \quad (3.165c)$$

In this phase, the difference in the magnetic quiver is particularly visible as only the node g_7 and g_8 are interchanged.

As a remark, since the derivation has employed linear algebra, the solution found is unique. Therefore, there is a one-to-one correspondences between the theories of Section 3.6.1 and Section 3.6.3. Hence, a (physical) explanation is desirable. In [20, Sec. 5.4] two 1-parameter families of fluxes have been considered that correspond to the same electric quiver, but different magnetic quivers. The discussed cases are a subset of the general solution (3.161). According to [20, Sec. 3.3], the different resulting magnetic quivers are due to different embeddings of $SU(2N+8)$ into $USp(2N)$. In detail, the tail of the electric quivers (3.120), (3.136) is a $USp(2N)$ gauge node connected to a $SU(2N+8)$ node. A $USp(2N)$ gauge group with $2n$ half-hypers in the fundamental representation has a classically enhanced flavour symmetry of $O(2n)$, which is reduced to $SO(2n)$ by the action of the parity inside $O(2n)$. Consequently, the link (in the quiver diagram) between the $SU(2N+8)$ node and the $USp(2N)$ requires a choice of embedding $SU(2N+8) \hookrightarrow SO(4N+16)$. In other words, the choice which $\mathfrak{so}(4N+16)$ spinor node contributes to $\mathfrak{su}(2N+8)$. It follows that the two choices are related by the parity in $O(4N+16)$. The different embeddings are a manifestation of the non-trivial discrete 6d theta angle for $USp(2N)$ due to $\pi_5(USp(2N)) = \mathbb{Z}_2$, see [47].

3.7.2 Comments

Analogously, one could consider the two families of fluxes

(A) $(\{m_i\}_{i=1}^6, m'_2, m'_3, m'_4)$ such that $\lambda_1 \geq \dots \geq \lambda_7 \geq \lambda_8 > 0 > \lambda_9 \in \mathbb{Z} + \frac{1}{2}$, cf. Section 3.6.2

(B) $(\{M_i\}_{i=1}^6, M'_2, M'_3, M'_4)$ such that $\lambda'_1 \geq \dots \geq \lambda'_7 > 0 > \lambda'_8 \geq \lambda'_9 \in \mathbb{Z} + \frac{1}{2}$, cf. Section 3.6.4

such that (3.160) holds again. However, the solution to these equations

$$m_i^B = m_i^A \quad \forall i, \quad m_3^B = m_3^A, \quad m_4^B = m_4^A + \frac{1}{4}(m_3^A - m_4^A), \quad m_2^B = m_2^A - \frac{1}{2}(m_3^A - m_4^A) \quad (3.166)$$

never yields integer fluxes, as $m'_3{}^A \pm m'_4{}^A = \text{odd}$ by construction. Therefore, it is not possible to obtain the same electric quivers from both scenarios.

3.8 From finite coupling to infinite coupling

For n M5 branes with a chosen embedding $\mathbb{Z}_k \hookrightarrow E_8$, the magnetic quivers for the finite coupling phase have been derived in Section 3.6. The Higgs branches for *any* singular loci on the tensor branch can be computed straightforwardly by the techniques presented in Section 2. Generically, the number of Higgs branch phases is rather large, but one can restrict to contrasting the two extreme phases: finite coupling, i.e. generic point of the tensor branch, versus infinite coupling, i.e. origin of the tensor branch.

In Table 3, the two phases are summarised with their respective electric and magnetic description. For the weakly coupled phase, the Type IIA / Type I' brane configuration provides a conventional low-energy effective description and the Higgs branch is a classical hyper-Kähler quotient. The corresponding magnetic quiver is composed of three characteristic parts:

- (i) A tail of length k from the $\mathbb{C}^2/\mathbb{Z}_k$ ALE space.
- (ii) An affine E_8 -type Dynkin part, where the ranks are determined by the fluxes of the chosen embedding.
- (iii) A $U(1)$ -bouquet of size $(n+p)$, where n denotes the number of M5s and p is determined by the fluxes too.

In contrast, at the UV-fixed point one has the 6d SCFT with non-local contributions from tensionless strings and a Higgs branch description from this is unknown. However, the magnetic phase of the brane configuration allows to derive an magnetic quiver, whose Coulomb branch readily describes the Higgs branch at infinite coupling. In particular, the changes to the magnetic quiver are simple *additions* of $(n+p)$ affine E_8 Dynkin quivers, due to the nature of the E_8 instanton transition discussed in Section 2.4. In [20, Sec. 4.3], the magnetic quivers for the 6d SCFTs have been conjectured and the Coulomb branches have been argued to be related to the E_8 instanton moduli space on $\mathbb{C}^2/\mathbb{Z}_k$. In this paper, the magnetic quivers are *derived* quantities and the Higgs branch over every singular locus of the tensor branch can be described in this fashion.

4 Conclusion

The physics of multiple M5 branes near an M9 plane on an A -type ALE singularity $\mathbb{C}^2/\mathbb{Z}_k$ is very rich and it is encapsulated in a large family of 6-dimensional $\mathcal{N} = (1, 0)$ supersymmetric gauge theories. For a given embedding $\mathbb{Z}_k \hookrightarrow E_8$, a system of n M5 branes exhibits a multitude of phases which are connected via three principal transitions:

- (i) An M5 outside the M9 can either be on the singularity or away from it.
- (ii) Two M5s outside the M9 can be separated or coincident, which leads to discrete gauging in the 6d theory.
- (iii) An M5 can move into the M9, which is the small E_8 instanton transition.

Among the phases \mathcal{P}_i where all M5s are on the singularity, there is only one phase which admits a weakly coupled electric quiver description. This leads to a conventional 6-dimensional $\mathcal{N} = (1, 0)$ quiver gauge theory whose classical Higgs branch is a hyper-Kähler quotient. However, as put forward in Conjecture 1, there are many more Higgs branches at singular points of the tensor branch.

As demonstrated in this paper, any phase of the 6-dimensional $\mathcal{N} = (1, 0)$ theory can be systematically captured by an associated magnetic quiver. Each quiver is derived from the phase

Finite coupling: generic point on tensor branch		
electric phase	<p>→ 6d $\mathcal{N} = (1, 0)$ quiver gauge theory determined by fluxes (m_i, m'_j)</p>	$\mathcal{H}_{\text{finite}}^{6d}$ classical hK-quotient
magnetic phase	<p>$\mathcal{H}_{\text{finite}}^{6d}$ 3d $\mathcal{N} = 4$ Coulomb branch</p> <p>$\{g_1, \dots, g_8, r, p\}$ determined by fluxes (m_i, m'_j)</p>	
Infinite coupling: origin of tensor branch		
electric phase	<p>→ 6d $\mathcal{N} = (1, 0)$ SCFT determined by fluxes (m_i, m'_j)</p>	$\mathcal{H}_{\infty}^{6d} = ???$
magnetic phase	<p>$\mathcal{H}_{\infty}^{6d}$ 3d $\mathcal{N} = 4$ Coulomb branch</p> <p>$\{g_1, \dots, g_8, r, p\}$ determined by fluxes (m_i, m'_j) cf. (3.125), (3.132), or (3.158)</p>	

Table 3: Contrasting the electric and magnetic description of the Higgs branch on a generic point and the origin of the tensor branch. The diagrams are schematics for the general cases discussed in Section 3.6. A given embedding $\mathbb{Z}_k \hookrightarrow E_8$, labeled by fluxed (m_i, m'_j) determines the brane configurations and the resulting magnetic quivers.

of the Type IIA or Type I' in which all D6 branes are suspended between D8 branes. This can be understood in analogy to the magnetic quiver of the 3-dimensional $\mathcal{N} = 4$ quiver gauge theories. Consequently, it is the suspension pattern of D4 branes in the D6-D8-NS5 configuration that dictates the form of the magnetic quiver. The derivations rules for the magnetic quiver can be

summarised as in Conjecture 2. The significance of the magnetic quiver $Q(\mathcal{P}_i)$ for a phase \mathcal{P}_i is

$$\mathcal{H}^{6d}(\text{phase } \mathcal{P}_i) = \mathcal{C}^{3d}(\text{magnetic quiver } Q(\mathcal{P}_i)) \quad (4.1)$$

where the 6d Higgs branch for \mathcal{P}_i does not admit any electric quiver description in any of the strongly coupled phases. However, every Higgs branch $\mathcal{H}^{6d}(\mathcal{P}_i)$ admits a description as space of dressed monopole operators.

The magnetic quivers and their associated brane configurations provide physical explanations for effects in 6d $\mathcal{N} = (1,0)$ theories. On the one hand, the *discrete gauging* effects and their manifestation as discrete S_n -quotients on the magnetic quiver are understood by the physics of n indistinguishable $\frac{1}{2}$ BPS objects. On the other hand, the *small E_8 instanton transition* implies that an E_8 global symmetry has to arise. Given that it is notoriously difficult to generate exceptional symmetries in brane systems, it is remarkable that magnetic quivers easily accommodate for this. In particular, it provides a Type IIA brane realisation for the closure of the minimal nilpotent orbit of E_8 .

The multitude of Higgs branch phases has a structure reminiscent to Hasse diagrams of nilpotent orbit closures, due to inclusion relations as for instance shown in Section 2.6. The structure of the Hasse-type phase diagram can be analysed by transverse slices, obtained for instance by quiver subtraction [35].

Moreover, the formalism presented in this paper facilitates the understanding of Higgs branches of theories with 8 supercharges at finite and infinite gauge coupling as spaces of dressed monopole operators. The standard lore of Higgs branches with 8 supercharges being hyper-Kähler quotients only applies for finite gauge coupling. At infinite coupling the Higgs branches are no longer hyper-Kähler quotients, but can be described as hyper-Kähler spaces via Coulomb branches of 3d $\mathcal{N} = 4$ gauge theories. This provides a uniform and systematic approach to all Higgs branch phases.

Outlook. An open question remains regarding the two brane configurations (2.19) and (2.21) describing the Higgs branch after a single E_8 instanton transition. The analysis presented in here is inconclusive whether this observation hints on a new geometric feature of the small instanton transition. It might very well be that it is a simple rearrangement of the D6 branes. This should be addressed in future work.

The arguments presented allow to speculate about 4 and 5-dimensional gauge theories with 8 supercharges. In fact, starting from the D3-D5-NS5 configuration in Type IIB one may consider either of the following two settings:

- (i) One T-duality to obtain a D4-D6-NS5 configuration in Type IIA, which yields 4-dimensional $\mathcal{N} = 2$ world-volume theory. Turning to the magnetic phase where the D4 branes are suspended between the D6 branes would induce a magnetic quiver derived from the way D2 branes are suspended.
- (ii) Two T-dualities to arrive at a D5-D7-NS5 configuration of Type IIB with an 5-dimensional $\mathcal{N} = 1$ world-volume theory. Here, the magnetic phase is reached when all 5-branes are suspended between 7-branes and the magnetic quiver encodes the suspension pattern of D3 branes. This viewpoint has recently been employed in [19] for the description of 5d $\mathcal{N} = 1$ SQCD.

Again, these magnetic descriptions have multiple advantages: firstly, they are applicable even when some (or all) gauge couplings of the electric quiver are tuned to infinity. Secondly, the 4d or 5d Higgs branches at infinite gauge coupling are described as spaces of dressed monopole operators. Thirdly, the magnetic quivers allow to derive dimensions and symmetries of the Higgs branches at infinite coupling via the understanding of 3d $\mathcal{N} = 4$ Coulomb branches.

Acknowledgements. We like to express our gratitude to Costas Bachas, Antoine Bourget, Andrés Collinucci, Julius Grimminger, Babak Haghighat, Chris Hull, Rudolph Kalveks, Noppadol Mekareeya, Satoshi Nawata, Tom Rudelius, and Zhenghao Zhong for useful discussions. We thank the Galileo Galilei Institute for Theoretical Physics for the hospitality and the INFN for partial support during the initial stage of this work at the workshop “Supersymmetric Quantum Field Theories in the Non-perturbative Regime” in 2018. We thank the Simons Center for Geometry and Physics, Stony Brook University for the hospitality and the partial support during the intermediate stage of this work at the Simons Summer workshop 2018. S.C. is supported by an EPSRC DTP studentship EP/M507878/1. A.H. is supported by STFC Consolidated Grant ST/J0003533/1, and EPSRC Programme Grant EP/K034456/1. M.S. had been supported by Austrian Science Fund (FWF) grant P28590. M.S. thanks the Faculty of Physics of the University of Vienna for travel support via the “Jungwissenschaftsförderung”. The work of M.S. was supported by the National Thousand-Young-Talents Program of China. M.S. thanks the Theoretical Physics Group of Imperial College London for hospitality.

A Symmetries

A crucial consistence check is provided by checking that the symmetries and dimensions of the 6d Higgs branches and 3d Coulomb branches match. Here, the symmetries of the hyper-Kähler moduli spaces are recalled.

A.1 6d Higgs branches

The hyper multiplets transform as $\oplus_I n_I \mathcal{R}_I$ under the gauge group $\otimes_I G_I$, where n_I denotes multiplicities. The resulting flavour symmetry G_F depends on the representation \mathcal{R}_I as follows:

- (i) If \mathcal{R}_I is a complex representation, then the flavour symmetry contains a $U(n_I)$ factor.
- (ii) If \mathcal{R}_I is a real representation, then the flavour symmetry is enhanced to $USp(2n_I)$.
- (iii) If \mathcal{R}_I is a pseudoreal representation, then the flavour symmetry is enhanced to $SO(2n_I)$.

As already remarked in [22], most of the appearing $U(1)$ factors are not global symmetries in the 6d field theory as they are anomalous. Nevertheless, these $U(1)$ factors are isometries or, more generally, symmetries of the Higgs branch moduli space. Therefore, it is legitimate to use the $U(1)$ gradings along the Higgs branch.

A.2 3d Coulomb branches

If the gauge group G of a 3d $\mathcal{N} = 4$ gauge theory contains abelian factors then Coulomb branches exhibit a topological symmetry $G_J^{UV} = U(1)^{\#\{U(1) \text{ in } G\}}$. This UV symmetry may be enhanced in the IR to G_J^{IR} such that G_J^{UV} is a maximal torus of G_J^{IR} . For quiver gauge theories, the Coulomb branch symmetry can be read off from the quiver as follows

- (i) The subset of balanced gauge nodes forms the Dynkin diagram of the non-abelian part of G_J^{IR} .
- (ii) The number of unbalanced gauge nodes minus one provides the number of $U(1)$ factors inside G_J^{IR} .

Recall that a unitary gauge node is *balanced* if the number of flavours equals twice the rank. Note that in some cases the Coulomb branch symmetry read following the previous procedure might be enhanced to a bigger group G_{enh}^{IR} , such that $G_J^{IR} \subset G_{enh}^{IR}$. Hence, this procedure provides a *minimum amount of symmetry* for the Coulomb branch.

References

- [1] E. Witten, *Some comments on string dynamics*, in *Future perspectives in string theory. Proceedings, Conference, Strings'95, Los Angeles, USA, March 13-18, 1995*, pp. 501–523, 1995. [hep-th/9507121](#).
- [2] A. Strominger, *Open p -branes*, *Phys. Lett.* **B383** (1996) 44–47, [[hep-th/9512059](#)].
- [3] A. Sagnotti, *A Note on the Green-Schwarz mechanism in open string theories*, *Phys. Lett.* **B294** (1992) 196–203, [[hep-th/9210127](#)].
- [4] U. H. Danielsson, G. Ferretti, J. Kalkkinen, and P. Stjernberg, *Notes on supersymmetric gauge theories in five-dimensions and six-dimensions*, *Phys. Lett.* **B405** (1997) 265–270, [[hep-th/9703098](#)].
- [5] M. Bershadsky and C. Vafa, *Global anomalies and geometric engineering of critical theories in six-dimensions*, [hep-th/9703167](#).
- [6] A. Hanany and A. Zaffaroni, *Branes and six-dimensional supersymmetric theories*, *Nucl. Phys.* **B529** (1998) 180–206, [[hep-th/9712145](#)].
- [7] I. Brunner and A. Karch, *Branes and six-dimensional fixed points*, *Phys. Lett.* **B409** (1997) 109–116, [[hep-th/9705022](#)].
- [8] A. Hanany and A. Zaffaroni, *Chiral symmetry from type IIA branes*, *Nucl. Phys.* **B509** (1998) 145–168, [[hep-th/9706047](#)].
- [9] J. J. Heckman, D. R. Morrison, and C. Vafa, *On the Classification of 6D SCFTs and Generalized ADE Orbifolds*, *JHEP* **05** (2014) 028, [[arXiv:1312.5746](#)]. [Erratum: JHEP06,017(2015)].
- [10] J. J. Heckman, D. R. Morrison, T. Rudelius, and C. Vafa, *Atomic Classification of 6D SCFTs*, *Fortsch. Phys.* **63** (2015) 468–530, [[arXiv:1502.05405](#)].
- [11] M. Del Zotto, J. J. Heckman, A. Tomasiello, and C. Vafa, *6d Conformal Matter*, *JHEP* **02** (2015) 054, [[arXiv:1407.6359](#)].
- [12] M. B. Green, J. H. Schwarz, and P. C. West, *Anomaly Free Chiral Theories in Six-Dimensions*, *Nucl. Phys.* **B254** (1985) 327–348.
- [13] S. Randjbar-Daemi, A. Salam, E. Sezgin, and J. A. Strathdee, *An Anomaly Free Model in Six-Dimensions*, *Phys. Lett.* **151B** (1985) 351–356.
- [14] A. Dabholkar and J. Park, *An Orientifold of type IIB theory on $K3$* , *Nucl. Phys.* **B472** (1996) 207–220, [[hep-th/9602030](#)].
- [15] N. J. Hitchin, A. Karlhede, U. Lindstrom, and M. Rocek, *Hyperkahler Metrics and Supersymmetry*, *Commun. Math. Phys.* **108** (1987) 535.
- [16] M. Del Zotto and A. Hanany, *Complete Graphs, Hilbert Series, and the Higgs branch of the 4d $\mathcal{N} = 2$ (A_n, A_m) SCFTs*, *Nucl. Phys.* **B894** (2015) 439–455, [[arXiv:1403.6523](#)].
- [17] S. Cremonesi, G. Ferlito, A. Hanany, and N. Mekareeya, *Instanton Operators and the Higgs Branch at Infinite Coupling*, *JHEP* **04** (2017) 042, [[arXiv:1505.06302](#)].
- [18] G. Ferlito, A. Hanany, N. Mekareeya, and G. Zafrir, *3d Coulomb branch and 5d Higgs branch at infinite coupling*, *JHEP* **07** (2018) 061, [[arXiv:1712.06604](#)].
- [19] S. Cabrera, A. Hanany, and F. Yagi, *Tropical Geometry and Five Dimensional Higgs Branches at Infinite Coupling*, *JHEP* **01** (2019) 068, [[arXiv:1810.01379](#)].
- [20] N. Mekareeya, K. Ohmori, Y. Tachikawa, and G. Zafrir, *E_8 instantons on type-A ALE spaces and supersymmetric field theories*, *JHEP* **09** (2017) 144, [[arXiv:1707.04370](#)].
- [21] A. Hanany and N. Mekareeya, *The small E_8 instanton and the Kraft Procesi transition*, *JHEP* **07** (2018) 098, [[arXiv:1801.01129](#)].
- [22] A. Hanany and G. Zafrir, *Discrete Gauging in Six Dimensions*, *JHEP* **07** (2018) 168, [[arXiv:1804.08857](#)].
- [23] N. Mekareeya, K. Ohmori, H. Shimizu, and A. Tomasiello, *Small instanton transitions for $M5$ fractions*, *JHEP* **10** (2017) 055, [[arXiv:1707.05785](#)].
- [24] O. J. Ganor and A. Hanany, *Small $E(8)$ instantons and tensionless noncritical strings*, *Nucl. Phys.* **B474** (1996) 122–140, [[hep-th/9602120](#)].
- [25] N. Seiberg and E. Witten, *Comments on string dynamics in six-dimensions*, *Nucl. Phys.* **B471** (1996) 121–134, [[hep-th/9603003](#)].
- [26] K. A. Intriligator, *RG fixed points in six-dimensions via branes at orbifold singularities*, *Nucl. Phys.* **B496** (1997) 177–190, [[hep-th/9702038](#)].
- [27] J. D. Blum and K. A. Intriligator, *New phases of string theory and 6-D RG fixed points via branes at orbifold singularities*, *Nucl. Phys.* **B506** (1997) 199–222, [[hep-th/9705044](#)].

- [28] G. Zafrir, *Brane webs, 5d gauge theories and 6d $\mathcal{N} = (1, 0)$ SCFT's*, *JHEP* **12** (2015) 157, [[arXiv:1509.02016](#)].
- [29] K. Ohmori and H. Shimizu, *S^1/T^2 compactifications of 6d $\mathcal{N} = (1, 0)$ theories and brane webs*, *JHEP* **03** (2016) 024, [[arXiv:1509.03195](#)].
- [30] H. Hayashi, S.-S. Kim, K. Lee, and F. Yagi, *6d SCFTs, 5d Dualities and Tao Web Diagrams*, [arXiv:1509.03300](#).
- [31] A. Hanany and E. Witten, *Type IIB superstrings, BPS monopoles, and three-dimensional gauge dynamics*, *Nucl. Phys.* **B492** (1997) 152–190, [[hep-th/9611230](#)].
- [32] S. Cremonesi, A. Hanany, and A. Zaffaroni, *Monopole operators and Hilbert series of Coulomb branches of 3d $\mathcal{N} = 4$ gauge theories*, *JHEP* **01** (2014) 005, [[arXiv:1309.2657](#)].
- [33] S. Cabrera and A. Hanany, *Branes and the Kraft-Procesi Transition*, *JHEP* **11** (2016) 175, [[arXiv:1609.07798](#)].
- [34] S. Cabrera and A. Hanany, *Branes and the Kraft-Procesi transition: classical case*, *JHEP* **04** (2018) 127, [[arXiv:1711.02378](#)].
- [35] S. Cabrera and A. Hanany, *Quiver Subtractions*, *JHEP* **09** (2018) 008, [[arXiv:1803.11205](#)].
- [36] A. Hanany and M. Sperling, *Discrete quotients of 3-dimensional $\mathcal{N} = 4$ Coulomb branches via the cycle index*, *JHEP* **08** (2018) 157, [[arXiv:1807.02784](#)].
- [37] A. Hanany and A. Zajac, *Discrete Gauging in Coulomb branches of Three Dimensional $\mathcal{N} = 4$ Supersymmetric Gauge Theories*, *JHEP* **08** (2018) 158, [[arXiv:1807.03221](#)].
- [38] A. Kapustin and M. J. Strassler, *On mirror symmetry in three-dimensional Abelian gauge theories*, *JHEP* **04** (1999) 021, [[hep-th/9902033](#)].
- [39] A. Beauville, *Symplectic singularities*, *Invent. Math.* **139** (2000), no. 3 541–549, [[math/9903070](#)].
- [40] A. Dancer, F. Kirwan, and A. Swann, *Implosion for hyperkahler manifolds*, [arXiv:1209.1578](#).
- [41] N. Seiberg and E. Witten, *Monopoles, duality and chiral symmetry breaking in $N=2$ supersymmetric QCD*, *Nucl. Phys.* **B431** (1994) 484–550, [[hep-th/9408099](#)].
- [42] G. Ferlito and A. Hanany, *A tale of two cones: the Higgs Branch of $Sp(n)$ theories with $2n$ flavours*, [arXiv:1609.06724](#).
- [43] V. Kac, *Infinite-Dimensional Lie Algebras*. Progress in mathematics. Cambridge University Press, 1994.
- [44] D. R. Morrison and N. Seiberg, *Extremal transitions and five-dimensional supersymmetric field theories*, *Nucl. Phys.* **B483** (1997) 229–247, [[hep-th/9609070](#)].
- [45] M. R. Douglas, S. H. Katz, and C. Vafa, *Small instantons, Del Pezzo surfaces and type I-prime theory*, *Nucl. Phys.* **B497** (1997) 155–172, [[hep-th/9609071](#)].
- [46] E. Gorbatov, V. S. Kaplunovsky, J. Sonnenschein, S. Theisen, and S. Yankielowicz, *On heterotic orbifolds, M theory and type I-prime brane engineering*, *JHEP* **05** (2002) 015, [[hep-th/0108135](#)].
- [47] R. Bott, *The stable homotopy of the classical groups*, *Ann. of Math. (2)* **70** (1959) 313–337.