

# Convex geometries representable by at most 5 circles on the plane

Polly Mathews Jr.\*

November 30, 2021

## Abstract

A convex geometry is a closure system satisfying the anti-exchange property. In this work we document all convex geometries on 4- and 5-element base sets with respect to their representation by circles on the plane. All 34 non-isomorphic geometries on a 4-element set can be represented by circles, and of 672 known geometries on a 5-element set, we made representations of 623. Of the 49 remaining geometries on a 5-element set, one was already shown not to be representable due to the Weak Carousel property, as articulated by Adaricheva and Bolat (Discrete Mathematics, 2019). In this paper we show that 7 more of these convex geometries cannot be represented by circles on the plane, due to what we term the *Triangle Property*.

## Contents

<b>1</b>	<b>Introduction</b>	<b>2</b>
<b>2</b>	<b>Preliminaries</b>	<b>4</b>
2.1	Basic Definitions . . . . .	4
2.2	Convex Dimension . . . . .	5
2.3	Convex hull operator . . . . .	6
<b>3</b>	<b>Creating the list of geometries on 4- and 5-element sets</b>	<b>7</b>

---

\*This work was done as part of *PolyMath REU-2020* program. Team mentor: Kira Adaricheva (Hofstra University). Graduate assistants: Madina Bolat (alumna UIUC), Gent Gjonbalaj (Tufts University). Team members: Brandon Amerine (Western Oregon University), J. Alexandria Behne (Texas A&M University), Evan Daisy (Amherst College), Fernanda Yopez-Lopez (University of Virginia), Alexander Frederiksen (University of Central Florida), Ayush Garg (IIT Delhi), Zachary King (University of Central Oklahoma), Grace Ma (University of Notre Dame), Michelle Olson (California State University, Fullerton), Rohit Pai (NYU), Junewoo Park (Brown University), Cat Raanes (University of British Columbia), Joseph Rogge (UIUC), Raviv Sarch (University of Michigan, Ann Arbor), Sean Riedel (University of California, Santa Cruz), Stephanie Zhou (Rutgers University), James Thompson (UNC-Chapel Hill).

<b>4</b>	<b>Representing the list</b>	<b>9</b>
4.1	Representation of geometries on 5-element set based on representations on 4-element or 3-element set . . . . .	10
4.2	Checking correctness of representations . . . . .	10
4.3	GeoGebra as a toolkit for representations . . . . .	11
4.4	Google Colab toolkit . . . . .	12
<b>5</b>	<b>Triangle Property and Impossible geometries</b>	<b>12</b>
5.1	Tight implication on circles . . . . .	12
5.2	Triangle Property . . . . .	14
<b>6</b>	<b>Acknowledgments.</b>	<b>16</b>
	<b>Appendices</b>	<b>19</b>
<b>A</b>		<b>19</b>
A.1	Description of size 4 geometries . . . . .	19
A.2	Description of size 5 geometries . . . . .	25
<b>B</b>		<b>172</b>
B.1	Representation of size 4 geometries . . . . .	172
B.2	Representation of size 5 geometries . . . . .	183
B.3	Impossible Geometries . . . . .	446

## 1 Introduction

In this project we address the problem raised in Adaricheva and Bolat [1]: whether all geometries with convex dimension at most 5 are representable by circles on the plane using the closure operator of convex hull for circles.

An early survey on the topic of convex geometries is given by Edelman and Jamison [8], and the theory of infinite convex geometries is developed in Adaricheva, Gorbunov, Tumanov [2]. A recent survey on the topic, which includes both finite and infinite convex geometries, is in a chapter of *Lattice Theory: Special Topics and Applications* (2016), by Adaricheva and Nation [3].

The representation of finite convex geometries by circles is introduced by G. Czedli in [7], where the usual convex hull closure operator acting on sets of points is generalized to the convex hull operator acting on circles. Moreover, he proves that every finite convex geometry of convex dimension 2 can be represented by circles on the plane.

The natural question of whether a finite convex geometry of any convex dimension can be represented by circles on the plane is answered in [1] *in the negative*: it turns out that the convex hull operator acting on circles in the plane satisfies a condition called the  $2 \times 3$ -*Weak carousel property* - and not all finite convex geometries satisfy it. An example of a geometry with a convex dimension of 6 that does not satisfy this condition is found on a 5-element set.

This left the question of whether any convex geometry on an at most 5-element set, with convex dimension at most 5, could be represented by circles on the plane.

The goal of the project was to document all existing convex geometries on 4- and 5-element sets, to represent them by circles (when possible), and to describe the features of “impossible” geometries.

After generating a list of geometries on 4- and 5-element sets, we found representations of all 34 discovered non-isomorphic geometries on 4-element sets and all 623 discovered geometries on 5-element sets. However, 49 of the 672 generated geometries on a 5-element set resisted representation by circles.

Geometry G4 from the list of 672 non-isomorphic geometries on a 5-element set is the “impossible” geometry shown not to be representable in [1]. In this paper we prove that 7 more geometries from the list of 672 are not representable. The proof is based on the Triangle Property (Lemma 5 in section 5).

Three geometries from this new set of “impossible” geometries have a convex dimension of 4, and one has a convex dimension of 5. **This provides a solution to Problem 1 in [1] since geometries not representable by circles exist with those convex dimensions.**

On the other hand, all geometries on 4- and 5-element sets with convex dimension 3 are representable by circles. Thus, the following question remains:

**Question 1.** *Does there exist a convex geometry of convex dimension 3 not representable by circles on the plane?*

The paper is organized as follows. We provide all necessary definitions related to convex geometries in section 2. In particular the parameter of *convex dimension* is explained in detail. Section 3 provides the background for the algorithm generating all non-isomorphic geometries (anti-matroids) on  $n$ -element set, for values of  $n$  up to 7. The algorithm was developed around 2013, in the framework of enumerating anti-matroids in the On-line Encyclopedia of Integer Sequences (OEIS). The existing code was enhanced to additionally compute the *implicational basis* of each geometry and its convex dimension. Sections 4 and 4.1 are devoted to methods for representing geometries by circles. Some basic principles of verifying representations are discussed in section 4.2. Sections 4.3 and 4.4 provide an overview of different software available for enhancing this area of mathematical work, in our case a GeoGebra and Google Colab toolkit. Finally, section 5 gives the proof of the Triangle Property, and its consequences for a subset of “impossible” geometries not representable by circles.

We provide two sets of appendices: in Appendix A there is a list of 34 geometries on 4-element set, and a list of 672 geometries on 5-element set, given by their alignments (convex sets), as well as sets of implications representing the associated closure operator. The meet-irreducible elements of alignments are provided, together with their maximal anti-chains, which allows the computation of each geometry’s convex dimension.

Appendix B has representations by circles for all 34 discovered geometries on a 4-element set, as well as 623 geometries on a 5-element set. The numbering corresponds to the order of geometries in the lists featured in Appendix A.

The last part of Appendix B lists 49 geometries which are either cannot be represented or not yet represented, giving their implicational bases, also featured in Appendix A. The list of these geometries is as follows:

$G4, G7, G11, G12, G14, G15, G18, G21, G23, G26, G27, G33, G34, G35, G39, G43,$   
 $G45, G46, G47, G49, G54, G56, G57, G60, G69, G70, G74, G84, G87, G89, G94,$   
 $G95, G96, G105, G114, G115, G122, G129, G132, G134, G143, G147, G153,$   
 $G161, G175, G206, G211, G235, G351.$

Among these 49 geometries, we show in this paper that the following are not representable by circles:

$G7, G11, G12, G18, G21, G23, G34.$

Excluding these 7 geometries, as well as earlier example  $G4$  which cannot be represented, we ask:

**Question 2.** *Are the 41 remaining geometries on the list above representable by circles on the plane?*

## 2 Preliminaries

### 2.1 Basic Definitions

A convex geometry is a special case of a closure system. It can be defined through a closure operator, or through an alignment.

**Definition 2.1.** *Let  $X$  be a set. A mapping  $\varphi: 2^X \rightarrow 2^X$  is called a closure operator, if for all  $Y, Z \in 2^X$ :*

1.  $Y \subseteq \varphi(Y)$
2. if  $Y \subseteq Z$  then  $\varphi(Y) \subseteq \varphi(Z)$
3.  $\varphi(\varphi(Y)) = \varphi(Y)$

*A subset  $Y \subseteq X$  is closed if  $\varphi(Y) = Y$ . The pair  $(X, \varphi)$ , where  $\varphi$  is a closure operator, is called a closure system.*

**Definition 2.2.** *Given any (finite) set  $X$ , an alignment on  $X$  is a family  $\mathcal{F}$  of subsets of  $X$  which satisfies two properties:*

1.  $X \in \mathcal{F}$
2. If  $Y, Z \in \mathcal{F}$  then  $Y \cap Z \in \mathcal{F}$ .

Closure systems are dual to alignments in the following sense:

If  $(X, \varphi)$  is a closure system, one can define a family of closed sets  $\mathcal{F} := \{Y \subseteq X : \varphi(Y) = Y\}$ . Then  $\mathcal{F}$  is an alignment.

If  $\mathcal{F}$  is an alignment, then define  $\varphi: 2^X \rightarrow 2^X$  in the following manner: for all  $Y \subseteq X$ , let  $\varphi(Y) := \bigcap \{Z \in \mathcal{F} : Y \subseteq Z\}$ . Then  $(X, \varphi)$  is a closure system.

**Definition 2.3.** A closure system  $(X, \varphi)$  is called a convex geometry if

1.  $\varphi(\emptyset) = \emptyset$
2. For any closed set  $Y \subseteq X$  and any distinct points  $x, y \in X \setminus Y$ , if  $x \in \varphi(Y \cup \{y\})$  then  $y \notin \varphi(Y \cup \{x\})$ .

The second property in this definition is called the *Anti-Exchange Property*. We can use duality between closure operators and alignments to provide another definition of a convex geometry.

**Definition 2.4.** A closure system  $(X, \varphi)$  is a convex geometry iff the corresponding alignment  $\mathcal{F}$  satisfies the following two properties:

1.  $\emptyset \in \mathcal{F}$
2. If  $Y \in \mathcal{F}$  and  $Y \neq X$  then  $\exists a \in X \setminus Y$  s.t.  $Y \cup \{a\} \in \mathcal{F}$ .

## 2.2 Convex Dimension

This section follows the survey on convex geometries by Edelman and Jamison [8].

**Definition 2.5.** An alignment  $\mathcal{F}$  is called a monotone alignment if the sets of  $\mathcal{F}$  form a chain under the inclusion order.

**Definition 2.6.** Given two alignments  $\mathcal{F}, \mathcal{K}$ , their join  $\mathcal{F} \vee \mathcal{K}$  is defined to be the smallest alignment that contains both  $\mathcal{F}$  and  $\mathcal{K}$ . Explicitly, for alignments on finite set  $X$ , this is the collection of all intersections of sets taken from  $\mathcal{F}, \mathcal{K}$ :  $\mathcal{F} \vee \mathcal{K} = \{F \cap K : F \in \mathcal{F} \text{ and } K \in \mathcal{K}\}$ .

A known result in [8] about joins follows.

**Theorem 2.1.** Every alignment can be expressed as the join of some collection of monotone alignments on the same base set.

This motivates the following definition.

**Definition 2.7.** The convex dimension of a convex geometry  $G$  is the least number  $k$  such that the alignment  $\mathcal{F}$  corresponding to  $G$  can be expressed as the join of  $k$  monotone alignments.

To compute the convex dimension of a convex geometry, we can examine antichains of meet-irreducibles.

**Definition 2.8.** A meet-irreducible in an alignment  $\mathcal{F}$  is a closed set  $Y \in \mathcal{F}$  for which there exists  $Z \in \mathcal{F}$  such that

1.  $Y \subset Z$
2. If  $Y \subset W$ , for some closed set  $W$ , then  $Z \subseteq W$ .

This is equivalent to saying that if  $Y = \bigcap_{i \in I} Y_i$  where  $Y_i \in \mathcal{F}$  for all  $i$ , then  $Y = Y_i$  for some  $i \in I$ .

Note that by definition 2.4 of a convex geometry, we can additionally claim that  $|Z \setminus Y| = 1$ .

**Definition 2.9.** *In a partially ordered set, an antichain is a collection of pairwise non-comparable elements.*

Set inclusion forms a partial order on the elements of an alignment, and this partial order allows us to talk about antichains of elements of an alignment. The following result is due to Edelman and Saks [9].

**Theorem 2.2.** *Let  $G$  be a convex geometry and  $\mathcal{F}$  be the corresponding alignment. The convex dimension of  $G$  is equal to the largest size antichain of meet-irreducibles in  $\mathcal{F}$ .*

### 2.3 Convex hull operator

A particular example of a closure operator on a set is the convex hull operator, where the base set  $X$  is a set of points in Euclidean space  $\mathbb{R}^n$ . For the goals of this paper we use only the plane, i.e. the space  $\mathbb{R}^2$ .

**Definition 2.10.** *A set  $S$  in  $\mathbb{R}^2$  is called convex if for any two points  $p, q \in S$ , the line segment connecting  $p$  and  $q$  is also contained in  $S$ .*

See figure below for an illustration.

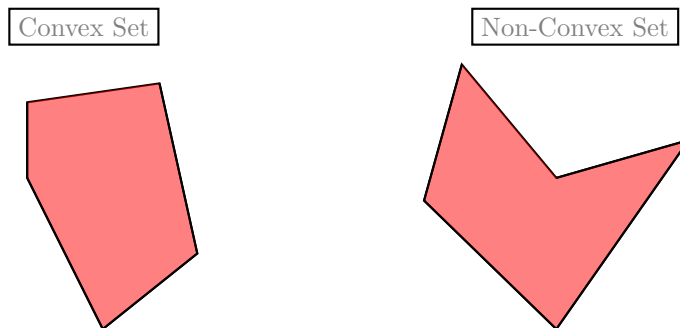

Figure 1: Example of a set which is convex and a set which is not convex.

**Definition 2.11.** *Given set  $S$  of points in  $\mathbb{R}^2$ , the convex hull of  $S$ , in notation  $\text{CH}(S)$ , is the intersection of all convex sets in  $\mathbb{R}^2$  which contain  $S$ .*

From the illustration, if  $S = \{A, B, C, D, E, F, G\}$ , a set of of 7 points on the plane,  $\text{CH}(S)$  is a convex shape with vertices  $A, C, D, F, G$  in Figure 2.

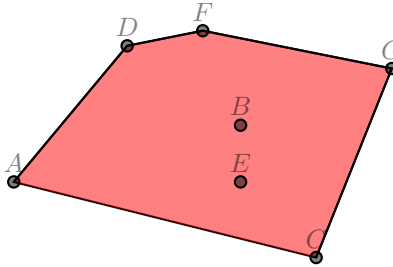

Figure 2: The convex hull  $\text{CH}(ABCDEFG)$

The following definition allows us to introduce a closure operator induced by the convex hull, on any set of points  $X$  on the plane.

**Definition 2.12.** *Let  $X$  be a finite set of points in  $\mathbb{R}^2$ . Define an operator  $\text{ch} : 2^X \rightarrow 2^X$  as follows:*

$$\text{ch}(Y) = \text{CH}(Y) \cap X,$$

for any  $Y \in 2^X$ .

It is straightforward to check that  $\text{ch}$  is a closure operator. For example,  $\text{ch}(ACDFG) = S$  in Figure 2. Moreover,  $\text{ch}$  satisfies the Anti-Exchange Property. Therefore,  $(X, \text{ch})$  is a convex geometry.

Finally, for the purposes of the current paper we want to recall the definition of the convex hull operator for circles introduced in Czédli [7].

If  $x$  is a circle on the plane, then by  $\tilde{x}$  we denote a set of points belonging to  $x$ . We allow a circle to have a radius 0, in which case it is a point.

**Definition 2.13.** *Let  $X$  be a finite set of circles in  $\mathbb{R}^2$ . Define the operator  $\text{ch}_c : 2^X \rightarrow 2^X$ , a convex hull operator for circles, as follows:*

$$\text{ch}_c(Y) = \{x \in X : \tilde{x} \subseteq \text{CH}(\bigcup_{y \in Y} \tilde{y})\},$$

for any  $Y \in 2^X$ .

For example,  $a, e \in \text{ch}_c(b, c, d)$  on Figure 3a, while  $a \notin \text{ch}_c(b, c, d)$ ,  $e \in \text{ch}_c(b, c, d)$  in Figure 3b.

### 3 Creating the list of geometries on 4- and 5-element sets

Our description of convex geometries represented by 4 or 5 circles on the plane relies on the OEIS [13] (On-line Encyclopedia of Integer Sequences) submission on the number of non-isomorphic antimatroids by Przemysław Uznański [11].

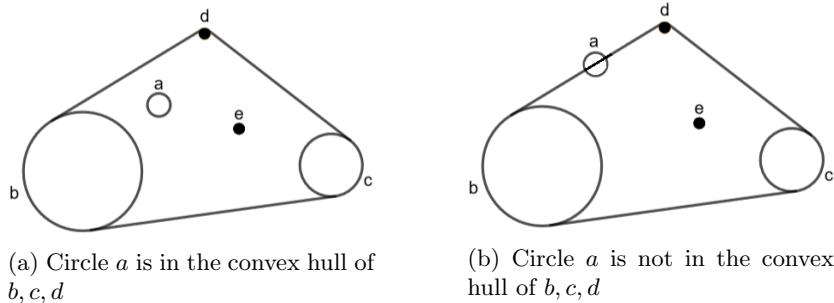

Figure 3: Examples of convex hulls

From a combinatorial point of view, a family  $\mathcal{F}$  of subsets of (finite)  $X$  is called an *antimatroid* if and only if:

1.  $\mathcal{F}$  is closed under unions, i.e.  $\forall Z, Y \in \mathcal{F}, Z \cup Y \in \mathcal{F}$
2.  $\mathcal{F}$  is non-empty accessible, i.e.  $\forall Y \in \mathcal{F}$  either  $Y = \emptyset$  or  $\exists x \in Y$  such that  $Y \setminus x \in \mathcal{F}$ .

A close look at the properties reveals that there exists a bijective map  $f$ , between antimatroids and convex geometries given by:

$$f(\mathcal{F}) = \{Y^c : Y \in \mathcal{F}\} \quad (1)$$

Here  $Y^c = X \setminus Y$ , the set-theoretic complement of the subset  $Y \subseteq X$ .

Uznański in [11] generated a list of all non-isomorphic antimatroids on base sets of order 3, 4, 5 and 6 using an extension property on antimatroids combined with a reverse tree traversal algorithm. The theoretical background of the algorithm was developed in Kempner and Levit [10].

Adapting Uznański's original codebase, all convex geometries can be easily generated using the bijection noted above. The antimatroids and their corresponding geometries are represented as elements of  $2^{2^X}$  using their associated alignments as described by Definition 2.2. For efficiency and portability however, the alignments are physically stored, and listed in the Appendices A1 and A2, as 32-bit integers through a programming technique known as *bitmasking* [14].

Given a 32-bit representation  $b_{31}b_{30} \dots b_1b_0$  and  $X = \{x_1 \dots x_n\}$  where  $n = 3, 4, 5$ , one may obtain the convex sets,  $F$ , by writing  $S = \{i : b_i = 1\}$ . Each convex set  $F_k$  is then given by

$$F_k = \{x_i : c_i = 1, c_5 \dots c_1 = S_k \in S\} \quad (2)$$

where  $c_i$  are the bits of  $S_k$ .

**Example 1.**



For a base set of order 3, represented as  $\{a, b, c\}$ , assign the zeroth, first and second bits to  $a, b$  and  $c$  respectively. Then  $\{a\}$  is represented as 001(1),  $\{b\}$  is represented as 010(2),  $\{a, b, c\}$  is represented as 111(7),  $\emptyset$  as 000(0) and so on. It is easy to check that the decimal equivalents of the binary representation of subsets form the set  $\{0, 1, 2 \dots 2^n - 1\}$  where  $n$  is the order of the base set. A family  $F$  has its  $n^{\text{th}}$  bit set (value 1), if and only if the subset is represented by  $n \in F$ .

**Example 2.**

For example, for a base set of order 3, the family  $F = \{\emptyset, \{a\}, \{a, b\}, \{a, b, c\}\}$  is represented as 10001011(139) because  $\emptyset \rightarrow 0, \{a\} \rightarrow 1, \{a, b\} \rightarrow 3, \{a, b, c\} \rightarrow 7$ , and hence the zeroth, first, third and seventh bits are set.

A useful perspective on a convex geometry is provided by its *implications*. Given a convex geometry  $(X, \varphi)$  with alignment  $\mathcal{F}$ , and ordered pair  $(A, B)$ , where  $A, B \in 2^X$ , also denoted  $A \rightarrow B$ , is an implication if:

$$B \subseteq \varphi(A) = \bigcap \{Y : A \subseteq Y, Y \in F\} \tag{3}$$

A set of implications fully defining closure operator  $\varphi$  is often referred to as *implicational basis* of a closure system. The recent exposition on implicational bases is given in Adaricheva and Nation [4].

Because implications are very useful for representing geometries, they were generated for each geometry in addition to its convex sets. However, some implications are redundant with respect to others. For example,  $ab \rightarrow c$  is redundant if  $a \rightarrow c$ . Hence work was also done in attempt to remove such redundancies.

In practice we only removed pairwise redundancies, but an *optimum* implication list could be found using a brute force approach (however, the problem of finding such an optimum implication list for general closure system is NP-hard, see [6, 12]). The pairwise reduction was achieved by declaring implication  $A \rightarrow B$  redundant if there exists an implication  $C \rightarrow D$  such that  $C \subseteq A$  and  $B \subseteq D$ .

To obtain a list of only convex geometries with convex dimension less than or equal to 5, as per Problem 1 in [1], calculation of each geometry’s dimension was also necessary. As described in Section 2.2, one may compute convex dimension by starting with the meet-irreducible convex sets, which can be identified by the convex sets  $Y$  that have only one convex superset  $Z$  such that  $|Z \setminus Y| = 1$ . From there, one can build a maximal antichain of said irreducibles using recursive techniques. And by Theorem 2.2, the convex dimension is the cardinality of this maximal antichain.

## 4 Representing the list

The methods described in section 3 were used to generate 34 distinct geometries on a set of 4 elements and 672 distinct geometries on a set of 5 elements. As

described in that section, a convex geometry on  $n$  elements can be represented by  $n$  circles on the plane, with implication corresponding to containment within convex hulls, see more details in subsection 4.2. We are interested in the representability of each of the geometries one generates in this manner. To wit, we want to establish for each of the 34 4-element geometries a representation using 4 circles on the plane; similarly, we want to establish for each of 672 5-element geometries a representation using 5 circles on the plane.

Representations of all 34 4-element geometries are presented in Appendix B1. However, we found that some of the 5-element geometries resisted representation. In particular, of 672 geometries generated, we constructed 623 accurate representations, which are given in Appendix B2. Additionally, 7 of the remaining geometries we found to be provably non-representable.

In this section we address the techniques used to produce representations in Appendices B1-2.

#### 4.1 Representation of geometries on 5-element set based on representations on 4-element or 3-element set

In the process of representing the 672 geometries on a 5-element base set, we found that the representations of those with a unique atom ( $a, b, c, d$ , or  $e$ ) and those with a unique coatom ( $abcd, abce, abde$ , or  $bcde$ ) could be generated using our existing representations of geometries on a 4-element base set. The former were generated by creating a non-empty intersection between the four elements and representing the fifth element with a point contained in this intersection, and the latter by representing the fifth element with a circle that completely contained the other four elements. We used a coded search function to generate lists of geometries with a unique atom and a unique coatom from our master list, to facilitate the identification of the representations we created.

We generated other groups of 5-element representations by doubling circles in the 4-element representations and slightly off-setting them, or by placing a fifth element in just one of the existing four. To identify these representations in the master list, a program was created to search for geometries isomorphic to the input.

#### 4.2 Checking correctness of representations

In this section we describe the method of checking that a convex geometry given by its implications, as in Appendices A1-2, is isomorphic to a geometry represented by circles on the plane.

We recall from section 3 that a closure operator  $\varphi$  can be recorded in the set  $\Sigma$  of implications, where  $Y \rightarrow Z$  means  $Z \subseteq \varphi(Y)$ . Then the corresponding alignment of  $\varphi$ -closed sets comprises all subsets of  $X$  that *respect* all implications in  $\Sigma$ : if  $(Y \rightarrow Z) \in \Sigma$  and  $Y \subseteq W$  for set  $W$  in alignment, this would imply  $Z \subseteq W$ .

Convex geometries on our list were given by both an alignment  $\mathcal{F}$  on set  $X$  and a set of implications  $\Sigma$ . In order to produce a representation by circles,

each element of  $X$  was represented by a circle, and the positioning of circles in the plane would define a closure operator  $ch_c$ , the convex hull operator for circles. A geometry generated by these circles would be isomorphic to  $(X, \mathcal{F})$  if the alignments match, i.e., if the alignment  $\mathcal{G}$  generated by  $ch_c$  consists of the same subsets as  $\mathcal{F}$ . The following two statements formed the basis for such matching.

**Proposition 4.1.** *Let  $(X, \mathcal{F})$  be an alignment defined by a set of implications  $\Sigma$ . Let  $\psi$  be any closure operator defined on  $X$  and the corresponding alignment of  $\psi$ -closed sets be  $\mathcal{G}$ . If for every  $(Y \rightarrow Z) \in \Sigma$  one has  $Z \subseteq \psi(Y)$ , then  $\mathcal{G} \subseteq \mathcal{F}$ .*

*Proof.* Indeed, take any set  $W \in \mathcal{G}$ . We need to show that  $W \in \mathcal{F}$ , i.e., it respects all implications from  $\Sigma$ . So take  $Y \rightarrow Z$  in  $\Sigma$  and let  $Y \subseteq W$ . Since by assumption we have  $Z \subseteq \psi(Y)$ , and  $W$  is  $\psi$ -closed, we have  $Z \subseteq W$  as desired.  $\square$

Concretely, we would check that for each implication  $Y \rightarrow Z$  from the set of implications defining the given convex geometry, all circles in  $Z$  are in the convex hull of circles from  $Y$ .

**Proposition 4.2.** *If all meet-irreducible sets from alignment  $\mathcal{F}$  belong to  $\mathcal{G}$ , then  $\mathcal{F} \subseteq \mathcal{G}$ .*

*Proof.* Indeed, every set in  $\mathcal{F}$  is the intersection of meet-irreducible sets. Therefore, they all belong to  $\mathcal{G}$ .  $\square$

In practice, we would check that all circles belonging to the meet-irreducible set of a given convex geometry form a convex set of circles. Combining the two practical procedures following from the propositions above, we could conclude that the given convex geometry is isomorphic to our convex geometry of circles.

### 4.3 GeoGebra as a toolkit for representations

At the beginning of our work, creating a representation for a geometry entailed drawing out the circles by hand, and then manually representing the drawing in LaTeX. One had to take care to preserve the convex hulls as precisely as possible and not generate unwanted implications.

This became especially cumbersome on certain geometries that were possible but required a very precarious setup, where even the slightest shift in the position of a circle would make the representation incorrect. We started using the software GeoGebra as a tool for representing Geometries, which allowed for the easy rearrangement of circles and points to one's liking. Eventually we came up with a template GeoGebra file [15] that allowed users to adjust not only the position and radii of the circles, but also to draw the convex hulls of all possible combinations of circles. This made it easier to check if a representation was actually correct or not.

Using GeoGebra helped in checking if a representation of a geometry was correct, but once represented, they still had to be remade in  $\text{\LaTeX}$  using the TikZ package. It was soon discovered that GeoGebra had a built in way to export images to TikZ code, and we utilized and enhanced this code to generate the desired representation.

#### 4.4 Google Colab toolkit

In order to streamline the process of exporting representations of geometries to  $\text{\LaTeX}$ , we generated a Python script to automatically generate TikZ code to transfer to  $\text{\LaTeX}$ . The centers and radii of the circles were shown in GeoGebra, so the user only had to copy those numbers into the script.

Simultaneously, we created another script in a Google Colab notebook that would parse through the TikZ code generated by GeoGebra, extract all of the necessary information (such as circle location and radii) and then output useable TikZ code. This new code, however, had issues with normalizing the size of the circles to fit nicely on the page, and so features of both scripts were combined in the Google Colab notebook. The end result was code that would accept a text file from GeoGebra and reliably output useable TikZ code for  $\text{\LaTeX}$ [16].

### 5 Triangle Property and Impossible geometries

In this section we will be proving that several geometries on a 5 element set are not representable by circles on the plane.

#### 5.1 Tight implication on circles

The following statement is a modification of Lemma 5.1 in [1].

**Lemma 1.** *Let  $a, b, c$  be three circles on the plane, where none is inside another. Then there are three different types of configurations of three circles  $a, b, c$ , up to re-labeling:*

- (1)  $\tilde{b} \subseteq \text{CH}(\tilde{a} \cup \tilde{c})$ ;
- (2)  $\text{CH}(\tilde{a} \cup \tilde{b} \cup \tilde{c}) = \text{CH}(\tilde{a} \cup \tilde{b}) \cup \text{CH}(\tilde{b} \cup \tilde{c})$  as in Figures 4 or 5;
- (3)  $\text{CH}(\tilde{a} \cup \tilde{b} \cup \tilde{c})$  is inscribed into a triangle as in Figure 6, or forms a shape as in Figure 7.

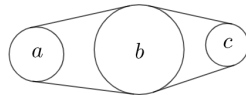

Figure 4

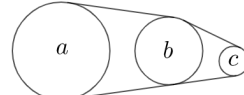

Figure 5

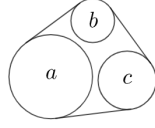

Figure 6

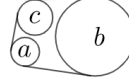

Figure 7

We want to reformulate this classification of three circle configurations in the terms of the boundaries of convex hulls. This allows to avoid an overlap between cases (2) and (3) of Lemma 1.

**Lemma 2.** *The boundary of  $\text{CH}(\tilde{a} \cup \tilde{b} \cup \tilde{c})$  for any three circles  $a, b, c$ , none of which includes another, comprises*

- (I) two tangent segments and two arcs of circles, when configuration (1) from Lemma 1 occurs;
- (II) four tangent segments and four arcs, as in Figure 4 or 5, for most configurations in (2) from Lemma 1;
- (III) three tangent segments and three arcs, as in Figure 6 and Figure 7, for configurations in (3) from Lemma 1, or, in an extreme case of configuration (2).

*Proof.* Case (1) is distinguished from others by the property that one of circles does not have an arc on the boundary of  $\text{CH}(\tilde{a} \cup \tilde{b} \cup \tilde{c})$ .

In case (2) one of the circles crosses both outer tangent lines of two other circles and has two points of intersection with each of those tangent lines.

In case (3), each circle is contained in one closed semiplane formed by one of outer tangent lines of two others. Therefore, a segment of that tangent line will be a part of the boundary of  $\text{CH}(\tilde{a} \cup \tilde{b} \cup \tilde{c})$ . The configuration in Figure 7 is distinguished by having an arc corresponding to central angle larger than  $\pi$  from one of the circles as a part of the border of  $\text{CH}(\tilde{a} \cup \tilde{b} \cup \tilde{c})$ .  $\square$

**Definition 5.1.** *An implication  $Y \rightarrow u$ ,  $Y \subseteq X, u \in X$ , is called tight, if implications  $(Y \setminus z) \rightarrow u$  do not hold, for all  $z \in Y$ .*

**Lemma 3.** *For an implication  $Y \rightarrow u$ ,  $Y \subseteq X, u \in X$ , if there exists  $y \in Y$  such that  $(Y \setminus y) \rightarrow y$ , then implication  $Y \rightarrow u$  cannot be tight.*

*Proof.* Let  $\varphi$  be the closure operator. If there exists  $y \in Y$  such that  $(Y \setminus y) \rightarrow y$ , then  $y \in \varphi((Y \setminus y))$ . Also since for any  $A$ ,  $A \subseteq \varphi(A)$ , we have  $Y \subseteq \varphi((Y \setminus y))$ . Now applying the closure operator to both sides,  $\varphi(Y) \subseteq \varphi((Y \setminus y))$ , as  $\varphi(\varphi(A)) = \varphi(A)$ . Since  $Y \rightarrow u$ ,  $u \in \varphi(Y)$  and  $u \in \varphi((Y \setminus y))$ . Thus  $(Y \setminus y) \rightarrow u$ , and hence  $Y \rightarrow u$  cannot be tight.  $\square$

**Lemma 4.** *If  $abc \rightarrow e$  is any tight implication that holds for circles  $a, b, c, e$ , then  $a, b, c$  cannot form a configuration in (1) or (2) of Lemma 1, for any labeling of circles by  $a, b, c$ .*

*Proof.* Indeed, if  $a, b, c$  form a configuration in (1), then the implication  $abc \rightarrow e$  cannot be tight due to Lemma 3. For configuration (2) we note that for any circle  $e$  in  $\text{ch}_c(a, b, c)$  we have either  $e \in \text{ch}_c(a, b)$  or  $e \in \text{ch}_c(b, c)$ . Note that the same may not be true for a shape  $e$  different from circle.  $\square$

**Corollary 5.1.** *If  $abc \rightarrow e$  is any tight implication that holds for circles  $a, b, c, e$ , then the boundary of  $\text{CH}(\tilde{a} \cup \tilde{b} \cup \tilde{c})$  comprises three tangent segments and three arcs.*

*Proof.* By Lemma 4, only configuration (3) from Lemma 1 may occur, which implies only case (III) of Lemma 2 occurs.  $\square$

## 5.2 Triangle Property

In this section we establish a simple property that holds for circles satisfying a tight implication. This will result in establishing that several convex geometries on a 5-element set are not representable by circles.

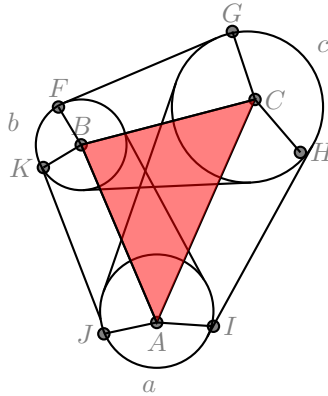

Figure 8: Triangle Property

**Lemma 5** (The Triangle Property). *If  $a, b, c$ , and  $e$  are circles in the plane with centers  $A, B, C$ , and  $E$  respectively, and  $abc \rightarrow e$  is a tight implication, then  $E$  must lie in the interior of triangle formed by  $A, B$  and  $C$ .*

*Proof.* If implication  $abc \rightarrow e$  is tight, then by Lemma 4 circles  $a, b, c$  cannot form any configuration from (1) and (2) of Lemma 1.

Moreover, since  $abc \rightarrow e$  is tight, the centers of  $a, b, c$  cannot be on a line, because in that case one obtains one of configurations (1) or (2) in Lemma 1. Therefore, the centers form a triangle.

By Corollary 5.1, the boundary of  $\text{CH}(\tilde{a} \cup \tilde{b} \cup \tilde{c})$  comprises three tangent segments and three arcs, as in Figure 8. The convex hull of three circles  $a, b, c$  splits into two parts:

- (I) the interior  $\text{int}(\triangle ABC)$  of triangle formed by the centers of the circles;

(II) the shape  $S = \text{CH}(\tilde{a} \cup \tilde{b} \cup \tilde{c}) \setminus \text{int}(\triangle ABC)$  .

Moreover,  $S$  splits into the union of the following shapes:

- (I) trapezoids formed between pairs of circles, each of which includes a segment connecting the centers of the two circles, two radii, and the circles' common tangent segment;
- (II) sectors of circles bordered by the radii which are the borders of trapezoids from (I).

If circle  $e$  is inside of the convex hull of  $a, b, c$ , and its center  $E$  is not in the interior of  $\triangle ABC$ , then it is in  $S$ . Thus it is either in one of the trapezoids or in one of the sectors.

Without loss of generality, suppose that  $E$  is inside of one of the sectors of circle  $a$ . Then the distance  $\sigma$  from  $E$  to the border of circle is  $\leq r_a$ . Therefore,  $r_e \leq r_a$  and  $e \in \text{ch}_c(a)$ . Here we use  $r_x$  to denote the radius of circle  $x$ .

Suppose now that  $E$  is in one of the trapezoids. Without loss of generality, suppose that  $E$  is in  $BCGF$  in Figure 8, where  $FG$  is the part of the border of  $\text{CH}(\tilde{a} \cup \tilde{b} \cup \tilde{c})$ , and  $\sigma$  is the distance from  $E$  to segment  $FG$ . Then  $r_e \leq \sigma$  and  $e \in \text{ch}_c(b, c)$ .

Therefore, the center of  $e$  for which  $abc \rightarrow e$  is tight cannot be in either the trapezoids or sectors, and thus it must be in interior of  $\triangle ABC$ .  $\square$

The following statement is a generalization of the Triangle Property.

**Corollary 5.2.** *If  $n > 2$ ,  $a_1, a_2, a_3, \dots, a_n, e$  are circles in the plane with centers  $A_1, A_2, \dots, A_n, E$  respectively, and  $a_1 a_2 a_3 \dots a_n \rightarrow e$  is tight then  $E \in \text{CH}(A_1, A_2, \dots, A_n)$ .*

*Proof.* The proof proceeds similar to the case of three circles and can be omitted.  $\square$

**Corollary 5.3.** *Convex geometries representable by circles cannot have three tight implications  $abc \rightarrow e$ ,  $abd \rightarrow e$ ,  $acd \rightarrow e$ .*

*Proof.* Indeed, consider  $A, B, C, D, E$ , the centers of circles that might represent this geometry. Connect  $A$  with  $B, C$  and  $D$ . Then the plane splits into three angles at vertex  $A$ . Choose two of smallest angles among these three. Without loss of generality, assume that the smallest are  $\angle CAB$  and  $\angle BAD$ . Then each of the two smallest angles are less than  $\pi$ , thus, line  $(AB)$  splits the plane into two semi-planes, so that  $C$  and  $D$  are in distinct semi-planes (see illustration in Figure 9).

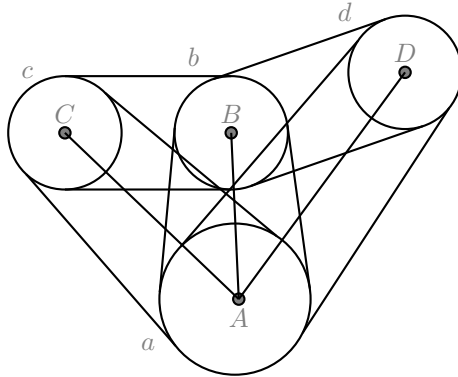

Figure 9: Corollary 5.3

By Lemma 5,  $E$  must be in the interior of  $\triangle ABC$  as well as in the interior of  $\triangle ABD$ , and since those interiors do not intersect, there is no possible location for  $E$ .  $\square$

**This gives us six geometries on the list that are not representable: G7, G11, G12, G18, G21 and G34. Note that G7, G21 and G34 have  $\text{cdim}=4$ .**

**Corollary 5.4.** *Convex geometries representable by circles cannot have three tight implications  $abc \rightarrow d$ ,  $acd \rightarrow e$ ,  $bcd \rightarrow e$ .*

*Proof.* Assume that the geometry does have a representation as a geometry of circles. The proof then follows from the use of Lemma 5 two times. First, since  $abc \rightarrow d$  is a tight implication,  $D$  must lie in the interior of triangle formed by vertices  $A$ ,  $B$  and  $C$  (which are the centers of  $a, b, c$ ). Moreover, we have two tight implications  $acd \rightarrow e$ ,  $bcd \rightarrow e$ . However, by Lemma 5 again, we would need  $E$  to be in the interior of both  $\triangle ACD$  and  $\triangle BCD$ , which is not possible.  $\square$

**This gives us that the additional geometry G23 cannot be represented by circles on the plane.**

## 6 Acknowledgments.

The project was initiated by several faculties from across the US led by Adam Sheffer (Baruch College, NY). These include Benjamin Brubaker (University of Minnesota), Victor Reiner (University of Minnesota), Patrick Devlin (Yale University), Yunus Zeytuncu (University of Michigan, Dearborn), Steven J. Miller (Williams College, MA) and Alexandra Seceleanu (University of Nebraska, Lincoln). Without the support and initiative of these colleagues and the unique circumstances of 2020, this project would not have started. More details about PolyMath-2020 can be found in [5].



*Address for correspondence:*

Kira Adaricheva, Department of Mathematics, Hofstra University, Hempstead  
NY, 11549

*Email address:* `Kira.Adaricheva@Hofstra.edu`

## References

- [1] K. Adaricheva, M. Bolat, *Representation of finite convex geometries by circles on the plane*, Discrete Mathematics v.342 (2019), N3, 726-746.
- [2] Adaricheva K.V., Gorbunov V.A., Tumanov V.I., *Join-semidistributive lattices and convex geometries*, Advances in Mathematics 173(2003), 1-49.
- [3] K. Adaricheva, J.B.Nation, *Convex geometries*, in Lattice Theory: Special Topics and Applications, v.2, G. Grätzer and F. Wehrung, eds. Springer, Basel, 2016.
- [4] K. Adaricheva, J.B.Nation, *Bases in closure systems*, in Lattice Theory: Special Topics and Applications, v.2, G. Grätzer and F. Wehrung, eds. Springer, Basel, 2016.
- [5] K. Adaricheva, B. Brubaker, P. Devlin, S. Miller, V. Reiner, A. Seceleanu, A. Scheffer, Y. Zeytuncu, *When life gives you lemons, make mathematicians*, Notices of AMS, v. 68, N3 (2021), 375-378.
- [6] G. Ausiello, A. D’Atri, D. Sacca, *Minimal representation of directed hypergraphs*. SIAM J. Comput. 15 (1986) 418-431.
- [7] G. Czédli, *Finite Convex Geometries of Circles*. Discrete Mathematics 330 (2014), 61–75.
- [8] P.H. Edelman and R.E. Jamison, *The Theory of Convex Geometries*. Geom Dedicata 19 (1985), 247–274.
- [9] P.H. Edelman and M. Saks, *Combinatorial representation and convex dimension of convex geometries*. Order 5 (1988), 23–32.
- [10] Y. Kempner, V. E. Levit *Correspondence between two Antimatroid Algorithmic Characterizations*. Electron. J. Comb. 10 (2003).
- [11] P. Uznański, *Enumeration of Antimatroids*. <https://paracombinatorics.wordpress.com/2013/04/07/enumeration-of-antimatroids-part-i/>
- [12] M. Wild, *The joy of implications, aka pure Horn functions: mainly a survey*. Theoretical Computer Science 658 (2017), 264-292.
- [13] The On-line Encyclopedia of Integer Sequences, <https://oeis.org>
- [14] Bitmasking, [https://en.wikipedia.org/wiki/Mask\\_\(computing\)](https://en.wikipedia.org/wiki/Mask_(computing))
- [15] GeoGebra Toolkit <https://www.geogebra.org/classic/dk88mrgu>
- [16] Google Colab notebook [https://colab.research.google.com/drive/1wocYWp8zzt\\_qNe5vvPyR-6ho0i0dlW0n?usp=sharing#scrollTo=0CIxso049TWn](https://colab.research.google.com/drive/1wocYWp8zzt_qNe5vvPyR-6ho0i0dlW0n?usp=sharing#scrollTo=0CIxso049TWn)

# Appendices

## A

### A.1 Description of size 4 geometries

1.  
id: 65535  
meet-irreducibles: abc abd acd bcd  
max antichain: abc abd acd bcd  
dimension: 4
  
2.  
id: 65407  
abc -> d  
meet-irreducibles: ab ac bc abd acd bcd  
max antichain: ab ac bc  
dimension: 3
  
3.  
id: 65399  
ab -> d  
meet-irreducibles: ac bc abd acd bcd  
max antichain: ac bc abd  
dimension: 3
  
4.  
id: 65367  
ac -> d  
ab -> d  
meet-irreducibles: a bc abd acd bcd  
max antichain: bc abd acd  
dimension: 3
  
5.  
id: 63351  
ab -> cd  
meet-irreducibles: ac bc ad bd acd bcd  
max antichain: ac bc ad bd  
dimension: 4
  
6.  
id: 65365  
a -> d  
meet-irreducibles: bc abd acd bcd

APPENDIX A.1: DESCRIPTION OF SIZE 4 GEOMETRIES

max antichain: bc abd acd  
dimension: 3

7.  
id: 65303  
bc -> d  
ac -> d  
ab -> d  
meet-irreducibles: a b c abd acd bcd  
max antichain: a b c  
dimension: 3

8.  
id: 63319  
ac -> d  
ab -> cd  
meet-irreducibles: a bc ad bd acd bcd  
max antichain: a bc bd  
dimension: 3

9.  
id: 65301  
bc -> d  
a -> d  
meet-irreducibles: b c abd acd bcd  
max antichain: abd acd bcd  
dimension: 3

10.  
id: 63317  
ab -> cd  
a -> d  
meet-irreducibles: bc ad bd acd bcd  
max antichain: bc ad bd  
dimension: 3

11.  
id: 63255  
bc -> d  
ac -> d  
ab -> cd  
meet-irreducibles: a b c ad bd acd bcd  
max antichain: a b c  
dimension: 3

12.

APPENDIX A.1: DESCRIPTION OF SIZE 4 GEOMETRIES

id: 62775  
ad -> c  
bc -> d  
ab -> cd  
meet-irreducibles: a b ac bd acd bcd  
max antichain: a b  
dimension: 2

13.  
id: 65297  
b -> d  
a -> d  
meet-irreducibles: c abd acd bcd  
max antichain: abd acd bcd  
dimension: 3

14.  
id: 63253  
bc -> d  
ab -> cd  
a -> d  
meet-irreducibles: b c ad bd acd bcd  
max antichain: b c ad  
dimension: 3

15.  
id: 62805  
a -> cd  
meet-irreducibles: bc bd acd bcd  
max antichain: bc bd acd  
dimension: 3

16.  
id: 62773  
bc -> d  
ab -> cd  
a -> c  
meet-irreducibles: b ac bd acd bcd  
max antichain: b ac  
dimension: 2

17.  
id: 63239  
c -> d  
ab -> cd  
meet-irreducibles: a b ad bd acd bcd

APPENDIX A.1: DESCRIPTION OF SIZE 4 GEOMETRIES

max antichain: a b  
dimension: 2

18.  
id: 65281  
c → d  
b → d  
a → d  
meet-irreducibles: abd acd bcd  
max antichain: abd acd bcd  
dimension: 3

19.  
id: 63249  
ab → cd  
b → d  
a → d  
meet-irreducibles: c ad bd acd bcd  
max antichain: c ad bd  
dimension: 3

20.  
id: 62769  
ab → cd  
b → d  
a → c  
meet-irreducibles: ac bd acd bcd  
max antichain: ac bd  
dimension: 2

21.  
id: 63237  
c → d  
ab → cd  
a → d  
meet-irreducibles: b ad bd acd bcd  
max antichain: b ad  
dimension: 2

22.  
id: 62741  
bc → d  
a → cd  
meet-irreducibles: b c bd acd bcd  
max antichain: b c  
dimension: 2

APPENDIX A.1: DESCRIPTION OF SIZE 4 GEOMETRIES

23.  
id: 54613  
a -> bcd  
meet-irreducibles: bc bd cd bcd  
max antichain: bc bd cd  
dimension: 3

24.  
id: 63233  
c -> d  
ab -> cd  
b -> d  
a -> d  
meet-irreducibles: ad bd acd bcd  
max antichain: ad bd  
dimension: 2

25.  
id: 62737  
b -> d  
a -> cd  
meet-irreducibles: c bd acd bcd  
max antichain: c bd  
dimension: 2

26.  
id: 62725  
c -> d  
a -> cd  
meet-irreducibles: b bd acd bcd  
max antichain: b acd  
dimension: 2

27.  
id: 54549  
bc -> d  
a -> bcd  
meet-irreducibles: b c bd cd bcd  
max antichain: b c  
dimension: 2

28.  
id: 62721  
c -> d  
b -> d

APPENDIX A.1: DESCRIPTION OF SIZE 4 GEOMETRIES

a -> cd  
meet-irreducibles: bd acd bcd  
max antichain: bd acd  
dimension: 2

29.  
id: 61713  
b -> cd  
a -> cd  
meet-irreducibles: c d acd bcd  
max antichain: c d  
dimension: 2

30.  
id: 54545  
b -> d  
a -> bcd  
meet-irreducibles: c bd cd bcd  
max antichain: c bd  
dimension: 2

31.  
id: 61697  
c -> d  
b -> cd  
a -> cd  
meet-irreducibles: d acd bcd  
max antichain: acd bcd  
dimension: 2

32.  
id: 54529  
c -> d  
b -> d  
a -> bcd  
meet-irreducibles: bd cd bcd  
max antichain: bd cd  
dimension: 2

33.  
id: 53521  
b -> cd  
a -> bcd  
meet-irreducibles: c d cd bcd  
max antichain: c d  
dimension: 2



## APPENDIX A.2: DESCRIPTION OF SIZE 5 GEOMETRIES

34.  
id: 53505  
c -> d  
b -> cd  
a -> bcd  
meet-irreducibles: d cd bcd  
max antichain: d  
dimension: 1

### A.2 Description of size 5 geometries

1.  
id: 4294967295  
meet-irreducibles: abcd abce abde acde bcde  
max antichain: abcd abce abde acde bcde  
dimension: 5

2.  
id: 4294934527  
abcd -> e  
meet-irreducibles: abc abd acd bcd abce abde acde bcde  
max antichain: abc abd acd bcd  
dimension: 4

3.  
id: 4294934399  
abc -> e  
meet-irreducibles: abd acd bcd abce abde acde bcde  
max antichain: abd acd bcd abce  
dimension: 4

4.  
id: 4286545791  
abc -> de  
meet-irreducibles: abd acd bcd abe ace bce abde acde bcde  
max antichain: abd acd bcd abe ace bce  
dimension: 6

5.  
id: 4294932351  
abd -> e  
abc -> e  
meet-irreducibles: ab acd bcd abce abde acde bcde

APPENDIX A.2: DESCRIPTION OF SIZE 5 GEOMETRIES

max antichain: acd bcd abce abde  
dimension: 4

6.  
id: 4294932343  
ab -> e  
meet-irreducibles: acd bcd abce abde acde bcde  
max antichain: acd bcd abce abde  
dimension: 4

7.  
id: 4294924159  
acd -> e  
abd -> e  
abc -> e  
meet-irreducibles: ab ac ad bcd abce abde acde bcde  
max antichain: ab ac ad bcd  
dimension: 4

8.  
id: 4286543743  
abd -> e  
abc -> de  
meet-irreducibles: ab acd bcd abe ace bce abde acde bcde  
max antichain: ab acd bcd ace bce  
dimension: 5

9.  
id: 4294924151  
acd -> e  
ab -> e  
meet-irreducibles: ac ad bcd abce abde acde bcde  
max antichain: bcd abce abde acde  
dimension: 4

10.  
id: 4286543735  
abc -> de  
ab -> e  
meet-irreducibles: acd bcd abe ace bce abde acde bcde  
max antichain: acd bcd abe ace bce  
dimension: 5

11.  
id: 4294907775  
bcd -> e

APPENDIX A.2: DESCRIPTION OF SIZE 5 GEOMETRIES

acd -> e  
abd -> e  
abc -> e  
meet-irreducibles: ab ac bc ad bd cd abce abde acde bcde  
max antichain: ab ac bc ad bd cd  
dimension: 6

12.  
id: 4286535551  
acd -> e  
abd -> e  
abc -> de  
meet-irreducibles: ab ac ad bcd abe ace bce abde acde bcde  
max antichain: ab ac ad bcd bce  
dimension: 5

13.  
id: 4286013311  
abe -> d  
acd -> e  
abc -> de  
meet-irreducibles: ab ac abd bcd ace bce abde acde bcde  
max antichain: ab ac bcd bce  
dimension: 4

14.  
id: 4294907767  
bcd -> e  
acd -> e  
ab -> e  
meet-irreducibles: ac bc ad bd cd abce abde acde bcde  
max antichain: ac bc ad bd cd  
dimension: 5

15.  
id: 4286535543  
acd -> e  
abc -> de  
ab -> e  
meet-irreducibles: ac ad bcd abe ace bce abde acde bcde  
max antichain: ac ad bcd abe bce  
dimension: 5

16.  
id: 4286535039  
ad -> e

APPENDIX A.2: DESCRIPTION OF SIZE 5 GEOMETRIES

abc -> de  
meet-irreducibles: ab ac bcd abe ace bce abde acde bcde  
max antichain: ab ac bcd bce  
dimension: 4

17.  
id: 4286019447  
ab -> de  
meet-irreducibles: acd bcd ace bce abde acde bcde  
max antichain: acd bcd ace bce abde  
dimension: 5

18.  
id: 4286519167  
bcd -> e  
acd -> e  
abd -> e  
abc -> de  
meet-irreducibles: ab ac bc ad bd cd abe ace bce abde acde bcde  
max antichain: ab ac bc ad bd cd  
dimension: 6

19.  
id: 4294924119  
ac -> e  
ab -> e  
meet-irreducibles: ad bcd abce abde acde bcde  
max antichain: bcd abce abde acde  
dimension: 4

20.  
id: 4286013303  
acd -> e  
abc -> de  
ab -> d  
meet-irreducibles: ac abd bcd ace bce abde acde bcde  
max antichain: ac abd bcd bce  
dimension: 4

21.  
id: 4285996927  
abe -> d  
bcd -> e  
acd -> e  
abc -> de  
meet-irreducibles: ab ac bc abd cd ace bce abde acde bcde

APPENDIX A.2: DESCRIPTION OF SIZE 5 GEOMETRIES

max antichain: ab ac bc cd  
dimension: 4

22.  
id: 4286535031  
ad -> e  
abc -> de  
ab -> e  
meet-irreducibles: ac bcd abe ace bce abde acde bcde  
max antichain: ac bcd abe bce  
dimension: 4

23.  
id: 4286519159  
bcd -> e  
acd -> e  
abc -> de  
ab -> e  
meet-irreducibles: ac bc ad bd cd abe ace bce abde acde bcde  
max antichain: ac bc ad bd cd abe  
dimension: 6

24.  
id: 4286013271  
abc -> de  
ac -> e  
ab -> d  
meet-irreducibles: abd bcd ace bce abde acde bcde  
max antichain: abd bcd ace bce  
dimension: 4

25.  
id: 4286011255  
acd -> e  
ab -> de  
meet-irreducibles: ac ad bcd ace bce abde acde bcde  
max antichain: ac ad bcd bce  
dimension: 4

26.  
id: 4286518655  
bcd -> e  
ad -> e  
abc -> de  
meet-irreducibles: ab ac bc bd cd abe ace bce abde acde bcde  
max antichain: ab ac bc bd cd

APPENDIX A.2: DESCRIPTION OF SIZE 5 GEOMETRIES

dimension: 5

27.

id: 4285996895

abe -> d

bcd -> e

abc -> de

ac -> e

meet-irreducibles: ab bc abd cd ace bce abde acde bcde

max antichain: ab bc cd ace

dimension: 4

28.

id: 4151801719

ab -> cde

meet-irreducibles: acd bcd ace bce ade bde acde bcde

max antichain: acd bcd ace bce ade bde

dimension: 6

29.

id: 4294907199

ad -> e

bc -> e

meet-irreducibles: ab ac bd cd abce abde acde bcde

max antichain: ab ac bd cd

dimension: 4

30.

id: 4294923607

ad -> e

ac -> e

ab -> e

meet-irreducibles: a bcd abce abde acde bcde

max antichain: bcd abce abde acde

dimension: 4

31.

id: 4294907735

bcd -> e

ac -> e

ab -> e

meet-irreducibles: bc ad bd cd abce abde acde bcde

max antichain: bc ad bd cd

dimension: 4

32.

APPENDIX A.2: DESCRIPTION OF SIZE 5 GEOMETRIES

id: 4285992831  
abe -> d  
cd -> e  
abc -> de  
meet-irreducibles: ab ac bc abd ace bce abde acde bcde  
max antichain: ab ac bc  
dimension: 3

33.  
id: 4286535511  
abc -> de  
ac -> e  
ab -> e  
meet-irreducibles: ad bcd abe ace bce abde acde bcde  
max antichain: ad bcd abe ace bce  
dimension: 5

34.  
id: 4285996919  
bcd -> e  
acd -> e  
abc -> de  
ab -> d  
meet-irreducibles: ac bc abd cd ace bce abde acde bcde  
max antichain: ac bc abd cd  
dimension: 4

35.  
id: 4286518647  
bcd -> e  
ad -> e  
abc -> de  
ab -> e  
meet-irreducibles: ac bc bd cd abe ace bce abde acde bcde  
max antichain: ac bc bd cd abe  
dimension: 5

36.  
id: 4285992799  
abe -> d  
cd -> e  
abc -> de  
ac -> e  
meet-irreducibles: ab bc abd ace bce abde acde bcde  
max antichain: ab bc ace  
dimension: 3

APPENDIX A.2: DESCRIPTION OF SIZE 5 GEOMETRIES

37.

id: 4286010743  
ad -> e  
ab -> de  
meet-irreducibles: ac bcd ace bce abde acde bcde  
max antichain: ac bcd bce abde  
dimension: 4

38.

id: 4285996887  
bcd -> e  
abc -> de  
ac -> e  
ab -> d  
meet-irreducibles: bc abd cd ace bce abde acde bcde  
max antichain: bc abd cd ace  
dimension: 4

39.

id: 4285994871  
bcd -> e  
acd -> e  
ab -> de  
meet-irreducibles: ac bc ad bd cd ace bce abde acde bcde  
max antichain: ac bc ad bd cd  
dimension: 5

40.

id: 4151793527  
acd -> e  
ab -> cde  
meet-irreducibles: ac ad bcd ace bce ade bde acde bcde  
max antichain: ac ad bcd bce bde  
dimension: 5

41.

id: 4286517631  
bd -> e  
ad -> e  
abc -> de  
meet-irreducibles: ab ac bc cd abe ace bce abde acde bcde  
max antichain: ab ac bc cd  
dimension: 4

42.



APPENDIX A.2: DESCRIPTION OF SIZE 5 GEOMETRIES

id: 4294907191

ad -> e

bc -> e

ab -> e

meet-irreducibles: ac bd cd abce abde acde bcde

max antichain: abce abde acde bcde

dimension: 4

43.

id: 4283905911

ace -> d

bcd -> e

ab -> de

meet-irreducibles: ac bc bd acd ae bce abde acde bcde

max antichain: ac bc bd ae

dimension: 4

44.

id: 4285992823

cd -> e

abc -> de

ab -> d

meet-irreducibles: ac bc abd ace bce abde acde bcde

max antichain: ac bc abd

dimension: 3

45.

id: 4286518591

ad -> e

abc -> de

bc -> e

meet-irreducibles: ab ac bd cd abe ace bce abde acde bcde

max antichain: ab ac bd cd bce

dimension: 5

46.

id: 4294907223

bcd -> e

ad -> e

ac -> e

ab -> e

meet-irreducibles: a bc bd cd abce abde acde bcde

max antichain: a bc bd cd

dimension: 4

47.

APPENDIX A.2: DESCRIPTION OF SIZE 5 GEOMETRIES

id: 4285996831  
abe -> d  
abc -> de  
bc -> e  
ac -> e  
meet-irreducibles: ab abd cd ace bce abde acde bcde  
max antichain: ab cd ace bce  
dimension: 4

48.  
id: 4286534999  
ad -> e  
abc -> de  
ac -> e  
ab -> e  
meet-irreducibles: a bcd abe ace bce abde acde bcde  
max antichain: bcd abe ace bce  
dimension: 4

49.  
id: 4286519127  
bcd -> e  
abc -> de  
ac -> e  
ab -> e  
meet-irreducibles: bc ad bd cd abe ace bce abde acde bcde  
max antichain: bc ad bd cd abe ace  
dimension: 6

50.  
id: 4286011223  
ac -> e  
ab -> de  
meet-irreducibles: ad bcd ace bce abde acde bcde  
max antichain: ad bcd ace bce  
dimension: 4

51.  
id: 4294923605  
a -> e  
meet-irreducibles: bcd abce abde acde bcde  
max antichain: bcd abce abde acde  
dimension: 4

52.  
id: 4294907671

APPENDIX A.2: DESCRIPTION OF SIZE 5 GEOMETRIES

bc -> e  
ac -> e  
ab -> e  
meet-irreducibles: ad bd cd abce abde acde bcde  
max antichain: ad bd cd abce  
dimension: 4

53.  
id: 4285994359  
bcd -> e  
ad -> e  
ab -> de  
meet-irreducibles: ac bc bd cd ace bce abde acde bcde  
max antichain: ac bc bd cd  
dimension: 4

54.  
id: 4151777143  
bcd -> e  
acd -> e  
ab -> cde  
meet-irreducibles: ac bc ad bd cd ace bce ade bde acde bcde  
max antichain: ac bc ad bd cd  
dimension: 5

55.  
id: 4283904887  
ace -> d  
bd -> e  
ab -> de  
meet-irreducibles: ac bc acd ae bce abde acde bcde  
max antichain: ac bc ae  
dimension: 3

56.  
id: 4286518583  
ad -> e  
abc -> de  
bc -> e  
ab -> e  
meet-irreducibles: ac bd cd abe ace bce abde acde bcde  
max antichain: ac bd cd abe bce  
dimension: 5

57.  
id: 4149688183

APPENDIX A.2: DESCRIPTION OF SIZE 5 GEOMETRIES

ace -> d  
bcd -> e  
ab -> cde  
meet-irreducibles: ac bc bd acd ae bce ade bde acde bcde  
max antichain: ac bc bd ae  
dimension: 4

58.  
id: 4285992735  
abe -> d  
cd -> e  
abc -> de  
bc -> e  
ac -> e  
meet-irreducibles: ab c abd ace bce abde acde bcde  
max antichain: ab ace bce  
dimension: 3

59.  
id: 4285996823  
abc -> de  
bc -> e  
ac -> e  
ab -> d  
meet-irreducibles: abd cd ace bce abde acde bcde  
max antichain: abd cd ace bce  
dimension: 4

60.  
id: 4286518615  
bcd -> e  
ad -> e  
abc -> de  
ac -> e  
ab -> e  
meet-irreducibles: a bc bd cd abe ace bce abde acde bcde  
max antichain: bc bd cd abe ace  
dimension: 5

61.  
id: 4286010711  
ad -> e  
ac -> e  
ab -> de  
meet-irreducibles: a bcd ace bce abde acde bcde  
max antichain: bcd ace bce abde

APPENDIX A.2: DESCRIPTION OF SIZE 5 GEOMETRIES

dimension: 4

62.

id: 4285994839

bcd -> e

ac -> e

ab -> de

meet-irreducibles: bc ad bd cd ace bce abde acde bcde

max antichain: bc ad bd cd ace

dimension: 5

63.

id: 4294907221

bcd -> e

a -> e

meet-irreducibles: bc bd cd abce abde acde bcde

max antichain: abce abde acde bcde

dimension: 4

64.

id: 4283914071

ac -> de

ab -> de

meet-irreducibles: ad bcd ae bce abde acde bcde

max antichain: ad bcd ae bce

dimension: 4

65.

id: 4151793495

ac -> e

ab -> cde

meet-irreducibles: ad bcd ace bce ade bde acde bcde

max antichain: ad bcd ace bce bde

dimension: 5

66.

id: 4286517599

bd -> e

ad -> e

abc -> de

ac -> e

meet-irreducibles: ab bc cd abe ace bce abde acde bcde

max antichain: ab bc cd ace

dimension: 4

67.

APPENDIX A.2: DESCRIPTION OF SIZE 5 GEOMETRIES

id: 4286534997  
abc -> de  
a -> e  
meet-irreducibles: bcd abe ace bce abde acde bcde  
max antichain: bcd abe ace bce  
dimension: 4

68.  
id: 4294907159  
ad -> e  
bc -> e  
ac -> e  
ab -> e  
meet-irreducibles: a bd cd abce abde acde bcde  
max antichain: abce abde acde bcde  
dimension: 4

69.  
id: 4283905879  
bcd -> e  
ac -> d  
ab -> de  
meet-irreducibles: bc bd acd ae bce abde acde bcde  
max antichain: bc bd acd ae  
dimension: 4

70.  
id: 4286519063  
abc -> de  
bc -> e  
ac -> e  
ab -> e  
meet-irreducibles: ad bd cd abe ace bce abde acde bcde  
max antichain: ad bd cd abe ace bce  
dimension: 6

71.  
id: 4285992791  
cd -> e  
abc -> de  
ac -> e  
ab -> d  
meet-irreducibles: bc abd ace bce abde acde bcde  
max antichain: bc abd ace  
dimension: 3

APPENDIX A.2: DESCRIPTION OF SIZE 5 GEOMETRIES

72.  
id: 4285990775  
cd -> e  
ab -> de  
meet-irreducibles: ac bc ad bd ace bce abde acde bcde  
max antichain: ac bc ad bd  
dimension: 4

73.  
id: 4294906143  
bd -> e  
ad -> e  
bc -> e  
ac -> e  
meet-irreducibles: ab cd abce abde acde bcde  
max antichain: abce abde acde bcde  
dimension: 4

74.  
id: 4286513535  
cd -> e  
bd -> e  
ad -> e  
abc -> de  
meet-irreducibles: ab ac bc d abe ace bce abde acde bcde  
max antichain: ab ac bc d  
dimension: 4

75.  
id: 4286517623  
bd -> e  
ad -> e  
abc -> de  
ab -> e  
meet-irreducibles: ac bc cd abe ace bce abde acde bcde  
max antichain: ac bc cd abe  
dimension: 4

76.  
id: 4285992727  
cd -> e  
abc -> de  
bc -> e  
ac -> e  
ab -> d  
meet-irreducibles: c abd ace bce abde acde bcde

APPENDIX A.2: DESCRIPTION OF SIZE 5 GEOMETRIES

max antichain: abd ace bce  
dimension: 3

77.  
id: 4285992719  
abe -> d  
abc -> de  
c -> e  
meet-irreducibles: ab abd ace bce abde acde bcde  
max antichain: ab ace bce  
dimension: 3

78.  
id: 4283773815  
ae -> d  
bd -> e  
ab -> de  
meet-irreducibles: ac bc acd bce abde acde bcde  
max antichain: ac bc abde  
dimension: 3

79.  
id: 4149687159  
ace -> d  
bd -> e  
ab -> cde  
meet-irreducibles: ac bc acd ae bce ade bde acde bcde  
max antichain: ac bc ae bde  
dimension: 4

80.  
id: 4285994295  
ad -> e  
bc -> e  
ab -> de  
meet-irreducibles: ac bd cd ace bce abde acde bcde  
max antichain: ac bd cd bce  
dimension: 4

81.  
id: 4285990743  
cd -> e  
ac -> e  
ab -> de  
meet-irreducibles: bc ad bd ace bce abde acde bcde  
max antichain: bc ad bd ace



APPENDIX A.2: DESCRIPTION OF SIZE 5 GEOMETRIES

dimension: 4

82.

id: 4286517591

bd -> e

ad -> e

abc -> de

ac -> e

ab -> e

meet-irreducibles: a bc cd abe ace bce abde acde bcde

max antichain: bc cd abe ace

dimension: 4

83.

id: 4283904823

ace -> d

bd -> e

bc -> e

ab -> de

meet-irreducibles: b ac acd ae bce abde acde bcde

max antichain: b ac ae

dimension: 3

84.

id: 4285994327

bcd -> e

ad -> e

ac -> e

ab -> de

meet-irreducibles: a bc bd cd ace bce abde acde bcde

max antichain: a bc bd cd

dimension: 4

85.

id: 4283913559

ad -> e

ac -> de

ab -> de

meet-irreducibles: a bcd ae bce abde acde bcde

max antichain: bcd bce abde acde

dimension: 4

86.

id: 4151792983

ad -> e

ac -> e

APPENDIX A.2: DESCRIPTION OF SIZE 5 GEOMETRIES

ab -> cde  
meet-irreducibles: a bcd ace bce ade bde acde bcde  
max antichain: bcd ace bce ade bde  
dimension: 5

87.  
id: 4283897687  
bcd -> e  
ac -> de  
ab -> de  
meet-irreducibles: bc ad bd cd ae bce abde acde bcde  
max antichain: bc ad bd cd ae  
dimension: 5

88.  
id: 4151777111  
bcd -> e  
ac -> e  
ab -> cde  
meet-irreducibles: bc ad bd cd ace bce ade bde acde bcde  
max antichain: bc ad bd cd ace  
dimension: 5

89.  
id: 4286518613  
bcd -> e  
abc -> de  
a -> e  
meet-irreducibles: bc bd cd abe ace bce abde acde bcde  
max antichain: bc bd cd abe ace  
dimension: 5

90.  
id: 4149696343  
ac -> de  
ab -> cde  
meet-irreducibles: ad bcd ae bce ade bde acde bcde  
max antichain: ad bcd ae bce bde  
dimension: 5

91.  
id: 4294906135  
bd -> e  
ad -> e  
bc -> e  
ac -> e

APPENDIX A.2: DESCRIPTION OF SIZE 5 GEOMETRIES

ab -> e  
meet-irreducibles: a b cd abce abde acde bcde  
max antichain: abce abde acde bcde  
dimension: 4

92.  
id: 4283904855  
bd -> e  
ac -> d  
ab -> de  
meet-irreducibles: bc acd ae bce abde acde bcde  
max antichain: bc acd ae  
dimension: 3

93.  
id: 4286010709  
ab -> de  
a -> e  
meet-irreducibles: bcd ace bce abde acde bcde  
max antichain: bcd ace bce abde  
dimension: 4

94.  
id: 4286518551  
ad -> e  
abc -> de  
bc -> e  
ac -> e  
ab -> e  
meet-irreducibles: a bd cd abe ace bce abde acde bcde  
max antichain: bd cd abe ace bce  
dimension: 5

95.  
id: 4149688151  
bcd -> e  
ac -> d  
ab -> cde  
meet-irreducibles: bc bd acd ae bce ade bde acde bcde  
max antichain: bc bd acd ae  
dimension: 4

96.  
id: 4286513527  
cd -> e  
bd -> e

APPENDIX A.2: DESCRIPTION OF SIZE 5 GEOMETRIES

ad -> e  
abc -> de  
ab -> e  
meet-irreducibles: ac bc d abe ace bce abde acde bcde  
max antichain: ac bc d abe  
dimension: 4

97.  
id: 4286513279  
d -> e  
abc -> de  
meet-irreducibles: ab ac bc abe ace bce abde acde bcde  
max antichain: ab ac bc  
dimension: 3

98.  
id: 4285990263  
cd -> e  
ad -> e  
ab -> de  
meet-irreducibles: ac bc bd ace bce abde acde bcde  
max antichain: ac bc bd  
dimension: 3

99.  
id: 4285994775  
bc -> e  
ac -> e  
ab -> de  
meet-irreducibles: ad bd cd ace bce abde acde bcde  
max antichain: ad bd cd ace bce  
dimension: 5

100.  
id: 4294907157  
bc -> e  
a -> e  
meet-irreducibles: bd cd abce abde acde bcde  
max antichain: abce abde acde bcde  
dimension: 4

101.  
id: 4151773047  
cd -> e  
ab -> cde  
meet-irreducibles: ac bc ad bd ace bce ade bde acde bcde

APPENDIX A.2: DESCRIPTION OF SIZE 5 GEOMETRIES

max antichain: ac bc ad bd  
dimension: 4

102.  
id: 4286517535  
bd -> e  
ad -> e  
abc -> de  
bc -> e  
ac -> e  
meet-irreducibles: ab cd abe ace bce abde acde bcde  
max antichain: ab cd ace bce  
dimension: 4

103.  
id: 4283905815  
bc -> e  
ac -> d  
ab -> de  
meet-irreducibles: bd acd ae bce abde acde bcde  
max antichain: bd acd ae bce  
dimension: 4

104.  
id: 4285993335  
bd -> e  
ad -> e  
ab -> de  
meet-irreducibles: ac bc cd ace bce abde acde bcde  
max antichain: ac bc cd abde  
dimension: 4

105.  
id: 4286513495  
cd -> e  
bd -> e  
ad -> e  
abc -> de  
ac -> e  
ab -> e  
meet-irreducibles: a bc d abe ace bce abde acde bcde  
max antichain: bc d abe ace  
dimension: 4

106.  
id: 4149556087

APPENDIX A.2: DESCRIPTION OF SIZE 5 GEOMETRIES

ae -> d  
bd -> e  
ab -> cde  
meet-irreducibles: ac bc acd bce ade bde acde bcde  
max antichain: ac bc ade bde  
dimension: 4

107.  
id: 4285990231  
cd -> e  
ad -> e  
ac -> e  
ab -> de  
meet-irreducibles: a bc bd ace bce abde acde bcde  
max antichain: a bc bd  
dimension: 3

108.  
id: 4116002679  
ae -> cd  
bcd -> e  
ab -> cde  
meet-irreducibles: ac bc ad bd acd bce bde acde bcde  
max antichain: ac bc ad bd  
dimension: 4

109.  
id: 4151776567  
ad -> e  
bc -> e  
ab -> cde  
meet-irreducibles: ac bd cd ace bce ade bde acde bcde  
max antichain: ac bd cd bce ade  
dimension: 5

110.  
id: 4151773015  
cd -> e  
ac -> e  
ab -> cde  
meet-irreducibles: bc ad bd ace bce ade bde acde bcde  
max antichain: bc ad bd ace  
dimension: 4

111.  
id: 4294902039

## APPENDIX A.2: DESCRIPTION OF SIZE 5 GEOMETRIES

cd -> e  
bd -> e  
ad -> e  
bc -> e  
ac -> e  
ab -> e  
meet-irreducibles: a b c d abce abde acde bcde  
max antichain: a b c d  
dimension: 4

112.  
id: 4285993303  
bd -> e  
ad -> e  
ac -> e  
ab -> de  
meet-irreducibles: a bc cd ace bce abde acde bcde  
max antichain: bc cd ace abde  
dimension: 4

113.  
id: 4149687095  
ace -> d  
bd -> e  
bc -> e  
ab -> cde  
meet-irreducibles: b ac acd ae bce ade bde acde bcde  
max antichain: ac ae bce bde  
dimension: 4

114.  
id: 4283897175  
bcd -> e  
ad -> e  
ac -> de  
ab -> de  
meet-irreducibles: a bc bd cd ae bce abde acde bcde  
max antichain: a bc bd cd  
dimension: 4

115.  
id: 4151776599  
bcd -> e  
ad -> e  
ac -> e  
ab -> cde

APPENDIX A.2: DESCRIPTION OF SIZE 5 GEOMETRIES

meet-irreducibles: a bc bd cd ace bce ade bde acde bcde  
max antichain: bc bd cd ace ade  
dimension: 5

116.  
id: 4283896663  
bd -> e  
ac -> de  
ab -> de  
meet-irreducibles: bc ad cd ae bce abde acde bcde  
max antichain: bc ad cd ae  
dimension: 4

117.  
id: 4286513271  
d -> e  
abc -> de  
ab -> e  
meet-irreducibles: ac bc abe ace bce abde acde bcde  
max antichain: ac bc abe  
dimension: 3

118.  
id: 4285990679  
cd -> e  
bc -> e  
ac -> e  
ab -> de  
meet-irreducibles: c ad bd ace bce abde acde bcde  
max antichain: ad bd ace bce  
dimension: 4

119.  
id: 4149695831  
ad -> e  
ac -> de  
ab -> cde  
meet-irreducibles: a bcd ae bce ade bde acde bcde  
max antichain: a bcd bce bde  
dimension: 4

120.  
id: 4286517589  
bd -> e  
abc -> de  
a -> e



APPENDIX A.2: DESCRIPTION OF SIZE 5 GEOMETRIES

meet-irreducibles: bc cd abe ace bce abde acde bcde  
max antichain: bc cd abe ace  
dimension: 4

121.  
id: 4283766615  
ae -> d  
bcd -> e  
ac -> de  
ab -> de  
meet-irreducibles: a bc ad bd cd bce abde acde bcde  
max antichain: a bc bd cd  
dimension: 4

122.  
id: 4149679959  
bcd -> e  
ac -> de  
ab -> cde  
meet-irreducibles: bc ad bd cd ae bce ade bde acde bcde  
max antichain: bc ad bd cd ae  
dimension: 5

123.  
id: 4285994325  
bcd -> e  
ab -> de  
a -> e  
meet-irreducibles: bc bd cd ace bce abde acde bcde  
max antichain: bc bd cd ace  
dimension: 4

124.  
id: 4283773783  
ae -> d  
bd -> e  
ac -> d  
ab -> de  
meet-irreducibles: a bc acd bce abde acde bcde  
max antichain: bc acd abde  
dimension: 3

125.  
id: 4286517527  
bd -> e  
ad -> e

APPENDIX A.2: DESCRIPTION OF SIZE 5 GEOMETRIES

abc -> de  
bc -> e  
ac -> e  
ab -> e  
meet-irreducibles: a b cd abe ace bce abde acde bcde  
max antichain: cd abe ace bce  
dimension: 4

126.  
id: 4149687127  
bd -> e  
ac -> d  
ab -> cde  
meet-irreducibles: bc acd ae bce ade bde acde bcde  
max antichain: bc acd ae bde  
dimension: 4

127.  
id: 4283913557  
ac -> de  
ab -> de  
a -> e  
meet-irreducibles: bcd ae bce abde acde bcde  
max antichain: bcd bce abde acde  
dimension: 4

128.  
id: 4151792981  
ab -> cde  
a -> e  
meet-irreducibles: bcd ace bce ade bde acde bcde  
max antichain: bcd ace bce ade bde  
dimension: 5

129.  
id: 4285994263  
ad -> e  
bc -> e  
ac -> e  
ab -> de  
meet-irreducibles: a bd cd ace bce abde acde bcde  
max antichain: a bd cd bce  
dimension: 4

130.  
id: 4285989239

APPENDIX A.2: DESCRIPTION OF SIZE 5 GEOMETRIES

cd -> e  
bd -> e  
ad -> e  
ab -> de  
meet-irreducibles: ac bc d ace bce abde acde bcde  
max antichain: ac bc d  
dimension: 3

131.  
id: 4294906133  
bd -> e  
bc -> e  
a -> e  
meet-irreducibles: b cd abce abde acde bcde  
max antichain: abce abde acde bcde  
dimension: 4

132.  
id: 4283897623  
bc -> e  
ac -> de  
ab -> de  
meet-irreducibles: ad bd cd ae bce abde acde bcde  
max antichain: ad bd cd ae bce  
dimension: 5

133.  
id: 4151777047  
bc -> e  
ac -> e  
ab -> cde  
meet-irreducibles: ad bd cd ace bce ade bde acde bcde  
max antichain: ad bd cd ace bce  
dimension: 5

134.  
id: 4286518549  
abc -> de  
bc -> e  
a -> e  
meet-irreducibles: bd cd abe ace bce abde acde bcde  
max antichain: bd cd abe ace bce  
dimension: 5

135.  
id: 4283904791

APPENDIX A.2: DESCRIPTION OF SIZE 5 GEOMETRIES

bd -> e  
bc -> e  
ac -> d  
ab -> de  
meet-irreducibles: b acd ae bce abde acde bcde  
max antichain: b acd ae  
dimension: 3

136.  
id: 4149688087  
bc -> e  
ac -> d  
ab -> cde  
meet-irreducibles: bd acd ae bce ade bde acde bcde  
max antichain: bd acd ae bce  
dimension: 4

137.  
id: 4285992711  
abc -> de  
c -> e  
ab -> d  
meet-irreducibles: abd ace bce abde acde bcde  
max antichain: abd ace bce  
dimension: 3

138.  
id: 4285990199  
cd -> e  
ad -> e  
bc -> e  
ab -> de  
meet-irreducibles: ac bd ace bce abde acde bcde  
max antichain: ac bd bce  
dimension: 3

139.  
id: 4283904819  
ace -> d  
ab -> de  
b -> e  
meet-irreducibles: ac acd ae bce abde acde bcde  
max antichain: ac ae bce  
dimension: 3

140.

APPENDIX A.2: DESCRIPTION OF SIZE 5 GEOMETRIES

id: 4285989207  
cd -> e  
bd -> e  
ad -> e  
ac -> e  
ab -> de  
meet-irreducibles: a bc d ace bce abde acde bcde  
max antichain: a bc d  
dimension: 3

141.  
id: 4151772503  
cd -> e  
ad -> e  
ac -> e  
ab -> cde  
meet-irreducibles: a bc bd ace bce ade bde acde bcde  
max antichain: bc bd ace ade  
dimension: 4

142.  
id: 4283892567  
cd -> e  
bd -> e  
ac -> de  
ab -> de  
meet-irreducibles: bc ad ae bce abde acde bcde  
max antichain: bc ad ae  
dimension: 3

143.  
id: 4286513493  
cd -> e  
bd -> e  
abc -> de  
a -> e  
meet-irreducibles: bc d abe ace bce abde acde bcde  
max antichain: bc d abe ace  
dimension: 4

144.  
id: 4149675863  
cd -> e  
ac -> de  
ab -> cde  
meet-irreducibles: bc ad bd ae bce ade bde acde bcde

APPENDIX A.2: DESCRIPTION OF SIZE 5 GEOMETRIES

max antichain: bc ad bd ae  
dimension: 4

145.  
id: 4285990229  
cd -> e  
ab -> de  
a -> e  
meet-irreducibles: bc bd ace bce abde acde bcde  
max antichain: bc bd ace  
dimension: 3

146.  
id: 4294906129  
b -> e  
a -> e  
meet-irreducibles: cd abce abde acde bcde  
max antichain: abce abde acde bcde  
dimension: 4

147.  
id: 4286513431  
cd -> e  
bd -> e  
ad -> e  
abc -> de  
bc -> e  
ac -> e  
ab -> e  
meet-irreducibles: a b c d abe ace bce abde acde bcde  
max antichain: a b c d  
dimension: 4

148.  
id: 4285990663  
c -> e  
ab -> de  
meet-irreducibles: ad bd ace bce abde acde bcde  
max antichain: ad bd ace bce  
dimension: 4

149.  
id: 4283896151  
bd -> e  
ad -> e  
ac -> de

APPENDIX A.2: DESCRIPTION OF SIZE 5 GEOMETRIES

ab -> de  
meet-irreducibles: a bc cd ae bce abde acde bcde  
max antichain: a bc cd  
dimension: 3

150.  
id: 4285990167  
cd -> e  
ad -> e  
bc -> e  
ac -> e  
ab -> de  
meet-irreducibles: a c bd ace bce abde acde bcde  
max antichain: a c bd  
dimension: 3

151.  
id: 4283904787  
ac -> d  
ab -> de  
b -> e  
meet-irreducibles: acd ae bce abde acde bcde  
max antichain: acd ae bce  
dimension: 3

152.  
id: 4116002615  
ae -> cd  
bc -> e  
ab -> cde  
meet-irreducibles: ac ad bd acd bce bde acde bcde  
max antichain: ac ad bd bce  
dimension: 4

153.  
id: 4149679447  
bcd -> e  
ad -> e  
ac -> de  
ab -> cde  
meet-irreducibles: a bc bd cd ae bce ade bde acde bcde  
max antichain: a bc bd cd  
dimension: 4

154.  
id: 4283765591

APPENDIX A.2: DESCRIPTION OF SIZE 5 GEOMETRIES

ae -> d  
bd -> e  
ac -> de  
ab -> de  
meet-irreducibles: a bc ad cd bce abde acde bcde  
max antichain: a bc cd  
dimension: 3

155.  
id: 4294902037  
cd -> e  
bd -> e  
bc -> e  
a -> e  
meet-irreducibles: b c d abce abde acde bcde  
max antichain: abce abde acde bcde  
dimension: 4

156.  
id: 4149678935  
bd -> e  
ac -> de  
ab -> cde  
meet-irreducibles: bc ad cd ae bce ade bde acde bcde  
max antichain: bc ad cd ae bde  
dimension: 5

157.  
id: 4285988983  
d -> e  
ab -> de  
meet-irreducibles: ac bc ace bce abde acde bcde  
max antichain: ac bc abde  
dimension: 3

158.  
id: 4151772951  
cd -> e  
bc -> e  
ac -> e  
ab -> cde  
meet-irreducibles: c ad bd ace bce ade bde acde bcde  
max antichain: ad bd ace bce  
dimension: 4

159.



APPENDIX A.2: DESCRIPTION OF SIZE 5 GEOMETRIES

id: 4285993301

bd -> e

ab -> de

a -> e

meet-irreducibles: bc cd ace bce abde acde bcde

max antichain: bc cd ace abde

dimension: 4

160.

id: 4149548887

ae -> d

bcd -> e

ac -> de

ab -> cde

meet-irreducibles: a bc ad bd cd bce ade bde acde bcde

max antichain: a bc bd cd

dimension: 4

161.

id: 4283897173

bcd -> e

ac -> de

ab -> de

a -> e

meet-irreducibles: bc bd cd ae bce abde acde bcde

max antichain: bc bd cd ae

dimension: 4

162.

id: 4151776597

bcd -> e

ab -> cde

a -> e

meet-irreducibles: bc bd cd ace bce ade bde acde bcde

max antichain: bc bd cd ace ade

dimension: 5

163.

id: 4149556055

ae -> d

bd -> e

ac -> d

ab -> cde

meet-irreducibles: a bc acd bce ade bde acde bcde

max antichain: bc acd ade bde

dimension: 4

APPENDIX A.2: DESCRIPTION OF SIZE 5 GEOMETRIES

164.  
id: 4285993239  
bd -> e  
ad -> e  
bc -> e  
ac -> e  
ab -> de  
meet-irreducibles: a b cd ace bce abde acde bcde  
max antichain: cd ace bce abde  
dimension: 4

165.  
id: 4283782485  
a -> de  
meet-irreducibles: bcd bce abde acde bcde  
max antichain: bcd bce abde acde  
dimension: 4

166.  
id: 4149695829  
ac -> de  
ab -> cde  
a -> e  
meet-irreducibles: bcd ae bce ade bde acde bcde  
max antichain: bcd ae bce bde  
dimension: 4

167.  
id: 4283766613  
bcd -> e  
ac -> de  
ab -> de  
a -> d  
meet-irreducibles: bc ad bd cd bce abde acde bcde  
max antichain: bc ad bd cd  
dimension: 4

168.  
id: 4116002647  
ae -> cd  
bcd -> e  
ac -> d  
ab -> cde  
meet-irreducibles: a bc ad bd acd bce bde acde bcde  
max antichain: a bc bd

APPENDIX A.2: DESCRIPTION OF SIZE 5 GEOMETRIES

dimension: 3

169.

id: 4283897111

ad -> e

bc -> e

ac -> de

ab -> de

meet-irreducibles: a bd cd ae bce abde acde bcde

max antichain: a bd cd bce

dimension: 4

170.

id: 4151776535

ad -> e

bc -> e

ac -> e

ab -> cde

meet-irreducibles: a bd cd ace bce ade bde acde bcde

max antichain: bd cd ace bce ade

dimension: 5

171.

id: 4283896599

bd -> e

bc -> e

ac -> de

ab -> de

meet-irreducibles: b ad cd ae bce abde acde bcde

max antichain: b ad cd ae

dimension: 4

172.

id: 4283773781

bd -> e

ab -> de

a -> d

meet-irreducibles: bc acd bce abde acde bcde

max antichain: bc acd abde

dimension: 3

173.

id: 4286517525

bd -> e

abc -> de

bc -> e

APPENDIX A.2: DESCRIPTION OF SIZE 5 GEOMETRIES

a → e  
meet-irreducibles: b cd abe ace bce abde acde bcde  
max antichain: cd abe ace bce  
dimension: 4

174.  
id: 4283766551  
ae → d  
bc → e  
ac → de  
ab → de  
meet-irreducibles: a ad bd cd bce abde acde bcde  
max antichain: a bd cd bce  
dimension: 4

175.  
id: 4279703319  
bc → de  
ac → de  
ab → de  
meet-irreducibles: ad bd cd ae be ce abde acde bcde  
max antichain: ad bd cd ae be ce  
dimension: 6

176.  
id: 4149679895  
bc → e  
ac → de  
ab → cde  
meet-irreducibles: ad bd cd ae bce ade bde acde bcde  
max antichain: ad bd cd ae bce  
dimension: 5

177.  
id: 4285994261  
bc → e  
ab → de  
a → e  
meet-irreducibles: bd cd ace bce abde acde bcde  
max antichain: bd cd ace bce  
dimension: 4

178.  
id: 4283773719  
ae → d  
bd → e

APPENDIX A.2: DESCRIPTION OF SIZE 5 GEOMETRIES

bc -> e  
ac -> d  
ab -> de  
meet-irreducibles: a b acd bce abde acde bcde  
max antichain: acd bce abde  
dimension: 3

179.  
id: 4149687063  
bd -> e  
bc -> e  
ac -> d  
ab -> cde  
meet-irreducibles: b acd ae bce ade bde acde bcde  
max antichain: acd ae bce bde  
dimension: 4

180.  
id: 4286513239  
d -> e  
abc -> de  
ac -> e  
ab -> e  
meet-irreducibles: a bc abe ace bce abde acde bcde  
max antichain: bc abe ace  
dimension: 3

181.  
id: 4151772471  
cd -> e  
ad -> e  
bc -> e  
ab -> cde  
meet-irreducibles: ac bd ace bce ade bde acde bcde  
max antichain: ac bd bce ade  
dimension: 4

182.  
id: 4149687091  
ace -> d  
ab -> cde  
b -> e  
meet-irreducibles: ac acd ae bce ade bde acde bcde  
max antichain: ac ae bce bde  
dimension: 4

APPENDIX A.2: DESCRIPTION OF SIZE 5 GEOMETRIES

183.  
id: 4294902033  
cd -> e  
b -> e  
a -> e  
meet-irreducibles: c d abce abde acde bcde  
max antichain: abce abde acde bcde  
dimension: 4

184.  
id: 4286513237  
d -> e  
abc -> de  
a -> e  
meet-irreducibles: bc abe ace bce abde acde bcde  
max antichain: bc abe ace  
dimension: 3

185.  
id: 4283892055  
cd -> e  
bd -> e  
ad -> e  
ac -> de  
ab -> de  
meet-irreducibles: a bc d ae bce abde acde bcde  
max antichain: a bc d  
dimension: 3

186.  
id: 4286513175  
d -> e  
abc -> de  
bc -> e  
ac -> e  
ab -> e  
meet-irreducibles: a b c abe ace bce abde acde bcde  
max antichain: a b c  
dimension: 3

187.  
id: 4149675351  
cd -> e  
ad -> e  
ac -> de  
ab -> cde

APPENDIX A.2: DESCRIPTION OF SIZE 5 GEOMETRIES

meet-irreducibles: a bc bd ae bce ade bde acde bcde  
max antichain: a bc bd  
dimension: 3

188.  
id: 4114027831  
ad -> ce  
bc -> de  
ab -> cde  
meet-irreducibles: ac bd cd ae be ace bde acde bcde  
max antichain: ac bd cd ae be  
dimension: 5

189.  
id: 4283761495  
ae -> d  
cd -> e  
bd -> e  
ac -> de  
ab -> de  
meet-irreducibles: a bc ad bce abde acde bcde  
max antichain: bc abde acde  
dimension: 3

190.  
id: 4149674839  
cd -> e  
bd -> e  
ac -> de  
ab -> cde  
meet-irreducibles: bc ad ae bce ade bde acde bcde  
max antichain: bc ad ae bde  
dimension: 4

191.  
id: 4285989205  
cd -> e  
bd -> e  
ab -> de  
a -> e  
meet-irreducibles: bc d ace bce abde acde bcde  
max antichain: bc d ace  
dimension: 3

192.  
id: 4149544791

APPENDIX A.2: DESCRIPTION OF SIZE 5 GEOMETRIES

ae -> d  
cd -> e  
ac -> de  
ab -> cde  
meet-irreducibles: a bc ad bd bce ade bde acde bcde  
max antichain: a bc bd  
dimension: 3

193.  
id: 4283896595  
ac -> de  
ab -> de  
b -> e  
meet-irreducibles: ad cd ae bce abde acde bcde  
max antichain: ad cd ae bce  
dimension: 4

194.  
id: 4285990151  
ad -> e  
c -> e  
ab -> de  
meet-irreducibles: a bd ace bce abde acde bcde  
max antichain: a bd bce  
dimension: 3

195.  
id: 4151772501  
cd -> e  
ab -> cde  
a -> e  
meet-irreducibles: bc bd ace bce ade bde acde bcde  
max antichain: bc bd ace ade  
dimension: 4

196.  
id: 4286517521  
abc -> de  
b -> e  
a -> e  
meet-irreducibles: cd abe ace bce abde acde bcde  
max antichain: cd abe ace bce  
dimension: 4

197.  
id: 4116002103



APPENDIX A.2: DESCRIPTION OF SIZE 5 GEOMETRIES

```

ae -> cd
ad -> c
bc -> e
ab -> cde
meet-irreducibles: a ac bd acd bce bde acde bcde
max antichain: a bd bce
dimension: 3

198.
id: 4285989143
cd -> e
bd -> e
ad -> e
bc -> e
ac -> e
ab -> de
meet-irreducibles: a b c d ace bce abde acde bcde
max antichain: a b c d
dimension: 4

199.
id: 4116001591
ae -> cd
bd -> e
bc -> e
ab -> cde
meet-irreducibles: b ac ad acd bce bde acde bcde
max antichain: ac ad bce bde
dimension: 4

200.
id: 4151772935
c -> e
ab -> cde
meet-irreducibles: ad bd ace bce ade bde acde bcde
max antichain: ad bd ace bce
dimension: 4

201.
id: 4149678423
bd -> e
ad -> e
ac -> de
ab -> cde
meet-irreducibles: a bc cd ae bce ade bde acde bcde
max antichain: a bc cd bde

```

APPENDIX A.2: DESCRIPTION OF SIZE 5 GEOMETRIES

dimension: 4

202.

id: 4151772439

cd -> e

ad -> e

bc -> e

ac -> e

ab -> cde

meet-irreducibles: a c bd ace bce ade bde acde bcde

max antichain: bd ace bce ade

dimension: 4

203.

id: 4149687059

ac -> d

ab -> cde

b -> e

meet-irreducibles: acd ae bce ade bde acde bcde

max antichain: acd ae bce bde

dimension: 4

204.

id: 4283892503

cd -> e

bd -> e

bc -> e

ac -> de

ab -> de

meet-irreducibles: b c ad ae bce abde acde bcde

max antichain: b c ad ae

dimension: 4

205.

id: 4149547863

ae -> d

bd -> e

ac -> de

ab -> cde

meet-irreducibles: a bc ad cd bce ade bde acde bcde

max antichain: a bc cd bde

dimension: 4

206.

id: 4286513429

cd -> e

APPENDIX A.2: DESCRIPTION OF SIZE 5 GEOMETRIES

bd -> e  
abc -> de  
bc -> e  
a -> e  
meet-irreducibles: b c d abe ace bce abde acde bcde  
max antichain: d abe ace bce  
dimension: 4

207.  
id: 4149675799  
cd -> e  
bc -> e  
ac -> de  
ab -> cde  
meet-irreducibles: c ad bd ae bce ade bde acde bcde  
max antichain: c ad bd ae  
dimension: 4

208.  
id: 4283896149  
bd -> e  
ac -> de  
ab -> de  
a -> e  
meet-irreducibles: bc cd ae bce abde acde bcde  
max antichain: bc cd ae  
dimension: 3

209.  
id: 4285990165  
cd -> e  
bc -> e  
ab -> de  
a -> e  
meet-irreducibles: c bd ace bce abde acde bcde  
max antichain: bd ace bce  
dimension: 3

210.  
id: 4283766101  
bcd -> e  
a -> de  
meet-irreducibles: bc bd cd bce abde acde bcde  
max antichain: bc bd cd  
dimension: 3

APPENDIX A.2: DESCRIPTION OF SIZE 5 GEOMETRIES

211.  
id: 4149679445  
bcd -> e  
ac -> de  
ab -> cde  
a -> e  
meet-irreducibles: bc bd cd ae bce ade bde acde bcde  
max antichain: bc bd cd ae  
dimension: 4

212.  
id: 4283765589  
bd -> e  
ac -> de  
ab -> de  
a -> d  
meet-irreducibles: bc ad cd bce abde acde bcde  
max antichain: bc ad cd  
dimension: 3

213.  
id: 4283896087  
bd -> e  
ad -> e  
bc -> e  
ac -> de  
ab -> de  
meet-irreducibles: a b cd ae bce abde acde bcde  
max antichain: a b cd  
dimension: 3

214.  
id: 4151775511  
bd -> e  
ad -> e  
bc -> e  
ac -> e  
ab -> cde  
meet-irreducibles: a b cd ace bce ade bde acde bcde  
max antichain: cd ace bce ade bde  
dimension: 5

215.  
id: 4149564757  
ab -> cde  
a -> de

APPENDIX A.2: DESCRIPTION OF SIZE 5 GEOMETRIES

meet-irreducibles: bcd bce ade bde acde bcde  
max antichain: bcd bce ade bde  
dimension: 4

216.  
id: 4149548885  
bcd -> e  
ac -> de  
ab -> cde  
a -> d  
meet-irreducibles: bc ad bd cd bce ade bde acde bcde  
max antichain: bc ad bd cd  
dimension: 4

217.  
id: 4279702807  
ad -> e  
bc -> de  
ac -> de  
ab -> de  
meet-irreducibles: a bd cd ae be ce abde acde bcde  
max antichain: a bd cd be ce  
dimension: 5

218.  
id: 4149679383  
ad -> e  
bc -> e  
ac -> de  
ab -> cde  
meet-irreducibles: a bd cd ae bce ade bde acde bcde  
max antichain: a bd cd bce  
dimension: 4

219.  
id: 4283765527  
ae -> d  
bd -> e  
bc -> e  
ac -> de  
ab -> de  
meet-irreducibles: a b ad cd bce abde acde bcde  
max antichain: a b cd  
dimension: 3

220.

APPENDIX A.2: DESCRIPTION OF SIZE 5 GEOMETRIES

id: 4149678871  
bd -> e  
bc -> e  
ac -> de  
ab -> cde  
meet-irreducibles: b ad cd ae bce ade bde acde bcde  
max antichain: ad cd ae bce bde  
dimension: 5

221.  
id: 4149556053  
bd -> e  
ab -> cde  
a -> d  
meet-irreducibles: bc acd bce ade bde acde bcde  
max antichain: bc acd ade bde  
dimension: 4

222.  
id: 4285993237  
bd -> e  
bc -> e  
ab -> de  
a -> e  
meet-irreducibles: b cd ace bce abde acde bcde  
max antichain: cd ace bce abde  
dimension: 4

223.  
id: 4149548823  
ae -> d  
bc -> e  
ac -> de  
ab -> cde  
meet-irreducibles: a ad bd cd bce ade bde acde bcde  
max antichain: a bd cd bce  
dimension: 4

224.  
id: 4145485591  
bc -> de  
ac -> de  
ab -> cde  
meet-irreducibles: ad bd cd ae be ce ade bde acde bcde  
max antichain: ad bd cd ae be ce  
dimension: 6

APPENDIX A.2: DESCRIPTION OF SIZE 5 GEOMETRIES

225.  
id: 4116002645  
ae -> cd  
bcd -> e  
ab -> cde  
a -> d  
meet-irreducibles: bc ad bd acd bce bde acde bcde  
max antichain: bc ad bd  
dimension: 3

226.  
id: 4283897109  
bc -> e  
ac -> de  
ab -> de  
a -> e  
meet-irreducibles: bd cd ae bce abde acde bcde  
max antichain: bd cd ae bce  
dimension: 4

227.  
id: 4151776533  
bc -> e  
ab -> cde  
a -> e  
meet-irreducibles: bd cd ace bce ade bde acde bcde  
max antichain: bd cd ace bce ade  
dimension: 5

228.  
id: 4149555991  
ae -> d  
bd -> e  
bc -> e  
ac -> d  
ab -> cde  
meet-irreducibles: a b acd bce ade bde acde bcde  
max antichain: acd bce ade bde  
dimension: 4

229.  
id: 4283766549  
bc -> e  
ac -> de  
ab -> de

APPENDIX A.2: DESCRIPTION OF SIZE 5 GEOMETRIES

a -> d  
meet-irreducibles: ad bd cd bce abde acde bcde  
max antichain: ad bd cd bce  
dimension: 4

230.  
id: 4116002583  
ae -> cd  
bc -> e  
ac -> d  
ab -> cde  
meet-irreducibles: a ad bd acd bce bde acde bcde  
max antichain: a bd bce  
dimension: 3

231.  
id: 4285988951  
d -> e  
ac -> e  
ab -> de  
meet-irreducibles: a bc ace bce abde acde bcde  
max antichain: bc ace abde  
dimension: 3

232.  
id: 4283773717  
bd -> e  
bc -> e  
ab -> de  
a -> d  
meet-irreducibles: b acd bce abde acde bcde  
max antichain: acd bce abde  
dimension: 3

233.  
id: 4116002581  
ae -> cd  
bc -> e  
ab -> cde  
a -> d  
meet-irreducibles: ad bd acd bce bde acde bcde  
max antichain: ad bd bce  
dimension: 3

234.  
id: 4283892499



APPENDIX A.2: DESCRIPTION OF SIZE 5 GEOMETRIES

cd -> e  
ac -> de  
ab -> de  
b -> e  
meet-irreducibles: c ad ae bce abde acde bcde  
max antichain: c ad ae  
dimension: 3

235.  
id: 4286513425  
cd -> e  
abc -> de  
b -> e  
a -> e  
meet-irreducibles: c d abe ace bce abde acde bcde  
max antichain: d abe ace bce  
dimension: 4

236.  
id: 4285988949  
d -> e  
ab -> de  
a -> e  
meet-irreducibles: bc ace bce abde acde bcde  
max antichain: bc ace abde  
dimension: 3

237.  
id: 4149674327  
cd -> e  
bd -> e  
ad -> e  
ac -> de  
ab -> cde  
meet-irreducibles: a bc d ae bce ade bde acde bcde  
max antichain: a bc d  
dimension: 3

238.  
id: 4285988887  
d -> e  
bc -> e  
ac -> e  
ab -> de  
meet-irreducibles: a b c ace bce abde acde bcde  
max antichain: a b c

APPENDIX A.2: DESCRIPTION OF SIZE 5 GEOMETRIES

dimension: 3

239.

id: 4283896083

ad -> e

ac -> de

ab -> de

b -> e

meet-irreducibles: a cd ae bce abde acde bcde

max antichain: a cd bce

dimension: 3

240.

id: 4113896759

ae -> c

ad -> ce

bc -> de

ab -> cde

meet-irreducibles: a ac bd cd be ace bde acde bcde

max antichain: a bd cd be

dimension: 4

241.

id: 4149543767

ae -> d

cd -> e

bd -> e

ac -> de

ab -> cde

meet-irreducibles: a bc ad bce ade bde acde bcde

max antichain: a bc bde

dimension: 3

242.

id: 4285989127

bd -> e

ad -> e

c -> e

ab -> de

meet-irreducibles: a b d ace bce abde acde bcde

max antichain: a b d

dimension: 3

243.

id: 4283892053

cd -> e

APPENDIX A.2: DESCRIPTION OF SIZE 5 GEOMETRIES

bd -> e  
ac -> de  
ab -> de  
a -> e  
meet-irreducibles: bc d ae bce abde acde bcde  
max antichain: bc d ae  
dimension: 3

244.  
id: 4283765523  
ae -> d  
ac -> de  
ab -> de  
b -> e  
meet-irreducibles: a ad cd bce abde acde bcde  
max antichain: a cd bce  
dimension: 3

245.  
id: 4149678867  
ac -> de  
ab -> cde  
b -> e  
meet-irreducibles: ad cd ae bce ade bde acde bcde  
max antichain: ad cd ae bce bde  
dimension: 5

246.  
id: 4286513173  
d -> e  
abc -> de  
bc -> e  
a -> e  
meet-irreducibles: b c abe ace bce abde acde bcde  
max antichain: abe ace bce  
dimension: 3

247.  
id: 4151772423  
ad -> e  
c -> e  
ab -> cde  
meet-irreducibles: a bd ace bce ade bde acde bcde  
max antichain: bd ace bce ade  
dimension: 4

APPENDIX A.2: DESCRIPTION OF SIZE 5 GEOMETRIES

248.  
id: 4149675349  
cd -> e  
ac -> de  
ab -> cde  
a -> e  
meet-irreducibles: bc bd ae bce ade bde acde bcde  
max antichain: bc bd ae  
dimension: 3

249.  
id: 4285993233  
ab -> de  
b -> e  
a -> e  
meet-irreducibles: cd ace bce abde acde bcde  
max antichain: cd ace bce abde  
dimension: 4

250.  
id: 4283761493  
cd -> e  
bd -> e  
ac -> de  
ab -> de  
a -> d  
meet-irreducibles: bc ad bce abde acde bcde  
max antichain: bc abde acde  
dimension: 3

251.  
id: 4283891991  
cd -> e  
bd -> e  
ad -> e  
bc -> e  
ac -> de  
ab -> de  
meet-irreducibles: a b c d ae bce abde acde bcde  
max antichain: a b c d  
dimension: 4

252.  
id: 4151771415  
cd -> e  
bd -> e

APPENDIX A.2: DESCRIPTION OF SIZE 5 GEOMETRIES

ad -> e  
bc -> e  
ac -> e  
ab -> cde  
meet-irreducibles: a b c d ace bce ade bde acde bcde  
max antichain: a b c d  
dimension: 4

253.  
id: 4149675783  
ac -> de  
c -> e  
ab -> cde  
meet-irreducibles: ad bd ae bce ade bde acde bcde  
max antichain: ad bd ae bce  
dimension: 4

254.  
id: 4149544789  
cd -> e  
ac -> de  
ab -> cde  
a -> d  
meet-irreducibles: bc ad bd bce ade bde acde bcde  
max antichain: bc ad bd  
dimension: 3

255.  
id: 4149675287  
cd -> e  
ad -> e  
bc -> e  
ac -> de  
ab -> cde  
meet-irreducibles: a c bd ae bce ade bde acde bcde  
max antichain: a c bd  
dimension: 3

256.  
id: 4285990149  
c -> e  
ab -> de  
a -> e  
meet-irreducibles: bd ace bce abde acde bcde  
max antichain: bd ace bce  
dimension: 3

APPENDIX A.2: DESCRIPTION OF SIZE 5 GEOMETRIES

257.

id: 4283761431

ae -> d

cd -> e

bd -> e

bc -> e

ac -> de

ab -> de

meet-irreducibles: a b c ad bce abde acde bcde

max antichain: a b c

dimension: 3

258.

id: 4149674775

cd -> e

bd -> e

bc -> e

ac -> de

ab -> cde

meet-irreducibles: b c ad ae bce ade bde acde bcde

max antichain: b c ad ae

dimension: 4

259.

id: 4116002101

ae -> cd

bc -> e

ab -> cde

a -> c

meet-irreducibles: ac bd acd bce bde acde bcde

max antichain: ac bd bce

dimension: 3

260.

id: 4285989141

cd -> e

bd -> e

bc -> e

ab -> de

a -> e

meet-irreducibles: b c d ace bce abde acde bcde

max antichain: b c d

dimension: 3

261.

APPENDIX A.2: DESCRIPTION OF SIZE 5 GEOMETRIES

id: 4149544727  
ae -> d  
cd -> e  
bc -> e  
ac -> de  
ab -> cde  
meet-irreducibles: a c ad bd bce ade bde acde bcde  
max antichain: a c bd  
dimension: 3

262.  
id: 4145481495  
cd -> e  
bc -> de  
ac -> de  
ab -> cde  
meet-irreducibles: c ad bd ae be ce ade bde acde bcde  
max antichain: c ad bd ae be  
dimension: 5

263.  
id: 4283765077  
bd -> e  
a -> de  
meet-irreducibles: bc cd bce abde acde bcde  
max antichain: bc cd abde  
dimension: 3

264.  
id: 4149678421  
bd -> e  
ac -> de  
ab -> cde  
a -> e  
meet-irreducibles: bc cd ae bce ade bde acde bcde  
max antichain: bc cd ae bde  
dimension: 4

265.  
id: 4283773713  
ab -> de  
b -> e  
a -> d  
meet-irreducibles: acd bce abde acde bcde  
max antichain: acd bce abde  
dimension: 3

APPENDIX A.2: DESCRIPTION OF SIZE 5 GEOMETRIES

266.  
id: 4151772437  
cd -> e  
bc -> e  
ab -> cde  
a -> e  
meet-irreducibles: c bd ace bce ade bde acde bcde  
max antichain: bd ace bce ade  
dimension: 4

267.  
id: 4149548373  
bcd -> e  
ab -> cde  
a -> de  
meet-irreducibles: bc bd cd bce ade bde acde bcde  
max antichain: bc bd cd ade  
dimension: 4

268.  
id: 4149547861  
bd -> e  
ac -> de  
ab -> cde  
a -> d  
meet-irreducibles: bc ad cd bce ade bde acde bcde  
max antichain: bc ad cd bde  
dimension: 4

269.  
id: 4279701783  
bd -> e  
ad -> e  
bc -> de  
ac -> de  
ab -> de  
meet-irreducibles: a b cd ae be ce abde acde bcde  
max antichain: a b cd ce  
dimension: 4

270.  
id: 4149678359  
bd -> e  
ad -> e  
bc -> e



APPENDIX A.2: DESCRIPTION OF SIZE 5 GEOMETRIES

ac -> de  
ab -> cde  
meet-irreducibles: a b cd ae bce ade bde acde bcde  
max antichain: a cd bce bde  
dimension: 4

271.  
id: 4116010325  
a -> cde  
meet-irreducibles: bcd bce bde acde bcde  
max antichain: bcd bce bde acde  
dimension: 4

272.  
id: 4145485079  
ad -> e  
bc -> de  
ac -> de  
ab -> cde  
meet-irreducibles: a bd cd ae be ce ade bde acde bcde  
max antichain: a bd cd be ce  
dimension: 5

273.  
id: 4114027799  
ad -> ce  
bc -> de  
ac -> e  
ab -> cde  
meet-irreducibles: a bd cd ae be ace bde acde bcde  
max antichain: a bd cd be  
dimension: 4

274.  
id: 4116002133  
bcd -> e  
ab -> cde  
a -> cd  
meet-irreducibles: bc bd acd bce bde acde bcde  
max antichain: bc bd acd  
dimension: 3

275.  
id: 4279571223  
ae -> d  
bd -> e

APPENDIX A.2: DESCRIPTION OF SIZE 5 GEOMETRIES

bc -> de  
ac -> de  
ab -> de  
meet-irreducibles: a b ad cd be ce abde acde bcde  
max antichain: a b cd ce  
dimension: 4

276.  
id: 4149547799  
ae -> d  
bd -> e  
bc -> e  
ac -> de  
ab -> cde  
meet-irreducibles: a b ad cd bce ade bde acde bcde  
max antichain: a cd bce bde  
dimension: 4

277.  
id: 4283896085  
bd -> e  
bc -> e  
ac -> de  
ab -> de  
a -> e  
meet-irreducibles: b cd ae bce abde acde bcde  
max antichain: b cd ae  
dimension: 3

278.  
id: 4151775509  
bd -> e  
bc -> e  
ab -> cde  
a -> e  
meet-irreducibles: b cd ace bce ade bde acde bcde  
max antichain: cd ace bce ade bde  
dimension: 5

279.  
id: 4283766037  
bc -> e  
a -> de  
meet-irreducibles: bd cd bce abde acde bcde  
max antichain: bd cd bce  
dimension: 3

APPENDIX A.2: DESCRIPTION OF SIZE 5 GEOMETRIES

280.  
id: 4279702805  
bc -> de  
ac -> de  
ab -> de  
a -> e  
meet-irreducibles: bd cd ae be ce abde acde bcde  
max antichain: bd cd ae be ce  
dimension: 5

281.  
id: 4149679381  
bc -> e  
ac -> de  
ab -> cde  
a -> e  
meet-irreducibles: bd cd ae bce ade bde acde bcde  
max antichain: bd cd ae bce  
dimension: 4

282.  
id: 4283765525  
bd -> e  
bc -> e  
ac -> de  
ab -> de  
a -> d  
meet-irreducibles: b ad cd bce abde acde bcde  
max antichain: b ad cd  
dimension: 3

283.  
id: 4116001559  
ae -> cd  
bd -> e  
bc -> e  
ac -> d  
ab -> cde  
meet-irreducibles: a b ad acd bce bde acde bcde  
max antichain: a bce bde  
dimension: 3

284.  
id: 4149548821  
bc -> e

APPENDIX A.2: DESCRIPTION OF SIZE 5 GEOMETRIES

ac -> de  
ab -> cde  
a -> d  
meet-irreducibles: ad bd cd bce ade bde acde bcde  
max antichain: ad bd cd bce  
dimension: 4

285.  
id: 4283891799  
d -> e  
ac -> de  
ab -> de  
meet-irreducibles: a bc ae bce abde acde bcde  
max antichain: bc abde acde  
dimension: 3

286.  
id: 4294902017  
c -> e  
b -> e  
a -> e  
meet-irreducibles: d abce abde acde bcde  
max antichain: abce abde acde bcde  
dimension: 4

287.  
id: 4116001587  
ae -> cd  
ab -> cde  
b -> e  
meet-irreducibles: ac ad acd bce bde acde bcde  
max antichain: ac ad bce bde  
dimension: 4

288.  
id: 4114023735  
cd -> e  
ad -> ce  
bc -> de  
ab -> cde  
meet-irreducibles: ac bd ae be ace bde acde bcde  
max antichain: ac bd ae be  
dimension: 4

289.  
id: 4149555989

APPENDIX A.2: DESCRIPTION OF SIZE 5 GEOMETRIES

bd -> e  
bc -> e  
ab -> cde  
a -> d  
meet-irreducibles: b acd bce ade bde acde bcde  
max antichain: acd bce ade bde  
dimension: 4

290.  
id: 4283761427  
ae -> d  
cd -> e  
ac -> de  
ab -> de  
b -> e  
meet-irreducibles: a c ad bce abde acde bcde  
max antichain: bce abde acde  
dimension: 3

291.  
id: 4149674771  
cd -> e  
ac -> de  
ab -> cde  
b -> e  
meet-irreducibles: c ad ae bce ade bde acde bcde  
max antichain: c ad ae bde  
dimension: 4

292.  
id: 4285989137  
cd -> e  
ab -> de  
b -> e  
a -> e  
meet-irreducibles: c d ace bce abde acde bcde  
max antichain: d ace bce  
dimension: 3

293.  
id: 4285988871  
d -> e  
c -> e  
ab -> de  
meet-irreducibles: a b ace bce abde acde bcde  
max antichain: ace bce abde

APPENDIX A.2: DESCRIPTION OF SIZE 5 GEOMETRIES

dimension: 3

294.

id: 4283891797

d -> e

ac -> de

ab -> de

a -> e

meet-irreducibles: bc ae bce abde acde bcde

max antichain: bc abde acde

dimension: 3

295.

id: 4283891735

d -> e

bc -> e

ac -> de

ab -> de

meet-irreducibles: a b c ae bce abde acde bcde

max antichain: a b c

dimension: 3

296.

id: 4113895735

ae -> c

bd -> e

ad -> ce

bc -> de

ab -> cde

meet-irreducibles: a b ac cd be ace bde acde bcde

max antichain: a b cd

dimension: 3

297.

id: 4149678355

ad -> e

ac -> de

ab -> cde

b -> e

meet-irreducibles: a cd ae bce ade bde acde bcde

max antichain: a cd bce bde

dimension: 4

298.

id: 4113634615

be -> d

APPENDIX A.2: DESCRIPTION OF SIZE 5 GEOMETRIES

ae -> c  
ad -> ce  
bc -> de  
ab -> cde  
meet-irreducibles: a b ac bd cd ace bde acde bcde  
max antichain: a b cd  
dimension: 3

299.  
id: 4151771399  
bd -> e  
ad -> e  
c -> e  
ab -> cde  
meet-irreducibles: a b d ace bce ade bde acde bcde  
max antichain: ace bce ade bde  
dimension: 4

300.  
id: 4283760981  
cd -> e  
bd -> e  
a -> de  
meet-irreducibles: bc d bce abde acde bcde  
max antichain: bc abde acde  
dimension: 3

301.  
id: 4149674325  
cd -> e  
bd -> e  
ac -> de  
ab -> cde  
a -> e  
meet-irreducibles: bc d ae bce ade bde acde bcde  
max antichain: bc d ae  
dimension: 3

302.  
id: 4149547795  
ae -> d  
ac -> de  
ab -> cde  
b -> e  
meet-irreducibles: a ad cd bce ade bde acde bcde  
max antichain: a cd bce bde

APPENDIX A.2: DESCRIPTION OF SIZE 5 GEOMETRIES

dimension: 4

303.

id: 4285988885

d -> e

bc -> e

ab -> de

a -> e

meet-irreducibles: b c ace bce abde acde bcde

max antichain: ace bce abde

dimension: 3

304.

id: 4149675271

ad -> e

ac -> de

c -> e

ab -> cde

meet-irreducibles: a bd ae bce ade bde acde bcde

max antichain: a bd bce

dimension: 3

305.

id: 4149544277

cd -> e

ab -> cde

a -> de

meet-irreducibles: bc bd bce ade bde acde bcde

max antichain: bc bd ade

dimension: 3

306.

id: 4283896081

ac -> de

ab -> de

b -> e

a -> e

meet-irreducibles: cd ae bce abde acde bcde

max antichain: cd ae bce

dimension: 3

307.

id: 4151775505

ab -> cde

b -> e

a -> e



APPENDIX A.2: DESCRIPTION OF SIZE 5 GEOMETRIES

meet-irreducibles: cd ace bce ade bde acde bcde  
max antichain: cd ace bce ade bde  
dimension: 5

308.

id: 4113896757  
ad -> ce  
bc -> de  
ab -> cde  
a -> c  
meet-irreducibles: ac bd cd be ace bde acde bcde  
max antichain: ac bd cd be  
dimension: 4

309.

id: 4149674759  
bd -> e  
ac -> de  
c -> e  
ab -> cde  
meet-irreducibles: b ad ae bce ade bde acde bcde  
max antichain: ad ae bce bde  
dimension: 4

310.

id: 4149543765  
cd -> e  
bd -> e  
ac -> de  
ab -> cde  
a -> d  
meet-irreducibles: bc ad bce ade bde acde bcde  
max antichain: bc ad bde  
dimension: 3

311.

id: 4279697687  
cd -> e  
bd -> e  
ad -> e  
bc -> de  
ac -> de  
ab -> de  
meet-irreducibles: a b c d ae be ce abde acde bcde  
max antichain: a b c d  
dimension: 4

APPENDIX A.2: DESCRIPTION OF SIZE 5 GEOMETRIES

312.  
id: 4149674263  
cd -> e  
bd -> e  
ad -> e  
bc -> e  
ac -> de  
ab -> cde  
meet-irreducibles: a b c d ae bce ade bde acde bcde  
max antichain: a b c d  
dimension: 4

313.  
id: 4285989125  
bd -> e  
c -> e  
ab -> de  
a -> e  
meet-irreducibles: b d ace bce abde acde bcde  
max antichain: b d ace  
dimension: 3

314.  
id: 4149544711  
ae -> d  
ac -> de  
c -> e  
ab -> cde  
meet-irreducibles: a ad bd bce ade bde acde bcde  
max antichain: a bd bce  
dimension: 3

315.  
id: 4145481479  
bc -> de  
ac -> de  
c -> e  
ab -> cde  
meet-irreducibles: ad bd ae be ce ade bde acde bcde  
max antichain: ad bd ae be ce  
dimension: 5

316.  
id: 4283765521  
ac -> de

APPENDIX A.2: DESCRIPTION OF SIZE 5 GEOMETRIES

ab -> de  
b -> e  
a -> d  
meet-irreducibles: ad cd bce abde acde bcde  
max antichain: ad cd bce  
dimension: 3

317.  
id: 4116001555  
ae -> cd  
ac -> d  
ab -> cde  
b -> e  
meet-irreducibles: a ad acd bce bde acde bcde  
max antichain: a bce bde  
dimension: 3

318.  
id: 4145480983  
cd -> e  
ad -> e  
bc -> de  
ac -> de  
ab -> cde  
meet-irreducibles: a c bd ae be ce ade bde acde bcde  
max antichain: a c bd be  
dimension: 4

319.  
id: 4114023703  
cd -> e  
ad -> ce  
bc -> de  
ac -> e  
ab -> cde  
meet-irreducibles: a c bd ae be ace bde acde bcde  
max antichain: a c bd be  
dimension: 4

320.  
id: 4151772421  
c -> e  
ab -> cde  
a -> e  
meet-irreducibles: bd ace bce ade bde acde bcde  
max antichain: bd ace bce ade

APPENDIX A.2: DESCRIPTION OF SIZE 5 GEOMETRIES

dimension: 4

321.

id: 4279567127

ae -> d

cd -> e

bd -> e

bc -> de

ac -> de

ab -> de

meet-irreducibles: a b c ad be ce abde acde bcde

max antichain: a b c

dimension: 3

322.

id: 4149543703

ae -> d

cd -> e

bd -> e

bc -> e

ac -> de

ab -> cde

meet-irreducibles: a b c ad bce ade bde acde bcde

max antichain: a b c

dimension: 3

323.

id: 4283891989

cd -> e

bd -> e

bc -> e

ac -> de

ab -> de

a -> e

meet-irreducibles: b c d ae bce abde acde bcde

max antichain: b c d ae

dimension: 4

324.

id: 4151771413

cd -> e

bd -> e

bc -> e

ab -> cde

a -> e

meet-irreducibles: b c d ace bce ade bde acde bcde

APPENDIX A.2: DESCRIPTION OF SIZE 5 GEOMETRIES

max antichain: ace bce ade bde  
dimension: 4

325.  
id: 4145350423  
ae -> d  
cd -> e  
bc -> de  
ac -> de  
ab -> cde  
meet-irreducibles: a c ad bd be ce ade bde acde bcde  
max antichain: a c bd be  
dimension: 4

326.  
id: 4149547349  
bd -> e  
ab -> cde  
a -> de  
meet-irreducibles: bc cd bce ade bde acde bcde  
max antichain: bc cd ade bde  
dimension: 4

327.  
id: 4149555985  
ab -> cde  
b -> e  
a -> d  
meet-irreducibles: acd bce ade bde acde bcde  
max antichain: acd bce ade bde  
dimension: 4

328.  
id: 4149675285  
cd -> e  
bc -> e  
ac -> de  
ab -> cde  
a -> e  
meet-irreducibles: c bd ae bce ade bde acde bcde  
max antichain: c bd ae  
dimension: 3

329.  
id: 4115993941  
bcd -> e

APPENDIX A.2: DESCRIPTION OF SIZE 5 GEOMETRIES

a -> cde  
meet-irreducibles: bc bd cd bce bde acde bcde  
max antichain: bc bd cd  
dimension: 3

330.  
id: 4283761429  
cd -> e  
bd -> e  
bc -> e  
ac -> de  
ab -> de  
a -> d  
meet-irreducibles: b c ad bce abde acde bcde  
max antichain: b c ad  
dimension: 3

331.  
id: 4145484055  
bd -> e  
ad -> e  
bc -> de  
ac -> de  
ab -> cde  
meet-irreducibles: a b cd ae be ce ade bde acde bcde  
max antichain: a b cd ce  
dimension: 4

332.  
id: 4114026775  
bd -> e  
ad -> ce  
bc -> de  
ac -> e  
ab -> cde  
meet-irreducibles: a b cd ae be ace bde acde bcde  
max antichain: a b cd  
dimension: 3

333.  
id: 4149544725  
cd -> e  
bc -> e  
ac -> de  
ab -> cde  
a -> d

APPENDIX A.2: DESCRIPTION OF SIZE 5 GEOMETRIES

meet-irreducibles: c ad bd bce ade bde acde bcde  
max antichain: c ad bd  
dimension: 3

334.  
id: 3579139413  
a -> bcde  
meet-irreducibles: bcd bce bde cde bcde  
max antichain: bcd bce bde cde  
dimension: 4

335.  
id: 4145353495  
ae -> d  
bd -> e  
bc -> de  
ac -> de  
ab -> cde  
meet-irreducibles: a b ad cd be ce ade bde acde bcde  
max antichain: a b cd ce  
dimension: 4

336.  
id: 4283765013  
bd -> e  
bc -> e  
a -> de  
meet-irreducibles: b cd bce abde acde bcde  
max antichain: cd bce abde  
dimension: 3

337.  
id: 4279701781  
bd -> e  
bc -> de  
ac -> de  
ab -> de  
a -> e  
meet-irreducibles: b cd ae be ce abde acde bcde  
max antichain: b cd ae ce  
dimension: 4

338.  
id: 4149678357  
bd -> e  
bc -> e

APPENDIX A.2: DESCRIPTION OF SIZE 5 GEOMETRIES

ac -> de  
ab -> cde  
a -> e  
meet-irreducibles: b cd ae bce ade bde acde bcde  
max antichain: cd ae bce bde  
dimension: 4

339.  
id: 4294901761  
d -> e  
c -> e  
b -> e  
a -> e  
meet-irreducibles: abce abde acde bcde  
max antichain: abce abde acde bcde  
dimension: 4

340.  
id: 4279571733  
bc -> de  
a -> de  
meet-irreducibles: bd cd be ce abde acde bcde  
max antichain: bd cd be ce  
dimension: 4

341.  
id: 4149548309  
bc -> e  
ab -> cde  
a -> de  
meet-irreducibles: bd cd bce ade bde acde bcde  
max antichain: bd cd bce ade  
dimension: 4

342.  
id: 4145485077  
bc -> de  
ac -> de  
ab -> cde  
a -> e  
meet-irreducibles: bd cd ae be ce ade bde acde bcde  
max antichain: bd cd ae be ce  
dimension: 5

343.  
id: 4114027797



APPENDIX A.2: DESCRIPTION OF SIZE 5 GEOMETRIES

ad -> ce  
bc -> de  
ab -> cde  
a -> e  
meet-irreducibles: bd cd ae be ace bde acde bcde  
max antichain: bd cd ae be  
dimension: 4

344.  
id: 4279571221  
bd -> e  
bc -> de  
ac -> de  
ab -> de  
a -> d  
meet-irreducibles: b ad cd be ce abde acde bcde  
max antichain: b ad cd ce  
dimension: 4

345.  
id: 4149547797  
bd -> e  
bc -> e  
ac -> de  
ab -> cde  
a -> d  
meet-irreducibles: b ad cd bce ade bde acde bcde  
max antichain: ad cd bce bde  
dimension: 4

346.  
id: 4286513169  
d -> e  
abc -> de  
b -> e  
a -> e  
meet-irreducibles: c abe ace bce abde acde bcde  
max antichain: abe ace bce  
dimension: 3

347.  
id: 4283892483  
ac -> de  
c -> e  
ab -> de  
b -> e

APPENDIX A.2: DESCRIPTION OF SIZE 5 GEOMETRIES

meet-irreducibles: ad ae bce abde acde bcde  
max antichain: ad ae bce  
dimension: 3

348.  
id: 4116002069  
bc -> e  
ab -> cde  
a -> cd  
meet-irreducibles: bd acd bce bde acde bcde  
max antichain: bd acd bce  
dimension: 3

349.  
id: 4283891987  
cd -> e  
ad -> e  
ac -> de  
ab -> de  
b -> e  
meet-irreducibles: a c d ae bce abde acde bcde  
max antichain: a c d  
dimension: 3

350.  
id: 4149674071  
d -> e  
ac -> de  
ab -> cde  
meet-irreducibles: a bc ae bce ade bde acde bcde  
max antichain: a bc bde  
dimension: 3

351.  
id: 4286513409  
abc -> de  
c -> e  
b -> e  
a -> e  
meet-irreducibles: d abe ace bce abde acde bcde  
max antichain: d abe ace bce  
dimension: 4

352.  
id: 4113892663  
ae -> c

APPENDIX A.2: DESCRIPTION OF SIZE 5 GEOMETRIES

cd -> e  
ad -> ce  
bc -> de  
ab -> cde  
meet-irreducibles: a ac bd be ace bde acde bcde  
max antichain: a bd be  
dimension: 3

353.  
id: 4116001557  
ae -> cd  
bd -> e  
bc -> e  
ab -> cde  
a -> d  
meet-irreducibles: b ad acd bce bde acde bcde  
max antichain: ad bce bde  
dimension: 3

354.  
id: 4279567123  
ae -> d  
cd -> e  
bc -> de  
ac -> de  
ab -> de  
b -> e  
meet-irreducibles: a c ad be ce abde acde bcde  
max antichain: a c be  
dimension: 3

355.  
id: 4149543699  
ae -> d  
cd -> e  
ac -> de  
ab -> cde  
b -> e  
meet-irreducibles: a c ad bce ade bde acde bcde  
max antichain: a c bde  
dimension: 3

356.  
id: 4283891985  
cd -> e  
ac -> de

APPENDIX A.2: DESCRIPTION OF SIZE 5 GEOMETRIES

ab -> de  
b -> e  
a -> e  
meet-irreducibles: c d ae bce abde acde bcde  
max antichain: c d ae  
dimension: 3

357.  
id: 4151771409  
cd -> e  
ab -> cde  
b -> e  
a -> e  
meet-irreducibles: c d ace bce ade bde acde bcde  
max antichain: ace bce ade bde  
dimension: 4

358.  
id: 4151771143  
d -> e  
c -> e  
ab -> cde  
meet-irreducibles: a b ace bce ade bde acde bcde  
max antichain: ace bce ade bde  
dimension: 4

359.  
id: 4283760725  
d -> e  
a -> de  
meet-irreducibles: bc bce abde acde bcde  
max antichain: bc abde acde  
dimension: 3

360.  
id: 4149674069  
d -> e  
ac -> de  
ab -> cde  
a -> e  
meet-irreducibles: bc ae bce ade bde acde bcde  
max antichain: bc ae bde  
dimension: 3

361.  
id: 4113892661

APPENDIX A.2: DESCRIPTION OF SIZE 5 GEOMETRIES

cd -> e  
ad -> ce  
bc -> de  
ab -> cde  
a -> c  
meet-irreducibles: ac bd be ace bde acde bcde  
max antichain: ac bd be  
dimension: 3

362.  
id: 4283761425  
cd -> e  
ac -> de  
ab -> de  
b -> e  
a -> d  
meet-irreducibles: c ad bce abde acde bcde  
max antichain: bce abde acde  
dimension: 3

363.  
id: 4279697431  
d -> e  
bc -> de  
ac -> de  
ab -> de  
meet-irreducibles: a b c ae be ce abde acde bcde  
max antichain: a b c  
dimension: 3

364.  
id: 4149674007  
d -> e  
bc -> e  
ac -> de  
ab -> cde  
meet-irreducibles: a b c ae bce ade bde acde bcde  
max antichain: a b c  
dimension: 3

365.  
id: 4285988869  
d -> e  
c -> e  
ab -> de  
a -> e

APPENDIX A.2: DESCRIPTION OF SIZE 5 GEOMETRIES

meet-irreducibles: b ace bce abde acde bcde  
max antichain: ace bce abde  
dimension: 3

366.

id: 4149674247

bd -> e

ad -> e

ac -> de

c -> e

ab -> cde

meet-irreducibles: a b d ae bce ade bde acde bcde

max antichain: a b d

dimension: 3

367.

id: 4149543253

cd -> e

bd -> e

ab -> cde

a -> de

meet-irreducibles: bc d bce ade bde acde bcde

max antichain: bc ade bde

dimension: 3

368.

id: 4283891733

d -> e

bc -> e

ac -> de

ab -> de

a -> e

meet-irreducibles: b c ae bce abde acde bcde

max antichain: b c ae

dimension: 3

369.

id: 4113895733

bd -> e

ad -> ce

bc -> de

ab -> cde

a -> c

meet-irreducibles: b ac cd be ace bde acde bcde

max antichain: b ac cd

dimension: 3

APPENDIX A.2: DESCRIPTION OF SIZE 5 GEOMETRIES

370.  
id: 4145480967  
ad -> e  
bc -> de  
ac -> de  
c -> e  
ab -> cde  
meet-irreducibles: a bd ae be ce ade bde acde bcde  
max antichain: a bd be ce  
dimension: 4

371.  
id: 4114023687  
ad -> ce  
bc -> de  
c -> e  
ab -> cde  
meet-irreducibles: a bd ae be ace bde acde bcde  
max antichain: a bd be  
dimension: 3

372.  
id: 4115989845  
cd -> e  
a -> cde  
meet-irreducibles: bc bd bce bde acde bcde  
max antichain: bc bd acde  
dimension: 3

373.  
id: 4283765009  
b -> e  
a -> de  
meet-irreducibles: cd bce abde acde bcde  
max antichain: cd bce abde  
dimension: 3

374.  
id: 4279701777  
bc -> de  
ac -> de  
ab -> de  
b -> e  
a -> e  
meet-irreducibles: cd ae be ce abde acde bcde

APPENDIX A.2: DESCRIPTION OF SIZE 5 GEOMETRIES

max antichain: cd ae be ce  
dimension: 4

375.  
id: 4149678353  
ac -> de  
ab -> cde  
b -> e  
a -> e  
meet-irreducibles: cd ae bce ade bde acde bcde  
max antichain: cd ae bce bde  
dimension: 4

376.  
id: 4149543687  
ae -> d  
bd -> e  
ac -> de  
c -> e  
ab -> cde  
meet-irreducibles: a b ad bce ade bde acde bcde  
max antichain: a bce bde  
dimension: 3

377.  
id: 4113634613  
be -> d  
ad -> ce  
bc -> de  
ab -> cde  
a -> c  
meet-irreducibles: b ac bd cd ace bde acde bcde  
max antichain: b ac cd  
dimension: 3

378.  
id: 4145479959  
cd -> e  
bd -> e  
ad -> e  
bc -> de  
ac -> de  
ab -> cde  
meet-irreducibles: a b c d ae be ce ade bde acde bcde  
max antichain: a b c d  
dimension: 4



APPENDIX A.2: DESCRIPTION OF SIZE 5 GEOMETRIES

379.  
id: 4114022679  
cd -> e  
bd -> e  
ad -> ce  
bc -> de  
ac -> e  
ab -> cde  
meet-irreducibles: a b c d ae be ace bde acde bcde  
max antichain: a b c d  
dimension: 4

380.  
id: 4151771397  
bd -> e  
c -> e  
ab -> cde  
a -> e  
meet-irreducibles: b d ace bce ade bde acde bcde  
max antichain: ace bce ade bde  
dimension: 4

381.  
id: 4145350407  
ae -> d  
bc -> de  
ac -> de  
c -> e  
ab -> cde  
meet-irreducibles: a ad bd be ce ade bde acde bcde  
max antichain: a bd be ce  
dimension: 4

382.  
id: 4144432903  
c -> de  
ab -> cde  
meet-irreducibles: ad bd ae be ade bde acde bcde  
max antichain: ad bd ae be  
dimension: 4

383.  
id: 4279571217  
bc -> de  
ac -> de

APPENDIX A.2: DESCRIPTION OF SIZE 5 GEOMETRIES

ab -> de  
b -> e  
a -> d  
meet-irreducibles: ad cd be ce abde acde bcde  
max antichain: ad cd be ce  
dimension: 4

384.  
id: 4149547793  
ac -> de  
ab -> cde  
b -> e  
a -> d  
meet-irreducibles: ad cd bce ade bde acde bcde  
max antichain: ad cd bce bde  
dimension: 4

385.  
id: 4149675269  
ac -> de  
c -> e  
ab -> cde  
a -> e  
meet-irreducibles: bd ae bce ade bde acde bcde  
max antichain: bd ae bce  
dimension: 3

386.  
id: 4145349399  
ae -> d  
cd -> e  
bd -> e  
bc -> de  
ac -> de  
ab -> cde  
meet-irreducibles: a b c ad be ce ade bde acde bcde  
max antichain: a b c  
dimension: 3

387.  
id: 4283760917  
cd -> e  
bd -> e  
bc -> e  
a -> de  
meet-irreducibles: b c d bce abde acde bcde

APPENDIX A.2: DESCRIPTION OF SIZE 5 GEOMETRIES

max antichain: b c d  
dimension: 3

388.  
id: 4279697685  
cd -> e  
bd -> e  
bc -> de  
ac -> de  
ab -> de  
a -> e  
meet-irreducibles: b c d ae be ce abde acde bcde  
max antichain: b c d ae  
dimension: 4

389.  
id: 4149674261  
cd -> e  
bd -> e  
bc -> e  
ac -> de  
ab -> cde  
a -> e  
meet-irreducibles: b c d ae bce ade bde acde bcde  
max antichain: b c d ae  
dimension: 4

390.  
id: 4145088279  
be -> d  
ae -> d  
cd -> e  
bc -> de  
ac -> de  
ab -> cde  
meet-irreducibles: a b c ad bd ce ade bde acde bcde  
max antichain: a b c  
dimension: 3

391.  
id: 4149544709  
ac -> de  
c -> e  
ab -> cde  
a -> d  
meet-irreducibles: ad bd bce ade bde acde bcde

APPENDIX A.2: DESCRIPTION OF SIZE 5 GEOMETRIES

max antichain: ad bd bce  
dimension: 3

392.  
id: 4149544213  
cd -> e  
bc -> e  
ab -> cde  
a -> de  
meet-irreducibles: c bd bce ade bde acde bcde  
max antichain: c bd ade  
dimension: 3

393.  
id: 4116001553  
ae -> cd  
ab -> cde  
b -> e  
a -> d  
meet-irreducibles: ad acd bce bde acde bcde  
max antichain: ad bce bde  
dimension: 3

394.  
id: 4145480981  
cd -> e  
bc -> de  
ac -> de  
ab -> cde  
a -> e  
meet-irreducibles: c bd ae be ce ade bde acde bcde  
max antichain: c bd ae be  
dimension: 4

395.  
id: 4114023701  
cd -> e  
ad -> ce  
bc -> de  
ab -> cde  
a -> e  
meet-irreducibles: c bd ae be ace bde acde bcde  
max antichain: c bd ae be  
dimension: 4

396.

APPENDIX A.2: DESCRIPTION OF SIZE 5 GEOMETRIES

id: 3579123029

bcd -> e

a -> bcde

meet-irreducibles: bc bd cd bce bde cde bcde

max antichain: bc bd cd

dimension: 3

397.

id: 4279567125

cd -> e

bd -> e

bc -> de

ac -> de

ab -> de

a -> d

meet-irreducibles: b c ad be ce abde acde bcde

max antichain: b c ad

dimension: 3

398.

id: 4149543701

cd -> e

bd -> e

bc -> e

ac -> de

ab -> cde

a -> d

meet-irreducibles: b c ad bce ade bde acde bcde

max antichain: b c ad

dimension: 3

399.

id: 4145350421

cd -> e

bc -> de

ac -> de

ab -> cde

a -> d

meet-irreducibles: c ad bd be ce ade bde acde bcde

max antichain: c ad bd be

dimension: 4

400.

id: 4283891731

d -> e

ac -> de

APPENDIX A.2: DESCRIPTION OF SIZE 5 GEOMETRIES

ab -> de  
b -> e  
meet-irreducibles: a c ae bce abde acde bcde  
max antichain: bce abde acde  
dimension: 3

401.  
id: 4113895731  
ae -> c  
ad -> ce  
bc -> de  
ab -> cde  
b -> e  
meet-irreducibles: a ac cd be ace bde acde bcde  
max antichain: a cd be  
dimension: 3

402.  
id: 4279570709  
bd -> e  
bc -> de  
a -> de  
meet-irreducibles: b cd be ce abde acde bcde  
max antichain: b cd ce  
dimension: 3

403.  
id: 4149547285  
bd -> e  
bc -> e  
ab -> cde  
a -> de  
meet-irreducibles: b cd bce ade bde acde bcde  
max antichain: cd bce ade bde  
dimension: 4

404.  
id: 4145484053  
bd -> e  
bc -> de  
ac -> de  
ab -> cde  
a -> e  
meet-irreducibles: b cd ae be ce ade bde acde bcde  
max antichain: b cd ae ce  
dimension: 4

APPENDIX A.2: DESCRIPTION OF SIZE 5 GEOMETRIES

405.  
id: 4114026773  
bd -> e  
ad -> ce  
bc -> de  
ab -> cde  
a -> e  
meet-irreducibles: b cd ae be ace bde acde bcde  
max antichain: b cd ae  
dimension: 3

406.  
id: 4286513153  
d -> e  
abc -> de  
c -> e  
b -> e  
a -> e  
meet-irreducibles: abe ace bce abde acde bcde  
max antichain: abe ace bce  
dimension: 3

407.  
id: 4145354005  
bc -> de  
ab -> cde  
a -> de  
meet-irreducibles: bd cd be ce ade bde acde bcde  
max antichain: bd cd be ce ade  
dimension: 5

408.  
id: 4115993877  
bc -> e  
a -> cde  
meet-irreducibles: bd cd bce bde acde bcde  
max antichain: bd cd bce  
dimension: 3

409.  
id: 4113896725  
bc -> de  
ab -> cde  
a -> ce  
meet-irreducibles: bd cd be ace bde acde bcde

APPENDIX A.2: DESCRIPTION OF SIZE 5 GEOMETRIES

max antichain: bd cd be ace  
dimension: 4

410.  
id: 4283891971  
ad -> e  
ac -> de  
c -> e  
ab -> de  
b -> e  
meet-irreducibles: a d ae bce abde acde bcde  
max antichain: a d bce  
dimension: 3

411.  
id: 4145353493  
bd -> e  
bc -> de  
ac -> de  
ab -> cde  
a -> d  
meet-irreducibles: b ad cd be ce ade bde acde bcde  
max antichain: b ad cd ce  
dimension: 4

412.  
id: 4285988881  
d -> e  
ab -> de  
b -> e  
a -> e  
meet-irreducibles: c ace bce abde acde bcde  
max antichain: ace bce abde  
dimension: 3

413.  
id: 4116001045  
bd -> e  
bc -> e  
ab -> cde  
a -> cd  
meet-irreducibles: b acd bce bde acde bcde  
max antichain: acd bce bde  
dimension: 3

414.



APPENDIX A.2: DESCRIPTION OF SIZE 5 GEOMETRIES

id: 4283761411  
ae -> d  
ac -> de  
c -> e  
ab -> de  
b -> e  
meet-irreducibles: a ad bce abde acde bcde  
max antichain: bce abde acde  
dimension: 3

415.  
id: 4113891639  
ae -> c  
cd -> e  
bd -> e  
ad -> ce  
bc -> de  
ab -> cde  
meet-irreducibles: a b ac d be ace bde acde bcde  
max antichain: a b d  
dimension: 3

416.  
id: 4149674755  
ac -> de  
c -> e  
ab -> cde  
b -> e  
meet-irreducibles: ad ae bce ade bde acde bcde  
max antichain: ad ae bce bde  
dimension: 4

417.  
id: 4149674259  
cd -> e  
ad -> e  
ac -> de  
ab -> cde  
b -> e  
meet-irreducibles: a c d ae bce ade bde acde bcde  
max antichain: a c d  
dimension: 3

418.  
id: 4285989121  
c -> e

APPENDIX A.2: DESCRIPTION OF SIZE 5 GEOMETRIES

ab -> de  
b -> e  
a -> e  
meet-irreducibles: d ace bce abde acde bcde  
max antichain: d ace bce  
dimension: 3

419.  
id: 4113630519  
be -> d  
ae -> c  
cd -> e  
ad -> ce  
bc -> de  
ab -> cde  
meet-irreducibles: a b ac bd ace bde acde bcde  
max antichain: a b  
dimension: 2

420.  
id: 4145349395  
ae -> d  
cd -> e  
bc -> de  
ac -> de  
ab -> cde  
b -> e  
meet-irreducibles: a c ad be ce ade bde acde bcde  
max antichain: a c be  
dimension: 3

421.  
id: 4283761409  
ac -> de  
c -> e  
ab -> de  
b -> e  
a -> d  
meet-irreducibles: ad bce abde acde bcde  
max antichain: bce abde acde  
dimension: 3

422.  
id: 4113891637  
cd -> e  
bd -> e

APPENDIX A.2: DESCRIPTION OF SIZE 5 GEOMETRIES

ad -> ce  
bc -> de  
ab -> cde  
a -> c  
meet-irreducibles: b ac d be ace bde acde bcde  
max antichain: b ac d  
dimension: 3

423.  
id: 4283760913  
cd -> e  
b -> e  
a -> de  
meet-irreducibles: c d bce abde acde bcde  
max antichain: bce abde acde  
dimension: 3

424.  
id: 4279697681  
cd -> e  
bc -> de  
ac -> de  
ab -> de  
b -> e  
a -> e  
meet-irreducibles: c d ae be ce abde acde bcde  
max antichain: c d ae be  
dimension: 4

425.  
id: 4149674257  
cd -> e  
ac -> de  
ab -> cde  
b -> e  
a -> e  
meet-irreducibles: c d ae bce ade bde acde bcde  
max antichain: c d ae  
dimension: 3

426.  
id: 4149673991  
d -> e  
ac -> de  
c -> e  
ab -> cde

APPENDIX A.2: DESCRIPTION OF SIZE 5 GEOMETRIES

meet-irreducibles: a b ae bce ade bde acde bcde  
max antichain: a bce bde  
dimension: 3

427.  
id: 4149542997  
d -> e  
ab -> cde  
a -> de  
meet-irreducibles: bc bce ade bde acde bcde  
max antichain: bc ade bde  
dimension: 3

428.  
id: 4113630517  
be -> d  
cd -> e  
ad -> ce  
bc -> de  
ab -> cde  
a -> c  
meet-irreducibles: b ac bd ace bde acde bcde  
max antichain: b ac  
dimension: 2

429.  
id: 4279567121  
cd -> e  
bc -> de  
ac -> de  
ab -> de  
b -> e  
a -> d  
meet-irreducibles: c ad be ce abde acde bcde  
max antichain: c ad be  
dimension: 3

430.  
id: 4149543697  
cd -> e  
ac -> de  
ab -> cde  
b -> e  
a -> d  
meet-irreducibles: c ad bce ade bde acde bcde  
max antichain: c ad bde

APPENDIX A.2: DESCRIPTION OF SIZE 5 GEOMETRIES

dimension: 3

431.

id: 4145479703

d -> e

bc -> de

ac -> de

ab -> cde

meet-irreducibles: a b c ae be ce ade bde acde bcde

max antichain: a b c

dimension: 3

432.

id: 4151771141

d -> e

c -> e

ab -> cde

a -> e

meet-irreducibles: b ace bce ade bde acde bcde

max antichain: ace bce ade bde

dimension: 4

433.

id: 4145479943

bd -> e

ad -> e

bc -> de

ac -> de

c -> e

ab -> cde

meet-irreducibles: a b d ae be ce ade bde acde bcde

max antichain: a b d ce

dimension: 4

434.

id: 4114022663

bd -> e

ad -> ce

bc -> de

c -> e

ab -> cde

meet-irreducibles: a b d ae be ace bde acde bcde

max antichain: a b d

dimension: 3

435.

APPENDIX A.2: DESCRIPTION OF SIZE 5 GEOMETRIES

id: 4283760661

d -> e

bc -> e

a -> de

meet-irreducibles: b c bce abde acde bcde

max antichain: bce abde acde

dimension: 3

436.

id: 4279697429

d -> e

bc -> de

ac -> de

ab -> de

a -> e

meet-irreducibles: b c ae be ce abde acde bcde

max antichain: b c ae

dimension: 3

437.

id: 4149674005

d -> e

bc -> e

ac -> de

ab -> cde

a -> e

meet-irreducibles: b c ae bce ade bde acde bcde

max antichain: b c ae

dimension: 3

438.

id: 4144432391

ad -> e

c -> de

ab -> cde

meet-irreducibles: a bd ae be ade bde acde bcde

max antichain: a bd be

dimension: 3

439.

id: 4279570705

bc -> de

b -> e

a -> de

meet-irreducibles: cd be ce abde acde bcde

max antichain: cd be ce

APPENDIX A.2: DESCRIPTION OF SIZE 5 GEOMETRIES

dimension: 3

440.

id: 4149547281

ab -> cde

b -> e

a -> de

meet-irreducibles: cd bce ade bde acde bcde

max antichain: cd bce ade bde

dimension: 4

441.

id: 4145484049

bc -> de

ac -> de

ab -> cde

b -> e

a -> e

meet-irreducibles: cd ae be ce ade bde acde bcde

max antichain: cd ae be ce

dimension: 4

442.

id: 4114026769

ad -> ce

bc -> de

ab -> cde

b -> e

a -> e

meet-irreducibles: cd ae be ace bde acde bcde

max antichain: cd ae be

dimension: 3

443.

id: 4145349383

ae -> d

bd -> e

bc -> de

ac -> de

c -> e

ab -> cde

meet-irreducibles: a b ad be ce ade bde acde bcde

max antichain: a b ce

dimension: 3

444.

APPENDIX A.2: DESCRIPTION OF SIZE 5 GEOMETRIES

id: 4149674245  
bd -> e  
ac -> de  
c -> e  
ab -> cde  
a -> e  
meet-irreducibles: b d ae bce ade bde acde bcde  
max antichain: b d ae  
dimension: 3

445.  
id: 4145088263  
be -> d  
ae -> d  
bc -> de  
ac -> de  
c -> e  
ab -> cde  
meet-irreducibles: a b ad bd ce ade bde acde bcde  
max antichain: a b ce  
dimension: 3

446.  
id: 4145353489  
bc -> de  
ac -> de  
ab -> cde  
b -> e  
a -> d  
meet-irreducibles: ad cd be ce ade bde acde bcde  
max antichain: ad cd be ce  
dimension: 4

447.  
id: 4149544197  
c -> e  
ab -> cde  
a -> de  
meet-irreducibles: bd bce ade bde acde bcde  
max antichain: bd bce ade  
dimension: 3

448.  
id: 4145480965  
bc -> de  
ac -> de



APPENDIX A.2: DESCRIPTION OF SIZE 5 GEOMETRIES

c -> e  
ab -> cde  
a -> e  
meet-irreducibles: bd ae be ce ade bde acde bcde  
max antichain: bd ae be ce  
dimension: 4

449.  
id: 4114023685  
ad -> ce  
bc -> de  
c -> e  
ab -> cde  
a -> e  
meet-irreducibles: bd ae be ace bde acde bcde  
max antichain: bd ae be  
dimension: 3

450.  
id: 4116001041  
ab -> cde  
b -> e  
a -> cd  
meet-irreducibles: acd bce bde acde bcde  
max antichain: acd bce bde  
dimension: 3

451.  
id: 4149543685  
bd -> e  
ac -> de  
c -> e  
ab -> cde  
a -> d  
meet-irreducibles: b ad bce ade bde acde bcde  
max antichain: ad bce bde  
dimension: 3

452.  
id: 4113891635  
ae -> c  
cd -> e  
ad -> ce  
bc -> de  
ab -> cde  
b -> e

APPENDIX A.2: DESCRIPTION OF SIZE 5 GEOMETRIES

meet-irreducibles: a ac d be ace bde acde bcde  
max antichain: a d be  
dimension: 3

453.  
id: 4279566613  
cd -> e  
bd -> e  
bc -> de  
a -> de  
meet-irreducibles: b c d be ce abde acde bcde  
max antichain: b c d  
dimension: 3

454.  
id: 4149543189  
cd -> e  
bd -> e  
bc -> e  
ab -> cde  
a -> de  
meet-irreducibles: b c d bce ade bde acde bcde  
max antichain: b c d  
dimension: 3

455.  
id: 4145479957  
cd -> e  
bd -> e  
bc -> de  
ac -> de  
ab -> cde  
a -> e  
meet-irreducibles: b c d ae be ce ade bde acde bcde  
max antichain: b c d ae  
dimension: 4

456.  
id: 4114022677  
cd -> e  
bd -> e  
ad -> ce  
bc -> de  
ab -> cde  
a -> e  
meet-irreducibles: b c d ae be ace bde acde bcde

APPENDIX A.2: DESCRIPTION OF SIZE 5 GEOMETRIES

max antichain: b c d ae  
dimension: 4

457.  
id: 4145350405  
bc -> de  
ac -> de  
c -> e  
ab -> cde  
a -> d  
meet-irreducibles: ad bd be ce ade bde acde bcde  
max antichain: ad bd be ce  
dimension: 4

458.  
id: 4279305493  
be -> d  
cd -> e  
bc -> de  
a -> de  
meet-irreducibles: b c bd ce abde acde bcde  
max antichain: abde acde bcde  
dimension: 3

459.  
id: 4145349909  
cd -> e  
bc -> de  
ab -> cde  
a -> de  
meet-irreducibles: c bd be ce ade bde acde bcde  
max antichain: c bd be ade  
dimension: 4

460.  
id: 4115989781  
cd -> e  
bc -> e  
a -> cde  
meet-irreducibles: c bd bce bde acde bcde  
max antichain: bd bce acde  
dimension: 3

461.  
id: 4113892629  
cd -> e

APPENDIX A.2: DESCRIPTION OF SIZE 5 GEOMETRIES

bc -> de  
 ab -> cde  
 a -> ce  
 meet-irreducibles: c bd be ace bde acde bcde  
 max antichain: c bd be  
 dimension: 3

462.  
 id: 4145349397  
 cd -> e  
 bd -> e  
 bc -> de  
 ac -> de  
 ab -> cde  
 a -> d  
 meet-irreducibles: b c ad be ce ade bde acde bcde  
 max antichain: b c ad  
 dimension: 3

463.  
 id: 4283891715  
 d -> e  
 ac -> de  
 c -> e  
 ab -> de  
 b -> e  
 meet-irreducibles: a ae bce abde acde bcde  
 max antichain: bce abde acde  
 dimension: 3

464.  
 id: 4145088277  
 be -> d  
 cd -> e  
 bc -> de  
 ac -> de  
 ab -> cde  
 a -> d  
 meet-irreducibles: b c ad bd ce ade bde acde bcde  
 max antichain: b c ad  
 dimension: 3

465.  
 id: 4113891383  
 ae -> c  
 ad -> ce

APPENDIX A.2: DESCRIPTION OF SIZE 5 GEOMETRIES

d -> e  
bc -> de  
ab -> cde  
meet-irreducibles: a b ac be ace bde acde bcde  
max antichain: a b  
dimension: 2

466.  
id: 4149674003  
d -> e  
ac -> de  
ab -> cde  
b -> e  
meet-irreducibles: a c ae bce ade bde acde bcde  
max antichain: a c bde  
dimension: 3

467.  
id: 4145352981  
bd -> e  
bc -> de  
ab -> cde  
a -> de  
meet-irreducibles: b cd be ce ade bde acde bcde  
max antichain: b cd ce ade  
dimension: 4

468.  
id: 4115992853  
bd -> e  
bc -> e  
a -> cde  
meet-irreducibles: b cd bce bde acde bcde  
max antichain: cd bce bde  
dimension: 3

469.  
id: 4113895701  
bd -> e  
bc -> de  
ab -> cde  
a -> ce  
meet-irreducibles: b cd be ace bde acde bcde  
max antichain: b cd ace  
dimension: 3

APPENDIX A.2: DESCRIPTION OF SIZE 5 GEOMETRIES

470.  
 id: 4285988865  
 d -> e  
 c -> e  
 ab -> de  
 b -> e  
 a -> e  
 meet-irreducibles: ace bce abde acde bcde  
 max antichain: ace bce abde  
 dimension: 3

471.  
 id: 4113634581  
 be -> d  
 bc -> de  
 ab -> cde  
 a -> ce  
 meet-irreducibles: b bd cd ace bde acde bcde  
 max antichain: b cd ace  
 dimension: 3

472.  
 id: 4111799573  
 bc -> de  
 a -> cde  
 meet-irreducibles: bd cd be ce bde acde bcde  
 max antichain: bd cd be ce  
 dimension: 4

473.  
 id: 3579122965  
 bc -> e  
 a -> bcde  
 meet-irreducibles: bd cd bce bde cde bcde  
 max antichain: bd cd bce  
 dimension: 3

474.  
 id: 4149674243  
 ad -> e  
 ac -> de  
 c -> e  
 ab -> cde  
 b -> e  
 meet-irreducibles: a d ae bce ade bde acde bcde  
 max antichain: a d bce

APPENDIX A.2: DESCRIPTION OF SIZE 5 GEOMETRIES

dimension: 3

475.

id: 4283891729

d -> e

ac -> de

ab -> de

b -> e

a -> e

meet-irreducibles: c ae bce abde acde bcde

max antichain: bce abde acde

dimension: 3

476.

id: 4113895729

ad -> ce

bc -> de

ab -> cde

b -> e

a -> c

meet-irreducibles: ac cd be ace bde acde bcde

max antichain: ac cd be

dimension: 3

477.

id: 4279567107

ae -> d

bc -> de

ac -> de

c -> e

ab -> de

b -> e

meet-irreducibles: a ad be ce abde acde bcde

max antichain: a be ce

dimension: 3

478.

id: 4149543683

ae -> d

ac -> de

c -> e

ab -> cde

b -> e

meet-irreducibles: a ad bce ade bde acde bcde

max antichain: a bce bde

dimension: 3

APPENDIX A.2: DESCRIPTION OF SIZE 5 GEOMETRIES

479.  
id: 4113634609  
ad -> ce  
bc -> de  
ab -> cde  
b -> d  
a -> c  
meet-irreducibles: ac bd cd ace bde acde bcde  
max antichain: ac bd cd  
dimension: 3

480.  
id: 4283891969  
ac -> de  
c -> e  
ab -> de  
b -> e  
a -> e  
meet-irreducibles: d ae bce abde acde bcde  
max antichain: d ae bce  
dimension: 3

481.  
id: 4151771393  
c -> e  
ab -> cde  
b -> e  
a -> e  
meet-irreducibles: d ace bce ade bde acde bcde  
max antichain: ace bce ade bde  
dimension: 4

482.  
id: 4279567105  
bc -> de  
ac -> de  
c -> e  
ab -> de  
b -> e  
a -> d  
meet-irreducibles: ad be ce abde acde bcde  
max antichain: ad be ce  
dimension: 3

483.



APPENDIX A.2: DESCRIPTION OF SIZE 5 GEOMETRIES

id: 4149543681  
 ac -> de  
 c -> e  
 ab -> cde  
 b -> e  
 a -> d  
 meet-irreducibles: ad bce ade bde acde bcde  
 max antichain: ad bce bde  
 dimension: 3

484.  
 id: 4279566609  
 cd -> e  
 bc -> de  
 b -> e  
 a -> de  
 meet-irreducibles: c d be ce abde acde bcde  
 max antichain: c d be  
 dimension: 3

485.  
 id: 4149543185  
 cd -> e  
 ab -> cde  
 b -> e  
 a -> de  
 meet-irreducibles: c d bce ade bde acde bcde  
 max antichain: c ade bde  
 dimension: 3

486.  
 id: 4145479953  
 cd -> e  
 bc -> de  
 ac -> de  
 ab -> cde  
 b -> e  
 a -> e  
 meet-irreducibles: c d ae be ce ade bde acde bcde  
 max antichain: c d ae be  
 dimension: 4

487.  
 id: 4114022673  
 cd -> e  
 ad -> ce

APPENDIX A.2: DESCRIPTION OF SIZE 5 GEOMETRIES

bc -> de  
ab -> cde  
b -> e  
a -> e  
meet-irreducibles: c d ae be ace bde acde bcde  
max antichain: c d ae be  
dimension: 4

488.  
id: 4145479687  
d -> e  
bc -> de  
ac -> de  
c -> e  
ab -> cde  
meet-irreducibles: a b ae be ce ade bde acde bcde  
max antichain: a b ce  
dimension: 3

489.  
id: 4114022407  
ad -> ce  
d -> e  
bc -> de  
c -> e  
ab -> cde  
meet-irreducibles: a b ae be ace bde acde bcde  
max antichain: a b  
dimension: 2

490.  
id: 4279305489  
cd -> e  
bc -> de  
b -> d  
a -> de  
meet-irreducibles: c bd ce abde acde bcde  
max antichain: abde acde bcde  
dimension: 3

491.  
id: 4145349393  
cd -> e  
bc -> de  
ac -> de  
ab -> cde

APPENDIX A.2: DESCRIPTION OF SIZE 5 GEOMETRIES

b -> e  
a -> d  
meet-irreducibles: c ad be ce ade bde acde bcde  
max antichain: c ad be  
dimension: 3

492.  
id: 4149673989  
d -> e  
ac -> de  
c -> e  
ab -> cde  
a -> e  
meet-irreducibles: b ae bce ade bde acde bcde  
max antichain: ae bce bde  
dimension: 3

493.  
id: 4145088273  
cd -> e  
bc -> de  
ac -> de  
ab -> cde  
b -> d  
a -> d  
meet-irreducibles: c ad bd ce ade bde acde bcde  
max antichain: c ad bd  
dimension: 3

494.  
id: 4144431367  
bd -> e  
ad -> e  
c -> de  
ab -> cde  
meet-irreducibles: a b d ae be ade bde acde bcde  
max antichain: a b d  
dimension: 3

495.  
id: 4113891379  
ae -> c  
ad -> ce  
d -> e  
bc -> de  
ab -> cde

APPENDIX A.2: DESCRIPTION OF SIZE 5 GEOMETRIES

b -> e  
meet-irreducibles: a ac be ace bde acde bcde  
max antichain: a be  
dimension: 2

496.  
id: 4279566357  
d -> e  
bc -> de  
a -> de  
meet-irreducibles: b c be ce abde acde bcde  
max antichain: abde acde bcde  
dimension: 3

497.  
id: 4149542933  
d -> e  
bc -> e  
ab -> cde  
a -> de  
meet-irreducibles: b c bce ade bde acde bcde  
max antichain: b c ade  
dimension: 3

498.  
id: 4145479701  
d -> e  
bc -> de  
ac -> de  
ab -> cde  
a -> e  
meet-irreducibles: b c ae be ce ade bde acde bcde  
max antichain: b c ae  
dimension: 3

499.  
id: 4279308561  
b -> de  
a -> de  
meet-irreducibles: cd ce abde acde bcde  
max antichain: cd ce abde  
dimension: 3

500.  
id: 4145352977  
bc -> de

APPENDIX A.2: DESCRIPTION OF SIZE 5 GEOMETRIES

ab -> cde  
b -> e  
a -> de  
meet-irreducibles: cd be ce ade bde acde bcde  
max antichain: cd be ce ade  
dimension: 4

501.  
id: 4115992849  
b -> e  
a -> cde  
meet-irreducibles: cd bce bde acde bcde  
max antichain: cd bce bde  
dimension: 3

502.  
id: 4113895697  
bc -> de  
ab -> cde  
b -> e  
a -> ce  
meet-irreducibles: cd be ace bde acde bcde  
max antichain: cd be ace  
dimension: 3

503.  
id: 4144300807  
ae -> d  
bd -> e  
c -> de  
ab -> cde  
meet-irreducibles: a b ad be ade bde acde bcde  
max antichain: a b  
dimension: 2

504.  
id: 4113634577  
bc -> de  
ab -> cde  
b -> d  
a -> ce  
meet-irreducibles: bd cd ace bde acde bcde  
max antichain: bd cd ace  
dimension: 3

505.

APPENDIX A.2: DESCRIPTION OF SIZE 5 GEOMETRIES

id: 4149543173

bd -> e

c -> e

ab -> cde

a -> de

meet-irreducibles: b d bce ade bde acde bcde

max antichain: bce ade bde

dimension: 3

506.

id: 4145479941

bd -> e

bc -> de

ac -> de

c -> e

ab -> cde

a -> e

meet-irreducibles: b d ae be ce ade bde acde bcde

max antichain: b d ae ce

dimension: 4

507.

id: 4114022661

bd -> e

ad -> ce

bc -> de

c -> e

ab -> cde

a -> e

meet-irreducibles: b d ae be ace bde acde bcde

max antichain: b d ae

dimension: 3

508.

id: 4145349893

bc -> de

c -> e

ab -> cde

a -> de

meet-irreducibles: bd be ce ade bde acde bcde

max antichain: bd be ce ade

dimension: 4

509.

id: 4115989765

c -> e

APPENDIX A.2: DESCRIPTION OF SIZE 5 GEOMETRIES

a -> cde  
meet-irreducibles: bd bce bde acde bcde  
max antichain: bd bce acde  
dimension: 3

510.  
id: 4113892613  
bc -> de  
c -> e  
ab -> cde  
a -> ce  
meet-irreducibles: bd be ace bde acde bcde  
max antichain: bd be ace  
dimension: 3

511.  
id: 4144432389  
c -> de  
ab -> cde  
a -> e  
meet-irreducibles: bd ae be ade bde acde bcde  
max antichain: bd ae be  
dimension: 3

512.  
id: 4145349381  
bd -> e  
bc -> de  
ac -> de  
c -> e  
ab -> cde  
a -> d  
meet-irreducibles: b ad be ce ade bde acde bcde  
max antichain: b ad ce  
dimension: 3

513.  
id: 4145348885  
cd -> e  
bd -> e  
bc -> de  
ab -> cde  
a -> de  
meet-irreducibles: b c d be ce ade bde acde bcde  
max antichain: b c d  
dimension: 3

APPENDIX A.2: DESCRIPTION OF SIZE 5 GEOMETRIES

514.

id: 4115988757  
cd -> e  
bd -> e  
bc -> e  
a -> cde  
meet-irreducibles: b c d bce bde acde bcde  
max antichain: b c d  
dimension: 3

515.

id: 4113891605  
cd -> e  
bd -> e  
bc -> de  
ab -> cde  
a -> ce  
meet-irreducibles: b c d be ace bde acde bcde  
max antichain: b c d  
dimension: 3

516.

id: 4145088261  
be -> d  
bc -> de  
ac -> de  
c -> e  
ab -> cde  
a -> d  
meet-irreducibles: b ad bd ce ade bde acde bcde  
max antichain: b ad ce  
dimension: 3

517.

id: 4145087765  
be -> d  
cd -> e  
bc -> de  
ab -> cde  
a -> de  
meet-irreducibles: b c bd ce ade bde acde bcde  
max antichain: b c ade  
dimension: 3

518.



APPENDIX A.2: DESCRIPTION OF SIZE 5 GEOMETRIES

id: 4113630485  
be -> d  
cd -> e  
bc -> de  
ab -> cde  
a -> ce  
meet-irreducibles: b c bd ace bde acde bcde  
max antichain: b c  
dimension: 2

519.  
id: 4111795477  
cd -> e  
bc -> de  
a -> cde  
meet-irreducibles: c bd be ce bde acde bcde  
max antichain: c bd be  
dimension: 3

520.  
id: 4113891633  
cd -> e  
ad -> ce  
bc -> de  
ab -> cde  
b -> e  
a -> c  
meet-irreducibles: ac d be ace bde acde bcde  
max antichain: ac d be  
dimension: 3

521.  
id: 4149673987  
d -> e  
ac -> de  
c -> e  
ab -> cde  
b -> e  
meet-irreducibles: a ae bce ade bde acde bcde  
max antichain: a bce bde  
dimension: 3

522.  
id: 4113630513  
cd -> e  
ad -> ce

APPENDIX A.2: DESCRIPTION OF SIZE 5 GEOMETRIES

bc -> de  
ab -> cde  
b -> d  
a -> c  
meet-irreducibles: ac bd ace bde acde bcde  
max antichain: ac bd  
dimension: 2

523.  
id: 4111798549  
bd -> e  
bc -> de  
a -> cde  
meet-irreducibles: b cd be ce bde acde bcde  
max antichain: b cd ce  
dimension: 3

524.  
id: 3579121941  
bd -> e  
bc -> e  
a -> bcde  
meet-irreducibles: b cd bce bde cde bcde  
max antichain: cd bce bde  
dimension: 3

525.  
id: 4283891713  
d -> e  
ac -> de  
c -> e  
ab -> de  
b -> e  
a -> e  
meet-irreducibles: ae bce abde acde bcde  
max antichain: bce abde acde  
dimension: 3

526.  
id: 4151771137  
d -> e  
c -> e  
ab -> cde  
b -> e  
a -> e  
meet-irreducibles: ace bce ade bde acde bcde

APPENDIX A.2: DESCRIPTION OF SIZE 5 GEOMETRIES

max antichain: ace bce ade bde  
dimension: 4

527.  
id: 3574928661  
bc -> de  
a -> bcde  
meet-irreducibles: bd cd be ce bde cde bcde  
max antichain: bd cd be ce  
dimension: 4

528.  
id: 4114022659  
ad -> ce  
bc -> de  
c -> e  
ab -> cde  
b -> e  
meet-irreducibles: a d ae be ace bde acde bcde  
max antichain: a d be  
dimension: 3

529.  
id: 4113891381  
ad -> ce  
d -> e  
bc -> de  
ab -> cde  
a -> c  
meet-irreducibles: b ac be ace bde acde bcde  
max antichain: b ac  
dimension: 2

530.  
id: 4283760657  
d -> e  
b -> e  
a -> de  
meet-irreducibles: c bce abde acde bcde  
max antichain: bce abde acde  
dimension: 3

531.  
id: 4279697425  
d -> e  
bc -> de

APPENDIX A.2: DESCRIPTION OF SIZE 5 GEOMETRIES

ac -> de  
ab -> de  
b -> e  
a -> e  
meet-irreducibles: c ae be ce abde acde bcde  
max antichain: c ae be  
dimension: 3

532.  
id: 4149674001  
d -> e  
ac -> de  
ab -> cde  
b -> e  
a -> e  
meet-irreducibles: c ae bce ade bde acde bcde  
max antichain: c ae bde  
dimension: 3

533.  
id: 4145349379  
ae -> d  
bc -> de  
ac -> de  
c -> e  
ab -> cde  
b -> e  
meet-irreducibles: a ad be ce ade bde acde bcde  
max antichain: a be ce  
dimension: 3

534.  
id: 4283760897  
c -> e  
b -> e  
a -> de  
meet-irreducibles: d bce abde acde bcde  
max antichain: bce abde acde  
dimension: 3

535.  
id: 4279697665  
bc -> de  
ac -> de  
c -> e  
ab -> de

APPENDIX A.2: DESCRIPTION OF SIZE 5 GEOMETRIES

b -> e  
a -> e  
meet-irreducibles: d ae be ce abde acde bcde  
max antichain: d ae be ce  
dimension: 4

536.  
id: 4149674241  
ac -> de  
c -> e  
ab -> cde  
b -> e  
a -> e  
meet-irreducibles: d ae bce ade bde acde bcde  
max antichain: d ae bce  
dimension: 3

537.  
id: 4279305473  
bc -> de  
c -> e  
b -> d  
a -> de  
meet-irreducibles: bd ce abde acde bcde  
max antichain: abde acde bcde  
dimension: 3

538.  
id: 4145349377  
bc -> de  
ac -> de  
c -> e  
ab -> cde  
b -> e  
a -> d  
meet-irreducibles: ad be ce ade bde acde bcde  
max antichain: ad be ce  
dimension: 3

539.  
id: 4279304465  
cd -> e  
b -> de  
a -> de  
meet-irreducibles: c d ce abde acde bcde  
max antichain: abde acde bcde

APPENDIX A.2: DESCRIPTION OF SIZE 5 GEOMETRIES

dimension: 3

540.

id: 4145348881

cd -> e

bc -> de

ab -> cde

b -> e

a -> de

meet-irreducibles: c d be ce ade bde acde bcde

max antichain: c d be

dimension: 3

541.

id: 4115988753

cd -> e

b -> e

a -> cde

meet-irreducibles: c d bce bde acde bcde

max antichain: bce bde acde

dimension: 3

542.

id: 4113891601

cd -> e

bc -> de

ab -> cde

b -> e

a -> ce

meet-irreducibles: c d be ace bde acde bcde

max antichain: c d be

dimension: 3

543.

id: 4144431111

d -> e

c -> de

ab -> cde

meet-irreducibles: a b ae be ade bde acde bcde

max antichain: a b

dimension: 2

544.

id: 4145088257

bc -> de

ac -> de

APPENDIX A.2: DESCRIPTION OF SIZE 5 GEOMETRIES

c -> e  
ab -> cde  
b -> d  
a -> d  
meet-irreducibles: ad bd ce ade bde acde bcde  
max antichain: ad bd ce  
dimension: 3

545.  
id: 4145087761  
cd -> e  
bc -> de  
ab -> cde  
b -> d  
a -> de  
meet-irreducibles: c bd ce ade bde acde bcde  
max antichain: c bd ade  
dimension: 3

546.  
id: 4113630481  
cd -> e  
bc -> de  
ab -> cde  
b -> d  
a -> ce  
meet-irreducibles: c bd ace bde acde bcde  
max antichain: c bd  
dimension: 2

547.  
id: 4149542917  
d -> e  
c -> e  
ab -> cde  
a -> de  
meet-irreducibles: b bce ade bde acde bcde  
max antichain: bce ade bde  
dimension: 3

548.  
id: 4145479685  
d -> e  
bc -> de  
ac -> de  
c -> e

APPENDIX A.2: DESCRIPTION OF SIZE 5 GEOMETRIES

ab -> cde  
a -> e  
meet-irreducibles: b ae be ce ade bde acde bcde  
max antichain: b ae ce  
dimension: 3

549.  
id: 4114022405  
ad -> ce  
d -> e  
bc -> de  
c -> e  
ab -> cde  
a -> e  
meet-irreducibles: b ae be ace bde acde bcde  
max antichain: b ae  
dimension: 2

550.  
id: 4145348629  
d -> e  
bc -> de  
ab -> cde  
a -> de  
meet-irreducibles: b c be ce ade bde acde bcde  
max antichain: b c ade  
dimension: 3

551.  
id: 4113891349  
d -> e  
bc -> de  
ab -> cde  
a -> ce  
meet-irreducibles: b c be ace bde acde bcde  
max antichain: b c  
dimension: 2

552.  
id: 4145090833  
ab -> cde  
b -> de  
a -> de  
meet-irreducibles: cd ce ade bde acde bcde  
max antichain: cd ce ade bde  
dimension: 4



APPENDIX A.2: DESCRIPTION OF SIZE 5 GEOMETRIES

553.

id: 4113633553  
ab -> cde  
b -> de  
a -> ce  
meet-irreducibles: cd ace bde acde bcde  
max antichain: cd ace bde  
dimension: 3

554.

id: 4111798545  
bc -> de  
b -> e  
a -> cde  
meet-irreducibles: cd be ce bde acde bcde  
max antichain: cd be ce  
dimension: 3

555.

id: 3579121937  
b -> e  
a -> bcde  
meet-irreducibles: cd bce bde cde bcde  
max antichain: cd bce bde  
dimension: 3

556.

id: 4145348869  
bd -> e  
bc -> de  
c -> e  
ab -> cde  
a -> de  
meet-irreducibles: b d be ce ade bde acde bcde  
max antichain: b d ce  
dimension: 3

557.

id: 4115988741  
bd -> e  
c -> e  
a -> cde  
meet-irreducibles: b d bce bde acde bcde  
max antichain: bce bde acde  
dimension: 3

APPENDIX A.2: DESCRIPTION OF SIZE 5 GEOMETRIES

558.

id: 4113891589

bd -> e

bc -> de

c -> e

ab -> cde

a -> ce

meet-irreducibles: b d be ace bde acde bcde

max antichain: b d ace

dimension: 3

559.

id: 4144431365

bd -> e

c -> de

ab -> cde

a -> e

meet-irreducibles: b d ae be ade bde acde bcde

max antichain: b d ae

dimension: 3

560.

id: 4113891377

ad -> ce

d -> e

bc -> de

ab -> cde

b -> e

a -> c

meet-irreducibles: ac be ace bde acde bcde

max antichain: ac be

dimension: 2

561.

id: 4145087749

be -> d

bc -> de

c -> e

ab -> cde

a -> de

meet-irreducibles: b bd ce ade bde acde bcde

max antichain: b ce ade

dimension: 3

562.

APPENDIX A.2: DESCRIPTION OF SIZE 5 GEOMETRIES

id: 4113630469  
be -> d  
bc -> de  
c -> e  
ab -> cde  
a -> ce  
meet-irreducibles: b bd ace bde acde bcde  
max antichain: b ace  
dimension: 2

563.  
id: 4144301317  
c -> de  
ab -> cde  
a -> de  
meet-irreducibles: bd be ade bde acde bcde  
max antichain: bd be ade  
dimension: 3

564.  
id: 4111795461  
bc -> de  
c -> e  
a -> cde  
meet-irreducibles: bd be ce bde acde bcde  
max antichain: bd be ce  
dimension: 3

565.  
id: 4144300805  
bd -> e  
c -> de  
ab -> cde  
a -> d  
meet-irreducibles: b ad be ade bde acde bcde  
max antichain: b ad  
dimension: 2

566.  
id: 4111794453  
cd -> e  
bd -> e  
bc -> de  
a -> cde  
meet-irreducibles: b c d be ce bde acde bcde  
max antichain: b c d

APPENDIX A.2: DESCRIPTION OF SIZE 5 GEOMETRIES

dimension: 3

567.

id: 3579117845

cd -> e

bd -> e

bc -> e

a -> bcde

meet-irreducibles: b c d bce bde cde bcde

max antichain: b c d

dimension: 3

568.

id: 4111533333

be -> d

cd -> e

bc -> de

a -> cde

meet-irreducibles: b c bd ce bde acde bcde

max antichain: b c

dimension: 2

569.

id: 3574927637

bd -> e

bc -> de

a -> bcde

meet-irreducibles: b cd be ce bde cde bcde

max antichain: b cd ce

dimension: 3

570.

id: 4283760641

d -> e

c -> e

b -> e

a -> de

meet-irreducibles: bce abde acde bcde

max antichain: bce abde acde

dimension: 3

571.

id: 4279697409

d -> e

bc -> de

ac -> de

APPENDIX A.2: DESCRIPTION OF SIZE 5 GEOMETRIES

c -> e  
ab -> de  
b -> e  
a -> e  
meet-irreducibles: ae be ce abde acde bcde  
max antichain: ae be ce  
dimension: 3

572.  
id: 4149673985  
d -> e  
ac -> de  
c -> e  
ab -> cde  
b -> e  
a -> e  
meet-irreducibles: ae bce ade bde acde bcde  
max antichain: ae bce bde  
dimension: 3

573.  
id: 4279566353  
d -> e  
bc -> de  
b -> e  
a -> de  
meet-irreducibles: c be ce abde acde bcde  
max antichain: abde acde bcde  
dimension: 3

574.  
id: 4149542929  
d -> e  
ab -> cde  
b -> e  
a -> de  
meet-irreducibles: c bce ade bde acde bcde  
max antichain: c ade bde  
dimension: 3

575.  
id: 4145479697  
d -> e  
bc -> de  
ac -> de  
ab -> cde

APPENDIX A.2: DESCRIPTION OF SIZE 5 GEOMETRIES

b -> e  
a -> e  
meet-irreducibles: c ae be ce ade bde acde bcde  
max antichain: c ae be  
dimension: 3

576.  
id: 4279566593  
bc -> de  
c -> e  
b -> e  
a -> de  
meet-irreducibles: d be ce abde acde bcde  
max antichain: d be ce  
dimension: 3

577.  
id: 4149543169  
c -> e  
ab -> cde  
b -> e  
a -> de  
meet-irreducibles: d bce ade bde acde bcde  
max antichain: bce ade bde  
dimension: 3

578.  
id: 4145479937  
bc -> de  
ac -> de  
c -> e  
ab -> cde  
b -> e  
a -> e  
meet-irreducibles: d ae be ce ade bde acde bcde  
max antichain: d ae be ce  
dimension: 4

579.  
id: 4114022657  
ad -> ce  
bc -> de  
c -> e  
ab -> cde  
b -> e  
a -> e

APPENDIX A.2: DESCRIPTION OF SIZE 5 GEOMETRIES

meet-irreducibles: d ae be ace bde acde bcde  
max antichain: d ae be  
dimension: 3

580.  
id: 4145087745  
bc -> de  
c -> e  
ab -> cde  
b -> d  
a -> de  
meet-irreducibles: bd ce ade bde acde bcde  
max antichain: bd ce ade  
dimension: 3

581.  
id: 4113630465  
bc -> de  
c -> e  
ab -> cde  
b -> d  
a -> ce  
meet-irreducibles: bd ace bde acde bcde  
max antichain: bd ace  
dimension: 2

582.  
id: 4144300801  
c -> de  
ab -> cde  
b -> e  
a -> d  
meet-irreducibles: ad be ade bde acde bcde  
max antichain: ad be  
dimension: 2

583.  
id: 4145086737  
cd -> e  
ab -> cde  
b -> de  
a -> de  
meet-irreducibles: c d ce ade bde acde bcde  
max antichain: c ade bde  
dimension: 3

APPENDIX A.2: DESCRIPTION OF SIZE 5 GEOMETRIES

584.  
id: 4113629457  
cd -> e  
ab -> cde  
b -> de  
a -> ce  
meet-irreducibles: c d ace bde acde bcde  
max antichain: c d  
dimension: 2

585.  
id: 4111794449  
cd -> e  
bc -> de  
b -> e  
a -> cde  
meet-irreducibles: c d be ce bde acde bcde  
max antichain: c d be  
dimension: 3

586.  
id: 3579117841  
cd -> e  
b -> e  
a -> bcde  
meet-irreducibles: c d bce bde cde bcde  
max antichain: bce bde cde  
dimension: 3

587.  
id: 4111533329  
cd -> e  
bc -> de  
b -> d  
a -> cde  
meet-irreducibles: c bd ce bde acde bcde  
max antichain: c bd  
dimension: 2

588.  
id: 4145348613  
d -> e  
bc -> de  
c -> e  
ab -> cde  
a -> de



APPENDIX A.2: DESCRIPTION OF SIZE 5 GEOMETRIES

meet-irreducibles: b be ce ade bde acde bcde  
max antichain: b ce ade  
dimension: 3

589.  
id: 4115988485  
d -> e  
c -> e  
a -> cde  
meet-irreducibles: b bce bde acde bcde  
max antichain: bce bde acde  
dimension: 3

590.  
id: 4113891333  
d -> e  
bc -> de  
c -> e  
ab -> cde  
a -> ce  
meet-irreducibles: b be ace bde acde bcde  
max antichain: b ace  
dimension: 2

591.  
id: 4144431109  
d -> e  
c -> de  
ab -> cde  
a -> e  
meet-irreducibles: b ae be ade bde acde bcde  
max antichain: b ae  
dimension: 2

592.  
id: 4111794197  
d -> e  
bc -> de  
a -> cde  
meet-irreducibles: b c be ce bde acde bcde  
max antichain: b c  
dimension: 2

593.  
id: 4111536401  
b -> de

APPENDIX A.2: DESCRIPTION OF SIZE 5 GEOMETRIES

a -> cde  
meet-irreducibles: cd ce bde acde bcde  
max antichain: cd ce bde  
dimension: 3

594.  
id: 3574927633  
bc -> de  
b -> e  
a -> bcde  
meet-irreducibles: cd be ce bde cde bcde  
max antichain: cd be ce  
dimension: 3

595.  
id: 4144300293  
bd -> e  
c -> de  
ab -> cde  
a -> de  
meet-irreducibles: b d be ade bde acde bcde  
max antichain: b d  
dimension: 2

596.  
id: 4111794437  
bd -> e  
bc -> de  
c -> e  
a -> cde  
meet-irreducibles: b d be ce bde acde bcde  
max antichain: b d ce  
dimension: 3

597.  
id: 4111533317  
be -> d  
bc -> de  
c -> e  
a -> cde  
meet-irreducibles: b bd ce bde acde bcde  
max antichain: b ce  
dimension: 2

598.  
id: 4110746885

APPENDIX A.2: DESCRIPTION OF SIZE 5 GEOMETRIES

c -> de  
a -> cde  
meet-irreducibles: bd be bde acde bcde  
max antichain: bd be acde  
dimension: 3

599.  
id: 3574923541  
cd -> e  
bd -> e  
bc -> de  
a -> bcde  
meet-irreducibles: b c d be ce bde cde bcde  
max antichain: b c d  
dimension: 3

600.  
id: 3574662421  
be -> d  
cd -> e  
bc -> de  
a -> bcde  
meet-irreducibles: b c bd ce bde cde bcde  
max antichain: b c  
dimension: 2

601.  
id: 4279566337  
d -> e  
bc -> de  
c -> e  
b -> e  
a -> de  
meet-irreducibles: be ce abde acde bcde  
max antichain: abde acde bcde  
dimension: 3

602.  
id: 4149542913  
d -> e  
c -> e  
ab -> cde  
b -> e  
a -> de  
meet-irreducibles: bce ade bde acde bcde  
max antichain: bce ade bde

APPENDIX A.2: DESCRIPTION OF SIZE 5 GEOMETRIES

dimension: 3

603.

id: 4145479681

d -> e

bc -> de

ac -> de

c -> e

ab -> cde

b -> e

a -> e

meet-irreducibles: ae be ce ade bde acde bcde

max antichain: ae be ce

dimension: 3

604.

id: 4114022401

ad -> ce

d -> e

bc -> de

c -> e

ab -> cde

b -> e

a -> e

meet-irreducibles: ae be ace bde acde bcde

max antichain: ae be

dimension: 2

605.

id: 4279304209

d -> e

b -> de

a -> de

meet-irreducibles: c ce abde acde bcde

max antichain: abde acde bcde

dimension: 3

606.

id: 4145348625

d -> e

bc -> de

ab -> cde

b -> e

a -> de

meet-irreducibles: c be ce ade bde acde bcde

max antichain: c be ade

APPENDIX A.2: DESCRIPTION OF SIZE 5 GEOMETRIES

dimension: 3

607.  
id: 4113891345  
d -> e  
bc -> de  
ab -> cde  
b -> e  
a -> ce  
meet-irreducibles: c be ace bde acde bcde  
max antichain: c be  
dimension: 2

608.  
id: 4279304449  
c -> e  
b -> de  
a -> de  
meet-irreducibles: d ce abde acde bcde  
max antichain: abde acde bcde  
dimension: 3

609.  
id: 4145348865  
bc -> de  
c -> e  
ab -> cde  
b -> e  
a -> de  
meet-irreducibles: d be ce ade bde acde bcde  
max antichain: d be ce  
dimension: 3

610.  
id: 4115988737  
c -> e  
b -> e  
a -> cde  
meet-irreducibles: d bce bde acde bcde  
max antichain: bce bde acde  
dimension: 3

611.  
id: 4113891585  
bc -> de  
c -> e

APPENDIX A.2: DESCRIPTION OF SIZE 5 GEOMETRIES

ab -> cde  
b -> e  
a -> ce  
meet-irreducibles: d be ace bde acde bcde  
max antichain: d be ace  
dimension: 3

612.  
id: 4144431361  
c -> de  
ab -> cde  
b -> e  
a -> e  
meet-irreducibles: d ae be ade bde acde bcde  
max antichain: d ae be  
dimension: 3

613.  
id: 4111533313  
bc -> de  
c -> e  
b -> d  
a -> cde  
meet-irreducibles: bd ce bde acde bcde  
max antichain: bd ce  
dimension: 2

614.  
id: 4111532305  
cd -> e  
b -> de  
a -> cde  
meet-irreducibles: c d ce bde acde bcde  
max antichain: c d  
dimension: 2

615.  
id: 3574923537  
cd -> e  
bc -> de  
b -> e  
a -> bcde  
meet-irreducibles: c d be ce bde cde bcde  
max antichain: c d be  
dimension: 3

APPENDIX A.2: DESCRIPTION OF SIZE 5 GEOMETRIES

616.  
id: 3574662417  
cd -> e  
bc -> de  
b -> d  
a -> bcde  
meet-irreducibles: c bd ce bde cde bcde  
max antichain: c bd  
dimension: 2

617.  
id: 4144300037  
d -> e  
c -> de  
ab -> cde  
a -> de  
meet-irreducibles: b be ade bde acde bcde  
max antichain: b ade  
dimension: 2

618.  
id: 4111794181  
d -> e  
bc -> de  
c -> e  
a -> cde  
meet-irreducibles: b be ce bde acde bcde  
max antichain: b ce  
dimension: 2

619.  
id: 3574923285  
d -> e  
bc -> de  
a -> bcde  
meet-irreducibles: b c be ce bde cde bcde  
max antichain: b c  
dimension: 2

620.  
id: 4044427537  
b -> cde  
a -> cde  
meet-irreducibles: cd ce de acde bcde  
max antichain: cd ce de  
dimension: 3

APPENDIX A.2: DESCRIPTION OF SIZE 5 GEOMETRIES

621.  
id: 3574665489  
b -> de  
a -> bcde  
meet-irreducibles: cd ce bde cde bcde  
max antichain: cd ce bde  
dimension: 3

622.  
id: 4110745861  
bd -> e  
c -> de  
a -> cde  
meet-irreducibles: b d be bde acde bcde  
max antichain: b d  
dimension: 2

623.  
id: 4279304193  
d -> e  
c -> e  
b -> de  
a -> de  
meet-irreducibles: ce abde acde bcde  
max antichain: abde acde bcde  
dimension: 3

624.  
id: 4145348609  
d -> e  
bc -> de  
c -> e  
ab -> cde  
b -> e  
a -> de  
meet-irreducibles: be ce ade bde acde bcde  
max antichain: be ce ade  
dimension: 3

625.  
id: 4115988481  
d -> e  
c -> e  
b -> e  
a -> cde



APPENDIX A.2: DESCRIPTION OF SIZE 5 GEOMETRIES

meet-irreducibles: bce bde acde bcde  
max antichain: bce bde acde  
dimension: 3

626.  
id: 4113891329  
d -> e  
bc -> de  
c -> e  
ab -> cde  
b -> e  
a -> ce  
meet-irreducibles: be ace bde acde bcde  
max antichain: be ace  
dimension: 2

627.  
id: 4144431105  
d -> e  
c -> de  
ab -> cde  
b -> e  
a -> e  
meet-irreducibles: ae be ade bde acde bcde  
max antichain: ae be  
dimension: 2

628.  
id: 4145086481  
d -> e  
ab -> cde  
b -> de  
a -> de  
meet-irreducibles: c ce ade bde acde bcde  
max antichain: c ade bde  
dimension: 3

629.  
id: 4111794193  
d -> e  
bc -> de  
b -> e  
a -> cde  
meet-irreducibles: c be ce bde acde bcde  
max antichain: c be  
dimension: 2

APPENDIX A.2: DESCRIPTION OF SIZE 5 GEOMETRIES

630.  
id: 4278255873  
c -> de  
b -> de  
a -> de  
meet-irreducibles: d e abde acde bcde  
max antichain: abde acde bcde  
dimension: 3

631.  
id: 4145086721  
c -> e  
ab -> cde  
b -> de  
a -> de  
meet-irreducibles: d ce ade bde acde bcde  
max antichain: ce ade bde  
dimension: 3

632.  
id: 4113629441  
c -> e  
ab -> cde  
b -> de  
a -> ce  
meet-irreducibles: d ace bde acde bcde  
max antichain: d ace  
dimension: 2

633.  
id: 4144300289  
c -> de  
ab -> cde  
b -> e  
a -> de  
meet-irreducibles: d be ade bde acde bcde  
max antichain: d be  
dimension: 2

634.  
id: 4111794433  
bc -> de  
c -> e  
b -> e  
a -> cde

APPENDIX A.2: DESCRIPTION OF SIZE 5 GEOMETRIES

meet-irreducibles: d be ce bde acde bcde  
max antichain: d be ce  
dimension: 3

635.  
id: 3579117825  
c -> e  
b -> e  
a -> bcde  
meet-irreducibles: d bce bde cde bcde  
max antichain: bce bde cde  
dimension: 3

636.  
id: 3574662401  
bc -> de  
c -> e  
b -> d  
a -> bcde  
meet-irreducibles: bd ce bde cde bcde  
max antichain: bd ce  
dimension: 2

637.  
id: 4044423441  
cd -> e  
b -> cde  
a -> cde  
meet-irreducibles: c d ce de acde bcde  
max antichain: c d  
dimension: 2

638.  
id: 3574661393  
cd -> e  
b -> de  
a -> bcde  
meet-irreducibles: c d ce bde cde bcde  
max antichain: c d  
dimension: 2

639.  
id: 4110745605  
d -> e  
c -> de  
a -> cde

APPENDIX A.2: DESCRIPTION OF SIZE 5 GEOMETRIES

meet-irreducibles: b be bde acde bcde  
max antichain: b acde  
dimension: 2

640.  
id: 3507556625  
b -> cde  
a -> bcde  
meet-irreducibles: cd ce de cde bcde  
max antichain: cd ce de  
dimension: 3

641.  
id: 4278255617  
d -> e  
c -> de  
b -> de  
a -> de  
meet-irreducibles: e abde acde bcde  
max antichain: abde acde bcde  
dimension: 3

642.  
id: 4145086465  
d -> e  
c -> e  
ab -> cde  
b -> de  
a -> de  
meet-irreducibles: ce ade bde acde bcde  
max antichain: ce ade bde  
dimension: 3

643.  
id: 4113629185  
d -> e  
c -> e  
ab -> cde  
b -> de  
a -> ce  
meet-irreducibles: ace bde acde bcde  
max antichain: ace bde  
dimension: 2

644.  
id: 4144300033

APPENDIX A.2: DESCRIPTION OF SIZE 5 GEOMETRIES

d -> e  
c -> de  
ab -> cde  
b -> e  
a -> de  
meet-irreducibles: be ade bde acde bcde  
max antichain: be ade  
dimension: 2

645.  
id: 4111794177  
d -> e  
bc -> de  
c -> e  
b -> e  
a -> cde  
meet-irreducibles: be ce bde acde bcde  
max antichain: be ce  
dimension: 2

646.  
id: 3579117569  
d -> e  
c -> e  
b -> e  
a -> bcde  
meet-irreducibles: bce bde cde bcde  
max antichain: bce bde cde  
dimension: 3

647.  
id: 4111532049  
d -> e  
b -> de  
a -> cde  
meet-irreducibles: c ce bde acde bcde  
max antichain: c bde  
dimension: 2

648.  
id: 3574923281  
d -> e  
bc -> de  
b -> e  
a -> bcde  
meet-irreducibles: c be ce bde cde bcde

APPENDIX A.2: DESCRIPTION OF SIZE 5 GEOMETRIES

max antichain: c be  
dimension: 2

649.  
id: 4144038145  
c -> de  
ab -> cde  
b -> de  
a -> de  
meet-irreducibles: d e ade bde acde bcde  
max antichain: d e  
dimension: 2

650.  
id: 4111532289  
c -> e  
b -> de  
a -> cde  
meet-irreducibles: d ce bde acde bcde  
max antichain: d ce  
dimension: 2

651.  
id: 4110745857  
c -> de  
b -> e  
a -> cde  
meet-irreducibles: d be bde acde bcde  
max antichain: d be  
dimension: 2

652.  
id: 3574923521  
bc -> de  
c -> e  
b -> e  
a -> bcde  
meet-irreducibles: d be ce bde cde bcde  
max antichain: d be ce  
dimension: 3

653.  
id: 3507552529  
cd -> e  
b -> cde  
a -> bcde

APPENDIX A.2: DESCRIPTION OF SIZE 5 GEOMETRIES

meet-irreducibles: c d ce de cde bcde  
max antichain: c d  
dimension: 2

654.  
id: 4144037889  
d -> e  
c -> de  
ab -> cde  
b -> de  
a -> de  
meet-irreducibles: e ade bde acde bcde  
max antichain: ade bde  
dimension: 2

655.  
id: 4111532033  
d -> e  
c -> e  
b -> de  
a -> cde  
meet-irreducibles: ce bde acde bcde  
max antichain: ce bde  
dimension: 2

656.  
id: 4110745601  
d -> e  
c -> de  
b -> e  
a -> cde  
meet-irreducibles: be bde acde bcde  
max antichain: be acde  
dimension: 2

657.  
id: 3574923265  
d -> e  
bc -> de  
c -> e  
b -> e  
a -> bcde  
meet-irreducibles: be ce bde cde bcde  
max antichain: be ce  
dimension: 2

APPENDIX A.2: DESCRIPTION OF SIZE 5 GEOMETRIES

658.  
id: 3574661137  
d -> e  
b -> de  
a -> bcde  
meet-irreducibles: c ce bde cde bcde  
max antichain: c bde  
dimension: 2

659.  
id: 4110483713  
c -> de  
b -> de  
a -> cde  
meet-irreducibles: d e bde acde bcde  
max antichain: d e  
dimension: 2

660.  
id: 4044423425  
c -> e  
b -> cde  
a -> cde  
meet-irreducibles: d ce de acde bcde  
max antichain: d ce  
dimension: 2

661.  
id: 3574661377  
c -> e  
b -> de  
a -> bcde  
meet-irreducibles: d ce bde cde bcde  
max antichain: d ce  
dimension: 2

662.  
id: 4110483457  
d -> e  
c -> de  
b -> de  
a -> cde  
meet-irreducibles: e bde acde bcde  
max antichain: bde acde  
dimension: 2



APPENDIX A.2: DESCRIPTION OF SIZE 5 GEOMETRIES

663.  
id: 4044423169  
d -> e  
c -> e  
b -> cde  
a -> cde  
meet-irreducibles: ce de acde bcde  
max antichain: ce de  
dimension: 2

664.  
id: 3574661121  
d -> e  
c -> e  
b -> de  
a -> bcde  
meet-irreducibles: ce bde cde bcde  
max antichain: ce bde  
dimension: 2

665.  
id: 4043374849  
c -> de  
b -> cde  
a -> cde  
meet-irreducibles: d e de acde bcde  
max antichain: d e  
dimension: 2

666.  
id: 3573612801  
c -> de  
b -> de  
a -> bcde  
meet-irreducibles: d e bde cde bcde  
max antichain: d e  
dimension: 2

667.  
id: 3507552513  
c -> e  
b -> cde  
a -> bcde  
meet-irreducibles: d ce de cde bcde  
max antichain: d ce  
dimension: 2

APPENDIX A.2: DESCRIPTION OF SIZE 5 GEOMETRIES

668.  
id: 4043374593  
d -> e  
c -> de  
b -> cde  
a -> cde  
meet-irreducibles: e de acde bcde  
max antichain: acde bcde  
dimension: 2

669.  
id: 3573612545  
d -> e  
c -> de  
b -> de  
a -> bcde  
meet-irreducibles: e bde cde bcde  
max antichain: bde cde  
dimension: 2

670.  
id: 3507552257  
d -> e  
c -> e  
b -> cde  
a -> bcde  
meet-irreducibles: ce de cde bcde  
max antichain: ce de  
dimension: 2

671.  
id: 3506503937  
c -> de  
b -> cde  
a -> bcde  
meet-irreducibles: d e de cde bcde  
max antichain: d e  
dimension: 2

672.  
id: 3506503681  
d -> e  
c -> de  
b -> cde  
a -> bcde

APPENDIX A.2: DESCRIPTION OF SIZE 5 GEOMETRIES

meet-irreducibles: e de cde bcde  
max antichain: e  
dimension: 1

## B

### B.1 Representation of size 4 geometries

1

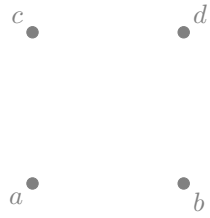

Boolean

2

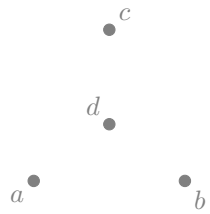

$abc \rightarrow d$

3

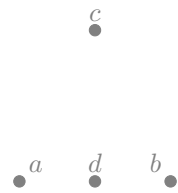

$ab \rightarrow d$

APPENDIX B.1: REPRESENTATION OF SIZE 4 GEOMETRIES

4

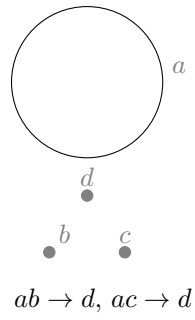

5

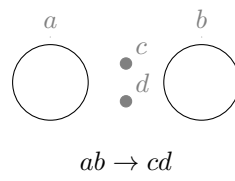

6

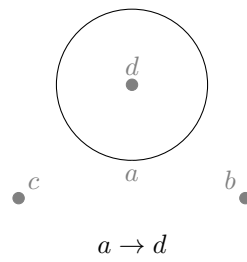

7

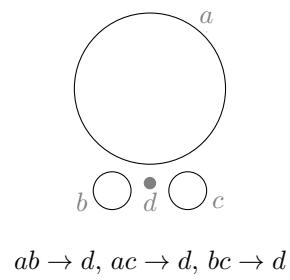

APPENDIX B.1: REPRESENTATION OF SIZE 4 GEOMETRIES

8

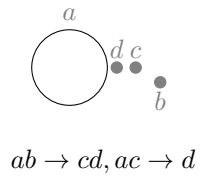

9

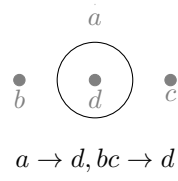

10

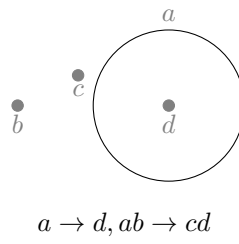

11

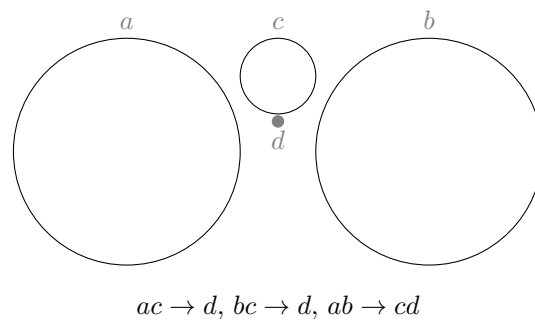

APPENDIX B.1: REPRESENTATION OF SIZE 4 GEOMETRIES

12

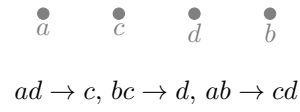

13

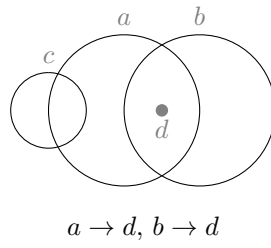

14

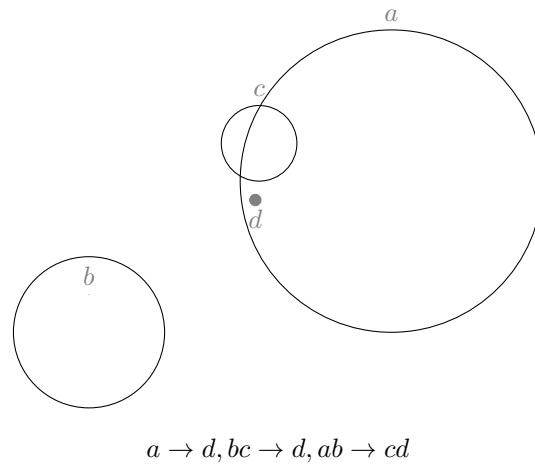

15

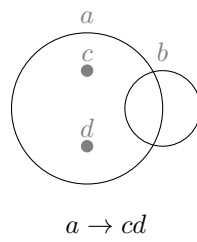

APPENDIX B.1: REPRESENTATION OF SIZE 4 GEOMETRIES

16

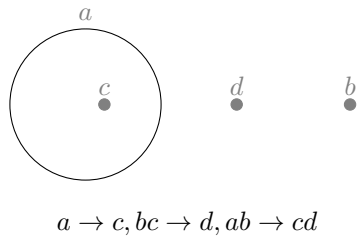

17

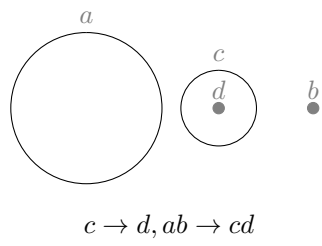

18

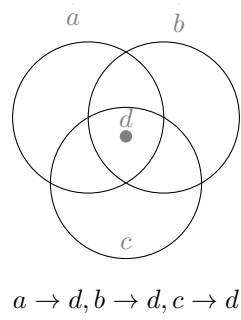

19

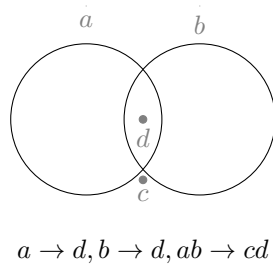



APPENDIX B.1: REPRESENTATION OF SIZE 4 GEOMETRIES

20

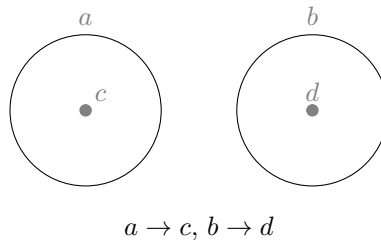

21

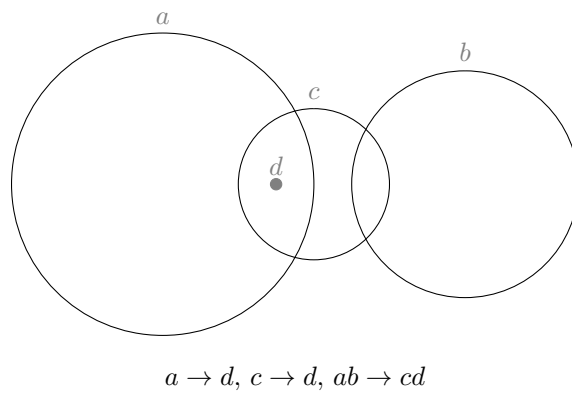

22

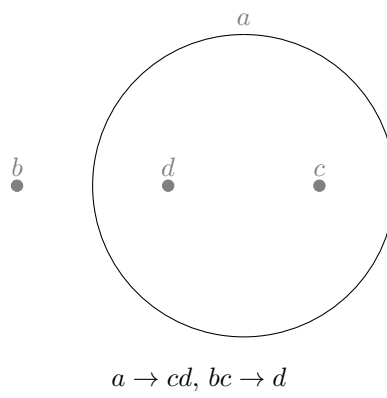

APPENDIX B.1: REPRESENTATION OF SIZE 4 GEOMETRIES

23

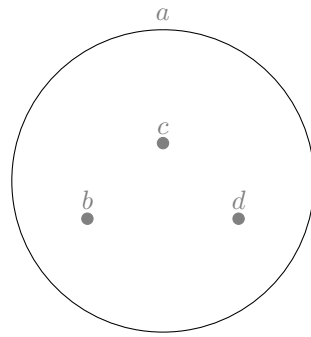

$$a \rightarrow bcd$$

24

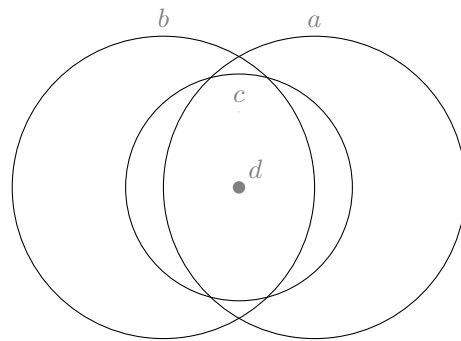

$$a \rightarrow d, b \rightarrow d, c \rightarrow d, ab \rightarrow cd$$

APPENDIX B.1: REPRESENTATION OF SIZE 4 GEOMETRIES

25

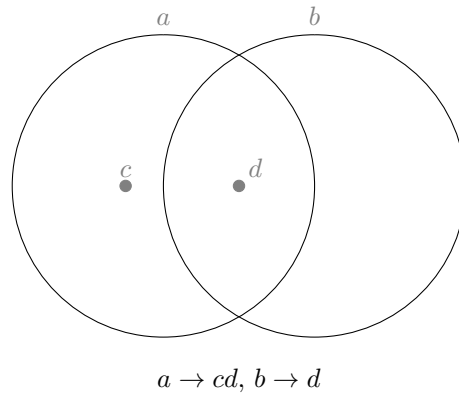

26

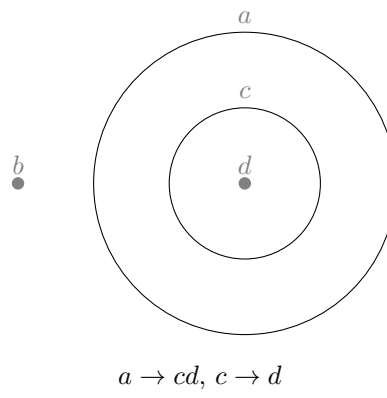

APPENDIX B.1: REPRESENTATION OF SIZE 4 GEOMETRIES

27

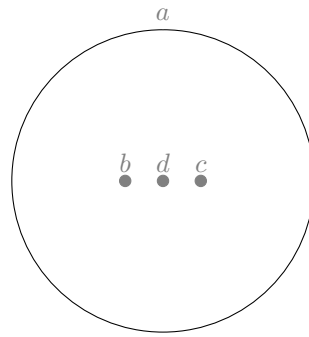

$$a \rightarrow bcd, bc \rightarrow d$$

28

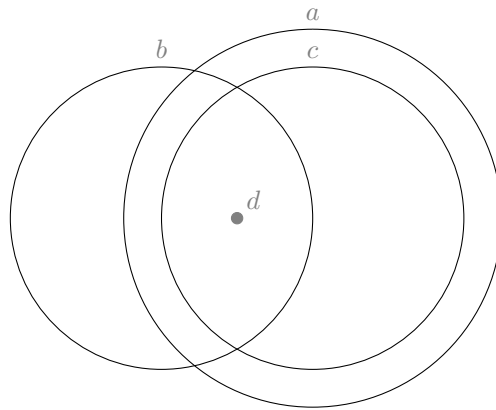

$$a \rightarrow cd, c \rightarrow d, b \rightarrow d$$

APPENDIX B.1: REPRESENTATION OF SIZE 4 GEOMETRIES

29

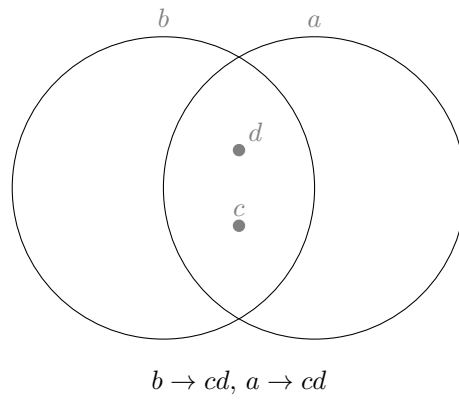

30

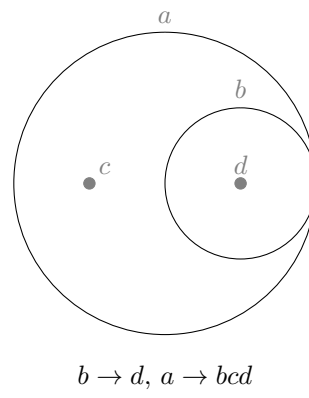

APPENDIX B.1: REPRESENTATION OF SIZE 4 GEOMETRIES

31

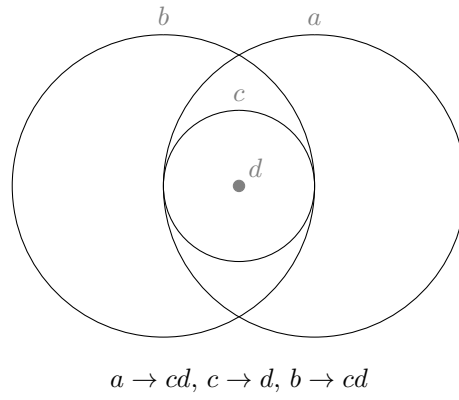

32

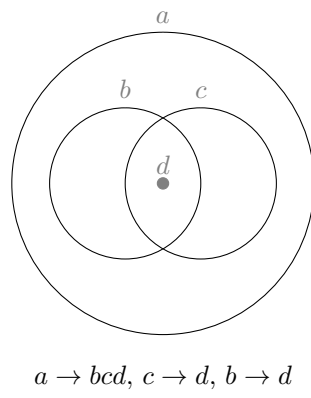

33

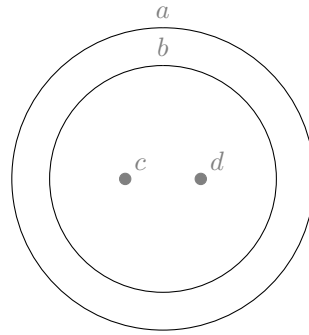

$$b \rightarrow cd, a \rightarrow bcd$$

34

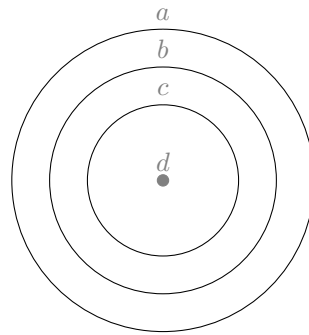

$$c \rightarrow d, b \rightarrow cd, a \rightarrow bcd$$

## B.2 Representation of size 5 geometries

1

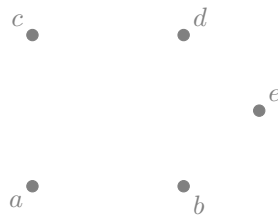

Figure 1: Boolean

APPENDIX B.2: REPRESENTATION OF SIZE 5 GEOMETRIES

2

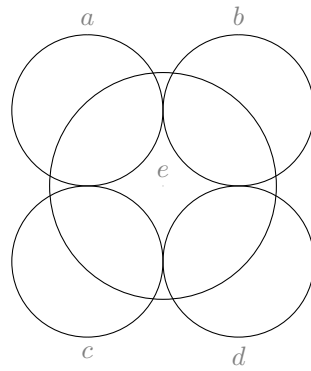

Figure 2:  $abcd \rightarrow e$

3

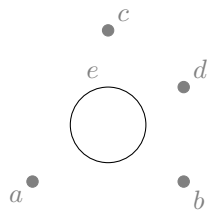

Figure 3:  $abc \rightarrow e$

5

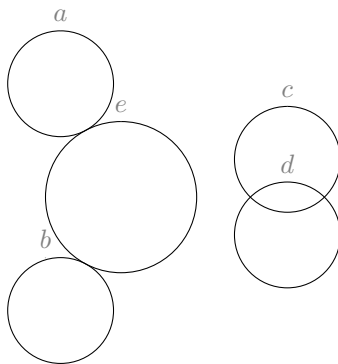

Figure 5:  $abd \rightarrow e, abc \rightarrow e$



APPENDIX B.2: REPRESENTATION OF SIZE 5 GEOMETRIES

6

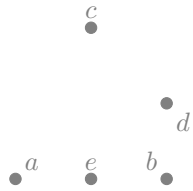

Figure 6:  $ab \rightarrow e$

8

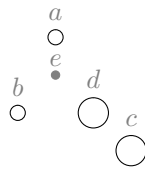

Figure 8:  $abd \rightarrow e, abc \rightarrow de$

9

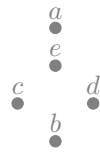

Figure 9:  $ab \rightarrow e, acd \rightarrow e$

10

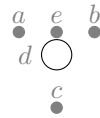

Figure 10:  $ab \rightarrow e, abc \rightarrow de$

APPENDIX B.2: REPRESENTATION OF SIZE 5 GEOMETRIES

13

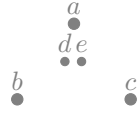

Figure 13:  $abe \rightarrow d$ ,  $acd \rightarrow e$ ,  $abc \rightarrow de$

16

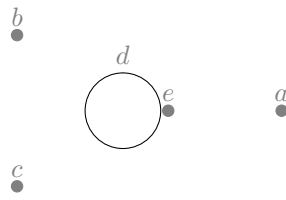

Figure 16:  $ad \rightarrow e$ ,  $abc \rightarrow de$

17

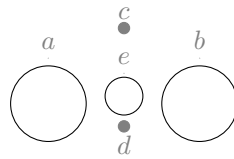

Figure 17:  $ab \rightarrow de$

19

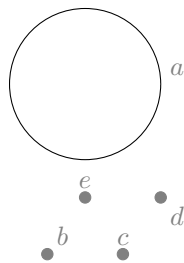

Figure 19:  $ab \rightarrow e$ ,  $ac \rightarrow e$

APPENDIX B.2: REPRESENTATION OF SIZE 5 GEOMETRIES

20

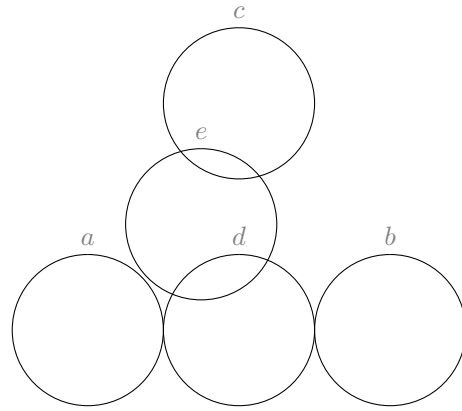

Figure 20:  $acd \rightarrow e, abc \rightarrow de, ab \rightarrow d$

22

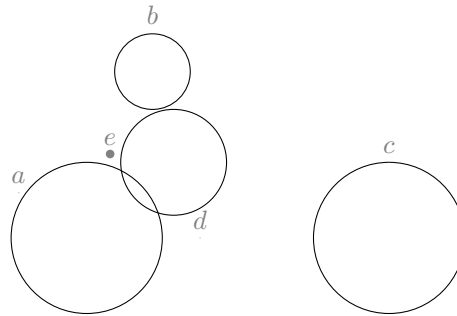

Figure 22:  $ad \rightarrow e, abc \rightarrow de, ab \rightarrow e$

APPENDIX B.2: REPRESENTATION OF SIZE 5 GEOMETRIES

24

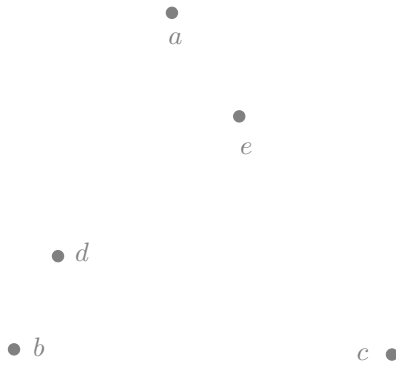

Figure 24:  $abc \rightarrow de, ac \rightarrow e, ab \rightarrow d$

25

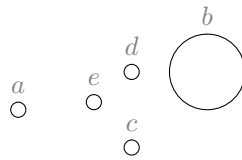

Figure 25:  $acd \rightarrow e, ab \rightarrow de$

28

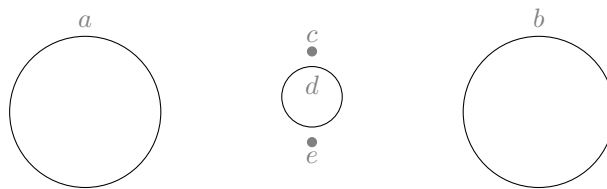

Figure 28:  $ab \rightarrow cde$

29

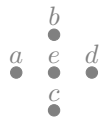

Figure 29:  $ad \rightarrow e, bc \rightarrow e$

APPENDIX B.2: REPRESENTATION OF SIZE 5 GEOMETRIES

30

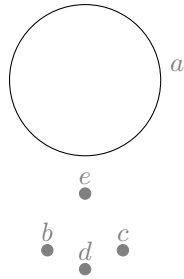

Figure 30:  $ab \rightarrow e, ac \rightarrow e, ad \rightarrow e$

31

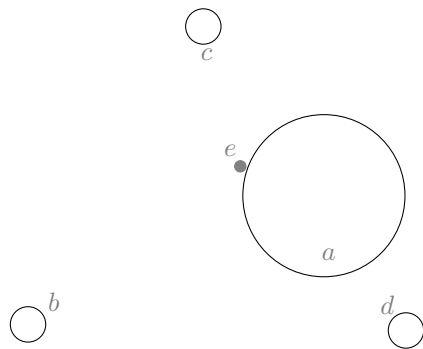

Figure 31:  $bcd \rightarrow e, ac \rightarrow e, ab \rightarrow e$

32

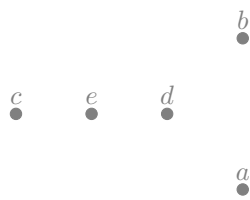

Figure 32:  $abe \rightarrow e, cd \rightarrow e, abc \rightarrow de.$

APPENDIX B.2: REPRESENTATION OF SIZE 5 GEOMETRIES

36

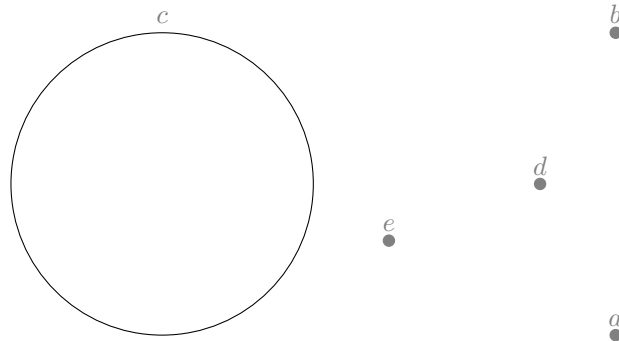

Figure 36:  $abe \rightarrow d, cd \rightarrow e, abc \rightarrow de, ac \rightarrow e$ .

37

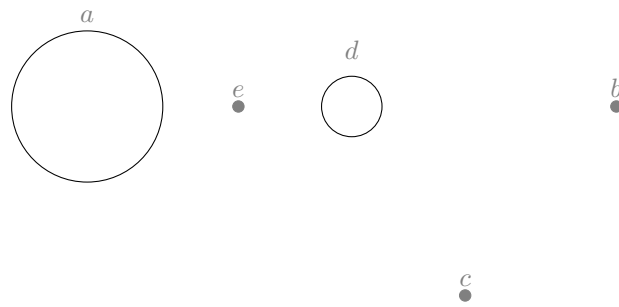

Figure 37:  $ad \rightarrow e, ab \rightarrow de$ .

38

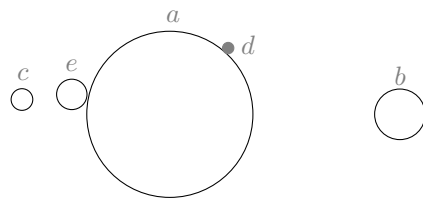

Figure 38:  $bcd \rightarrow e, abc \rightarrow de, ac \rightarrow e, ab \rightarrow d$

APPENDIX B.2: REPRESENTATION OF SIZE 5 GEOMETRIES

40

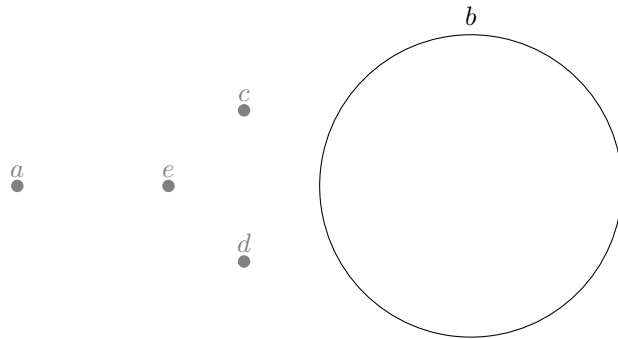

Figure 40:  $acd \rightarrow e, ab \rightarrow cde$ .

41

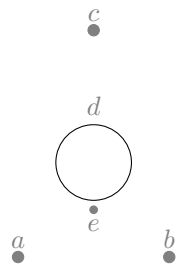

Figure 41:  $ad \rightarrow e, bd \rightarrow e, abc \rightarrow de$

42

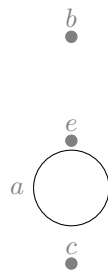

Figure 42:  $ab \rightarrow e, ad \rightarrow e, bc \rightarrow e$ .

APPENDIX B.2: REPRESENTATION OF SIZE 5 GEOMETRIES

44

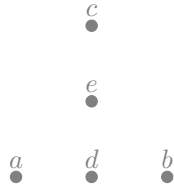

Figure 44:  $ab \rightarrow d, cd \rightarrow e, abc \rightarrow de$

48

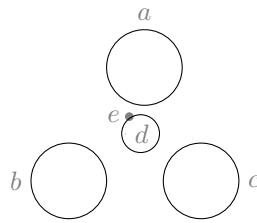

Figure 48:  $ab \rightarrow e, ad \rightarrow e, ac \rightarrow e, abc \rightarrow de.$

50

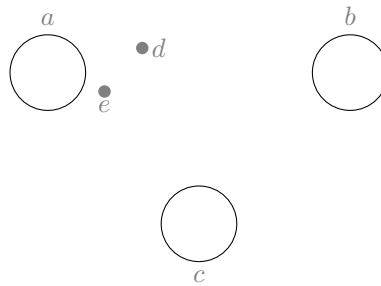

Figure 50:  $ac \rightarrow e, ab \rightarrow de$



51

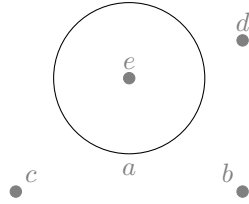

Figure 51:  $a \rightarrow e$

52

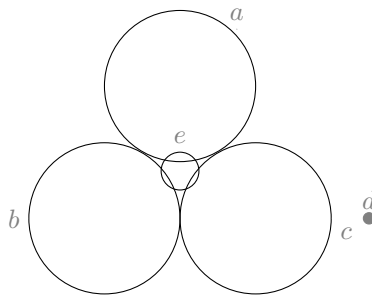

Figure 52:  $ab \rightarrow e, ac \rightarrow e, bc \rightarrow e$

53

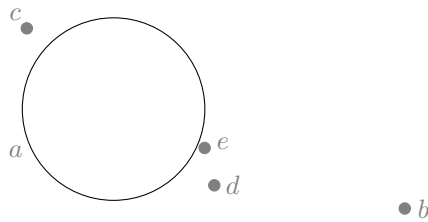

Figure 53:  $bcd \rightarrow e, ad \rightarrow e, ab \rightarrow de$

55

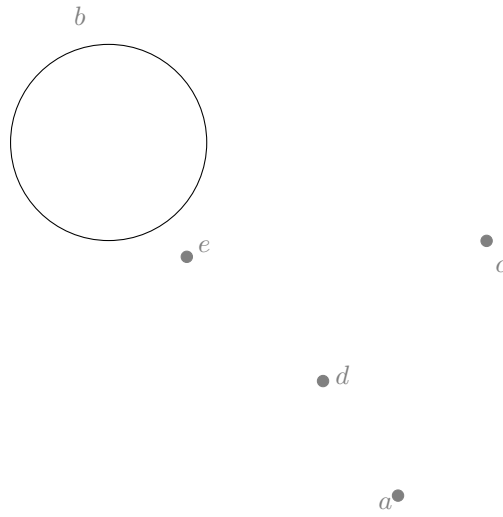

Figure 55:  $ace \rightarrow d, bd \rightarrow e, ab \rightarrow de$

58

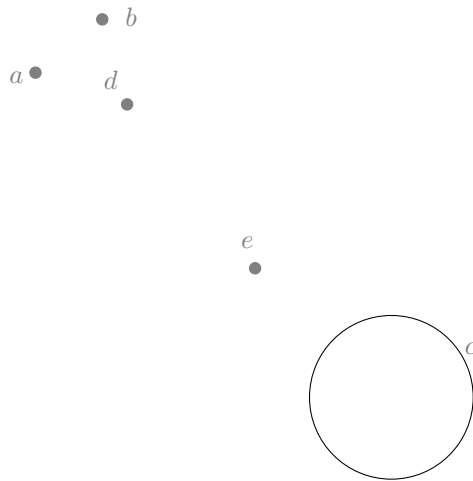

Figure 58:  $abe \rightarrow d, cd \rightarrow e, abc \rightarrow de, bc \rightarrow e, ac \rightarrow e$

APPENDIX B.2: REPRESENTATION OF SIZE 5 GEOMETRIES

59

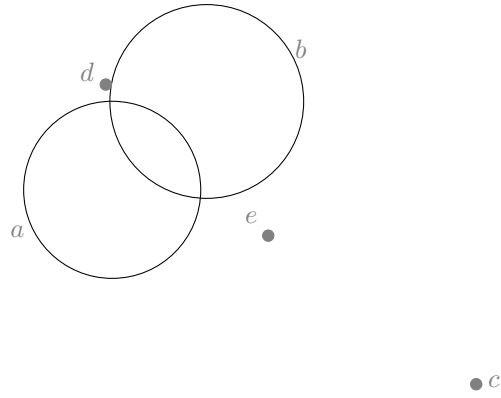

Figure 59:  $abc \rightarrow de, bc \rightarrow e, ac \rightarrow e, ab \rightarrow d$

61

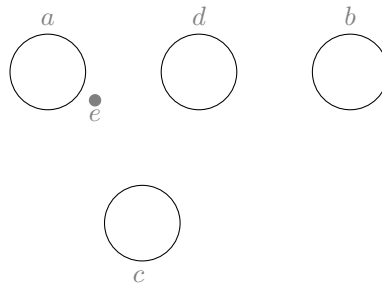

Figure 61:  $ac \rightarrow e, ab \rightarrow de, ad \rightarrow e$

APPENDIX B.2: REPRESENTATION OF SIZE 5 GEOMETRIES

62

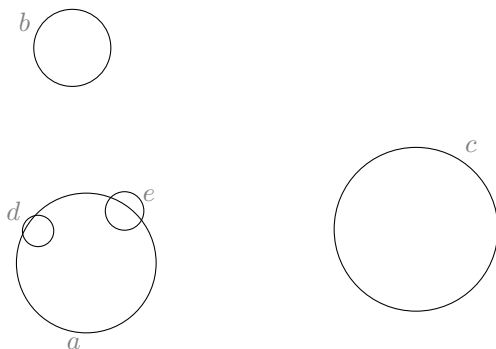

Figure 62:  $bcd \rightarrow e, ac \rightarrow e, ab \rightarrow de$

63

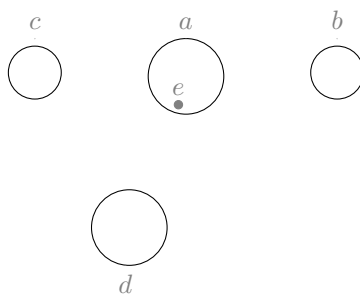

Figure 63:  $a \rightarrow e, bcd \rightarrow e,$

64

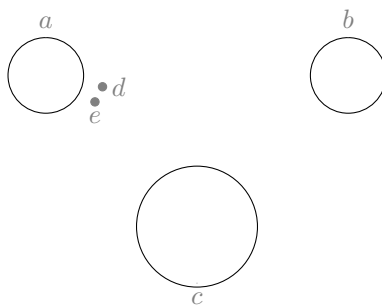

Figure 64:  $ac \rightarrow de, ab \rightarrow de$

APPENDIX B.2: REPRESENTATION OF SIZE 5 GEOMETRIES

65

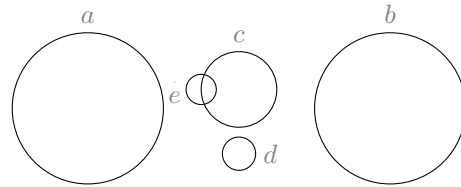

Figure 65:  $ab \rightarrow cde, ac \rightarrow e$

66

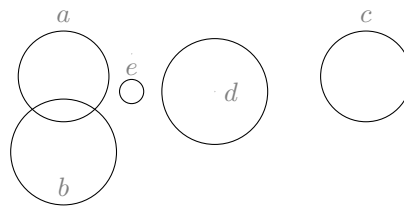

Figure 66:  $abc \rightarrow de, ac \rightarrow e, ad \rightarrow e, bd \rightarrow e$

67

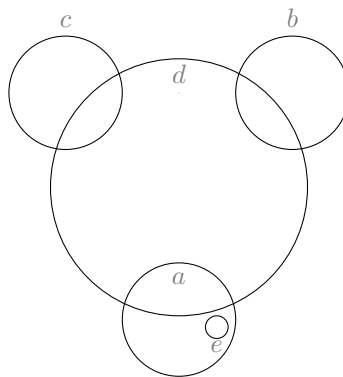

Figure 67:  $a \rightarrow e, abc \rightarrow de$

68

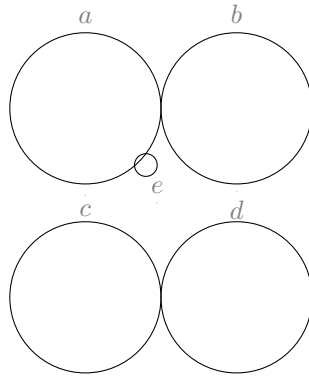

Figure 68:  $ab \rightarrow e, ac \rightarrow e, bc \rightarrow e, ad \rightarrow e$

71

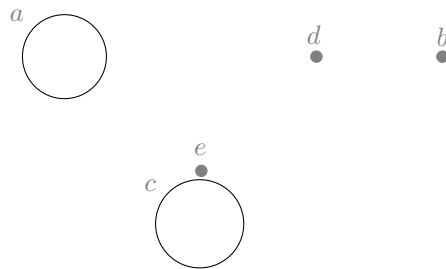

Figure 71:  $cd \rightarrow e, abc \rightarrow de, ac \rightarrow e, ab \rightarrow d$

72

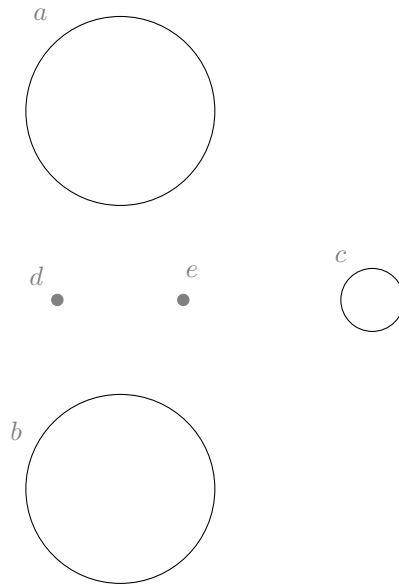

Figure 72:  $cd \rightarrow e, ab \rightarrow de$

73

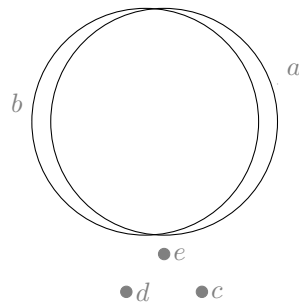

Figure 73:  $ac \rightarrow e, ad \rightarrow e, bc \rightarrow e, bd \rightarrow e$

APPENDIX B.2: REPRESENTATION OF SIZE 5 GEOMETRIES

75

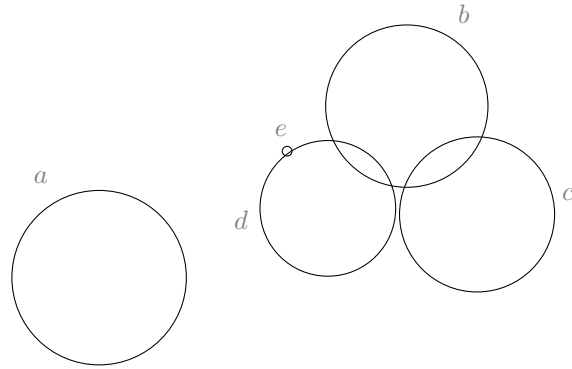

Figure 75:  $abc \rightarrow de, ad \rightarrow e, bd \rightarrow e, ab \rightarrow e$

76

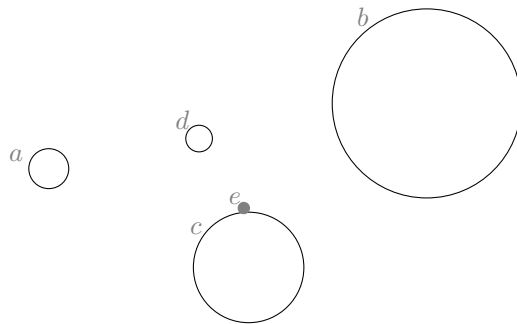

Figure 76:  $cd \rightarrow e, abc \rightarrow de, bc \rightarrow e, ac \rightarrow e, ab \rightarrow d$



77

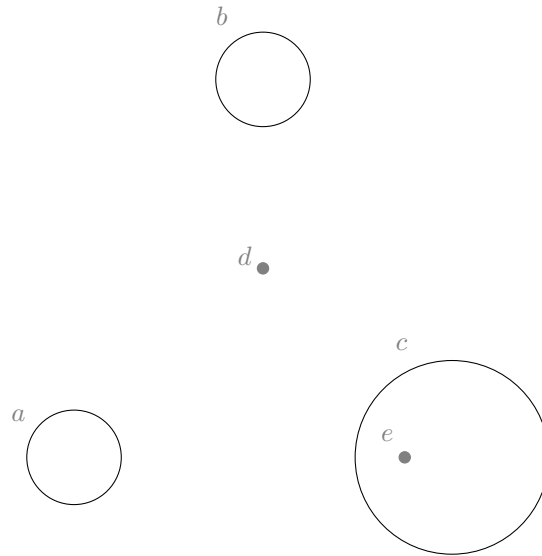

Figure 77:  $abe \rightarrow d, abc \rightarrow de, c \rightarrow e$

78

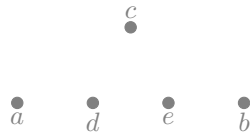

Figure 78:  $ae \rightarrow d, bd \rightarrow e, ab \rightarrow de$

APPENDIX B.2: REPRESENTATION OF SIZE 5 GEOMETRIES

79

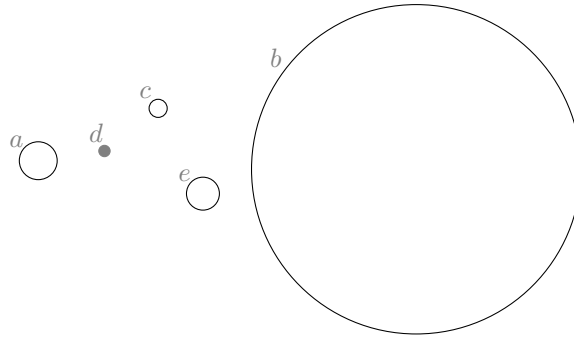

Figure 79:  $ace \rightarrow d, bd \rightarrow e, ab \rightarrow cde$

80

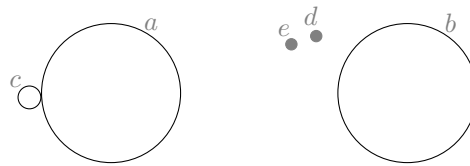

Figure 80:  $ad \rightarrow e, bc \rightarrow e, ab \rightarrow de$

81

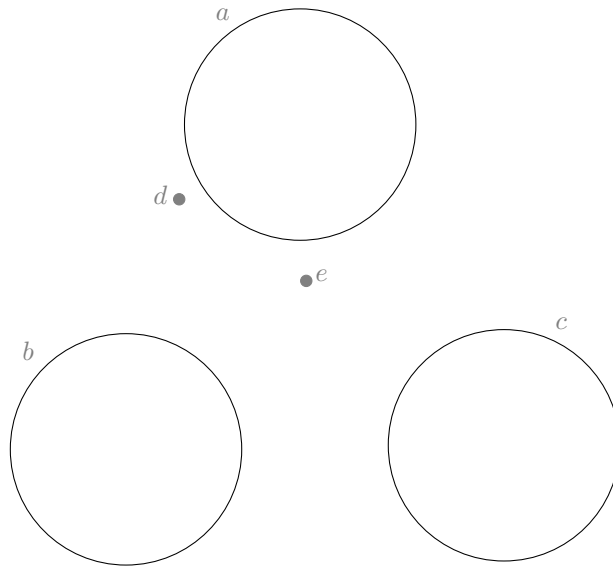

Figure 81:  $ab \rightarrow de, ac \rightarrow e, cd \rightarrow e$

82

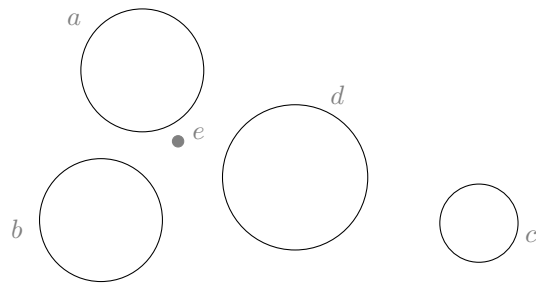

Figure 82:  $ab \rightarrow e, ac \rightarrow e, ad \rightarrow e, bd \rightarrow e, abc \rightarrow de$

83

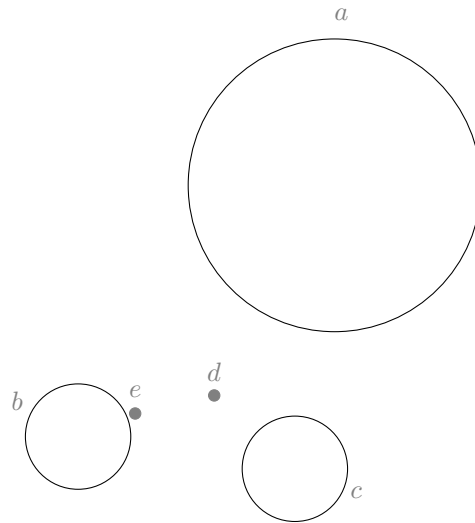

Figure 83:  $ab \rightarrow de, bc \rightarrow e, bd \rightarrow e, ace \rightarrow d$

85

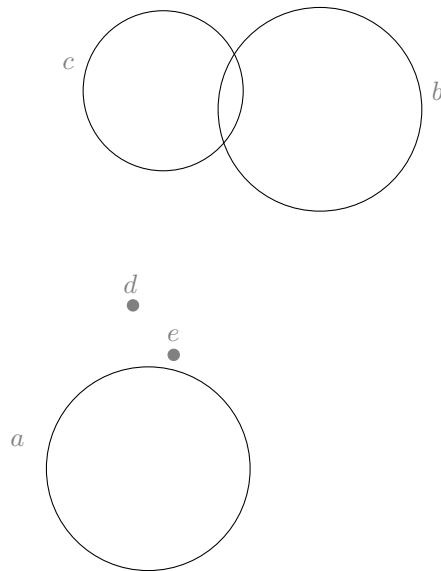

Figure 85:  $ac \rightarrow de, ab \rightarrow de, ad \rightarrow e$

86

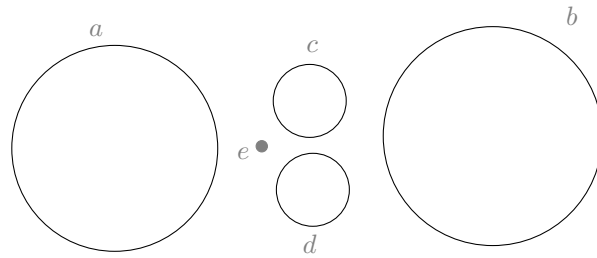

Figure 86:  $ab \rightarrow cde, ac \rightarrow e, ad \rightarrow e$

88

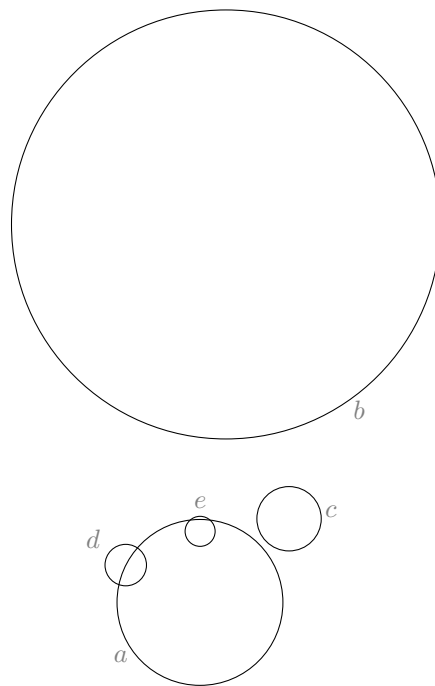

Figure 88:  $bcd \rightarrow e, ac \rightarrow e, ab \rightarrow cde$

APPENDIX B.2: REPRESENTATION OF SIZE 5 GEOMETRIES

90

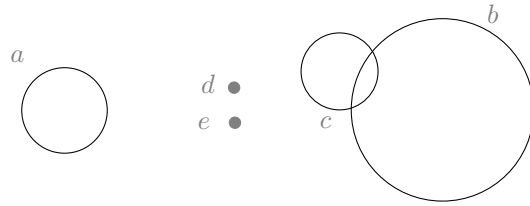

Figure 90:  $ab \rightarrow cde, ac \rightarrow de$

91

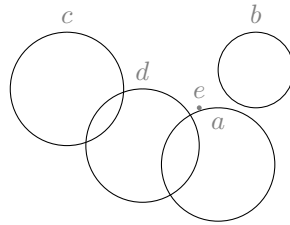

Figure 91:  $bd \rightarrow e, ad \rightarrow e, ab \rightarrow e, ac \rightarrow e, bc \rightarrow e$

92

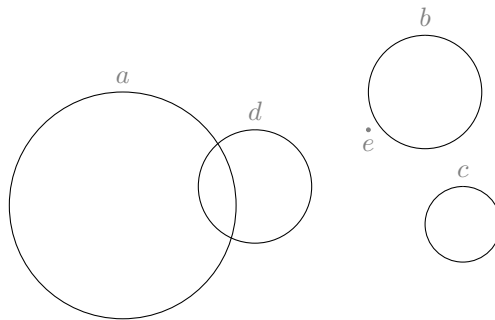

Figure 92:  $bd \rightarrow e, ac \rightarrow d, ab \rightarrow de$

APPENDIX B.2: REPRESENTATION OF SIZE 5 GEOMETRIES

93

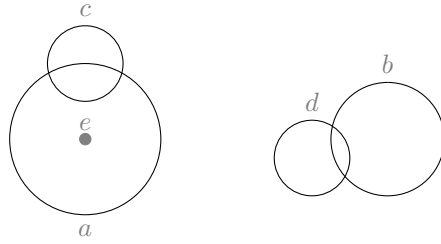

Figure 93:  $ab \rightarrow de, a \rightarrow e$

97

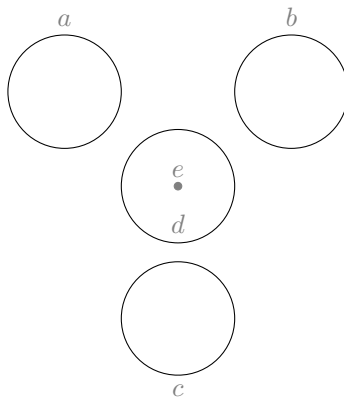

Figure 97:  $d \rightarrow e, abc \rightarrow de$

98

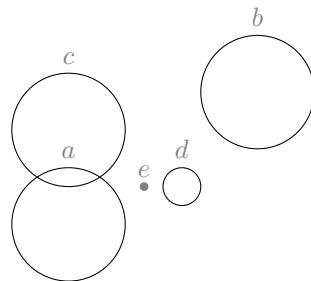

Figure 98:  $cd \rightarrow e, ad \rightarrow e, ab \rightarrow de$

APPENDIX B.2: REPRESENTATION OF SIZE 5 GEOMETRIES

99

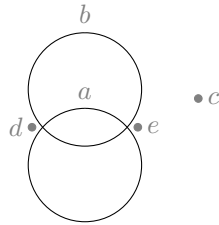

Figure 99:  $bc \rightarrow e, ac \rightarrow e, ab \rightarrow de$

100

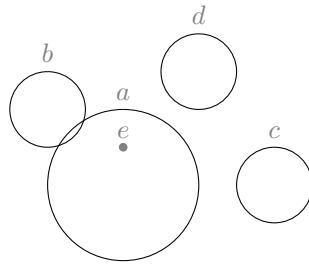

Figure 100:  $bc \rightarrow e, a \rightarrow e$



101

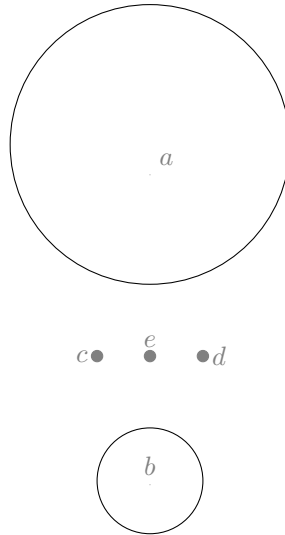

Figure 101:  $cd \rightarrow e, ab \rightarrow cde$

102

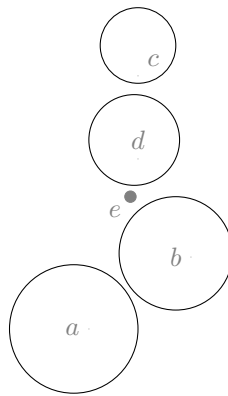

Figure 102:  $bd \rightarrow e, ad \rightarrow e, ac \rightarrow e, bc \rightarrow e, abc \rightarrow de$

103

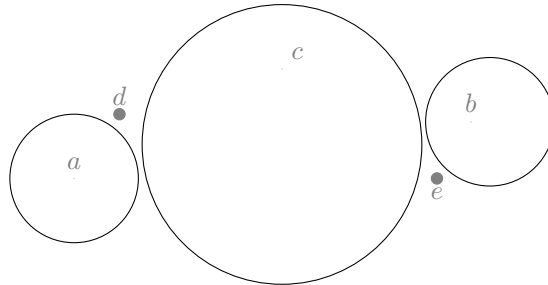

Figure 103:  $bc \rightarrow e$ ,  $ac \rightarrow d$ ,  $ab \rightarrow de$

104

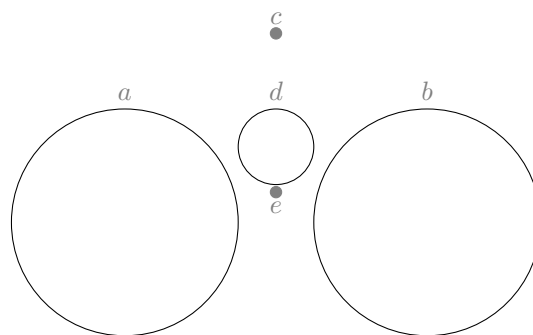

Figure 104:  $ad \rightarrow e$ ,  $bd \rightarrow e$ ,  $ab \rightarrow de$

106

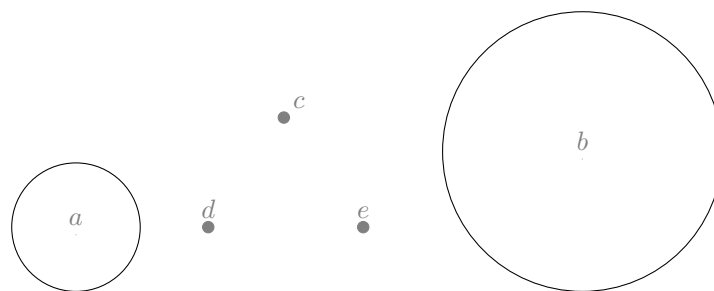

Figure 106:  $ae \rightarrow d$ ,  $bd \rightarrow e$ ,  $ab \rightarrow cde$

107

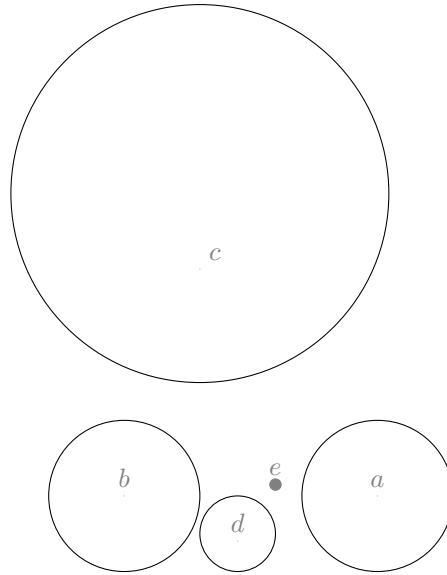

Figure 107:  $cd \rightarrow e, ad \rightarrow e, ac \rightarrow e, ab \rightarrow de$

108

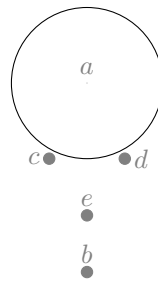

Figure 108:  $ae \rightarrow cd, bcd \rightarrow e, ab \rightarrow cde$

109

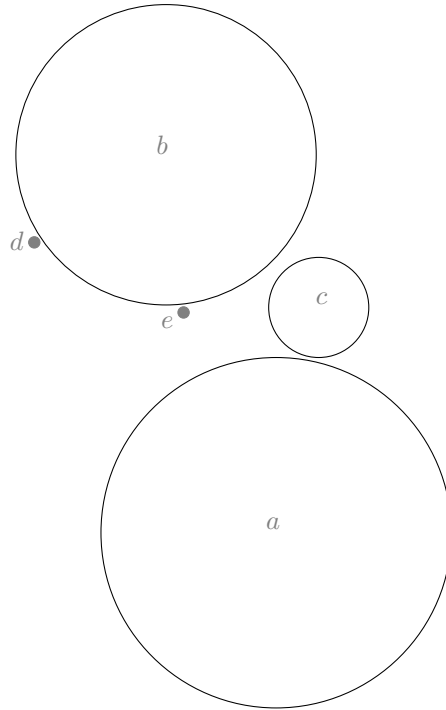

Figure 109:  $ad \rightarrow e, bc \rightarrow e, ab \rightarrow cde$

110

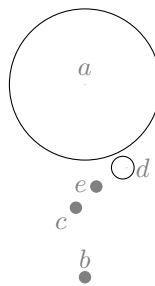

Figure 110:  $cd \rightarrow e, ac \rightarrow e, ab \rightarrow cde$

111

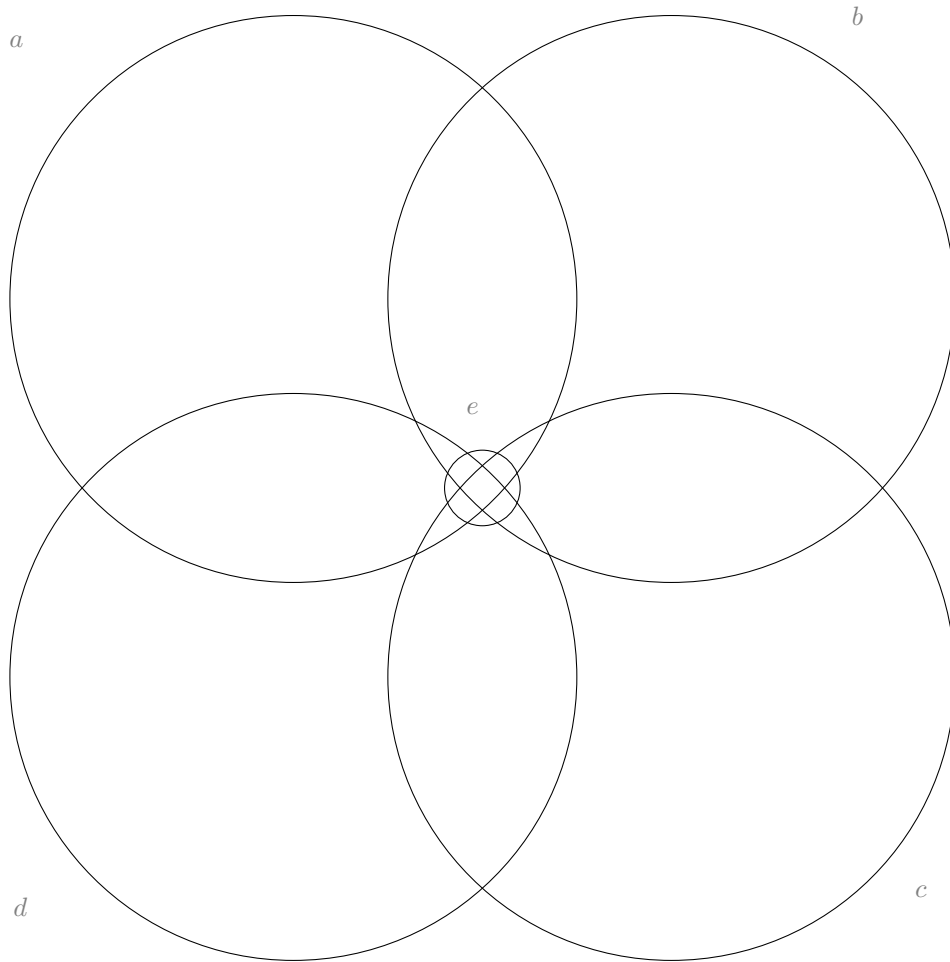

Figure 111:  $ab \rightarrow e, ac \rightarrow e, ad \rightarrow e, bc \rightarrow e, bd \rightarrow e, cd \rightarrow e$

APPENDIX B.2: REPRESENTATION OF SIZE 5 GEOMETRIES

112

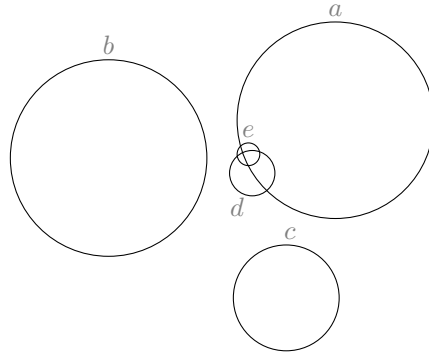

Figure 112:  $bd \rightarrow e, ad \rightarrow e, ac \rightarrow e, ab \rightarrow de$

113

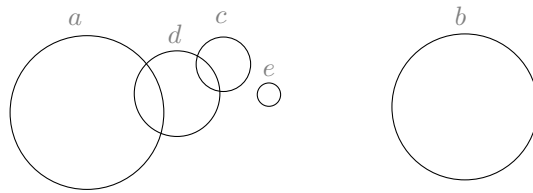

Figure 113:  $ace \rightarrow d, bd \rightarrow e, bc \rightarrow e, ab \rightarrow cde$

116

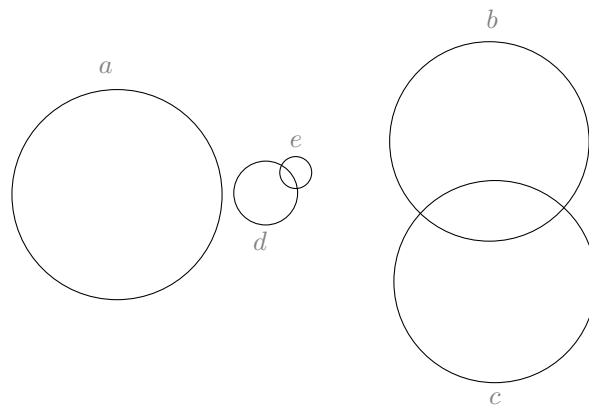

Figure 114:  $bd \rightarrow e, ac \rightarrow de, ab \rightarrow de$

APPENDIX B.2: REPRESENTATION OF SIZE 5 GEOMETRIES

117

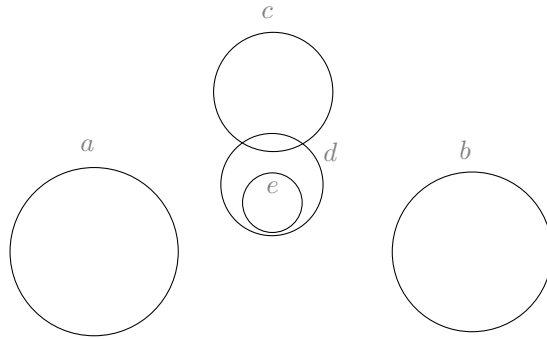

Figure 115:  $d \rightarrow e, abc \rightarrow de, ab \rightarrow e$

118

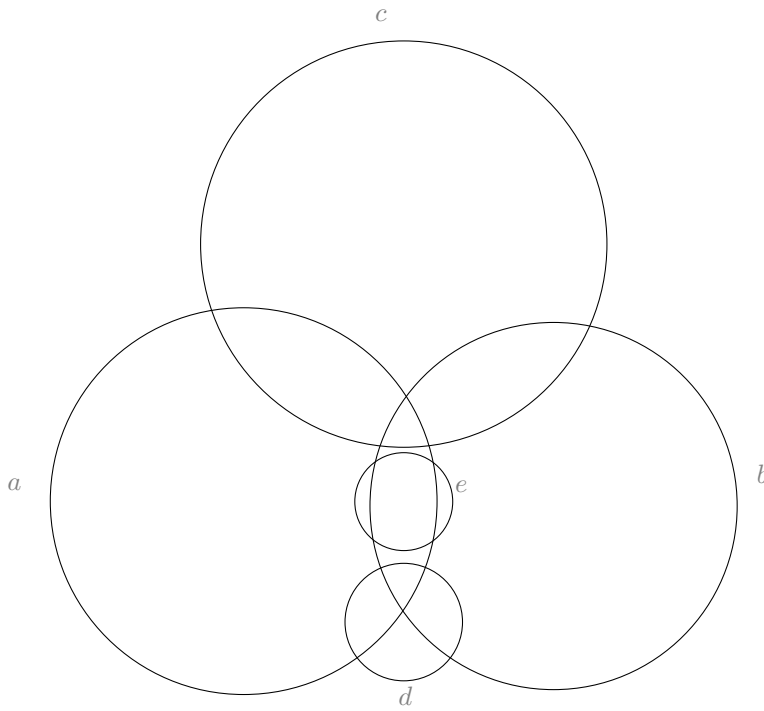

Figure 116:  $cd \rightarrow e, bc \rightarrow e, ac \rightarrow e, ab \rightarrow de$

APPENDIX B.2: REPRESENTATION OF SIZE 5 GEOMETRIES

119

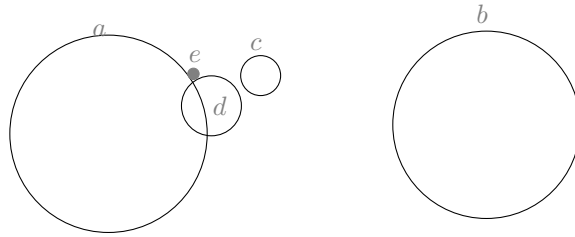

Figure 117:  $ad \rightarrow e, ac \rightarrow de, ab \rightarrow cde$

120

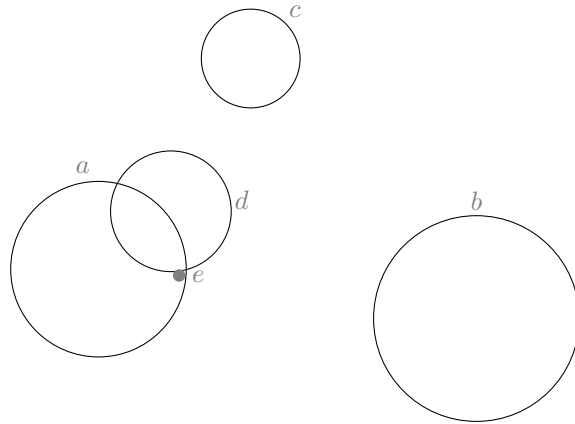

Figure 118:  $bd \rightarrow e, abc \rightarrow de, a \rightarrow e$

121

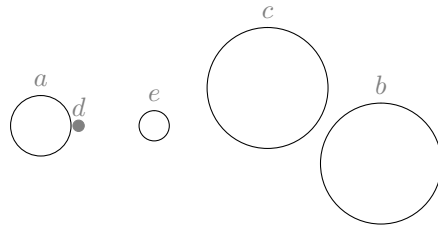

Figure 119:  $ae \rightarrow d, bcd \rightarrow e, ac \rightarrow de, ab \rightarrow de$



123

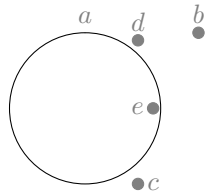

Figure 123:  $a \rightarrow e$ ,  $ab \rightarrow de$ ,  $bcd \rightarrow e$

124

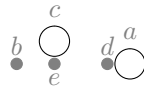

Figure 124:  $ae \rightarrow d$ ,  $bd \rightarrow e$ ,  $ac \rightarrow d$ ,  $ab \rightarrow de$

125

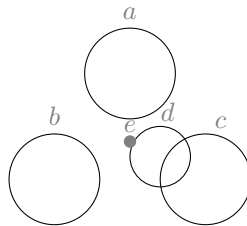

Figure 125:  $bd \rightarrow e$ ,  $ad \rightarrow e$ ,  $abc \rightarrow de$ ,  $bc \rightarrow e$ ,  $ac \rightarrow e$ ,  $ab \rightarrow e$

126

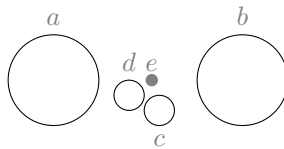

Figure 126:  $bd \rightarrow e$ ,  $ac \rightarrow d$ ,  $ab \rightarrow cde$

127

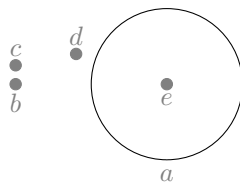

Figure 127:  $a \rightarrow e, ab \rightarrow de, ac \rightarrow de$

128

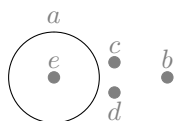

Figure 128:  $a \rightarrow e, ab \rightarrow cde$

130

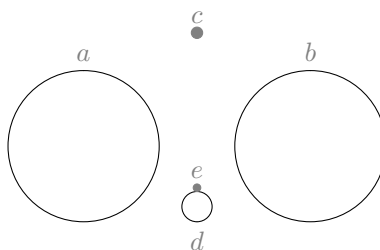

Figure 130:  $cd \rightarrow e, bd \rightarrow e, ad \rightarrow e, ab \rightarrow de$

131

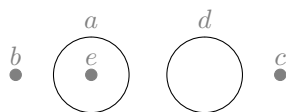

Figure 131:  $a \rightarrow e, bc \rightarrow e, bd \rightarrow e$

133

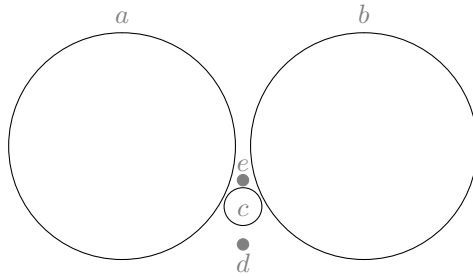

Figure 133:  $ac \rightarrow e$ ,  $bc \rightarrow e$ ,  $ab \rightarrow cde$

135

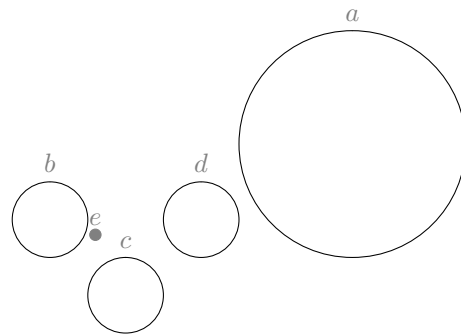

Figure 135:  $ab \rightarrow de$ ,  $ac \rightarrow d$ ,  $bc \rightarrow e$ ,  $bd \rightarrow e$

136

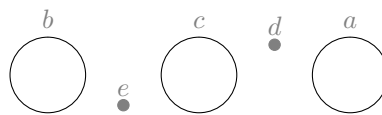

Figure 136:  $ab \rightarrow cde$ ,  $ac \rightarrow d$ ,  $bc \rightarrow e$

APPENDIX B.2: REPRESENTATION OF SIZE 5 GEOMETRIES

137

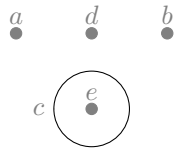

Figure 137:  $ab \rightarrow d, c \rightarrow e$

138

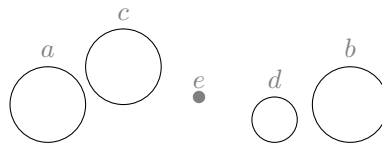

Figure 138:  $ab \rightarrow de, bc \rightarrow e, ad \rightarrow e, cd \rightarrow e$

139

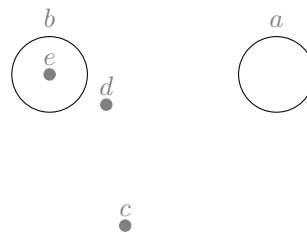

Figure 139:  $b \rightarrow e, ab \rightarrow de, ace \rightarrow d$

140

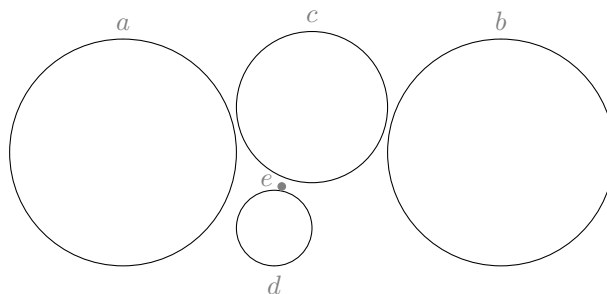

Figure 140:  $ab \rightarrow de, ac \rightarrow e, ad \rightarrow e, bd \rightarrow e, cd \rightarrow e$

APPENDIX B.2: REPRESENTATION OF SIZE 5 GEOMETRIES

141

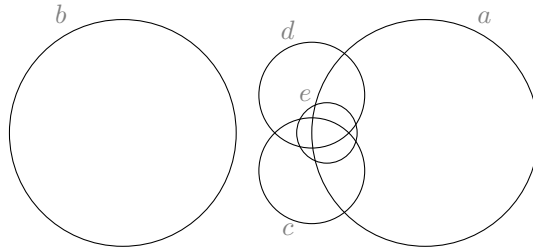

Figure 141:  $cd \rightarrow e$ ,  $ad \rightarrow e$ ,  $ac \rightarrow e$ ,  $ab \rightarrow cde$

142

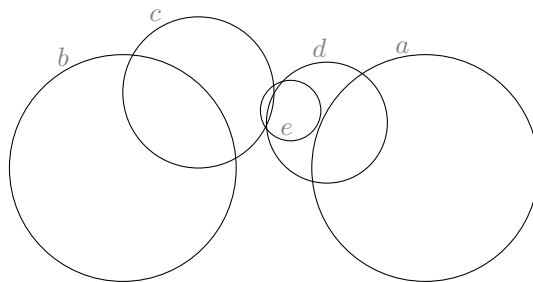

Figure 142:  $cd \rightarrow e$ ,  $bd \rightarrow e$ ,  $ac \rightarrow de$ ,  $ab \rightarrow de$

144

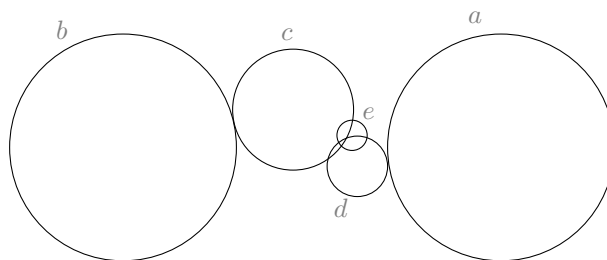

Figure 144:  $cd \rightarrow e$ ,  $ac \rightarrow de$ ,  $ab \rightarrow cde$

APPENDIX B.2: REPRESENTATION OF SIZE 5 GEOMETRIES

145

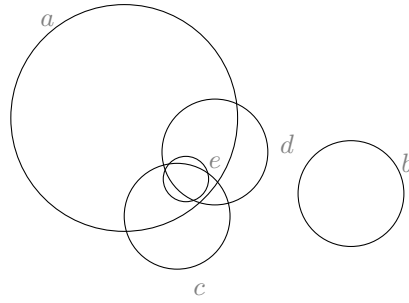

Figure 145:  $a \rightarrow e, ab \rightarrow de, cd \rightarrow e$

146

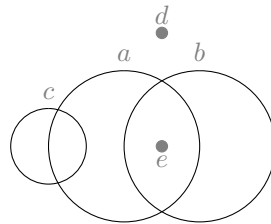

Figure 146:  $a \rightarrow e, b \rightarrow e$

148

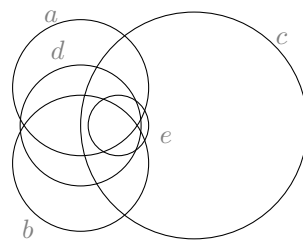

Figure 148:  $c \rightarrow e, ab \rightarrow de$

APPENDIX B.2: REPRESENTATION OF SIZE 5 GEOMETRIES

149

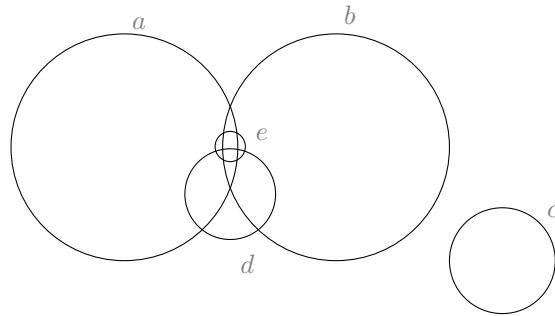

Figure 149:  $ab \rightarrow de, ac \rightarrow de, ad \rightarrow e, bd \rightarrow e$

150

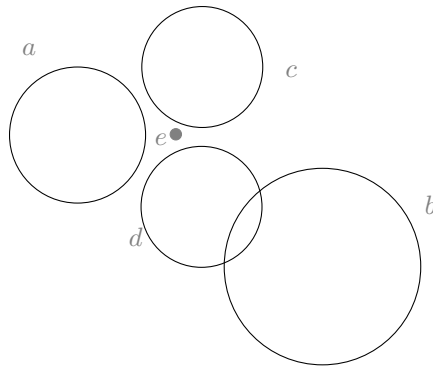

Figure 150:  $cd \rightarrow e, ad \rightarrow e, bc \rightarrow e, ac \rightarrow e, ab \rightarrow de$

151

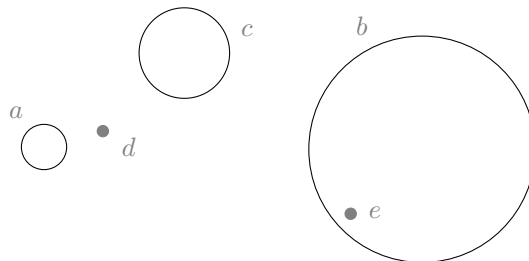

Figure 151:  $ac \rightarrow d, ab \rightarrow de, b \rightarrow e$

152

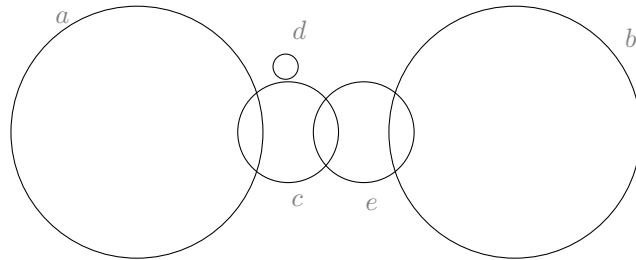

Figure 152:  $ae \rightarrow cd, bc \rightarrow e, ab \rightarrow cde$

154

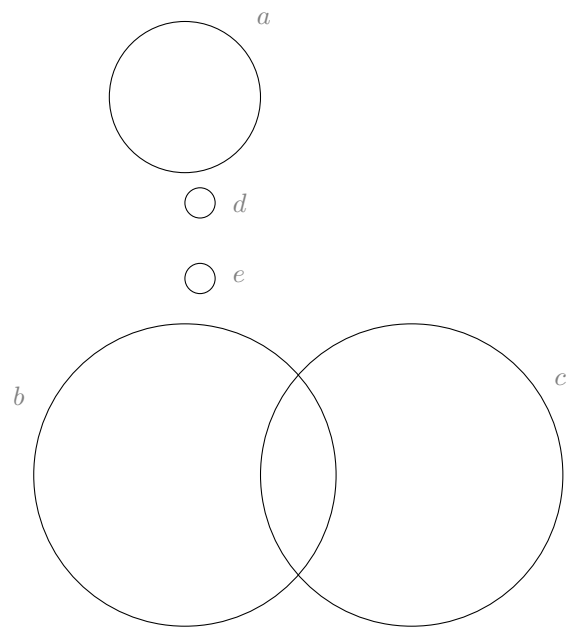

Figure 153:  $ae \rightarrow d, bd \rightarrow e, ac \rightarrow de, ab \rightarrow de$



155

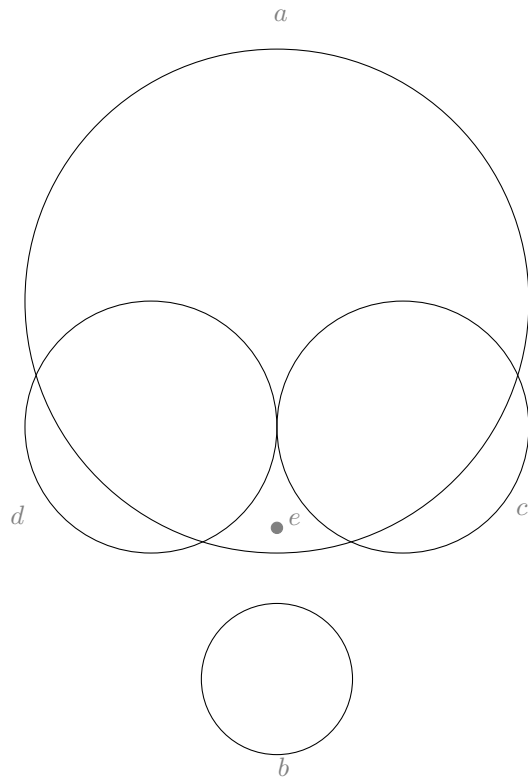

Figure 154:  $cd \rightarrow e, bd \rightarrow e, bc \rightarrow e, a \rightarrow e$

156

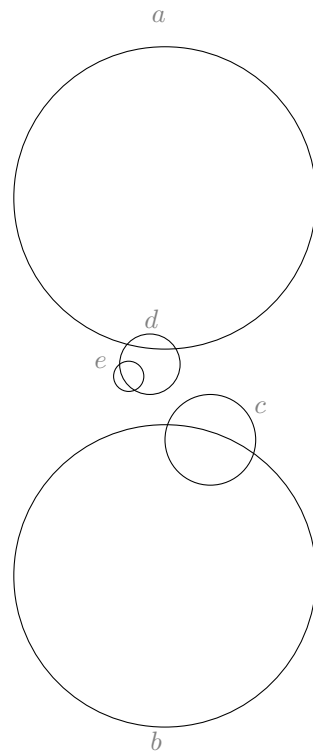

Figure 155:  $bd \rightarrow e, ac \rightarrow de, ab \rightarrow cde$

157

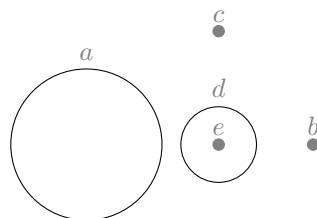

Figure 156:  $d \rightarrow e, ab \rightarrow de$

158

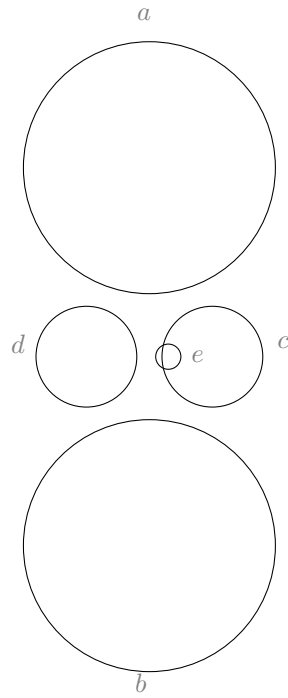

Figure 157:  $cd \rightarrow e, ac \rightarrow e, bc \rightarrow e, ab \rightarrow cde$

159

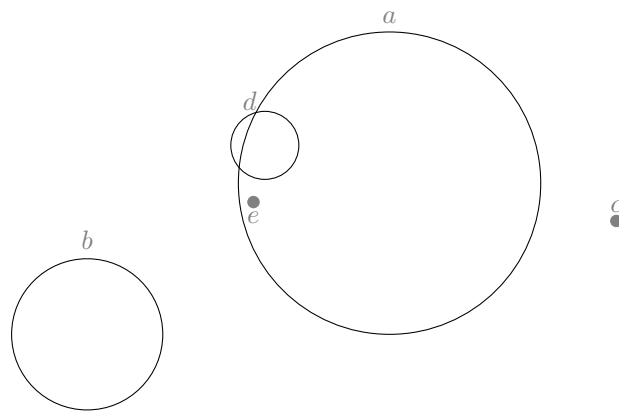

Figure 158:  $a \rightarrow e, bd \rightarrow e, ab \rightarrow de$

160

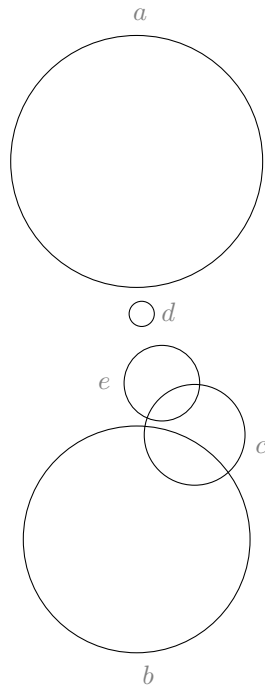

Figure 159:  $ae \rightarrow d, bcd \rightarrow e, ac \rightarrow de, ab \rightarrow cde$

162

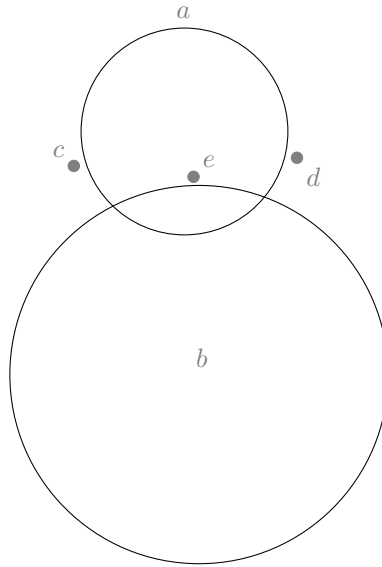

Figure 162:  $a \rightarrow e, ab \rightarrow cde, bcd \rightarrow e$

163

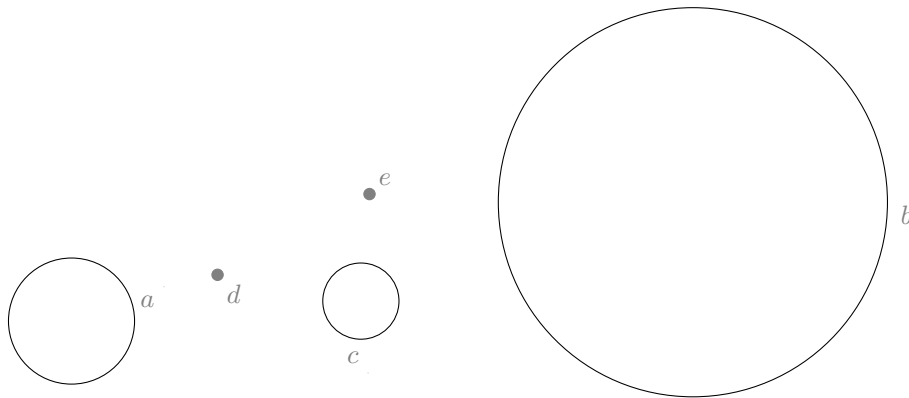

Figure 163:  $ae \rightarrow d, bd \rightarrow e, ac \rightarrow d, ab \rightarrow cde$

APPENDIX B.2: REPRESENTATION OF SIZE 5 GEOMETRIES

164

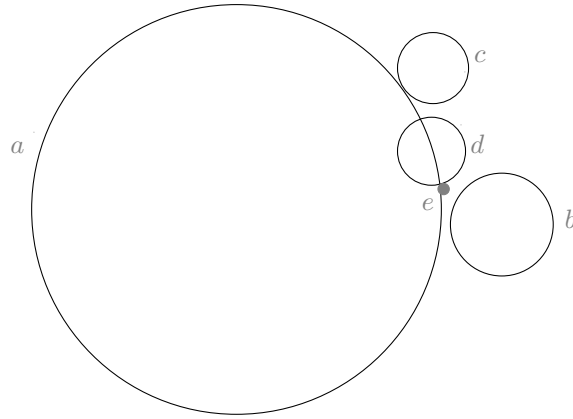

Figure 164:  $ab \rightarrow de, ac \rightarrow e, ad \rightarrow e, bc \rightarrow e, bd \rightarrow e$

165

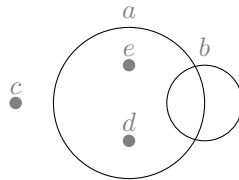

Figure 165:  $a \rightarrow de$

166

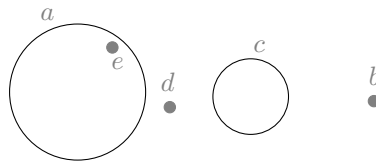

Figure 166:  $a \rightarrow e, ab \rightarrow cde, ac \rightarrow de$

167

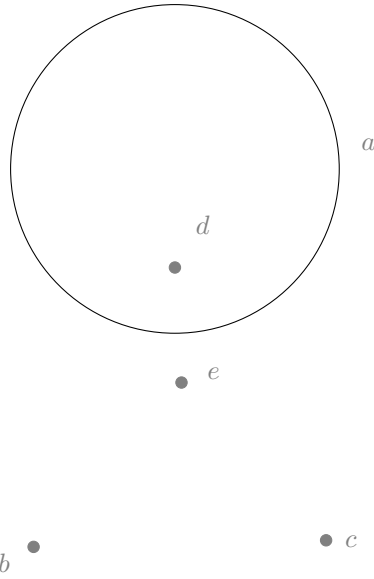

Figure 167:  $a- > d, ab- > de, ac- > de, bcd- > e$

168

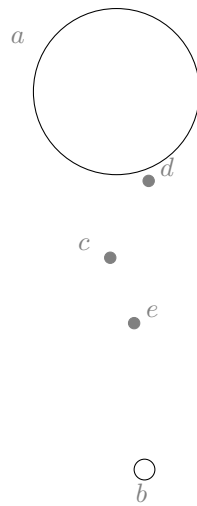

Figure 168:  $ab \rightarrow cde, ac \rightarrow d, ae \rightarrow cd, bcd \rightarrow e$

169

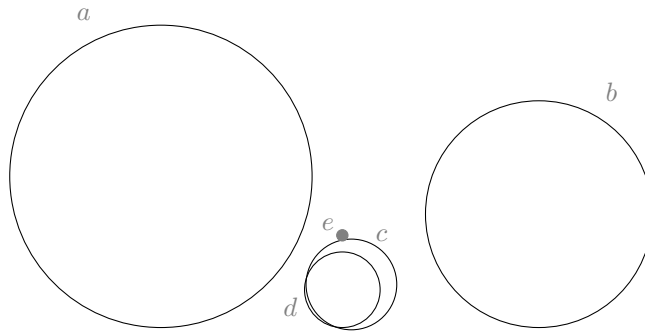

Figure 169:  $ab \rightarrow de, ac \rightarrow de, ad \rightarrow e, bc \rightarrow e$

170

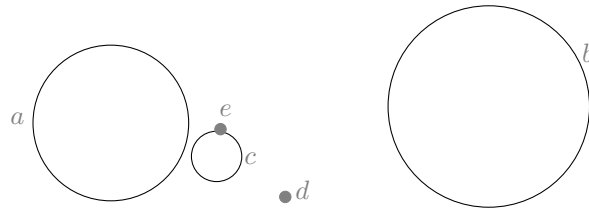

Figure 170:  $ab \rightarrow cde, ac \rightarrow e, ad \rightarrow e, bc \rightarrow e$



171

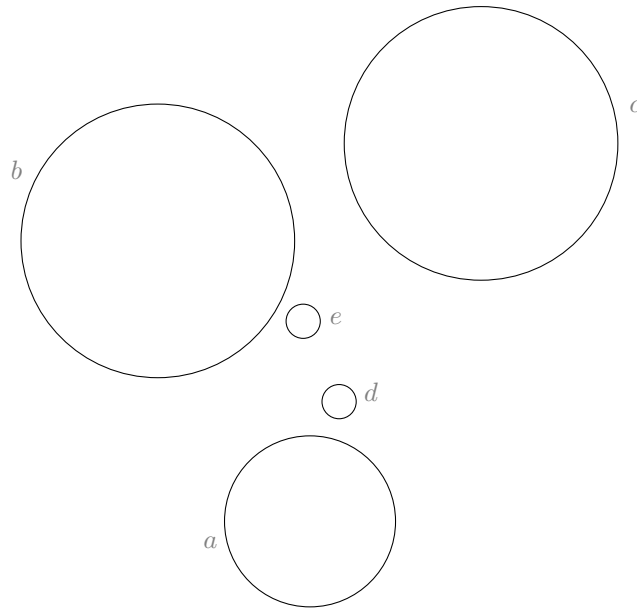

Figure 171:  $ab \rightarrow de, ac \rightarrow de, bc \rightarrow e, bd \rightarrow e$

172

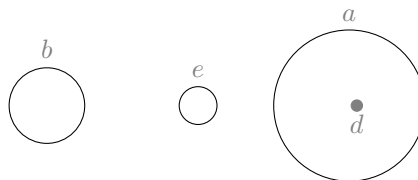

Figure 172:  $bd \rightarrow e, ab \rightarrow de, a \rightarrow d$

173

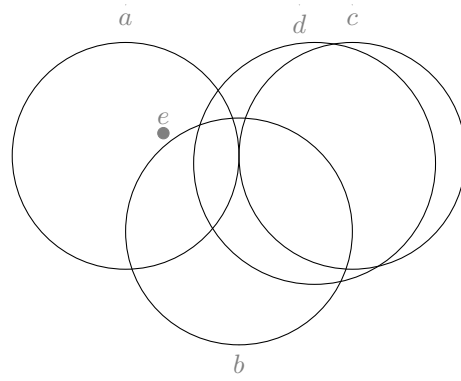

Figure 173:  $abc \rightarrow d, bc \rightarrow e, bd \rightarrow e, a \rightarrow e$

174

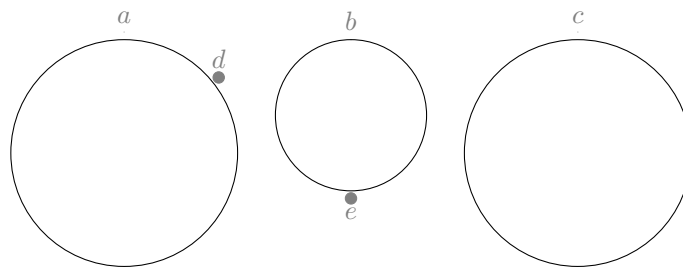

Figure 174:  $ab \rightarrow de, ac \rightarrow de, bc \rightarrow e, ae \rightarrow d$

176

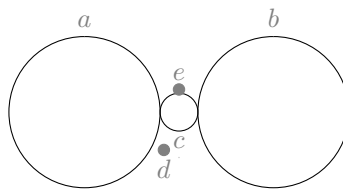

Figure 176:  $bc \rightarrow e, ac \rightarrow de, ab \rightarrow cde$

177

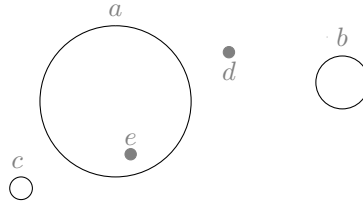

Figure 177:  $bc \rightarrow e, ab \rightarrow de, a \rightarrow e$

178

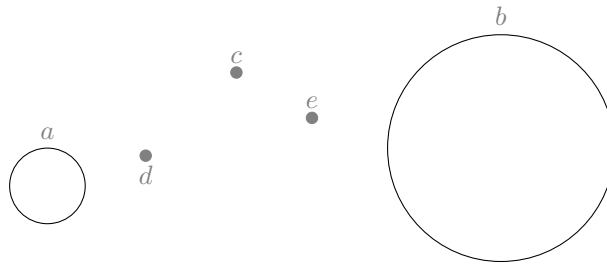

Figure 178:  $ae \rightarrow d, bd \rightarrow e, bc \rightarrow e, ac \rightarrow d, ab \rightarrow de$

179

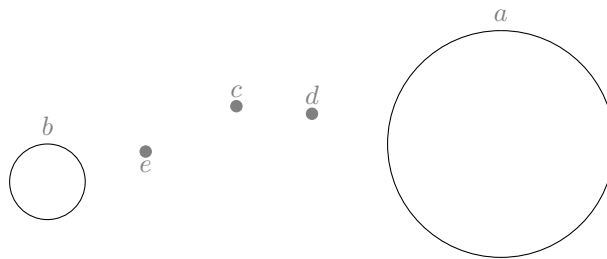

Figure 179:  $bd \rightarrow e, bc \rightarrow e, ac \rightarrow d, ab \rightarrow cde$

APPENDIX B.2: REPRESENTATION OF SIZE 5 GEOMETRIES

180

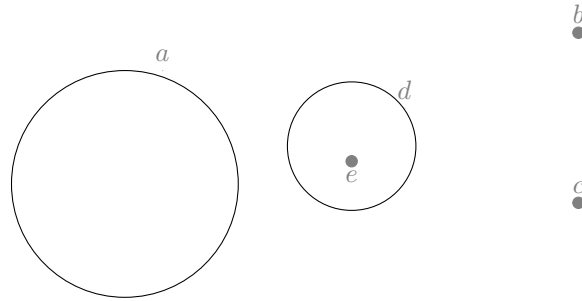

Figure 180:  $d \rightarrow e$ ,  $abc \rightarrow de$ ,  $ac \rightarrow e$ ,  $ab \rightarrow e$

181

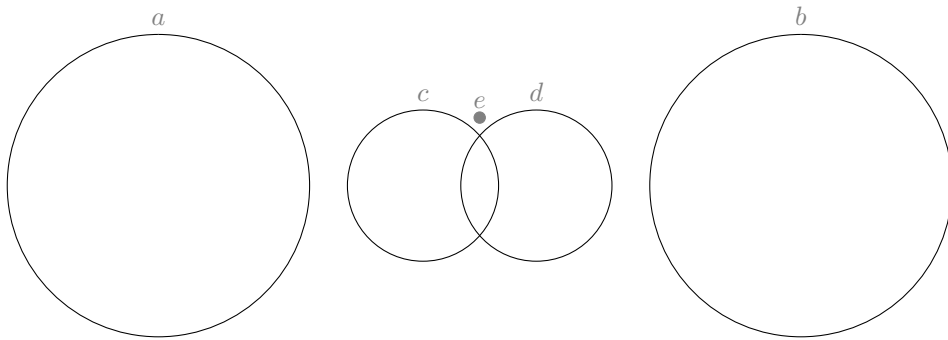

Figure 181:  $cd \rightarrow e$ ,  $ad \rightarrow e$ ,  $bc \rightarrow e$ ,  $ab \rightarrow cde$

182

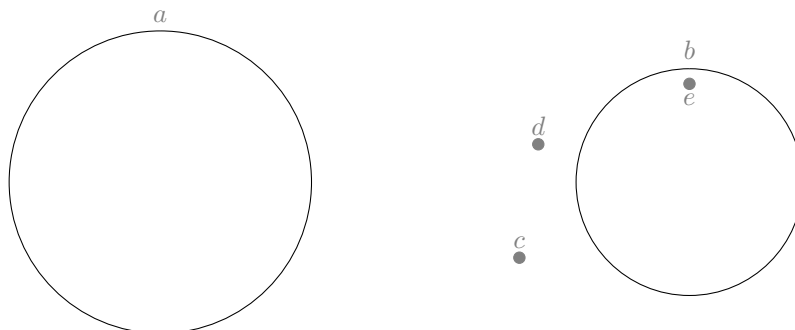

Figure 182:  $ace \rightarrow d$ ,  $ab \rightarrow cde$ ,  $b \rightarrow e$

APPENDIX B.2: REPRESENTATION OF SIZE 5 GEOMETRIES

183

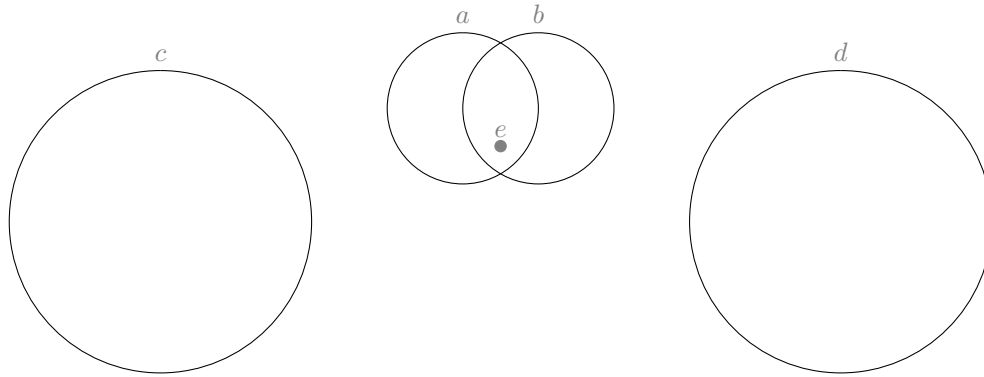

Figure 183:  $cd \rightarrow e, b \rightarrow e, a \rightarrow e$

184

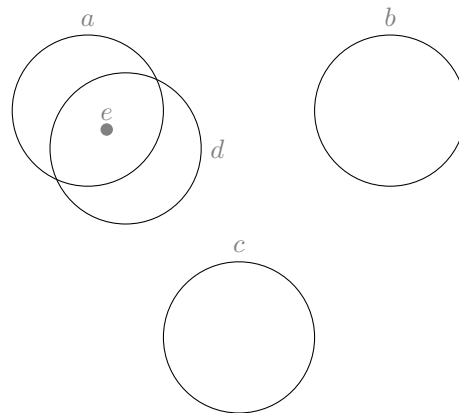

Figure 184:  $d \rightarrow e, abc \rightarrow de, a \rightarrow e$

185

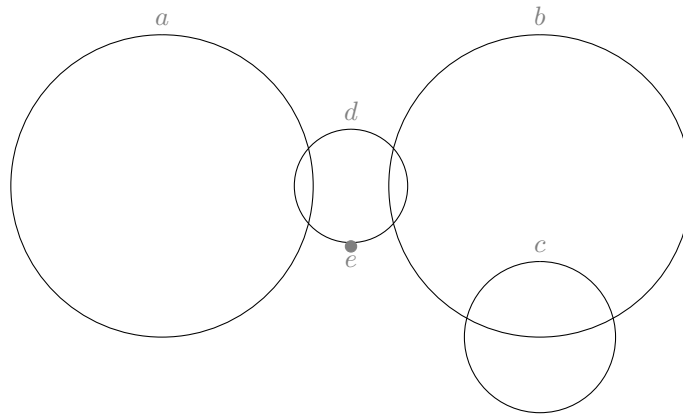

Figure 185:  $cd \rightarrow e$ ,  $bd \rightarrow e$ ,  $ad \rightarrow e$ ,  $ac \rightarrow de$ ,  $ab \rightarrow de$

186

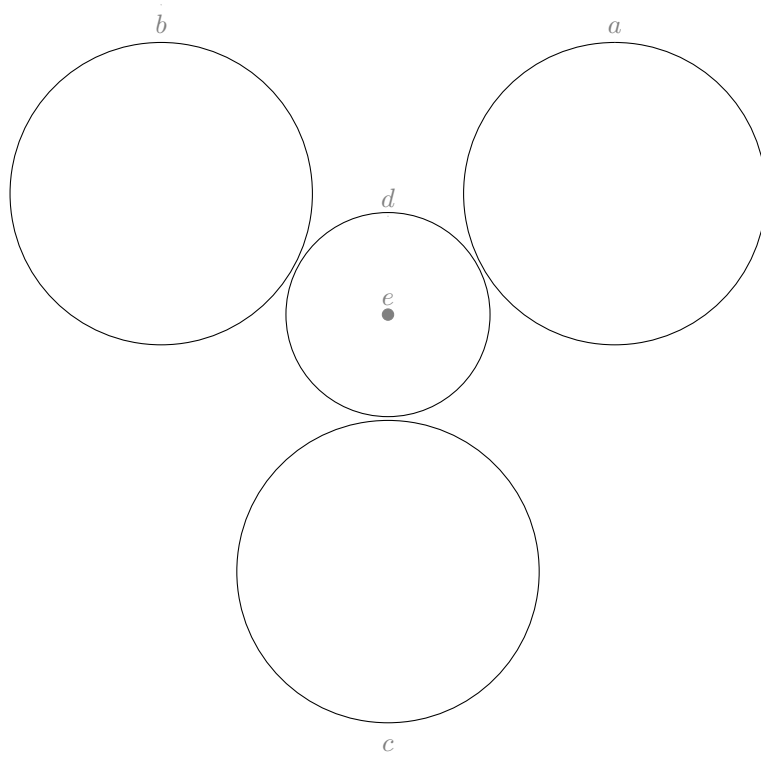

Figure 186:  $d \rightarrow e$ ,  $abc \rightarrow de$ ,  $bc \rightarrow e$ ,  $ac \rightarrow e$ ,  $ab \rightarrow e$

187

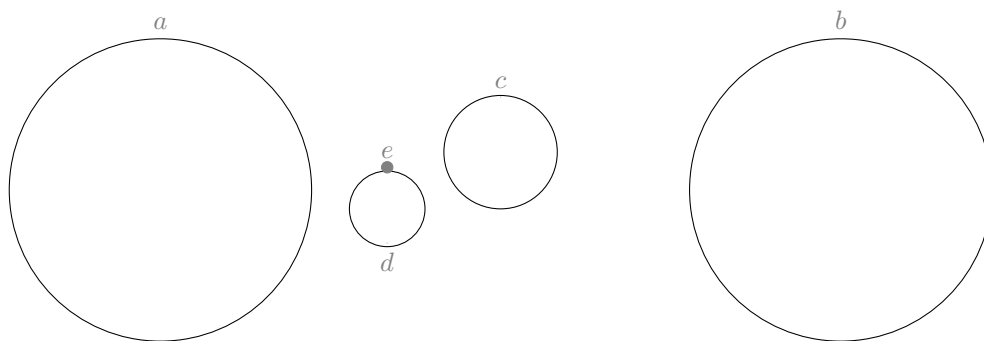

Figure 187:  $cd \rightarrow e$ ,  $ad \rightarrow e$ ,  $ac \rightarrow de$ ,  $ab \rightarrow cde$

APPENDIX B.2: REPRESENTATION OF SIZE 5 GEOMETRIES

188

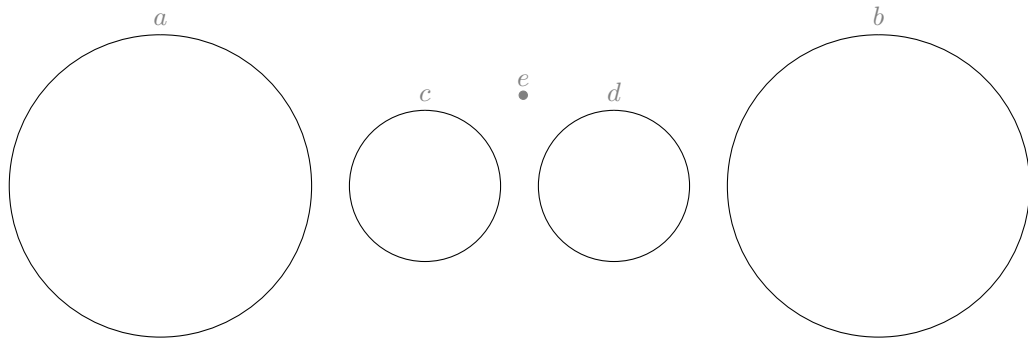

Figure 188:  $ad \rightarrow ce$ ,  $bc \rightarrow de$ ,  $ab \rightarrow cde$

189

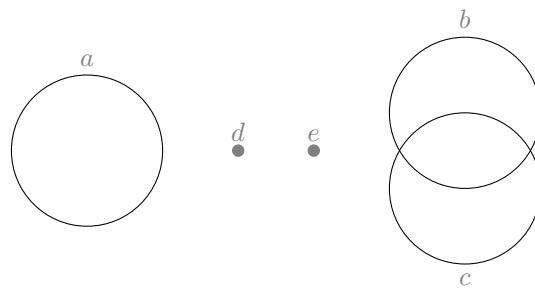

Figure 189:  $ae \rightarrow d$ ,  $cd \rightarrow e$ ,  $bd \rightarrow e$ ,  $ac \rightarrow de$ ,  $ab \rightarrow de$

190

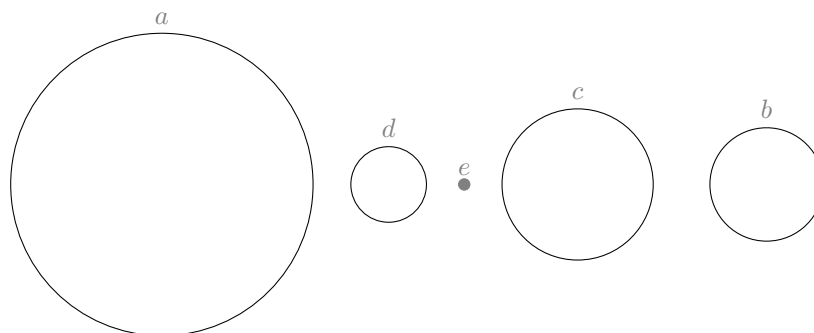

Figure 190:  $cd \rightarrow e$ ,  $bd \rightarrow e$ ,  $ac \rightarrow de$ ,  $ab \rightarrow cde$



APPENDIX B.2: REPRESENTATION OF SIZE 5 GEOMETRIES

191

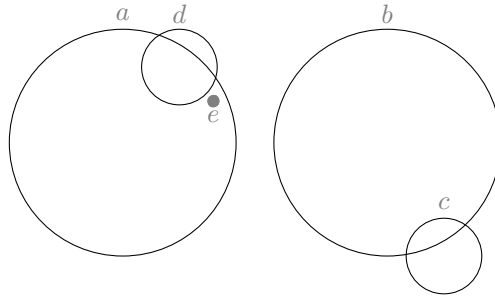

Figure 191:  $cd \rightarrow e$ ,  $bd \rightarrow e$ ,  $ab \rightarrow de$ ,  $a \rightarrow e$

192

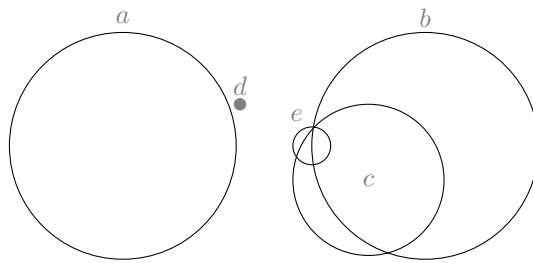

Figure 192:  $ae \rightarrow d$ ,  $cd \rightarrow e$ ,  $ac \rightarrow de$ ,  $ab \rightarrow cde$

193

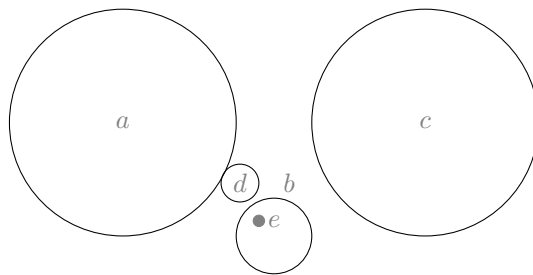

Figure 193:  $ac \rightarrow de$ ,  $ab \rightarrow de$ ,  $b \rightarrow e$

194

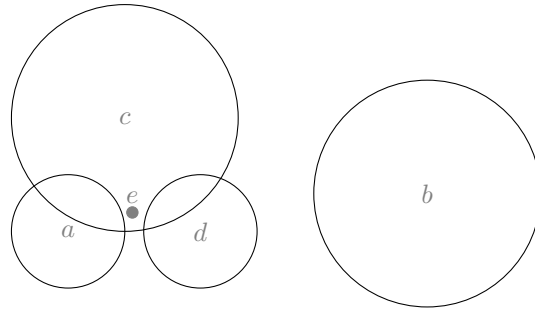

Figure 194:  $ad \rightarrow e, c \rightarrow e, ab \rightarrow de$

195

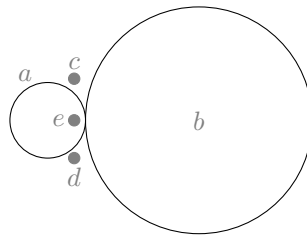

Figure 195:  $cd \rightarrow e, ab \rightarrow cde, a \rightarrow e$

196

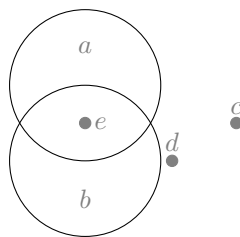

Figure 196:  $abc \rightarrow de, b \rightarrow e, a \rightarrow e$

APPENDIX B.2: REPRESENTATION OF SIZE 5 GEOMETRIES

197

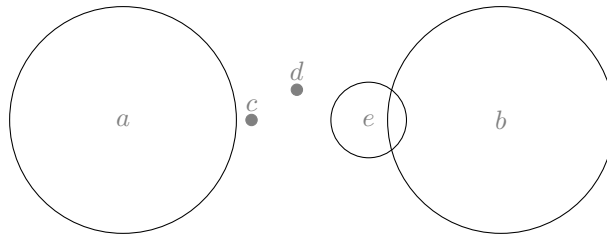

Figure 197:  $ae \rightarrow cd$ ,  $ad \rightarrow c$ ,  $bc \rightarrow e$ ,  $ab \rightarrow cde$

198

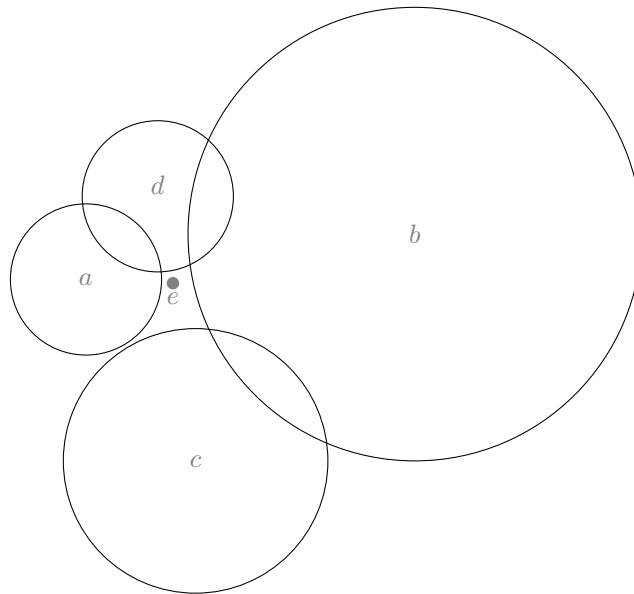

Figure 198:  $cd \rightarrow e$ ,  $bd \rightarrow e$ ,  $ad \rightarrow e$ ,  $bc \rightarrow e$ ,  $ac \rightarrow e$ ,  $ab \rightarrow de$

APPENDIX B.2: REPRESENTATION OF SIZE 5 GEOMETRIES

199

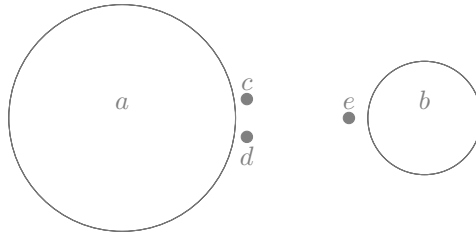

Figure 199:  $ae \rightarrow cd, bd \rightarrow e, bc \rightarrow e, ab \rightarrow cde$

200

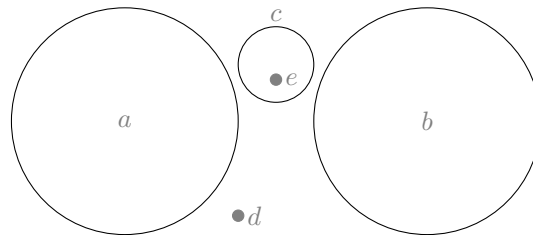

Figure 200:  $c \rightarrow e, ab \rightarrow cde$

201

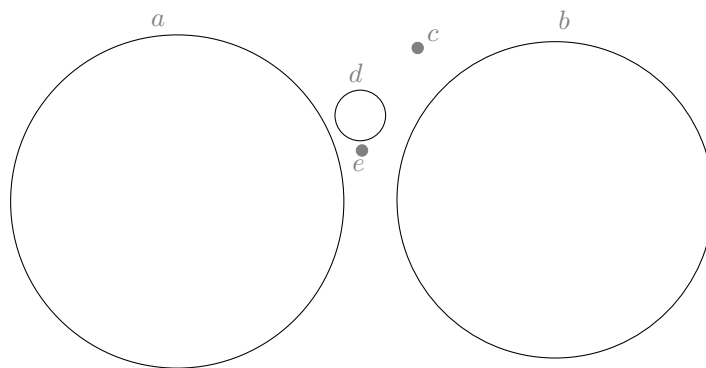

Figure 201:  $bd \rightarrow e, ad \rightarrow e, ac \rightarrow de, ab \rightarrow cde$

APPENDIX B.2: REPRESENTATION OF SIZE 5 GEOMETRIES

202

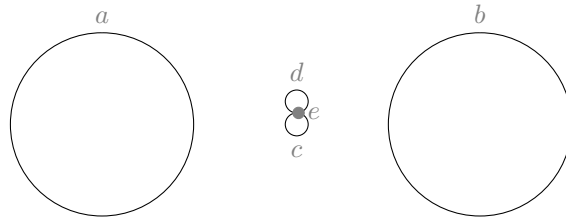

Figure 202:  $cd \rightarrow e$ ,  $ad \rightarrow e$ ,  $bc \rightarrow e$ ,  $ac \rightarrow e$ ,  $ab \rightarrow cde$

203

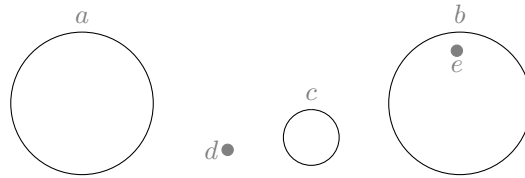

Figure 203:  $ac \rightarrow d$ ,  $ab \rightarrow cde$ ,  $b \rightarrow e$

204

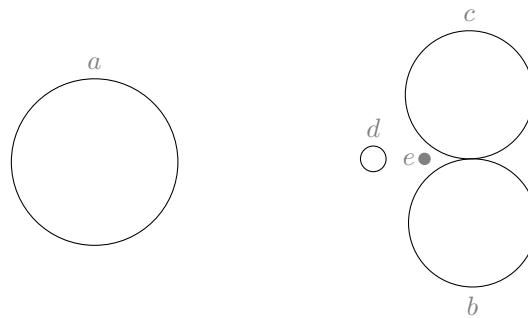

Figure 204:  $cd \rightarrow e$ ,  $bd \rightarrow e$ ,  $bc \rightarrow e$ ,  $ac \rightarrow de$ ,  $ab \rightarrow de$

APPENDIX B.2: REPRESENTATION OF SIZE 5 GEOMETRIES

205

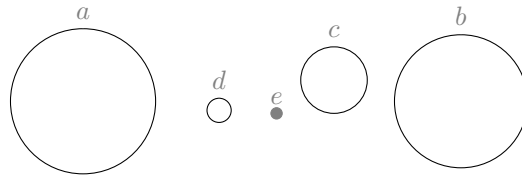

Figure 205:  $ae \rightarrow d, bd \rightarrow e, ac \rightarrow de, ab \rightarrow cde$

207

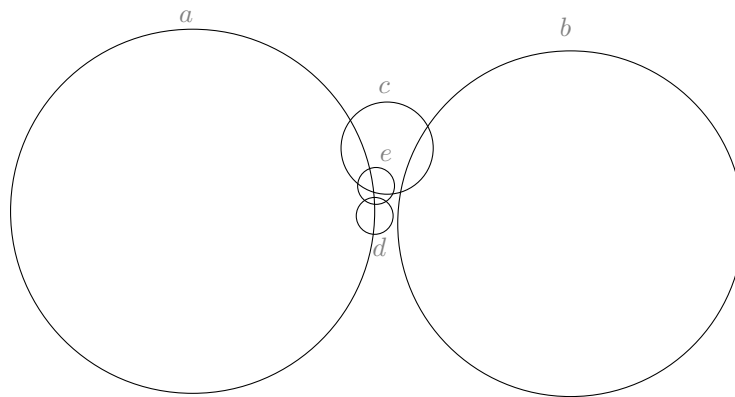

Figure 207:  $cd \rightarrow e, bc \rightarrow e, ac \rightarrow de, ab \rightarrow cde$

208

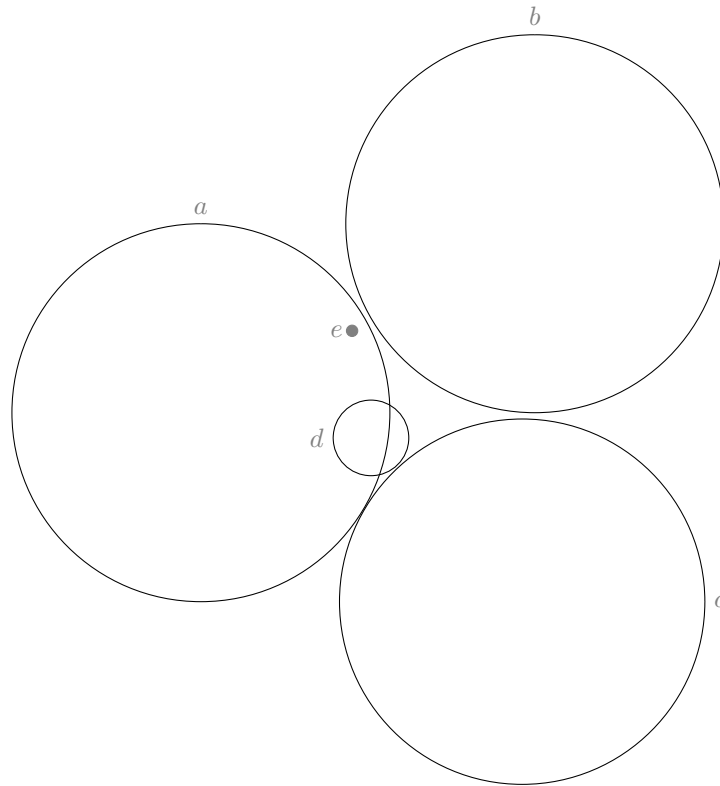

Figure 208:  $bd \rightarrow e$ ,  $ac \rightarrow de$ ,  $ab \rightarrow de$ ,  $a \rightarrow e$

209

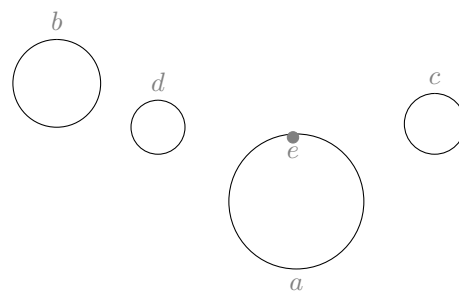

Figure 209:  $cd \rightarrow e$ ,  $bc \rightarrow e$ ,  $ab \rightarrow de$ ,  $a \rightarrow e$

APPENDIX B.2: REPRESENTATION OF SIZE 5 GEOMETRIES

210

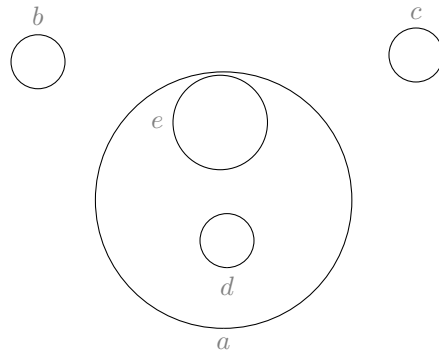

Figure 210:  $bcd \rightarrow e, a \rightarrow de$

212

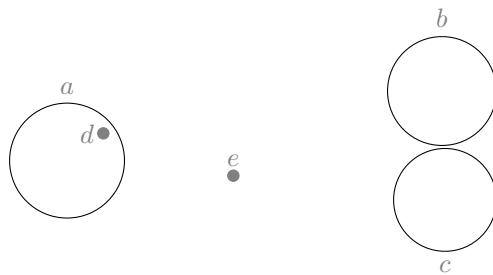

Figure 212:  $bd \rightarrow e, ac \rightarrow de, ab \rightarrow de, a \rightarrow d$

213

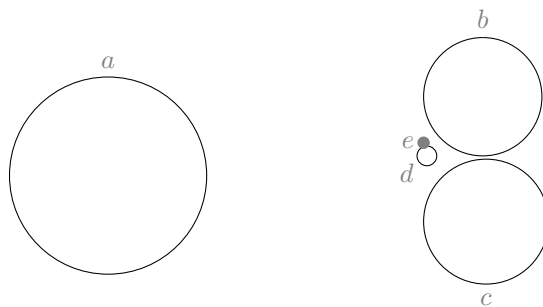

Figure 213:  $bd \rightarrow e, ad \rightarrow e, bc \rightarrow e, ac \rightarrow de, ab \rightarrow de$



214

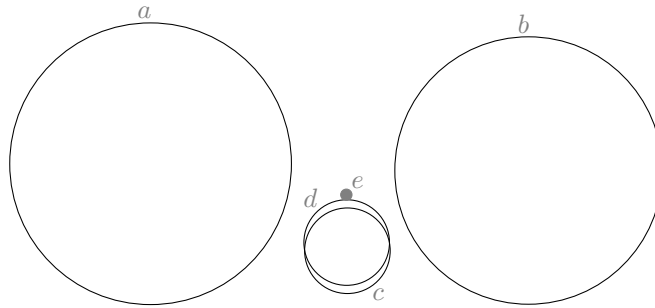

Figure 214:  $bd \rightarrow e, ad \rightarrow e, bc \rightarrow e, ac \rightarrow e, ab \rightarrow cde$

215

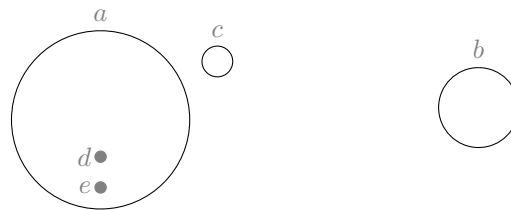

Figure 215:  $ab \rightarrow cde, a \rightarrow de$

216

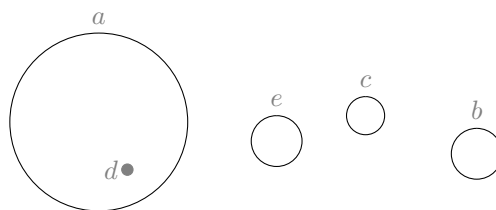

Figure 216:  $bcd \rightarrow e, ac \rightarrow de, ab \rightarrow cde, a \rightarrow d$

APPENDIX B.2: REPRESENTATION OF SIZE 5 GEOMETRIES

217

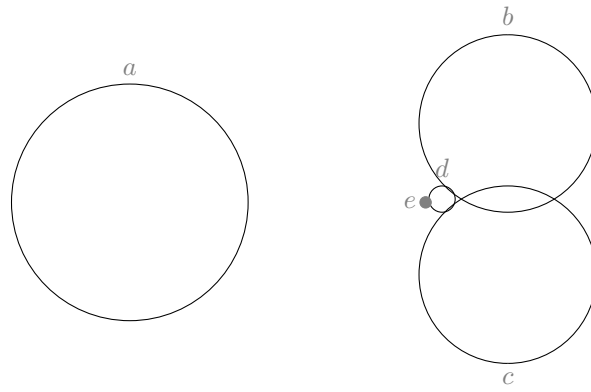

Figure 217:  $ad \rightarrow e$ ,  $bc \rightarrow de$ ,  $ac \rightarrow de$ ,  $ab \rightarrow de$

218

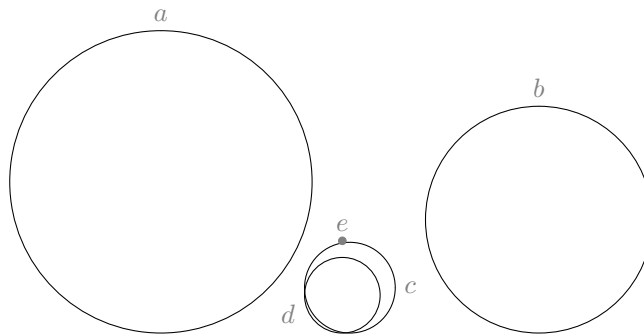

Figure 218:  $ad \rightarrow e$ ,  $bc \rightarrow e$ ,  $ac \rightarrow de$ ,  $ab \rightarrow cde$

APPENDIX B.2: REPRESENTATION OF SIZE 5 GEOMETRIES

219

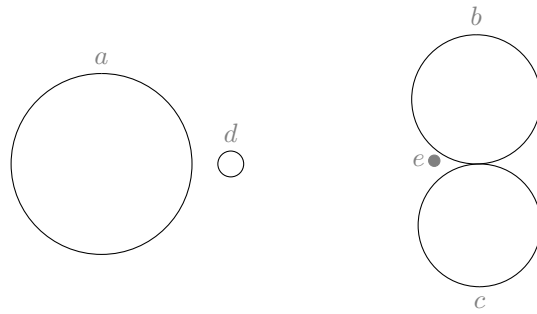

Figure 219:  $ae \rightarrow d$ ,  $bd \rightarrow e$ ,  $bc \rightarrow e$ ,  $ac \rightarrow de$ ,  $ab \rightarrow de$

220

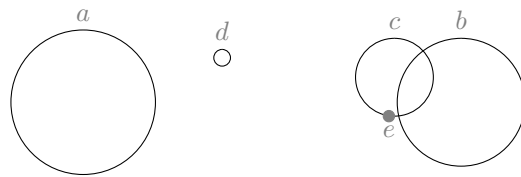

Figure 220:  $bd \rightarrow e$ ,  $bc \rightarrow e$ ,  $ac \rightarrow de$ ,  $ab \rightarrow cde$

221

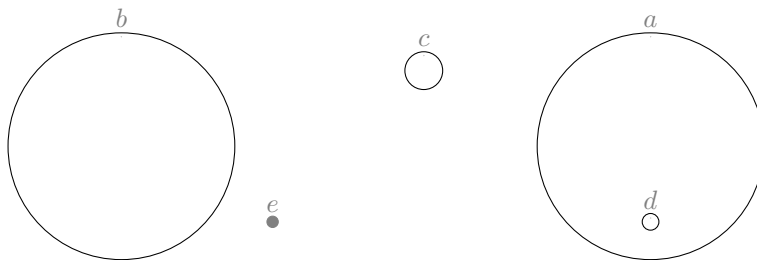

Figure 221:  $bd \rightarrow e$ ,  $ab \rightarrow cde$ ,  $a \rightarrow d$

APPENDIX B.2: REPRESENTATION OF SIZE 5 GEOMETRIES

222

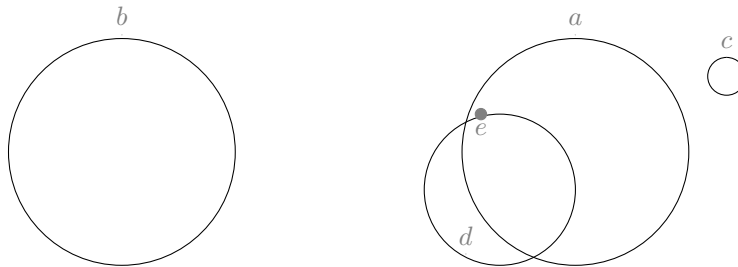

Figure 222:  $bd \rightarrow e$ ,  $bc \rightarrow e$ ,  $ab \rightarrow de$ ,  $a \rightarrow e$

223

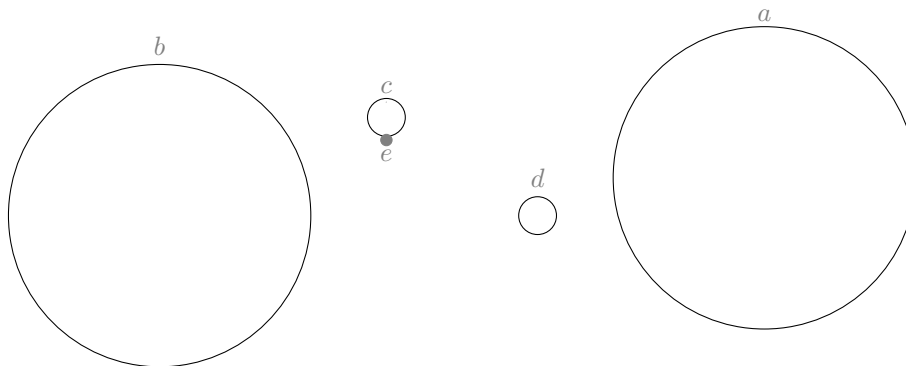

Figure 223:  $ae \rightarrow d$ ,  $bc \rightarrow e$ ,  $ac \rightarrow de$ ,  $ab \rightarrow cde$

224

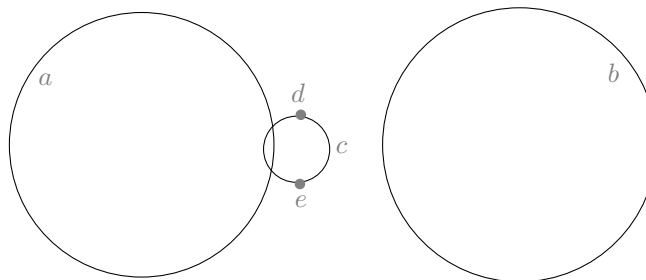

Figure 224:  $ab \rightarrow cde$ ,  $ac \rightarrow de$ ,  $bc \rightarrow de$

APPENDIX B.2: REPRESENTATION OF SIZE 5 GEOMETRIES

225

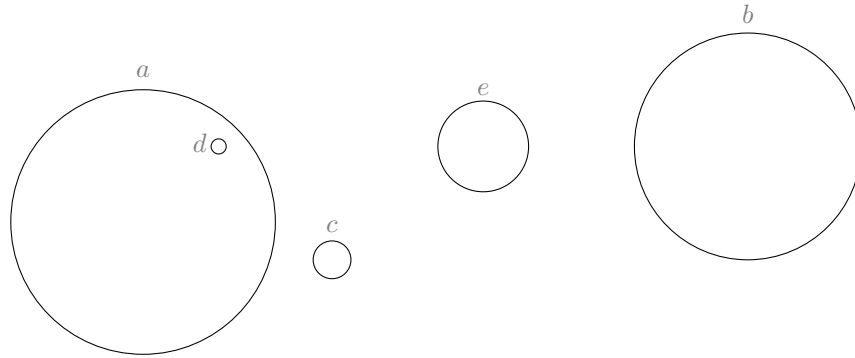

Figure 225:  $ae \rightarrow cd, bcd \rightarrow e, ab \rightarrow cde, a \rightarrow d$

226

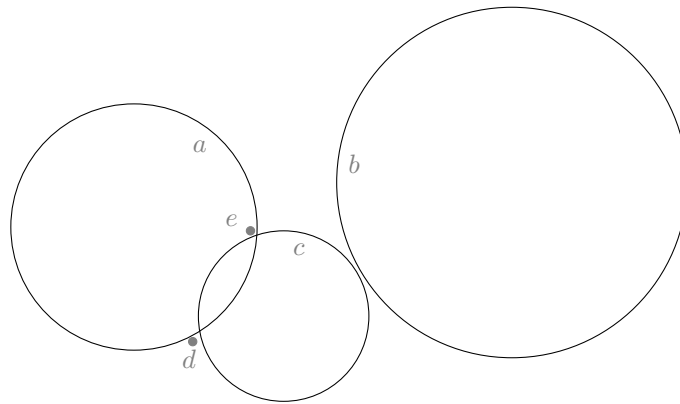

Figure 226:  $bc \rightarrow e, ac \rightarrow de, ab \rightarrow de, a \rightarrow e$

227

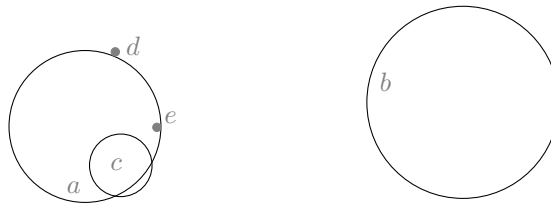

Figure 227:  $bc \rightarrow e, ab \rightarrow cde, a \rightarrow e$

APPENDIX B.2: REPRESENTATION OF SIZE 5 GEOMETRIES

228

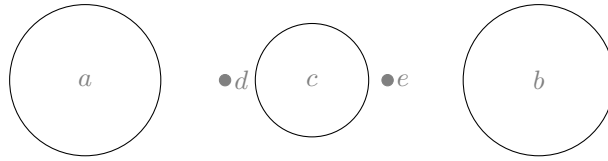

Figure 228:  $ae \rightarrow d$ ,  $bd \rightarrow e$ ,  $ac \rightarrow d$ ,  $ab \rightarrow cde$

229

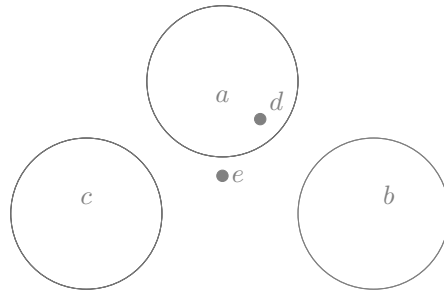

Figure 229:  $bc \rightarrow e$ ,  $ac \rightarrow de$ ,  $ab \rightarrow de$ ,  $a \rightarrow d$

230

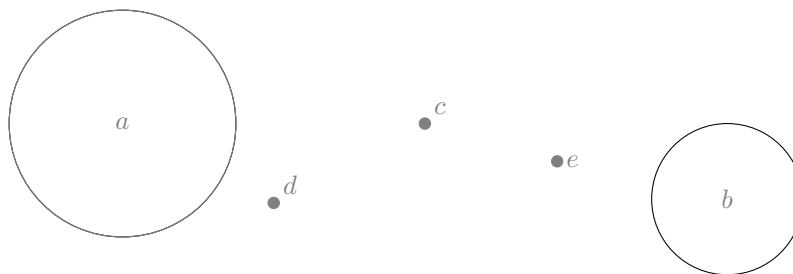

Figure 230:  $ae \rightarrow cd$ ,  $bc \rightarrow e$ ,  $ac \rightarrow d$ ,  $ab \rightarrow cde$

APPENDIX B.2: REPRESENTATION OF SIZE 5 GEOMETRIES

231

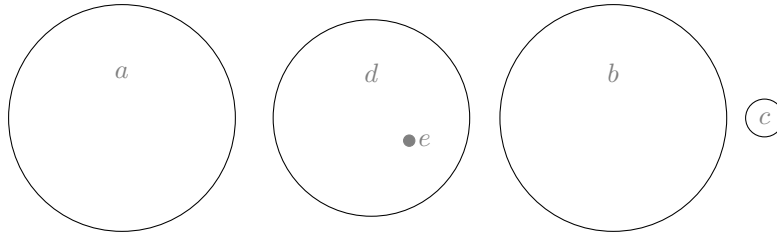

Figure 231:  $d \rightarrow e$ ,  $ac \rightarrow e$ ,  $ab \rightarrow de$

232

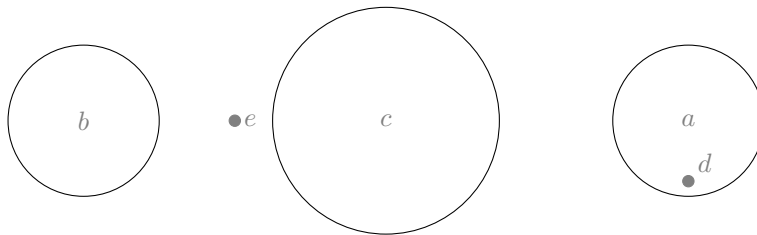

Figure 232:  $bd \rightarrow e$ ,  $bc \rightarrow e$ ,  $ab \rightarrow de$ ,  $a \rightarrow d$

233

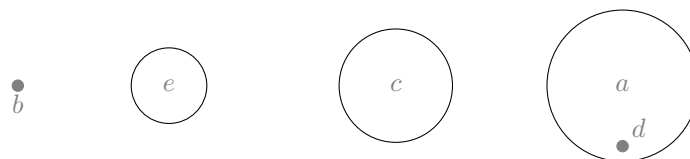

Figure 233:  $ae \rightarrow cd$ ,  $bc \rightarrow e$ ,  $ab \rightarrow cde$ ,  $a \rightarrow d$

234

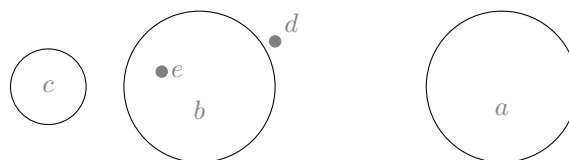

Figure 234:  $cd \rightarrow e$ ,  $ac \rightarrow de$ ,  $ab \rightarrow de$ ,  $b \rightarrow e$

236

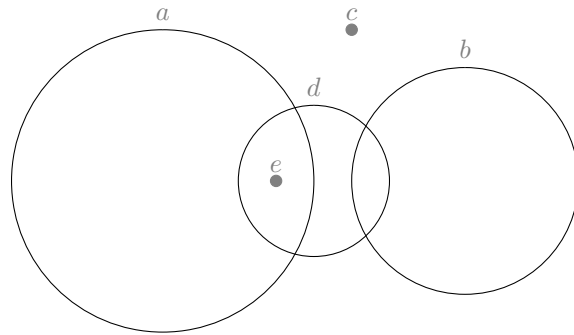

Figure 236:  $a \rightarrow e$ ,  $d \rightarrow e$ ,  $ab \rightarrow de$

237

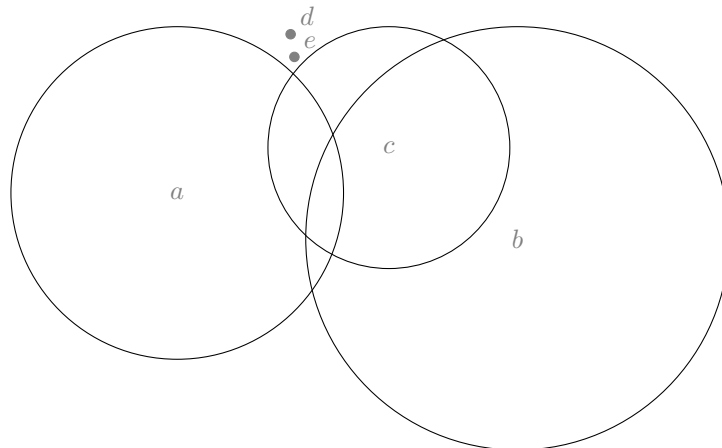

Figure 237:  $cd \rightarrow e$ ,  $bd \rightarrow e$ ,  $ad \rightarrow e$ ,  $ac \rightarrow de$ ,  $ab \rightarrow cde$



238

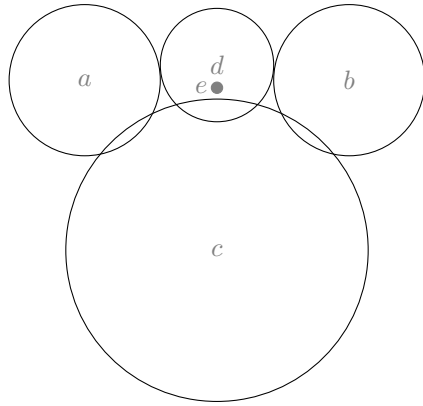

Figure 238:  $d \rightarrow e$ ,  $bc \rightarrow e$ ,  $ac \rightarrow e$ ,  $ab \rightarrow de$

239

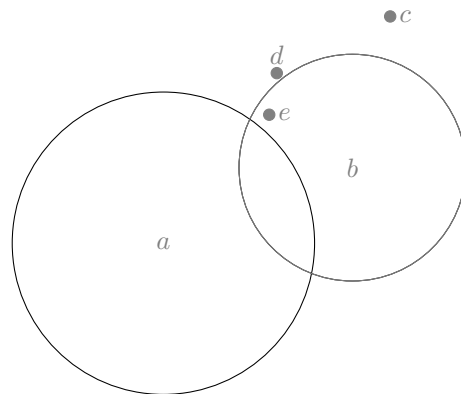

Figure 239:  $ad \rightarrow e$ ,  $ac \rightarrow de$ ,  $ab \rightarrow de$ ,  $b \rightarrow e$

APPENDIX B.2: REPRESENTATION OF SIZE 5 GEOMETRIES

240

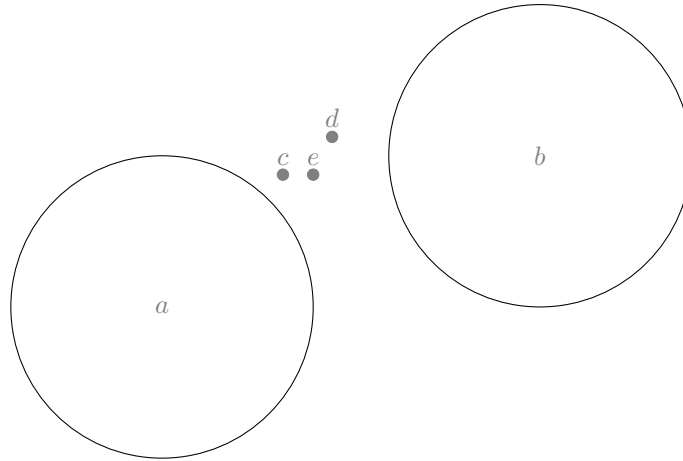

Figure 240:  $ae \rightarrow c$ ,  $ad \rightarrow ce$ ,  $bc \rightarrow de$ ,  $ab \rightarrow cde$

241

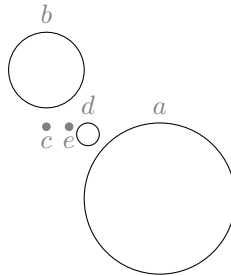

Figure 241:  $ae \rightarrow d$ ,  $cd \rightarrow e$ ,  $bd \rightarrow e$ ,  $ac \rightarrow de$ ,  $ab \rightarrow cde$

242

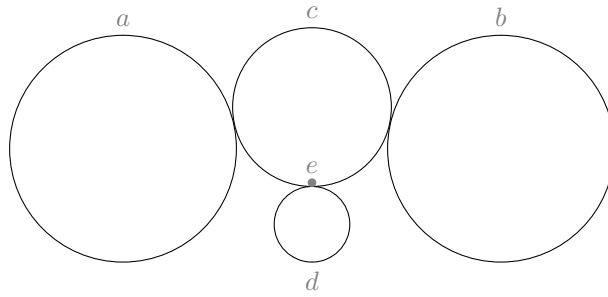

Figure 242:  $c \rightarrow e$ ,  $ad \rightarrow e$ ,  $bd \rightarrow e$ ,  $ab \rightarrow de$

243

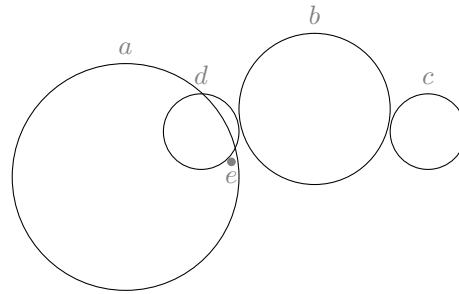

Figure 243:  $a \rightarrow e$ ,  $ab \rightarrow de$ ,  $ac \rightarrow de$ ,  $bd \rightarrow e$ ,  $cd \rightarrow e$

244

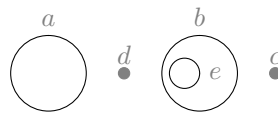

Figure 244:  $b \rightarrow e$ ,  $ab \rightarrow de$ ,  $ac \rightarrow de$ ,  $ae \rightarrow d$

245

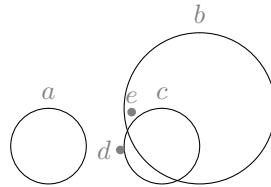

Figure 245:  $b \rightarrow e$ ,  $ab \rightarrow cde$ ,  $ac \rightarrow de$

246

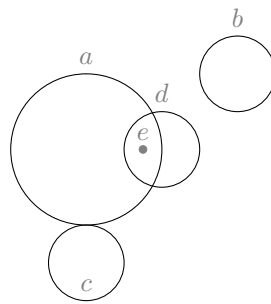

Figure 246:  $a \rightarrow e$ ,  $d \rightarrow e$ ,  $bc \rightarrow e$ ,  $abc \rightarrow d$

247

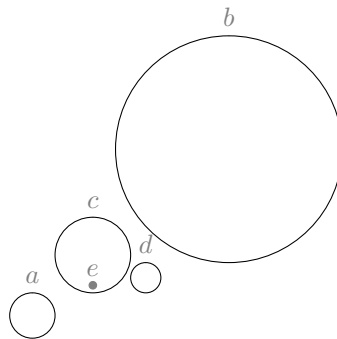

Figure 247:  $c \rightarrow e$ ,  $ad \rightarrow e$ ,  $ab \rightarrow cd$

248

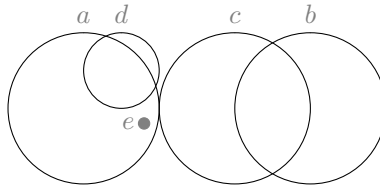

Figure 248:  $a \rightarrow e$ ,  $cd \rightarrow e$ ,  $ac \rightarrow de$ ,  $ab \rightarrow cde$

249

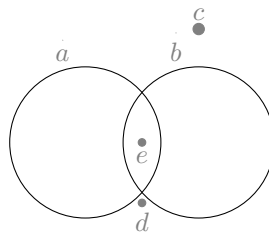

Figure 249:  $a \rightarrow e$ ,  $b \rightarrow e$ ,  $ab \rightarrow de$

250

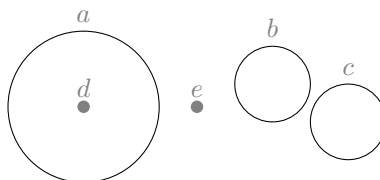

Figure 250:  $a \rightarrow d$ ,  $ab \rightarrow de$ ,  $ac \rightarrow de$ ,  $bd \rightarrow e$ ,  $cd \rightarrow e$

251

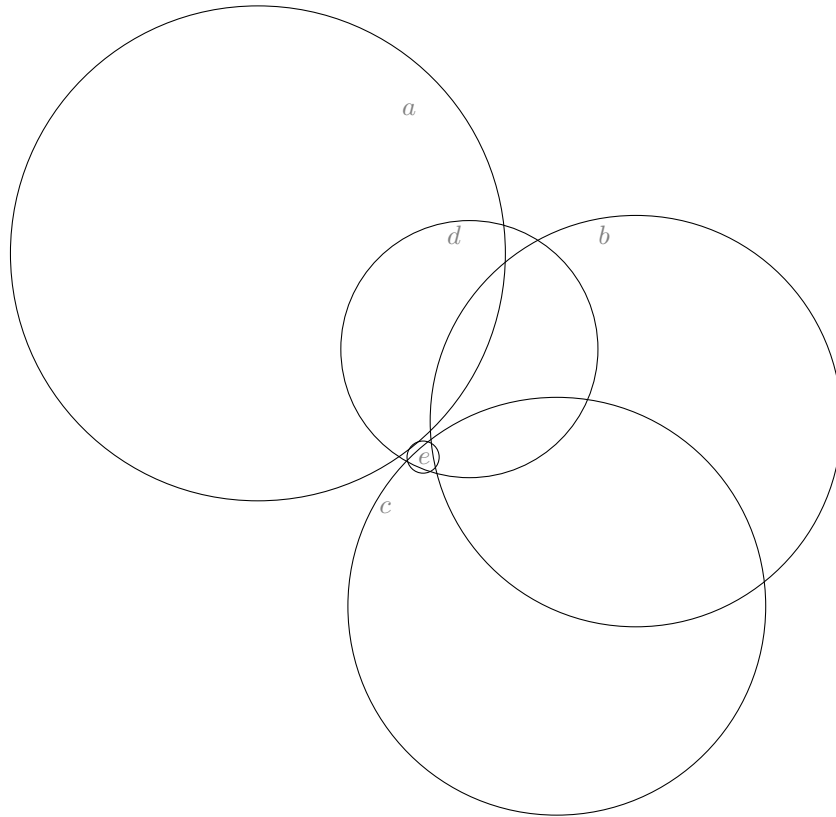

Figure 251:  $cd \rightarrow e, bd \rightarrow e, ad \rightarrow e, bc \rightarrow e, ac \rightarrow de, ab \rightarrow de$

252

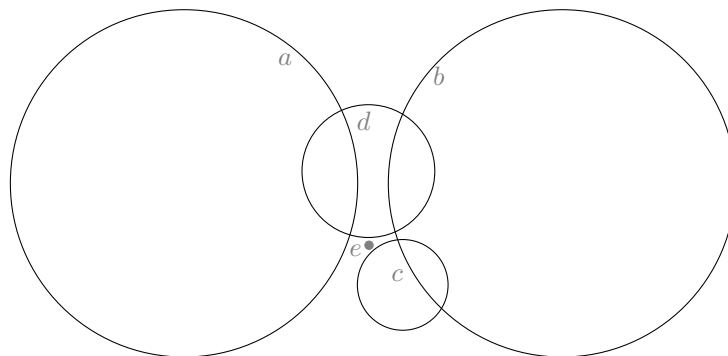

Figure 252:  $cd \rightarrow e, bd \rightarrow e, ad \rightarrow e, bc \rightarrow e, ac \rightarrow e, ab \rightarrow cde$

APPENDIX B.2: REPRESENTATION OF SIZE 5 GEOMETRIES

253

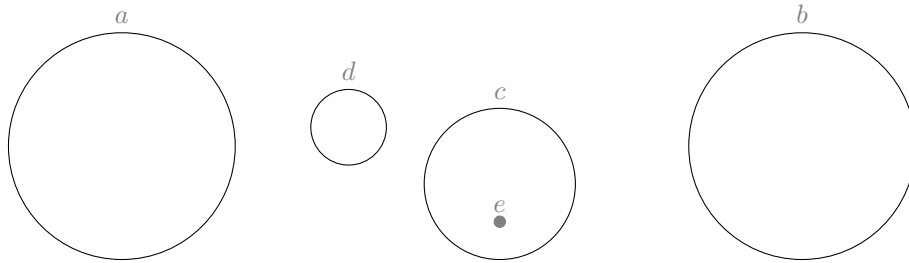

Figure 253:  $ab \rightarrow cde$ ,  $ac \rightarrow de$ ,  $c \rightarrow e$

254

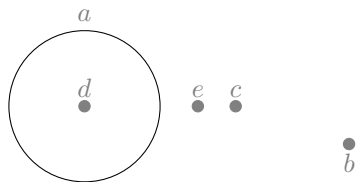

Figure 254:  $ab \rightarrow cde$ ,  $ac \rightarrow de$ ,  $a \rightarrow d$ ,  $cd \rightarrow e$

255

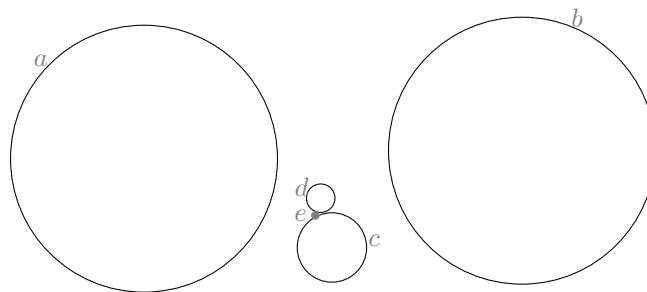

Figure 255:  $ab \rightarrow cde$ ,  $ac \rightarrow de$ ,  $bc \rightarrow e$ ,  $ad \rightarrow e$ ,  $cd \rightarrow e$

256

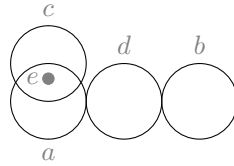

Figure 256:  $ab \rightarrow de, a \rightarrow e, c \rightarrow e$

257

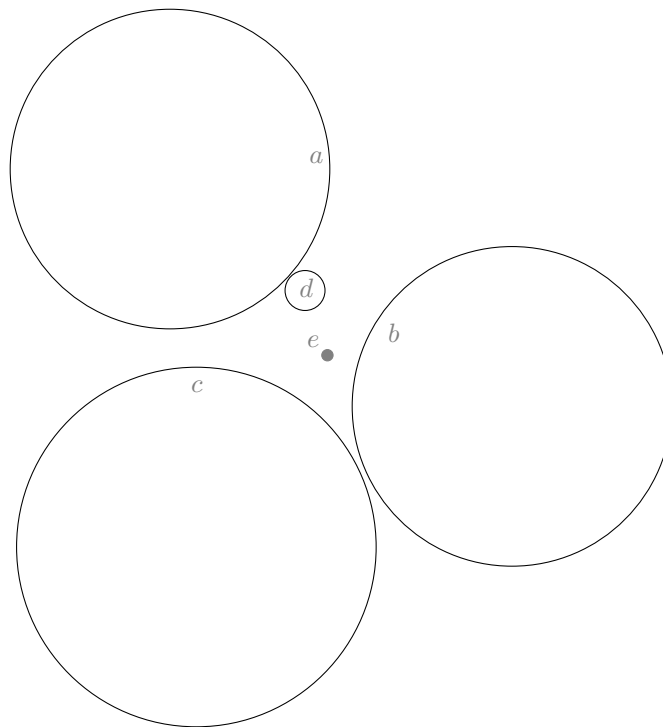

Figure 257:  $ae \rightarrow d, cd \rightarrow e, bd \rightarrow e, bc \rightarrow e, ac \rightarrow de, ab \rightarrow de$



258

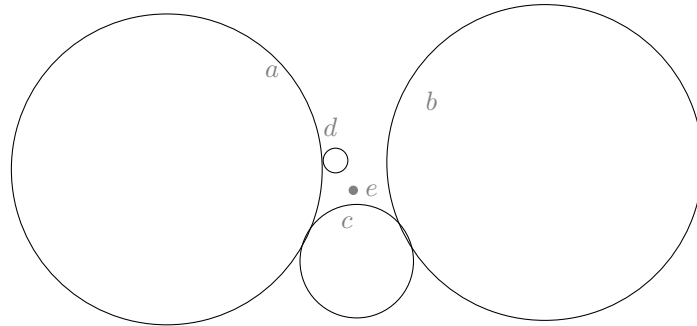

Figure 258:  $cd \rightarrow e, bd \rightarrow e, bc \rightarrow e, ac \rightarrow de, ab \rightarrow cde$

259

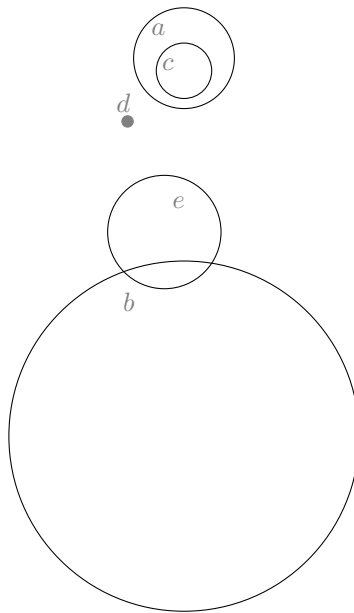

Figure 259:  $ae \rightarrow cd, bc \rightarrow e, ab \rightarrow cde, a \rightarrow c$

260

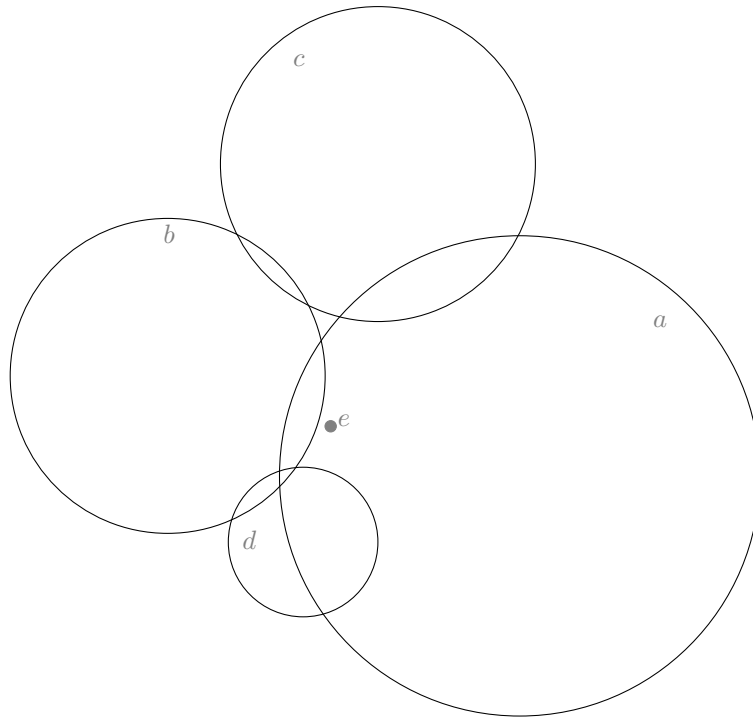

Figure 260:  $cd \rightarrow e, bd \rightarrow e, bc \rightarrow e, ab \rightarrow de, a \rightarrow e$

261

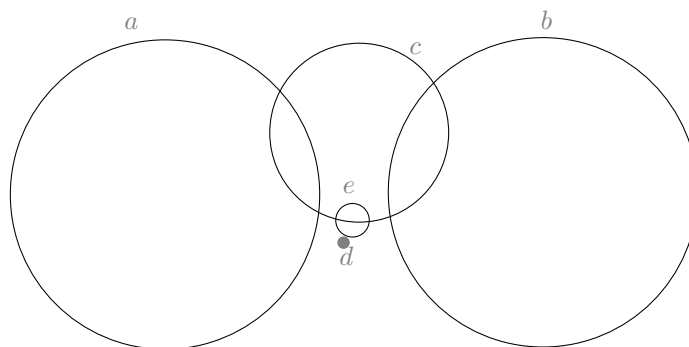

Figure 261:  $ab \rightarrow cde, ac \rightarrow de, bc \rightarrow e, cd \rightarrow e, ae \rightarrow d$

APPENDIX B.2: REPRESENTATION OF SIZE 5 GEOMETRIES

262

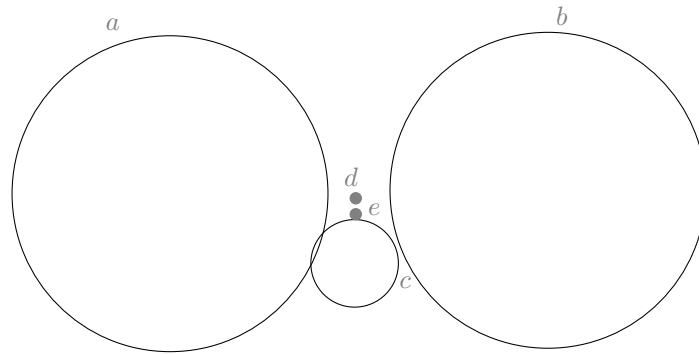

Figure 262:  $ab \rightarrow cde, ac \rightarrow de, bc \rightarrow de, cd \rightarrow e$

263

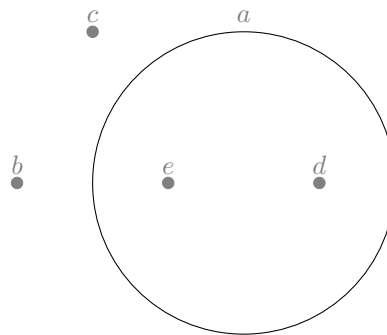

Figure 263:  $a \rightarrow de, bd \rightarrow e$

264

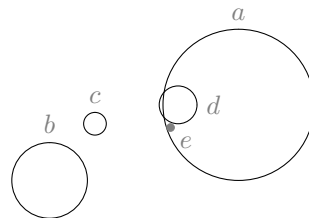

Figure 264:  $a \rightarrow e, bd \rightarrow e, ac \rightarrow de, ab \rightarrow cde$

APPENDIX B.2: REPRESENTATION OF SIZE 5 GEOMETRIES

265

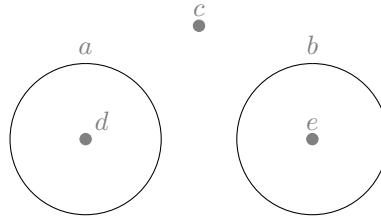

Figure 265:  $a \rightarrow d, b \rightarrow e$

266

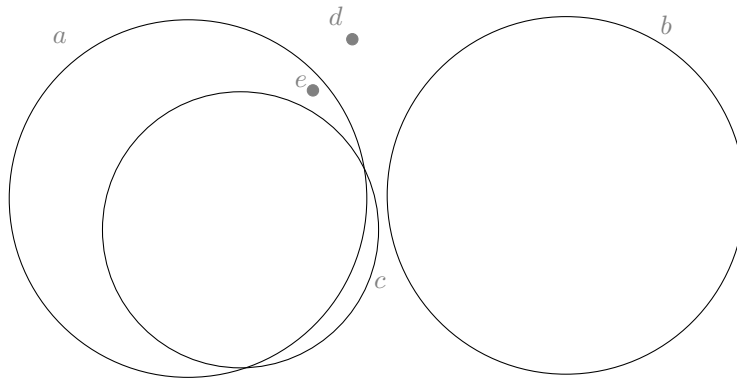

Figure 266:  $ab \rightarrow cde, cd \rightarrow e, bc \rightarrow e, a \rightarrow e$

267

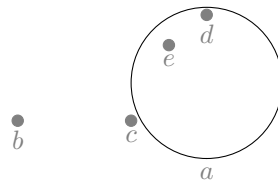

Figure 267:  $a \rightarrow de, bcd \rightarrow e, ab \rightarrow cde$

268

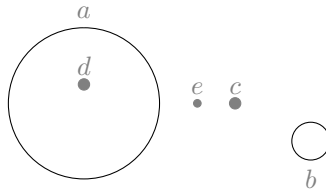

Figure 268:  $ab \rightarrow cde$ ,  $ac \rightarrow de$ ,  $a \rightarrow d$ ,  $bd \rightarrow e$

269

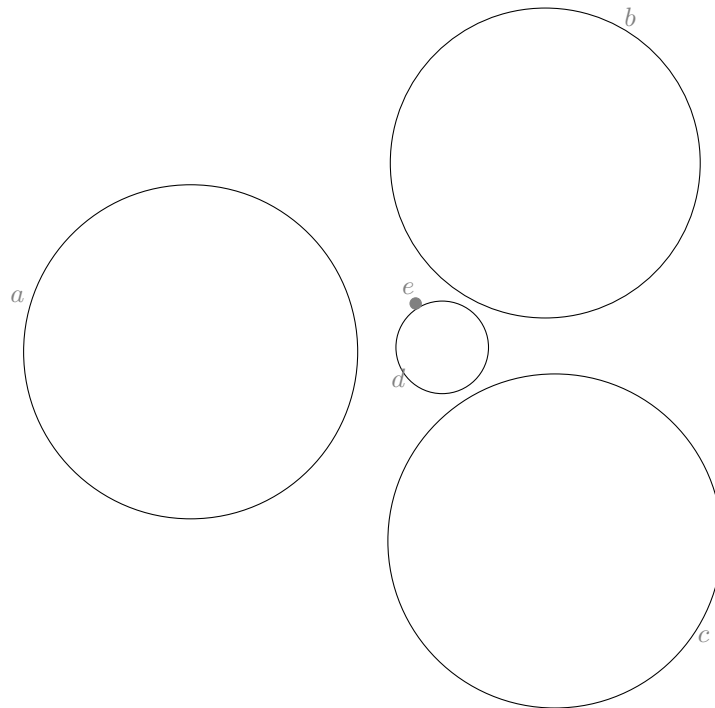

Figure 269:  $bd \rightarrow e$ ,  $ad \rightarrow e$ ,  $bc \rightarrow de$ ,  $ac \rightarrow de$ ,  $ab \rightarrow de$

270

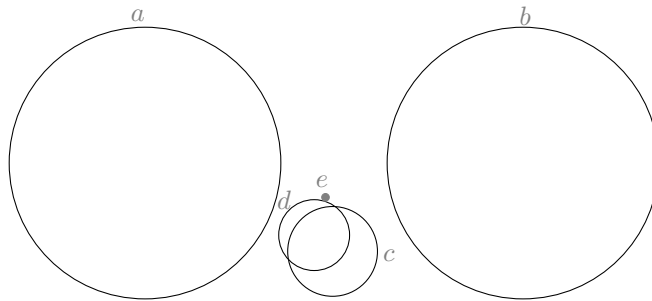

Figure 270:  $bd \rightarrow e, bc \rightarrow e, ad \rightarrow e, ac \rightarrow de, ab \rightarrow cde$

271

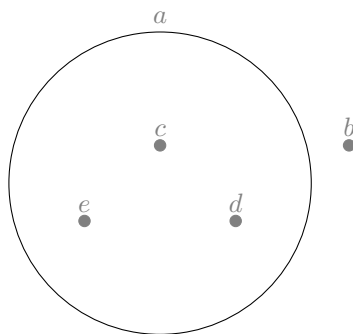

Figure 271:  $a \rightarrow cde$

APPENDIX B.2: REPRESENTATION OF SIZE 5 GEOMETRIES

272

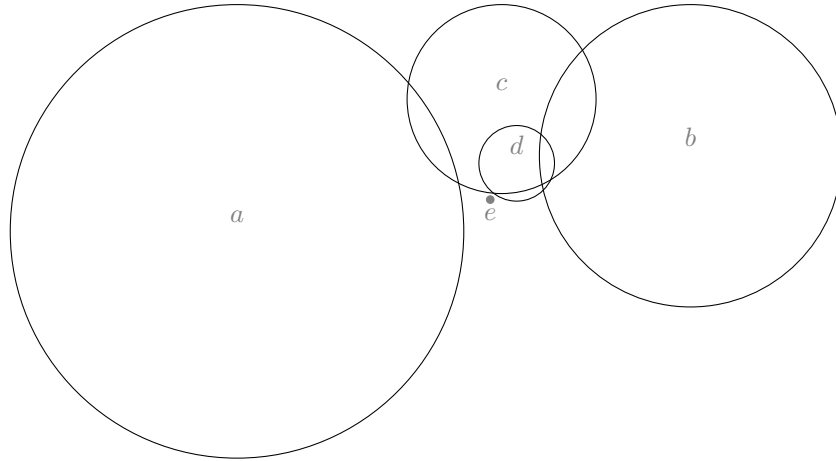

Figure 272:  $ad \rightarrow e$ ,  $bc \rightarrow de$ ,  $ac \rightarrow de$ ,  $ab \rightarrow cde$

273

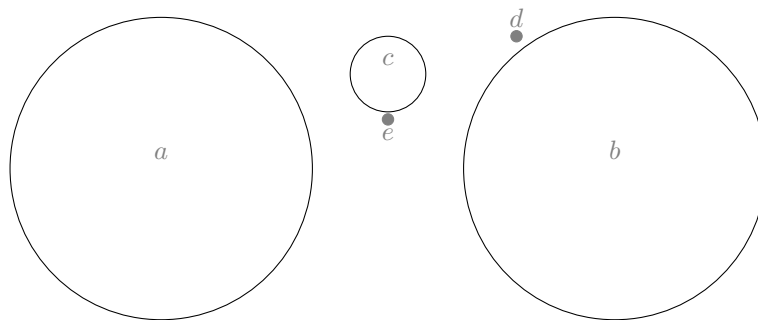

Figure 273:  $ad \rightarrow ce$ ,  $bc \rightarrow de$ ,  $ac \rightarrow e$ ,  $ab \rightarrow cde$

274

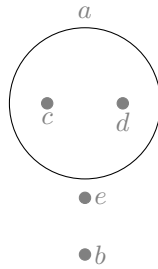

Figure 274:  $bcd \rightarrow e$ ,  $ab \rightarrow cde$ ,  $a \rightarrow cd$

275

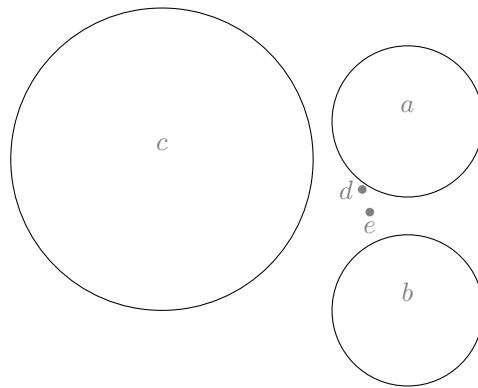

Figure 275:  $ae \rightarrow d$ ,  $bd \rightarrow e$ ,  $bc \rightarrow de$ ,  $ac \rightarrow de$ ,  $ab \rightarrow de$

276

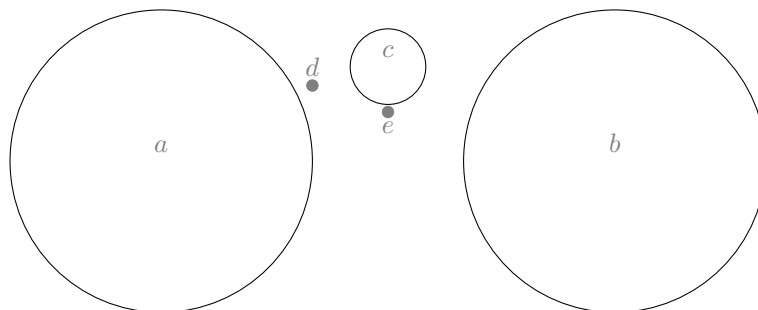

Figure 276:  $ae \rightarrow d$ ,  $bd \rightarrow e$ ,  $bc \rightarrow e$ ,  $ac \rightarrow de$ ,  $ab \rightarrow cde$



277

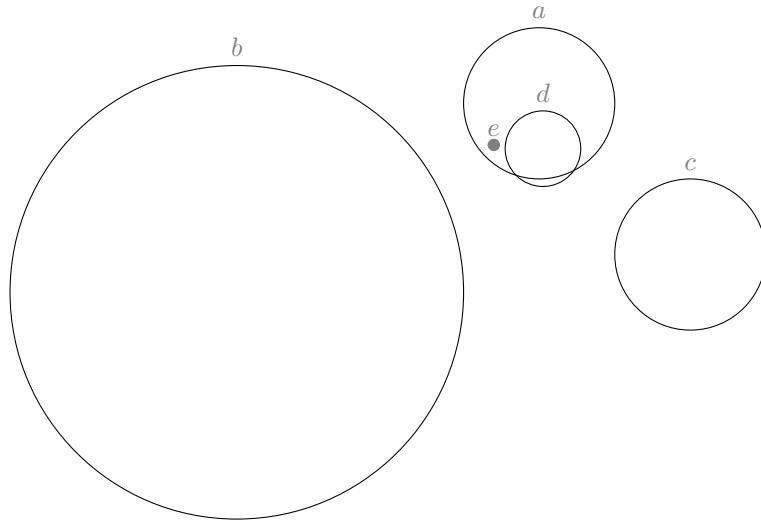

Figure 277:  $bd \rightarrow e$ ,  $bc \rightarrow e$ ,  $ac \rightarrow de$ ,  $ab \rightarrow de$ ,  $a \rightarrow e$

278

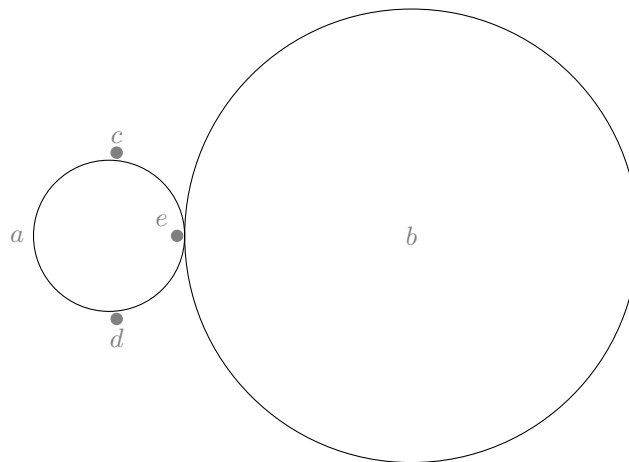

Figure 278:  $bd \rightarrow e$ ,  $bc \rightarrow e$ ,  $ab \rightarrow cde$ ,  $a \rightarrow e$

279

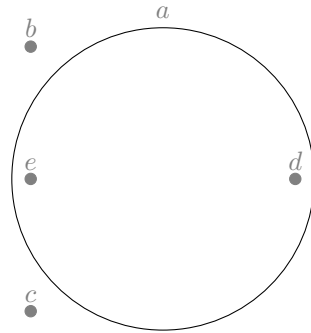

Figure 279:  $bc \rightarrow e, a \rightarrow de$

280

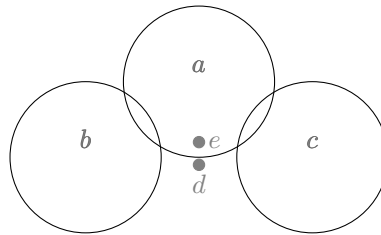

Figure 280:  $bc \rightarrow de, ac \rightarrow de, ab \rightarrow de, a \rightarrow e$

281

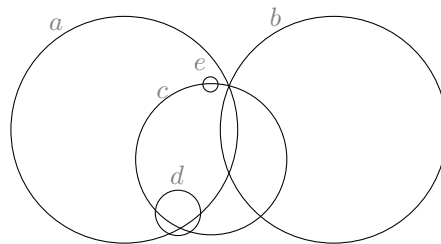

Figure 281:  $ab \rightarrow cde, ac \rightarrow de, bc \rightarrow e, a \rightarrow e$

282

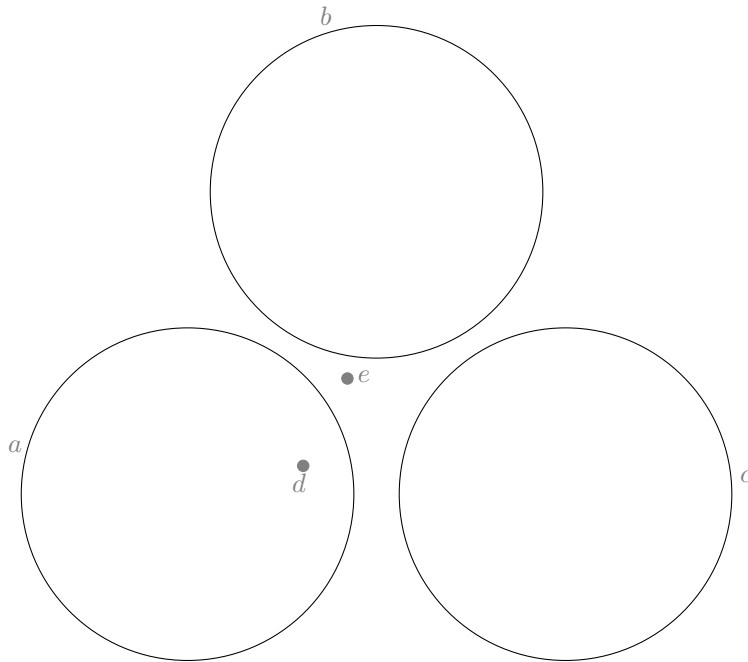

Figure 282:  $bd \rightarrow e, bc \rightarrow e, ac \rightarrow de, ab \rightarrow de, a \rightarrow d$

283

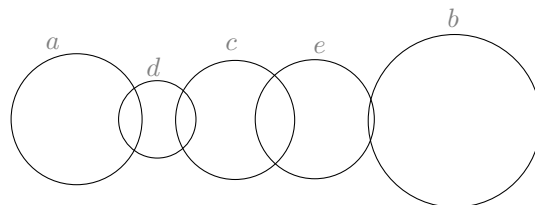

Figure 283:  $ae \rightarrow cd, bd \rightarrow e, bc \rightarrow e, ac \rightarrow d, ab \rightarrow cde$

APPENDIX B.2: REPRESENTATION OF SIZE 5 GEOMETRIES

284

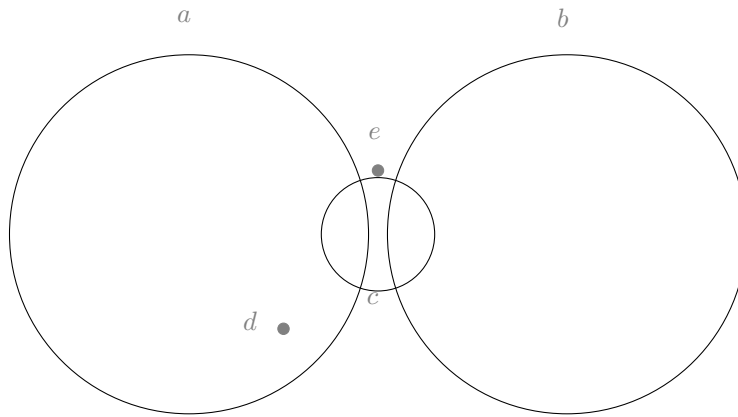

Figure 284:  $a \rightarrow d, ac \rightarrow de, ab \rightarrow cde, bc \rightarrow e$

285

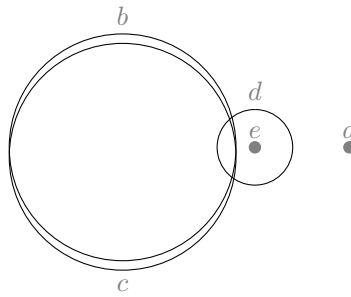

Figure 285:  $d \rightarrow e, ab \rightarrow de, ac \rightarrow de$

286

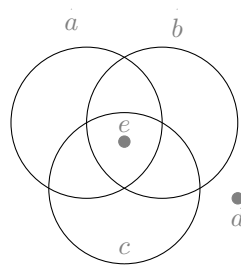

Figure 286:  $a \rightarrow e, b \rightarrow e, c \rightarrow e$

287

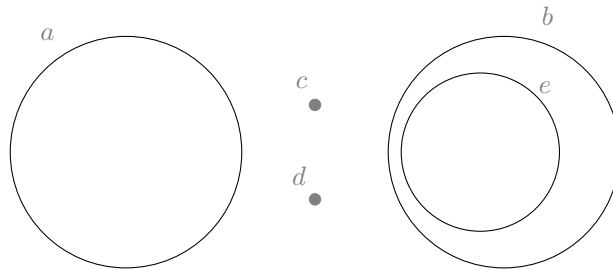

Figure 287:  $b \rightarrow e, ab \rightarrow cde, ae \rightarrow cd$

288

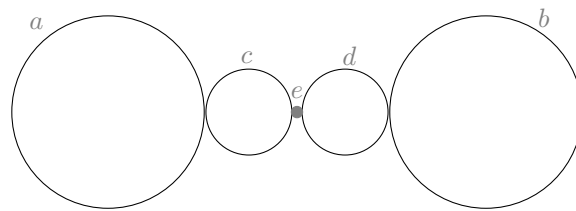

Figure 288:  $cd \rightarrow e, ad \rightarrow ce, bc \rightarrow de, ab \rightarrow cde$

289

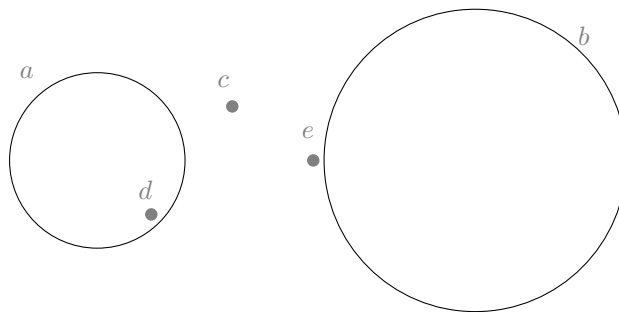

Figure 289:  $bd \rightarrow e, bc \rightarrow e, ab \rightarrow cde, a \rightarrow d$

APPENDIX B.2: REPRESENTATION OF SIZE 5 GEOMETRIES

290

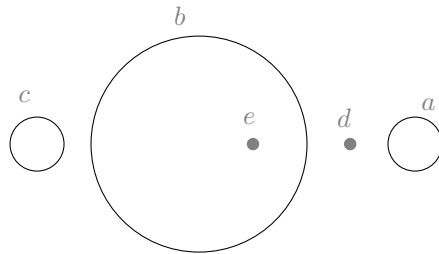

Figure 290:  $ae \rightarrow d, cd \rightarrow e, ac \rightarrow de, ab \rightarrow de, b \rightarrow e$

291

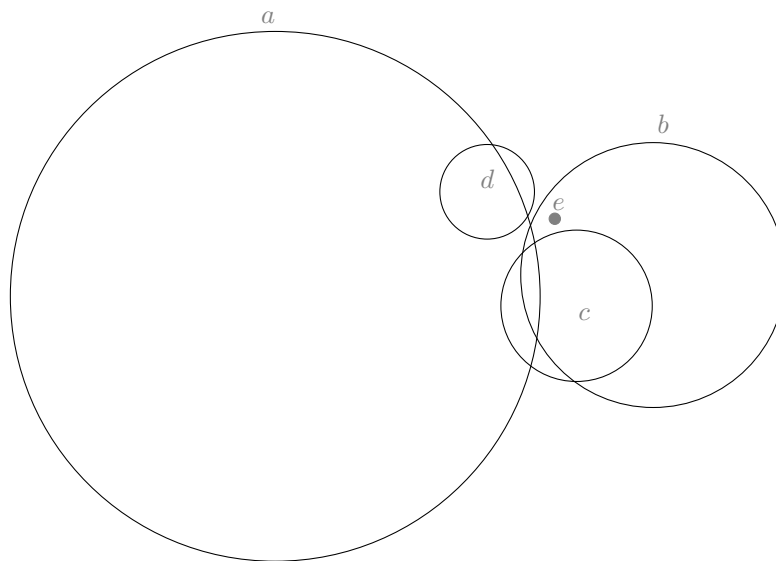

Figure 291:  $cd \rightarrow e, ac \rightarrow de, ab \rightarrow cde, b \rightarrow e$

292

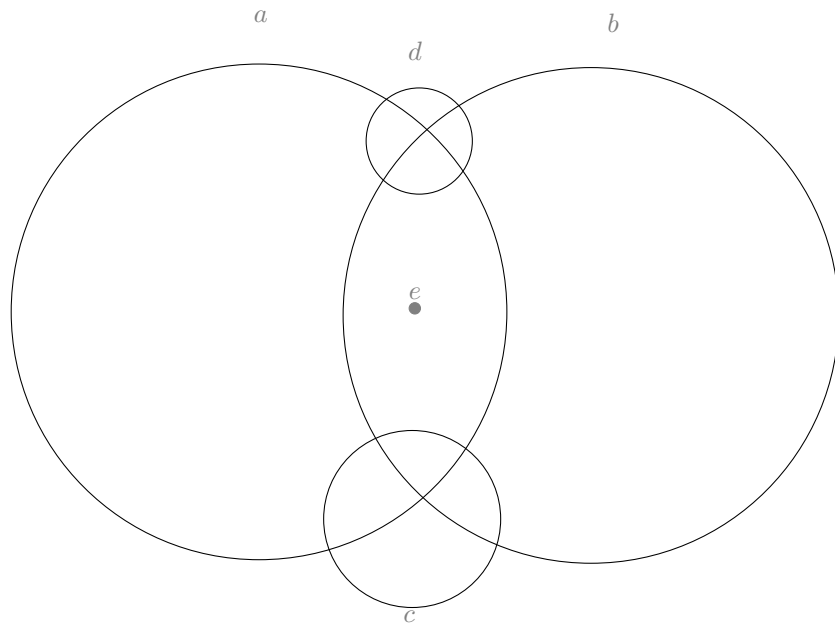

Figure 292:  $cd \rightarrow e, a \rightarrow e, ab \rightarrow de, b \rightarrow e$

293

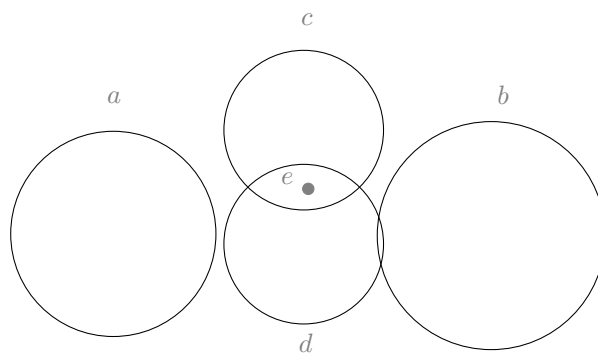

Figure 293:  $d \rightarrow e, c \rightarrow e, ab \rightarrow de$

294

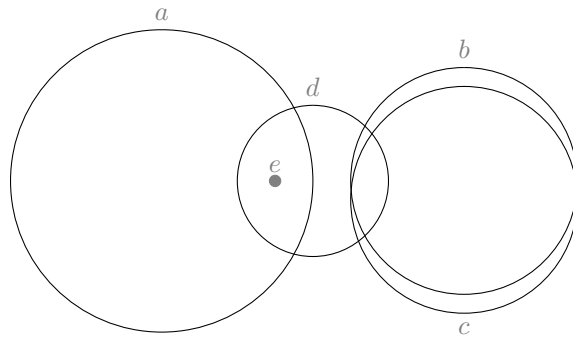

Figure 294:  $a \rightarrow e, d \rightarrow e, ab \rightarrow de, ac \rightarrow de$

295

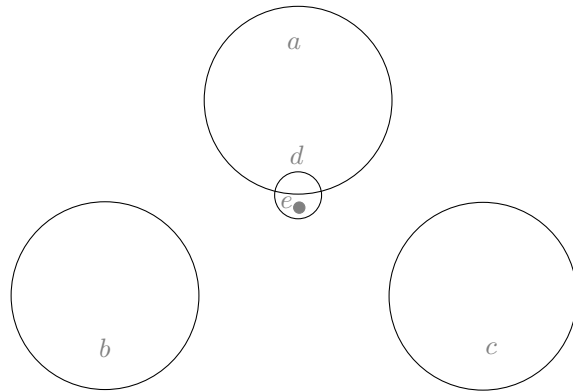

Figure 295:  $d \rightarrow e, bc \rightarrow e, ac \rightarrow de, ab \rightarrow de$



APPENDIX B.2: REPRESENTATION OF SIZE 5 GEOMETRIES

296

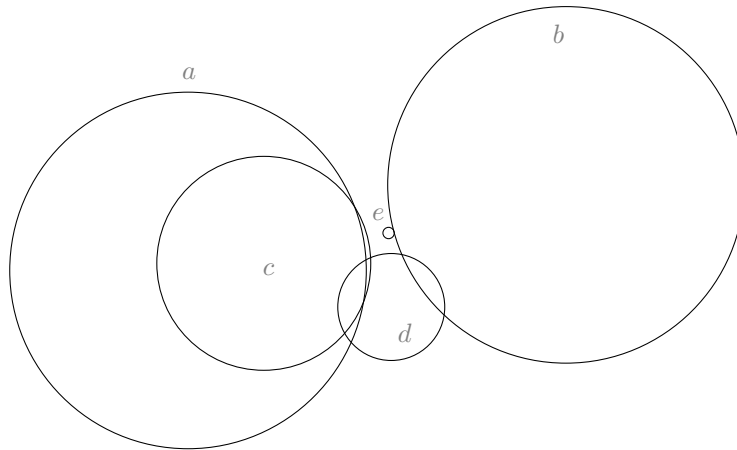

Figure 296:  $bd \rightarrow e, ae \rightarrow c, ab \rightarrow cde, ad \rightarrow ce, bc \rightarrow de,$

297

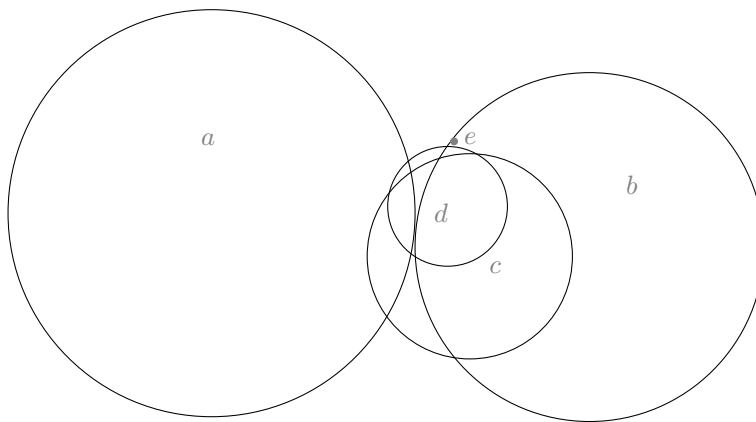

Figure 297:  $ad \rightarrow e, ac \rightarrow de, ab \rightarrow cde, b \rightarrow e$

298

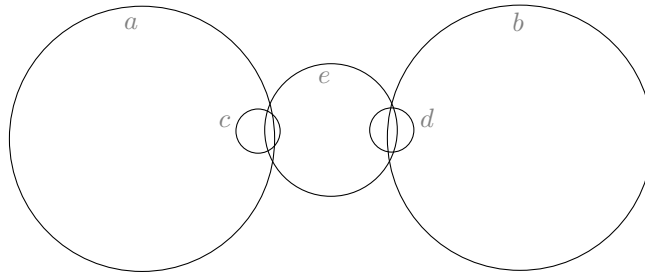

Figure 298:  $ae \rightarrow c, be \rightarrow d, ad \rightarrow ce, bc \rightarrow de, ab \rightarrow cde$

299

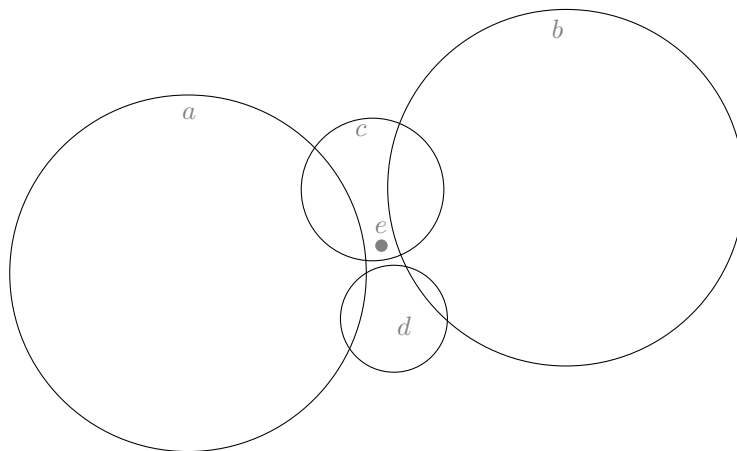

Figure 299:  $bd \rightarrow e, ad \rightarrow e, ab \rightarrow cde, c \rightarrow e$

APPENDIX B.2: REPRESENTATION OF SIZE 5 GEOMETRIES

300

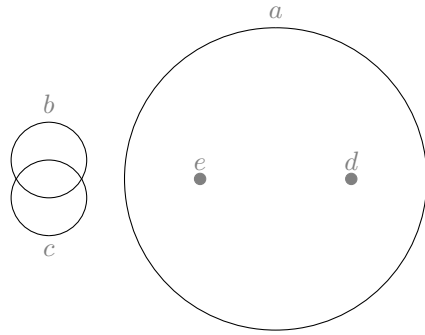

Figure 300:  $a \rightarrow de$ ,  $bd \rightarrow e$ ,  $cd \rightarrow e$

301

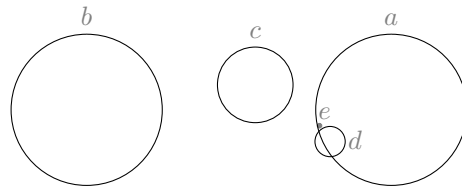

Figure 301:  $cd \rightarrow e$ ,  $bd \rightarrow e$ ,  $ac \rightarrow de$ ,  $ab \rightarrow cde$ ,  $a \rightarrow e$

302

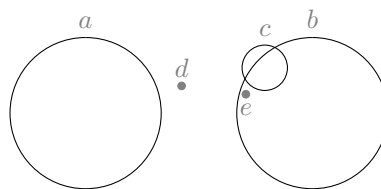

Figure 302:  $ae \rightarrow d$ ,  $ac \rightarrow de$ ,  $ab \rightarrow cde$ ,  $b \rightarrow e$

APPENDIX B.2: REPRESENTATION OF SIZE 5 GEOMETRIES

303

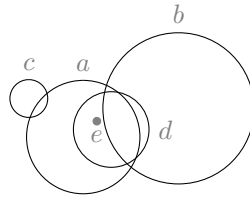

Figure 303:  $a \rightarrow e, bc \rightarrow e, ab \rightarrow de, d \rightarrow e$

304

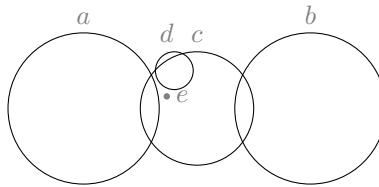

Figure 304:  $ad \rightarrow e, ac \rightarrow de, c \rightarrow e, ab \rightarrow cde$

305

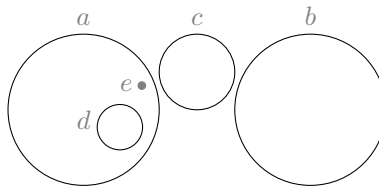

Figure 305:  $cd \rightarrow e, ab \rightarrow cde, a \rightarrow de$

306

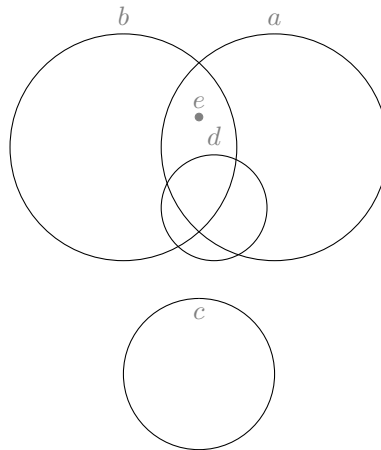

Figure 306:  $ac \rightarrow de, ab \rightarrow de, b \rightarrow e, a \rightarrow e$

307

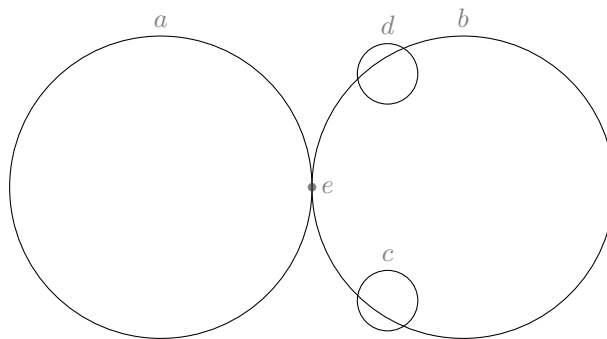

Figure 307:  $ab \rightarrow cde, b \rightarrow e, a \rightarrow e$

308

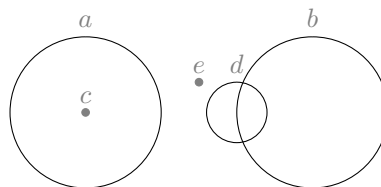

Figure 308:  $ad \rightarrow ce, bc \rightarrow de, ab \rightarrow cde, a \rightarrow c$

APPENDIX B.2: REPRESENTATION OF SIZE 5 GEOMETRIES

309

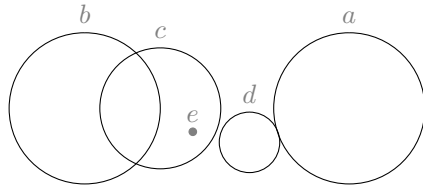

Figure 309:  $bd \rightarrow e, ac \rightarrow de, c \rightarrow e, ab \rightarrow cde$

310

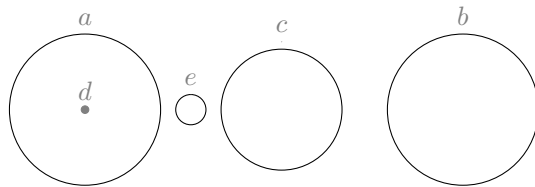

Figure 310:  $cd \rightarrow e, bd \rightarrow e, ac \rightarrow de, ab \rightarrow cde, a \rightarrow d$

311

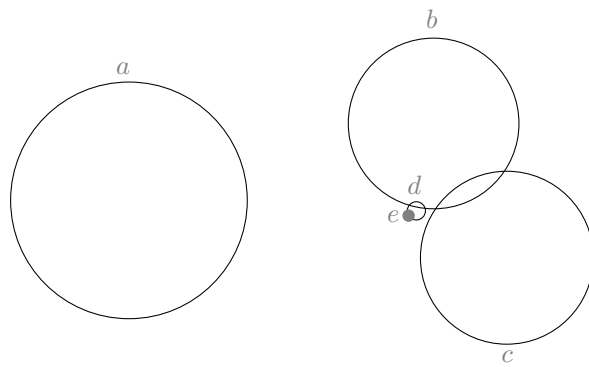

Figure 311:  $cd \rightarrow e, bd \rightarrow e, ad \rightarrow e, bc \rightarrow de, ac \rightarrow de, ab \rightarrow de$

APPENDIX B.2: REPRESENTATION OF SIZE 5 GEOMETRIES

312

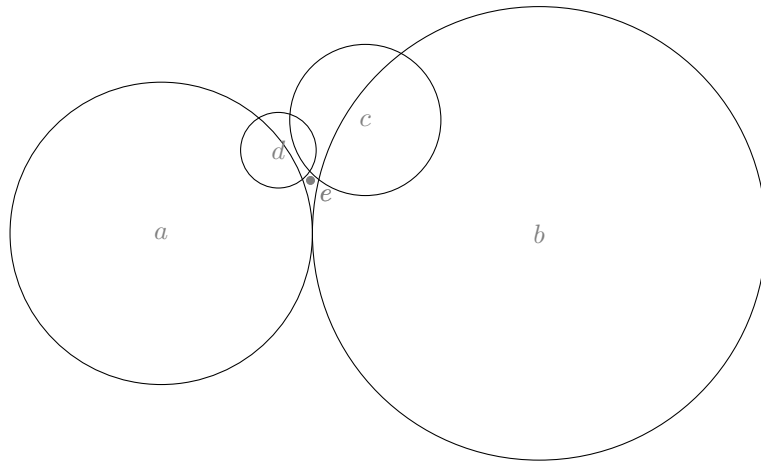

Figure 312:  $cd \rightarrow e, bd \rightarrow e, ad \rightarrow e, bc \rightarrow e, ac \rightarrow de, ab \rightarrow cde$

313

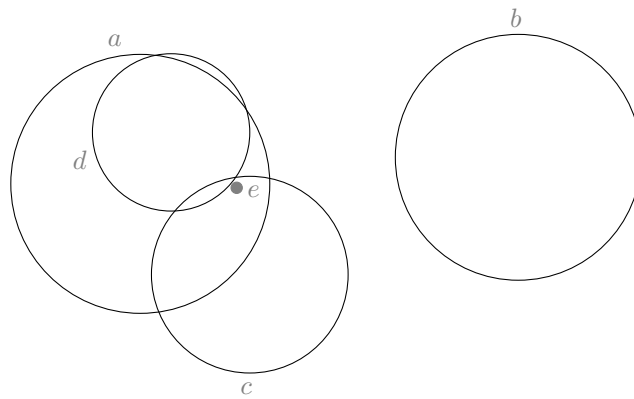

Figure 313:  $bd \rightarrow e, c \rightarrow e, ab \rightarrow de, a \rightarrow e$

APPENDIX B.2: REPRESENTATION OF SIZE 5 GEOMETRIES

314

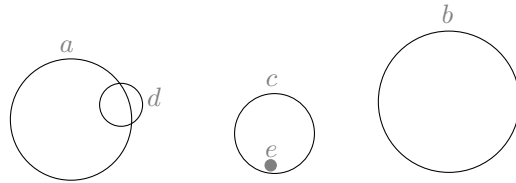

Figure 314:  $ae \rightarrow d, ac \rightarrow de, c \rightarrow e, ab \rightarrow cde$

315

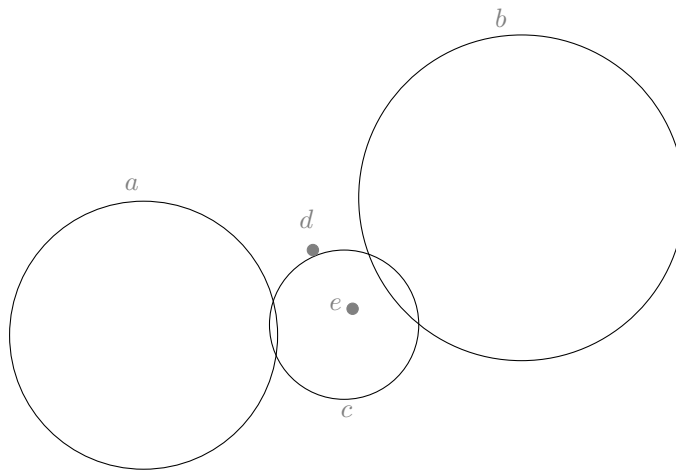

Figure 315:  $bc \rightarrow de, ac \rightarrow de, c \rightarrow e, ab \rightarrow cde$



316

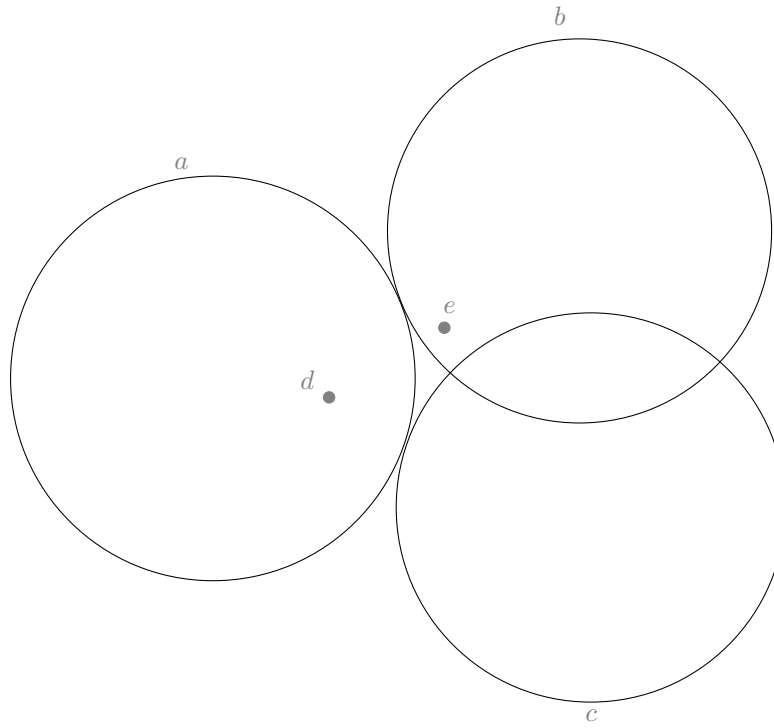

Figure 316:  $ac \rightarrow de, ab \rightarrow de, b \rightarrow e, a \rightarrow d$

317

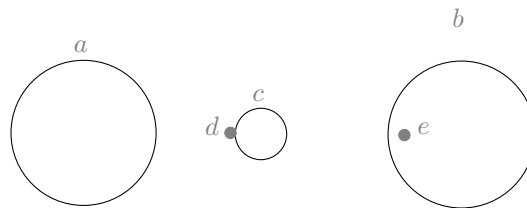

Figure 317:  $ae \rightarrow cd, ac \rightarrow d, ab \rightarrow cde, b \rightarrow e$

318

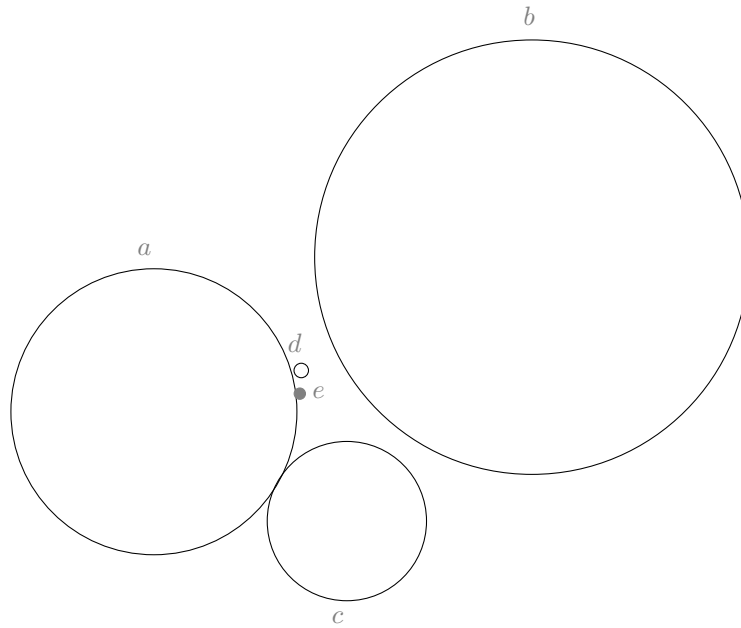

Figure 318:  $cd \rightarrow e, ad \rightarrow e, bc \rightarrow de, ac \rightarrow de, ab \rightarrow cde$

319

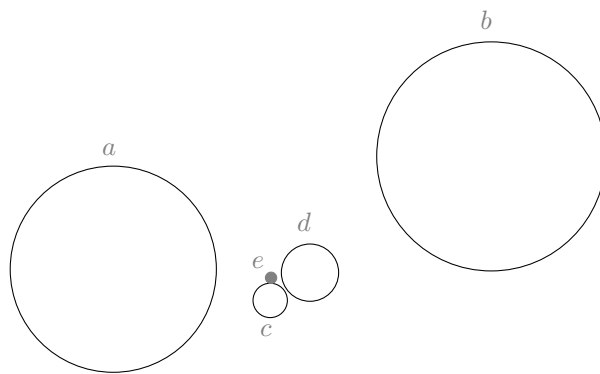

Figure 319:  $cd \rightarrow e, ad \rightarrow ce, bc \rightarrow de, ac \rightarrow e, ab \rightarrow cde$

320

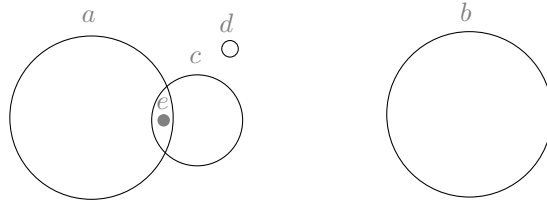

Figure 320:  $c \rightarrow e, ab \rightarrow cde, a \rightarrow e$

321

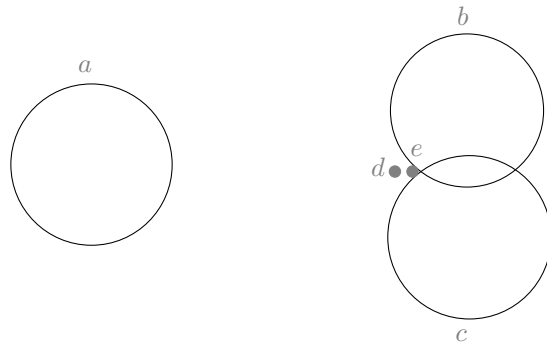

Figure 321:  $ae \rightarrow d, cd \rightarrow e, bd \rightarrow e, bc \rightarrow de, ac \rightarrow de, ab \rightarrow de$

322

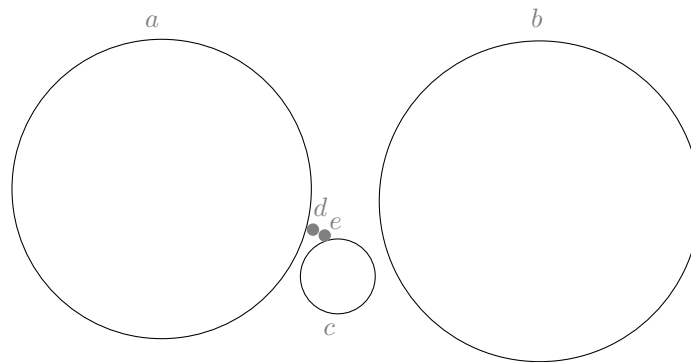

Figure 322:  $ae \rightarrow d, cd \rightarrow e, bd \rightarrow e, bc \rightarrow e, ac \rightarrow de, ab \rightarrow cde$

323

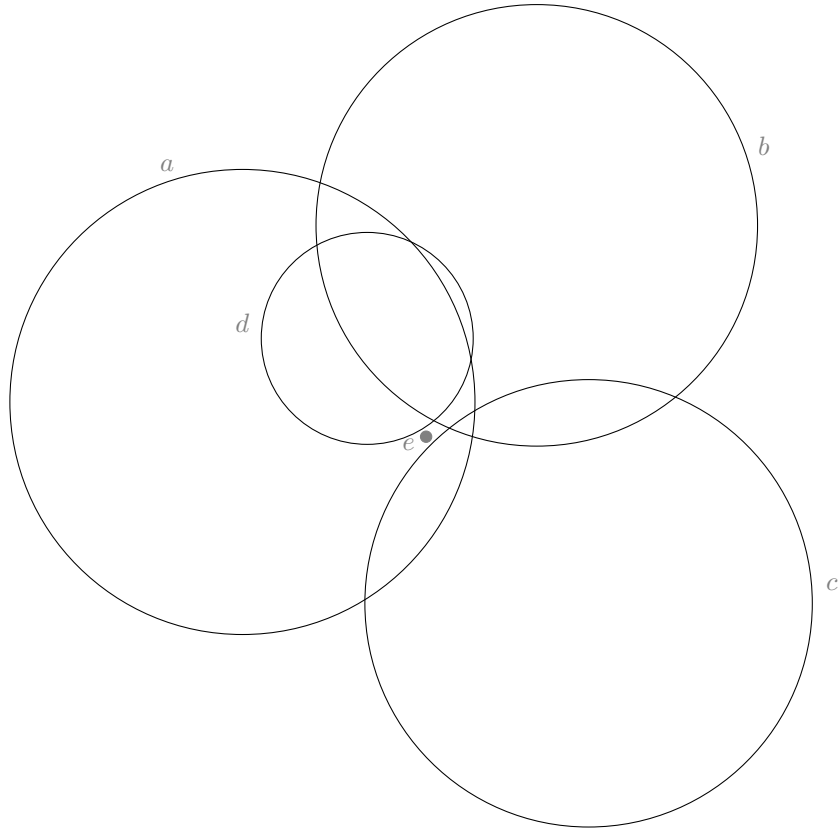

Figure 323:  $cd \rightarrow e, bd \rightarrow e, bc \rightarrow e, ac \rightarrow de, ab \rightarrow de, a \rightarrow e$

APPENDIX B.2: REPRESENTATION OF SIZE 5 GEOMETRIES

324

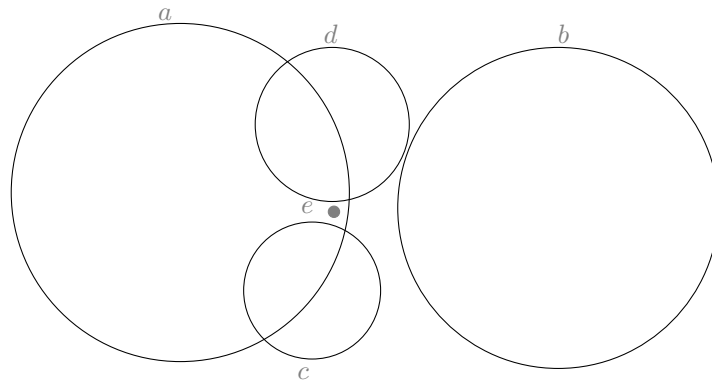

Figure 324:  $cd \rightarrow e, bd \rightarrow e, bc \rightarrow e, ab \rightarrow cde, a \rightarrow e$

325

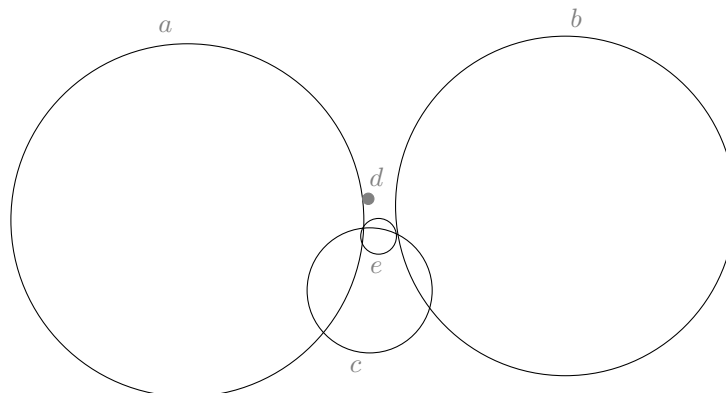

Figure 325:  $ae \rightarrow d, cd \rightarrow e, bc \rightarrow de, ac \rightarrow de, ab \rightarrow cde$

APPENDIX B.2: REPRESENTATION OF SIZE 5 GEOMETRIES

326

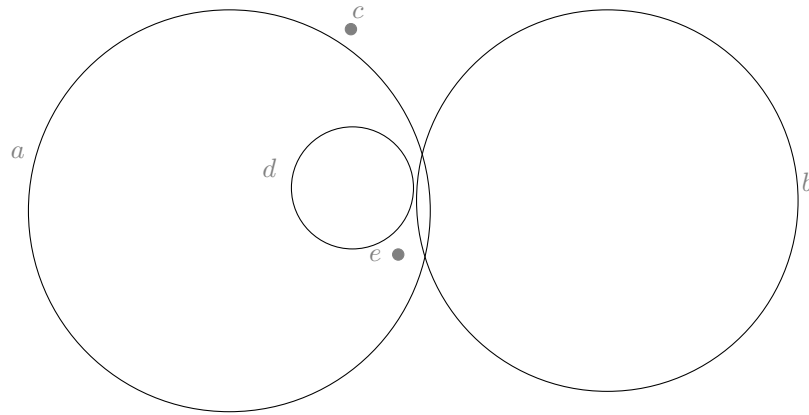

Figure 326:  $bd \rightarrow e, ab \rightarrow cde, a \rightarrow de$

327

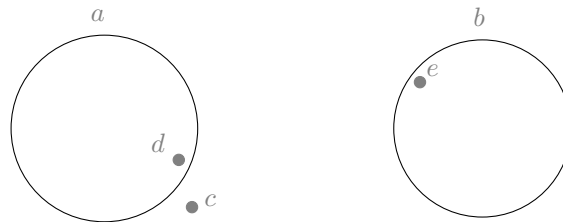

Figure 327:  $ab \rightarrow cde, b \rightarrow e, a \rightarrow d$

328

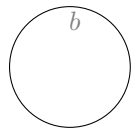
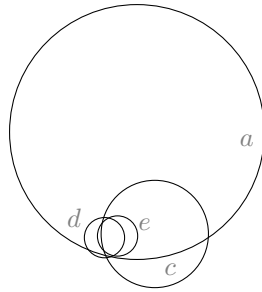

Figure 328:  $cd \rightarrow e, bc \rightarrow e, ac \rightarrow de, ab \rightarrow cde, a \rightarrow e$

329

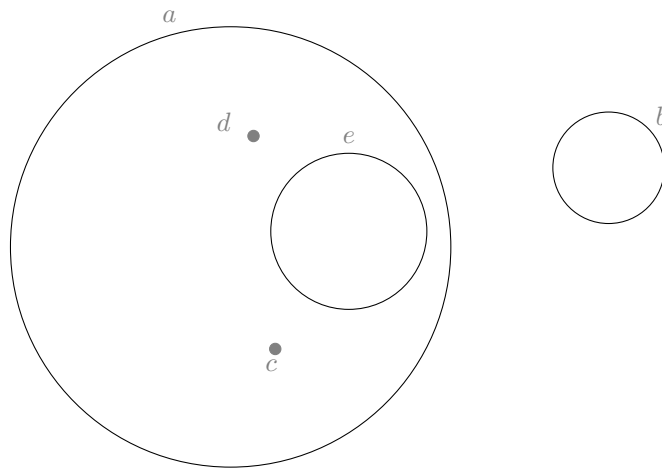

Figure 329:  $bcd \rightarrow e, a \rightarrow cde$

APPENDIX B.2: REPRESENTATION OF SIZE 5 GEOMETRIES

330

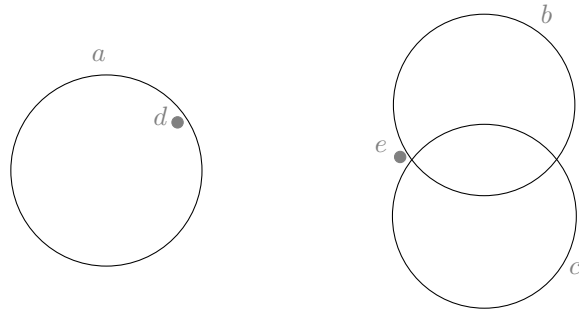

Figure 330:  $cd \rightarrow e, bd \rightarrow e, bc \rightarrow e, ac \rightarrow de, ab \rightarrow de, a \rightarrow d$

331

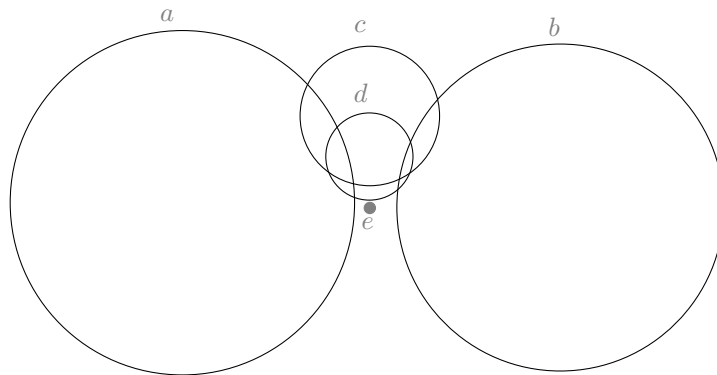

Figure 331:  $bd \rightarrow e, ad \rightarrow e, bc \rightarrow de, ac \rightarrow de, ab \rightarrow cde$



332

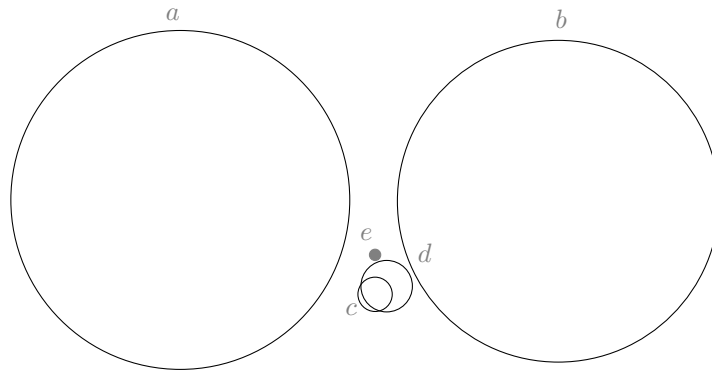

Figure 332:  $bd \rightarrow e, ad \rightarrow ce, bc \rightarrow de, ac \rightarrow e, ab \rightarrow cde$

333

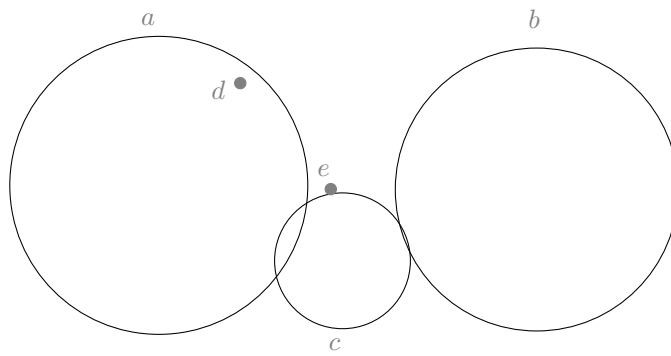

Figure 333:  $cd \rightarrow e, bc \rightarrow e, ac \rightarrow de, ab \rightarrow cde, a \rightarrow d$

334

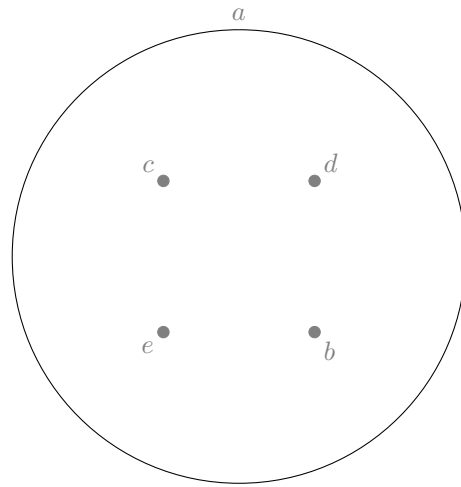

Figure 334:  $a \rightarrow bcde$

335

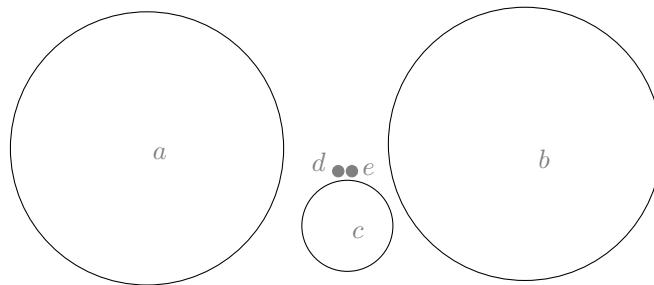

Figure 335:  $ae \rightarrow d, bd \rightarrow e, bc \rightarrow de, ac \rightarrow de, ab \rightarrow cde$

336

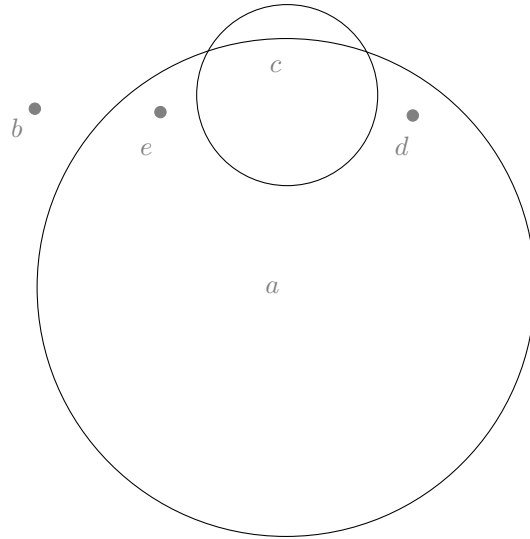

Figure 336:  $bd \rightarrow e, bc \rightarrow e, a \rightarrow de$

337

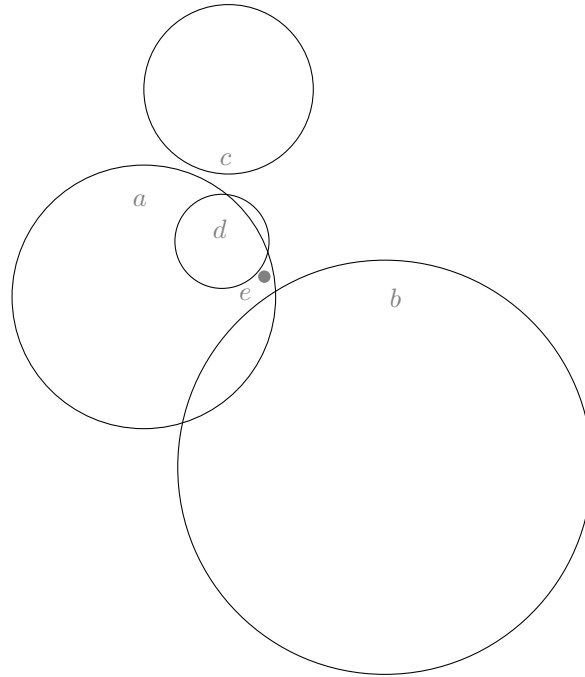

Figure 337:  $bd \rightarrow e, bc \rightarrow de, ac \rightarrow de, ab \rightarrow de, a \rightarrow e$

338

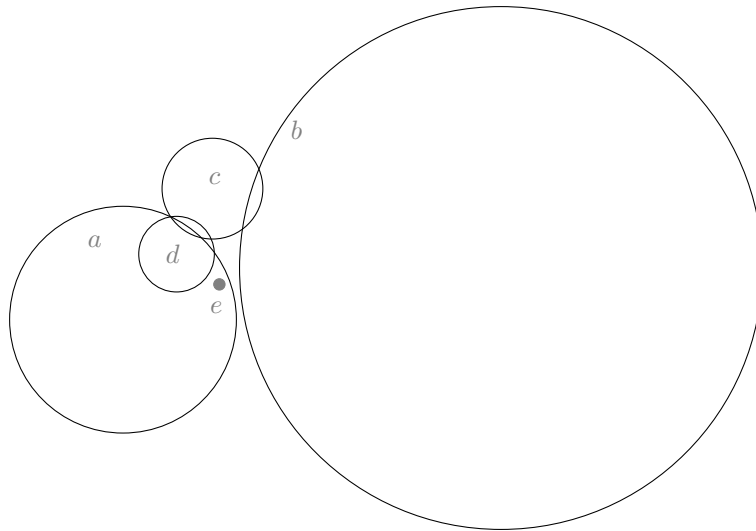

Figure 338:  $bd \rightarrow e, bc \rightarrow e, ac \rightarrow de, ab \rightarrow cde, a \rightarrow e$

339

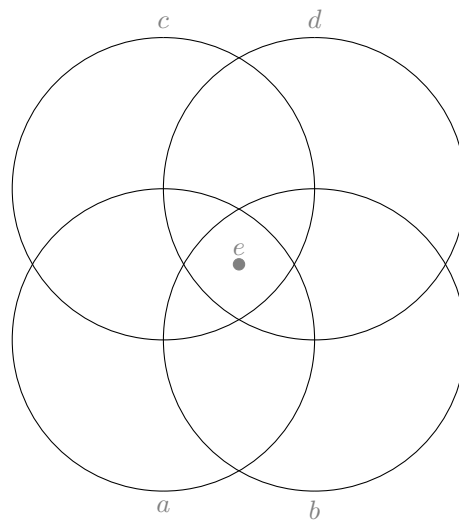

Figure 339:  $a \rightarrow e, b \rightarrow e, c \rightarrow e, d \rightarrow e$

APPENDIX B.2: REPRESENTATION OF SIZE 5 GEOMETRIES

340

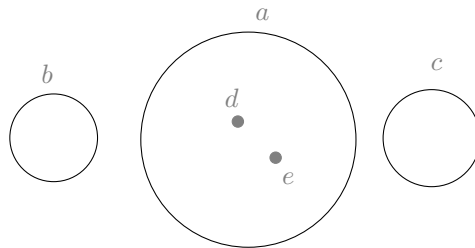

Figure 340:  $a \rightarrow de, bc \rightarrow de$

341

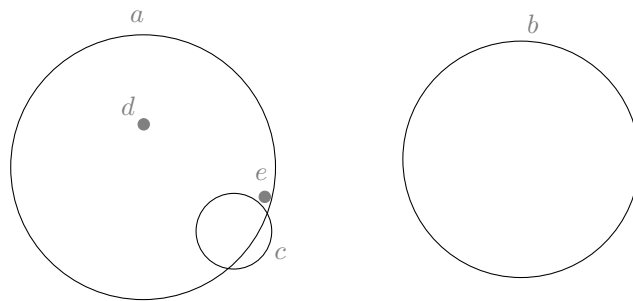

Figure 341:  $a \rightarrow de, ab \rightarrow cde, bc \rightarrow e$

342

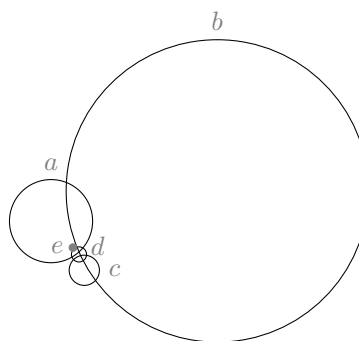

Figure 342:  $a \rightarrow e, ac \rightarrow de, bc \rightarrow de, ab \rightarrow cde$

343

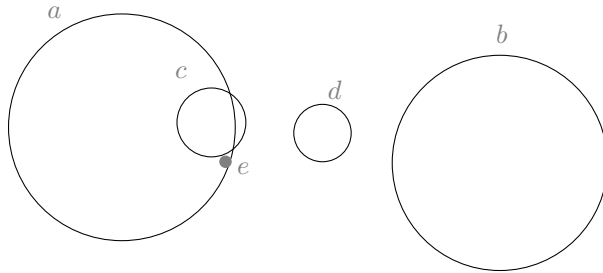

Figure 343:  $a \rightarrow e, ab \rightarrow cde, ad \rightarrow ce, bc \rightarrow de$

344

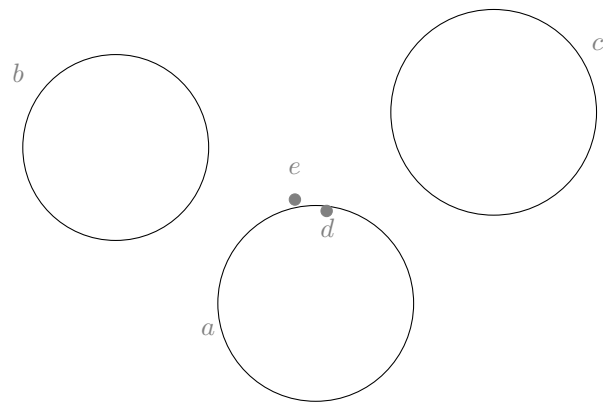

Figure 344:  $a \rightarrow d, ab \rightarrow de, ac \rightarrow de, bc \rightarrow de, bd \rightarrow e$

345

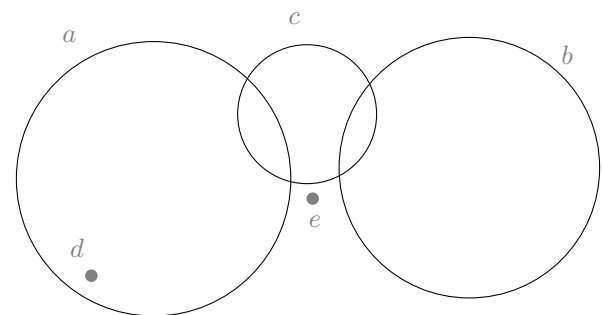

Figure 345:  $a \rightarrow d, ab \rightarrow cde, ac \rightarrow de, bc \rightarrow e, bd \rightarrow e$

APPENDIX B.2: REPRESENTATION OF SIZE 5 GEOMETRIES

346

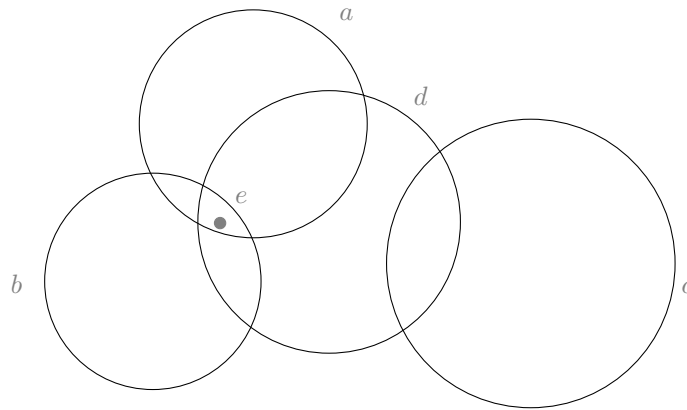

Figure 346:  $a \rightarrow e, b \rightarrow e, d \rightarrow e, abc \rightarrow de$

347

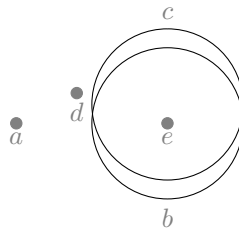

Figure 347:  $b \rightarrow e, c \rightarrow e, ab \rightarrow de, ac \rightarrow de$



348

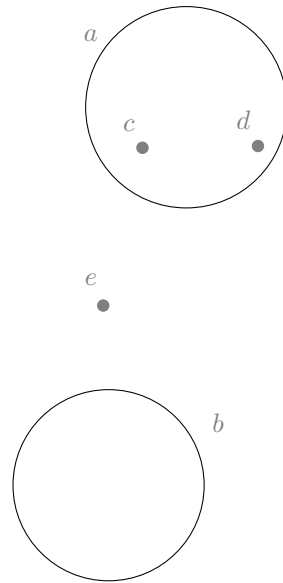

Figure 348:  $a \rightarrow cd, ab \rightarrow cde, bc \rightarrow e$

349

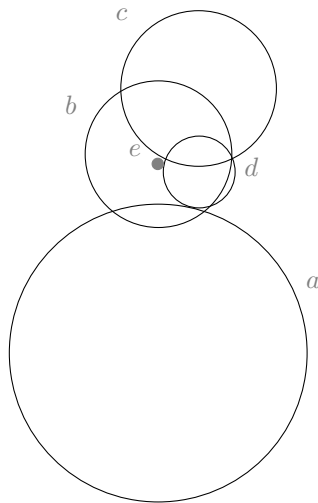

Figure 349:  $b \rightarrow e, ab \rightarrow de, ac \rightarrow de, ad \rightarrow e, cd \rightarrow e$

350

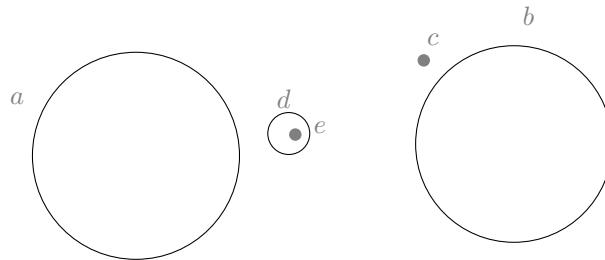

Figure 350:  $d \rightarrow e, ab \rightarrow cde, ac \rightarrow de$

352

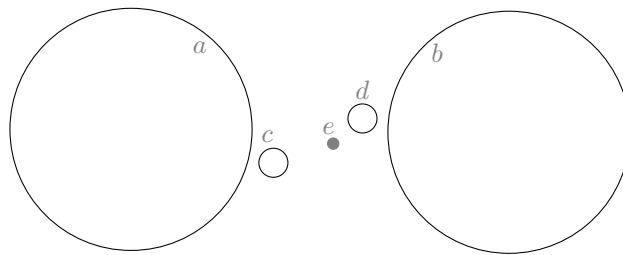

Figure 352:  $ae \rightarrow c, cd \rightarrow e, ad \rightarrow ce, bc \rightarrow de, ab \rightarrow cde$

353

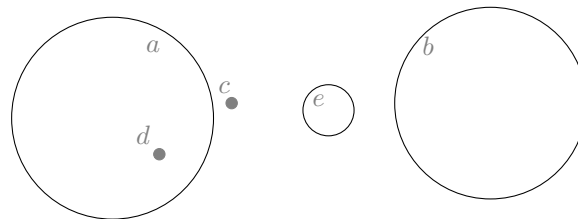

Figure 353:  $ae \rightarrow cd, bd \rightarrow e, bc \rightarrow e, ab \rightarrow cde, a \rightarrow d$

354

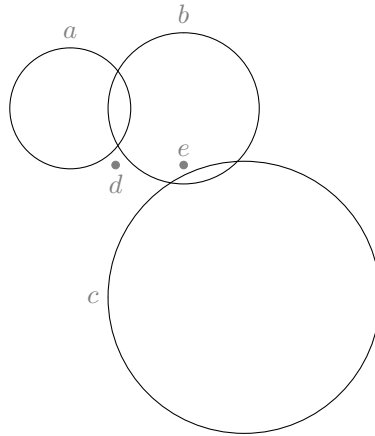

Figure 354:  $b \rightarrow e$ ,  $ae \rightarrow d$ ,  $cd \rightarrow e$ ,  $bc \rightarrow de$ ,  $ac \rightarrow de$ ,  $ab \rightarrow de$

355

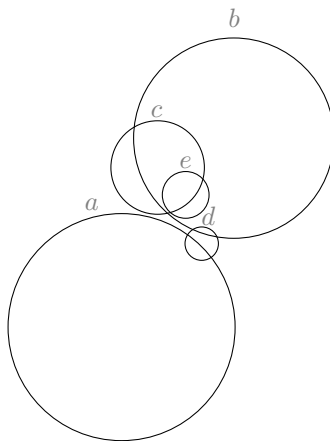

Figure 355:  $ae \rightarrow d$ ,  $cd \rightarrow e$ ,  $ac \rightarrow de$ ,  $ab \rightarrow cde$ ,  $b \rightarrow e$

356

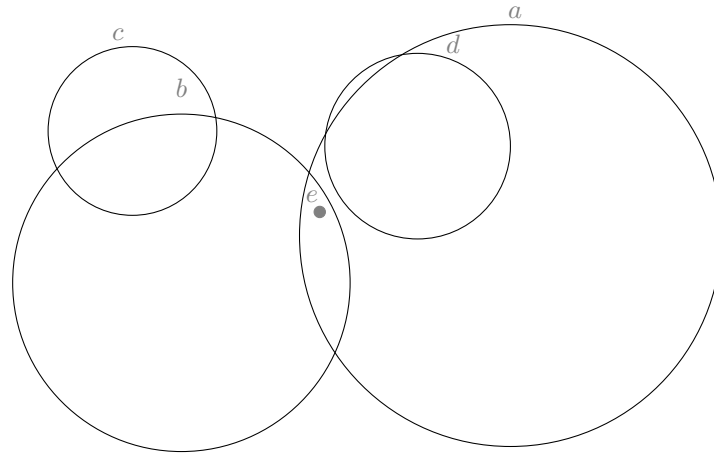

Figure 356:  $cd \rightarrow e, ac \rightarrow de, ab \rightarrow de, b \rightarrow e, a \rightarrow e$

357

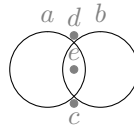

Figure 357:  $a \rightarrow e, b \rightarrow e, cd \rightarrow e, ab \rightarrow cde$

358

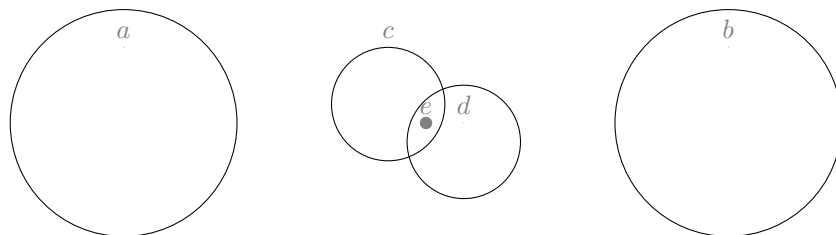

Figure 358:  $d \rightarrow e, c \rightarrow e, ab \rightarrow cde$

APPENDIX B.2: REPRESENTATION OF SIZE 5 GEOMETRIES

359

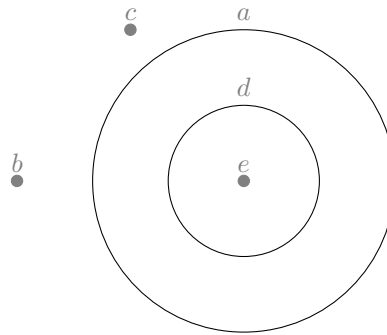

Figure 359:  $a \rightarrow de, d \rightarrow e$

360

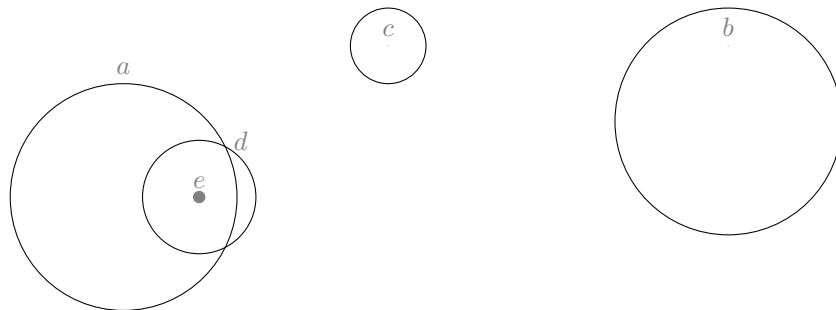

Figure 360:  $d \rightarrow e, a \rightarrow e, ab \rightarrow cde, ac \rightarrow de$

361

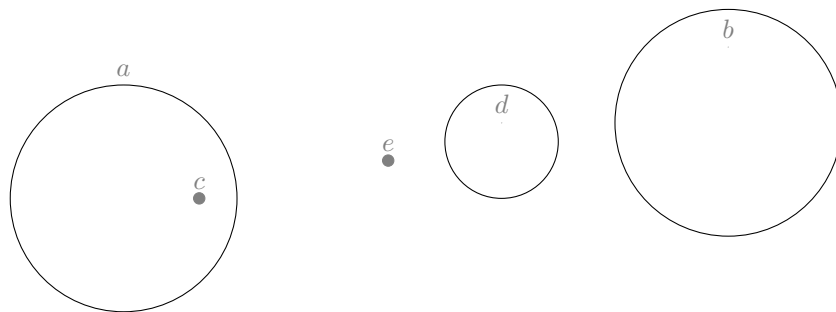

Figure 361:  $cd \rightarrow e, ad \rightarrow ce, bc \rightarrow de, ab \rightarrow cde, a \rightarrow c$

362

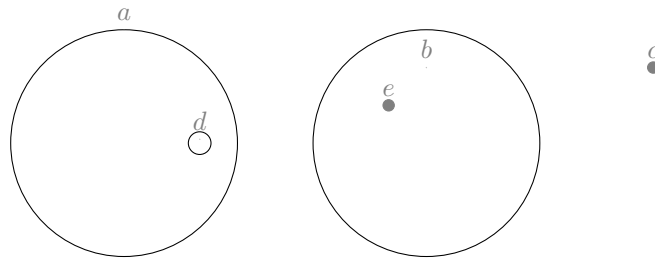

Figure 362:  $cd \rightarrow e$ ,  $ac \rightarrow de$ ,  $ab \rightarrow de$ ,  $b \rightarrow e$ ,  $a \rightarrow d$

363

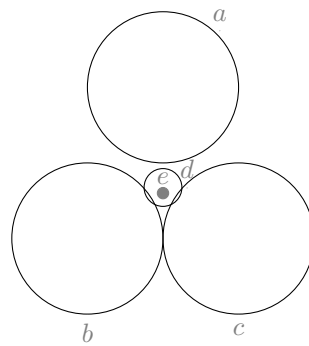

Figure 363:  $ab \rightarrow d$ ,  $ac \rightarrow d$ ,  $bc \rightarrow d$ ,  $d \rightarrow e$

364

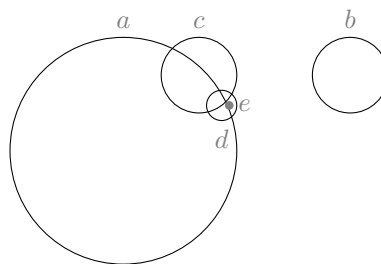

Figure 364:  $d \rightarrow e$ ,  $bc \rightarrow e$ ,  $ac \rightarrow de$ ,  $ab \rightarrow cde$

APPENDIX B.2: REPRESENTATION OF SIZE 5 GEOMETRIES

365

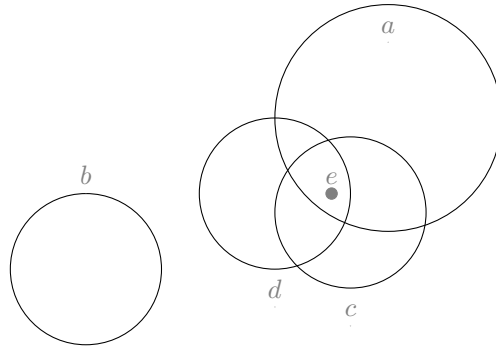

Figure 365:  $d \rightarrow e, c \rightarrow e, ab \rightarrow de, a \rightarrow e$

366

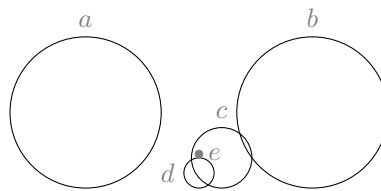

Figure 366:  $c \rightarrow e, ad \rightarrow e, bd \rightarrow e, ac \rightarrow de, ab \rightarrow cde$

367

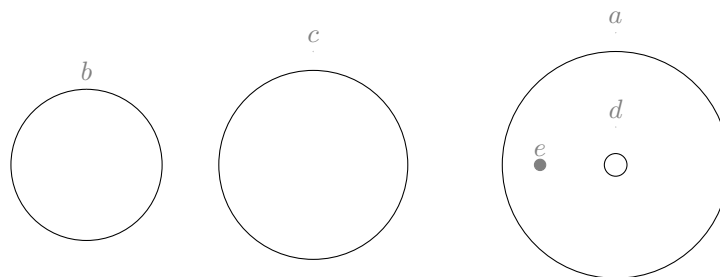

Figure 367:  $cd \rightarrow e, bd \rightarrow e, ab \rightarrow cde, a \rightarrow de$

368

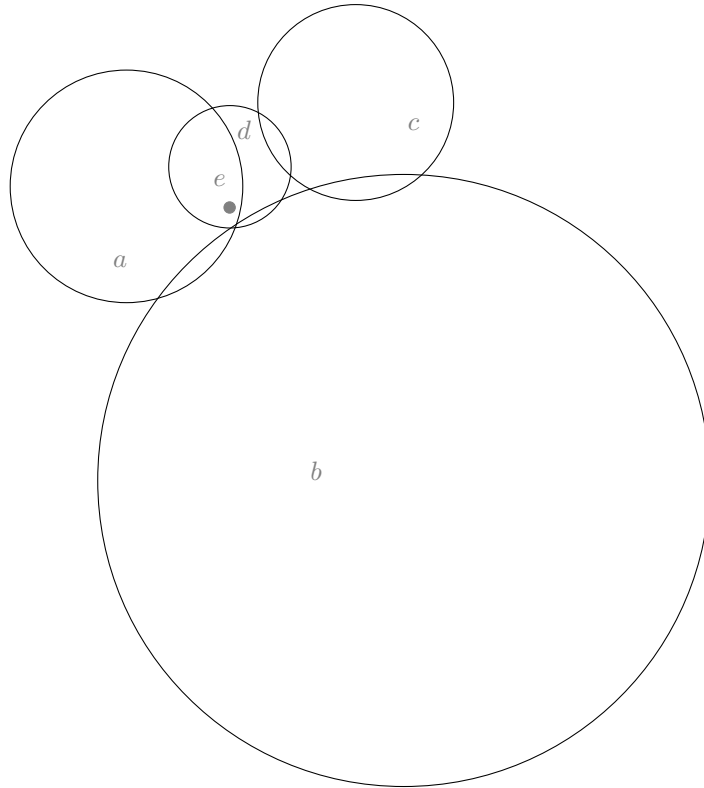

Figure 368:  $d \rightarrow e, bc \rightarrow e, ac \rightarrow de, ab \rightarrow de, a \rightarrow e$

369

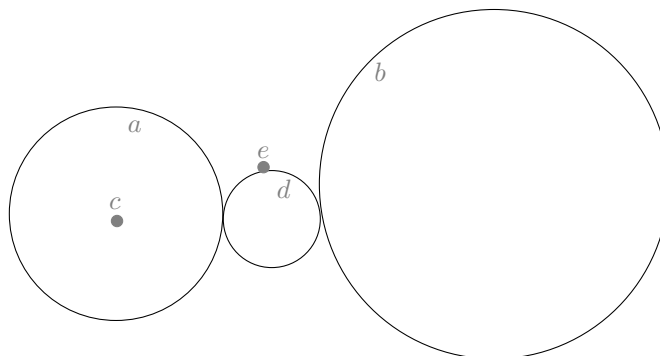

Figure 369:  $bd \rightarrow e, ad \rightarrow ce, bc \rightarrow de, ab \rightarrow cde, a \rightarrow c$



APPENDIX B.2: REPRESENTATION OF SIZE 5 GEOMETRIES

370

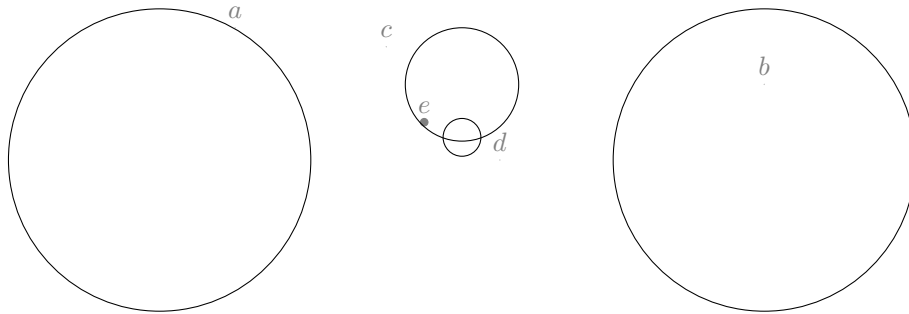

Figure 370:  $ad \rightarrow e, bc \rightarrow de, ac \rightarrow de, c \rightarrow e, ab \rightarrow cde$

371

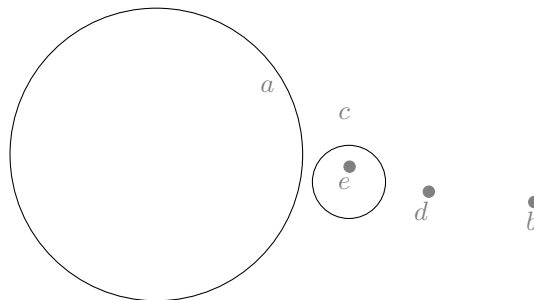

Figure 371:  $ad \rightarrow ce, bc \rightarrow de, c \rightarrow e, ab \rightarrow cde$

372

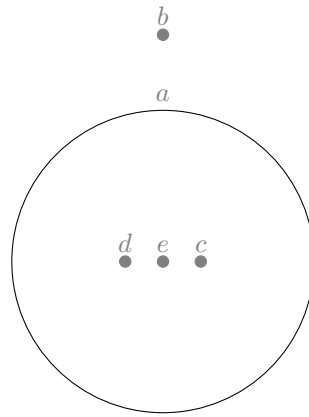

Figure 372:  $a \rightarrow cde, cd \rightarrow e$

373

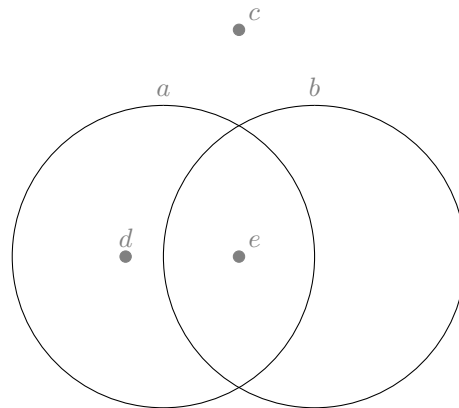

Figure 373:  $a \rightarrow de, b \rightarrow e$

374

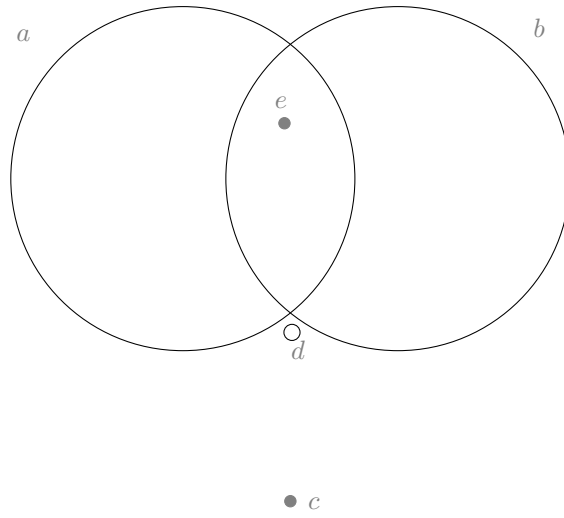

Figure 374:  $bc \rightarrow de, ac \rightarrow de, ab \rightarrow de, b \rightarrow e, a \rightarrow e$

375

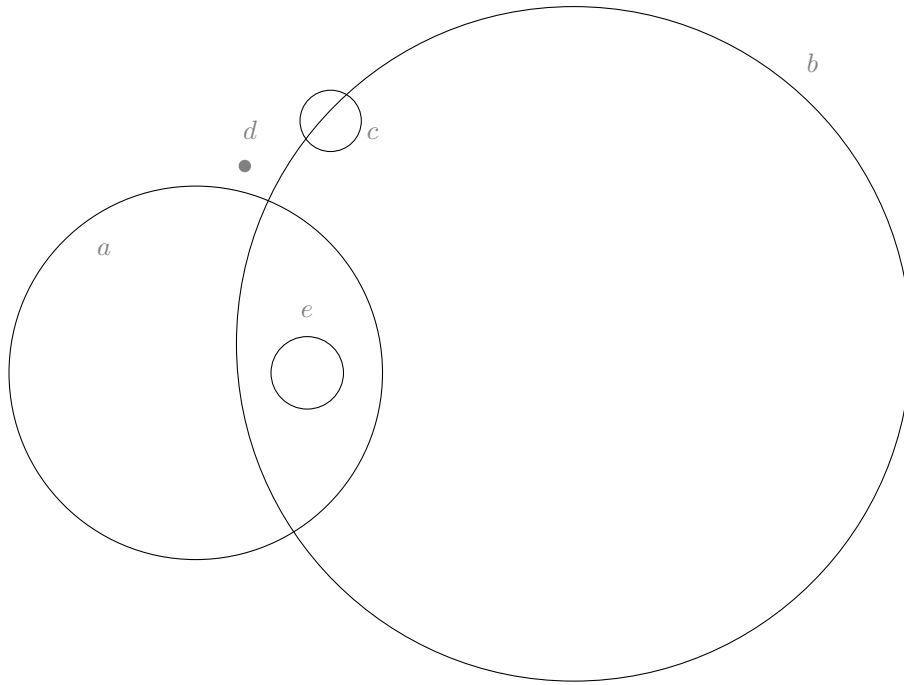

Figure 375:  $ac \rightarrow de, ab \rightarrow cde, b \rightarrow e, a \rightarrow e$

376

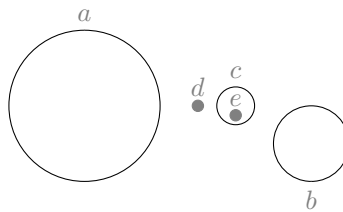

Figure 376:  $ab \rightarrow cd, ac \rightarrow d, ae \rightarrow d, c \rightarrow e, bd \rightarrow e$

377

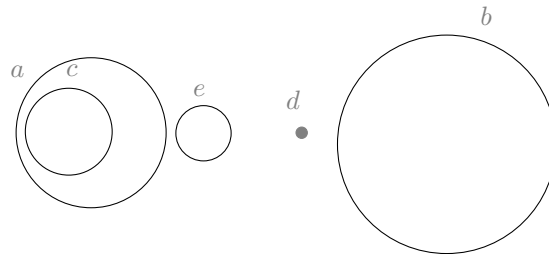

Figure 377:  $be \rightarrow d, ad \rightarrow ce, bc \rightarrow de, ab \rightarrow cde, a \rightarrow c$

378

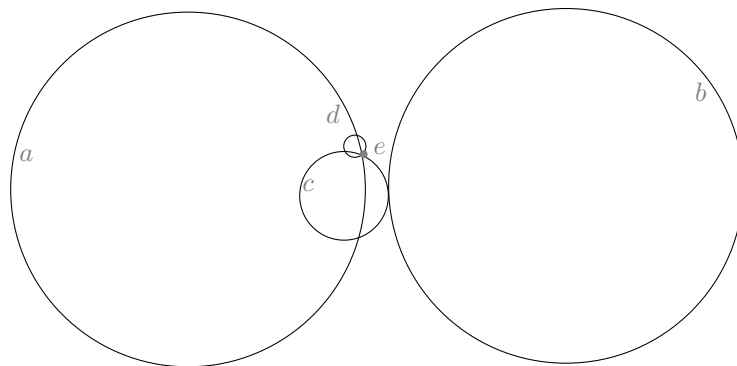

Figure 378:  $ab \rightarrow cde, ac \rightarrow de, bc \rightarrow de, cd \rightarrow e, bd \rightarrow e, ad \rightarrow e$

APPENDIX B.2: REPRESENTATION OF SIZE 5 GEOMETRIES

379

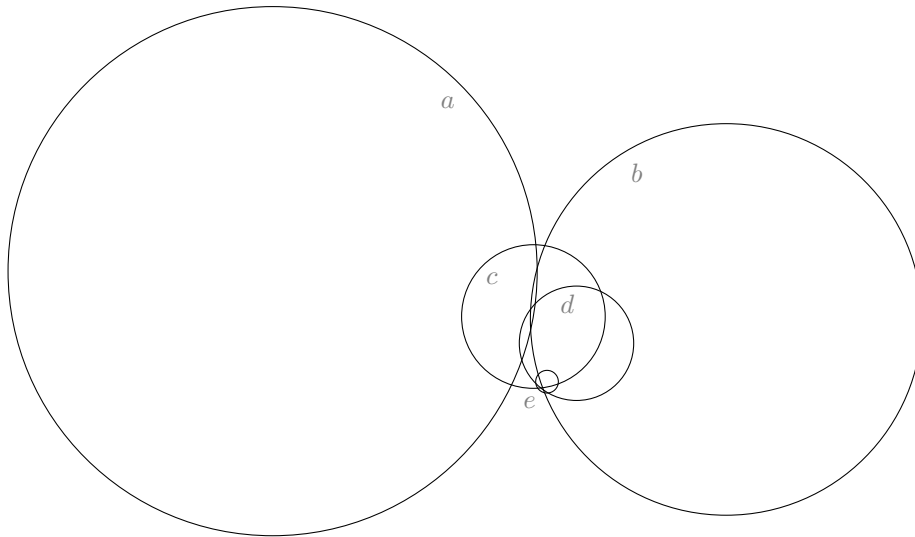

Figure 379:  $cd \rightarrow e, bd \rightarrow e, ad \rightarrow ce, bc \rightarrow de, ac \rightarrow e, ab \rightarrow cde$

380

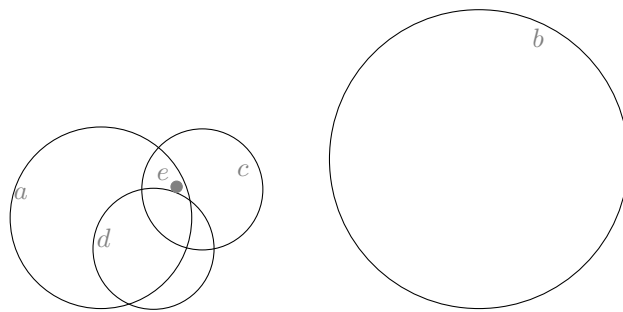

Figure 380:  $ab \rightarrow cd, bd \rightarrow e, a \rightarrow e, c \rightarrow e$

381

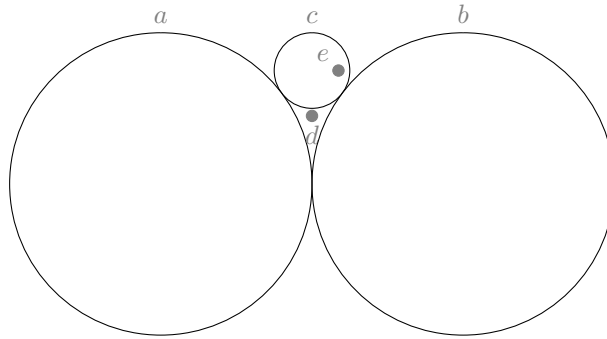

Figure 381:  $ac \rightarrow d, bc \rightarrow d, ab \rightarrow cd, c \rightarrow e, ae \rightarrow d$

382

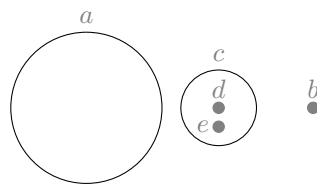

Figure 382:  $c \rightarrow de, ab \rightarrow cde$

383

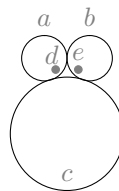

Figure 383:  $a \rightarrow d, b \rightarrow e, ac \rightarrow de, bc \rightarrow de$

384

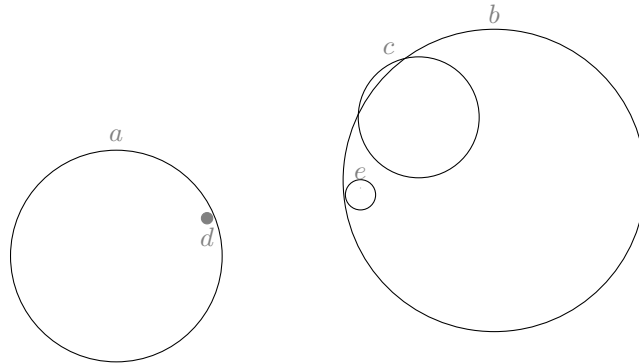

Figure 384:  $ac \rightarrow de, ab \rightarrow cde, b \rightarrow e, a \rightarrow d$

385

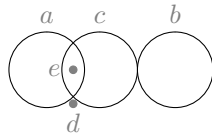

Figure 385:  $a \rightarrow e, c \rightarrow e, ac \rightarrow de, ab \rightarrow cde$

386

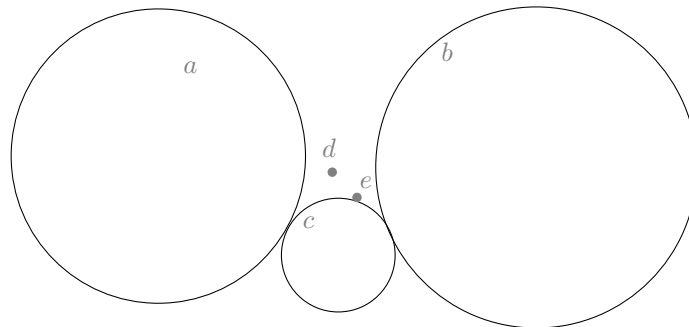

Figure 386:  $ae \rightarrow d, cd \rightarrow e, bd \rightarrow e, bc \rightarrow de, ac \rightarrow de, ab \rightarrow cde$



387

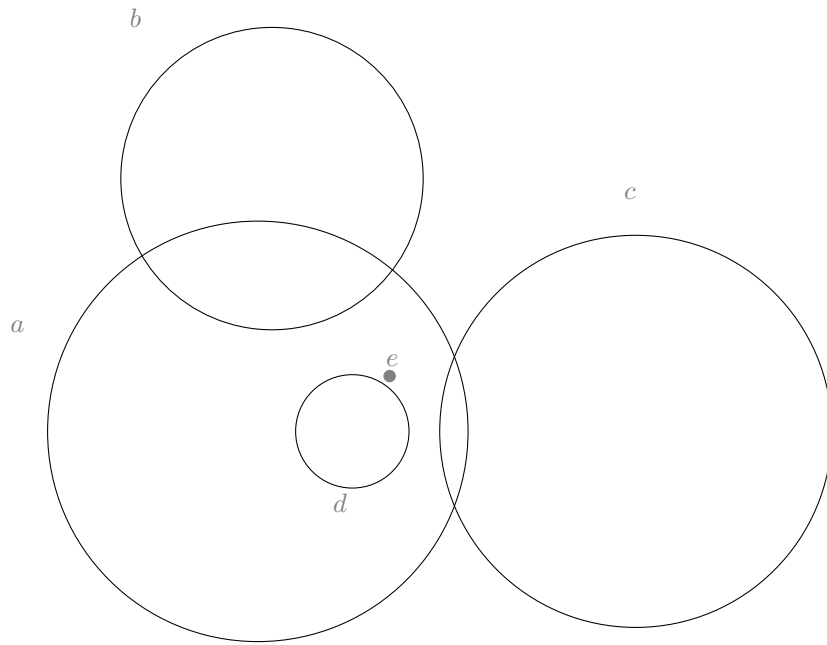

Figure 387:  $cd \rightarrow e, bd \rightarrow e, bc \rightarrow e, a \rightarrow de$

388

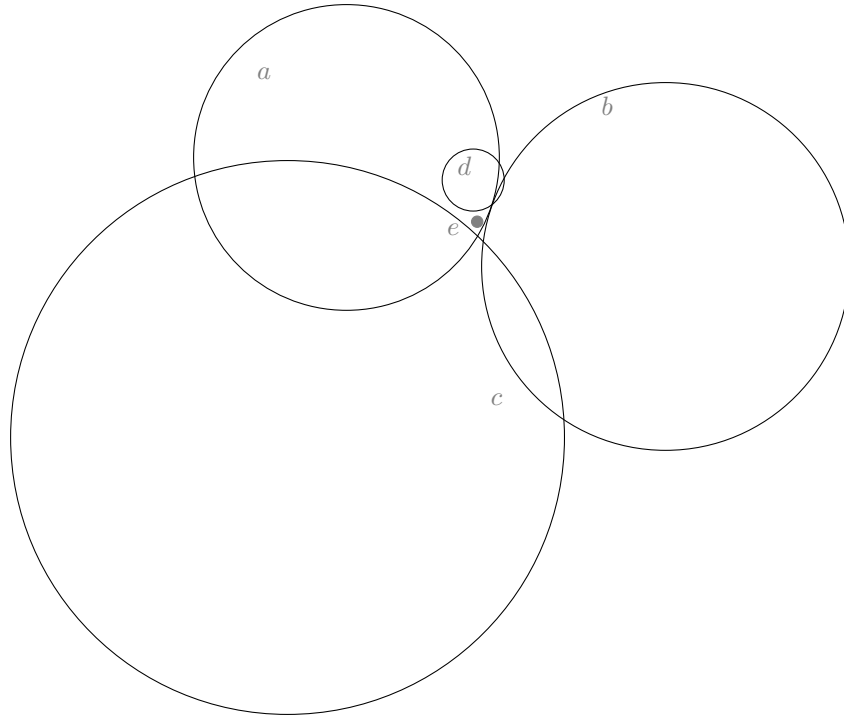

Figure 388:  $cd \rightarrow e, bd \rightarrow e, bc \rightarrow de, ac \rightarrow de, ab \rightarrow de, a \rightarrow e$

389

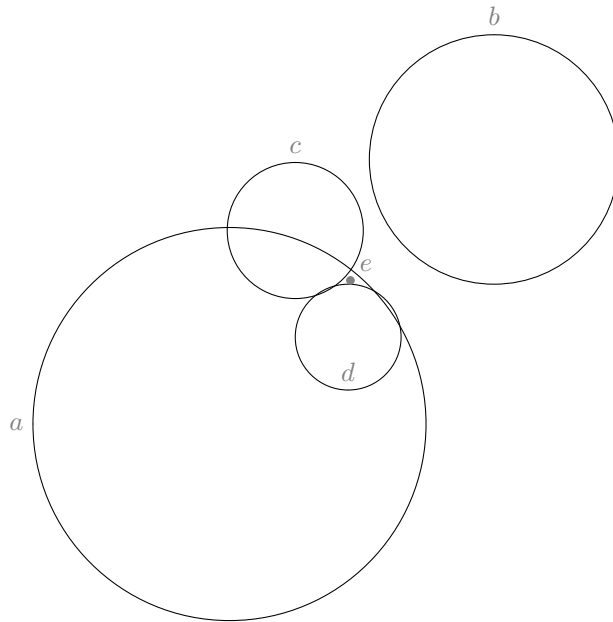

Figure 389:  $a \rightarrow e$ ,  $bc \rightarrow e$ ,  $bd \rightarrow e$ ,  $cd \rightarrow e$ ,  $ac \rightarrow de$ ,  $ab \rightarrow cde$

390

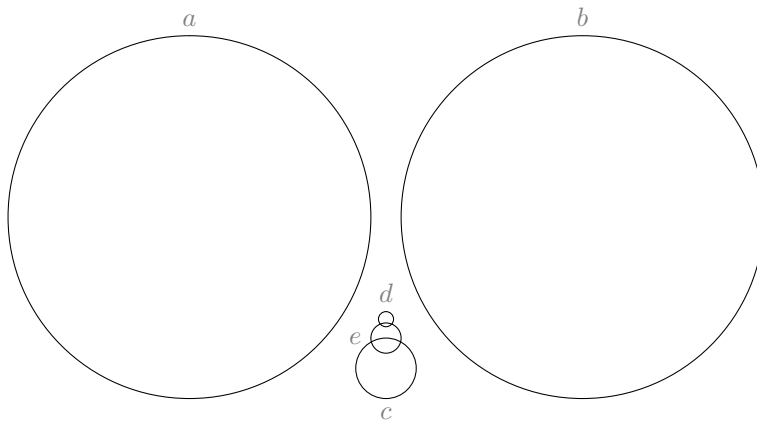

Figure 390:  $be \rightarrow d$ ,  $ae \rightarrow d$ ,  $cd \rightarrow e$ ,  $bc \rightarrow de$ ,  $ac \rightarrow de$ ,  $ab \rightarrow cde$

APPENDIX B.2: REPRESENTATION OF SIZE 5 GEOMETRIES

391

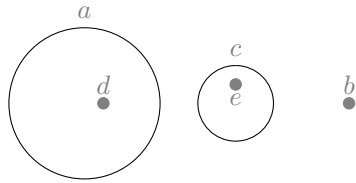

Figure 391:  $a \rightarrow d, ab \rightarrow c, c \rightarrow e$

392

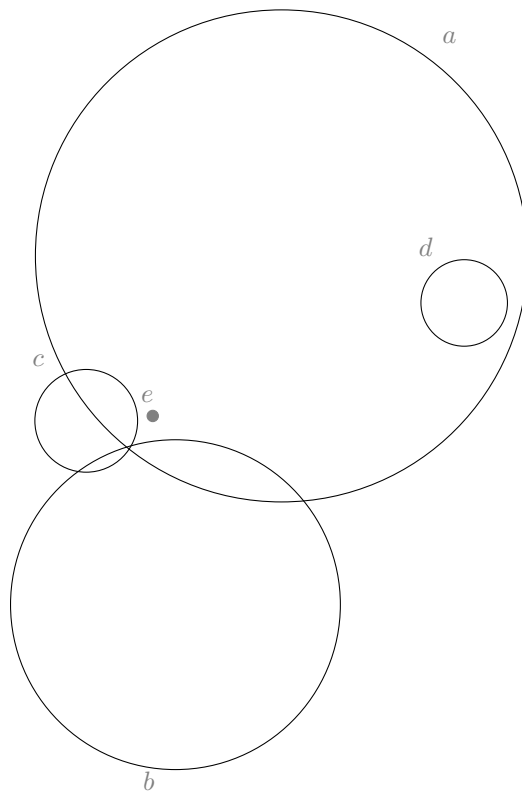

Figure 392:  $cd \rightarrow e, bc \rightarrow e, ab \rightarrow cde, a \rightarrow de$

APPENDIX B.2: REPRESENTATION OF SIZE 5 GEOMETRIES

393

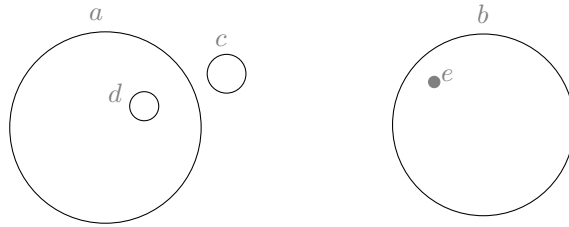

Figure 393:  $ae \rightarrow cd, ab \rightarrow cde, b \rightarrow e, a \rightarrow d$

394

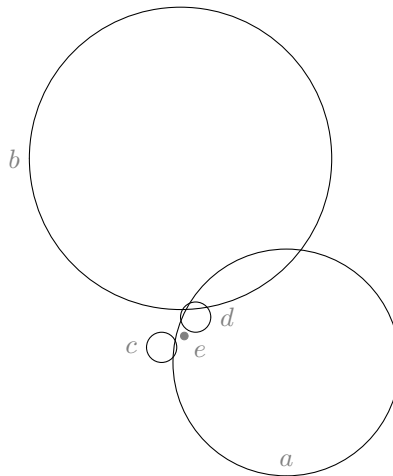

Figure 394:  $a \rightarrow e, cd \rightarrow e, bc \rightarrow de, ac \rightarrow de, ab \rightarrow cde$

395

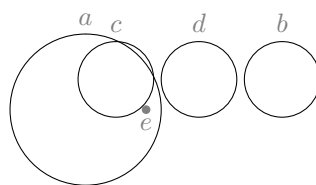

Figure 395:  $a \rightarrow e, cd \rightarrow e, ad \rightarrow ce, bc \rightarrow de, ab \rightarrow cde$

396

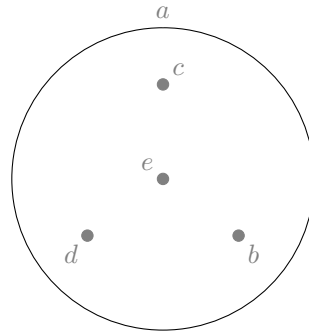

Figure 396:  $bcd \rightarrow e, a \rightarrow bcde$

397

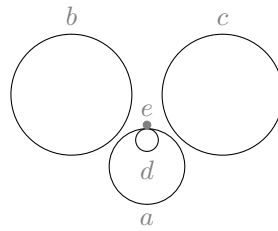

Figure 397:  $a \rightarrow d, cd \rightarrow e, bd \rightarrow e, bc \rightarrow de, ac \rightarrow de, ab \rightarrow de$

398

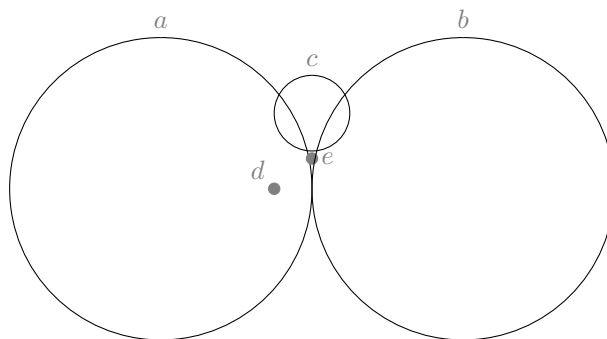

Figure 398:  $ac \rightarrow e, bc \rightarrow e, ab \rightarrow ce, cd \rightarrow e, bd \rightarrow e, a \rightarrow d$

APPENDIX B.2: REPRESENTATION OF SIZE 5 GEOMETRIES

399

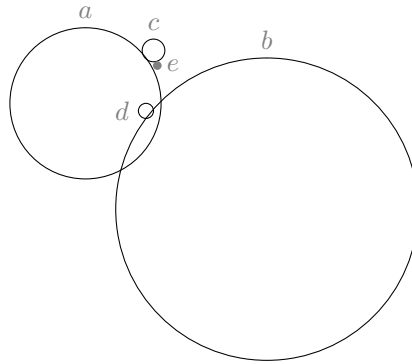

Figure 399:  $a \rightarrow d, cd \rightarrow e, bc \rightarrow de, ac \rightarrow de, ab \rightarrow cde$

400

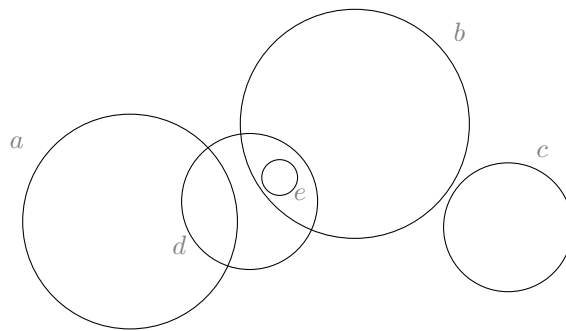

Figure 400:  $ab \rightarrow de, ac \rightarrow de, d \rightarrow e, b \rightarrow e$

401

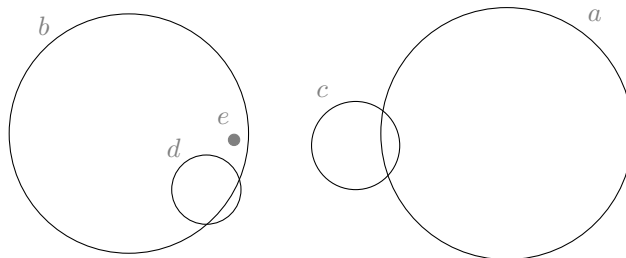

Figure 401:  $ae \rightarrow c, ad \rightarrow ce, bc \rightarrow de, ab \rightarrow cde, b \rightarrow e$

APPENDIX B.2: REPRESENTATION OF SIZE 5 GEOMETRIES

402

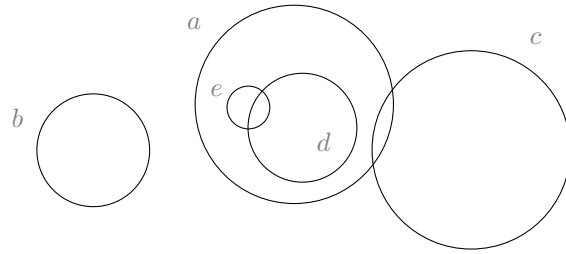

Figure 402:  $bc \rightarrow de, bd \rightarrow e, a \rightarrow de$

403

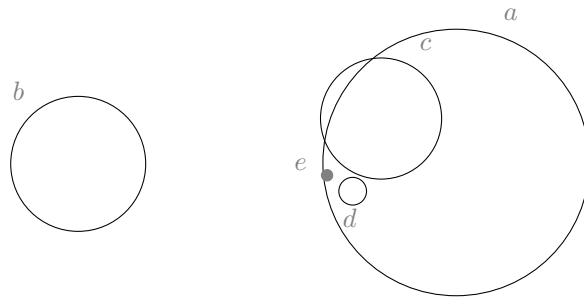

Figure 403:  $ab \rightarrow cde, bd \rightarrow e, bc \rightarrow e, a \rightarrow de$

404

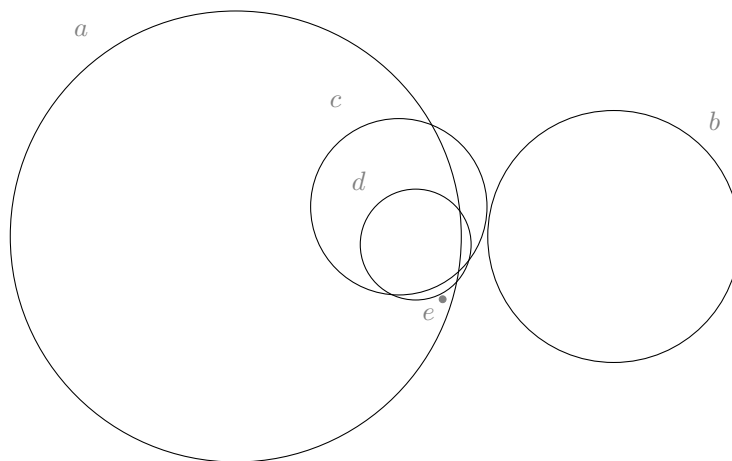

Figure 404:  $bd \rightarrow e, bc \rightarrow de, ac \rightarrow de, ab \rightarrow cde, a \rightarrow e$



APPENDIX B.2: REPRESENTATION OF SIZE 5 GEOMETRIES

405

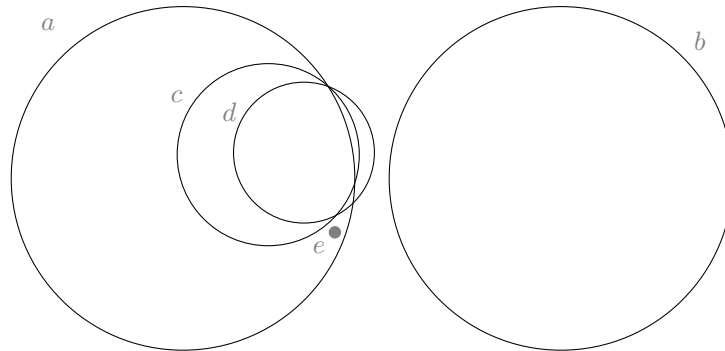

Figure 405:  $bd \rightarrow e, ad \rightarrow c, bc \rightarrow de, ab \rightarrow cd, a \rightarrow e$

406

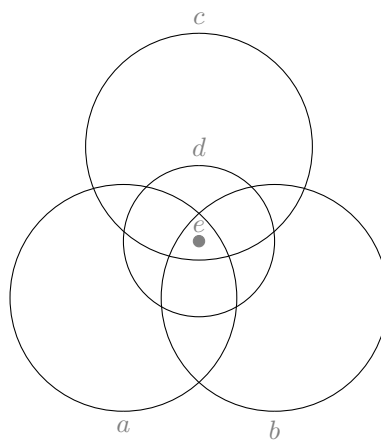

Figure 406:  $a \rightarrow e, b \rightarrow e, c \rightarrow e, d \rightarrow e, abc \rightarrow de$

APPENDIX B.2: REPRESENTATION OF SIZE 5 GEOMETRIES

407

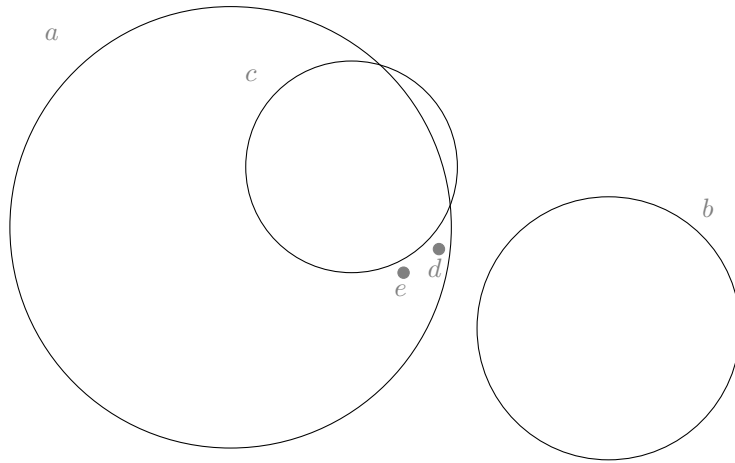

Figure 407:  $bc \rightarrow de, ab \rightarrow cde, a \rightarrow de$

408

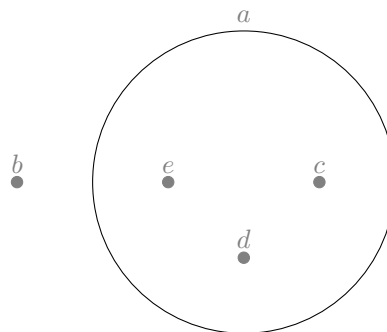

Figure 408:  $a \rightarrow cde, bc \rightarrow e$

APPENDIX B.2: REPRESENTATION OF SIZE 5 GEOMETRIES

409

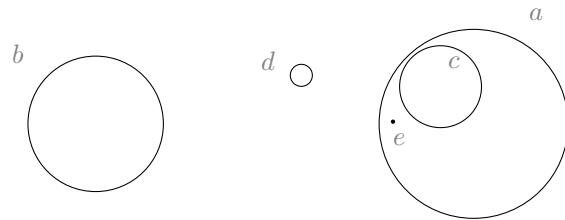

Figure 409:  $ab \rightarrow cde, bc \rightarrow de, a \rightarrow ce$

410

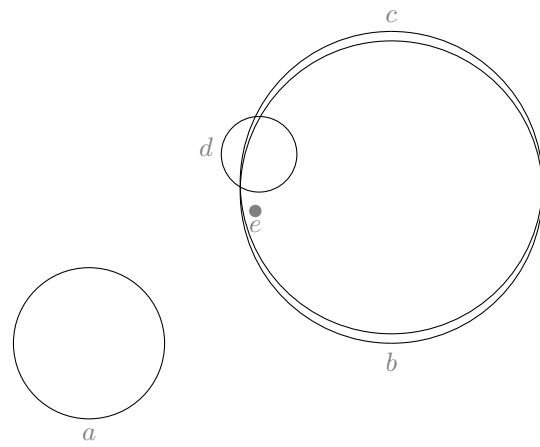

Figure 410:  $b \rightarrow e, c \rightarrow e, ab \rightarrow de, ac \rightarrow de, ad \rightarrow e$

APPENDIX B.2: REPRESENTATION OF SIZE 5 GEOMETRIES

411

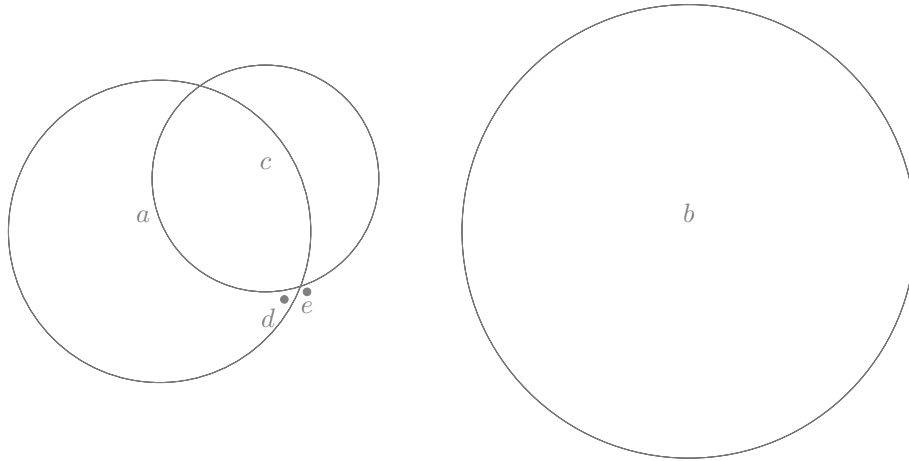

Figure 411:  $bd \rightarrow e$ ,  $bc \rightarrow de$ ,  $ac \rightarrow de$ ,  $ab \rightarrow cde$ ,  $a \rightarrow d$

412

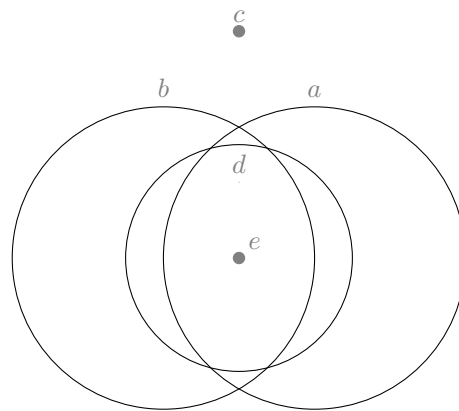

Figure 412:  $a \rightarrow e$ ,  $b \rightarrow e$ ,  $d \rightarrow e$ ,  $ab \rightarrow de$

APPENDIX B.2: REPRESENTATION OF SIZE 5 GEOMETRIES

413

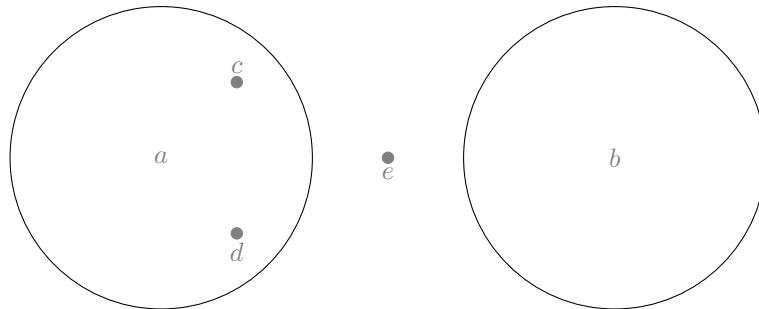

Figure 413:  $bd \rightarrow e$ ,  $bc \rightarrow e$ ,  $ab \rightarrow cde$ ,  $a \rightarrow cd$

414

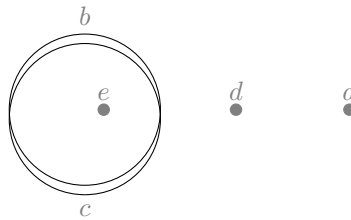

Figure 414:  $b \rightarrow e$ ,  $c \rightarrow e$ ,  $ab \rightarrow de$ ,  $ac \rightarrow de$ ,  $ae \rightarrow d$

415

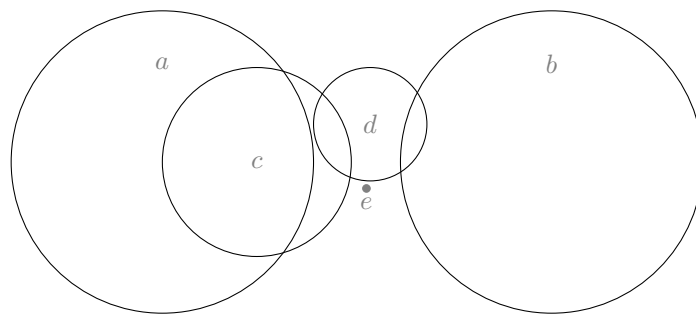

Figure 415:  $ae \rightarrow c$ ,  $cd \rightarrow e$ ,  $bd \rightarrow e$ ,  $ad \rightarrow ce$ ,  $bc \rightarrow de$ ,  $ab \rightarrow cde$

APPENDIX B.2: REPRESENTATION OF SIZE 5 GEOMETRIES

416

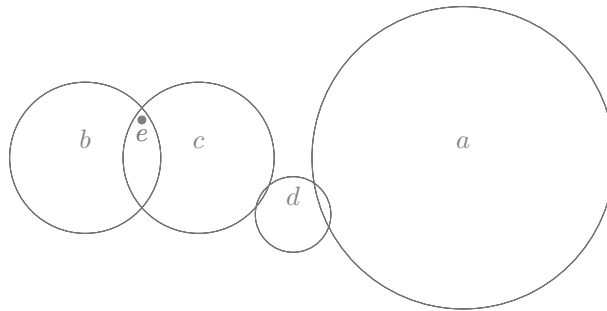

Figure 416:  $ac \rightarrow de, c \rightarrow e, ab \rightarrow cde, b \rightarrow e$

417

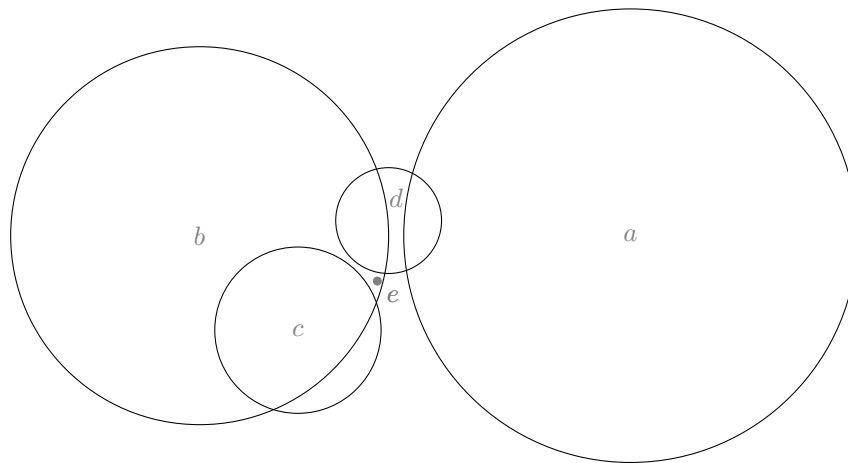

Figure 417:  $cd \rightarrow e, ad \rightarrow e, ac \rightarrow de, ab \rightarrow cde, b \rightarrow e$

418

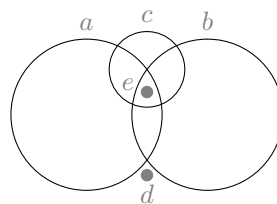

Figure 418:  $ab \rightarrow de, a \rightarrow e, b \rightarrow e, c \rightarrow e$

419

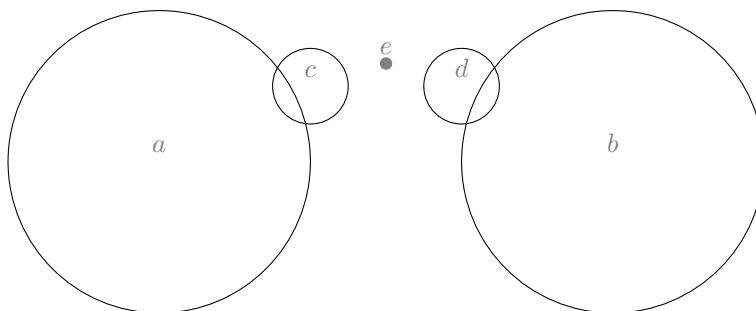

Figure 419:  $be \rightarrow d$ ,  $ae \rightarrow c$ ,  $cd \rightarrow e$ ,  $ad \rightarrow ce$ ,  $bc \rightarrow de$ ,  $ab \rightarrow cde$

420

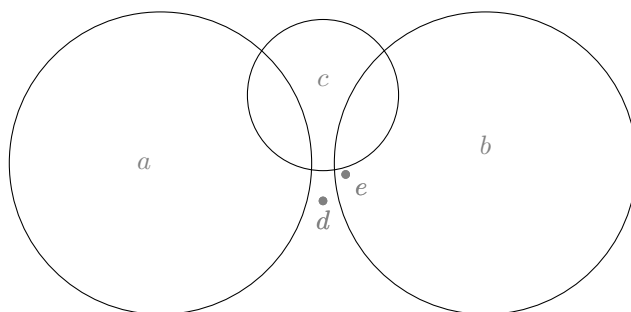

Figure 420:  $ae \rightarrow d$ ,  $cd \rightarrow e$ ,  $bc \rightarrow de$ ,  $ac \rightarrow de$ ,  $ab \rightarrow cde$ ,  $b \rightarrow e$

421

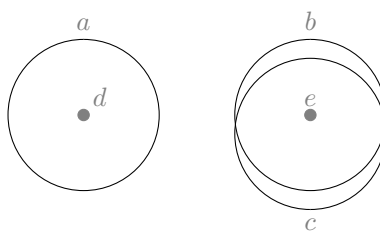

Figure 421:  $a \rightarrow d$ ,  $b \rightarrow e$ ,  $c \rightarrow e$

422

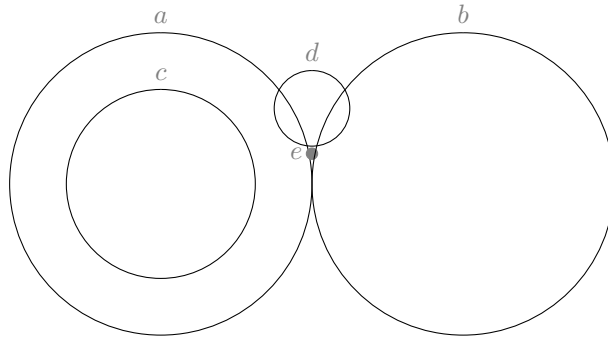

Figure 422:  $ad \rightarrow e$ ,  $bd \rightarrow e$ ,  $ab \rightarrow de$ ,  $bc \rightarrow de$ ,  $cd \rightarrow e$ ,  $a \rightarrow c$

423

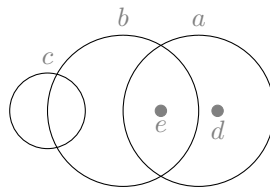

Figure 423:  $b \rightarrow e$ ,  $a \rightarrow de$ ,  $cd \rightarrow e$



424

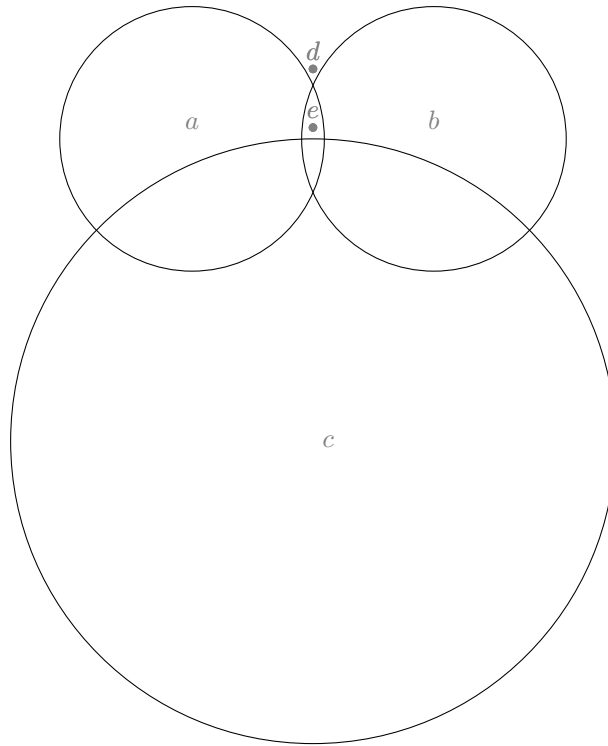

Figure 424:  $cd \rightarrow e$ ,  $bc \rightarrow de$ ,  $ac \rightarrow de$ ,  $ab \rightarrow de$ ,  $b \rightarrow e$ ,  $a \rightarrow e$

425

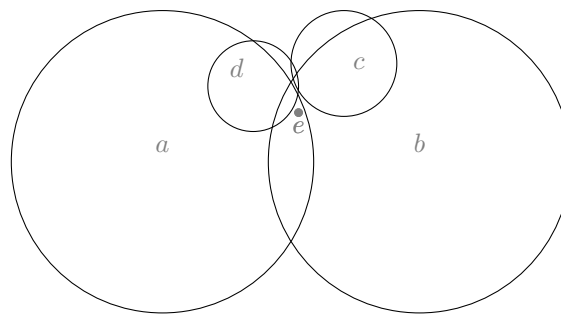

Figure 425:  $cd \rightarrow e$ ,  $ac \rightarrow de$ ,  $ab \rightarrow cde$ ,  $b \rightarrow e$ ,  $a \rightarrow e$

APPENDIX B.2: REPRESENTATION OF SIZE 5 GEOMETRIES

426

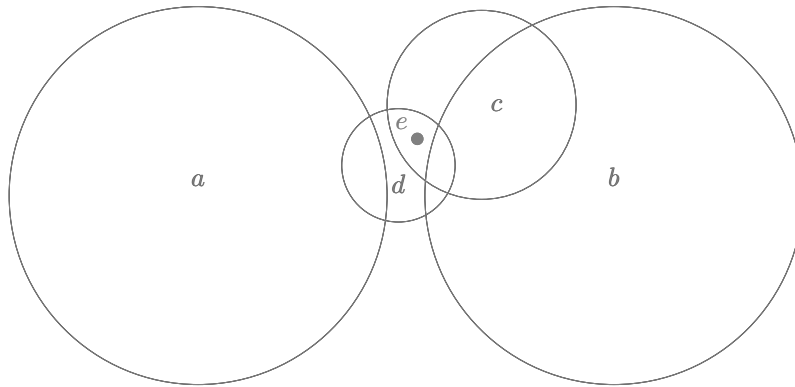

Figure 426:  $d \rightarrow e$ ,  $ac \rightarrow de$ ,  $c \rightarrow e$ ,  $ab \rightarrow cde$

427

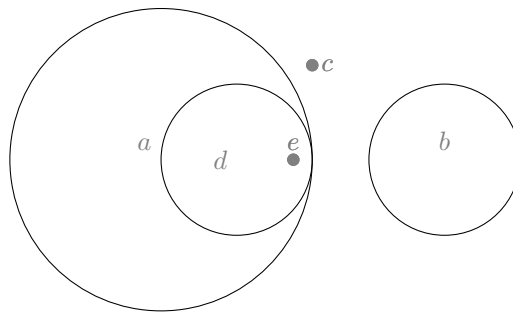

Figure 427:  $d \rightarrow e$ ,  $ab \rightarrow cde$ ,  $a \rightarrow de$

APPENDIX B.2: REPRESENTATION OF SIZE 5 GEOMETRIES

428

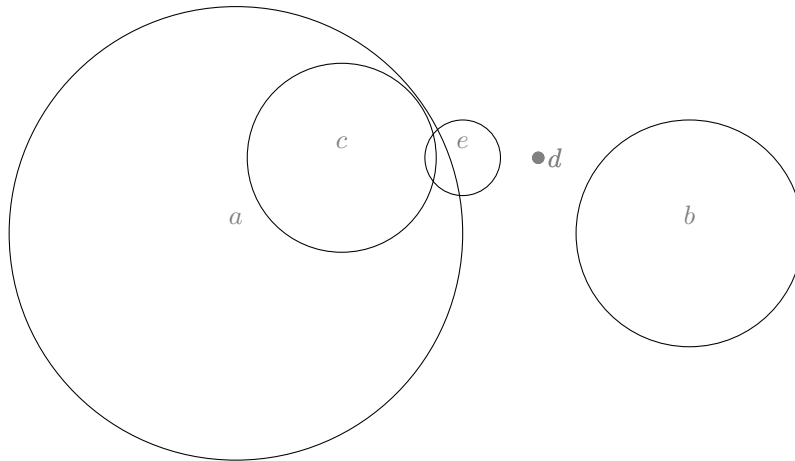

Figure 428:  $be \rightarrow d$ ,  $cd \rightarrow e$ ,  $ad \rightarrow ce$ ,  $bc \rightarrow de$ ,  $ab \rightarrow cde$ ,  $a \rightarrow c$

429

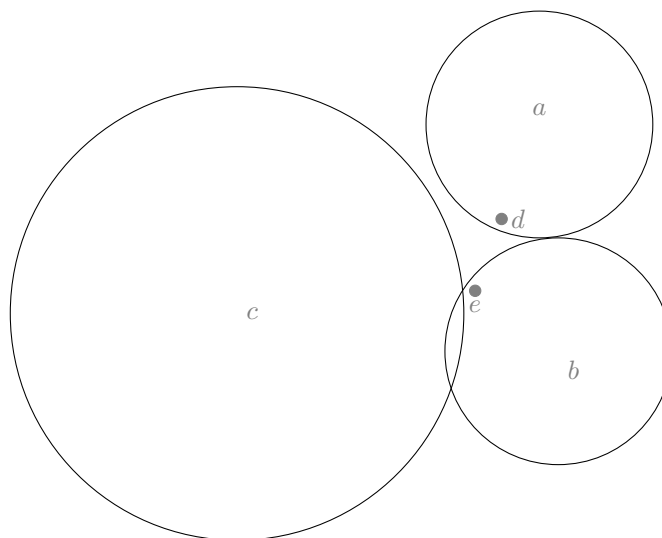

Figure 429:  $cd \rightarrow e$ ,  $bc \rightarrow de$ ,  $ac \rightarrow de$ ,  $ab \rightarrow de$ ,  $b \rightarrow e$ ,  $a \rightarrow d$

430

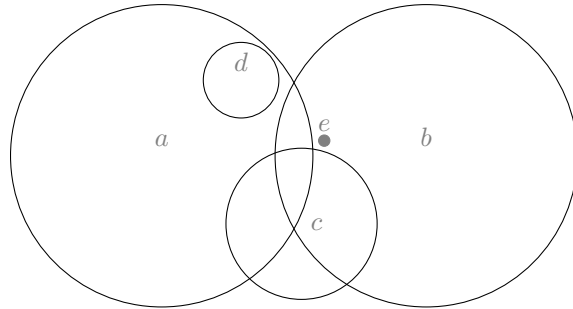

Figure 430:  $cd \rightarrow e$ ,  $ac \rightarrow de$ ,  $ab \rightarrow cde$ ,  $b \rightarrow e$ ,  $a \rightarrow d$

431

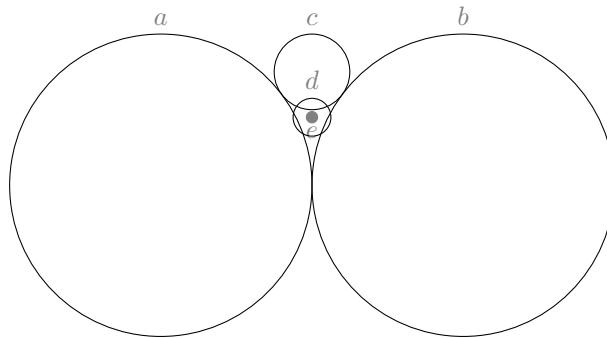

Figure 431:  $ac \rightarrow d$ ,  $bc \rightarrow d$ ,  $ab \rightarrow cd$ ,  $d \rightarrow e$

432



Figure 432:  $d \rightarrow e$ ,  $c \rightarrow e$ ,  $ab \rightarrow cde$ ,  $a \rightarrow e$

433

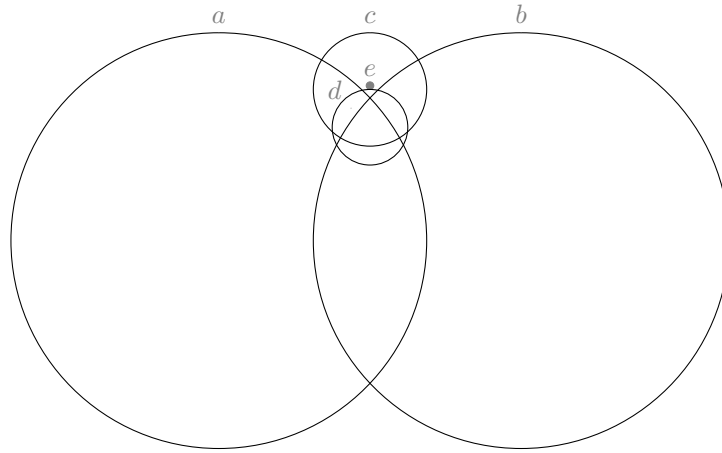

Figure 433:  $ac \rightarrow d, bc \rightarrow d, ab \rightarrow cd, ad \rightarrow e, bd \rightarrow e, c \rightarrow e$

434

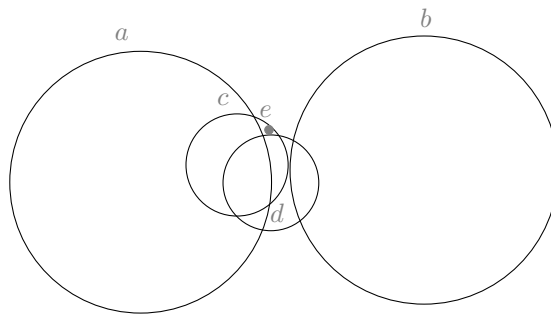

Figure 434:  $ab \rightarrow cde, c \rightarrow e, bc \rightarrow de, ad \rightarrow ce, bd \rightarrow e$

APPENDIX B.2: REPRESENTATION OF SIZE 5 GEOMETRIES

435

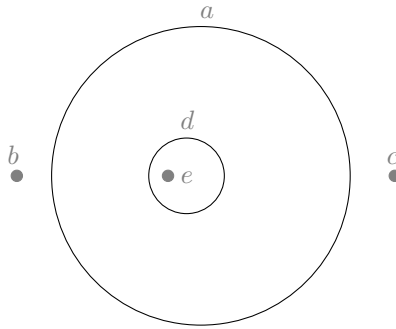

Figure 435:  $a \rightarrow de, d \rightarrow e, bc \rightarrow e$

436

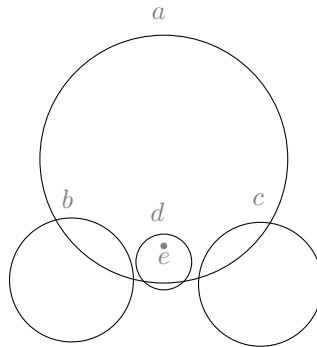

Figure 436:  $a \rightarrow e, bc \rightarrow de, ab \rightarrow de, ac \rightarrow de, d \rightarrow e$

437

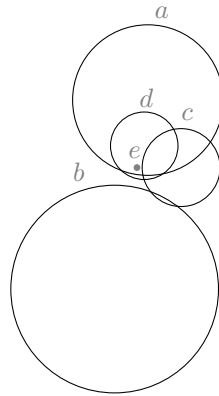

Figure 437:  $a \rightarrow e, bc \rightarrow e, ac \rightarrow de, ab \rightarrow cde, d \rightarrow e$

438

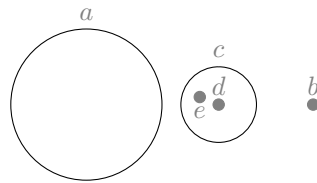

Figure 438:  $c \rightarrow de, ab \rightarrow cde, ad \rightarrow e$

439

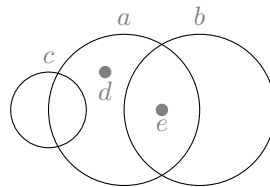

Figure 439:  $a \rightarrow de, b \rightarrow e, bc \rightarrow d$

440

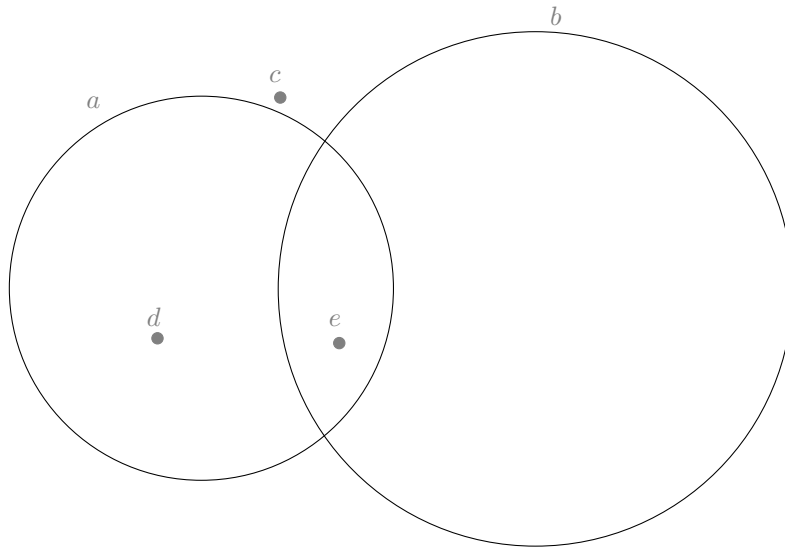

Figure 440:  $ab \rightarrow cde, b \rightarrow e, a \rightarrow de$

441

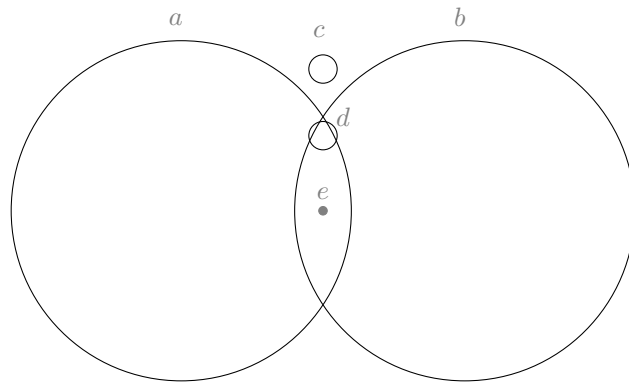

Figure 441:  $bc \rightarrow de, ac \rightarrow de, ab \rightarrow cde, b \rightarrow e, a \rightarrow e$



APPENDIX B.2: REPRESENTATION OF SIZE 5 GEOMETRIES

442

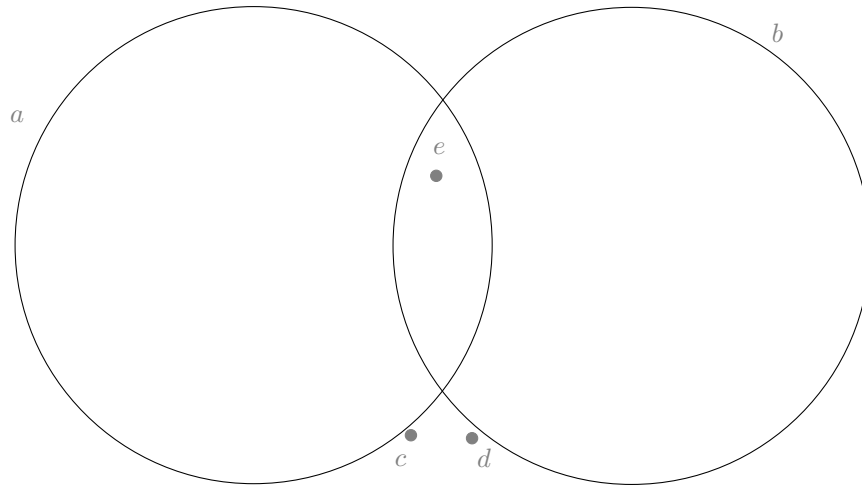

Figure 442:  $a \rightarrow e, b \rightarrow e, ab \rightarrow cde, ad \rightarrow ce, bc \rightarrow de$

443

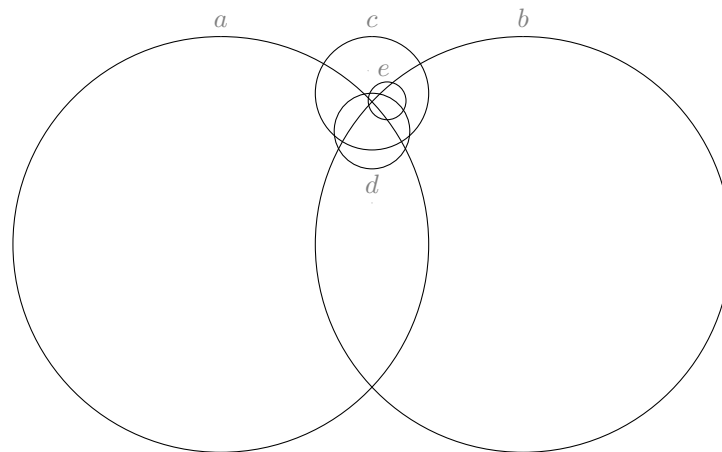

Figure 443:  $ac \rightarrow d, ae \rightarrow d, bc \rightarrow d, ab \rightarrow cd, bd \rightarrow e, c \rightarrow e$

444

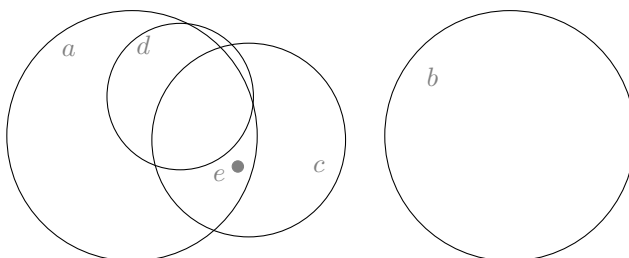

Figure 444:  $bd \rightarrow e$ ,  $ac \rightarrow de$ ,  $c \rightarrow e$ ,  $ab \rightarrow cde$ ,  $a \rightarrow e$

445

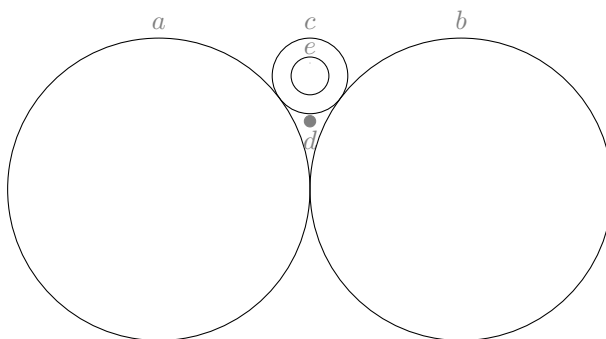

Figure 445:  $ac \rightarrow d$ ,  $bc \rightarrow d$ ,  $ab \rightarrow cd$ ,  $c \rightarrow e$ ,  $ae \rightarrow d$ ,  $be \rightarrow d$

446

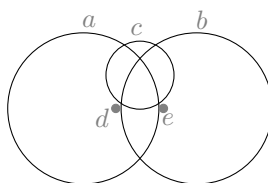

Figure 446:  $bc \rightarrow de$ ,  $ac \rightarrow de$ ,  $ab \rightarrow cde$ ,  $b \rightarrow e$ ,  $a \rightarrow d$

APPENDIX B.2: REPRESENTATION OF SIZE 5 GEOMETRIES

447

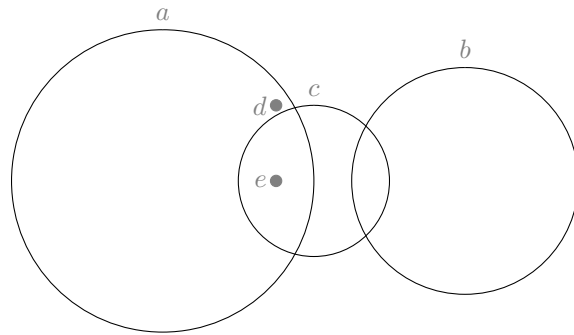

Figure 447:  $a \rightarrow de$ ,  $c \rightarrow e$ ,  $ab \rightarrow ce$

448

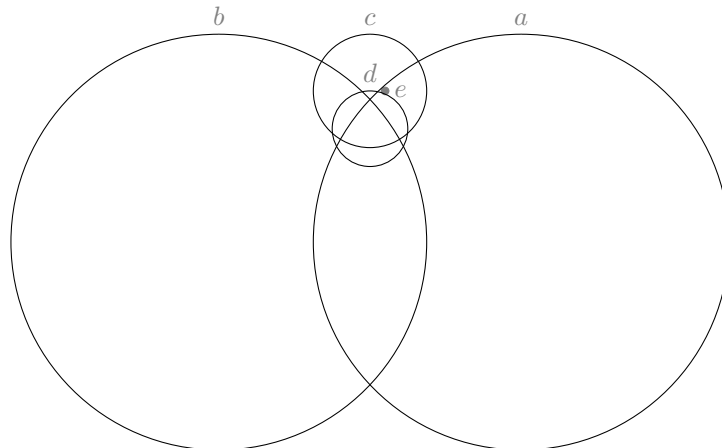

Figure 448:  $ac \rightarrow d$ ,  $bc \rightarrow d$ ,  $ab \rightarrow cd$ ,  $a \rightarrow e$ ,  $c \rightarrow e$

APPENDIX B.2: REPRESENTATION OF SIZE 5 GEOMETRIES

449

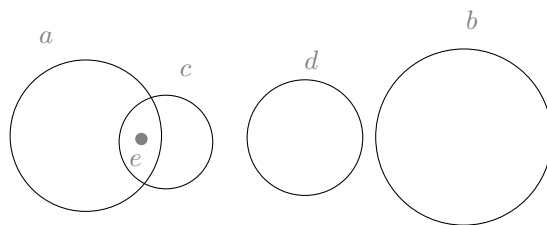

Figure 449:  $a \rightarrow e, c \rightarrow e, ab \rightarrow cde, ad \rightarrow ce, bc \rightarrow de$

450

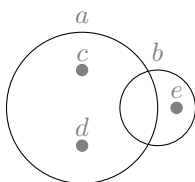

Figure 450:  $ab \rightarrow cde, b \rightarrow e, a \rightarrow cd$

451

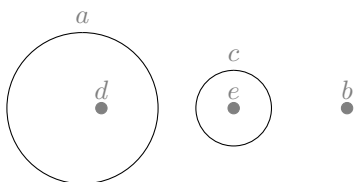

Figure 451:  $a \rightarrow d, bd \rightarrow e, ab \rightarrow c, c \rightarrow e$

452

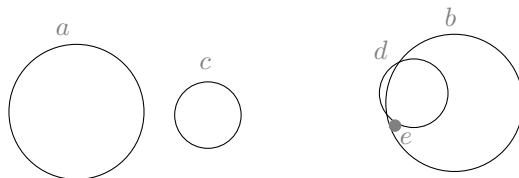

Figure 452:  $ae \rightarrow c, cd \rightarrow e, ad \rightarrow ce, bc \rightarrow de, ab \rightarrow cde, b \rightarrow e$

453

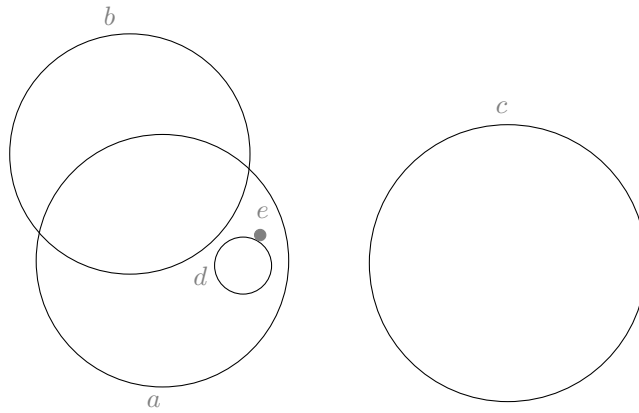

Figure 453:  $cd \rightarrow e, bd \rightarrow e, bc \rightarrow de, a \rightarrow de$

454

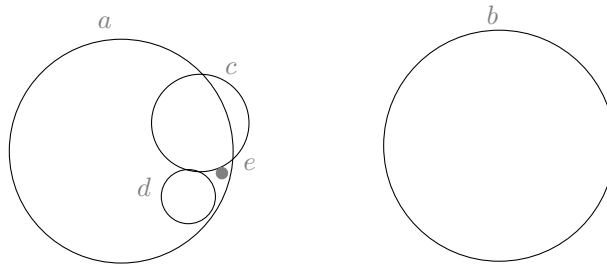

Figure 454:  $cd \rightarrow e, bd \rightarrow e, bc \rightarrow e, ab \rightarrow cde, a \rightarrow de$

APPENDIX B.2: REPRESENTATION OF SIZE 5 GEOMETRIES

455

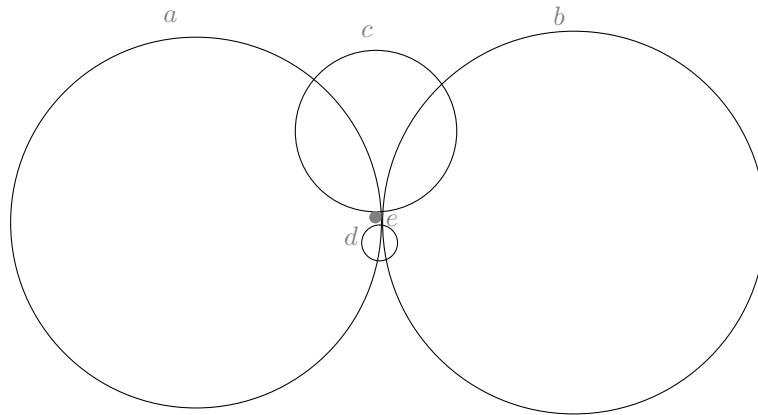

Figure 455:  $cd \rightarrow e, bd \rightarrow e, bc \rightarrow de, ac \rightarrow de, ab \rightarrow cde, a \rightarrow e$

456

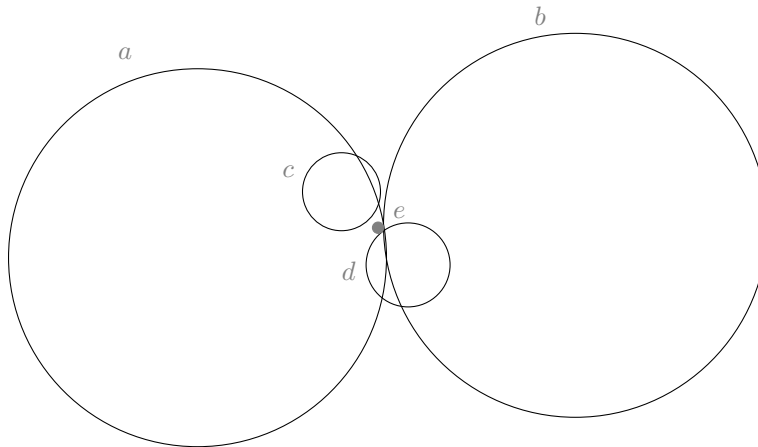

Figure 456:  $cd \rightarrow e, bd \rightarrow e, ad \rightarrow ce, bc \rightarrow de, ab \rightarrow cde, a \rightarrow e$

APPENDIX B.2: REPRESENTATION OF SIZE 5 GEOMETRIES

457

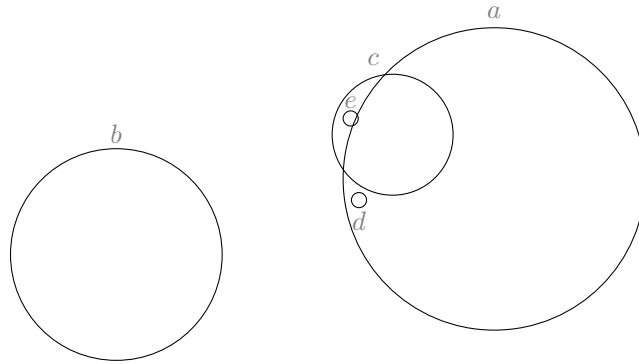

Figure 457:  $bc \rightarrow de, ac \rightarrow de, c \rightarrow e, ab \rightarrow cde, a \rightarrow d$

458

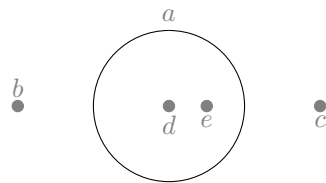

Figure 458:  $be \rightarrow d, cd \rightarrow e, bc \rightarrow de, a \rightarrow de$

459

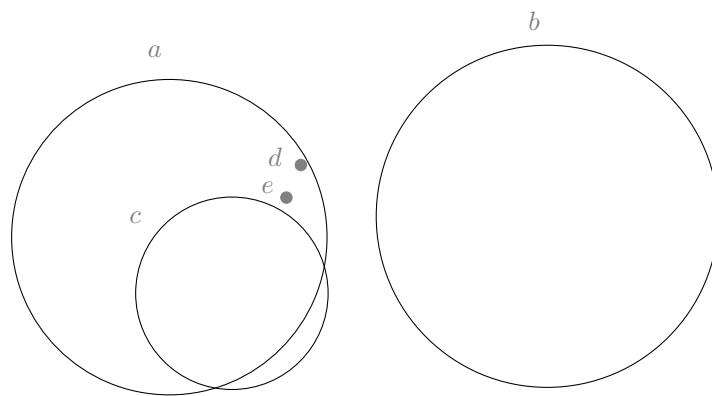

Figure 459:  $cd \rightarrow e, bc \rightarrow de, ab \rightarrow cde, a \rightarrow de$

460

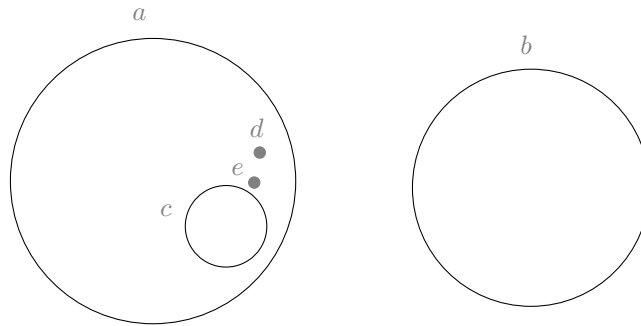

Figure 460:  $cd \rightarrow e, bc \rightarrow e, a \rightarrow cde$

461

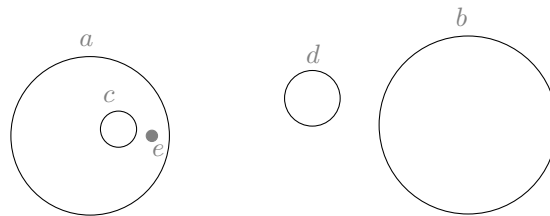

Figure 461:  $cd \rightarrow e, bc \rightarrow de, ab \rightarrow cde, a \rightarrow ce$

462

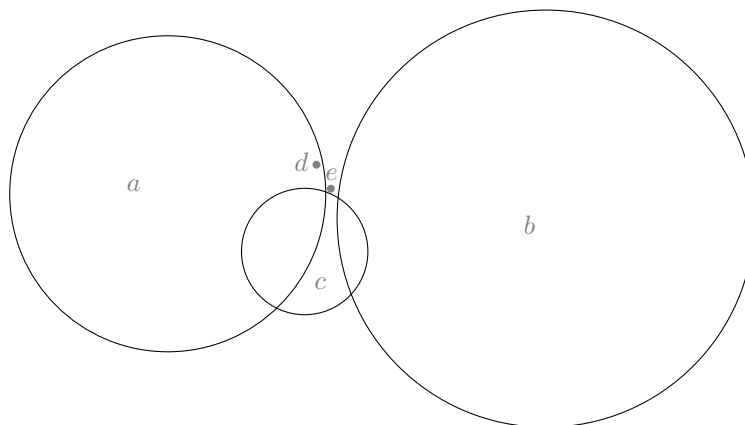

Figure 462:  $cd \rightarrow e, bd \rightarrow e, bc \rightarrow de, ac \rightarrow de, ab \rightarrow cde, a \rightarrow d$



463

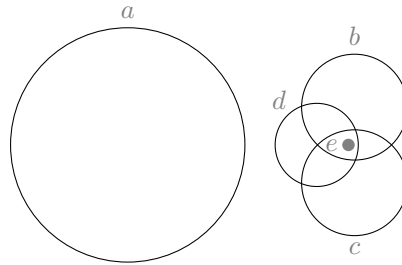

Figure 463:  $d \rightarrow e$ ,  $ac \rightarrow de$ ,  $c \rightarrow e$ ,  $ab \rightarrow de$ ,  $b \rightarrow e$

464

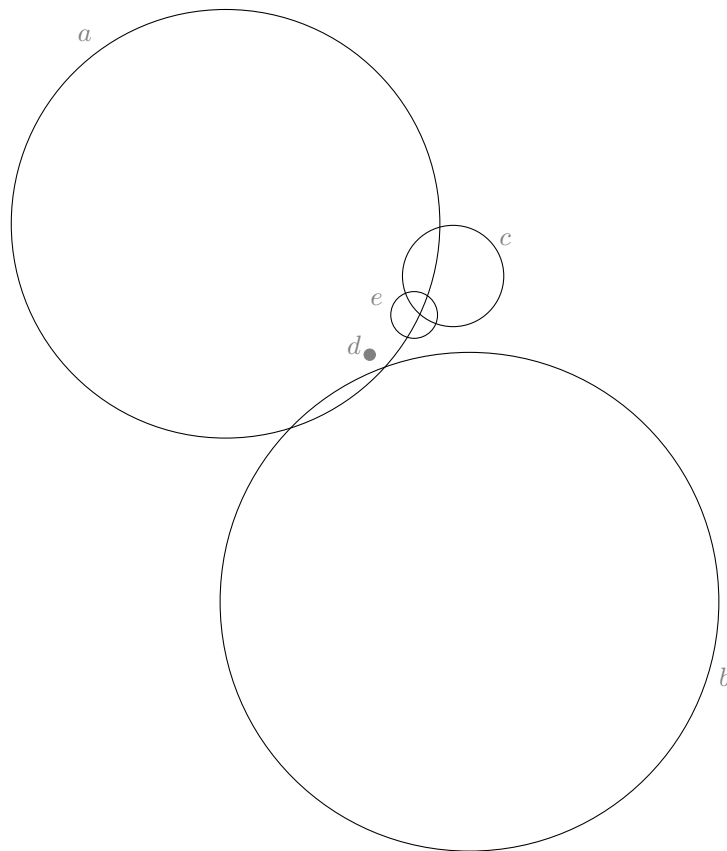

Figure 464:  $be \rightarrow d$ ,  $cd \rightarrow e$ ,  $bc \rightarrow de$ ,  $ac \rightarrow de$ ,  $ab \rightarrow cde$ ,  $a \rightarrow d$

APPENDIX B.2: REPRESENTATION OF SIZE 5 GEOMETRIES

465

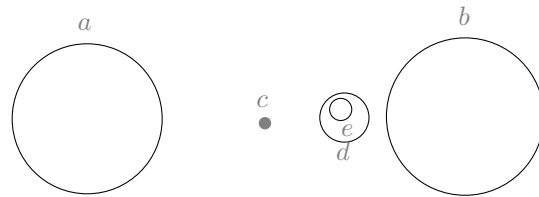

Figure 465:  $ae \rightarrow c, ad \rightarrow ce, d \rightarrow e, bc \rightarrow de, ab \rightarrow cde$

466

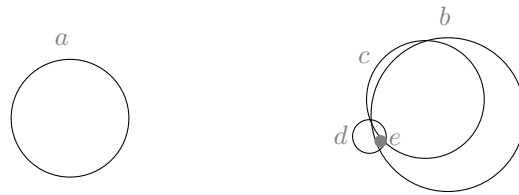

Figure 466:  $d \rightarrow e, ac \rightarrow de, ab \rightarrow cde, b \rightarrow e$

467

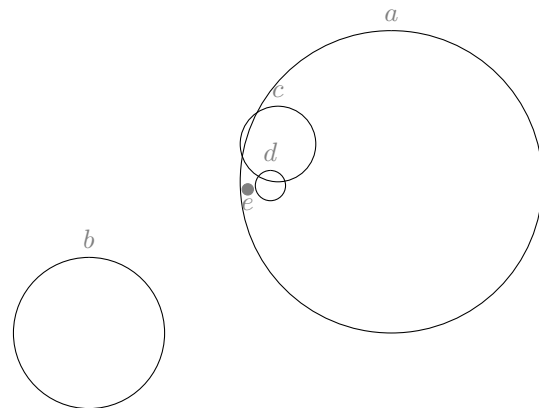

Figure 467:  $bd \rightarrow e, bc \rightarrow de, ab \rightarrow cde, a \rightarrow de$

APPENDIX B.2: REPRESENTATION OF SIZE 5 GEOMETRIES

468

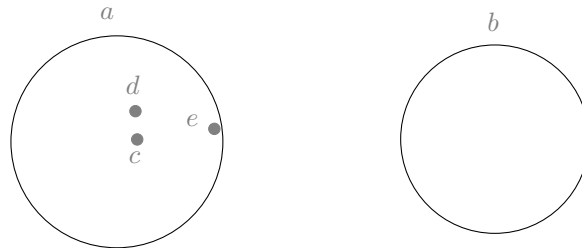

Figure 468:  $bd \rightarrow e, bc \rightarrow e, a \rightarrow cde$

469

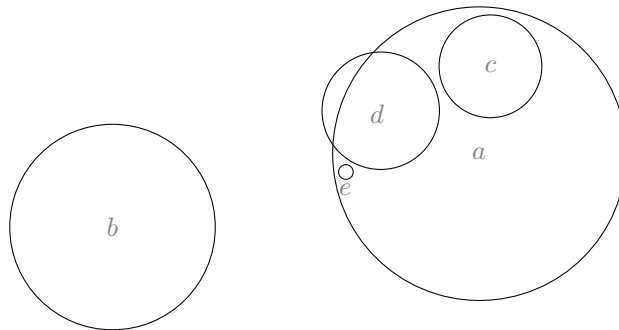

Figure 469:  $bd \rightarrow e, bc \rightarrow de, ab \rightarrow cde, a \rightarrow ce$

470

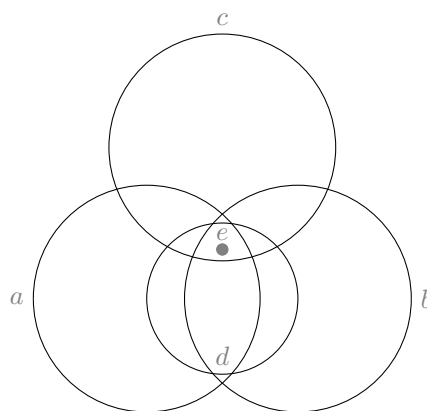

Figure 470:  $a \rightarrow e, b \rightarrow e, c \rightarrow e, d \rightarrow e, ab \rightarrow de$

APPENDIX B.2: REPRESENTATION OF SIZE 5 GEOMETRIES

471

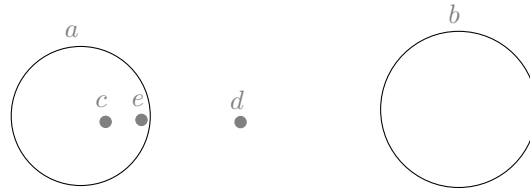

Figure 471:  $be \rightarrow d, bc \rightarrow de, ab \rightarrow cde, a \rightarrow ce$

472

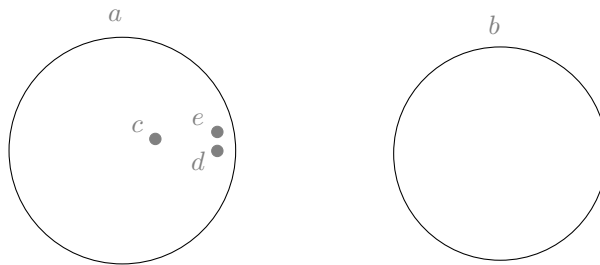

Figure 472:  $bc \rightarrow de, a \rightarrow cde$

473

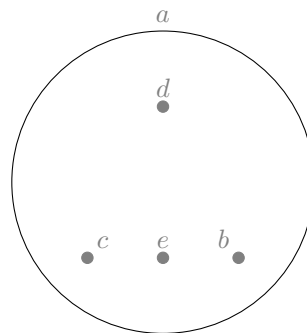

Figure 473:  $bc \rightarrow e, a \rightarrow bcde$

APPENDIX B.2: REPRESENTATION OF SIZE 5 GEOMETRIES

474

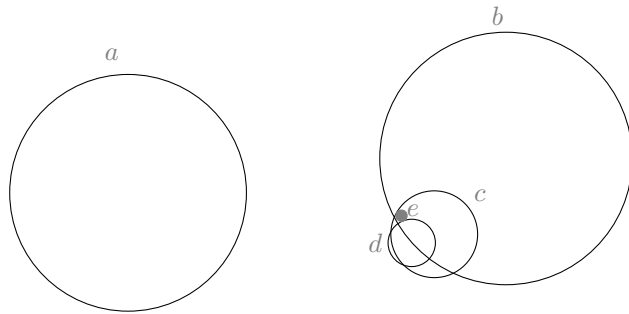

Figure 474:  $ad \rightarrow e, ac \rightarrow de, c \rightarrow e, ab \rightarrow cde, b \rightarrow e$

475

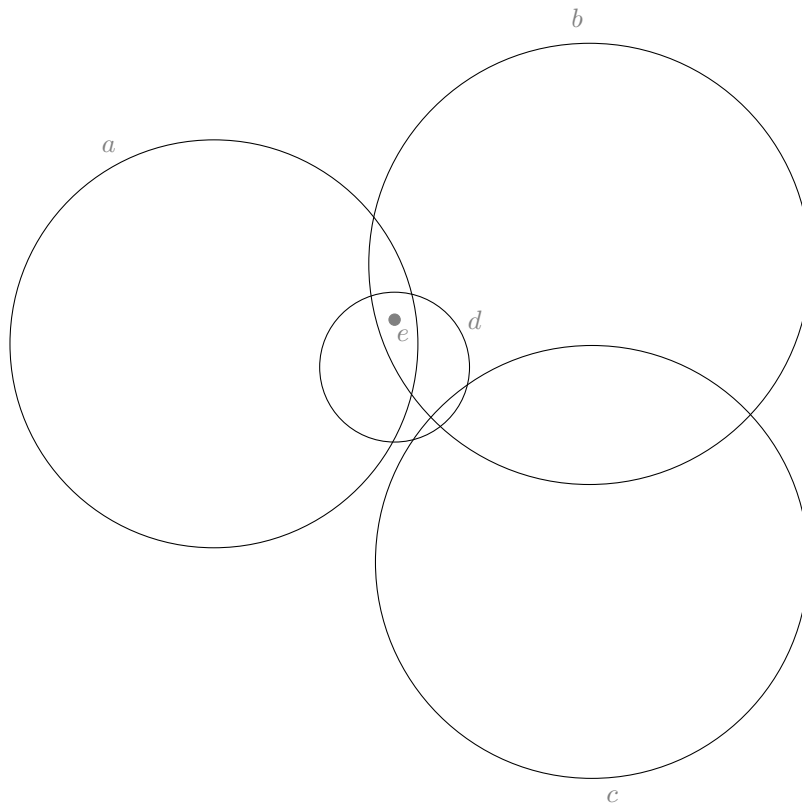

Figure 475:  $d \rightarrow e, ac \rightarrow de, ab \rightarrow de, b \rightarrow e, a \rightarrow e$

476

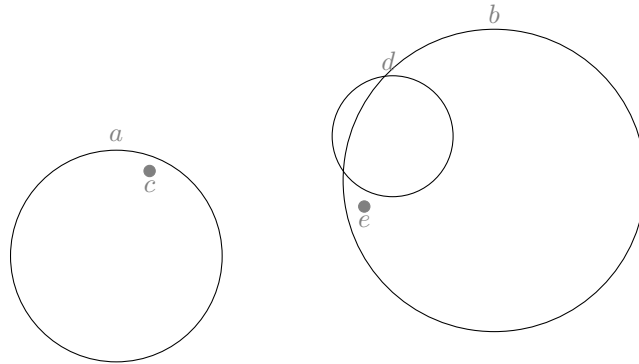

Figure 476:  $ad \rightarrow ce, bc \rightarrow de, ab \rightarrow cde, b \rightarrow e, a \rightarrow c$

477

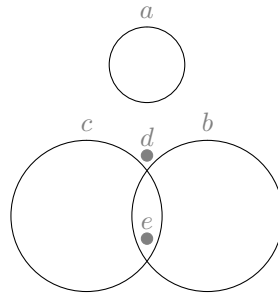

Figure 477:  $b \rightarrow e, c \rightarrow e, ab \rightarrow de, ac \rightarrow de, bc \rightarrow de, ae \rightarrow d$

478

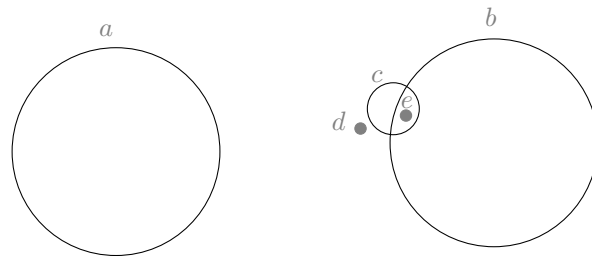

Figure 478:  $ae \rightarrow d, ac \rightarrow de, c \rightarrow e, ab \rightarrow cde, b \rightarrow e$

APPENDIX B.2: REPRESENTATION OF SIZE 5 GEOMETRIES

479

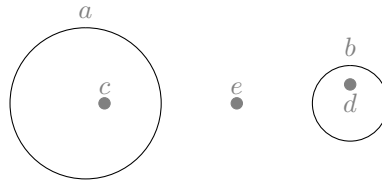

Figure 479:  $a \rightarrow c, bc \rightarrow e, ab \rightarrow e, b \rightarrow d, ad \rightarrow e$

480

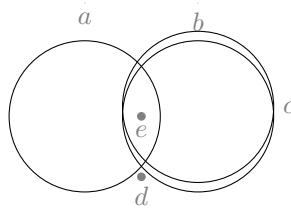

Figure 480:  $a \rightarrow e, b \rightarrow e, c \rightarrow e, ab \rightarrow de, ac \rightarrow de$

481

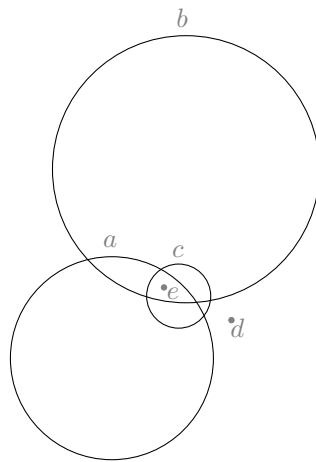

Figure 481:  $ab \rightarrow cd, a \rightarrow e, b \rightarrow e, c \rightarrow e$

482

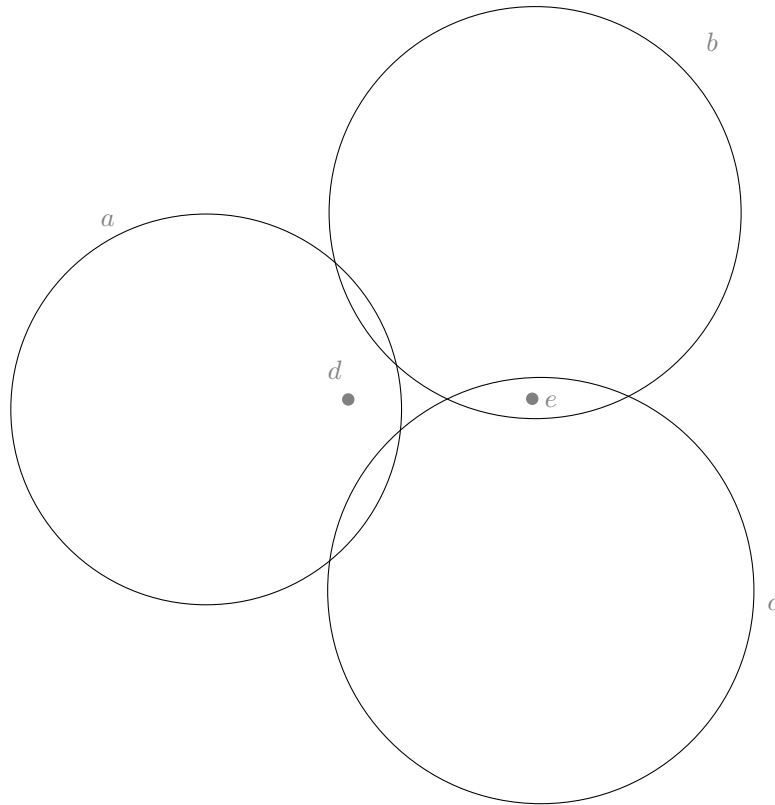

Figure 482:  $bc \rightarrow de, ac \rightarrow de, c \rightarrow e, ab \rightarrow de, b \rightarrow e, a \rightarrow d$

483

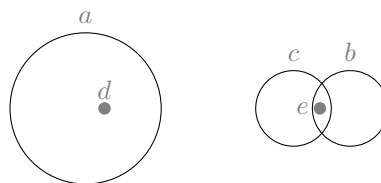

Figure 483:  $a \rightarrow d, b \rightarrow e, c \rightarrow e, ab \rightarrow c$



484

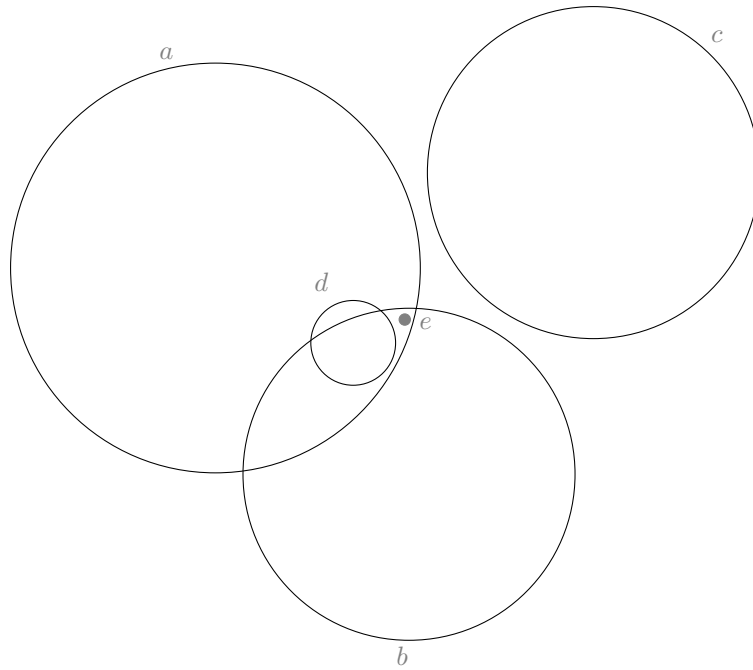

Figure 484:  $cd \rightarrow e, bc \rightarrow de, b \rightarrow e, a \rightarrow de$

APPENDIX B.2: REPRESENTATION OF SIZE 5 GEOMETRIES

485

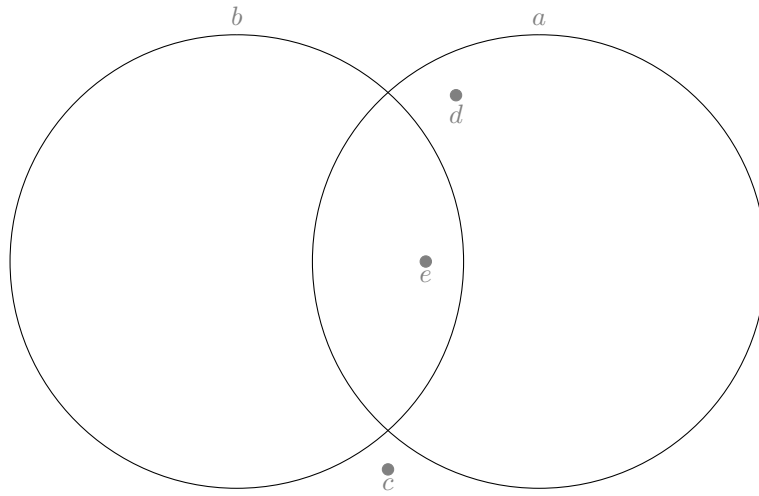

Figure 485:  $a \rightarrow e, ab \rightarrow cde, b \rightarrow e, cd \rightarrow e.$

486

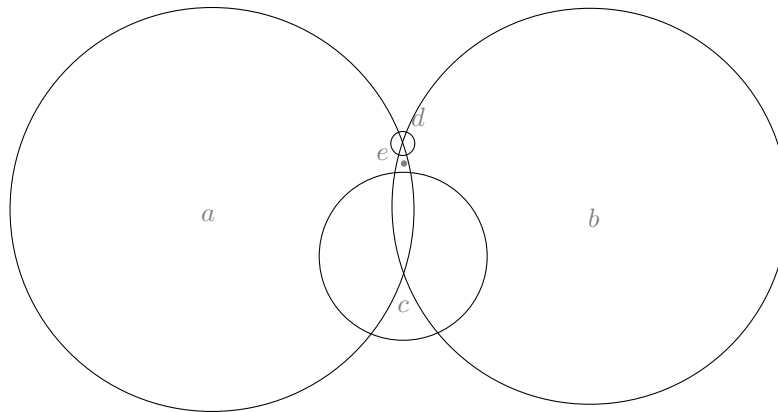

Figure 486:  $cd \rightarrow e, b \rightarrow e, bc \rightarrow de, ac \rightarrow de, ab \rightarrow cde, a \rightarrow e$

APPENDIX B.2: REPRESENTATION OF SIZE 5 GEOMETRIES

487

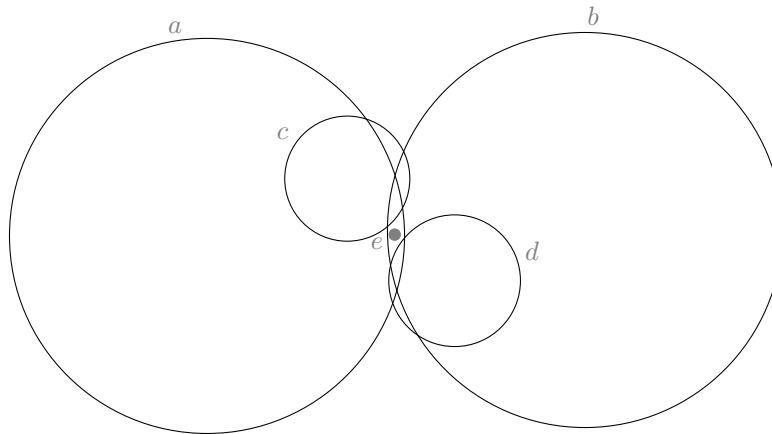

Figure 487:  $cd \rightarrow e, ad \rightarrow ce, bc \rightarrow de, ab \rightarrow cde, b \rightarrow e, a \rightarrow e$

488

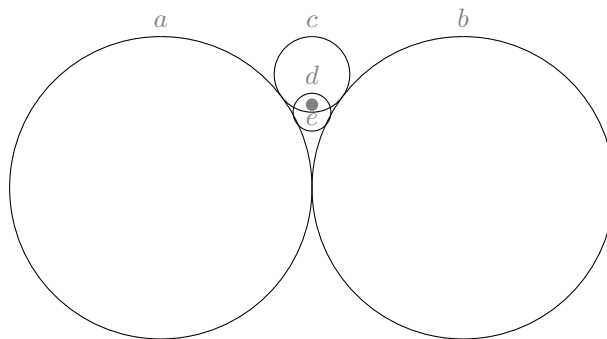

Figure 488:  $ac \rightarrow d, bc \rightarrow d, ab \rightarrow cd, c \rightarrow e, d \rightarrow e$

APPENDIX B.2: REPRESENTATION OF SIZE 5 GEOMETRIES

489

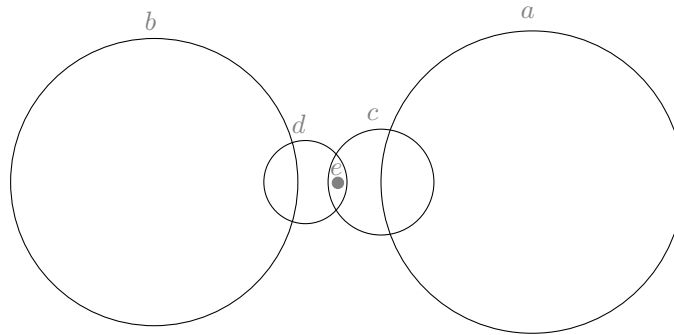

Figure 489:  $ad \rightarrow ce, d \rightarrow e, bc \rightarrow de, c \rightarrow e, ab \rightarrow cde$

490

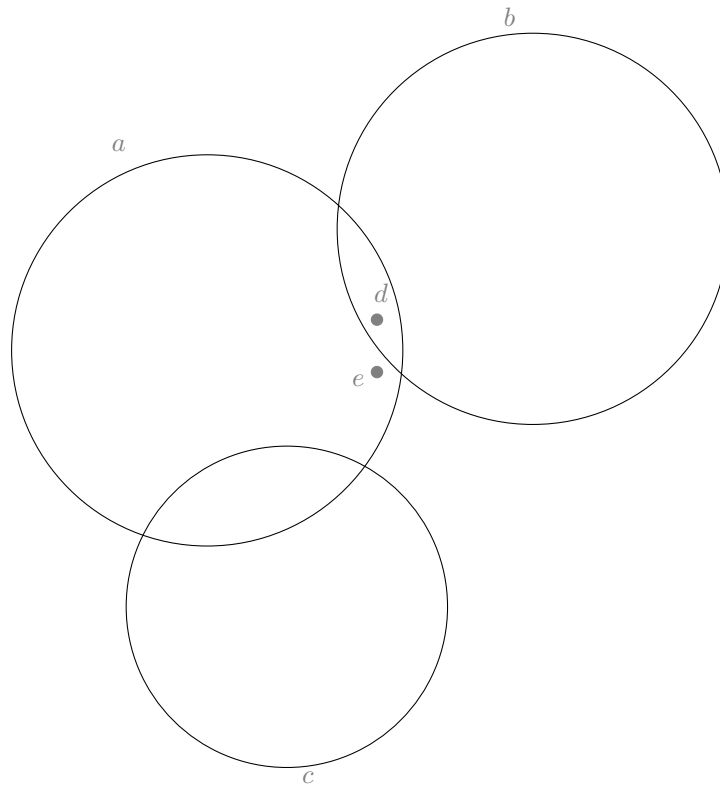

Figure 490:  $cd \rightarrow e, bc \rightarrow de, b \rightarrow d, a \rightarrow de$

APPENDIX B.2: REPRESENTATION OF SIZE 5 GEOMETRIES

491

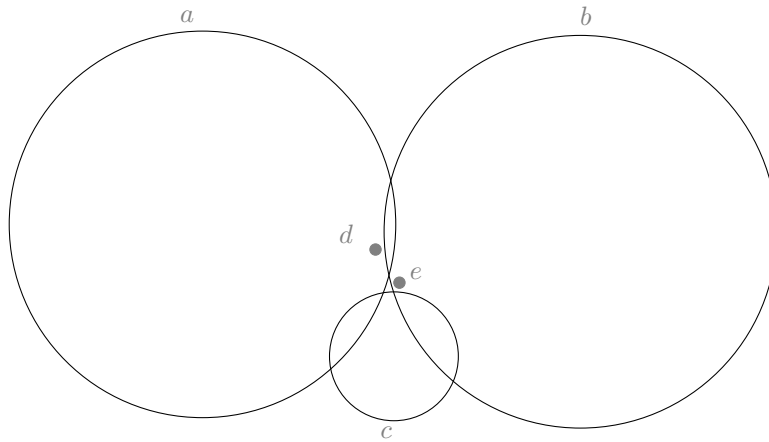

Figure 491:  $cd \rightarrow e, bc \rightarrow de, ac \rightarrow de, ab \rightarrow cde, b \rightarrow e, a \rightarrow d$

492

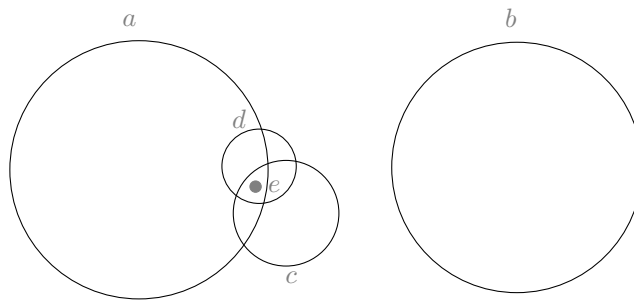

Figure 492:  $d \rightarrow e, ac \rightarrow de, c \rightarrow e, ab \rightarrow cde, a \rightarrow e$

493

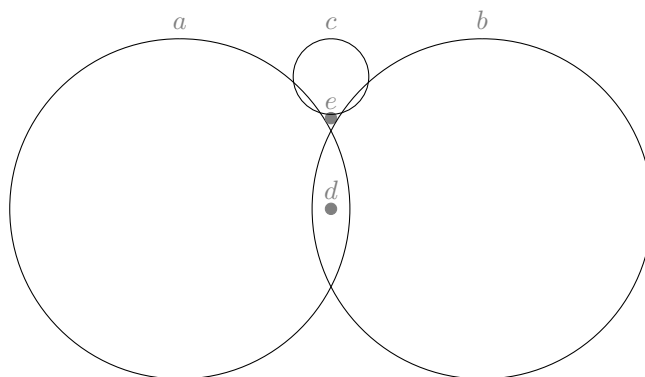

Figure 493:  $ac \rightarrow e, bc \rightarrow e, ab \rightarrow ce, a \rightarrow d, b \rightarrow d, cd \rightarrow e$

494

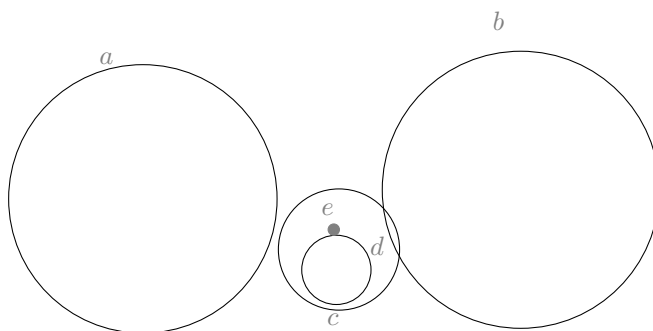

Figure 494:  $bd \rightarrow e, ad \rightarrow e, c \rightarrow de, ab \rightarrow cde$

495

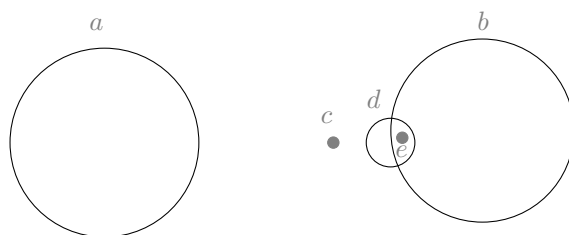

Figure 495:  $ae \rightarrow c, ad \rightarrow ce, d \rightarrow e, bc \rightarrow de, ab \rightarrow cde, b \rightarrow e$

496

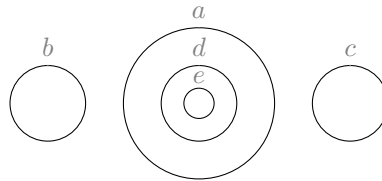

Figure 496:  $a \rightarrow de, bc \rightarrow de, d \rightarrow e$

497

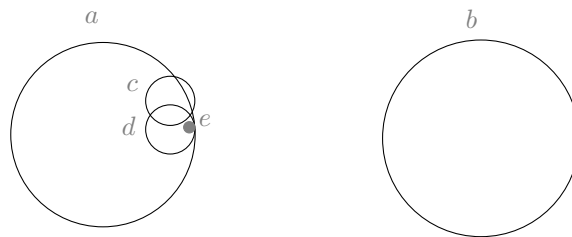

Figure 497:  $d \rightarrow e, bc \rightarrow e, ab \rightarrow cde, a \rightarrow de$

498

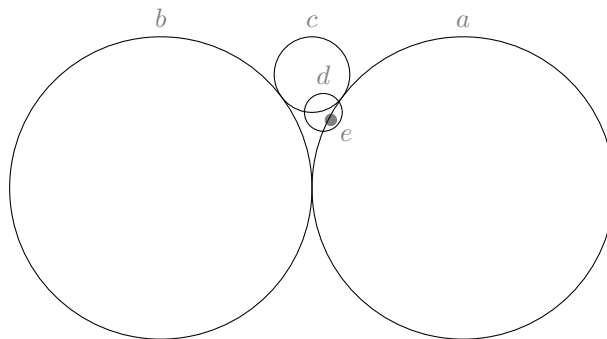

Figure 498:  $ac \rightarrow d, bc \rightarrow d, ab \rightarrow cd, a \rightarrow e, d \rightarrow e$

499

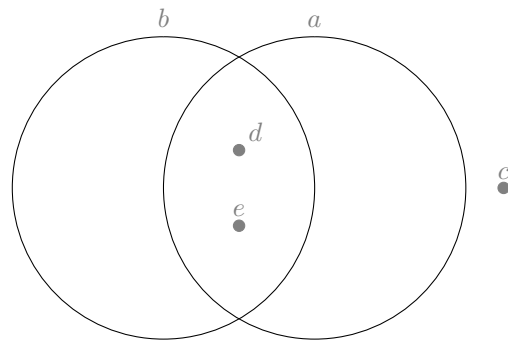

Figure 499:  $a \rightarrow de, b \rightarrow de$

500

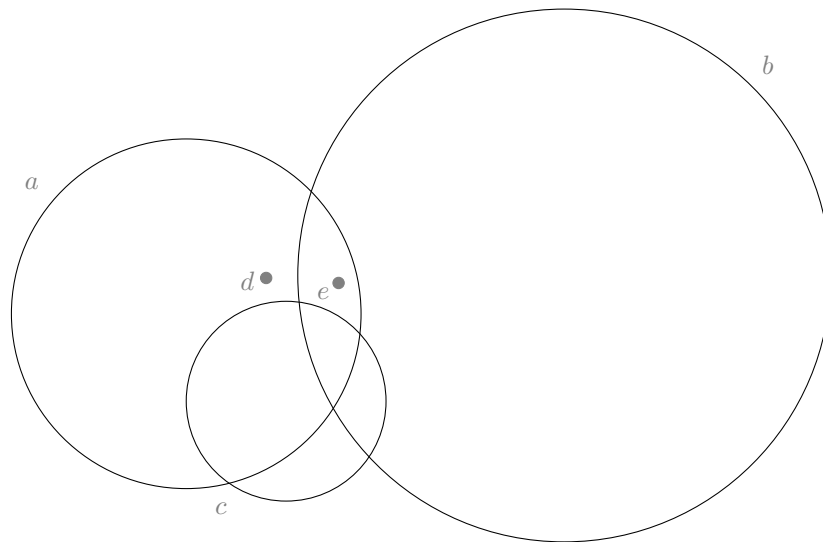

Figure 500:  $bc \rightarrow de, ab \rightarrow cde, b \rightarrow e, a \rightarrow de$



501

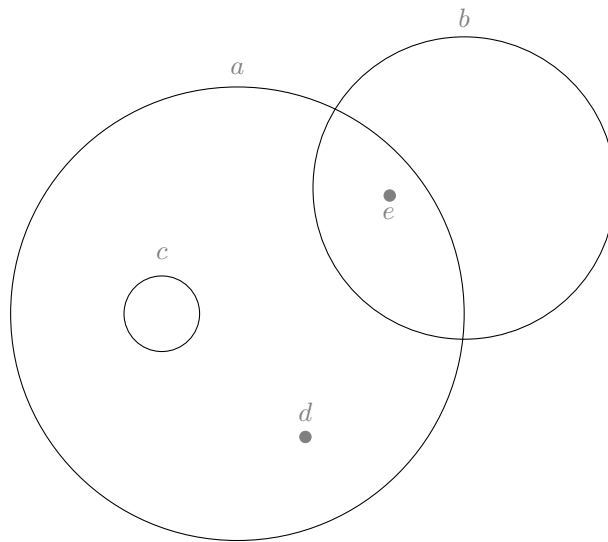

Figure 501:  $b \rightarrow e, a \rightarrow cde$

502

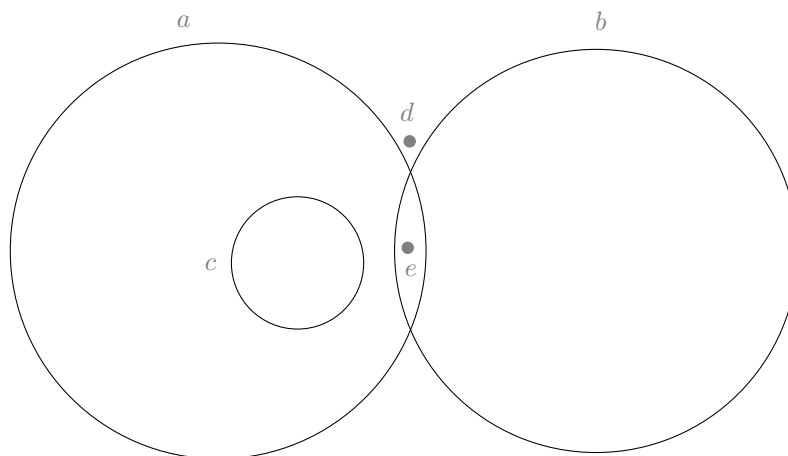

Figure 502:  $bc \rightarrow de, ab \rightarrow cde, b \rightarrow e, a \rightarrow ce$

503

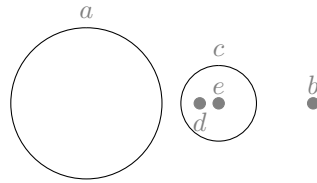

Figure 503:  $c \rightarrow de, ab \rightarrow cde, ae \rightarrow d, bd \rightarrow e$

504

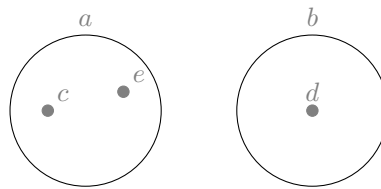

Figure 504:  $a \rightarrow ce, b \rightarrow d, bc \rightarrow e$

505

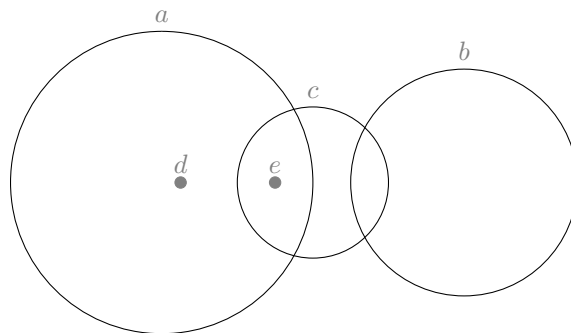

Figure 505:  $a \rightarrow de, c \rightarrow e, ab \rightarrow c, bd \rightarrow e$

506

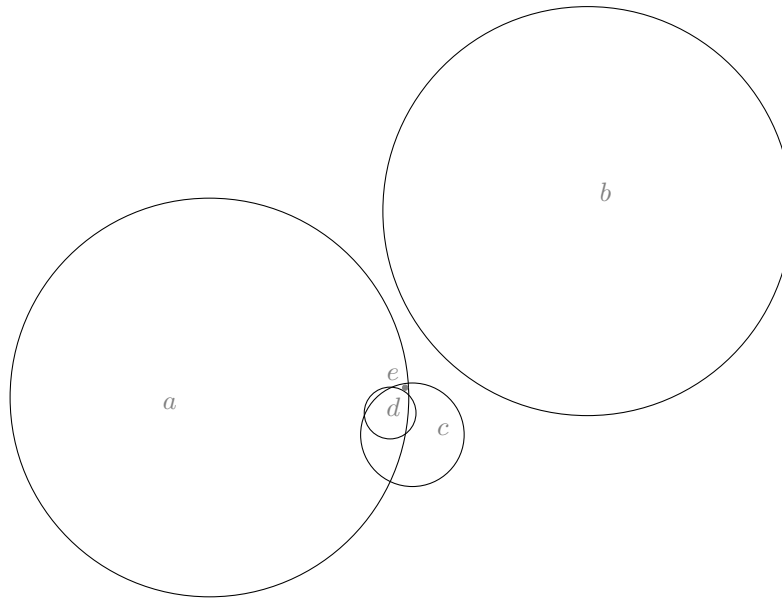

Figure 506:  $bd \rightarrow e, bc \rightarrow de, ac \rightarrow de, c \rightarrow e, ab \rightarrow cde, a \rightarrow e$

507

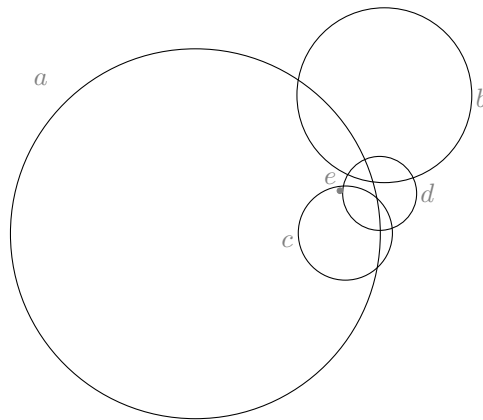

Figure 507:  $a \rightarrow e, c \rightarrow e, ab \rightarrow cde, ad \rightarrow ce, bc \rightarrow de, bd \rightarrow e$

508

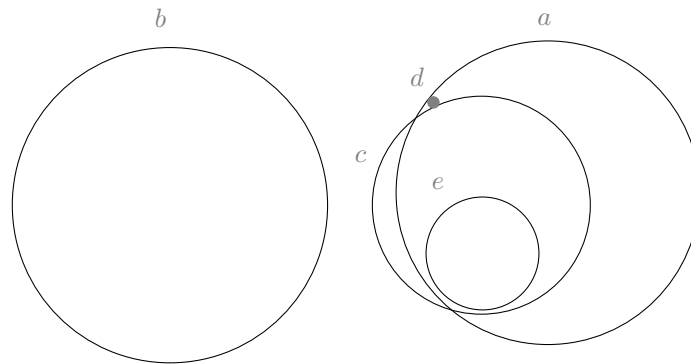

Figure 508:  $bc \rightarrow de, c \rightarrow e, ab \rightarrow cde, a \rightarrow de$

509

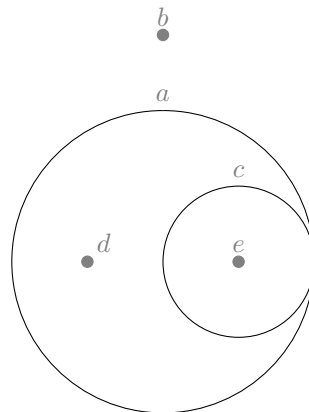

Figure 509:  $c \rightarrow e, a \rightarrow cde$

510

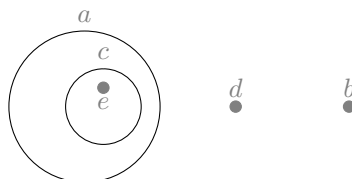

Figure 510:  $a \rightarrow ce, bc \rightarrow de, ab \rightarrow cde, c \rightarrow e$

511

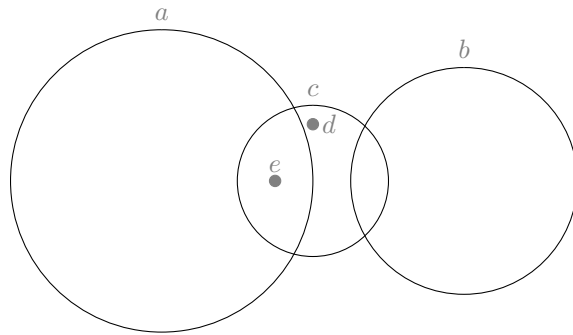

Figure 511:  $a \rightarrow e$ ,  $c \rightarrow de$ ,  $ab \rightarrow cde$

512

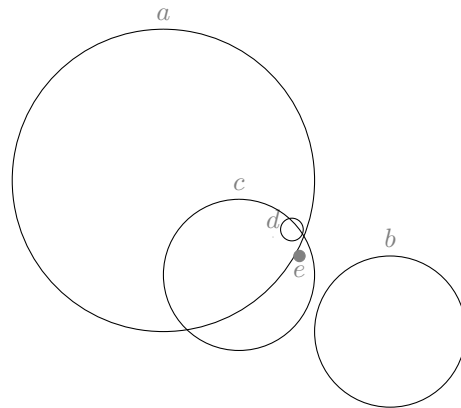

Figure 512:  $bd \rightarrow e$ ,  $bc \rightarrow de$ ,  $ac \rightarrow de$ ,  $c \rightarrow e$ ,  $ab \rightarrow cde$ ,  $a \rightarrow d$

APPENDIX B.2: REPRESENTATION OF SIZE 5 GEOMETRIES

513

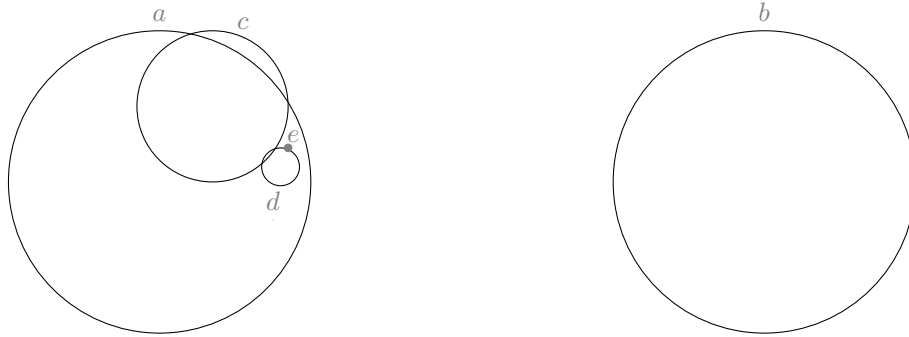

Figure 513:  $cd \rightarrow e$ ,  $bd \rightarrow e$ ,  $bc \rightarrow de$ ,  $ab \rightarrow cde$ ,  $a \rightarrow de$

514

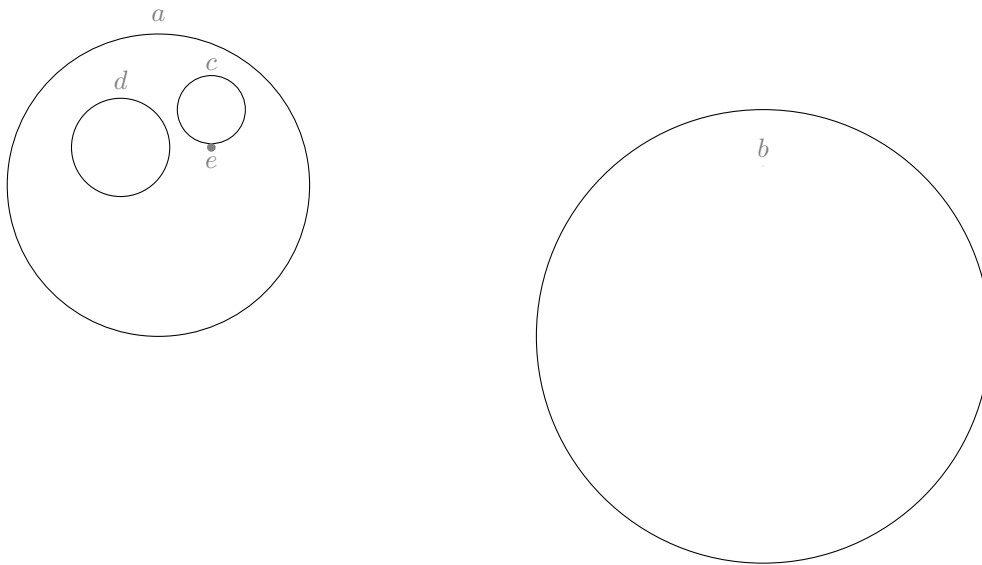

Figure 514:  $cd \rightarrow e$ ,  $bd \rightarrow e$ ,  $bc \rightarrow e$ ,  $a \rightarrow cde$

515

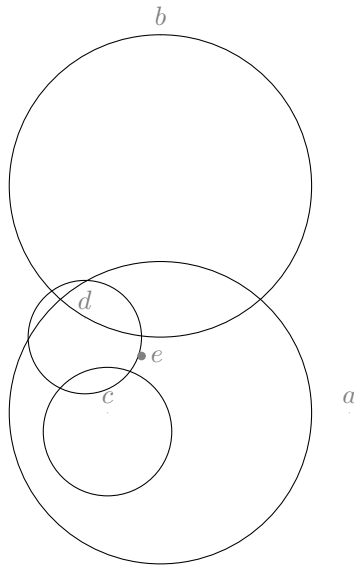

Figure 515:  $cd \rightarrow e$ ,  $bd \rightarrow e$ ,  $bc \rightarrow de$ ,  $ab \rightarrow cde$ ,  $a \rightarrow ce$

516

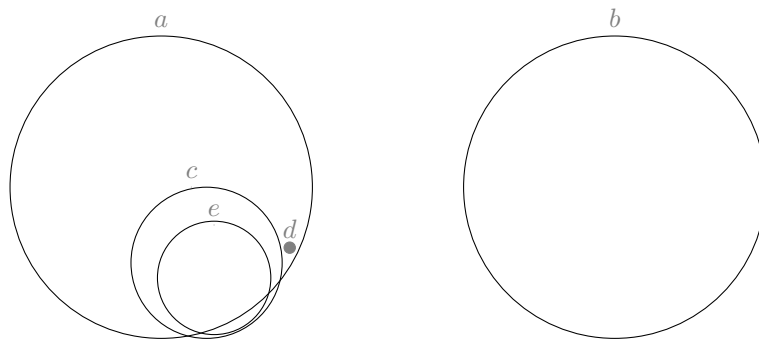

Figure 516:  $be \rightarrow d$ ,  $bc \rightarrow de$ ,  $c \rightarrow e$ ,  $ab \rightarrow cde$ ,  $a \rightarrow d$

517

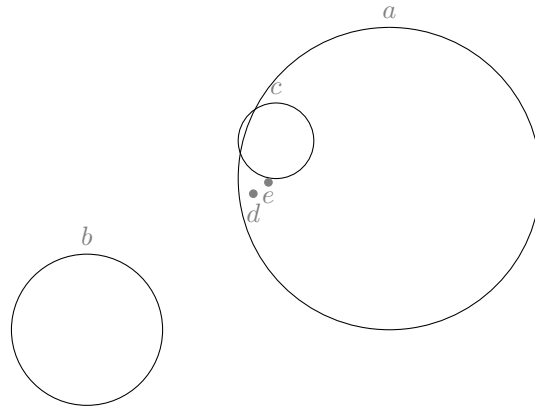

Figure 517:  $be \rightarrow d, cd \rightarrow e, bc \rightarrow de, ab \rightarrow cde, a \rightarrow de$

518

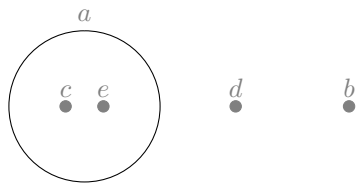

Figure 518:  $a \rightarrow ce, bc \rightarrow de, ab \rightarrow cde, be \rightarrow d, cd \rightarrow e$

519

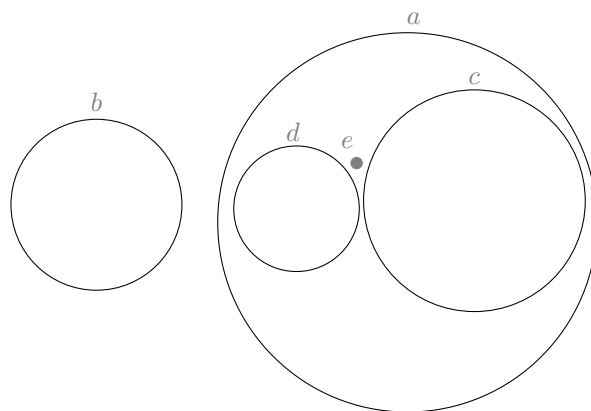

Figure 519:  $cd \rightarrow e, bc \rightarrow de, a \rightarrow cde$



520

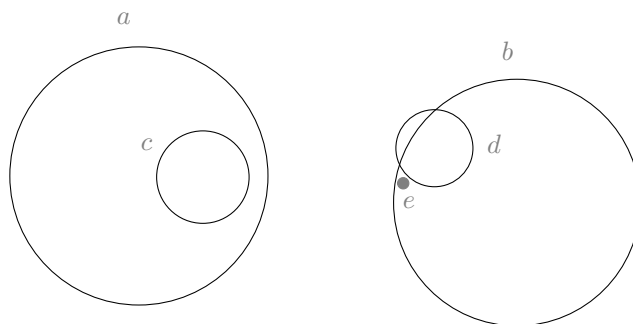

Figure 520:  $cd \rightarrow e, ad \rightarrow ce, bc \rightarrow de, ab \rightarrow cde, b \rightarrow e, a \rightarrow c$

521

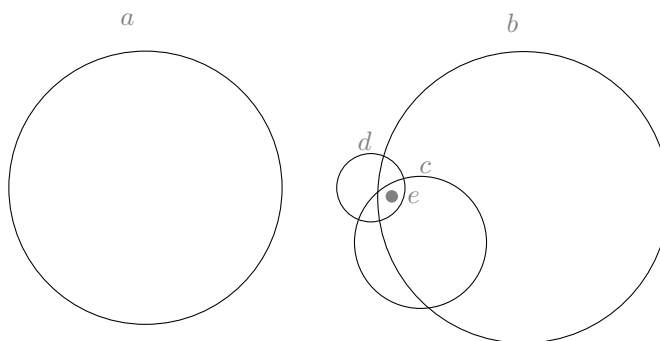

Figure 521:  $d \rightarrow e, ac \rightarrow de, c \rightarrow e, ab \rightarrow cde, b \rightarrow e$

522

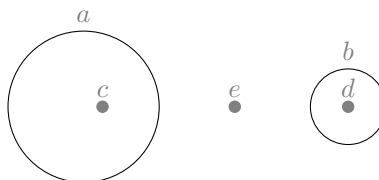

Figure 522:  $a \rightarrow c, bc \rightarrow de, ab \rightarrow cde, b \rightarrow d, cd \rightarrow e, ad \rightarrow ce$

APPENDIX B.2: REPRESENTATION OF SIZE 5 GEOMETRIES

523

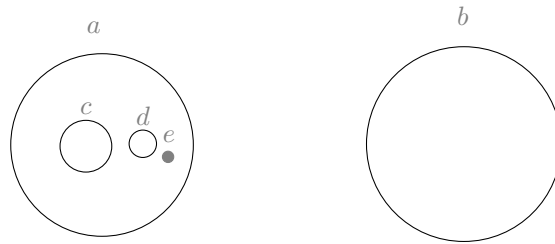

Figure 523:  $bd \rightarrow e, bc \rightarrow de, a \rightarrow cde$

524

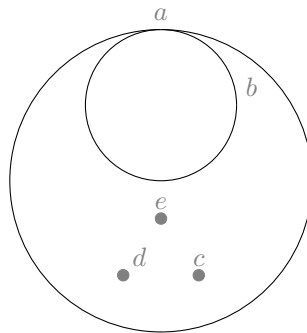

Figure 524:  $bc \rightarrow e, bd \rightarrow e, a \rightarrow bcde$

APPENDIX B.2: REPRESENTATION OF SIZE 5 GEOMETRIES

525

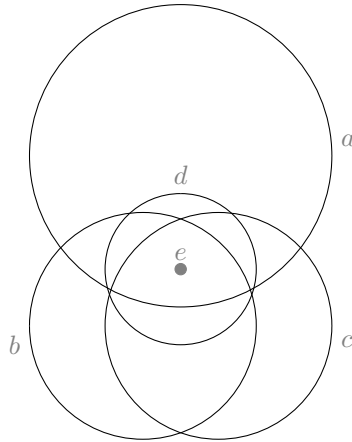

Figure 525:  $a \rightarrow e, b \rightarrow e, c \rightarrow e, d \rightarrow e, ab \rightarrow de, ac \rightarrow de$

526

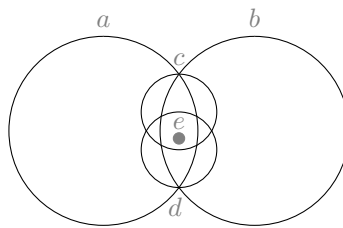

Figure 526:  $a \rightarrow e, b \rightarrow e, c \rightarrow e, d \rightarrow e, ab \rightarrow cde$

527

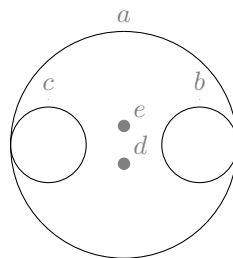

Figure 527:  $bc \rightarrow de, a \rightarrow bcde$

528

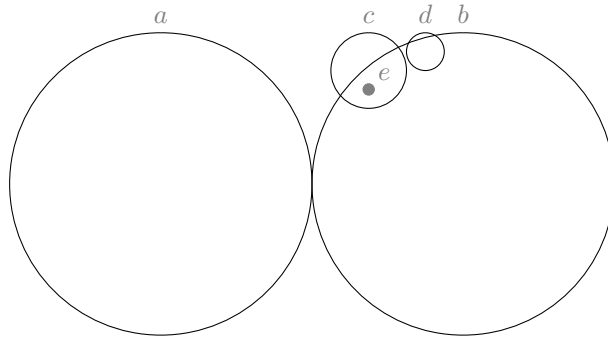

Figure 528:  $b \rightarrow e$ ,  $c \rightarrow e$ ,  $ad \rightarrow ce$ ,  $bc \rightarrow de$ ,  $ab \rightarrow cde$

529

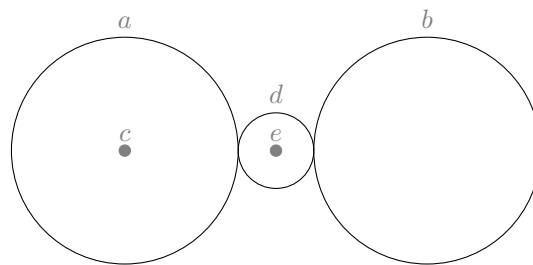

Figure 529:  $a \rightarrow c$ ,  $d \rightarrow e$ ,  $bc \rightarrow de$ ,  $ab \rightarrow cde$

530

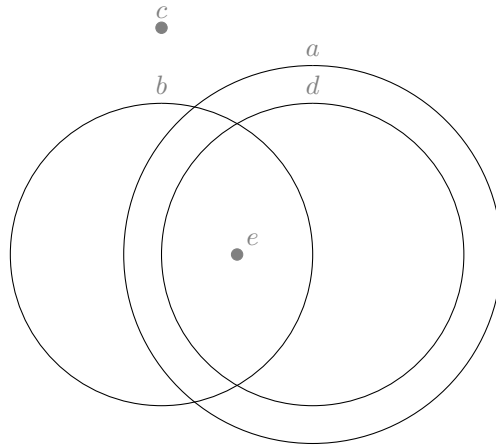

Figure 530:  $a \rightarrow de, b \rightarrow e, d \rightarrow e$

531

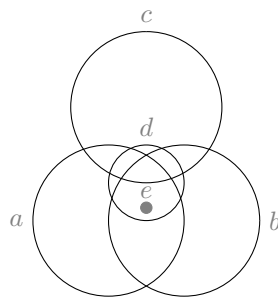

Figure 531:  $a \rightarrow e, b \rightarrow e, d \rightarrow e, ab \rightarrow de, ac \rightarrow de, bc \rightarrow de$

532

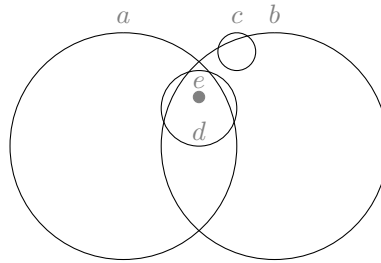

Figure 532:  $a \rightarrow e$ ,  $b \rightarrow e$ ,  $d \rightarrow e$ ,  $ac \rightarrow de$ ,  $ab \rightarrow cde$

533

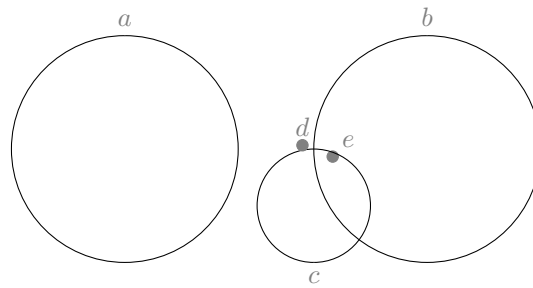

Figure 533:  $b \rightarrow e$ ,  $c \rightarrow e$ ,  $ac \rightarrow de$ ,  $bc \rightarrow de$ ,  $ae \rightarrow d$ ,  $ab \rightarrow cde$

534

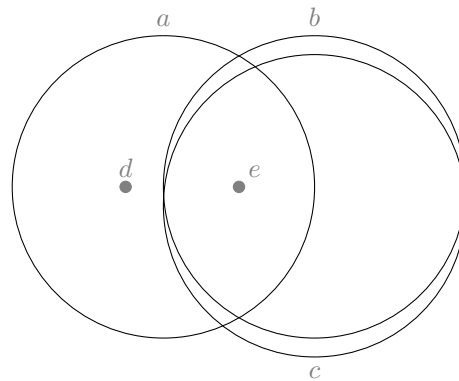

Figure 534:  $a \rightarrow de$ ,  $b \rightarrow e$ ,  $c \rightarrow e$

535

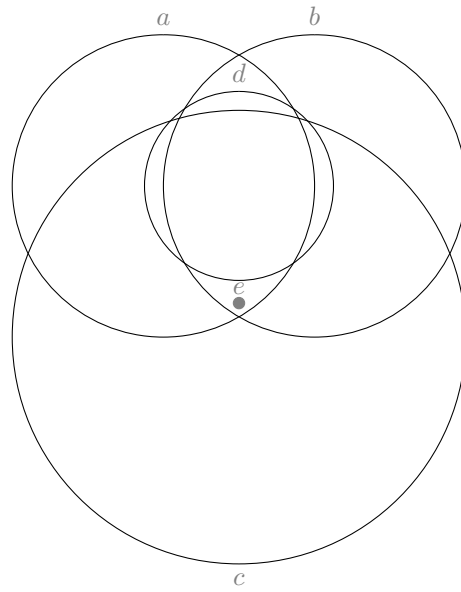

Figure 535:  $ac \rightarrow de, bc \rightarrow de, c \rightarrow e, b \rightarrow e, a \rightarrow e, ab \rightarrow de$

536

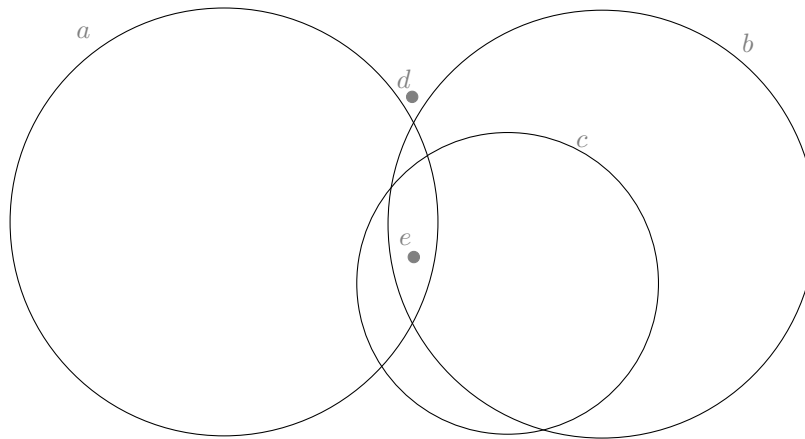

Figure 536:  $ac \rightarrow de, c \rightarrow e, ab \rightarrow cde, b \rightarrow e, a \rightarrow e$

APPENDIX B.2: REPRESENTATION OF SIZE 5 GEOMETRIES

537

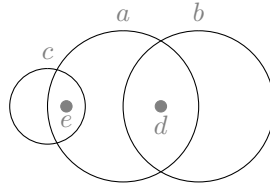

Figure 537:  $a \rightarrow de, b \rightarrow d, c \rightarrow e$

538

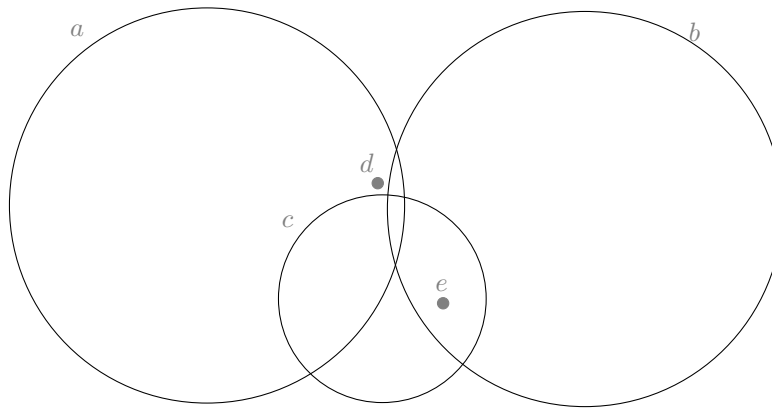

Figure 538:  $bc \rightarrow de, c \rightarrow e, ab \rightarrow cde, b \rightarrow e, a \rightarrow d$

539

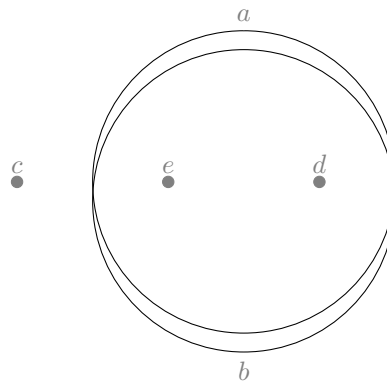

Figure 539:  $a \rightarrow de, b \rightarrow de, cd \rightarrow e$



APPENDIX B.2: REPRESENTATION OF SIZE 5 GEOMETRIES

540

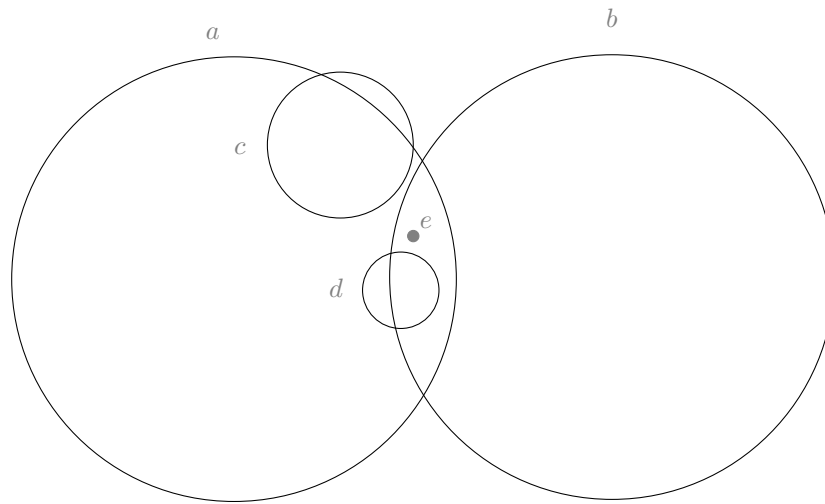

Figure 540:  $cd \rightarrow e, bc \rightarrow de, ab \rightarrow cde, b \rightarrow e, a \rightarrow de$

541

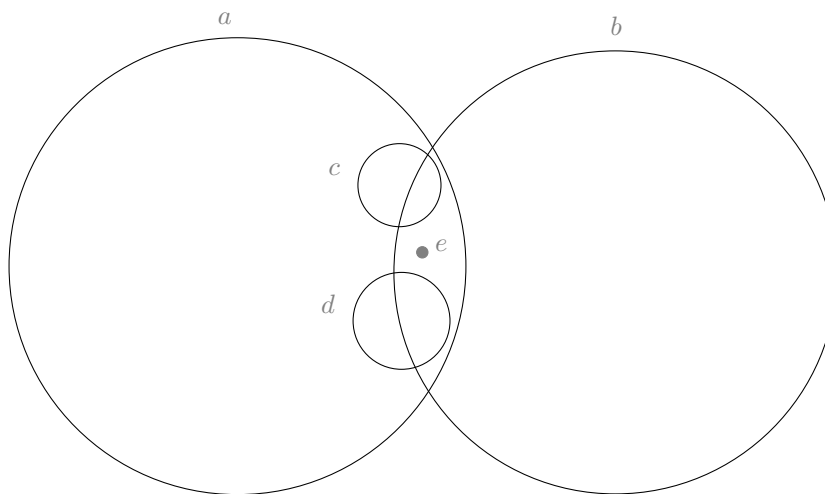

Figure 541:  $cd \rightarrow e, b \rightarrow e, a \rightarrow cde$

542

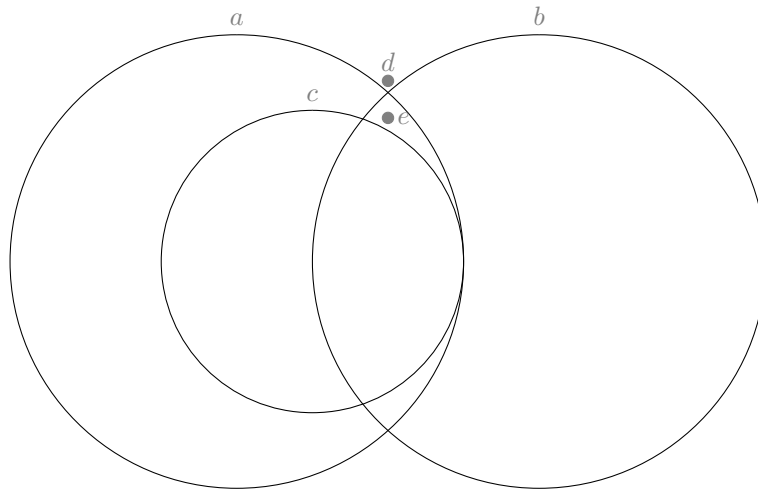

Figure 542:  $cd \rightarrow e, bc \rightarrow de, ab \rightarrow cde, b \rightarrow e, a \rightarrow ce$ .

543

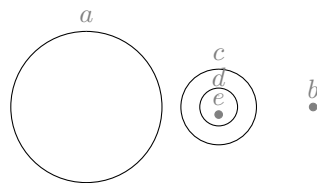

Figure 543:  $c \rightarrow de, ab \rightarrow cde, d \rightarrow e$

544

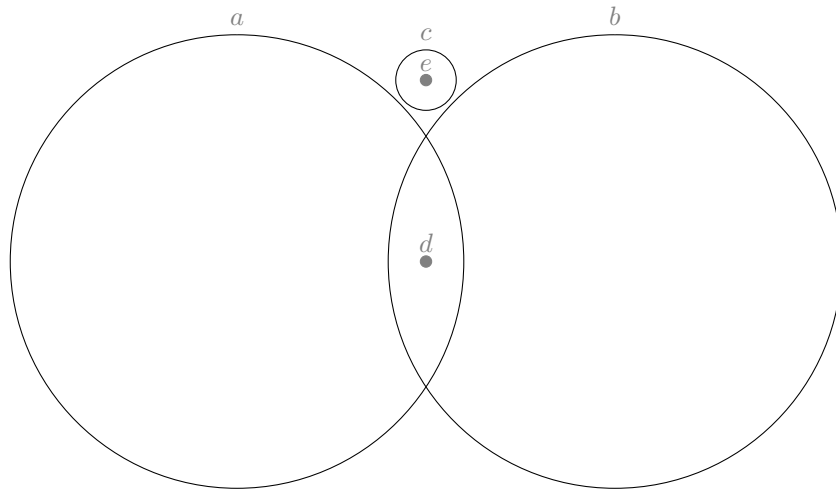

Figure 544:  $c \rightarrow e, ab \rightarrow cde, b \rightarrow d, a \rightarrow d$

545

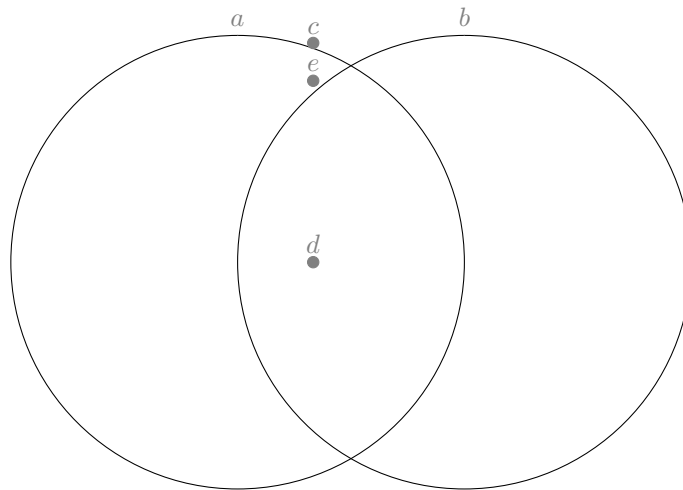

Figure 545:  $cd \rightarrow e, bc \rightarrow de, ab \rightarrow cde, b \rightarrow d, a \rightarrow de$

APPENDIX B.2: REPRESENTATION OF SIZE 5 GEOMETRIES

546

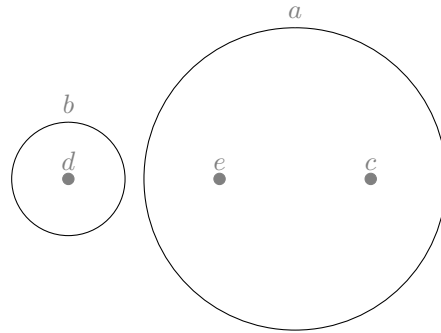

Figure 546:  $a \rightarrow ce$ ,  $bc \rightarrow de$ ,  $cd \rightarrow e$ ,  $b \rightarrow d$

547

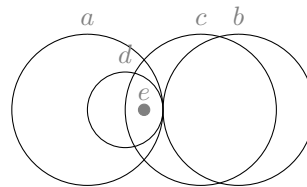

Figure 547:  $a \rightarrow de$ ,  $ab \rightarrow cde$ ,  $c \rightarrow e$ ,  $d \rightarrow e$

548

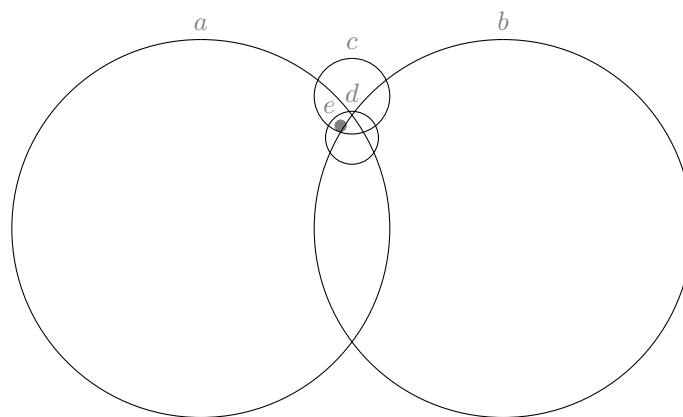

Figure 548:  $ac \rightarrow de$ ,  $bc \rightarrow de$ ,  $ab \rightarrow cde$ ,  $a \rightarrow e$ ,  $c \rightarrow e$ ,  $d \rightarrow e$

549

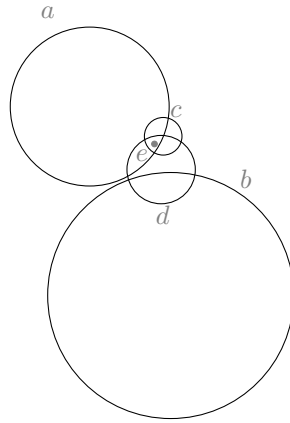

Figure 549:  $a \rightarrow e, c \rightarrow e, d \rightarrow e, ab \rightarrow cde, ad \rightarrow ce, bc \rightarrow de$

550

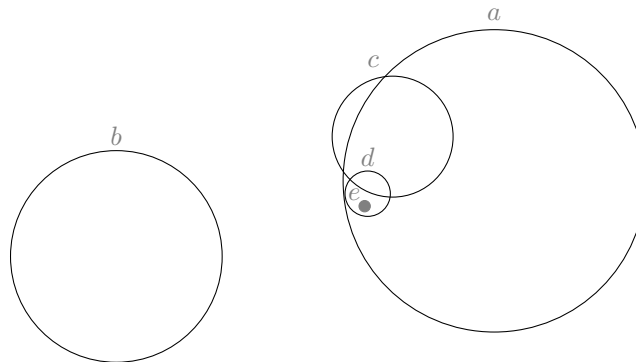

Figure 550:  $bc \rightarrow de, d \rightarrow e, ab \rightarrow cde, a \rightarrow de$

APPENDIX B.2: REPRESENTATION OF SIZE 5 GEOMETRIES

551

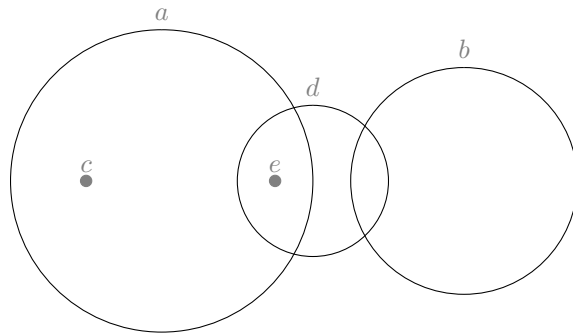

Figure 551:  $a \rightarrow ce$ ,  $d \rightarrow e$ ,  $ab \rightarrow de$ ,  $bc \rightarrow de$

552

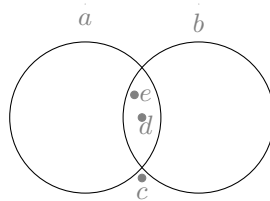

Figure 552:  $a \rightarrow de$ ,  $b \rightarrow de$ ,  $ab \rightarrow cde$

553

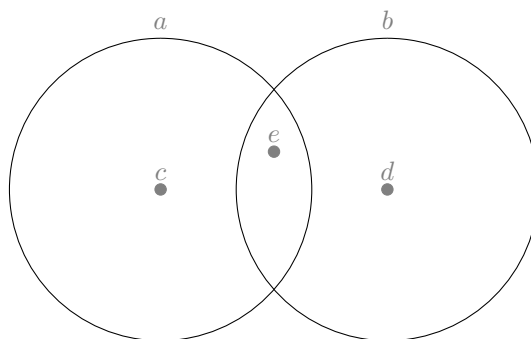

Figure 553:  $a \rightarrow ce$ ,  $b \rightarrow de$

APPENDIX B.2: REPRESENTATION OF SIZE 5 GEOMETRIES

554

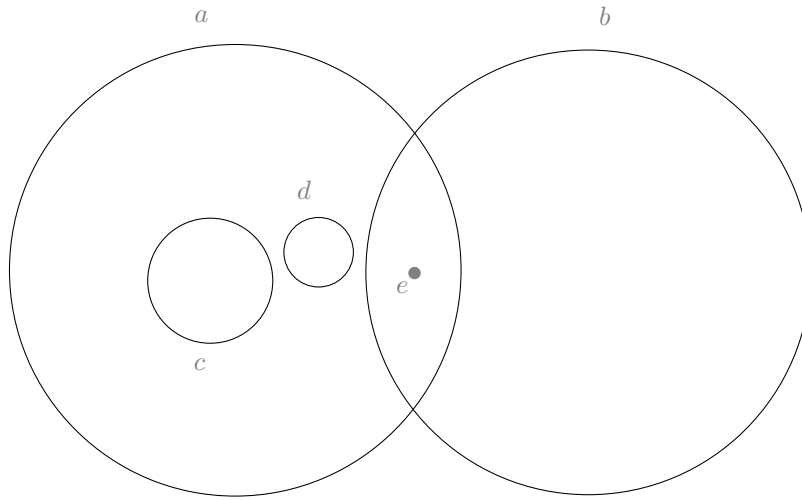

Figure 554:  $bc \rightarrow de, b \rightarrow e, a \rightarrow cde$

555

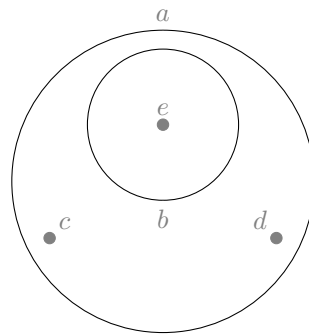

Figure 555:  $b \rightarrow e, a \rightarrow bcde$

556

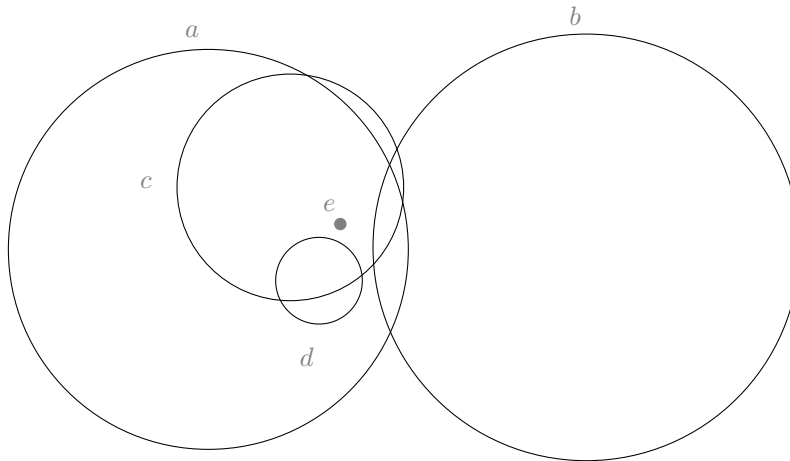

Figure 556:  $bd \rightarrow e, bc \rightarrow de, c \rightarrow e, ab \rightarrow cde, a \rightarrow de$

557

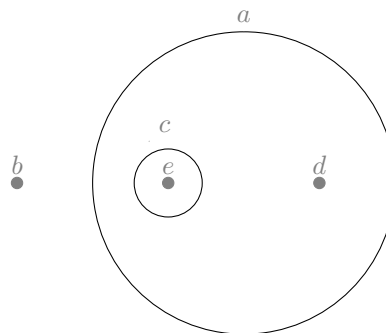

Figure 557:  $a \rightarrow cde, bd \rightarrow e, c \rightarrow e$



APPENDIX B.2: REPRESENTATION OF SIZE 5 GEOMETRIES

558

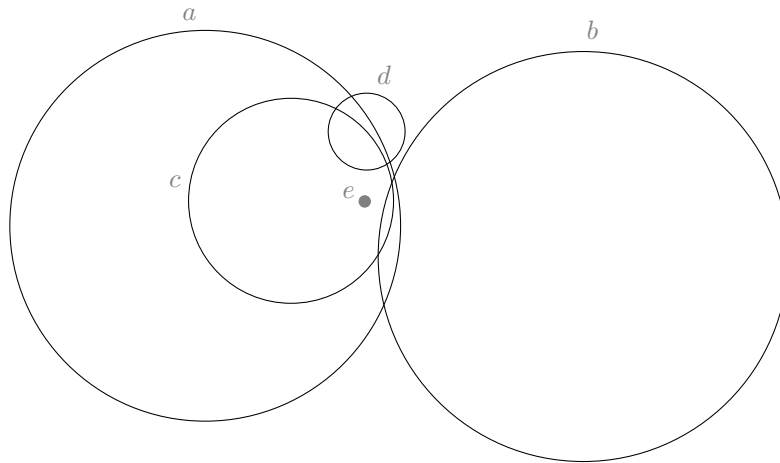

Figure 558:  $bd \rightarrow e, bc \rightarrow de, c \rightarrow e, ab \rightarrow cde, a \rightarrow ce$

559

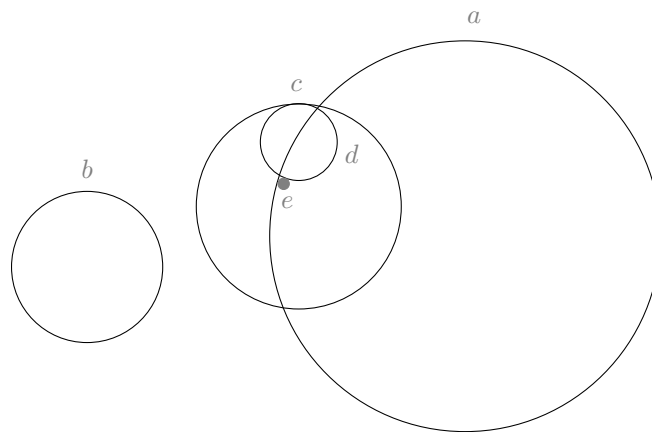

Figure 559:  $bd \rightarrow e, c \rightarrow de, ab \rightarrow cde, a \rightarrow e$

APPENDIX B.2: REPRESENTATION OF SIZE 5 GEOMETRIES

560



Figure 560:  $a \rightarrow c, b \rightarrow e, d \rightarrow e, bc \rightarrow d, ab \rightarrow d$

561

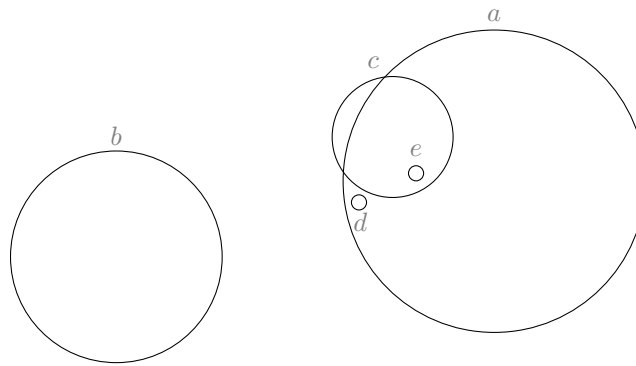

Figure 561:  $be \rightarrow d, bc \rightarrow de, c \rightarrow e, ab \rightarrow cde, a \rightarrow de$

562

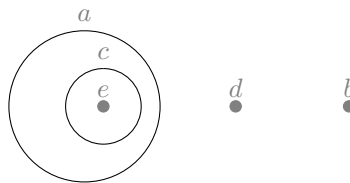

Figure 562:  $a \rightarrow c, bc \rightarrow d, ab \rightarrow d, c \rightarrow e, be \rightarrow d$

APPENDIX B.2: REPRESENTATION OF SIZE 5 GEOMETRIES

563

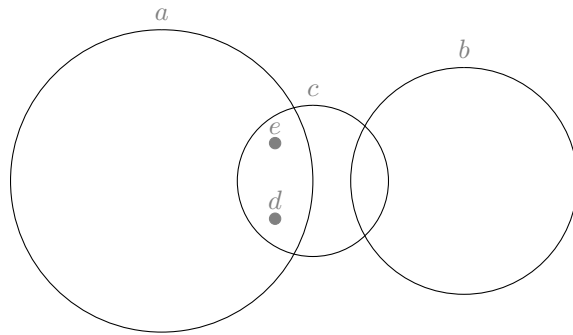

Figure 563:  $a \rightarrow de$ ,  $c \rightarrow de$ ,  $ab \rightarrow cd$

564

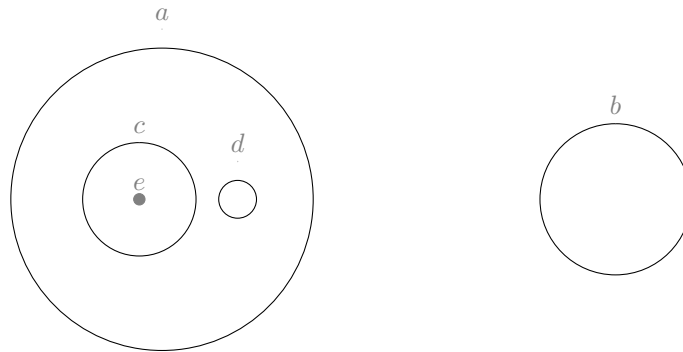

Figure 564:  $bc \rightarrow de$ ,  $c \rightarrow e$ ,  $a \rightarrow cde$

565

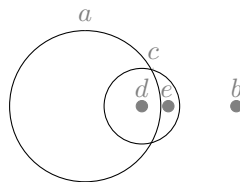

Figure 565:  $c \rightarrow de$ ,  $ab \rightarrow cde$ ,  $a \rightarrow d$ ,  $bd \rightarrow e$

566

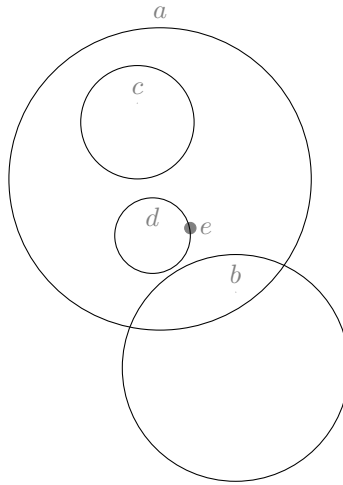

Figure 566:  $cd \rightarrow e, bd \rightarrow e, bc \rightarrow de, a \rightarrow cde$

567

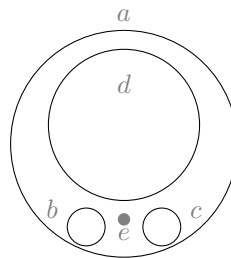

Figure 567:  $bd \rightarrow e, cd \rightarrow e, bc \rightarrow e, a \rightarrow bcde$

568

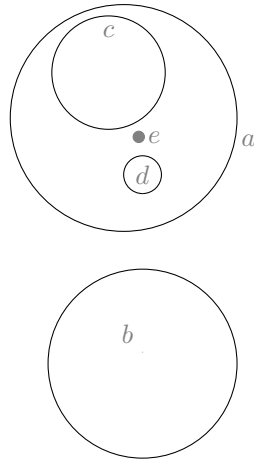

Figure 568:  $be \rightarrow d, cd \rightarrow e, bc \rightarrow de, a \rightarrow cde$

569

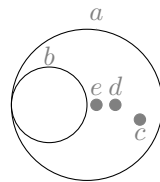

Figure 569:  $bd \rightarrow e, bc \rightarrow de, a \rightarrow bcde$

APPENDIX B.2: REPRESENTATION OF SIZE 5 GEOMETRIES

570

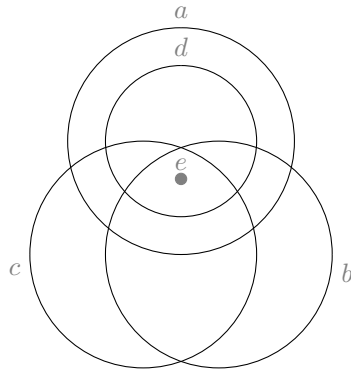

Figure 570:  $a \rightarrow de, b \rightarrow e, c \rightarrow e, d \rightarrow e$

571

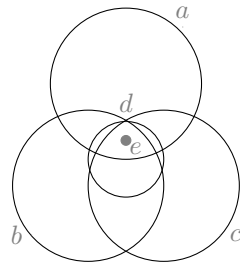

Figure 571:  $a \rightarrow e, b \rightarrow e, c \rightarrow e, d \rightarrow e, ab \rightarrow de, ac \rightarrow de, bc \rightarrow de$

572

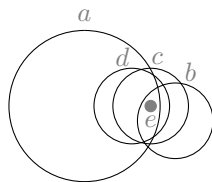

Figure 572:  $a \rightarrow e, b \rightarrow e, c \rightarrow e, d \rightarrow e, ab \rightarrow cde, ac \rightarrow de$

APPENDIX B.2: REPRESENTATION OF SIZE 5 GEOMETRIES

573

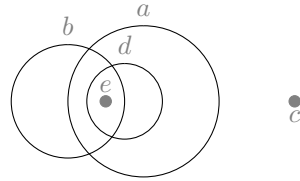

Figure 573:  $d \rightarrow e, bc \rightarrow de, b \rightarrow e, a \rightarrow de$

574

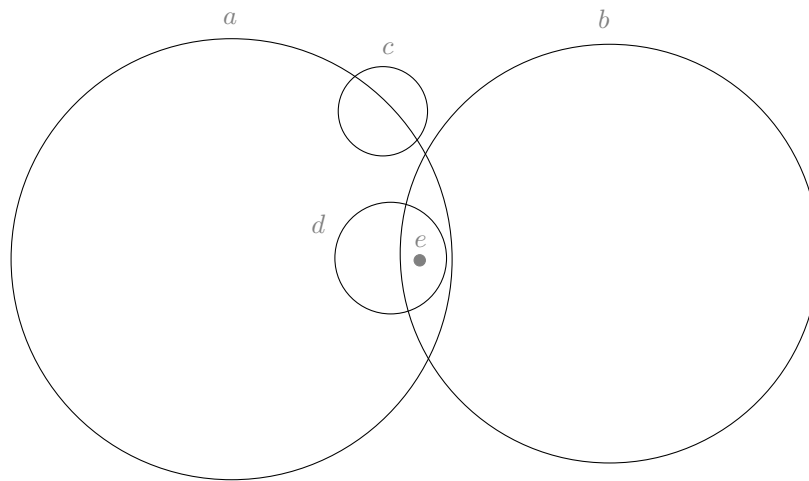

Figure 574:  $d \rightarrow e, ab \rightarrow cde, b \rightarrow e, a \rightarrow de$

APPENDIX B.2: REPRESENTATION OF SIZE 5 GEOMETRIES

575

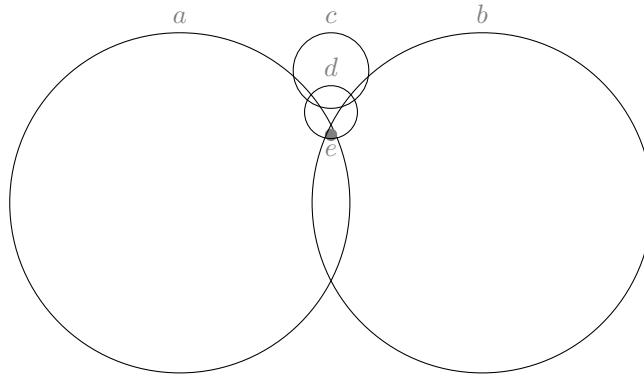

Figure 575:  $ac \rightarrow d, bc \rightarrow d, ab \rightarrow cd, a \rightarrow e, b \rightarrow e, d \rightarrow e$

576

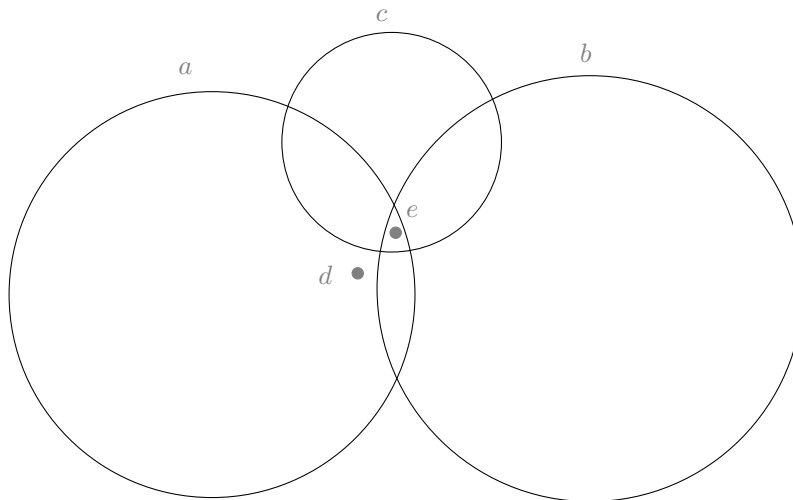

Figure 576:  $bc \rightarrow de, c \rightarrow e, b \rightarrow e, a \rightarrow de$



APPENDIX B.2: REPRESENTATION OF SIZE 5 GEOMETRIES

577

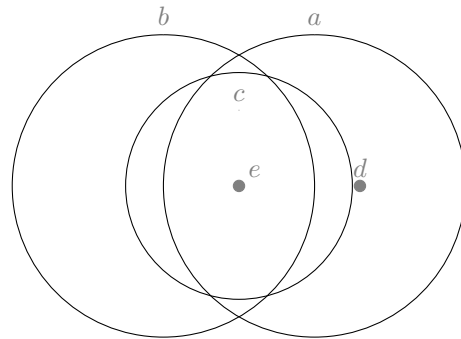

Figure 577:  $a \rightarrow de, b \rightarrow e, c \rightarrow e, ab \rightarrow c$

578

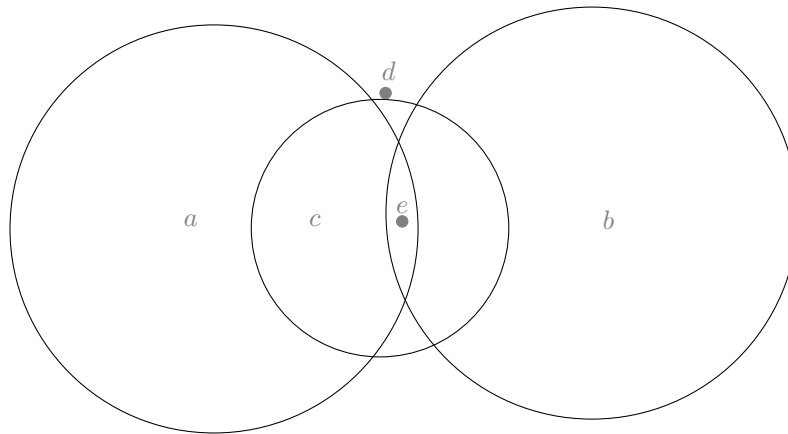

Figure 578:  $bc \rightarrow de, ac \rightarrow de, c \rightarrow e, ab \rightarrow cde, b \rightarrow e, a \rightarrow e$

579

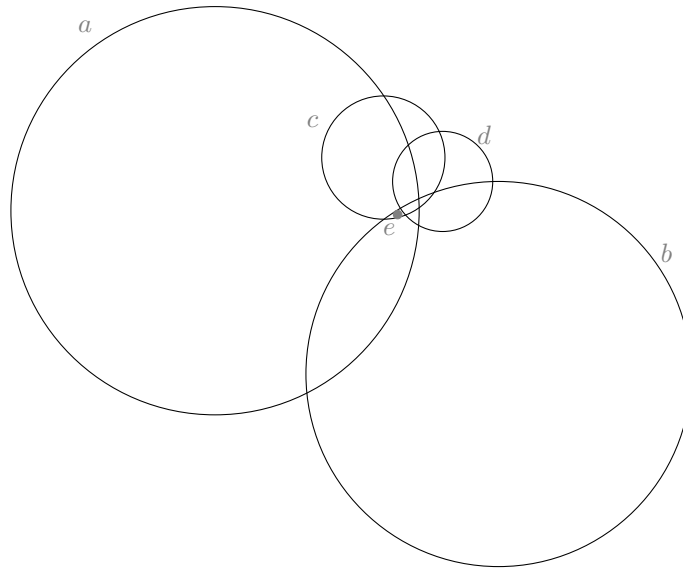

Figure 579:  $a \rightarrow e, b \rightarrow e, c \rightarrow e, ab \rightarrow cde, ad \rightarrow ce, bc \rightarrow de$

580

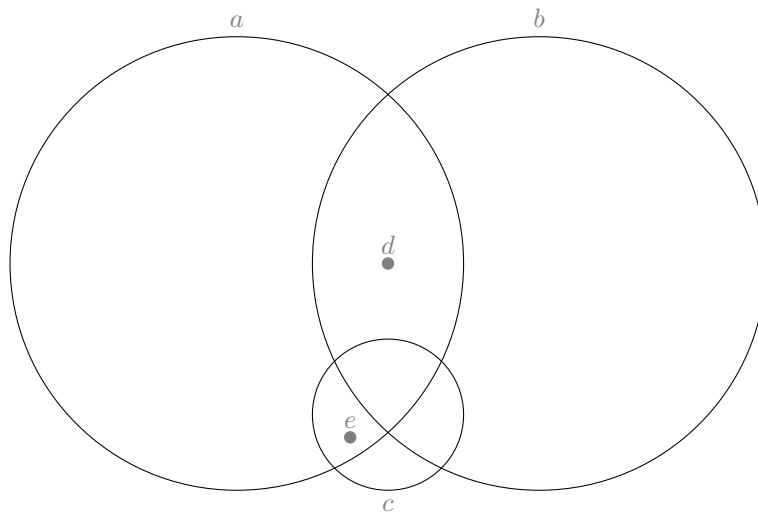

Figure 580:  $bc \rightarrow de, c \rightarrow e, ab \rightarrow cde, b \rightarrow d, a \rightarrow de$ .

581

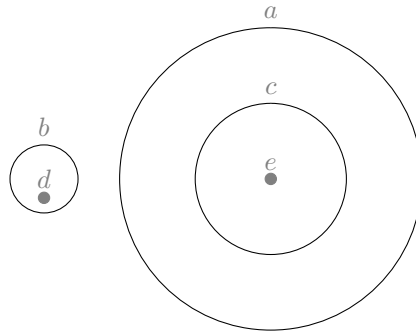

Figure 581:  $a \rightarrow ce, c \rightarrow e, b \rightarrow d$

582

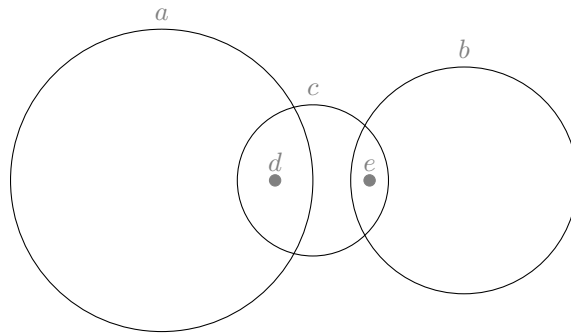

Figure 582:  $a \rightarrow d, c \rightarrow de, ab \rightarrow cd, b \rightarrow e$

583

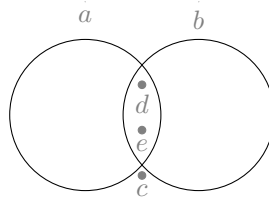

Figure 583:  $a \rightarrow de, b \rightarrow de, ab \rightarrow cde, cd \rightarrow e$

584

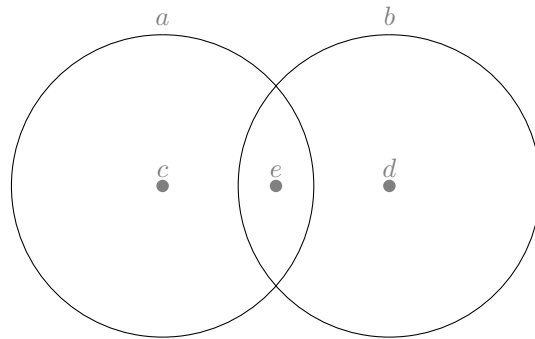

Figure 584:  $a \rightarrow ce, b \rightarrow de, cd \rightarrow e$

585

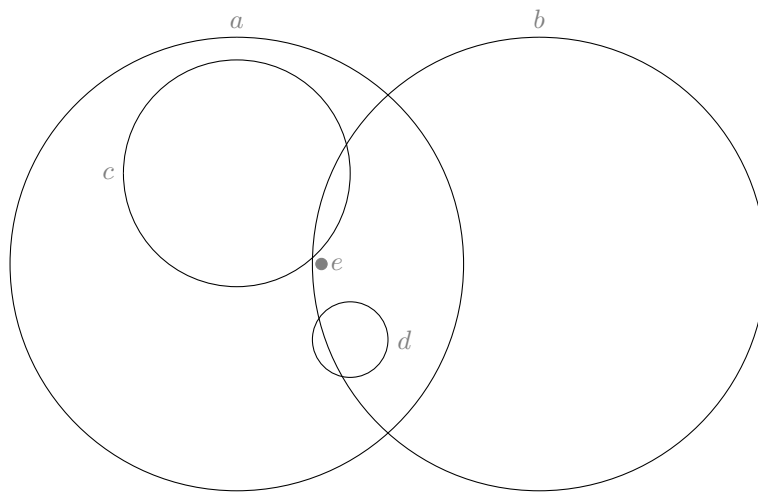

Figure 585:  $cd \rightarrow e, bc \rightarrow de, b \rightarrow e, a \rightarrow cde.$

APPENDIX B.2: REPRESENTATION OF SIZE 5 GEOMETRIES

586

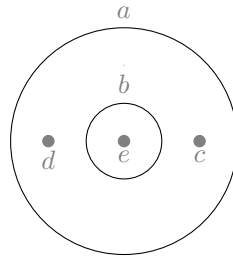

Figure 586:  $b \rightarrow e, cd \rightarrow e, a \rightarrow bcde$

587

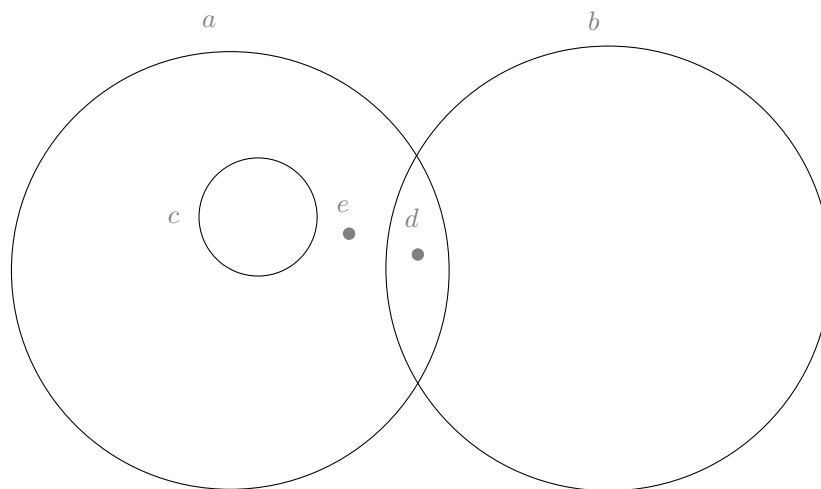

Figure 587:  $cd \rightarrow e, bc \rightarrow de, b \rightarrow d, a \rightarrow cde$

588

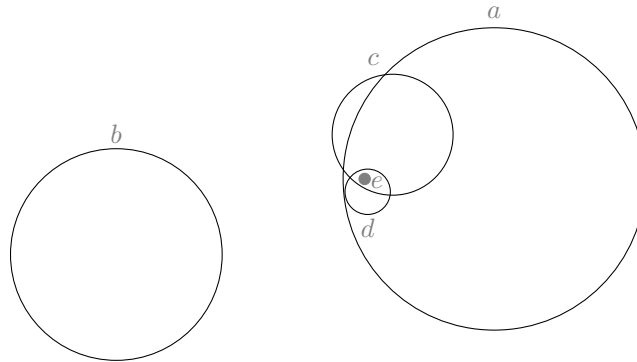

Figure 588:  $d \rightarrow e, bc \rightarrow de, c \rightarrow e, ab \rightarrow cde, a \rightarrow de$

589

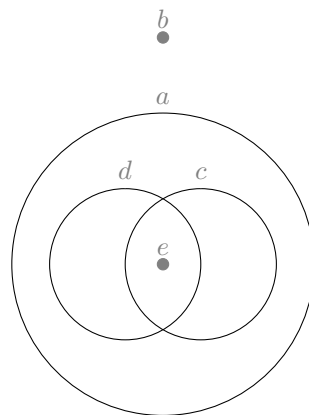

Figure 589:  $a \rightarrow cde, c \rightarrow e, d \rightarrow e$

590

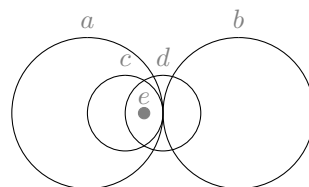

Figure 590:  $a \rightarrow c, bc \rightarrow d, ab \rightarrow d, c \rightarrow e, d \rightarrow e$

APPENDIX B.2: REPRESENTATION OF SIZE 5 GEOMETRIES

591

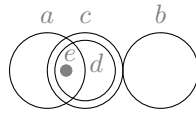

Figure 591:  $a \rightarrow e$ ,  $d \rightarrow e$ ,  $c \rightarrow de$ ,  $ab \rightarrow cde$

592

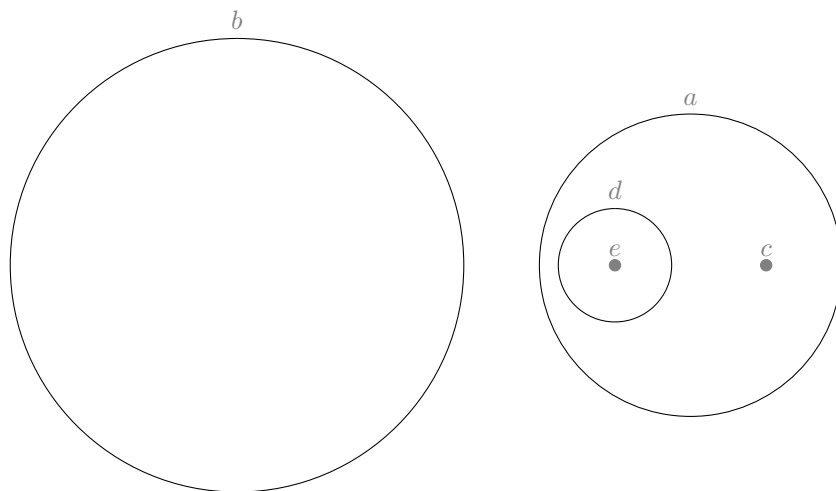

Figure 592:  $d \rightarrow e$ ,  $bc \rightarrow de$ ,  $a \rightarrow cde$ .

593

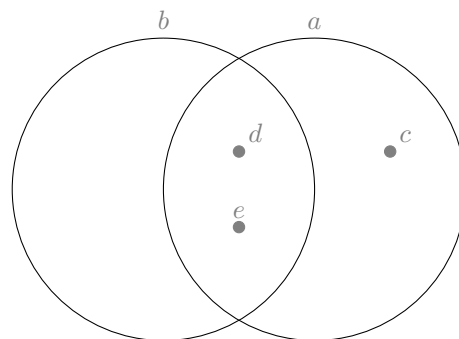

Figure 593:  $b \rightarrow de$ ,  $a \rightarrow cde$

APPENDIX B.2: REPRESENTATION OF SIZE 5 GEOMETRIES

594

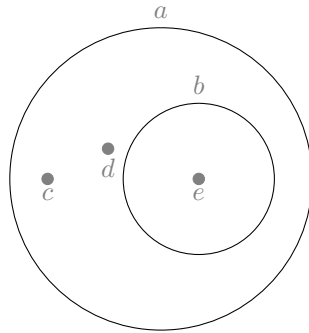

Figure 594:  $b \rightarrow e, bc \rightarrow de, a \rightarrow bcde$

595

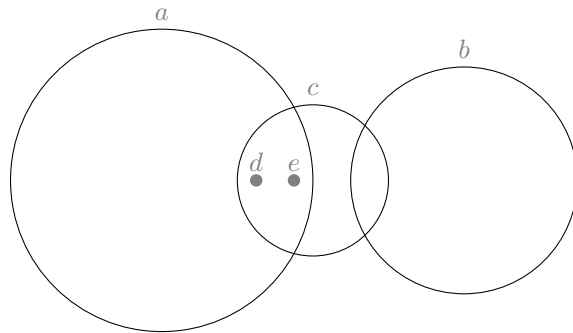

Figure 595:  $a \rightarrow de, c \rightarrow de, ab \rightarrow c, bd \rightarrow e$

596

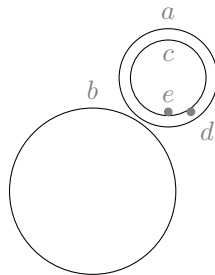

Figure 596:  $a \rightarrow cde, c \rightarrow e, bd \rightarrow e, bc \rightarrow de$



APPENDIX B.2: REPRESENTATION OF SIZE 5 GEOMETRIES

597

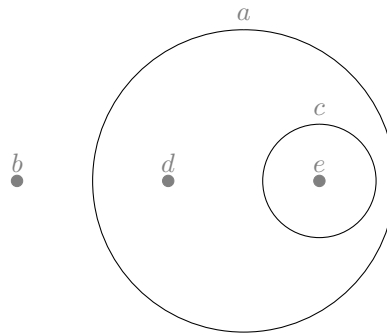

Figure 597:  $a \rightarrow cde$ ,  $bc \rightarrow de$ ,  $be \rightarrow d$ ,  $c \rightarrow e$

598

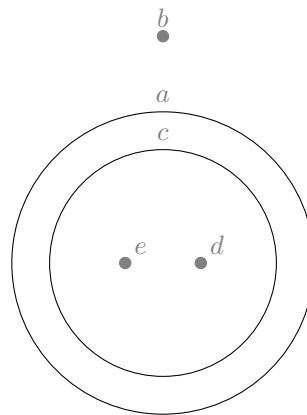

Figure 598:  $c \rightarrow de$ ,  $a \rightarrow cde$

599

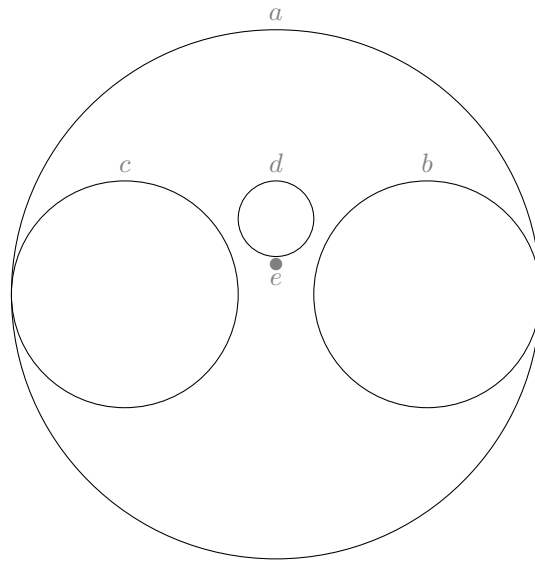

Figure 599:  $bd \rightarrow e, cd \rightarrow e, bc \rightarrow de, a \rightarrow bcde$

600

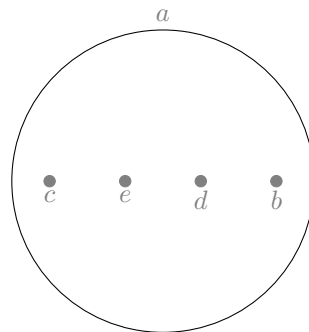

Figure 600:  $be \rightarrow d, cd \rightarrow e, bc \rightarrow de, a \rightarrow bcde$

APPENDIX B.2: REPRESENTATION OF SIZE 5 GEOMETRIES

601

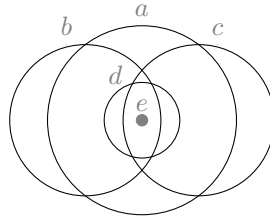

Figure 601:  $a \rightarrow de$ ,  $b \rightarrow e$ ,  $c \rightarrow e$ ,  $d \rightarrow e$ ,  $bc \rightarrow de$

602

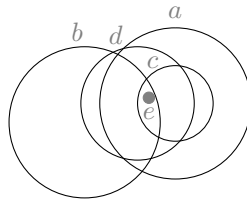

Figure 602:  $a \rightarrow de$ ,  $b \rightarrow e$ ,  $c \rightarrow e$ ,  $d \rightarrow e$ ,  $ab \rightarrow cde$

603

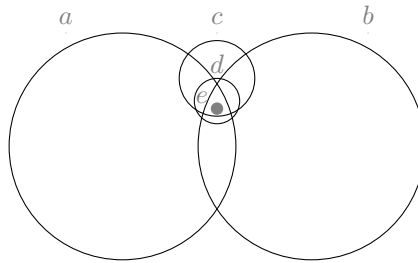

Figure 603:  $a \rightarrow e$ ,  $b \rightarrow e$ ,  $c \rightarrow e$ ,  $d \rightarrow e$ ,  $ac \rightarrow de$ ,  $bc \rightarrow de$ ,  $ab \rightarrow cde$

APPENDIX B.2: REPRESENTATION OF SIZE 5 GEOMETRIES

604

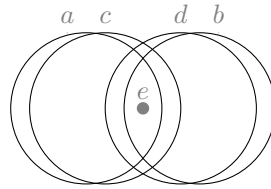

Figure 604:  $a \rightarrow e, b \rightarrow e, c \rightarrow e, d \rightarrow e, ad \rightarrow ce, bc \rightarrow de, ab \rightarrow cde$

605

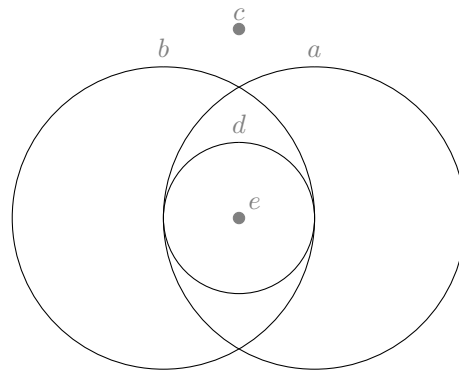

Figure 605:  $a \rightarrow de, b \rightarrow de, d \rightarrow e$

606

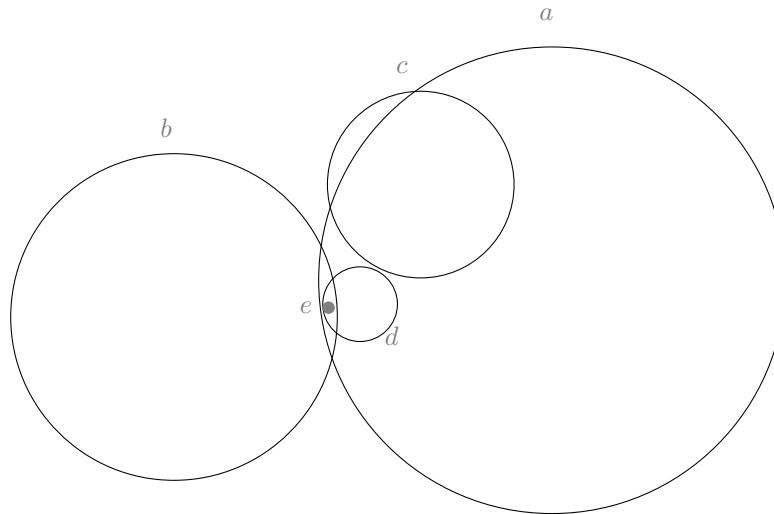

Figure 606:  $d \rightarrow e, bc \rightarrow de, ab \rightarrow cde, b \rightarrow e, a \rightarrow de$

607

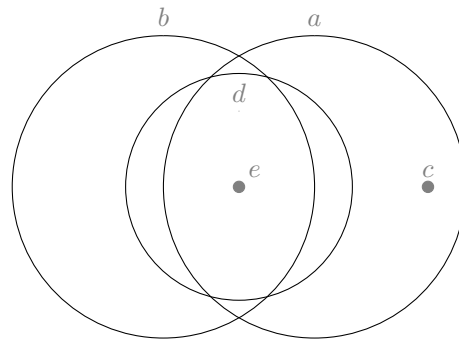

Figure 607:  $a \rightarrow ce, b \rightarrow e, d \rightarrow e, ab \rightarrow cde, bc \rightarrow de$

APPENDIX B.2: REPRESENTATION OF SIZE 5 GEOMETRIES

608

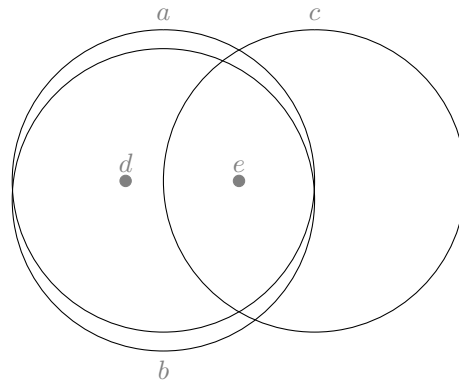

Figure 608:  $a \rightarrow de, b \rightarrow de, c \rightarrow e$

609

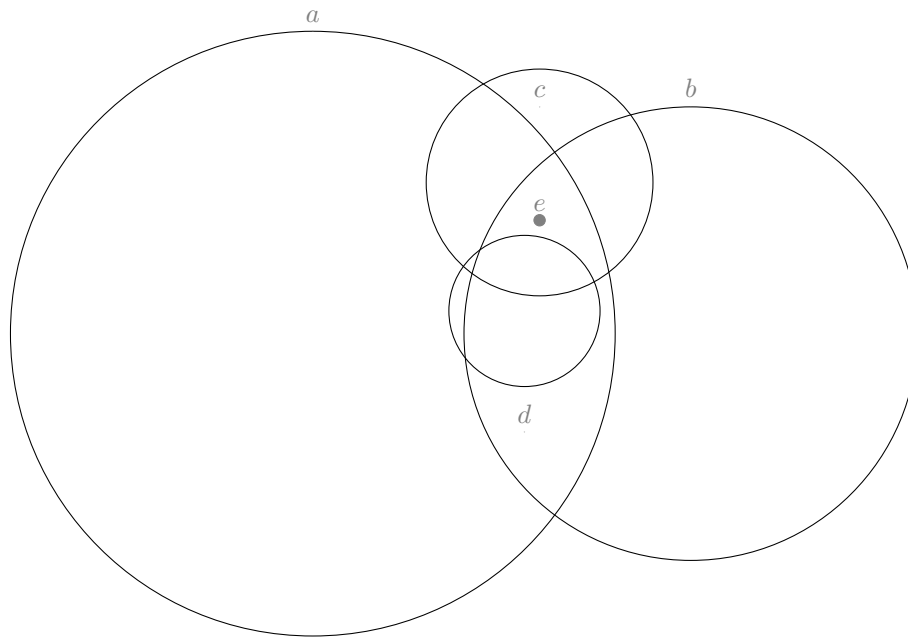

Figure 609:  $bc \rightarrow de, c \rightarrow e, ab \rightarrow cde, b \rightarrow e, a \rightarrow de.$

APPENDIX B.2: REPRESENTATION OF SIZE 5 GEOMETRIES

610

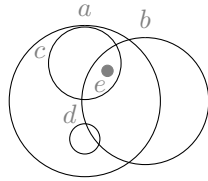

Figure 610:  $a \rightarrow cde, b \rightarrow e, c \rightarrow e$

611

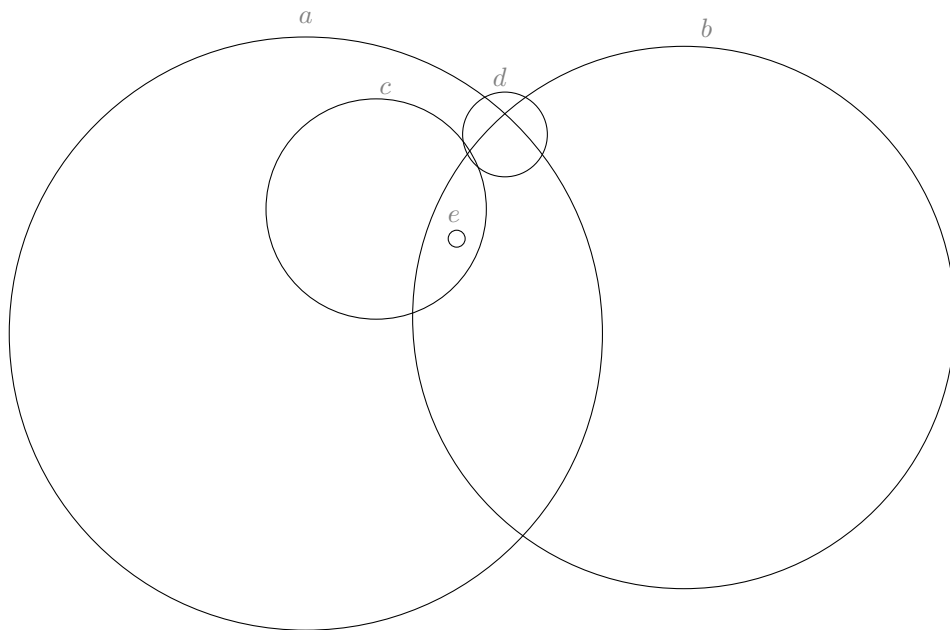

Figure 611:  $bc \rightarrow de, ab \rightarrow cde, a \rightarrow ce, b \rightarrow e, c \rightarrow e$

612

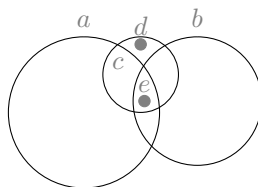

Figure 612:  $c \rightarrow de, ab \rightarrow cde, a \rightarrow e, b \rightarrow e$

APPENDIX B.2: REPRESENTATION OF SIZE 5 GEOMETRIES

613

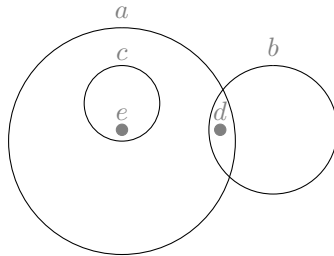

Figure 613:  $bc \rightarrow de, b \rightarrow d, c \rightarrow e, a \rightarrow cde$

614

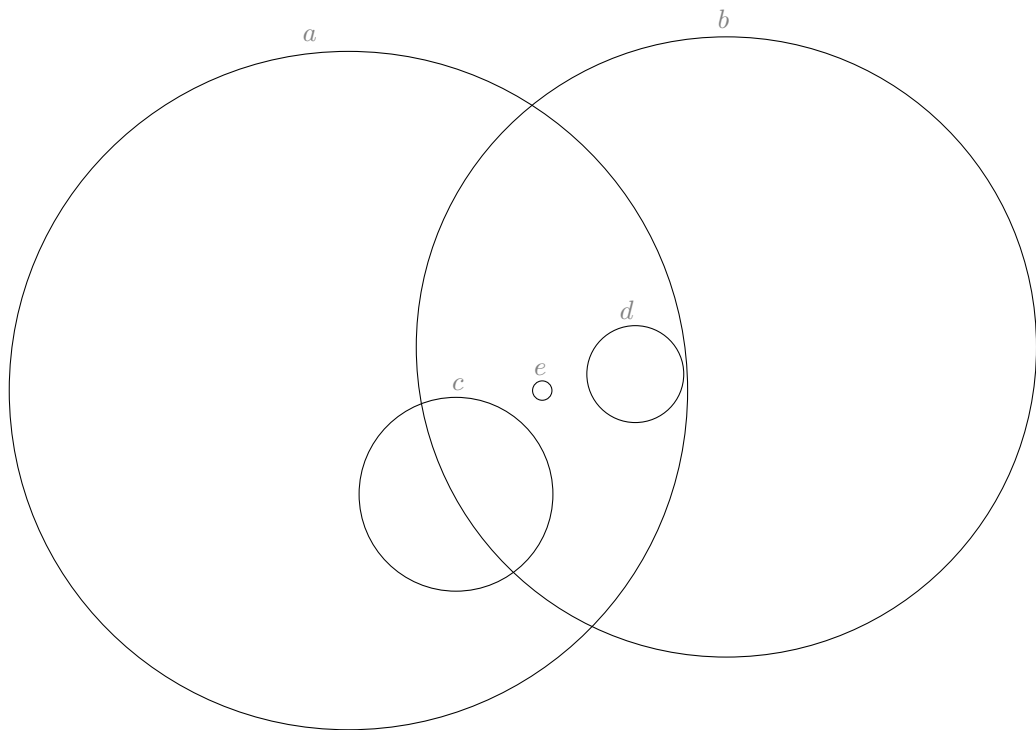

Figure 614:  $cd \rightarrow e, a \rightarrow cde, b \rightarrow de$



615

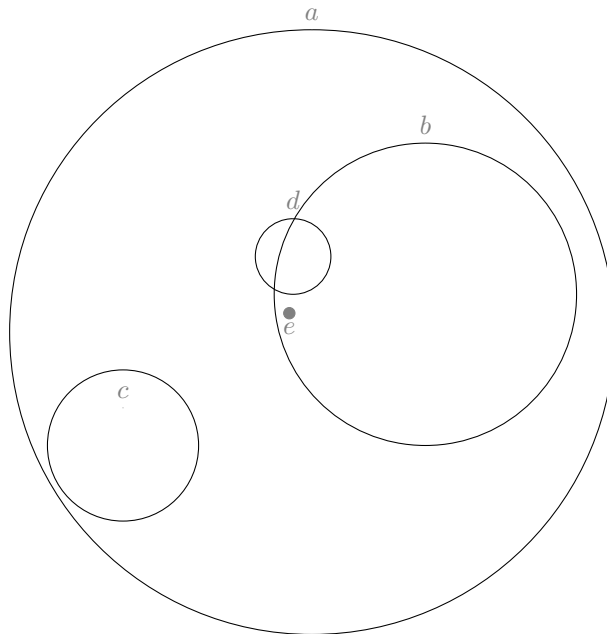

Figure 615:  $b \rightarrow e, bc \rightarrow de, cd \rightarrow e, a \rightarrow bcde$

616

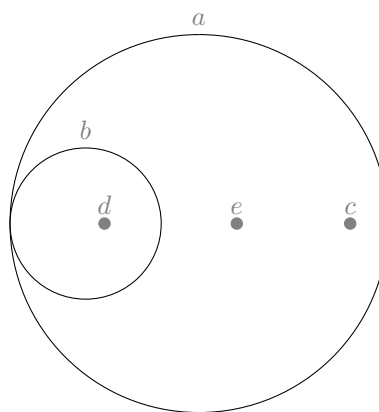

Figure 616:  $b \rightarrow d, bc \rightarrow de, cd \rightarrow e, a \rightarrow bcde$

617

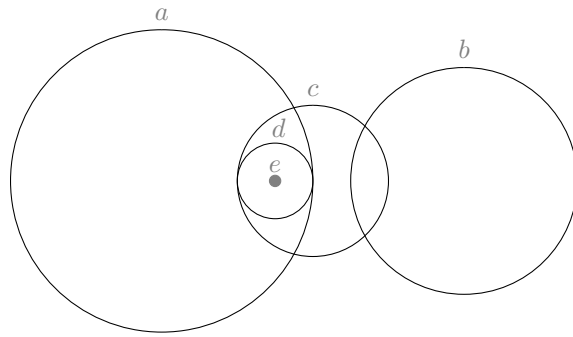

Figure 617:  $a \rightarrow de$ ,  $c \rightarrow de$ ,  $ab \rightarrow cde$ ,  $d \rightarrow e$

618

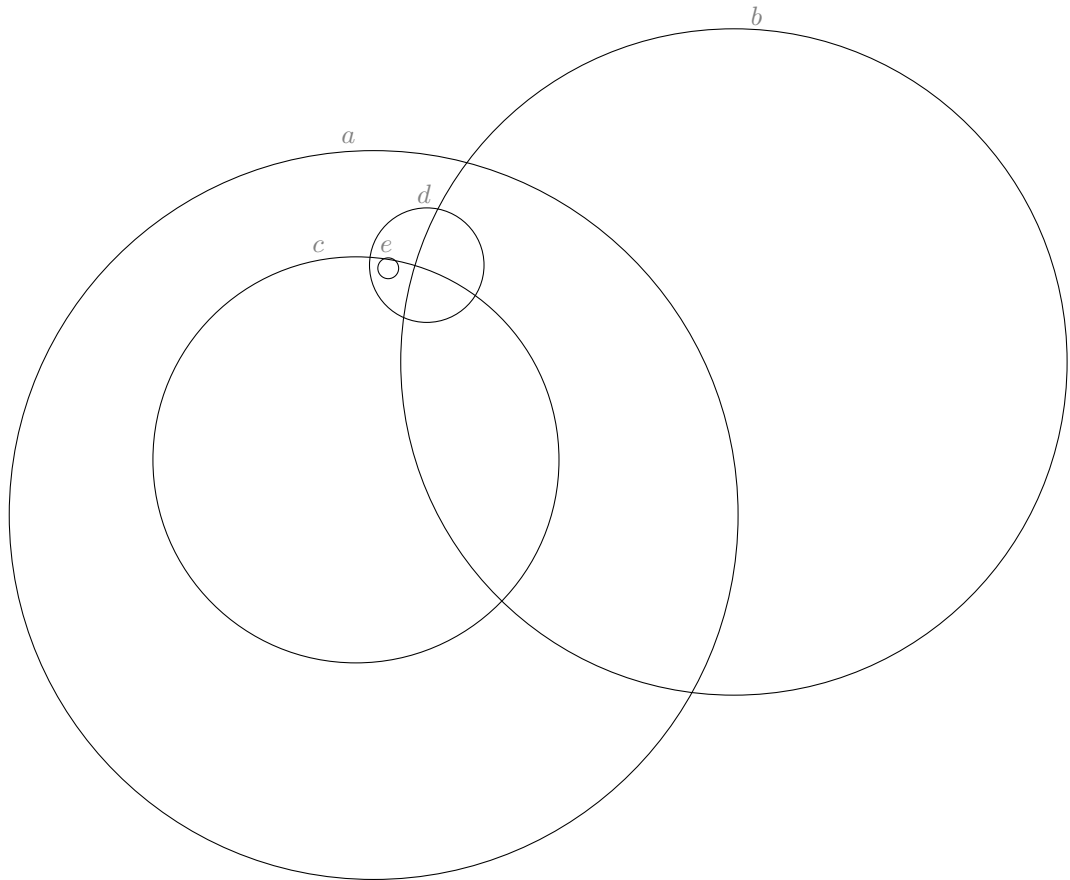

Figure 618:  $c \rightarrow e, d \rightarrow e, a \rightarrow cde, bc \rightarrow de$

619

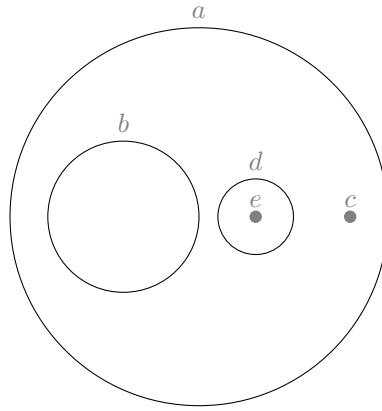

Figure 619:  $d \rightarrow e, bc \rightarrow de, a \rightarrow bcde$

620

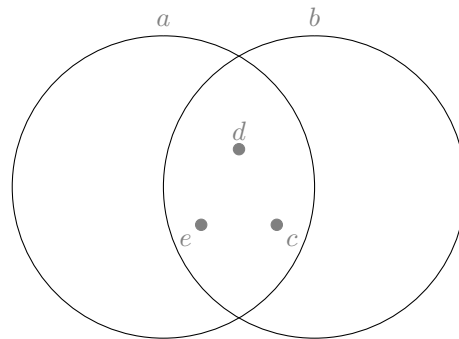

Figure 620:  $a \rightarrow cde, b \rightarrow cde$

APPENDIX B.2: REPRESENTATION OF SIZE 5 GEOMETRIES

621

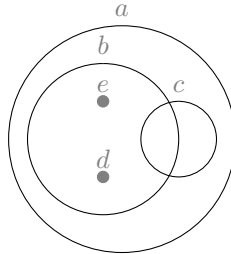

Figure 621:  $b \rightarrow de, a \rightarrow bcde$

622

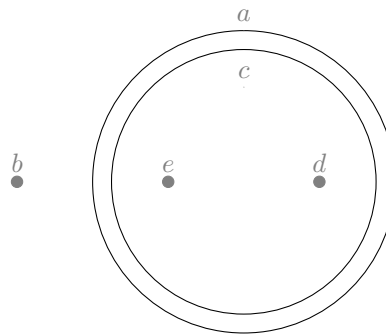

Figure 622:  $a \rightarrow cde, bd \rightarrow e, c \rightarrow de$

623

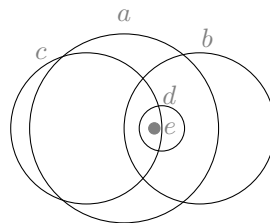

Figure 623:  $a \rightarrow de, b \rightarrow de, c \rightarrow e, d \rightarrow e,$

APPENDIX B.2: REPRESENTATION OF SIZE 5 GEOMETRIES

624

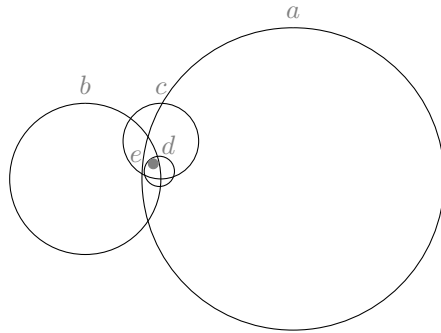

Figure 624:  $a \rightarrow de$ ,  $b \rightarrow e$ ,  $c \rightarrow e$ ,  $d \rightarrow e$ ,  $bc \rightarrow de$ ,  $ab \rightarrow cde$

625

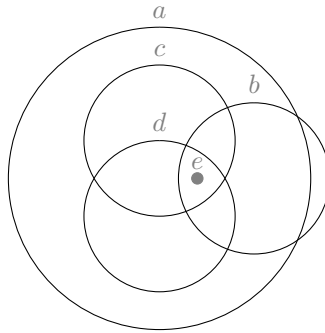

Figure 625:  $a \rightarrow cde$ ,  $b \rightarrow e$ ,  $c \rightarrow e$ ,  $d \rightarrow e$ ,

626

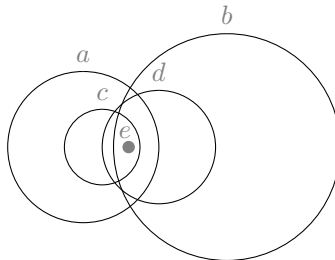

Figure 626:  $a \rightarrow ce$ ,  $b \rightarrow e$ ,  $c \rightarrow e$ ,  $d \rightarrow e$ ,  $bc \rightarrow de$ ,  $ab \rightarrow cde$

APPENDIX B.2: REPRESENTATION OF SIZE 5 GEOMETRIES

627

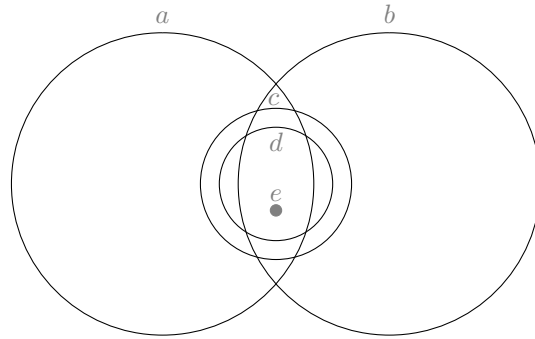

Figure 627:  $a \rightarrow e, b \rightarrow e, c \rightarrow de, d \rightarrow e, ab \rightarrow cde$

628

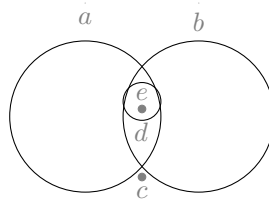

Figure 628:  $a \rightarrow de, b \rightarrow de, ab \rightarrow cde, d \rightarrow e$

629

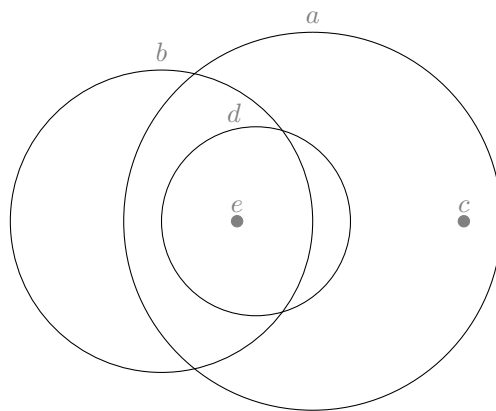

Figure 629:  $a \rightarrow cde, d \rightarrow e, b \rightarrow e, bc \rightarrow de$

630

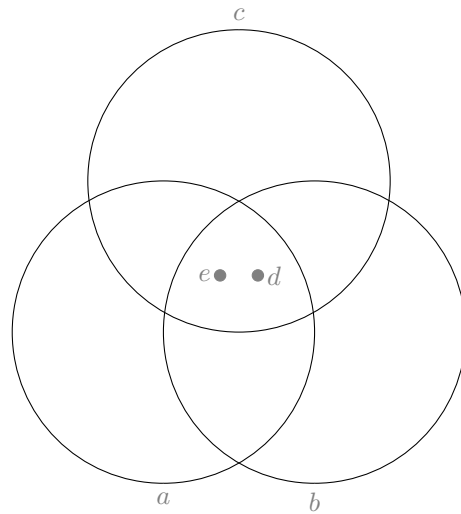

Figure 630:  $a \rightarrow de, b \rightarrow de, c \rightarrow de$

631

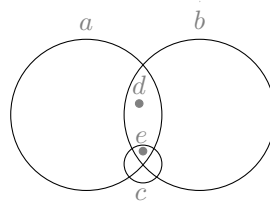

Figure 631:  $a \rightarrow de, b \rightarrow de, ab \rightarrow cde, c \rightarrow e$



632

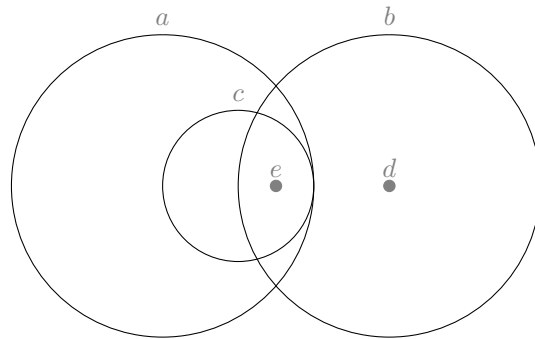

Figure 632:  $a \rightarrow ce$ ,  $b \rightarrow de$ ,  $c \rightarrow e$ ,  $ab \rightarrow cde$

633

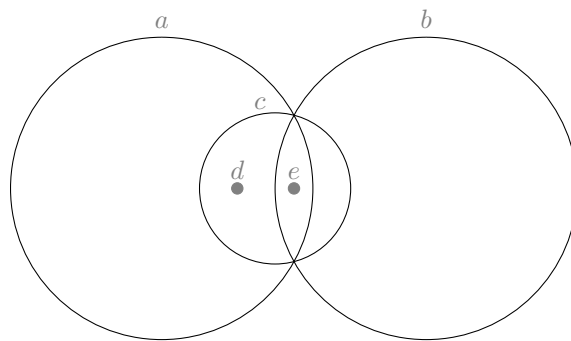

Figure 633:  $a \rightarrow de$ ,  $c \rightarrow de$ ,  $ab \rightarrow cde$ ,  $b \rightarrow e$

634

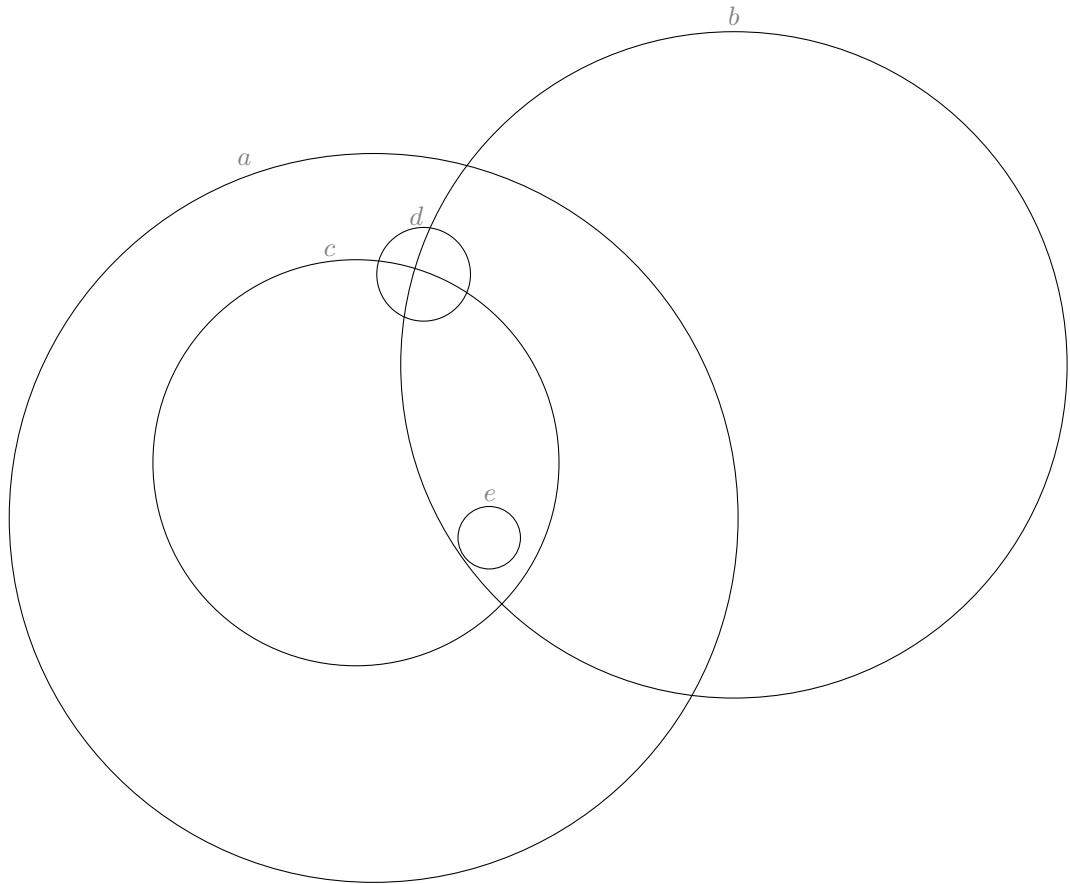

Figure 634:  $c \rightarrow e, a \rightarrow cde, b \rightarrow e, bc \rightarrow de$

APPENDIX B.2: REPRESENTATION OF SIZE 5 GEOMETRIES

635

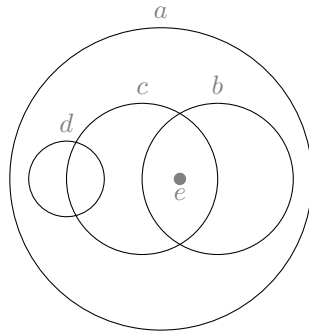

Figure 635:  $c \rightarrow e, b \rightarrow e, a \rightarrow bcde$

636

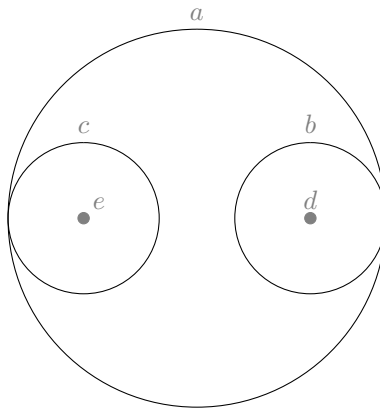

Figure 636:  $c \rightarrow e, b \rightarrow d, a \rightarrow bcde, bc \rightarrow de$

637

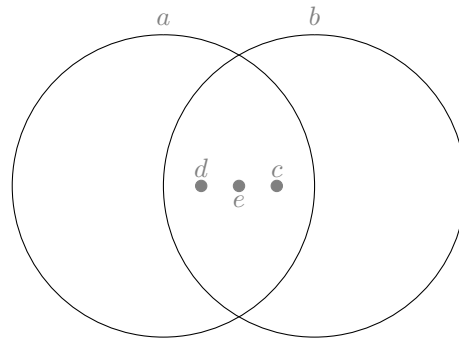

Figure 637:  $a \rightarrow cde, b \rightarrow cde, cd \rightarrow e$

638

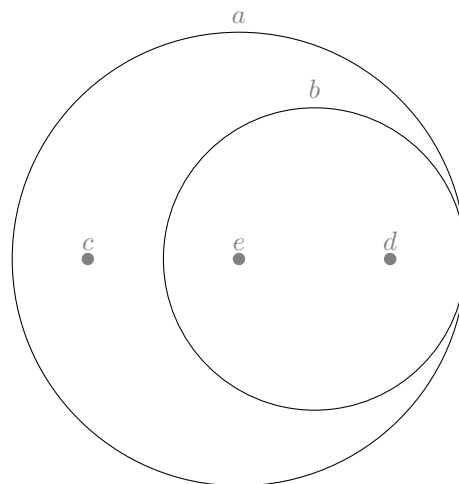

Figure 638:  $b \rightarrow de, cd \rightarrow e, a \rightarrow bcde$

APPENDIX B.2: REPRESENTATION OF SIZE 5 GEOMETRIES

639

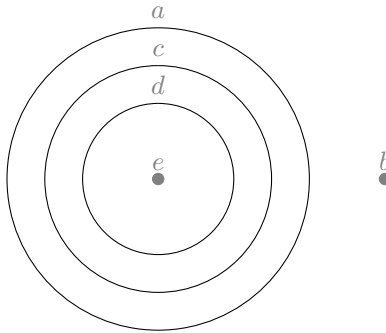

Figure 639:  $a \rightarrow cde, c \rightarrow de, d \rightarrow e$

640

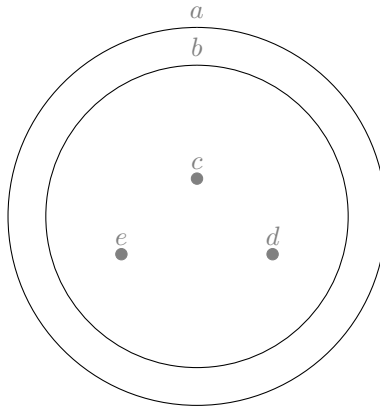

Figure 640:  $b \rightarrow cde, a \rightarrow bcde$

641

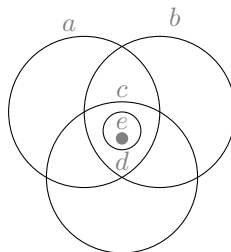

Figure 641:  $a \rightarrow de, b \rightarrow de, c \rightarrow de, d \rightarrow e$

642

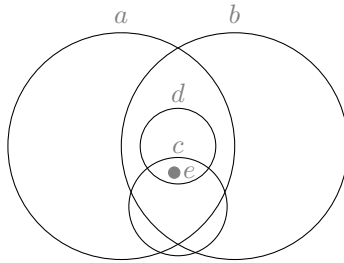

Figure 642:  $a \rightarrow de, b \rightarrow de, c \rightarrow e, d \rightarrow e, ab \rightarrow cde$

643

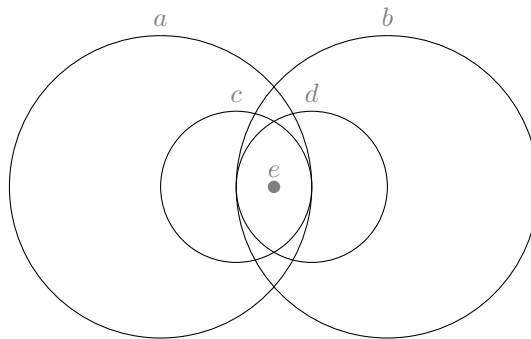

Figure 643:  $a \rightarrow ce, b \rightarrow de, c \rightarrow e, d \rightarrow e, ab \rightarrow cde$

APPENDIX B.2: REPRESENTATION OF SIZE 5 GEOMETRIES

644

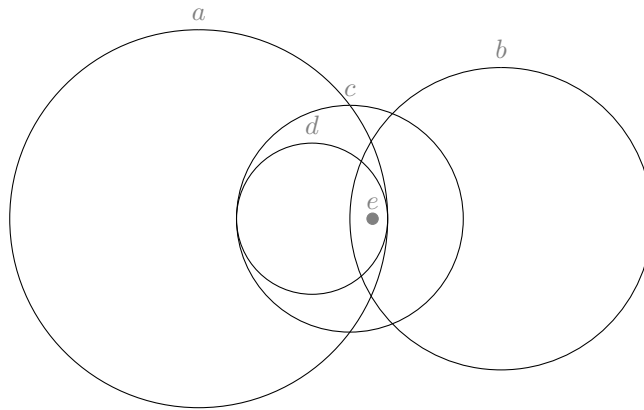

Figure 644:  $a \rightarrow de, b \rightarrow e, c \rightarrow de, d \rightarrow e, ab \rightarrow cde$

645

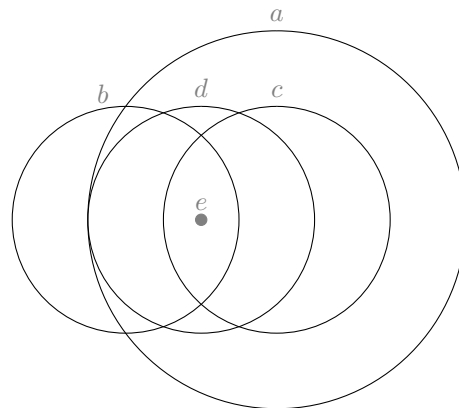

Figure 645:  $a \rightarrow cde, b \rightarrow e, c \rightarrow e, d \rightarrow e, bc \rightarrow de$

APPENDIX B.2: REPRESENTATION OF SIZE 5 GEOMETRIES

646

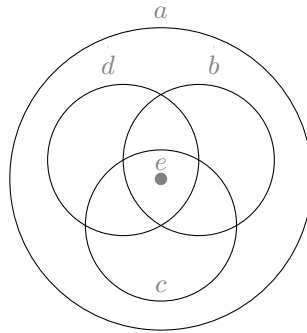

Figure 646:  $d \rightarrow e, b \rightarrow e, c \rightarrow e, a \rightarrow bcde$

647

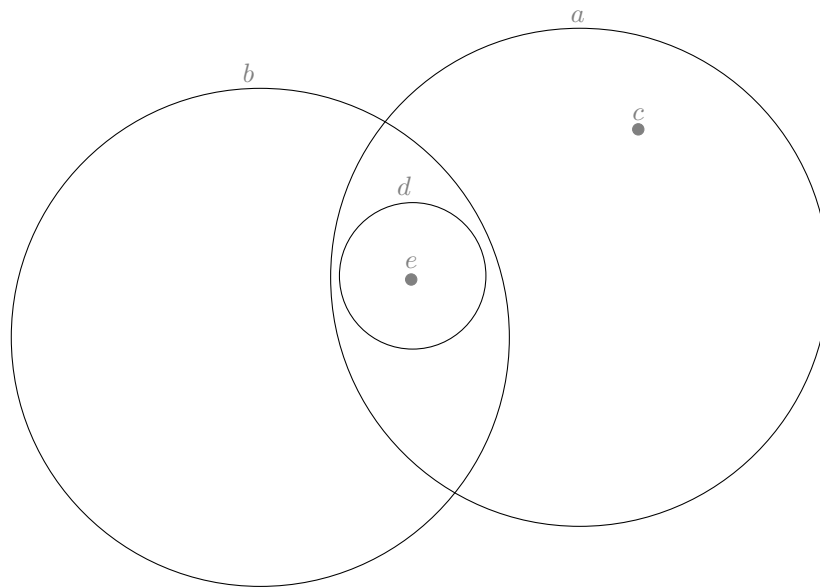

Figure 647:  $d \rightarrow e, b \rightarrow de, a \rightarrow cde$



648

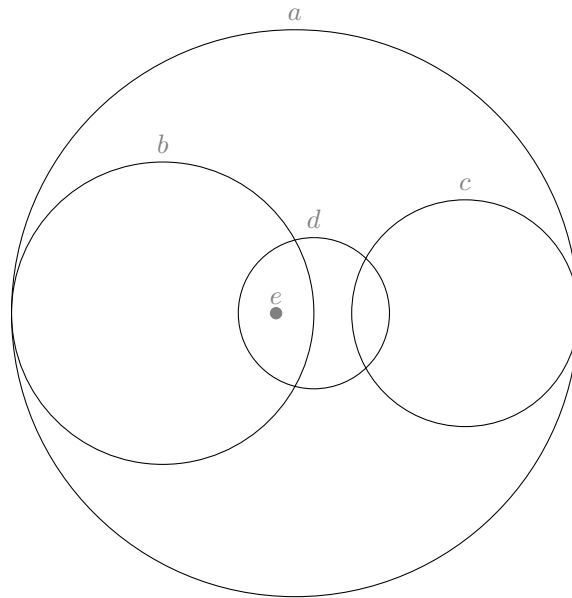

Figure 648:  $b \rightarrow e, d \rightarrow e, bc \rightarrow de, a \rightarrow bcde$

649

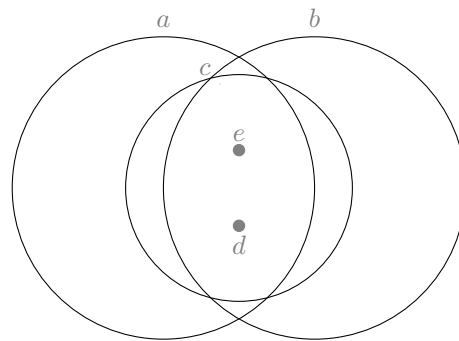

Figure 649:  $a \rightarrow de, b \rightarrow de, c \rightarrow de, ab \rightarrow cde$

650

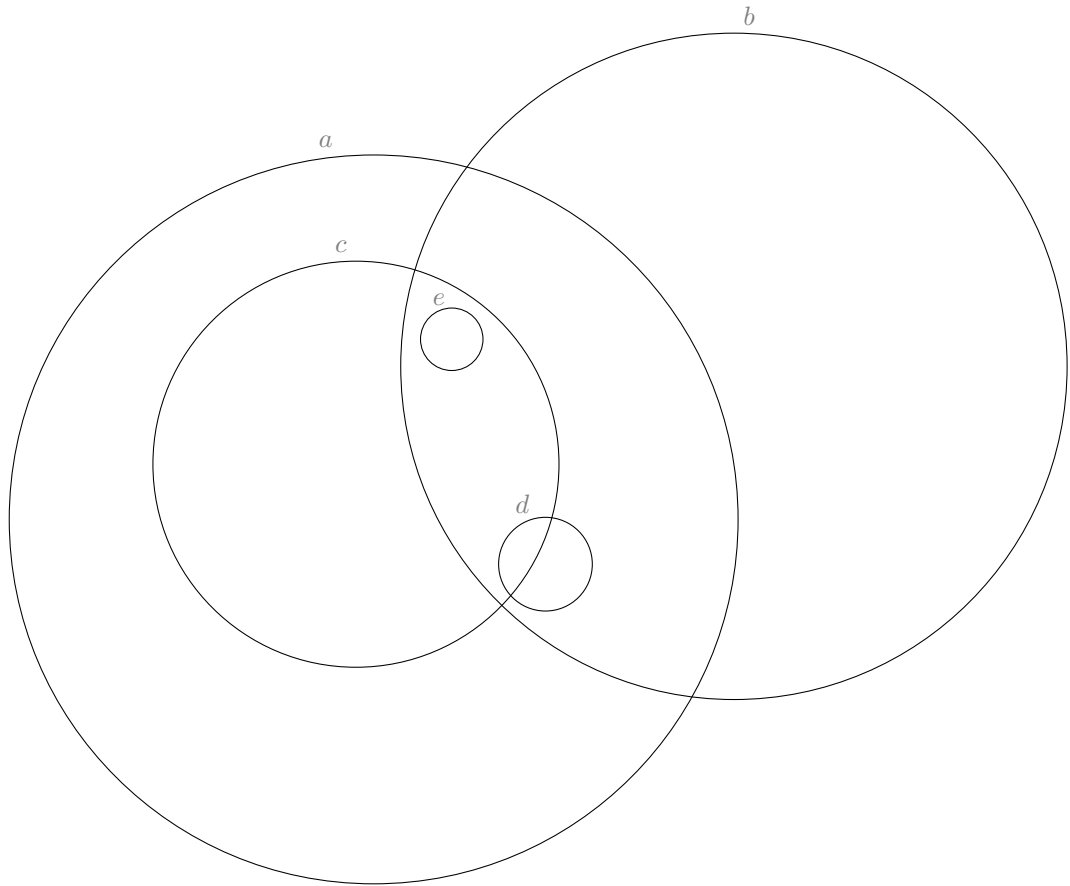

Figure 650:  $c \rightarrow e, a \rightarrow cde, b \rightarrow de$

APPENDIX B.2: REPRESENTATION OF SIZE 5 GEOMETRIES

651

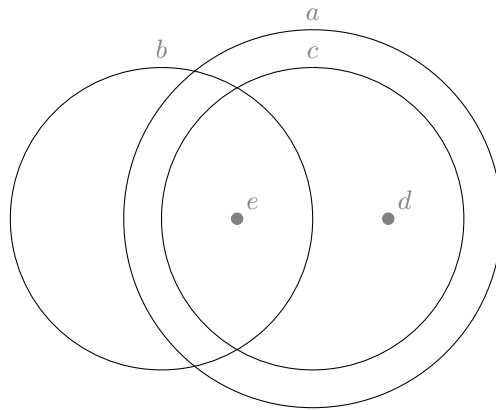

Figure 651:  $a \rightarrow cde$ ,  $c \rightarrow de$ ,  $b \rightarrow e$

652

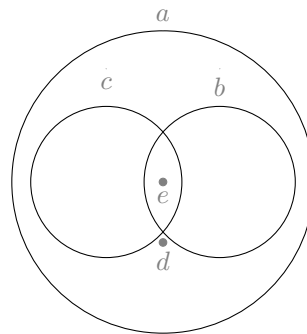

Figure 652:  $c \rightarrow e$ ,  $b \rightarrow e$ ,  $bc \rightarrow de$ ,  $a \rightarrow bcde$

APPENDIX B.2: REPRESENTATION OF SIZE 5 GEOMETRIES

653

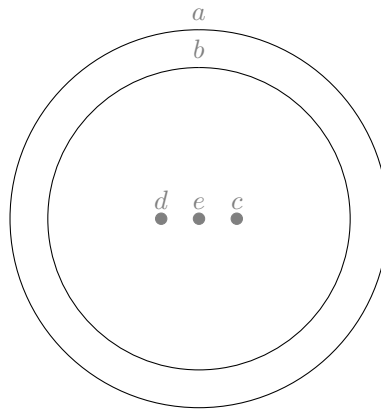

Figure 653:  $b \rightarrow cde, cd \rightarrow e, a \rightarrow bcde$

654

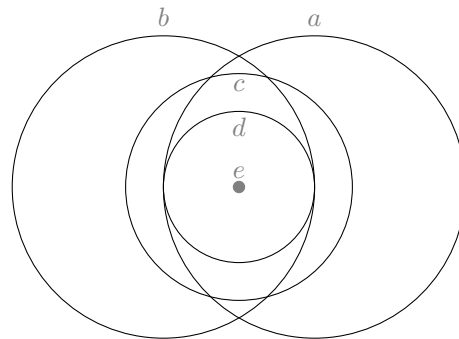

Figure 654:  $a \rightarrow de, b \rightarrow de, c \rightarrow de, d \rightarrow e, ab \rightarrow cde$

APPENDIX B.2: REPRESENTATION OF SIZE 5 GEOMETRIES

655

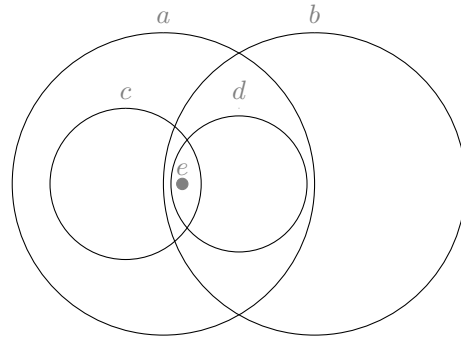

Figure 655:  $a \rightarrow cde$ ,  $b \rightarrow de$ ,  $c \rightarrow e$ ,  $d \rightarrow e$

656

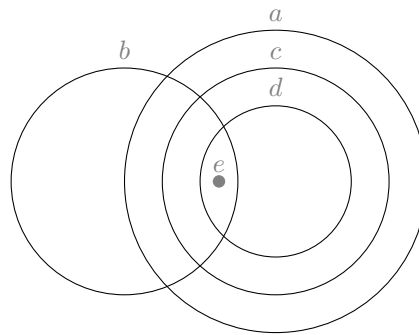

Figure 656:  $a \rightarrow cde$ ,  $b \rightarrow e$ ,  $c \rightarrow de$ ,  $d \rightarrow e$

APPENDIX B.2: REPRESENTATION OF SIZE 5 GEOMETRIES

657

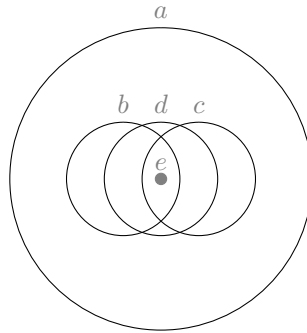

Figure 657:  $a \rightarrow bcde$ ,  $b \rightarrow e$ ,  $c \rightarrow e$ ,  $d \rightarrow e$ ,  $bc \rightarrow de$

658

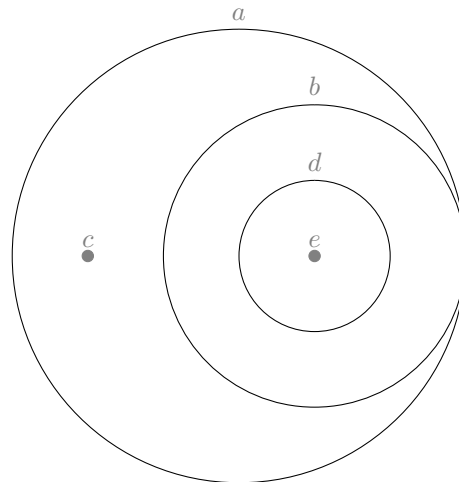

Figure 658:  $b \rightarrow de$ ,  $d \rightarrow e$ ,  $a \rightarrow bcde$

APPENDIX B.2: REPRESENTATION OF SIZE 5 GEOMETRIES

659

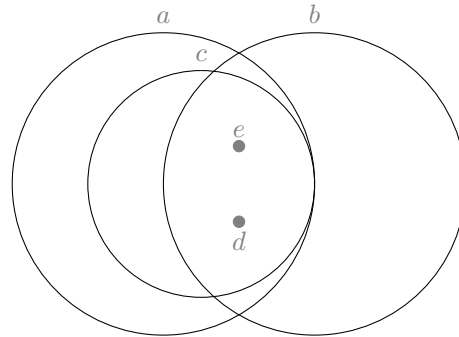

Figure 659:  $a \rightarrow cde, b \rightarrow de, c \rightarrow de$

660

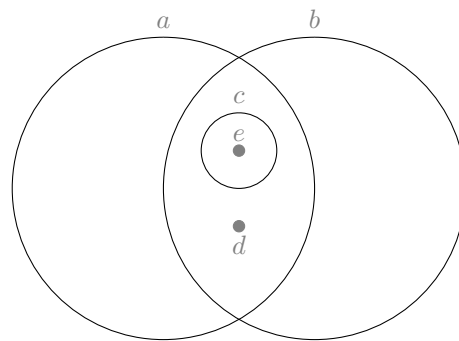

Figure 660:  $a \rightarrow cde, b \rightarrow cde, c \rightarrow e$

661

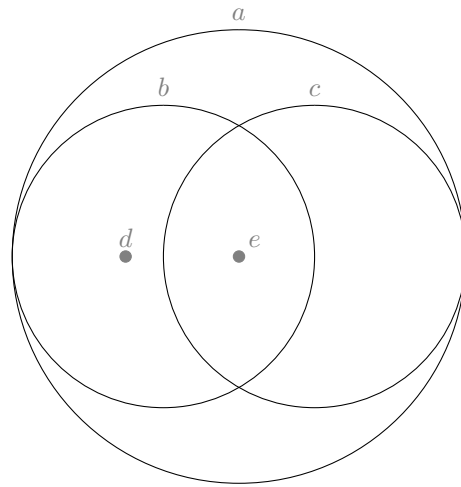

Figure 661:  $b \rightarrow de, c \rightarrow e, a \rightarrow bcde$

662

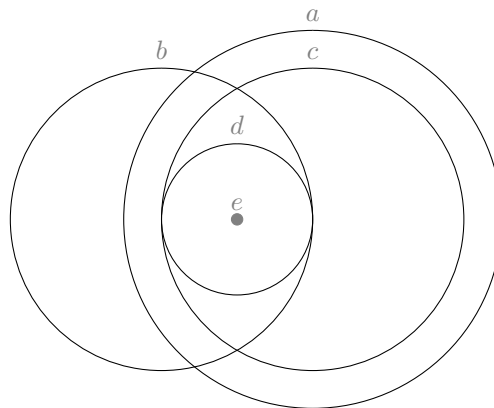

Figure 662:  $a \rightarrow cde, b \rightarrow de, c \rightarrow de, d \rightarrow e$



APPENDIX B.2: REPRESENTATION OF SIZE 5 GEOMETRIES

663

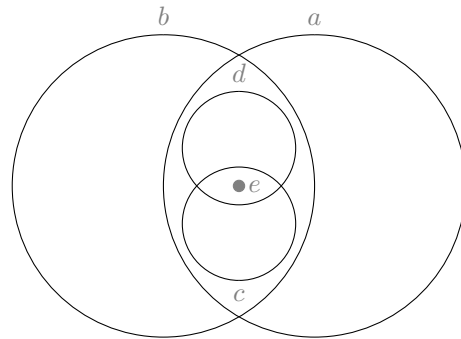

Figure 663:  $a \rightarrow cde, b \rightarrow cde, c \rightarrow e, d \rightarrow e$

664

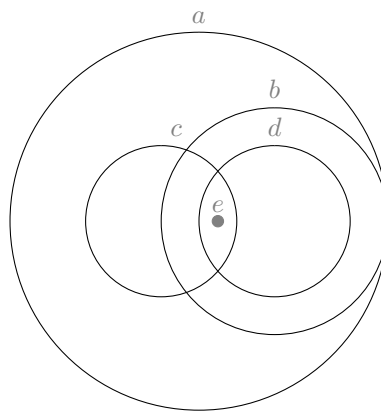

Figure 664:  $a \rightarrow bcde, b \rightarrow de, c \rightarrow e, d \rightarrow e$

APPENDIX B.2: REPRESENTATION OF SIZE 5 GEOMETRIES

665

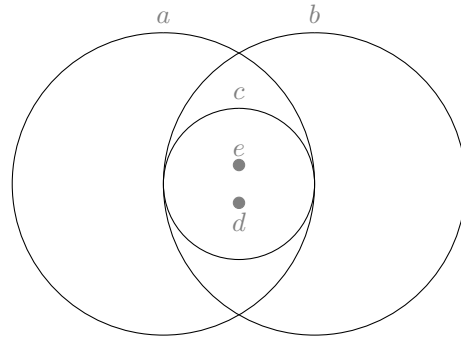

Figure 665:  $a \rightarrow cde, b \rightarrow cde, c \rightarrow de$

666

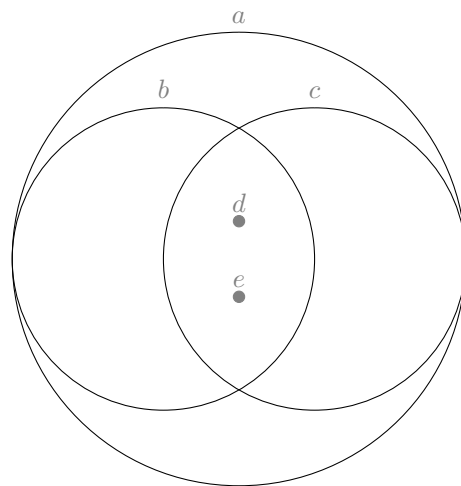

Figure 666:  $b \rightarrow de, c \rightarrow de, a \rightarrow bcde$

APPENDIX B.2: REPRESENTATION OF SIZE 5 GEOMETRIES

667

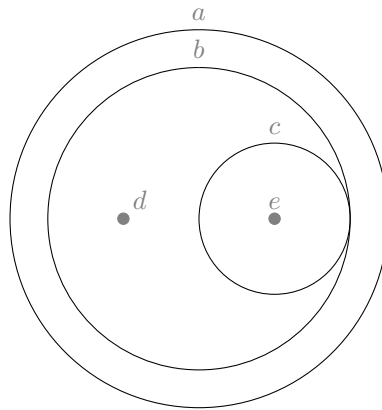

Figure 667:  $c \rightarrow e, b \rightarrow cde, a \rightarrow bcde$

668

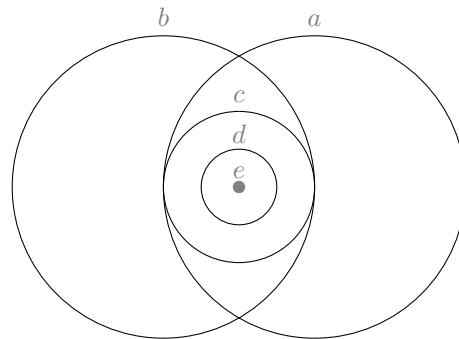

Figure 668:  $a \rightarrow cde, b \rightarrow cde, c \rightarrow de, d \rightarrow e$

APPENDIX B.2: REPRESENTATION OF SIZE 5 GEOMETRIES

669

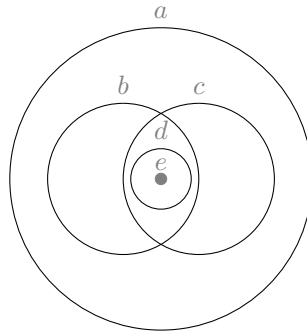

Figure 669:  $a \rightarrow bcde$ ,  $b \rightarrow de$ ,  $c \rightarrow de$ ,  $d \rightarrow e$

670

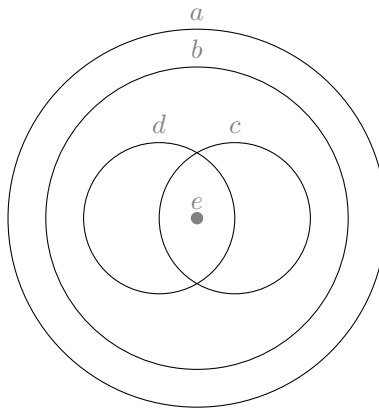

Figure 670:  $a \rightarrow bcde$ ,  $b \rightarrow cde$ ,  $c \rightarrow e$ ,  $d \rightarrow e$

APPENDIX B.2: REPRESENTATION OF SIZE 5 GEOMETRIES

671

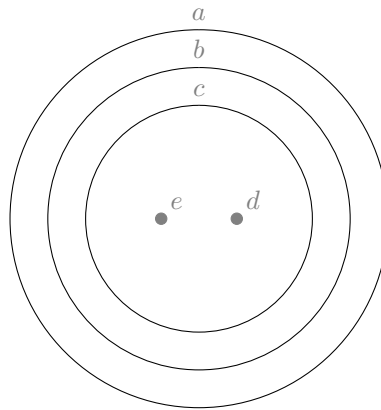

Figure 671:  $b \rightarrow cde, c \rightarrow de, a \rightarrow bcde$

672

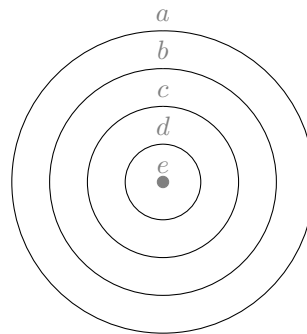

Figure 672:  $a \rightarrow bcde, b \rightarrow cde, c \rightarrow de, d \rightarrow e$

### B.3 Impossible Geometries

4. Weak Carousel Rule

abc  $\rightarrow$  de  
dimension: 6

7. Triangle Property

acd  $\rightarrow$  e  
abd  $\rightarrow$  e  
abc  $\rightarrow$  e  
dimension: 4

11. Triangle Property

bcd  $\rightarrow$  e  
acd  $\rightarrow$  e  
abd  $\rightarrow$  e  
abc  $\rightarrow$  e  
dimension: 6

12. Triangle Property

acd  $\rightarrow$  e  
abd  $\rightarrow$  e  
abc  $\rightarrow$  de  
dimension: 5

14.

bcd  $\rightarrow$  e  
acd  $\rightarrow$  e  
ab  $\rightarrow$  e  
dimension: 5

15.

acd  $\rightarrow$  e  
abc  $\rightarrow$  de  
ab  $\rightarrow$  e  
dimension: 5

18. Triangle Property

bcd  $\rightarrow$  e  
acd  $\rightarrow$  e  
abd  $\rightarrow$  e  
abc  $\rightarrow$  de  
dimension: 6

21. Triangle Property

abe  $\rightarrow$  d

## APPENDIX B.3: IMPOSSIBLE GEOMETRIES

bcd  $\rightarrow$  e  
acd  $\rightarrow$  e  
abc  $\rightarrow$  de  
dimension: 4

### 23. Triangle Property Corollary

bcd  $\rightarrow$  e  
acd  $\rightarrow$  e  
abc  $\rightarrow$  de  
ab  $\rightarrow$  e  
dimension: 6

26.

bcd  $\rightarrow$  e  
ad  $\rightarrow$  e  
abc  $\rightarrow$  de  
dimension: 5

27.

abe  $\rightarrow$  d  
bcd  $\rightarrow$  e  
abc  $\rightarrow$  de  
ac  $\rightarrow$  e  
dimension: 4

33.

abc  $\rightarrow$  de  
ac  $\rightarrow$  e  
ab  $\rightarrow$  e  
dimension: 5

### 34. Triangle Property

bcd  $\rightarrow$  e  
acd  $\rightarrow$  e  
abc  $\rightarrow$  de  
ab  $\rightarrow$  d  
dimension: 4

35.

bcd  $\rightarrow$  e  
ad  $\rightarrow$  e  
abc  $\rightarrow$  de  
ab  $\rightarrow$  e  
dimension: 5

39.

### APPENDIX B.3: IMPOSSIBLE GEOMETRIES

bcd → e  
acd → e  
ab → de  
dimension: 5

43.  
ace → d  
bcd → e  
ab → de  
dimension: 4

45.  
ad → e  
abc → de  
bc → e  
dimension: 5

46.  
bcd → e  
ad → e  
ac → e  
ab → e  
dimension: 4

47.  
abe → d  
abc → de  
bc → e  
ac → e  
dimension: 4

49.  
bcd → e  
abc → de  
ac → e  
ab → e  
dimension: 6

54.  
bcd → e  
acd → e  
ab → cde  
dimension: 5

56.  
ad → e



### APPENDIX B.3: IMPOSSIBLE GEOMETRIES

abc -> de  
bc -> e  
ab -> e  
dimension: 5

57.  
ace -> d  
bcd -> e  
ab -> cde  
dimension: 4

60.  
bcd -> e  
ad -> e  
abc -> de  
ac -> e  
ab -> e  
dimension: 5

69.  
bcd -> e  
ac -> d  
ab -> de  
dimension: 4

70.  
abc -> de  
bc -> e  
ac -> e  
ab -> e  
dimension: 6

74.  
cd -> e  
bd -> e  
ad -> e  
abc -> de  
dimension: 4

84.  
bcd -> e  
ad -> e  
ac -> e  
ab -> de  
dimension: 4

### APPENDIX B.3: IMPOSSIBLE GEOMETRIES

87.

bcd → e  
ac → de  
ab → de  
dimension: 5

89.

bcd → e  
abc → de  
a → e  
dimension: 5

94.

ad → e  
abc → de  
bc → e  
ac → e  
ab → e  
dimension: 5

95.

bcd → e  
ac → d  
ab → cde  
dimension: 4

96.

cd → e  
bd → e  
ad → e  
abc → de  
ab → e  
dimension: 4

105.

cd → e  
bd → e  
ad → e  
abc → de  
ac → e  
ab → e  
dimension: 4

114.

bcd → e  
ad → e

### APPENDIX B.3: IMPOSSIBLE GEOMETRIES

ac -> de  
ab -> de  
dimension: 4

115.  
bcd -> e  
ad -> e  
ac -> e  
ab -> cde  
dimension: 5

122.  
bcd -> e  
ac -> de  
ab -> cde  
dimension: 5

129.  
ad -> e  
bc -> e  
ac -> e  
ab -> de  
dimension: 4

132.  
bc -> e  
ac -> de  
ab -> de  
dimension: 5

134.  
abc -> de  
bc -> e  
a -> e  
dimension: 5

143.  
cd -> e  
bd -> e  
abc -> de  
a -> e  
dimension: 4

147.  
cd -> e  
bd -> e

### APPENDIX B.3: IMPOSSIBLE GEOMETRIES

ad -> e  
abc -> de  
bc -> e  
ac -> e  
ab -> e  
dimension: 4

153.  
bcd -> e  
ad -> e  
ac -> de  
ab -> cde  
dimension: 4

161.  
bcd -> e  
ac -> de  
ab -> de  
a -> e  
dimension: 4

175.  
bc -> de  
ac -> de  
ab -> de  
dimension: 6

206.  
cd -> e  
bd -> e  
abc -> de  
bc -> e  
a -> e  
dimension: 4

211.  
bcd -> e  
ac -> de  
ab -> cde  
a -> e  
dimension: 4

235.  
cd -> e  
abc -> de  
b -> e

### APPENDIX B.3: IMPOSSIBLE GEOMETRIES

a → e  
dimension: 4

351.  
abc → de  
c → e  
b → e  
a → e  
dimension: 4