MULTI-TASK LEARNING WITH DEEP NEURAL NETWORKS: A SURVEY

Michael Crawshaw
Department of Computer Science
George Mason University
mrcrawsha@gmu.edu

ABSTRACT

Multi-task learning (MTL) is a subfield of machine learning in which multiple tasks are simultaneously learned by a shared model. Such approaches offer advantages like improved data efficiency, reduced overfitting through shared representations, and fast learning by leveraging auxiliary information. However, the simultaneous learning of multiple tasks presents new design and optimization challenges, and choosing which tasks should be learned jointly is in itself a non-trivial problem. In this survey, we give an overview of multi-task learning methods for deep neural networks, with the aim of summarizing both the well-established and most recent directions within the field. Our discussion is structured according to a partition of the existing deep MTL techniques into three groups: architectures, optimization methods, and task relationship learning. We also provide a summary of common multi-task benchmarks.

1 Introduction

Multi-task learning is a training paradigm in which machine learning models are trained with data from multiple tasks simultaneously, using shared representations to learn the common ideas between a collection of related tasks. These shared representations increase data efficiency and can potentially yield faster learning speed for related or downstream tasks, helping to alleviate the well-known weaknesses of deep learning: large-scale data requirements and computational demand. However, achieving such effects has not proven easy and is an active area of research today.

We believe that MTL reflects the learning process of human beings more accurately than single task learning in that integrating knowledge across domains is a central tenant of human intelligence. When a newborn baby learns to walk or use its hands, it accumulates general motor skills which rely on abstract notions of balance and intuitive physics. Once these motor skills and abstract concepts are learned, they can be reused and augmented for more complex tasks later in life, such as riding a bike or tightrope walking. Any time that a human attempts to learn something new, we bring a tremendous amount of prior knowledge to the table. It's no wonder that neural networks require such numerous training examples and computation time: every task is learned from scratch. Imagine trying to learn to tightrope walk without first learning to walk! The human ability to rapidly learn with few examples is dependent on this process of learning concepts which are generalizable across multiple settings and leveraging these concepts for fast learning; we believe that developing systems to perform this process should be the goal of multi-task learning and the related fields of meta-learning (Hospedales et al., 2020), transfer learning (Zhuang et al., 2019), and continuous/lifelong learning (Parisi et al., 2019).

Learning concepts for multiple tasks does bring difficulties which aren't present in single task learning. In particular, it may be the case that different tasks have conflicting needs. In this case, increasing the performance of a model on one task will hurt performance on a task with different needs, a phenomenon referred to as *negative transfer* or *destructive interference*. Minimizing negative transfer is a key goal for MTL methods. Many architectures are designed with specific features to decrease negative transfer, such as task-specific feature spaces and attention mechanisms, but division of information between tasks is a fine line to walk: we want to allow information flow between tasks that yields positive transfer, and discourage sharing when it would create negative transfer. The question of how exactly to design such a system is being actively investigated in MTL research.

The existing methods of MTL have often been partitioned into two groups with a familiar dichotomy: *hard parameter sharing vs. soft parameter sharing*. Hard parameter sharing is the practice of sharing model weights between multiple tasks, so that each weight is trained to jointly minimize multiple loss functions. Under soft parameter sharing, different tasks have individual task-specific models with separate weights, but the distance between the model parameters of different tasks is added to the joint objective function. Though there is no explicit parameter sharing, there is an incentive for the task-specific models to have similar parameters. This is a useful dichotomy, but the nature of multi-task methods has grown extremely diverse in the past few years, and we feel that these two categories alone are not broad enough to accurately describe the entire field. Instead, we widen the scope of the members of this dichotomy to cover more ground. We generalize the class of hard parameter sharing methods to multi-task architectures, while soft parameter sharing is broadened into multi-task optimization. When combined, architecture design and optimization techniques provide a nearly complete image of modern MTL. However, there is still an important direction within the field that is missing even from this generalized dichotomy: task relationship learning. Task relationship learning (or TRL) methods focus on learning an explicit representation of the relationships between tasks, such as task embeddings or transfer learning affinities, and these types of methods don't quite fit into either architecture design or optimization. Broadly speaking, these three directions - architecture design, optimization, and task relationship learning - make up the existing methods of modern deep multi-task learning.

Many different researchers have used the term multi-task learning to refer to different settings, and we feel that it is important to clarify the scope of this review. As a convention, we interpret MTL to only contain learning settings in which a fixed set of tasks is learned simultaneously, and each task is treated equally. This means that we don't consider training settings that have only a single "main task" with one or more auxiliary tasks, as well as settings in which the set of tasks to learn changes over time. We may, however, discuss models which were designed for such settings, if the ideas from the model are easily applicable to MTL.

The rest of the survey is outlined as follows. Section 2 contains a discussion of neural network architectures for multi-task learning. In section 3, we discuss MTL optimization strategies, and we discuss methods for learning explicit task relationships in section 4. Section 5 contains an overview of common multi-task benchmark for various domains. Finally, we conclude with section 6. Within each subsection or subsubsection, the methods are mostly presented in order of publication, from earliest to most recent. It should be noted that we do not discuss any classical (non-neural) multi-task learning methods, though a thorough review can be found in (Zhang and Yang, 2017; Ruder, 2017).

2 Multi-Task Architectures

A large portion of the MTL literature is devoted to the design of multi-task neural network architectures. There are many different factors to consider when creating a shared architecture, such as the portion of the model's parameters that will be shared between tasks, and how to parameterize and combine task-specific and shared modules. More variations arise when considering architectures for a specific problem domain, like how to partition convolutional filters into shared and task-specific groups for a set of vision tasks. Many of the proposed architectures for MTL play a balancing game with the degree of information sharing between tasks: Too much sharing will lead to negative transfer and can cause worse performance of joint multi-task models than individual models for each task, while too little sharing doesn't allow the model to effectively leverage information between tasks. The best performing architectures for MTL are those which balance sharing well.

We partition the MTL architectures into four groups: architectures for a particular task domain, multi-modal architectures, learned architectures, and conditional architectures. For single-domain architectures, we consider the domains of computer vision, natural language processing, and reinforcement learning. Multi-modal architectures handle tasks with input in more than one mode, such as visual question answering with both a visual and a language component. It should be noted that we only consider multi-modal architectures which handle multiple tasks. For a more complete discussion of multi-modal methods, see (Baltrusaitis et al., 2019). Lastly, We make the following distinction between learned architectures and conditional architectures: Learned architectures are fixed between steps of architecture learning, so the same computation is performed for each input from the same task. In conditional architectures, the architecture used for a given piece of data is dependent on the data itself.

2.1 Architectures for Computer Vision

In the single-task setting, many major developments for computer vision architectures have focused on novel network components and connections to improve optimization and extract more meaningful features, such as batch normalization (Ioffe and Szegedy, 2015), residual networks (He et al., 2016), and squeeze and excitation blocks (Hu et al., 2018). In contrast, many multi-task architectures for computer vision focus on partitioning the network into task-specific and

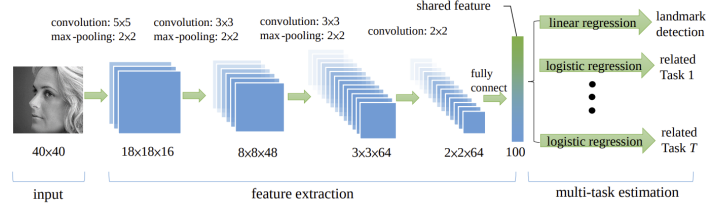

Figure 1: Architecture for TCDCN (Zhang et al., 2014). The base feature extractor is made of a series of convolutional layers which are shared between all tasks, and the extracted features are used as input to task-specific output heads.

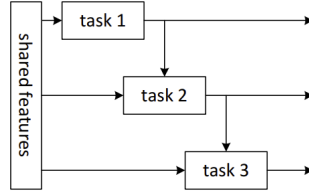

Figure 2: Illustration of Multi-task Network Cascades (Dai et al., 2016). The output of the first task is used as an input for the second task, the second task’s output is used as an input for the third task, and so on.

shared components in a way that allows for generalization through sharing and information flow between tasks, while minimizing negative transfer.

2.1.1 Shared Trunk

Traditionally, many multi-task architectures in computer vision follow a simple outline: A global feature extractor made of convolutional layers shared by all tasks followed by an individual output branch for each task, as in figure 1. We will refer to this template as a *shared trunk*.

(Zhang et al., 2014; Dai et al., 2016; Zhao et al., 2018; Liu et al., 2019; Ma et al., 2018) propose architectures which are variations on the shared trunk idea. (Zhang et al., 2014), the earliest of these works, introduces Tasks-Constrained Deep Convolutional Network (TCDCN), whose architecture is shown in figure 1. The authors propose to improve performance on a facial landmark detection task by jointly learning head pose estimation and facial attribute inference. (Dai et al., 2016) introduces Multi-task Network Cascades (MNCs). The architecture of MNCs is similar to TCDCN, with an important difference: the output of each task-specific branch is appended to the input of the next task-specific branch, forming the “cascade” of information flow after which the method is named. This type of architecture is similar to the cascaded information networks for NLP discussed in section 2.2.3.

(Zhao et al., 2018; Liu et al., 2019) each build on this original template with the introduction of task-specific modules which can be placed within existing shared architectures. By doing this, the computation of features relies on both the shared parameters of the feature extractor and the task-specific parameters of modules placed through the network, so that features of different tasks may differ before the task-specific output branches. (Zhao et al., 2018) introduces a modulation module in the form of a task-specific channel-wise linear projection of feature maps, and the authors design a convolutional architecture with these modules following convolutional layers in the latter half of the network. Interestingly, it is empirically shown that the inclusion of these task-specific projection modules decreases the chance that gradient update directions for different tasks point in opposite directions, implying that this architecture decreases the occurrence of negative transfer. (Liu et al., 2019) proposes task-specific attention modules. Each attention module takes as input the features from some intermediate layer of the shared network concatenated with the output of the previous attention module, if one exists. Each module computes an attention map by passing its input through a Conv-BN-ReLU layer followed by a Conv-BN-Sigmoid layer. The attention map is then element-wise multiplied with features from a successive shared layer, and this product is the output of the attention module. This attention module allows the network to emphasize features in the network which are more important for the corresponding task, and downplay the effect of unimportant features.

Multi-gate Mixture-of-Experts (Ma et al., 2018) is a recently proposed shared trunk model, with a twist: the network contains multiple shared trunks, and each task-specific output head receives as input a linear combination of the outputs of each shared trunk. The weights of the linear combination are computed by a separate gating function, which performs a linear transformation on the network input to compute the linear combination weights. The gating function can either

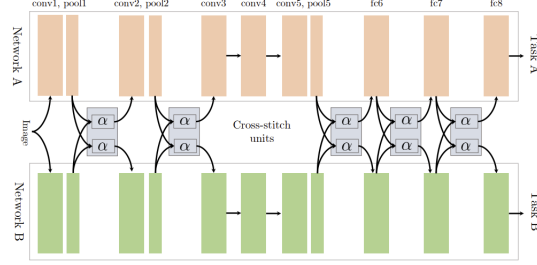

Figure 3: Cross-Stitch network architecture (Misra et al., 2016). Each task has a separate network, but cross-stitch units combine information from parallel layers of the different task networks with a linear combination.

be shared between all tasks, so that each task-specific output head receives the same input, or task-specific, so that each output head receives a different mixture of the shared trunk outputs. This model bears resemblance to Cross-Stitch networks (Misra et al., 2016) (see section 2.1.2), but performs a single linear combination of shared components instead of multiple feature combinations from task-specific layers. This method wasn't empirically evaluated on computer vision tasks, but is discussed here due to its close relationship with the other CV architectures (Zhang et al., 2014; Misra et al., 2016).

2.1.2 Cross-Talk

Not all MTL architectures for computer vision consist of a shared, global feature extractor with task-specific output branches or modules. (Misra et al., 2016; Ruder et al., 2019; Gao et al., 2019) take a separate approach. Instead of a single shared extractor, these architectures have a separate network for each task, with information flow between parallel layers in the task networks, referred to as *cross-talk*. Figure 3 depicts this idea with the Cross-Stitch network architecture from (Misra et al., 2016).

A Cross-Stitch network is composed of individual networks for each task, but the input to each layer is a linear combination of the outputs of the previous layer from every task network. The weights of each linear combination are learned and task-specific, so that each layer can choose which tasks to leverage information from. (Ruder et al., 2019) generalizes this idea with the introduction of the Sluice network. In the Sluice network, each layer is divided into task-specific and shared subspaces, and the input to each layer is a linear combination of the task-specific and shared outputs of the previous layer from each task network. This way, each layer can choose whether to focus on task specific or shared features from previous layers. The task-specific and shared subspaces of each layer are also encouraged to be orthogonal, by adding an auxiliary term to the loss function to minimize the squared Frobenius norm of the product of each task-specific subspace with its corresponding shared subspace. It should be noted that Sluice networks are presented in a domain-agnostic way, but we discuss them here due to their relation to Cross-Stitch networks. Finally, (Gao et al., 2019) generalizes the feature fusion operation at parallel layers with Neural Discriminative Dimensionality Reduction (NDDR-CNN). Instead of using a linear combination to combine features from parallel layers of the task networks, NDDR-CNN concatenates the outputs from each layer and pass the result through a 1×1 convolution. The parameters of this convolution are task specific, as are the linear combination weights in Cross-Stitch networks. A diagram is shown in figure 4. Note that this method for feature fusion is a generalization of Cross-Stitch networks. The 1×1 convolutional parameters can be learned in such a way to mimic a Cross-Stitch network, but most parameter combinations lead to feature fusion operations which can't be implemented with a Cross-Stitch network.

(Yang and Hospedales, 2016a) proposes an architecture which is related to the cross-talk template, though perhaps only tangentially. In the Sluice network, task-specific and shared parameter tensors from each layer are simply concatenated to form the layer's parameters. The architecture of (Yang and Hospedales, 2016a) also creates an explicit separation between task-specific and shared parameters, but does so using tensor factorization, a well-known approach in the classical MTL literature (Evgeniou and Pontil, 2004; Argyriou et al., 2008; Kumar and Daume III, 2012). Tensor factorization is used in MTL to represent a multi-task model's parameter tensor as a product of two smaller tensors, one shared between tasks and one task-specific, which enforces a different type of division of shared/task-specific feature spaces than, for example, Sluice networks. (Yang and Hospedales, 2016a) extends this approach to the deep learning setting in order to learn the sharing structure at each layer within a deep network. Unfortunately, there is no empirical comparison of this tensor factorization approach with the other cross-talk architectures, and there hasn't been much work extending the tensor factorization approach of (Yang and Hospedales, 2016a) for deep MTL.

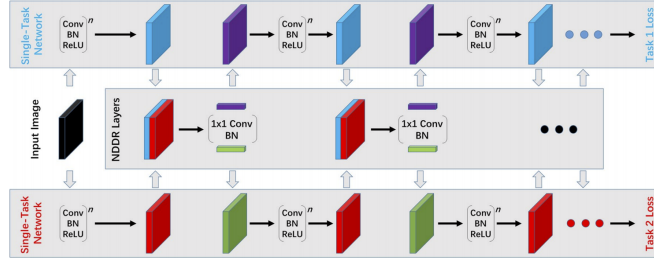

Figure 4: NDDR-CNN network architecture (Gao et al., 2019). Instead of combining information from different task networks with a linear combination of parallel features (as in Cross-Stitch networks (Misra et al., 2016)), NDDR-CNN uses concatenation and a 1×1 convolution to fuse features from separate task networks.

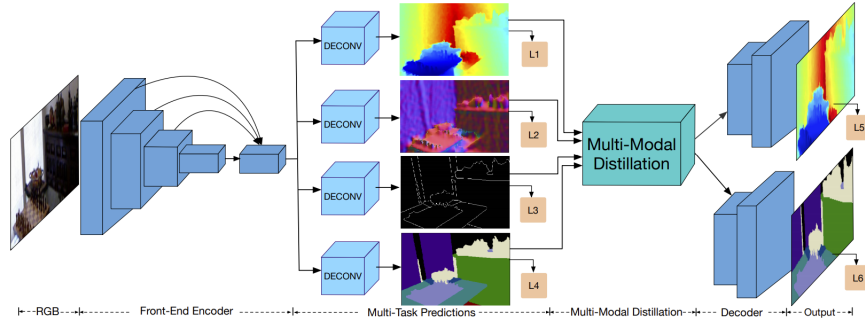

Figure 5: PAD-Net architecture for prediction distillation (Xu et al., 2018a). Preliminary predictions are made for four tasks, then these predictions are re-combined and used to compute final, refined predictions for two output tasks.

2.1.3 Prediction Distillation

A major tenant and popular justification of MTL is that learned features from one task may be useful in performing another related task. Prediction distillation techniques are based on a natural extension of this principle: that the answers to one task may help learning of another. (Vandenhende et al., 2020) provides a great motivating example of this phenomenon: In an MTL setup for jointly learning depth prediction and semantic segmentation, discontinuities in the depth map imply likely discontinuities in semantic segmentation labels, and vice versa. PAD-Net (Xu et al., 2018a), Pattern-Affinitive Propagation (Zhang et al., 2019), and MTI-Net (Vandenhende et al., 2020) each take advantage of this phenomenon for the multi-task learning of computer vision tasks by making preliminary predictions for each task, then combining these predictions to produced final, refined outputs.

PAD-Net (Xu et al., 2018a) is the earliest of these works, introducing an architecture to combine preliminary predictions for depth prediction, scene parsing, surface normal estimation, and contour prediction to produce refined predictions for depth prediction and scene parsing, as pictured in figure 5. The preliminary predictions are recombined using one of three novel variations of a multi-modal distillation module, either using naive feature concatenation, message passing, or attention-guided message passing. Pattern-Affinitive Propagation (PAP) (Zhang et al., 2019) expands on this architecture by introducing an affinity learning layer which learns to represent pair-wise relationships of tasks and combines features from various tasks according to these relationships. PAP also does away with the extra auxiliary tasks of PAD-Net and instead produces both preliminary and final predictions for depth prediction, surface normal estimation, and semantic segmentation. Both of these methods, at the times of their publication, reached state of the art performance on at least one task from the NYU-v2 dataset (Silberman et al., 2012).

This style of architecture is further extended by the recently proposed MTI-Net (Vandenhende et al., 2020), which models task interactions at multiple scales of the receptive field. Specifically, the architecture consists of a backbone that extracts multi-scale features, and features from each scale are used to make preliminary task predictions. The initial predictions from the $1/32$ scale are combined with $1/16$ scale features to form the input for predictions at the $1/16$ scale, then the predictions from the $1/16$ scale are used as input to make predictions at the $1/8$ scale, etc. After predictions are made from each scale, the predictions are distilled between tasks and aggregated across scales to make the final refined task predictions. The motivation behind this multi-scale interaction network comes from the fact that one task's features or ground-truth outputs may only be informative for learning another task at some (but not all) scales. The

authors consider an example of adjacent cars: at the local level, when only considering small image patches, the depth discontinuity between cars suggests that there should be a change in the semantic labels across this discontinuity. At the global level, however, one can see that the objects surrounding the depth discontinuity have the same semantic label, which contradicts the supposed task interaction at the local level. This scenario suggests that multi-scale information should be considered when distilling predictions across tasks, and indeed this model does show a larger improvement over single-task counterparts than high-performing baselines.

2.1.4 Task Routing

Despite their success, shared trunk and cross-talk architectures are somewhat rigid in their parameter sharing scheme. (Strezoski et al., 2019a) presents an architecture which is more flexible, allowing for fine-grained parameter sharing between tasks that occurs at the feature level instead of the layer level. The novel component of this architecture is the Task Routing Layer which applies a task-specific binary mask to the output of a convolutional layer to which it is applied, zeroing out a subset of the computed features and effectively assigning a subnetwork to each task which overlaps with that of other tasks. The binary masks are not learned, instead they are randomly initialized at the beginning of training and fixed from that point on. Although this random initialization doesn't allow for the possibility of a principled parameter sharing scheme between tasks, the user still has control over the degree of sharing between tasks through the use of a hyperparameter σ , known as the sharing ratio. σ takes values between 0 and 1, specifying the proportion of units in each layer which are task-specific, and the random initialization of the binary masks in each layer are executed in a way to fit this constraint. The proposed architecture only requires a small increase in the number of parameters as the number of tasks increases, and experiments demonstrate superior performance over MTL baselines such as the Cross-Stitch network. Impressively, the Task Routing Layer allows for the network to scale up to handle up to 312 tasks simultaneously while maintaining decent performance. The Task Routing Layer is strongly related to the learned architectures Piggyback (Mallya et al., 2018) and Sparse Sharing Architectures (Sun et al., 2019a) (discussed in section 2.5.4), though in these works the binary masks which assign a set of units to each task are learned.

2.1.5 Single Tasking

Nearly every multi-task architecture for computer vision produces output for multiple tasks from the same given input, and each one we have discussed so far satisfies this condition. (Maninis et al., 2019) is, to our knowledge, the only such method which handles a single task at once, but can be used for multiple tasks with multiple forward passes. The authors argue that, since the network only performs inference for a single task at a time, the network is better able to leverage task-specific information and disregard information useful for other tasks. This focusing is accomplished through the use of two different attention mechanisms: task-specific data-dependent modulation (Perez et al., 2018) and task-specific Residual Adapter blocks (Rebuffi et al., 2018). The network is also trained with an adversarial loss (Liu et al., 2017) to encourage the gradients from each task to be indistinguishable. The idea of using an adversarial setup to encourage similar gradient directions between tasks has also been explored outside of the realm of computer vision, and is discussed further in section 3.4.1.

2.2 Architectures for Natural Language Processing

Natural language processing naturally lends itself well to MTL, due to the abundance of related questions one can ask about a given piece of text and the task-agnostic representations which are so often used in modern NLP techniques. The development in neural architectures for NLP has gone through phases in recent years, with traditional feed-forward architectures evolving into recurrent models, and recurrent models being succeeded by attention based architectures. These phases are reflected in the application of these NLP architectures for MTL.

It should also be noted that many NLP techniques could be considered as multi-task in that they construct general representations which are task-agnostic (such as word embeddings), and under this interpretation a discussion of multi-task NLP would include a large number of methods which are better known as general NLP techniques. Here, for the sake of practicality, we restrict our discussion to mostly include techniques which explicitly learn multiple tasks simultaneously for the end goal of performing these tasks simultaneously.

2.2.1 Traditional Feed-Forward

(Collobert and Weston, 2008; Collobert et al., 2011; Liu et al., 2015a) all use traditional feed-forward (non-attention based) architectures for multi-task NLP. Many of these architectures have a structural resemblance to the early shared architectures of computer vision: a shared, global feature extractor followed by task-specific output branches. In this case, however, the features are word representations. (Collobert and Weston, 2008) uses a shared lookup table layer to learn word representations, where the parameters of each word vector are directly learned through gradient descent.

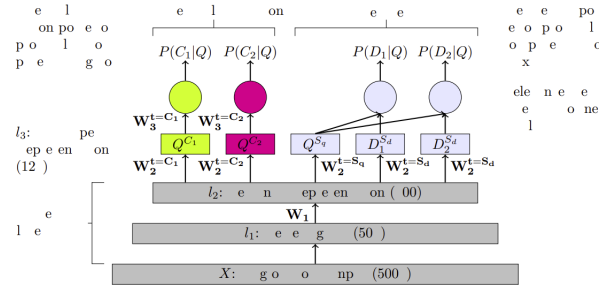

Figure 6: Network architecture of (Liu et al., 2015a). The input is converted to a bag-of-words representation and hashed into letter 3-grams, followed by a shared linear transformation and nonlinear activation function. This shared representation is passed to task-specific overhead heads to compute final outputs for each task.

The remainder of the architecture is task-specific, and comprised of convolutions, max over time, fully connected layers, and a softmax output. The seminal work (Collobert et al., 2011) is motivated by the general principles of MTL: representations which are shared across tasks generalize better, and sharing can improve performance on all tasks. Their architecture is similar to that of (Collobert and Weston, 2008), with lookup tables followed by sequences of convolutions and linear transformations. The main architectural difference is that the first hidden layer (whether it be linear or convolutional) following the lookup tables is shared between tasks. Following this trend, the architecture of (Liu et al., 2015a) has a similar degree of sharing, and is pictured in figure 6. In this case word vectors aren't learned directly. Instead, the input sentence or document is converted into a bag-of-words representation, and hashed into letter 3-grams. These features are then fed into a shared linear projection followed by a tanh activation function, and then fed to task specific output branches.

2.2.2 Recurrence

The introduction of modern recurrent neural networks for NLP yielded a new family of models for multi-task NLP, with novel recurrent architectures introduced in (Luong et al., 2015; Liu et al., 2016a,b; Dong et al., 2015). Sequence to sequence learning (Sutskever et al., 2014) was adapted for multi-task learning in (Luong et al., 2015). In this work, the authors explore three variants of parameter sharing schemes for multi-task seq2seq models, which they name one-to-many, many-to-one, and many-to-many. In one-to-many, the encoder is shared through all tasks, and the decoder is task-specific. This is useful to handle sets of tasks which require differently formatted output, such as translating a piece of text into multiple target languages. In many-to-one, the encoder is task-specific, while the decoder is shared. This is an inversion of the usual parameter sharing scheme in which earlier layers are shared and feed into task-specific branches. The many-to-one variant is applicable when the set of tasks require output in the same format, such as in image captioning and machine translation into the same target language. Lastly, the authors explore the many-to-many variant, in which there are multiple shared or task-specific encoders and decoders. They use this variant, for example, to jointly train an english to german and a german to english translation system, with both an english and german encoder and decoder. The english encoder also feeds into the english decoder to perform an autoencoder reconstruction task, as does the german encoder. A similar sequence to sequence architecture for machine translation is proposed in (Dong et al., 2015) with a focus on training a multi-task network to translate one source language into multiple target languages.

(Liu et al., 2016a) also explores several variants of recurrent multi-task architectures, though in the text classification regime instead of sequence to sequence learning. These parameter sharing schemes are generally more fine-grained than those described in (Luong et al., 2015), with a focus on different methods to allow information flow between tasks. The authors explore three parameter sharing schemes: the Uniform-Layer, Coupled-Layer, and Shared-Layer architectures, which are shown in figure 7. In the Uniform-Layer architecture, each task has its own embedding layer, and all tasks share an embedding layer and an LSTM layer. Let i be a task index, t be the recurrent timestep, and x_t be the t -th word in an input sentence. Then the input to the shared LSTM layer for task i on timestep t is the concatenation of the i -th task specific embedding of x_t with the shared embedding of x_t . For the Coupled-Layer model, each task has its own separate LSTM layer, but each task can read from the LSTM layers of the other tasks. More specifically, the memory content of the LSTM for a given task at timestep t is modified to include a weighted sum of the hidden states of the LSTM layers of each task at timestep $t - 1$, while preserving all other components of the LSTM. Finally, the Shared-Layer architecture allocates a separate LSTM layer for each task, as well as a shared bi-directional LSTM layer that feeds into the task-specific LSTMs.

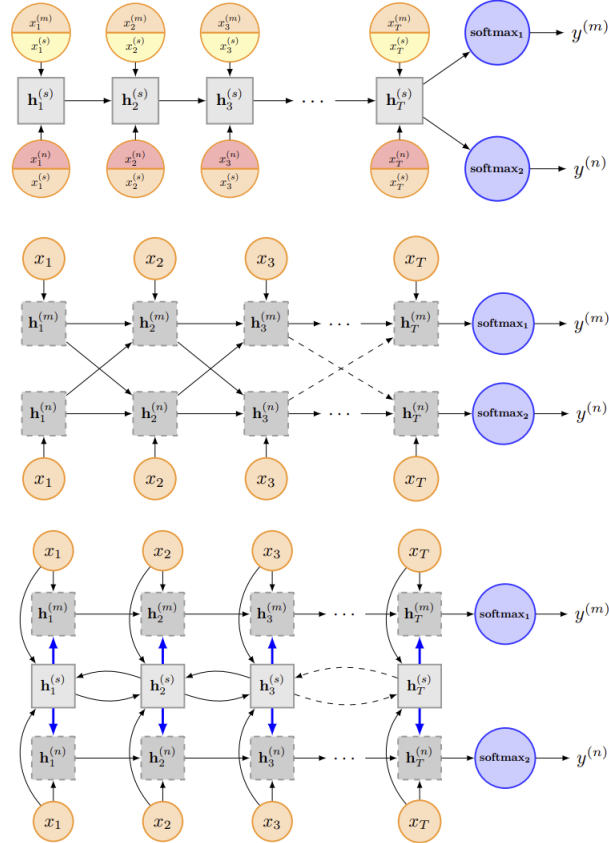

Figure 7: From top to bottom: Uniform-Layer, Coupled-Layer, and Shared-Layer architectures of (Liu et al., 2016a). Each architecture presents a novel partition of recurrent architecture components into shared and task-specific modules.

In addition to these recurrent architectures, (Liu et al., 2016b) augments the LSTM architecture with a memory mechanism. To form a shared architecture, each task has its own LSTM parameters, but the memory is shared among all tasks. The memory mechanism is inspired by the memory enhanced LSTM (ME-LSTM) (Sukhbaatar et al., 2015). The novel contribution of (Liu et al., 2016b) is in a fusion mechanism that allows the memory to be read from and written to jointly by all tasks. With this addition, the hidden state of each task’s LSTM is computed from a gated sum of the LSTM’s internal memory and the information held in the shared external memory. The authors also introduce a variant in which each task has its own private external memory, and the shared global external memory is read/written by each task-specific memory module.

2.2.3 Cascaded Information

In all of the NLP architectures we have discussed so far, the sub-architectures corresponding to each task have been symmetric. In particular, the output branch of each task occurs at the maximum network depth for each task, meaning that supervision for the task-specific features of each task occurs at the same depth. Several works (Søgaard and Goldberg, 2016; Hashimoto et al., 2016; Sanh et al., 2019) propose supervising “lower-level” tasks at earlier layers so that the features learned for these tasks may be used by higher-level tasks. By doing this we form an explicit task hierarchy, and provide a direct way for information from one task to aid in the solution of another. We refer to this template for iterated inference and feature combination as *cascaded information*, with an example pictured in figure 8.

(Søgaard and Goldberg, 2016) forms this hierarchy by choosing POS tagging as a low-level task to inform syntactic chunking and CCG supertagging. Their network architecture is made of a series of bi-directional RNN layers, and for each task i there is an associated layer ℓ_i from which the task-specific classifier for task i stems. In this case, the associated layer for POS tagging occurs earlier in the network than the associated layers of syntactic chunking and CCG supertagging, so that the learned POS features can inform the tasks of syntactic chunking and CCG supertagging. Not long after the publication of (Søgaard and Goldberg, 2016), (Hashimoto et al., 2016) achieved a mix of SOTA and

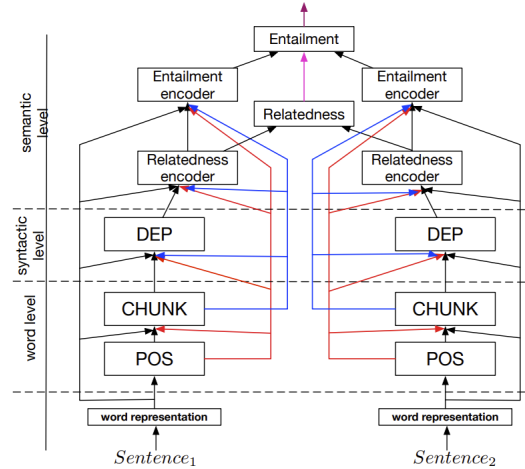

Figure 8: Various task supervision in various layers from (Hashimoto et al., 2016). Lower level tasks are supervised at earlier layers.

SOTA-competitive results on several language tasks by constructing a similarly supervised architecture with 5 tasks: POS tagging, chunking, dependency parsing, semantic relatedness, and textual entailment. The authors also replace the bi-directional RNN units of (Søgaard and Goldberg, 2016) with bi-directional LSTM units. Figure 8 shows their architecture.

Besides the increase in the number of tasks, this method also introduces a regularization term to avoid training interference between the tasks. Each time a task’s dataset is sampled for training, the squared Euclidean distance between the pre-update parameters and the current model parameters is added to the loss function. This encourages the network parameters not to stray too far from the parameter configuration which was learned by training on a different task on the previous epoch.

Following these two works, (Sanh et al., 2019) introduces a similarly inspired model for a different set of tasks, achieving SOTA results for Named Entity Recognition, Entity Mention Detection and Relation Extraction. In order from lowest to highest, the task hierarchy in this work is NER, EMD, and coreference resolution/relation extraction (equally ranked as highest level).

2.2.4 Adversarial Feature Separation

In a novel application of adversarial methods, (Liu et al., 2017) introduces an adversarial learning framework for multi-task learning in order to distill learned features into task-specific and task-agnostic subspaces. Their architecture is comprised of a single shared LSTM layer and one task-specific LSTM layer per task. Once the input sentence from a task is passed through the shared LSTM layer and the task-specific LSTM layer, the two outputs are concatenated and used as the final features to perform inference on. However, the features produced by the shared LSTM layer are also fed into the task discriminator. The task discriminator is a linear transformation followed by a softmax layer that is trained to predict which task the original input sentence came from. The shared LSTM layer is then trained to jointly minimize the task loss along with the discriminator loss, so that the features produced by the shared LSTM do not contain any task-specific information. In addition, the shared features and the task specific features are encouraged to encode separate information with the use of an orthogonality penalty (similar to (Ruder et al., 2019)) on the resulting features. More specifically, the orthogonality loss is defined as the squared Frobenius norm of the product of the task-specific features and the shared features. This loss is added to the overall training objective, in order to encourage the task-specific and the shared features to be orthogonal. These two auxiliary losses enforce the separation of task-specific and task-agnostic information in the shared network.

2.2.5 BERT for MTL

Despite the popularity of the Bidirectional Encoder Representations from Transformers (BERT) (Devlin et al., 2018), there have been surprisingly little applications of the text encoding method for MTL. (Liu et al., 2019b) extends the work of (Liu et al., 2015a) by adding shared BERT embedding layers into the architecture. The network architecture overall is quite similar to (Liu et al., 2019b), the only difference being the addition of BERT contextual embedding

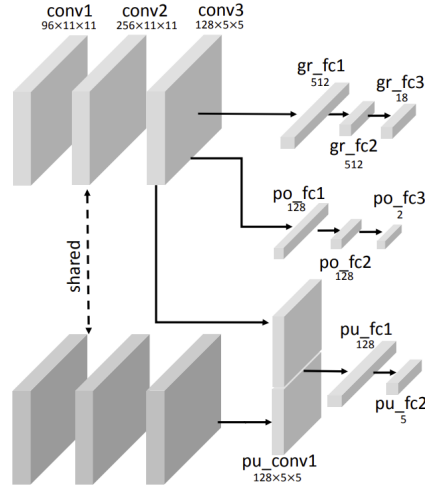

Figure 9: Shared architecture for robotic grasping, pushing, and poking (Pinto and Gupta, 2017).

layers following the input embedding vectors in figure 6. This new MTL architecture, named MT-DNN, achieved SOTA performance on eight out of nine GLUE tasks (Wang et al., 2018) at the time of its publication.

2.3 Architectures for Reinforcement Learning

In recent years, many of the advances in reinforcement learning have focused on optimization and training methods (Schulman et al., 2017; Haarnoja et al., 2018; Akkaya et al., 2019). Since many RL problems don't necessarily involve complex perception, such as working with words or pixels, the architectural demand isn't as high for many RL problems. Because of this, many deep networks for RL are simple fully-connected, convolutional, or recurrent architectures. However, in the multi-task case, there are several instances of interesting works which leverage information between tasks to create improved architectures for RL.

2.3.1 Joint Task Training

Several works in RL have found that task performance can be improved by simply training for multiple tasks jointly, with or without parameter sharing. (Pinto and Gupta, 2017) uses a shared trunk architecture (shown in figure 9 to jointly learn robotic grasping, pushing, and poking from pixels. The shared feature extractor consists of three convolutional layers, and these shared features are fed to three task-specific output branches. The grasping and poking output branches are made of three fully-connected layers each, and the pushing branch has one convolutional layer, followed by two fully-connected layers. This shared network is trained with a supervised loss which is an average of cross-entropy and squared Euclidean losses, one for each task. The network actions are parameterized in such a way to allow for supervised training. The authors find that this shared network trained with 2500 examples of both pushing and grasping outperforms a task-specific grasping network trained with 5000 examples. (Zeng et al., 2018) also finds advantages by jointly training with robotic pushing and grasping, though their architecture does not employ any parameter sharing. The network is comprised of two separate fully convolutional Q-networks, one for pushing and one for grasping. The two networks are, however, given a joint training signal. The reward for a timestep t is defined as follows: if a grasping action is chosen at timestep t and the grasp is successful, the reward is 1. If a pushing action is chosen at timestep t and the action causes a sufficiently large change in the environment, then the reward is 0.5. From this reward, there is no explicit encouragement of one task to aid another. But when both networks are jointly trained to maximize the same reward, the pushing network learns to push in a way that influences the environment to maximize the grasping reward. This joint training setup was shown to be much more sample efficient than baselines, making training on a physical robot feasible with only a few hours of training.

2.3.2 Modular Policies

There have been many similarities between the various parameter sharing schemes that we have discussed so far, but modular networks are present a novel family of parameter sharing methods which are totally different from the shared trunk or cross-talk architectures from sections 2.1.1 and 2.1.2. In modular learning setups, each task's network

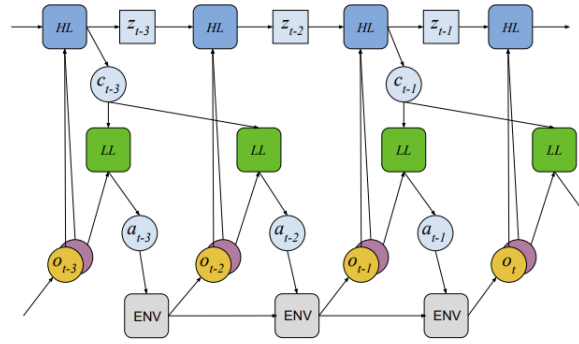

Figure 10: Shared modular architecture for locomotion with multiple robots (Heess et al., 2016). Note that the high-level module updates the modulated input to the low-level module at a different frequency than it itself receives input from the environment.

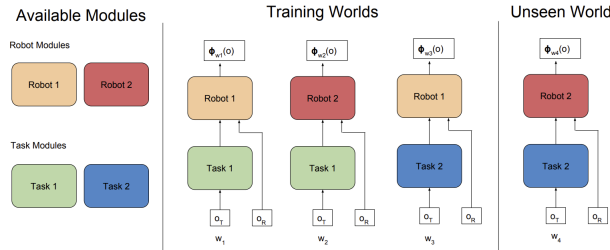

Figure 11: Shared modular architecture for multi-task and multi-robot transfer (Devin et al., 2017). Each network is made of two modules, one robot module and one task module. Each robot module can be combined with a task module to form a network to perform each (task, robot) pair.

architecture is composed of a combination of smaller sub-networks, and these smaller sub-networks are combined in different ways for different tasks. Just as MTL is motivated by generality through shared representations, modular learning offers generality of computation through shared neural building blocks. The goal of these setups is to learn building blocks which are general enough to be useful as a part of the network architecture for multiple tasks. We discuss several other learned modular architectures in sections 2.5 and 2.6, but here we only discuss those modular methods for which the parameters of the building blocks are learned and the configuration of building blocks for each task remains fixed. Discussion of modular methods with learned building block combinations can be found in the aforementioned sections.

Within weeks of each other, (Heess et al., 2016) and (Devin et al., 2017) both introduced modular neural network policies for multi-task learning across various robots. The architectures of each of these works are depicted in figures 10 and 11, respectively.

The task architecture of (Heess et al., 2016) is made of two modules, a low-level “spinal” network and a high-level “cortical” network. The spinal network has access to proprioceptive information like muscle tension, and it chooses motor actions, while the cortical network has access to all observations and modulates inputs to the spinal network. It is important to note that the proprioceptive information given to the spinal network is always task-independent, so that the spinal network must learn task-independent representations. In their experiments, the low-level/spinal network is feed-forward, while the high-level/cortical network is recurrent. The combination of the division of labor between the two modules and the information hiding from the spinal network allows for a pre-trained spinal network to be deployed with a new cortical network to quickly solve a new task with the same robot body. The usage of the pre-trained spinal network allows for effective exploration in the robot body, despite the new task.

The architecture of (Devin et al., 2017) is similarly inspired, but employs parameter sharing for the network controllers between different robots as well as between tasks. Each task and robot has its own network module. The network for each task/robot pair is composed of the corresponding task-specific module, followed by the corresponding robot-specific module, as shown in figure 11. Because each module is shared between tasks and robots, it is constrained

to learn information which is general across its domains. The authors also show that the learned modules can be paired in combinations unseen during training, to instantiate a policy with zero-shot generalization capabilities. This method also gives partial information to the task module; each observation is decomposed into a task-specific portion and a robot-specific portion. The task-specific module only receives the task-specific observation as input, and the robot-specific module receives the robot-specific observation as well as the output of the task-specific module.

Both of these architectures exhibit an interesting strategy for learning general representations across tasks: *information hiding*. We have so far discussed parameter sharing, adversarial methods, and orthogonality constraints as regularization strategies for multi-task methods. But the division of labor brought forth by the modularity in these two architectures allows for information to be restricted to certain modules in the network, forcing the modules missing this information to learn representations which are invariant to the omitted information. In this case, we obtain modules which are invariant to the task at hand.

RL with Policy Sketches (Andreas et al., 2017) is another template for policy modularity which was proposed soon after (Heess et al., 2016) and (Devin et al., 2017), in which the policy for a task is composed of several subpolicies, and each subpolicy is a neural network whose parameters are shared between tasks. The composition of subpolicies for each task is defined by a human-provided “policy sketch”, which roughly outlines the steps to complete a task. For example, in the minecraft-inspired environment used for evaluation in the paper, the tasks “Make Planks” and “Make Sticks” may have the policy sketches (get wood, use workbench) and (get wood, use toolshed), respectively. In this case, the policies for these tasks would use the subpolicies π_{wood} , π_{bench} , and π_{shed} , with the compositions $\pi_{\text{planks}} = (\pi_{\text{wood}}, \pi_{\text{bench}})$ and $\pi_{\text{sticks}} = (\pi_{\text{wood}}, \pi_{\text{shed}})$. The weak supervision provided by the policy sketches defines a sharing structure of subpolicies between tasks, which was shown to be more beneficial to learning than unsupervised option discovery. This process is similar to how the syntactical structure of a question defines the composition of subpolicies in Neural Module Networks (Andreas et al., 2016) (discussed in section 2.6), though in that example the composed architecture is dependent on each individual given question, while the composition of subpolicies remains fixed for each task with Policy Sketches. It is important to note that module composition takes two different forms with Policy Sketches and the architectures of (Heess et al., 2016) and (Devin et al., 2017): subpolicies in Policy Sketches behave as in hierarchical reinforcement learning (Kulkarni et al., 2016), where a subpolicy is chosen to act as the policy until some termination condition is met, as opposed to composition in the sense of function composition as in (Heess et al., 2016) and (Devin et al., 2017).

2.3.3 Multiple Auxiliary Tasks

(Jaderberg et al., 2016) introduces several unsupervised auxiliary tasks to be learned in conjunction with a main task, as an additional form of supervision. These auxiliary tasks encourage general representations in the usual sense for MTL, but they also help to decrease the sparsity of rewards in the original task. The architecture is a CNN-LSTM actor-critic with a shared trunk, and output branches for each auxiliary task that requires its own output. The auxiliary tasks themselves are called pixel control, feature control, and reward prediction. Pixel control shares parameters from the agent CNN and LSTM, and branches off into a task-specific branch that chooses its own actions. The actions are rewarded for causing maximal change in the pixel intensity of the pixels observed as a result of the chosen action. Feature control does not require an output, and instead the agent is rewarded for activating the hidden units of a given hidden layer of the agent network. Lastly, reward prediction uses the agent’s CNN to map three recent frames to a prediction of the reward on the next step. These auxiliary tasks do not require any supervision that isn’t provided by the environment dynamics and are general enough to apply to many different problem settings. Training an agent with these simple auxiliary tasks led to SOTA performance on the Arcade Learning Environment (Bellemare et al., 2013).

2.4 Multi-Modal Architectures

In sections 2.1, 2.2, and 2.3, we discussed the multi-task architectures which were specifically designed to handle data in one fixed domain. Here, we describe architectures to handle multiple tasks using data from multiple domains, which is usually some combination of visual and linguistic data. Multi-modal learning is an interesting extension of many of the motivating principles behind multi-task learning: sharing representations across domains decreases overfitting and increases data efficiency. In the multi-task single modality case, the representations are shared across tasks but within in a single modality. However, in the multi-task multi-modal case, representations are shared across tasks and across modes, providing another layer of abstraction through which the learned representations must generalize. This suggests that multi-task multi-modal learning may yield an increase in the benefits already exhibited by multi-task learning.

(Nguyen and Okatani, 2019) introduces an architecture for shared vision and language tasks by using dense co-attention layers (Nguyen and Okatani, 2018), in which tasks are organized into a hierarchy and low-level tasks are supervised at earlier layers in the network. Dense co-attention layers were developed for visual question answering, specifically for the integration of visual and linguistic information. This setup of task supervision is similar to the cascaded information architectures discussed in section 2.2.3. However, instead of hand-designing a hierarchy of tasks, this method performs a

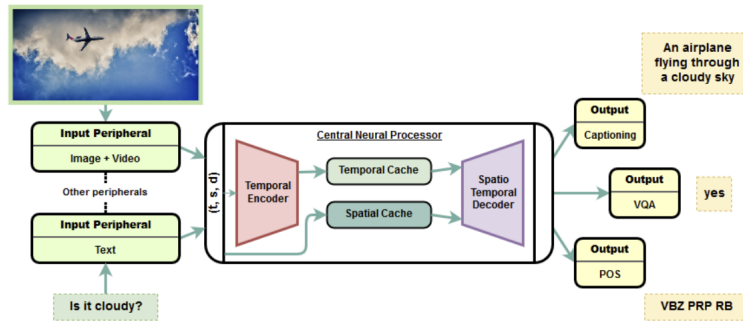

Figure 12: OmniNet architecture proposed in (Pramanik et al., 2019). Each modality has a separate network to handle inputs, and the aggregated outputs are processed by an encoder-decoder called the Central Neural Processor. The output of the CNP is then passed to several task-specific output heads.

search over the layers for each task in order to learn the task hierarchy. The architecture of (Akhtar et al., 2019) handles visual, audio, and text input to classify emotion and sentiment in a video of a human speaker, using bi-directional GRU layers along with pairwise attention mechanisms for each pair of modes to learn a shared representation incorporating all modes of input.

Both (Nguyen and Okatani, 2019; Akhtar et al., 2019) are focused on a set of tasks which all share the same fixed set of modalities. Instead, (Kaiser et al., 2017) and (Pramanik et al., 2019) focus on building a “universal multi-modal multi-task model”, in which a single model can handle multiple tasks with varying input domains. The architecture introduced in (Kaiser et al., 2017) is comprised of an input encoder, an I/O mixer, and an autoregressive decoder. Each of these three blocks is made of a mix of convolutions, attention layers, and sparsely-gated mixture-of-experts layers. The authors also demonstrate that the large degree of sharing between tasks yields significantly increased performance for tasks with limited training data. Instead of aggregating mechanisms from various modes of deep learning, (Pramanik et al., 2019) introduces an architecture called OmniNet with a spatio-temporal cache mechanism to learn dependencies across spatial dimensions of data as well as the temporal dimension. A diagram is shown in figure 12. Each input modality has a corresponding “peripheral” network, and the outputs of these networks are aggregated and fed into the Central Neural Processor, whose output is fed to task-specific output heads. The CNP has an encoder-decoder architecture with a spatial cache and a temporal cache. OmniNet reached SOTA-competitive performance on POS tagging, image captioning, visual question answering, and video activity recognition.

Most recently, (Lu et al., 2020) introduces a multi-task model that handles 12 different datasets simultaneously, aptly named 12-in-1. Their model achieves superior performance over the corresponding single-task models on 11 out of 12 of these tasks, and using multi-task training as a pre-training step leads to SOTA performance on 7 of these tasks. The architecture is based on the ViLBERT model (Lu et al., 2020), and is trained using a mix of methods such as dynamic task scheduling, curriculum learning, and hyperparameter heuristics.

2.5 Learned Architectures

As we have already seen in the preceding sections, there have been many developments in the design of shared architectures to emphasize the strengths of multi-task learning while mitigating the weaknesses. Another approach to architecture design for multi-task learning is to learn the architecture as well as the weights of the resulting model. Many of the following methods for learning shared architectures allow for the model to learn how parameters should be shared between tasks. With a varying parameter sharing scheme, the model can shift the overlap between tasks in such a way that similar tasks have a higher degree of sharing than unrelated tasks. This is one potential method for mitigating negative transfer between tasks: if two tasks exhibit negative transfer, the model may learn to keep the parameters for those tasks separate. Going further, it may be the case that two tasks exhibit positive transfer in some parts of the network, and negative transfer in others. In this case, designing a parameter sharing scheme by hand to accommodate various task similarities at different parts of the network becomes infeasible, especially as the number of tasks and the size of the network grows. Learned parameter sharing offers a way to facilitate adaptive sharing between tasks to a level of precision that isn’t realistic for hand designed shared architectures.

We roughly categorize the methods for learned architectures into four groups: architecture search, branched sharing, modular sharing, and fine-grained sharing. The boundaries between these groups aren’t concrete, and they are often blurred, but we believe this is a useful way to broadly characterize the patterns in the recently developed methods.

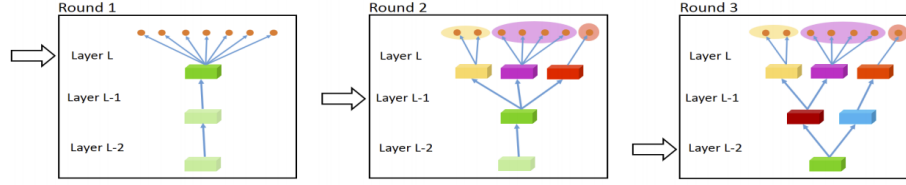

Figure 13: Learned branching architecture proposed in (Lu et al., 2017). At the beginning of training, each task shares all layers of the network. As training goes on, less related tasks branch into clusters, so that only highly related tasks share as many parameters.

Branched sharing methods are a coarse-grained way to share parameters between tasks. Once the computation graphs for two tasks differ, they never rejoin (see figure 13). *Modular sharing* represents a more fine-grained approach, in which a set of neural network modules is shared between tasks, where the architecture for each task is made by a task-specific combination of some or all of the modules, as in figure 16. Lastly, the most fine-grained approach to parameter sharing is what we simply call *fine-grained sharing*, in which sharing decisions occur at the parameter level instead of the layer level, as shown in figure 17.

2.5.1 Architecture Search

Each of (Wong and Gesmundo, 2017; Liang et al., 2018; Gao et al., 2020) introduces a method for multi-task architecture search, but with completely different approaches. (Wong and Gesmundo, 2017) introduces the Multi-task Neural Model Search (MNMS) controller. This method doesn't involve a single network which is shared between all tasks. Instead, the MNMS controller is trained simultaneously on all tasks to generate one individual architecture for each task. The method is an extension of (Zoph and Le, 2016), where an RNN controller iteratively makes architecture design choices, and is trained with reinforcement learning to maximize the expected performance of the resulting network. In the multi-task variant, the RNN also uses task embeddings, which are learned jointly with the MNMS controller, to condition architectural design choices on the nature of the task.

On the other hand, (Liang et al., 2018) introduces several variations of a multi-task neural architecture search algorithm that uses evolutionary strategies to learn neural network modules which can be reordered differently for various tasks. This method is an extension of the Soft Layer Ordering introduced in (Meyerson and Miikkulainen, 2017) (discussed in section 2.3.2). Just as in (Meyerson and Miikkulainen, 2017), the method of (Liang et al., 2018) involves learning neural network modules jointly with their ordering for various tasks. In the architecture search extension, the architecture of the modules is learned along with their routing for individual tasks. The most sophisticated variant of this algorithm is called Coevolution of Modules and Task Routing (CMTR), in which the CoDeepNEAT algorithm (Miikkulainen et al., 2019) is used to evolve the architecture of the shared group modules in an outer loop, and the task specific routings of these modules are evolved in an inner loop.

Most recently, (Gao et al., 2020) proposes MTL-NAS as a method for gradient-based architecture search in MTL. All architectures in this search space are made of a set of fixed-architecture single-task backbone networks, one for each task, and the search process operates over feature fusion operations between different layers of these single-task networks. The feature fusion operations are parameterized by NDDR (from NDDR-CNN (Gao et al., 2019), see section 2.1.2), which is essentially a 1×1 convolution acting on concatenations of feature maps from different tasks. This method also introduces a minimum entropy objective on the weights of the fusion operations, so that the search process converges to a discrete architecture during the architecture search phase, which diminishes the need for a discretization of a soft combination of architectures as in other NAS works (Liu et al., 2018) and closes the performance gap between learned soft architectures and the final discretized version. The final learned architectures were shown to outperform common multi-task baselines on the NYU-v2 (Silberman et al., 2012) and Taskonomy (Zamir et al., 2018) datasets.

2.5.2 Branched Sharing

(Lu et al., 2017) is one of the earliest methods for learned parameter sharing in multi-task deep learning. The idea is to start with a network which is shared between all tasks up to task-specific output heads, then iteratively decouple parameters between tasks layer by layer, starting with the layer closest to the output heads, and moving to the earlier layers. A diagram of this process is shown in figure 13. When a shared layer splits into multiple task specific layers, tasks are clustered based on an estimate of pairwise task affinity. These task affinities are computed according to the following principle: two tasks are likely related if the same input data is equally easy/difficult for the models corresponding to each task.

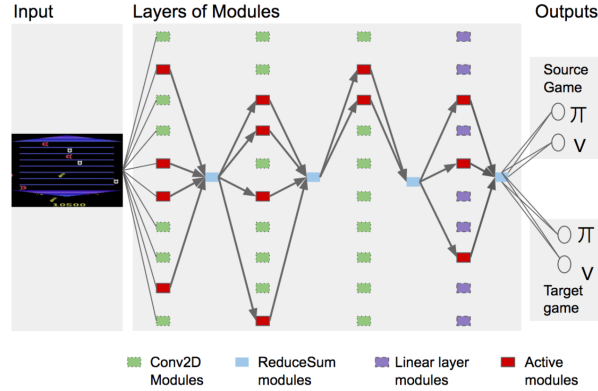

Figure 14: Example PathNet architecture (Fernando et al., 2017). A large network is shared by many tasks, but each task only uses a subnetwork which is evolved through a tournament selection genetic algorithm.

More recently, (Vandenhende et al., 2019) proposes a similar method with a different criterion for task grouping. Instead of concurrent sample difficulty, this algorithm uses representation similarity analysis (RSA) (Kriegeskorte, 2008) as a measure of task affinity. RSA is built on the principle that similar tasks will rely on similar features of the input, and will therefore learn similar feature representations. The other important difference between these methods is that (Vandenhende et al., 2019) computes the branching structure globally instead of greedily by layer. However, the search over all branching structures is computationally expensive, so the authors resort to a beam search strategy for computing the branching structure from the representation similarities across tasks in different parts of the network. This paper includes a direct comparison of the two methods, and the RSA-based variant is shown to be superior. RSA is also used in some methods to learn explicit task relationships, which are discussed in section 4.

2.5.3 Modular Sharing

The earliest work on modular parameter sharing in multi-task learning that we are aware of is PathNet (Fernando et al., 2017). A PathNet model is one large neural network which is used for multiple tasks, though different tasks have different computation pathways within the larger model. A diagram is shown in figure 14. The pathway for each task is learned through a tournament selection genetic algorithm, in which many different candidate pathways compete and evolve towards an optimal subnetwork of the larger network. While this idea is mostly general and can be applied to various settings, such as multi-task learning and meta-learning, the authors deploy this model for continual learning with two reinforcement learning tasks. The weights learned during training on the first task are fixed during training of the second task, during which new pathways through the network are evolved to complete the task at hand.

Soft Layer Ordering (Meyerson and Miikkulainen, 2017) and Modular Meta-Learning (Alet et al., 2018) are two concurrent works of modular MTL, similar but with an important difference. Each of these methods learns a shared set of neural network modules which are combined in different ways for different tasks, with the hope that a network “building block” will learn generally applicable knowledge if it is used in various contexts within the different task networks. Soft Layer Ordering parameterizes a task network by computing a convex combination of each module’s output at each layer of the network, as shown in figure 15. With this parameterization, each learned module can contribute to each level of depth in the network. In contrast, Modular Meta-Learning learns a computation graph over the modules, meaning that each step of the computation is a discrete composition of a small number of modules, instead of a soft combination of all of them. The difference in the parameterization of the computation graph between these methods leads to different optimization strategies, namely, the computation graph in Soft Layer Ordering architectures can be optimized with gradient descent jointly with the network weights, since the composition of the modules is a differentiable operation. In comparison, the computation graph in Modular Meta-Learning is a discrete structure, so gradient-based optimization methods cannot be used to learn the graph over modules for each task. Instead, the authors employ simulated annealing, a black box optimization method, to learn the computation graph. While this two-level optimization incurs computational cost, the discrete nature of the computation graph affords the ability to produce an inductive bias in the resulting model, which the soft sharing of layers does not exhibit. These methods represent two realizations of a broadly generalizable template that many other methods have employed: Learn individual network pieces, and learn how to combine them.

The method of (Chen et al., 2018) is another strategy in this spirit, and closely resembles NAS (Zoph and Le, 2016). This paper proposes a method that fits the template described above, but the composition of modules is not directly

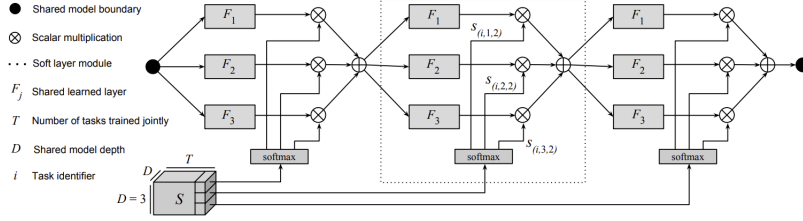

Figure 15: Soft Layer Ordering with three learned layers (Meyerson and Miikkulainen, 2017). Each layer of the network is a linear combination of several network modules, and the weights of these combinations are task-specific.

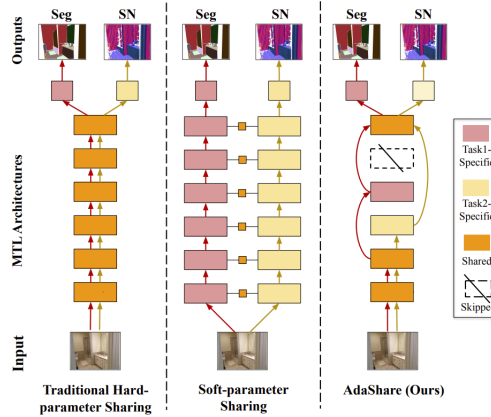

Figure 16: A learned parameter sharing scheme with AdaShare (Sun et al., 2019b). Each layer in the network is either included or ignored by each task, so that each task uses a subnetwork which is (likely) overlapping with other tasks.

parameterized and learned such as in Soft Layer Ordering and Modular Meta-Learning. Instead, this method trains an RNN controller to choose a layer from a fixed set of layers to iteratively build an architecture as a sequence of modules, and the module is again trained with reinforcement learning to maximize the expected performance of the constructed architecture. This method bears a strong resemblance to the previously discussed Multi-task Neural Model Search controller (Wong and Gesmundo, 2017), with the main difference being that the RNN controller used in (Chen et al., 2018) simply chooses between a set of network modules, while the MNMS controller makes architectural design decisions.

Most recently, AdaShare (Sun et al., 2019b) is an algorithm for modular MTL in which each task architecture is comprised of a sequence of network layers. Each layer in the shared set is either included or omitted from the network for each task. An example is shown in figure 16. Along with the weights of each layer, AdaShare learns an $N \times L$ array of binary values, where N is the number of tasks, L is the total number of shared layers, and the (i, ℓ) -th element of the binary array denotes whether layer ℓ is included in the model of the i -th task. Since the output of a task’s network is not differentiable with respect to these binary values, the method adopts Gumbel-Softmax sampling (Jang et al., 2016) to optimize these parameters with gradient descent jointly with the network weights. This strategy makes an interesting medium between Soft Layer Ordering (Meyerson and Miikkulainen, 2017) and Modular Meta-Learning (Alet et al., 2018), in which each shared module is shared discretely instead of softly, but the computation graph can still be learned with gradient descent. AdaShare also employs several regularization terms to encourage sharing in the lower-level modules and sparsity in the resulting task-specific networks, which are discussed in section 3.2.

2.5.4 Fine-Grained Sharing

Fine-grained parameter sharing schemes are the most recently introduced MTL architecture type, and they allow for more flexible information flow between tasks than sharing at the layer or multi-layer level. Piggyback (Mallya et al., 2018) is a method for adapting a pre-trained network on a related task by learning to mask out individual weights of the original network. This allows for the storage of a newly trained model with a storage cost of only one additional bit per parameter of the original model while preserving the original network function. Despite the fact that the network output is not differentiable with respect to these network masks, these network masks are optimized through gradient descent jointly with the network weights by using a continuous relaxation of the mask values as a noisy estimate of the

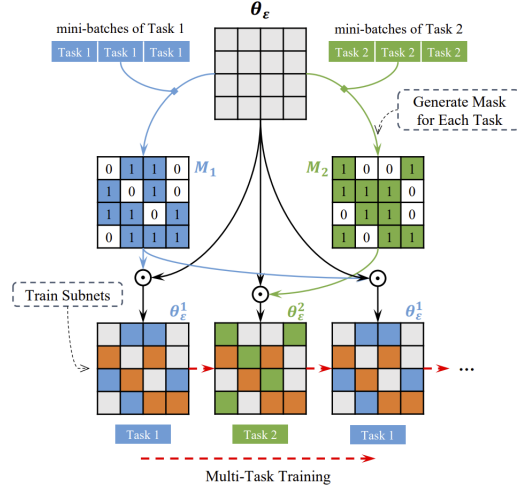

Figure 17: Learned fine-grained sharing architecture from (Sun et al., 2019a). Each task has a sparse subnetwork which may or may not overlap with that of other tasks. Each subnetwork is extracted using Iterative Magnitude Pruning (Frankle and Carbin, 2018) on the entire randomly initialized network before training.

binary mask values. This method of optimizing such mask values is justified in prior work on binarized neural networks (Courbariaux et al., 2015).

(Newell et al., 2019) and (Bragman et al., 2019) are concurrent works that each propose a parameter sharing scheme for multi-task CNNs in which sharing occurs at the filter level. For each convolutional layer of a multi-task network, the method of (Newell et al., 2019) learns a binary valued $N \times C$ array M , where N is again the number of tasks and C is the number of feature channels in a given layer of the network. The (i, c) -th element of M denotes whether the model of the i -th task should include the c -th feature map in the considered layer. Instead of optimizing this binary valued array with a Gumbel-Softmax (Jang et al., 2016) distribution, the authors do not learn these values directly. Rather, the method learns a real-valued matrix P of size $N \times N$, with values in the range $[0, 1]$, where the (i, j) -th element of P represents the proportion of feature channels which are shared by both the models for task i and task j . In this way, the relationships between tasks are learned directly, and an array M which satisfies $P = \frac{1}{C} M^T M$ is sampled after each new value of P is computed. With this parameterization of M , the network architecture isn't directly learned, but is instead sampled so that the learned task affinity matrix dictates the amount of overlap between task parameters. This task affinity matrix, P , is learned through evolutionary strategies. (Bragman et al., 2019) proposes Stochastic Filter Groups (SFGs), in which the assignment of a convolutional filter to task-specific or shared is learned through variational inference. More specifically, SFGs are trained by learning the posterior distribution over the possible assignment of convolutional filters to task-specific or shared roles. As far as we know, SFGs are the only probabilistic approach to multi-task architecture learning.

(Sun et al., 2019a) introduces an algorithm for learning a fine-grained parameter sharing scheme by extracting sparse subnetworks of a single fully shared model. From a randomly initialized, overparameterized network, the authors employ Iterative Magnitude Pruning (IMP) (Frankle and Carbin, 2018) to extract a sparse subnetwork from the larger network for each individual task. IMP prunes a network by training for a small number of epochs, then removing the weights which have the smallest magnitude until a desired level of sparsity is reached. Given a reasonable level of sparsity, the extracted subnetworks for each task will overlap and exhibit fine-grained parameter sharing between tasks. A diagram is shown in figure 17. It is important to note that the degree of overlap between the extracted subnetworks of two tasks is not necessarily correlated with the relatedness of those two tasks, which suggests the need for a fine-grained parameter sharing scheme which incorporates information of task affinity to construct appropriate sharing mechanisms between tasks.

2.6 Conditional Architectures

Conditional or adaptive computation (Bengio et al., 2013) is a method in which parts of a neural network architecture are selected for execution depending on the input to the network. Conditional computation is used in many areas outside of multi-task learning, such as to decrease model computational cost and in hierarchical reinforcement learning (Kulkarni et al., 2016). In the multi-task case, a conditional architecture is dynamic between inputs as well as between tasks,

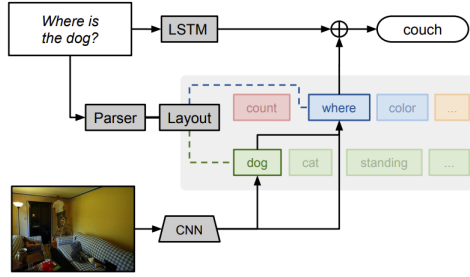

Figure 18: Example Neural Module Network execution (Andreas et al., 2016). The semantic structure of a given question is used to dynamically instantiate a network made of modules that correspond to the elements of the question.

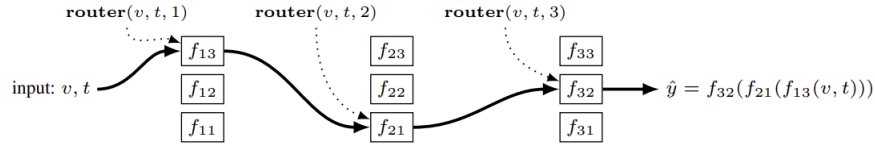

Figure 19: Example Routing Network execution (Rosenbaum et al., 2017). The router iteratively chooses a layer to apply to the input to dynamically instantiate a network for each input.

though the components of these dynamically instantiated architectures are shared, which encourages these components to be generalizable between various inputs and tasks.

Neural Module Networks (Andreas et al., 2016) are an early work of conditional computation which were specifically designed for visual question answering. This method leverages the compositional structure of questions in natural language to train and deploy modules specifically catered for the individual parts of a question. The structure of a given question is determined by a non-neural semantic parser, specifically the Stanford Parser (Klein and Manning, 2003). The output of the parser is used to determine the compositional pieces of the question and the relationships between them, and the corresponding neural modules are used to dynamically instantiate a model for the given question. This process is shown in figure 18. While this work paved the way for future methods of conditional computation, it is lacking in the sense that the composition of modules is not learned. Therefore, the role of each module and combination of modules is fixed and cannot be improved.

Routing Networks (Rosenbaum et al., 2017) and the Compositional Recursive Learner (CRL) (Chang et al., 2018) are more recent related works of conditional computation in which the composition of modules is learned in addition to the weights of the modules themselves. A Routing Network is comprised of a router and a set of neural network modules. Given a piece of input data, the router iteratively chooses a module from the set of network modules to apply to the input for a fixed number of iterations; this process is shown in figure 19. The router can also choose a “pass” action instead of a module, which simply continues to the next iteration of routing. The module weights can be learned directly through backpropagation, and the router weights are learned with reinforcement learning to maximize the performance of the dynamically instantiated networks on their inputs. The Compositional Recursive Learner of (Chang et al., 2018) is similar, though with some key differences. Given a piece of input data, the CRL also iteratively chooses a network module from a fixed set of modules through which to route the input. In the case of the CRL, any task specific information (such as a task ID) is intentionally hidden from the network modules, to ensure that the modules learn task-agnostic and therefore generalizable information. CRL is also trained with reinforcement learning on a curriculum, to encourage the re-use of modules learned on easier problems.

(Ahn et al., 2019) introduces a very similar architecture in which layers of varying configuration and scale are chosen from a larger backbone network through which to route the input. The router (called the selector network in this variant) is again trained with reinforcement learning.

The architecture of (Kirsch et al., 2018) is similarly inspired to Routing Networks and the CRL, but takes a local view of routing rather than a global one. In Routing Networks and the CRL, any of the network modules can be placed into an instantiated network at any depth. In contrast, (Kirsch et al., 2018) proposes a conditional architecture in which routing decisions are made only within layers of the network. The architecture is made of a series of modular layers, each having m network modules. When a layer is to be applied to an input, the input is passed through a controller, which selects k modules from the set of m modules belonging to the layer. The layer input is then individually passed

through each of the k selected modules, and the results are added or concatenated to form the output of the layer. The controllers in these modular layers are trained not with reinforcement learning but with variational methods, where the module choice is treated as a latent variable. The authors argue that the architectural differences in their model from past works on conditional computation diminish the occurrence of *module collapse*, a well-known weakness of conditional models. When module collapse occurs, the router selects only a small number of modules from the available set, while the remaining modules remain mostly unused, and the resulting models do not exhibit modularity.

Most recently, Soft Modularization (Yang et al., 2020) is another conditional approach, which can be seen as a soft relaxation of Routing Networks. Soft Modularization uses both a router network and a policy network composed of L layers, each with m modules. Instead of making a discrete decision and choosing one module at each step of computation, as Routing Networks do, the input to each module is a linear combination of the outputs of modules from the previous layer. Specifically, the router network takes as input an observation and the corresponding task index, and outputs an $m \times m$ matrix of linear combination weights for each layer after the first, so that the element in the i -th row and j -th column of the weight matrix for layer ℓ denotes the weight of module i from layer $\ell - 1$ in the input to module j from layer ℓ . The soft relaxation from Routing Networks eliminates the need to train the router separately from the policy, and instead the entire network can be trained end-to-end. This architecture is also related to Soft Layer Ordering (Meyerson and Miikkulainen, 2017) (see section 2.3.2), though with Soft Modularization the linear combination weights aren't directly learned, instead they are dynamically computed by a separate network (the router network) at each step of computation. When combined with Soft Actor-Critic (Haarnoja et al., 2018), the Soft Modularization agent reaches 60% success rate on MT50 from the Meta-World benchmark (Yu et al., 2019).

A thorough discussion of the strengths and weaknesses of routing based approaches can be found in (Rosenbaum et al., 2019) and (Ramachandran and Le, 2019).

3 Optimization for Multi-Task Learning

With MTL architecture design as the modern generalization of hard parameter sharing on one side, MTL optimization is the broader version of soft parameter sharing on the other. Soft parameter sharing is a way to regularize model parameters by penalizing the distance from model parameters to corresponding parameters of a model for a different, but related task. While MTL optimization methods do include regularization strategies that penalize parameter distance, many other regularization strategies are being actively developed. When the challenge of negative transfer is viewed through an optimization lens, new methods for dealing with negative transfer - aside from various parameter sharing schemes - begin to appear.

We partition the existing MTL optimization methods into six distinct groups: loss weighting, regularization, gradient modulation, task scheduling, multi-objective optimization, and knowledge distillation. Just as in previous sections of this review, the boundaries between these groups are not always concrete. Certain methods may be interpreted as existing in more than one of these groups, but we believe that this partition is useful for conceptualizing the various directions of research in MTL optimization.

3.1 Loss Weighting

A very common approach to ease multi-task optimization is to balance the individual loss functions for different tasks. When a model is to be trained on more than one task, the various task-specific loss functions must be combined into a single aggregated loss function which the model is trained to minimize. A natural question to ask then, is how to exactly to combine multiple loss functions into one that is suitable for MTL. Most of the methods we describe here parameterize the aggregated loss function as a weighted sum of the task-specific loss functions, and the contribution of each method is in the computation these weights. (Gong et al., 2019) contains an empirical comparison of existing loss weighting methods.

It should be noted that there are several related works (Xu et al., 2018b; Du et al., 2018) which introduce methods for weighting the loss of auxiliary tasks relative to a main task loss. While these methods are interesting and potentially useful for MTL, they were designed for a setting that lies outside MTL, namely one in which there is a main task accompanied by one or more auxiliary tasks.

3.1.1 Weighting by Uncertainty

One of the earliest methods for learning loss weights is (Kendall et al., 2017). In this work, the authors treat the multi-task network as a probabilistic model, and derive a weighted multi-task loss function by maximizing the likelihood of the ground truth output. For the case of training on N simultaneous regression tasks, the distribution computed by the network output for task i is the Gaussian $\mathcal{N}(f_i(x), \sigma_i^2)$, where $f_i(x)$ is the network output for task i and σ_i is

a learned parameter which signifies the task-dependent (or homoscedastic) uncertainty for task i . The resulting loss function to jointly maximize the likelihood of each such distribution is

$$\sum_i \frac{1}{2\sigma_i^2} \|y_i - f_i(x)\|^2 + \log \sigma_i$$

Here y_i is the ground-truth label for task i . From this derived loss function, we can see that each task’s loss is weighted by the inverse of its task-dependent uncertainty, so that tasks with less uncertainty will be given more weight. Also, each task’s loss is regularized by $\log \sigma_i$, so that the optimization process isn’t incentivized to follow the degenerate strategy of increasing the σ_i ’s indefinitely. A very similar formula arises for training on classification tasks, and this method for weighting task losses is the main contribution of this work. Interestingly, the models trained with this method of weighting were shown to outperform identical models which were trained with the best performing constant loss weights.

3.1.2 Weighting by Learning Speed

Following (Kendall et al., 2017), several methods of weighting multi-task loss functions were introduced which weigh a task’s loss by the learning speed on that task (Chen et al., 2017; Liu et al., 2019; Zheng et al., 2018; Liu et al., 2019a), with slightly varying approaches. The majority of these methods increase a task’s loss weight when the learning speed for that task is low, in order to balance learning between tasks, though this is not the case for all methods discussed here.

(Liu et al., 2019) and (Liu et al., 2019a) each explicitly set a task’s loss weight using a ratio of the current loss to a previous loss. Let $\mathcal{L}_i(t)$ be the loss for task i at timestep t , and let N be the number of tasks. Dynamic Weight Averaging (Liu et al., 2019) sets the task weights in the following way:

$$\lambda_i(t) = \frac{N \exp(r_i(t-1)/T)}{\sum_j \exp(r_j(t-1)/T)}$$

where $r_i(t-1) = \mathcal{L}_i(t-1)/\mathcal{L}_i(t-2)$ and T is a temperature hyperparameter. In other words, the loss weight vector is a softmax over the ratios of successive loss values over the last two training steps for each task, multiplied by the number of tasks. Similarly, Loss Balanced Task Weighting (Liu et al., 2019a) sets

$$\lambda_i(t) = \left(\frac{\mathcal{L}_i(t)}{\mathcal{L}_i(0)} \right)^\alpha$$

where α is a hyperparameter. Notice that LBTW measures learning speed as the ratio of the current loss to the initial loss, while DWA measures it as the ratio of the losses from the last two training steps. LBTW also does not normalize the weight values to sum to a fixed value.

GradNorm (Chen et al., 2017) is similarly inspired to these two methods, but doesn’t compute loss weights explicitly. Instead, the weights are optimized to minimize an auxiliary loss which measures the difference between each task’s gradient and a desired task gradient based on the average task loss gradient and the learning speed of each task. To define this auxiliary loss, we first must define $G_i(t) = \|\nabla_{\theta} \lambda_i(t) \mathcal{L}_i(t)\|_2$ (weighted gradient for task i), $\bar{G}(t)$ as the average of all such $G_i(t)$, $\tilde{\mathcal{L}}_i(t) = \mathcal{L}_i(t)/\mathcal{L}_i(0)$ (learning speed for task k), and $r_i(t) = \tilde{\mathcal{L}}_i(t)/\mathbb{E}_j[\tilde{\mathcal{L}}_j(t)]$ (relative learning speed for task i). Then the auxiliary loss is defined as

$$\mathcal{L}_{\text{grad}}(\lambda(t)) = \sum_j \|G_j(t) - \bar{G}(t) \times [r_i(t)]^\alpha\|_1$$

where α is again a hyperparameter. By optimizing the task weights $\lambda_i(t)$ to minimize $\mathcal{L}_{\text{grad}}$, the weights are shifted so that tasks with a higher learning speed yield gradients with smaller magnitude, and tasks with a lower learning speed yield gradients with a larger magnitude. It should be noted that this separate optimization adds some compute cost, though the authors only apply GradNorm to the last layer of shared weights in the network in order to minimize the added cost. Even with this restriction, GradNorm outperforms baselines.

Notice that all of the methods introduced so far in 3.1.2 increase the weight of a given task’s loss when learning on that task is slower than other tasks. In comparison, (Zheng et al., 2018) assigns a loss weight to a task which decreases as learning speed increases, assigning a weight of zero if the loss increased on the previous training step. More specifically, the weight for task i on timestep t is defined in the following way: Let $\mathcal{L}_i(t)$ be the loss from task i on timestep t , let $\tilde{\mathcal{L}}_i(t) = \alpha \mathcal{L}_i(t) + (1 - \alpha) \tilde{\mathcal{L}}_i(t-1)$, and $p_i(t) = \min(\tilde{\mathcal{L}}_i(t), \tilde{\mathcal{L}}_i(t-1))/\tilde{\mathcal{L}}_i(t-1)$ where α is a hyperparameter. Then the weight for task i on timestep t is set to

$$\lambda_i(t) = -(1 - p_i(t))^\gamma \log(p_i(t))$$

similar to the Focal Loss (Lin et al., 2017). The rationale behind this strategy is that if the loss for task i has increased (i.e. $p_i(t) = 1$), there may be a local minimum in the loss landscape of that task. By assigning a weight for this task to zero, training steps will only depend on gradients from tasks whose loss is still decreasing, and gradient descent will (hopefully) escape from the task-specific local minimum in the landscape of the task whose loss has just increased.

3.1.3 Weighting by Performance

Weighting task’s losses by performance is similar to weighting by learning speed. These two categories are distinguished by the fact that learning speed can be thought of as the rate of change of performance. Given that there are numerous works which introduced methods for weighting by learning speed, there are surprisingly few methods for weighting by performance. To our knowledge, the only such works are Dynamic Task Prioritization (Guo et al., 2018) and the implicit schedule in (Jean et al., 2019).

Dynamic Task Prioritization (Guo et al., 2018) was inspired by the non-neural MTL work Self-Paced Multi-Task Learning (Li et al., 2016). Dynamic Task Prioritization (or DTP) prioritizes difficult tasks and examples by assigning weights both at the task level and the example level. DTP employs the Focal Loss (Lin et al., 2017) to weigh examples within a task and performance metrics such as classification accuracy to weigh tasks themselves, where both the example and task level of weights emphasize difficult data over easy data. These are the distinguishing factors of this work: usage of performance metrics other than the loss function to weigh tasks, and loss weighting at both the example and the task level.

The method for loss weighting introduced in (Jean et al., 2019) is deemed an implicit task schedule, in reference to the connection between loss weighting and task scheduling (see section 3.3). In this work, the i -th task is assigned the weight

$$\lambda_i = 1 + (\text{sign}(\bar{S} - S_i)) \min(\gamma, (\max_j S_j)^\alpha |\bar{S} - S_i|^\beta)$$

where S_i is the ratio of the current validation performance to a target validation performance, \bar{S} is the average over all S_i ’s, γ is a hyperparameter which limits the difference between task weights, α is a hyperparameter that adjusts how quickly the weights deviate from uniformity, and β is a hyperparameter that adjusts the emphasis on deviations of a task’s score from the mean score. While the formula to compute the loss weights in this implicit schedule looks quite different from the focal loss, they have the same intention: focus on tasks with poor performance. Interestingly, this work also includes a discussion of the difference between scaling learning rates and scaling gradients (there is no difference for vanilla SGD), which is an often overlooked but important detail of choosing loss coefficients.

3.1.4 Weighting by Reward Magnitude

It is a well known issue in multi-task learning that a difference in the scale of loss functions between tasks can cause imbalanced learning dynamics when training jointly on such tasks. For example, consider an MTL setting with two tasks, T_1 and T_2 , both classification tasks. Suppose that the loss \mathcal{L}_1 for task T_1 is a standard cross-entropy loss, and the loss \mathcal{L}_2 for T_2 is equal to the standard cross-entropy loss multiplied by a constant factor of 1000. It is clear in this case that the gradient for the joint task loss $\mathcal{L} = \mathcal{L}_1 + \mathcal{L}_2$ will be mostly dependent on the network’s performance on T_2 and very little on that of T_1 , so that the multi-task learning will actually be focused mostly on T_2 . While this is a somewhat contrived example, the same principle applies to MTL settings in the wild, where the scale of loss functions may differ greatly. One approach to tackle this issue is to compute task loss weights based on the magnitude of each task’s loss function.

(Hessel et al., 2018) uses PopArt normalization (van Hasselt et al., 2016) to perform loss weighting for multi-task deep reinforcement learning. The authors derive a scale-invariant update rule for actor-critic methods, then extend it to a multi-task setting. The main idea is to keep a running estimate of the mean and standard deviation of the return from each timestep, then replace the returns with the normalized versions. The REINFORCE (Williams, 1992) algorithm uses an update rule in which the gradient of the objective with respect to the policy parameter is

$$(R(t) - v(s_t)) \nabla_\theta \log \pi(a_t | s_t)$$

where $R(t)$ is the return from step t , v is the value function, θ are the parameters of the policy π , and s_t and a_t are the state and action at step t . This work replaces this update rule with

$$\left(\frac{R_i(t) - \mu_i}{\sigma_i} - \tilde{v}_i(s_t) \right) \nabla_\theta \log \pi(a_t | s_t)$$

where $R_i(t)$ is the return on step t for task i , μ_i and σ_i are running estimates of the mean and standard deviation of $R_i(t)$, and \tilde{v}_i is a normalized value function for task i . A similar replacement is made for the update rule of the value function, and the details can be found in (Hessel et al., 2018). This normalization constrains the reward function from

each task to have a similar contribution to the update, so that the relative importance of each task is agnostic to the scale of the reward functions. Applying PopArt to multi-task deep reinforcement learning significantly improves performance of agents trained with IMPALA (Espeholt et al., 2018) on the DeepMind Lab (Beattie et al., 2016) collection of tasks.

3.1.5 Geometric Mean of Losses

While most MTL methods model the network loss as a weighted average of individual task losses, (Chennupati et al., 2019) proposes to compute the geometric mean of task losses as an alternative. The authors claim that using a geometric mean facilitates balanced training of all tasks, and that this loss function handles differences in learning speeds of various tasks better than the traditional weighted average loss function. However, there is no rigorous evidence to support these claims. The results presented in their work show that models trained with the geometric outperform baselines, but there has been little work done on analyzing the specific properties of optimization using these loss functions in the MTL setting, which may be an interesting direction for future research.

3.2 Regularization

Regularization has long played an important role in multi-task learning, mostly in the form of soft parameter sharing. Soft parameter sharing is one of two popular techniques for MTL (the other being hard parameter sharing) in which parameters aren't shared between task models, but instead the L_2 distance between the parameters of task models is added to the training objective, in order to encourage similar model parameters between different tasks. Soft parameter sharing is simple to implement and has been employed extensively in MTL methods.

(Duong et al., 2015) is a well-known method which uses soft parameter sharing instead of hard parameter sharing. The authors employ the architecture of (Chen and Manning, 2014) for dependency parsing in multiple languages, but train separate copies of the same network, one for each language. Only a small fraction of the parameters in the network are softly shared between tasks, namely the layers which transform the embedded POS tags and the embedded arc labels. The use of soft parameter sharing across models for different languages was shown to greatly increase performance in the small data setting.

An interesting variant of soft parameter sharing is introduced in (Yang and Hospedales, 2016b), in which the L_2 distance between parameter vectors is replaced by the tensor trace norm of the tensor formed by stacking corresponding parameter vectors from different tasks. The trace norm of a matrix is the sum of the singular values of that matrix, and it can be thought of as a convex relaxation of rank, i.e. the number of non-zero singular values. Therefore, minimizing the trace norm of a matrix is a good surrogate for minimizing the rank of that matrix. By extending the trace norm from matrices to tensors and minimizing the tensor trace norm of stacked parameter vectors, this method encourages the learning of parameter vectors across tasks which are similar, just as in traditional soft parameter sharing. In this case, however, similarity is measured by the existence of linear dependencies between parameter vectors (i.e. low tensor rank), instead of L_2 distance. The authors interpret the resulting trace norms after training as a measure of *sharing strength* between corresponding layers in different task models (low trace norm means stronger sharing), and interestingly, the sharing strength was found to decrease with layer depth. This coincides with the common intuition in MTL that representations in earlier layers should be less task-dependent than those of deeper layers.

Besides soft parameter sharing, MTL models can also be regularized by placing prior distributions on the network parameters. Multilinear Relationship Networks (MRNs) (Long et al., 2017) do exactly this by imposing a tensor normal distribution as a prior over the parameters in task-specific layers of multi-task models. A tensor normal distribution is essentially a multivariate normal distribution with the extra assumption that the covariance matrix can be decomposed into the Kronecker product of K covariance matrices, where K is the order of a tensor following this distribution. Each of these covariance matrices represents the covariance between rows of various matricizations of a tensor following the distribution. To impose this distribution on the parameter tensor of a multi-task network, the covariance is constructed as the Kronecker product of three covariance matrices: a covariance matrix representing the relationships between features, another indicating the relationships between classification classes, and the last modeling the relationships between tasks. It is this construction that allows the model to learn relationships between tasks, as its name suggests. At the time of its publication, MRNs reached state of the art performance on three different MTL benchmarks.

Deep Asymmetric Multitask Feature Learning (Deep-AMTFL) (Lee et al., 2018) is a method of regularizing deep multi-task neural networks by introducing an autoencoder term to the objective function. This auxiliary task involves reconstructing the features from the second to last layer of a network from the network output, so that each of the task predictions is used to construct the features for all other tasks, a task which was proposed by Asymmetric Multi-Task Learning (Lee et al., 2016). The motivation behind these methods is to allow for information to flow from tasks which the model does well to tasks which the model does poorly, but not the other way around, hence the "asymmetric" in the names.

AdaShare (Sun et al., 2019b) (architecture discussed in section 2.5.3) introduces a novel regularization scheme for MTL methods by regularizing sharing parameters instead of module parameters. AdaShare uses a set of neural network blocks which are shared between many tasks, though not all blocks are used by every task. The sharing parameters of this architecture encode the usage of blocks by different tasks, as shown in figure 16. AdaShare regularizes these sharing parameters α_i instead of the network weights. Specifically, the training objective includes two auxiliary terms

$$\mathcal{L}_{sparsity} = \sum_{\ell \leq L, i \leq N} \log \alpha_{i,\ell} \quad \mathcal{L}_{sharing} = \sum_{i,j \leq N} \sum_{\ell \leq L} \frac{L-\ell}{L} \|\alpha_{i,\ell} - \alpha_{j,\ell}\|_1$$

where N is the number of tasks and L is the number of blocks. $\mathcal{L}_{sparsity}$ encourages each task’s network to be sparse, while $\mathcal{L}_{sharing}$ encourages similarity in the sharing parameters of different tasks. Notice that the coefficient $\frac{L-\ell}{L}$ in the definition of $\mathcal{L}_{sharing}$ linearly decreases the importance of sharing in deeper layers, which follows the observation in (Yang and Hospedales, 2016b) that more sharing should occur in earlier layers, though in this case it is explicitly encouraged. Both of these regularization terms are very general, and could potentially be applied to Soft Layer Ordering (Meyerson and Miikkulainen, 2017), Modular Meta Learning (Alet et al., 2018), Stochastic Filter Groups (Bragman et al., 2019), and many other architectures which learn what to share between tasks.

A related type of regularization is introduced for conditional computation models, specifically Routing Networks (discussed in section 2.6), in (Cases et al., 2019). In this case, the regularizer is shaping the decisions of module selection between tasks by encouraging diversity of choices made by the router, but it takes a slightly different form compared to the AdaShare regularization, due to the differences between Routing Networks and the AdaShare architecture. Specifically, Routing Networks iteratively construct a network layer by layer, choosing between the set of all layers at each step, so that any permutation (with repetitions) of layers can be combined into a network by the router. In particular, this means that the router can ignore many or most layers and only utilize a few layers per task, which is a well known occurrence in training Routing Networks called *module collapse* (Rosenbaum et al., 2019). Module collapse causes a waste of network components as well as a decrease in modularity. The issue of module collapse is addressed by the regularization technique used in (Cases et al., 2019), which rewards diversity of choices made by the router, so that no layer is ignored.

Finally, Maximum Roaming (Pascal et al., 2020) is a multi-task regularization method that can be thought of as a variant of Dropout (Srivastava et al., 2014) specifically made for MTL networks. While most MTL methods partition parameters between tasks in either a fixed or principally learned way, Maximum Roaming randomly varies the parameter partitioning during training, under the constraint that each parameter must be assigned to a maximal number of tasks. Despite the unorthodoxy of this idea, it is empirically demonstrated to be beneficial for performance on the CelebA (Liu et al., 2015b), CityScapes (Cordts et al., 2016), and NYU-v2 (Silberman et al., 2012) datasets. The intuitive explanation of the benefit of roaming is that it allows for each unit to learn from all tasks throughout training without the constraint that each parameter is always shared between all tasks, which is a likely contributor to negative transfer. Intuition aside, this phenomenon is not yet rigorously understood and further work is certainly needed to fully utilize the potential gains.

3.3 Task Scheduling

Task scheduling is the process of choosing which task or tasks to train on at each training step. Most MTL models make this decision in a very simple way, either training on all tasks at each step or randomly sampling a subset of tasks to train on, though there is some variation in these simple task schedulers. For example, when training on a single task at each update step in supervised learning settings, it is common to employ either uniform task sampling (Dong et al., 2015), where each task has the same probability of being chosen, or proportional task sampling (Sanh et al., 2019), in which the probability of choosing a task is proportional to the size of its dataset. Despite the fact that most methods use these baseline task schedulers, it is a well known fact that optimized task scheduling can significantly improve model performance (Bengio et al., 2009).

It is important to note that the problem of scheduling tasks is strongly tied to the problem of weighting task losses. To see this, consider an MTL setting with two tasks, T_1 and T_2 , with corresponding loss functions \mathcal{L}_1 and \mathcal{L}_2 , and consider two separate training setups for this setting. In the first setup, the model is trained by minimizing the joint loss $\mathcal{L}_1 + 2\mathcal{L}_2$, and each training batch holds an equal amount of data from both tasks. In the second setup, each training batch either holds data exclusively from T_1 or T_2 , where the chances of the batch containing T_1 data and T_2 data are $1/3$ and $2/3$, respectively. If a batch is from T_1 , the training step will minimize \mathcal{L}_1 , and if a batch is from T_2 , the step will minimize \mathcal{L}_2 . It isn’t hard to intuit that these setups will, on average, lead to similar results. The training processes won’t be numerically equivalent, but each setup jointly optimizes for the tasks in a way that prioritizes T_2 twice as much as T_1 . Loss weighting can be seen as a continuous relaxation of task scheduling, so that many task schedulers can easily be adapted to loss weighting methods, and vice versa. However, most works adhere to the conventions of their

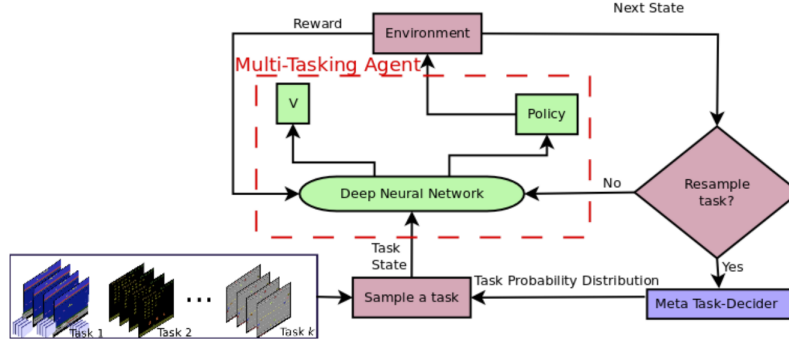

Figure 20: Task scheduling visualization from (Sharma et al., 2017). A meta task-decider is trained to sample tasks with a training signal that encourages tasks with worse relative performance to be chosen more frequently.

subfield and only use one of these two framings: multi-task computer vision methods frequently use loss weighting (Dai et al., 2016; Misra et al., 2016; Ruder et al., 2019), while multi-task NLP methods often employ task scheduling (Liu et al., 2015a; Luong et al., 2015; Liu et al., 2019b).

(Sharma et al., 2017) proposes a method for task scheduling in multi-task RL which is based on active learning, with three different variants. The common idea behind these three variants is to assign task scheduling probabilities based on relative performance to a target level: the further the model is from the target performance on a given task, the more likely it is that the task will be scheduled. This is akin to the loss weighting methods that increase the loss weight of a task that exhibits slow learning. Figure 20 shows a visualization of the task scheduling process. The difference between the three variants is in the implementation of the “meta task-decider”, the component which computes task sampling probabilities. In one way or another, each variant uses the values $m_i = 1 - a_i/b_i$ to compute these probabilities, where i is a task index, b_i is the target performance for task i , and a_i is the current model performance for task i . Notice that m_i is a measure of the difference between the current model performance and the baseline performance for task i . The first variant, A5C, doesn’t learn a sampling distribution, but instead computes a softmax over all m_i ’s to construct the sampling distribution over tasks. The second variant, UA4C, treats the task sampling problem as a non-stationary multi-armed bandit problem in which the reward for the meta task-decider when picking task i is m_i . This way, the agent is rewarded for choosing tasks which are furthest from their respective target performances. Lastly, the third variant, EA4C, treats the sequence of task sampling decisions as a reinforcement learning problem, so that the meta task-decider can learn to choose sequences of tasks which help the agent to learn over time. In this case, the reward for the meta task-decider when choosing task i is

$$\lambda m_i + (1 - \lambda) \left(\frac{1}{3} \sum_{j \in \mathbb{L}} (1 - m_j) \right)$$

where \mathbb{L} is the task indices of the three tasks with the worst current performance and λ is a hyperparameter. This reward function then incentivizes the meta task-decider to choose tasks which are furthest from their target performance while simultaneously choosing tasks which ensure that the performance on the worst tasks are still improving. Agents trained with these three variants vastly outperform an identical agent with uniform sampling probability on various collections of Atari games ranging in size from 6 games to 21 games.

The A5C variant of the algorithm of (Sharma et al., 2017) is very similar to a more recently proposed method for task scheduling (Jean et al., 2019). In this work, each task is assigned an unnormalized score

$$\lambda_i = \frac{1}{\min(1, \frac{a_i}{b_i})^\alpha + \epsilon}$$

where a_i and b_i are defined similarly as above, and α and ϵ are hyperparameters. The unnormalized scores are simply divided by their sums to obtain the task sampling probabilities. The novel portion of this method is the inclusion of ϵ for numerical stability and α to control the degree of over and under sampling of tasks. (Jean et al., 2019) also provides a discussion of task scheduling vs. loss weighting, in which loss weighting is referred to as “implicit task scheduling”, as well as a loss weighting method which is discussed in section 3.1.3.

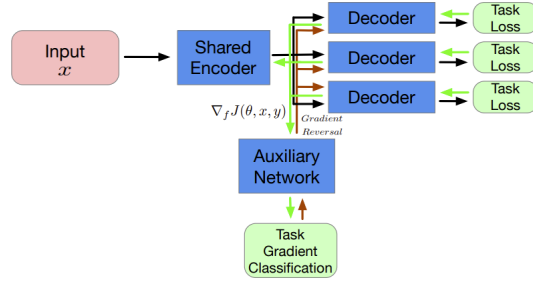

Figure 21: Multi-task GREAT model (Sinha et al., 2018). An auxiliary network takes a gradient vector for a single task’s loss and tries to classify which task the gradient vector came from. The network gradients are then modulated to minimize the performance of the auxiliary network, to enforce the condition that gradients from different task functions have statistically indistinguishable distributions.

3.4 Gradient Modulation

One of the main challenges in MTL is *negative transfer*, when the joint training of tasks hurts learning instead of helping it. From an optimization perspective, negative transfer manifests as the presence of conflicting task gradients. When two tasks have gradients which point in opposing directions, following the gradient for one task will decrease the performance on the other task, and following the average of the two gradients means that neither task sees the same improvement it would in a single-task training setting. Among many other approaches to alleviate the conflict in learning dynamics between different tasks, explicit gradient modulation has arisen as a potential solution. The methods presented here work by modifying training gradients, either through the use of adversarial methods or by simply replacing gradient vectors when conflicts arise.

3.4.1 Adversarial Gradient Modulation

If a multi-task model is training on a collection of related tasks, then ideally the gradients from these tasks should point in similar directions. Gradient Adversarial Training (GREAT) (Sinha et al., 2018) explicitly enforces this condition by including an adversarial loss term that encourages gradients from different sources to have statistically indistinguishable distributions. GREAT is a general framework which can be applied for adversarial defense and knowledge distillation (and likely other settings) besides multi-task learning. In the MTL setup, the model is augmented with an auxiliary discriminator network which attempts to classify the tasks corresponding to gradients of the task decoders, as pictured in figure 21. During the backward pass, the gradients are modified by Gradient Alignment Layers (GALs) through element-wise scaling to minimize the performance of the auxiliary network in distinguishing between the task gradients. A similar adversarial setup to enforce gradient similarity between tasks is used in (Maninis et al., 2019).

While the motivation for the model is intuitively plausible, the premise of adversarial training isn’t rigorously justified. Just because two tasks are related, how can we be sure that their gradient distributions should be identical? Furthermore, it seems likely that the distribution of a task’s gradients will change throughout training, so how likely can it be that each task’s gradient distributions move together? The existence of negative transfer in the first place tells us that similar tasks do not necessarily have aligning gradients. Can we actually alleviate negative transfer by enforcing gradients to be similar, even when the original gradients of the loss function are conflicting? Without theoretical justification, we can’t be sure of the answers to these questions. Nevertheless, the experiments presented in this work show that GREAT does increase the performance of multi-task models, and that it outperforms other multi-task optimization baselines such as GradNorm. The nature of both the premise and the results of this model are still unanswered questions.

3.4.2 Gradient Replacement

An entirely different approach to gradient modulation is explored in (Lopez-Paz and Ranzato, 2017; Chaudhry et al., 2018; Yu et al., 2020). The main idea behind these three works is to replace a task gradient vector which conflicts with another by a modified version which has no conflicts. This idea is broad, but the implementations of each of these works are similar at heart and we will present a rigorous definition of each.

(Lopez-Paz and Ranzato, 2017) introduces Gradient Episodic Memory (GEM) for continual learning, a problem formulation in which a model learns multiple tasks sequentially, instead of simultaneously as in MTL. GEM keeps an episodic memory of training examples from past learned tasks, and enforces the following constraint at each update

step t when training on task i :

$$\forall j < i : G_i(t)^T G_j(t) \geq 0$$

where $G_i(t)$ is the gradient vector for task i (the current task) and $G_j(t)$ is the gradient of the loss on the data in episodic memory from task j , at training step t . The condition that the dot product between two gradient vectors is non-negative is equivalent to the condition that the angle between the two gradient vectors is less than 90 degrees, so that they don't point in opposing directions. If this condition isn't met for some j , then $G_i(t)$ is replaced by $\tilde{G}_i(t)$, the solution to the following optimization problem:

$$\begin{aligned} \text{minimize: } & \frac{1}{2} \|G_i(t) - \tilde{G}_i(t)\|^2 \\ \text{subject to: } & \forall j < i : \tilde{G}_i(t)^T G_j(t) \geq 0 \end{aligned}$$

This quadratic optimization problem can be solved efficiently by instead solving the dual and recovering the corresponding value of $\tilde{G}_i(t)$. Even so, GEM introduces significant increase in computation time compared to traditional training. Averaged GEM (A-GEM) (Chaudhry et al., 2018) was proposed to alleviate the computation burden. The authors point out that it is much more efficient to relax the GEM constraint to

$$G_i(t)^T G_{\text{avg}}(t) \geq 0$$

where $G_{\text{avg}}(t) = \frac{1}{i-1} \sum_{j < i} G_j(t)$. In other words, instead of requiring the new gradient to be non-conflicting with the task gradient of each previous task, A-GEM only requires that the new gradient be non-conflicting with the average of the previous tasks' gradients. By doing this, the modified optimization problem has the following closed form solution:

$$\tilde{G}_i(t) = G_i(t) - \frac{G_i(t)^T G_{\text{avg}}(t)}{G_{\text{avg}}(t)^T G_{\text{avg}}(t)} G_{\text{avg}}(t)$$

This slight relaxation of the constraints yields a huge improvement in computation time while maintaining the performance of GEM.

This exact update rule is adapted for the MTL setting in (Yu et al., 2020) with a method named PCGrad. Besides the theoretical analysis in the paper, the PCGrad algorithm itself is near identical to A-GEM. The main difference is due to the difference in problem formulations: PCGrad is meant to be used when learning multiple tasks simultaneously, so multiple gradient vectors must be checked for conflicts with others at each update step. When combined with Soft Actor-Critic (Haarnoja et al., 2018), PCGrad is able to successfully complete 70% of the tasks in the MT50 benchmark of the Meta-World environment (Yu et al., 2019), a challenging, recently proposed environment for multi-task and meta-learning with robotic manipulation tasks.

The success of gradient modulation methods demonstrate that minimizing the presence of conflicting gradients between tasks is an effective way to decrease negative transfer. Continuing to develop such methods may be an important part of MTL optimization in future research.

3.5 Knowledge Distillation

Originally introduced for compressing large ensembles of non-neural machine learning models into a single model (Bucila et al., 2006), *knowledge distillation* has found many applications outside of its originally intended domain. In MTL, the most common use of knowledge distillation is to instill a single multi-task "student" network with the knowledge of many individual single-task "teacher" networks. Interestingly, the performance of the student network has been shown to surpass that of the teacher networks in some domains, making knowledge distillation a desirable method not just for saving memory, but also for increasing performance.

The first applications of policy distillation for multi-task learning came from two separate papers at the same time (uploaded to arXiv on the exact same day!), namely Policy Distillation (Rusu et al., 2015) and Actor-Mimic (Parisotto et al., 2015). Both of these methods are designed for reinforcement learning, and follow roughly the same template: For each task in a collection of tasks, use reinforcement learning to train a task specific policy to convergence, and after training, use supervised learning to train a single student policy to mimic the outputs of the task-specific teacher policies, such as with a mean-square error or cross-entropy loss. Additionally, Actor-Mimic includes a feature regression objective, where each teacher network has a corresponding feature prediction network which attempts to predict the hidden activations of the teacher network from the hidden activations of the student network. The gradients of this objective are propagated through the student network, so that the student network is trained to compute features which contain the same information as each teacher network. Actor-Mimic was also shown to demonstrate impressive transfer performance. Transfer to new tasks was performed by removing the last layer of the distilled student policy and using the weights as the initialization for a single-task policy. The transferred policies were able to learn some new tasks

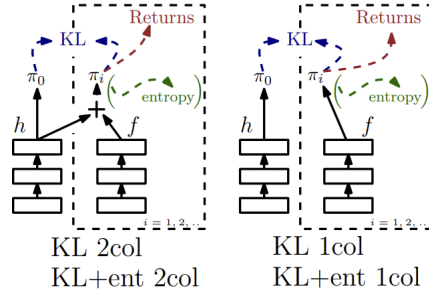

Figure 22: Two architectures from the Distal framework for RL (Teh et al., 2017). On the left is an architecture which employs both of the main ideas behind Distal: KL-regularization of single-task policies with the multi-task policy and a two-column policy for each task, where one column is shared between all tasks. On the right is an architecture which only employs KL-regularization of the single-task policies.

faster than policies trained from scratch, though occasionally this transfer would slow down learning on new tasks. Also, both of these papers show similar results for the student network in the Atari domain: the distilled student network either matches or outperforms the single-task teachers. This is somewhat surprising, given that the student network is not trained to maximize in-game reward, it is only trained to mimic the behavior of the teacher networks.

A common intuitive explanation for the phenomenon of student networks outperforming their teachers is that the student networks are provided with a more rich training signal than the teacher. For example, in classification, each single-task network is provided with a ground truth label for each input in the form of a one-hot vector. Meanwhile, the student’s training signal will be a “softer” version of this, namely the teachers’ output, a dense vector which may contain information about similarity of classes to the ground-truth class and other information not found in the ground truth one-hot vector.

It is interesting to note that most knowledge distillation algorithms (these two included) have an asymmetric information flow between student and teacher, namely that information travels from teacher to student, but not the other way around. This observation raises the question: should the single-task teacher networks receive information from the distilled multi-task student network? This isn’t possible with the methods discussed so far, since the teacher networks are done training before the student network starts it. On the other hand, the Distal framework for multi-task reinforcement learning (Teh et al., 2017) provides a setting which accomplishes exactly this symmetric information flow between student and teacher. Distal is a very general framework which leads to several different loss functions and architectures, though each variant is driven by one or both of two main ideas: The single-task policies are regularized by minimizing the KL-divergence between single-task policies and the shared multi-task policy as a part of the training objective, and the policies for each task are formed by adding the output of the corresponding single-task policy with the output of the shared multi-task policy. Two of the resulting architecture variants are pictured in figure 22. The details of each variation and the motivation behind the design choices can be found in the original work. It should be noted, though, that the lines between different approaches to multi-task RL being to blur when considering Distal. This framework does not use knowledge distillation in the same sense as Policy Distillation and Actor-Mimic, since the shared multi-task network isn’t explicitly trained to mimic the outputs of the single-task network.

Most recently, knowledge distillation was applied to multi-task NLP with MT-DNN ensembles (Liu et al., 2019c) and Born-Again Multi-tasking networks (BAM) (Clark et al., 2019). Both works mainly use the original template for multi-task knowledge distillation, but the authors of BAM also introduce a training trick to help student networks surpass their teachers which they name teacher annealing. For model input x , ground truth label y , and teacher output $f_T(x)$, the usual target output for the student on a given example x is $f_T(x)$. With teacher annealing, the student’s target output is replaced by $\lambda y + (1 - \lambda)f_T(x)$, where λ is linearly annealed from 0 to 1 throughout student training. This way, by the end of the student training process, the student is trying to output the ground truth labels for each input and is no longer trying to mimic the teacher, so that the student isn’t inherently limited by the teacher’s weaknesses. Ablation studies in this work show that teacher annealing does improve student performance on the GLUE benchmark.

3.6 Multi-Objective Optimization

The need to optimize for multiple - possibly conflicting - loss functions is a fundamental difficulty of MTL. The standard formulation of machine learning involves the optimization of a single loss function, so that the methods created to solve such problems only consider a single loss function. As we’ve seen so far, most MTL methods circumvent this challenge

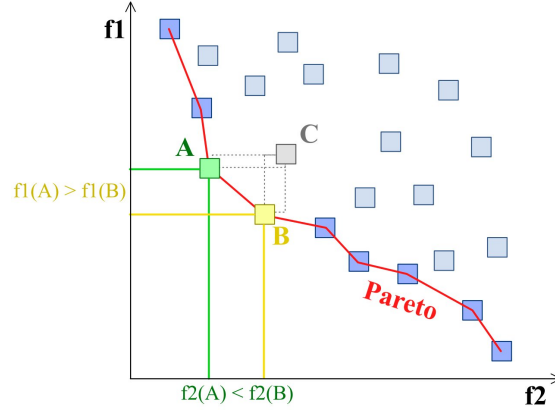

Figure 23: Visualization of Pareto optimal solutions for a two-objective optimization problem (Dréo, 2006). The Pareto frontier is made of all points along the red curve.

by combining many loss functions into one using a weighted average, though this fix isn't perfect. The map from a tuple of loss values $(\mathcal{L}_1(t), \mathcal{L}_2(t), \dots, \mathcal{L}_N(t))$ to their weighted average $\sum_i \lambda_i \mathcal{L}_i(t)$ isn't an injective mapping, meaning that some information is lost when we transform a collection of loss functions into a single weighted loss function¹. Constructing this weighted average also necessitates a choice of weights, which is prone to error. Using multi-objective optimization for MTL is an alternative optimization method which doesn't suffer from these weaknesses.

Multi-objective optimization is exactly the process of optimizing several objective functions simultaneously. Notice that in a multi-objective problem, there is not necessarily a solution which is a global minimum for all objective functions, meaning that typically there are no globally optimal solutions for multi-objective optimization problems. Instead, we consider solutions which are Pareto optimal. Pareto optimal solutions to a multi-objective problem are those for which the performance for any of the objectives can only be improved by worsening performance on another objective. In other words, Pareto optimal solutions represent the best feasible options for solving a multi-objective optimization problem, up to a trade-off between objectives. The set of Pareto optimal solutions to a multi-objective optimization problem is called the Pareto frontier, and is visualized in figure 23.

Despite being a natural fit for MTL and a well-studied problem (Miettinen, 1998), it has only recently been applied to multi-task problems. (Sener and Koltun, 2018) brought gradient-based multi-objective optimization algorithms to the field of deep multi-task learning by extending the well known Multiple Gradient Descent Algorithm (MGDA) (Désidéri, 2012) to a form that scales well to the high dimensionality of deep learning problems. This is accomplished by minimizing an upper bound to the MGDA loss, and doing so incurs only a small amount of computational overhead compared to traditional MTL. Pareto Multi-Task Learning (Lin et al., 2019) takes this extension one step further by generalizing the algorithm proposed in (Sener and Koltun, 2018) in order to compute multiple Pareto optimal solutions. Since no Pareto optimal solution is a priori superior to any other, a set of Pareto optimal solutions which is representative of the Pareto frontier is more flexible and likely more useful than a single solution. Pareto MTL works by decomposing the multi-objective optimization problem into multiple subproblems, each with varying preferences between objectives. Interestingly, the authors show that Pareto MTL and the algorithm presented in (Sener and Koltun, 2018) can actually be formulated as methods to compute adaptive loss weights, similar to those discussed in section 3.1. This is somewhat counterintuitive, since multi-objective optimization methods are intended to be of a fundamentally different nature than methods which optimize a weighted average over loss functions. With further exploration, the surprising connection between these two directions could potentially lead to a better understanding of existing multi-task optimization methods.

4 Task Relationship Learning

We have now discussed MTL architectures and optimization methods, completing a broader analogue of the popular dichotomy specified by hard and soft parameter sharing. However, there is a lesser known third wheel to this pair of approaches: task relationship learning. Task relationship learning (or TRL) is a separate approach that doesn't quite fit

¹It is a well known fact in mathematical analysis that there is no continuous injective mapping from \mathbb{R}^d to \mathbb{R} for $d \geq 2$, so unfortunately there is no immediate candidate for a multi-task loss function which is superior to the weighted average in the sense of injectivity.

into either architecture design or optimization, and is more specific to MTL. The goal of TRL is to learn an explicit representation of tasks or relationships between tasks, such as clustering tasks into groups by similarity, and leveraging the learned task relationships to improve learning on the tasks at hand.

In this section we discuss three research directions within TRL. The first is grouping tasks, where the goal is to partition a collection of tasks into groups such that simultaneous training of tasks in a group is beneficial. The second is learning transfer relationships, which includes methods that attempt to analyze and understand when transferring knowledge from one task to another is beneficial for learning. Finally, we discuss task embedding methods, which learn an embedding space for tasks themselves.

4.1 Grouping Tasks

As a solution to negative transfer, many MTL methods are designed to adaptively share information between related tasks and separate information from tasks which might hurt each other’s learning. The papers discussed here use task grouping as an alternative solution: if two tasks exhibit negative transfer, simply separate their learning from the start. However, doing so requires significant computation time for trial and error in training networks jointly for various sets of tasks, and there are currently very few methods which can accurately determine the joint learning dynamics of groups of tasks without this kind of brute force trial and error.

Two early concurrent works of learning to group tasks are (Alonso and Plank, 2016) and (Bingel and Søggaard, 2017). Both of these papers are empirical studies analyzing the effectiveness of various task groupings in MTL for natural language processing, with a focus on choosing one or two auxiliary tasks (such as POS tagging, syntactic chunking, and word counting) to help learning on a main task (such as named entity recognition and semantic frame detection) by training a multi-task network on many combinations of tasks. In these studies, a single-task network is trained for each individual main task, and its performance is compared to the performance of a multi-task network trained on the main task jointly with one or two auxiliary tasks.

(Alonso and Plank, 2016) trains 1440 task combinations, each with a main task and one or two auxiliary tasks, and finds that performance on the main task improves the most with auxiliary tasks whose label distributions have high entropy and low kurtosis. This is consistent with the findings of (Bingel and Søggaard, 2017), in which 90 pairs of tasks (one main, one auxiliary) are trained. Using the results of these training runs as data, this work trains a logistic regression model to predict whether an auxiliary task will help or hurt main task performance based on features from the datasets and learning curves of the two tasks. They also find that entropy of the auxiliary label distribution is highly correlated with improvement on the main task, though the features most highly correlated with main task improvement are the gradients of the main task learning curve when trained on its own. Specifically, if the learning curve of a task (when trained in a single-task setup) begins to plateau during the first 20% to 30% of training, including an auxiliary task in training is likely to improve the performance on the main task. The authors speculate that this may be because a main task whose learning curve has an early plateau is likely to be stuck in a non-optimal local minimum, and the inclusion of an auxiliary task helps the optimization process to escape this minimum. Somewhat surprising is their finding that the difference in sizes of the main and auxiliary task dataset was not found to be indicative of the main task performance gain when including the auxiliary task. Despite the fact that these studies don’t treat all tasks identically, as is usually the case with MTL, the conditions they find which imply positive transfer between tasks are general enough that they may be useful in the multi-task setting.

An empirical study on the joint training of computer vision tasks is performed in (Doersch and Zisserman, 2017), with a focus on self-supervised tasks, namely relative position regression, colorization, motion segmentation, and exemplar matching. This study is less in-depth, as it is not the sole focus of the paper, but the authors come to the interesting conclusion that multi-task training always improved performance compared to the single-task baselines. This fact is very surprising given the inconsistency of improvement that MTL usually affords over single-task training. The consistent improvement may be due to the relationships between the tasks or the nature of their self-supervised labels, but none of these answers are certain.

Adjacent to these empirical studies to analyze multi-task task relationships is a principled method for learning these relationships online during training without trial-and-error task grouping, called Selective Sharing (Strezoski et al., 2019b). Selective sharing uses a shared trunk architecture to handle multiple tasks, and clusters tasks into groups based on the similarity of their gradient vectors throughout training. This clustering is motivated by the fact that the task-specific branches are all initialized with identical parameters, so that the similarity between task gradients is indicative of the similarity of tasks. As the clusters of tasks are updated throughout training, the task branches of the network are merged so that tasks which are clustered together share parameters, and this process continues until the clusters stop changing. Aside from the obvious benefit of decreased computation cost compared to large scale empirical studies to determine groups of tasks, this method uses learned task features to understand the relationships

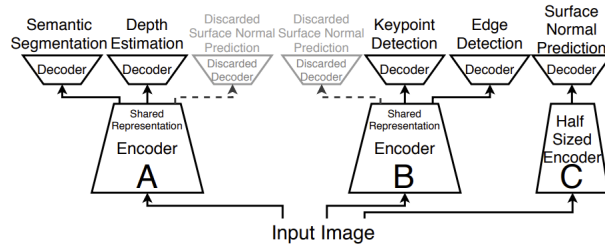

Figure 24: An example partitioning of a group of tasks into clusters with positive transfer (Standley et al., 2019).

between tasks, which is a powerful and inexpensive approach to TRL that is also employed in (Kriegeskorte, 2008; Song et al., 2019) (see section 4.2 for further discussion). It should be noted, however, that their model is based on an assumption which breaks down more and more during training. It may be true that gradient vectors are indicative of task similarity at the beginning of training, when parameters across tasks are still relatively similar. But as training continues and model parameters get further apart, similarity between task gradients becomes less and less representative of the similarity between tasks, and this signal will devolve into noise with a sufficiently non-convex loss landscape. Still, the approach is empirically shown to be effective for computing task relationships with proper configuration.

Most recently, (Standley et al., 2019) includes an in-depth empirical study of task grouping with the Taskonomy dataset (Zamir et al., 2018) and a method to partition a group of tasks into clusters which each exhibit positive transfer between their respective tasks. Such a partitioning of tasks is pictured in figure 24. Using four different training settings with varying amounts of training data and network sizes to train each pair of tasks within groups of five tasks, the authors find several interesting trends with a more thorough analysis than the previous studies. First, there were mixed results on whether or not multi-task training improved over the single-task baselines, with many multi-task networks performing worse than the single-task counterparts. Next, the performance gain from single-task to multi-task training varies wildly with the training setting, implying that the effectiveness of MTL is not as dependent on the relationship of the tasks themselves as we might have once thought. Surprisingly, the study also finds no correlation between the multi-task affinity and the transfer affinity between tasks, which again shows that there are many more factors behind joint task learning dynamics (in both multi-task and transfer learning) than just the nature of the tasks in consideration. To find a partition of a group of tasks into clusters with desirable learning dynamics, this work uses both approximations of the performance of multi-task networks at convergence and a branch-and-bound algorithm that uses these approximations to select a set of multi-task networks to collectively perform all tasks. Using this method of grouping tasks, the resulting multi-task networks consistently outperform the single task baselines, which is a vast improvement over the multi-task setups from the empirical study in which every single pair of tasks is trained jointly. To our knowledge, this is the only computational framework for deciding which tasks to train together in multi-task learning that allows for more than two tasks to be trained jointly.

4.2 Transfer Relationships

Learning transfer relationships between tasks in MTL is related to the problem of learning to group tasks for joint learning, though they don't always correlate, as noted above. However, unlike learning tasks simultaneously, transfer learning already plays an important role in the wider deep learning research effort; most natural language processing and computer vision models start not from scratch, but transferring a pre-trained model to use on a new task. Be that as it may, research into methods that can explicitly learn transfer relationships between tasks is only somewhat recent. With the large existing applicability of transfer learning today, these methods have the potential to make a strong impact on the larger research community.

The first (and certainly most well known) work which attempted to learn transfer affinities between tasks is Taskonomy (Zamir et al., 2018). Aside from the Taskonomy dataset with 4 million images labeled for 26 tasks, this paper introduces a computational method to automatically construct a taxonomy of visual tasks based on transfer relationships between tasks. To do this, a single-task network is trained on each individual task, then transfer relationships are computed by answering the following question for each pair of tasks: How well can we perform task i by training a decoder on top of a feature extractor which was trained on task j ? This is a bit of a simplification, as the actual training setup involves transferring from multiple source tasks to a single target task, but the main idea is the same. Once the transfer affinities are computed, the problem of constructing a task taxonomy is characterized as choosing the ideal source task or tasks for each target task in a way that satisfies a budget on the number of source tasks. The motivation here is to limit the number of tasks which have access to the full amount of supervised data (these are the source tasks), and to learn the

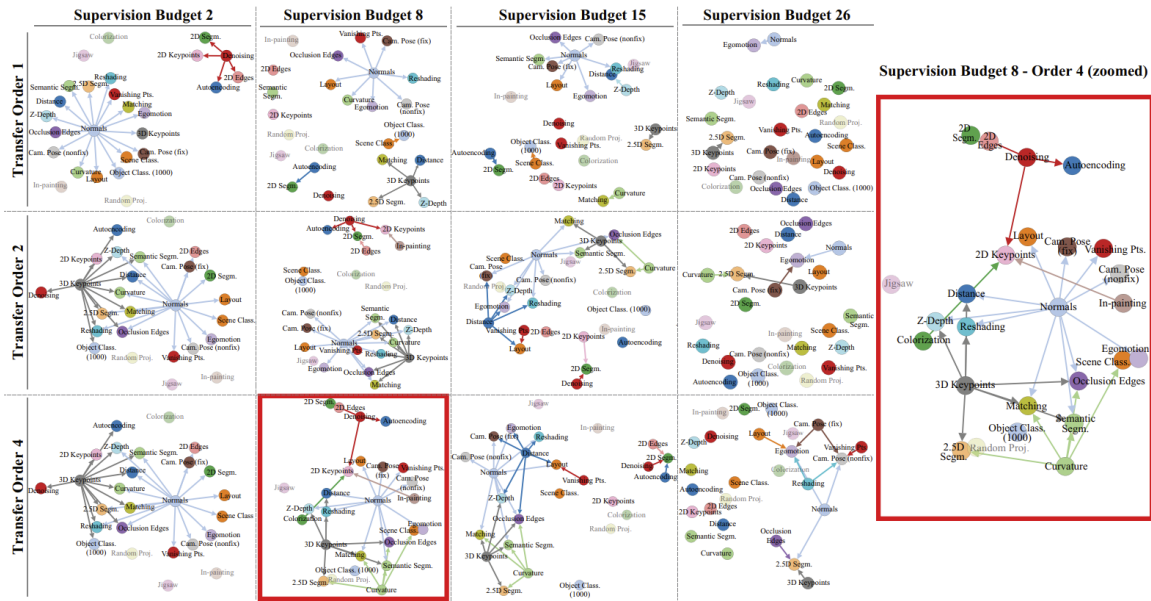

Figure 25: Task taxonomies for a collection of computer vision tasks as computed in Taskonomy (Zamir et al., 2018). An edge from task i to task j denotes that task i is an ideal source task to perform transfer learning on task j .

remainder of tasks by transferring from the source tasks, with only a small amount of training data to train the decoder on top of the transferred feature extractor. The problem of choosing the ideal set of source tasks and which source tasks to use for each target task (given the task transfer affinities) is encoded as a Boolean Integer Programming problem. The solution can be represented as a directed graph in which the nodes are tasks, and the presence of an edge from task i to task j means that task i is included in the set of source tasks for task j . Some resulting taxonomies for varying supervision budgets and transfer order (maximum number of source tasks for each target task) are shown in figure 25. Taskonomy is the first large scale empirical study to analyze task transfer relationships and compute an explicit hierarchy of tasks based on their transfer relationships, and by doing so they are able to compute optimal transfer policies for learning a group of related tasks with limited supervision. However, their method of doing so is extremely expensive, since it involves training for a huge number of combinations of source/target tasks. The entire process of constructing task taxonomies took 47,886 GPU hours.

A similarly inspired but much more efficient method for learning task transfer relationships is introduced in (Dwivedi and Roig, 2019), which uses Representation Similarity Analysis (RSA) (Kriegeskorte, 2008) to compute a measure of similarity between tasks. RSA is a commonly used tool in computational neuroscience to quantitatively compare measures of neural activity, and it has been adopted for analyzing neural network activations by the deep learning community in recent years (Vandenhende et al., 2019). The underlying assumption behind the RSA transfer model in (Dwivedi and Roig, 2019) is that if two tasks would exhibit positive transfer, then single-task networks trained on each of them will tend to learn similar representations, and so RSA will be an accurate measure of the transfer affinities of the task at hand. Because RSA only involves comparing the representations of different networks, there is no need to actually perform any transfer learning between each pair of tasks, making the RSA transfer model orders of magnitude faster than Taskonomy. Furthermore, the authors find that the computed task affinities from RSA are nearly independent of the size of the models used to train on the tasks, so that the computation of the task relationships can be done with very small models in order to cut computation cost even more.

Most recently, (Song et al., 2019) follows a similar approach as the RSA transfer model: compare the similarity of single-task networks to compute task transfer affinities, instead of actually performing transfer learning. Instead of comparing the networks' learned representations, the method presented in (Song et al., 2019) compares their attribution maps on the same input data. An attribution map is a scoring over the individual units of a network's input which represents the relevance of each unit to the network's output. In computer vision, for example, an attribution map assigns a relevance score to each pixel in the input. Just as the RSA transfer model assumes that tasks with positive transfer will learn similar representations, the attribution map transfer model assumes that such tasks will pay attention to the same parts of an input. This approach shows similar results as the RSA transfer model: orders of magnitude

speedup compared to Taskonomy without degradation of the results. Unfortunately, this work doesn't include any direct comparison with the RSA transfer model, so there is no evidence of superiority of either model.

The existing methods for learning task transfer relationships are all very recent, and there is much more work to be done in this area. One interesting thing to note is the manner in which the RSA and attribution map transfer models (Kriegeskorte, 2008; Song et al., 2019) achieve efficiency while computing nontrivial information. To summarize succinctly, these models use the network to train the network. Both methods leverage information learned by the single-task networks (either intermediate representations or relevance scoring) in order to inform training downstream. Taskonomy, on the other hand, trains extra networks to do what these two methods did without any extra training. It goes to show that the rich information learned by deep networks isn't only useful for the network's forward pass. In general, even outside of MTL, this information can and should be leveraged to further inform model training: Use the network to train the network.

4.3 Task Embeddings

Although they are mostly used for meta-learning, task embeddings are a very general form of learning task relationships, and are strongly related to the methods we have so far discussed in this section. Even with this strong tie between models, there is a significant lack of methods in MTL which utilize task embeddings. This shouldn't come as a surprise, though. Task embeddings find their most use in situations where a new task is given after already learning a number of tasks from the same distribution, and this new task must be localized with respect to tasks already learned. If the set of tasks for a model to learn is fixed - as is the case with MTL - why should one assign a vector representation to each task? Still, we feel that the connection to TRL is important, so we provide a brief summary of several task embedding methods in the meta-learning literature.

(James et al., 2018) uses metric learning to construct a task embedding for imitation learning of various robotic manipulation tasks. This model, named TecNet, is comprised of an embedding network and a control network. The embedding network produces a vector representation of a task given many examples from that task, while the control network takes an observation and a task representation as input to produce an action. Instead of computing a task embedding from expert demonstrations, (Achille et al., 2019) constructs them from the Fisher Information Matrix of a pre-trained network. Lastly, (Lan et al., 2019) trains a shared policy for meta-reinforcement learning which is conditioned on task embeddings. These task embeddings are the outputs of a task encoder which is trained to output embeddings based on experience from each task.

5 Multi-Task Benchmarks

In this section, we give a short overview of commonly used benchmarks in various domains of multi-task learning, including benchmarks for computer vision, natural language processing, reinforcement learning, and multi-modal problems. It should be noted that, while there are a few benchmarks specifically designed for multi-task learning (such as Taskonomy (Zamir et al., 2018) and Meta-World (Yu et al., 2019)), these are few and far between. Most MTL methods are evaluated in multi-task settings which use generic benchmarks that include supervision for multiple tasks, such as NYU-v2 (Silberman et al., 2012). Lastly, the benchmarks discussed here aren't an exhaustive list, just a highlight of some of the most commonly used MTL benchmarks. The benchmarks within each domain are sorted by release date starting with the earliest.

5.1 Computer Vision Benchmarks

- **NYU-v2** (Silberman et al., 2012) is a dataset of RGB-depth images from 464 indoor scenes with 1449 densely labeled images and over 400,000 unlabeled images. The labeled images are labeled for instance segmentation, semantic segmentation, and scene classification, and all images contain depth values for each pixel. All images are frames extracted from video sequences.
- **MS-COCO** (Lin et al., 2014) contains 328,000 images of natural scenes with a total of 2.5 million object instances spanning 91 object types. The images contain labels for image classification, semantic segmentation, and instance segmentation.
- **CelebA** (Liu et al., 2015b) has 200,000 images of celebrity faces, with 20 images of 10,000 different people. Each image is labeled with 40 face attributes and five keypoints, for a total of 8 million facial attribute labels.
- **OmniGlott** (Lake et al., 2015) contains images of characters, unlike many of the other popular natural image benchmarks. The dataset contains images of 1623 characters from 50 different alphabets, operating in a low-data regime. Omniglott was designed with a focus on few-shot learning and meta-learning in image classification and generative modeling.

- **CityScapes** (Cordts et al., 2016) is comprised of video frames shot in the streets of 50 urban cities. The densely labeled subset of the dataset contains 5000 images with pixel-level annotations, while 20000 other images are coarsely labeled. The images are labeled for image classification, semantic segmentation, and instance segmentation.
- **Taskonomy** (Zamir et al., 2018) may be the only large scale computer vision dataset specifically intended for research with multi-task learning. The dataset consists of 4 million images of indoor scenes from 600 different buildings, and each image is annotated for 26 different visual tasks, including 2D, 2.5D, and 3D tasks.

5.2 Natural Language Processing Benchmarks

Unless otherwise specified, it can be assumed that the text within a corpus is English.

- **Penn Treebank** (Marcus et al., 1993) is a corpus of text consisting of 4.5 million words. The text is aggregated from multiple sources including scientific abstracts, news stories, book chapters, computer manuals, and more, and contains Part-of-Speech tags and syntactical structure annotations.
- **OntoNotes 5.0** (Weischedel et al., 2013) is a multi-lingual corpus of Arabic, English, and Chinese text with 2.9 million words total, labeled for syntax and predicate argument structure, coreference resolution, and word sense disambiguation. The text sources consist of written news, broadcast news, web data, and more.
- **WMT 14** (Bojar et al., 2014) is a dataset from the 2014 Workshop on Statistical Machine Translation, with parallel corpora of many language pairs, including French-English, German-English, Hindi-English, Russian-English, and Czech-English. These corpora vary in size between 90 million total English sentences and 1 million total Hindi sentences.
- **Stanford Natural Language Inference** (Bowman et al., 2015) contains 570,000 sentence pairs, where each pair contains a label describing their relationship as either neutral, entailment, or contradiction. The dataset was acquired through Amazon Turk, with the instructions displaying a captioned image and asking for one alternative caption, one caption that may be correct, and one caption that is certainly incorrect.
- **SciTail** (Khot et al., 2018) is a textual entailment dataset consisting of scientific statements. The corpus was constructed by converting multiple choice questions on science exams (and web data) into entailed and non-entailed pairs, for a total of 27,000 total examples.
- **GLUE** (Wang et al., 2018) consists of nine NLP tasks accompanied with data from previously existing NLP corpora. The benchmark is intended to be used to evaluate general language understanding models that can handle all or multiple tasks simultaneously. Some tasks are intentionally provided with small amounts of training data to encourage information sharing between tasks.
- **decaNLP** (McCann et al., 2018) is a collection of ten NLP tasks which are all posed as question answering. This is a new approach to NLP benchmarking: instead of the task being specified by explicit constraints on the input/output, each task is given to the model with a description in natural language. Each example is a 3-tuple of question, context, and answer.

5.3 Reinforcement Learning Benchmarks

- **Arcade Learning Environment** (Bellemare et al., 2013) (or ALE) is a diverse collection of hundreds of Atari 2600 games, where observations are given to the agent as raw pixels. These games were originally designed to be a challenge for the human video game player, so they present a challenge for modern RL agents in aspects such as exploration and learning with sparse rewards.
- **DeepMind Lab** (Beattie et al., 2016) is a 3D first person game platform which requires the agent to make actions from raw pixels. DeepMind Lab offers the ability to customize environments through the observations, termination conditions, reward functions, and more. The 3D nature of the environment makes for a challenge not just in strategic decision making but also in perception.
- **Meta-World** (Yu et al., 2019) is a collection of robotic manipulation tasks designed to encourage research in multi-task learning and meta-learning. The collection consists of 50 tasks for a simulated Sawyer robotic arm, each task with its own parametric variations, such as goal position. The multi-task benchmarks within Meta-World are MT10 and MT50, which consist of simultaneously learning 10 and 50 tasks, respectively, while the meta-learning benchmarks are ML10 and ML45, which consist of learning on 10 and 45 tasks before being asked to quickly adapt to new unseen tasks.

5.4 Multi-Modal Benchmarks

- **Flickr30K Captions** (Young et al., 2014) is a collection of 30,000 photographs obtained from the image hosting website Flickr, with over 150,000 corresponding captions.
- **MS-COCO Captions** (Chen et al., 2015) contains over 1.5 million captions of more than 300,000 photos from the MS-COCO (Lin et al., 2014) dataset. These captions were collected using Amazon Mechanical Turk.
- **Visual Genome** (Krishna et al., 2017) is made of over 100,000 densely annotated images with a focus on a grounding connection between visual and linguistic concepts. Each image contains over 40 regions which each have their own description, 17 (on average) question-answer pairs per image, an average of 21 object annotations per image, attribute labels per object, and relationship annotations between objects.
- **Flickr30K Entities** (Plummer et al., 2015) augments the Flickr30K dataset with 276,000 annotated bounding boxes and 244,000 coreference chains. The coreference chains identify when references to objects in different captions of the same image are referring to the same object.
- **GuessWhat?!** (De Vries et al., 2017) is not just a dataset, but a dialogue-based guessing game in which a questioner asks an oracle about an unknown object pictured in a given image. The paper includes a collection of 150,000 games played by humans, with 800,000 visual question answer pairs on 66,000 images. The intention of GuessWhat?! is to introduce a task which bridges visual question answering with dialogue.
- **VQA 2.0** (Goyal et al., 2017) is a visual question answering dataset constructed by balancing the VQA (Antol et al., 2015) dataset with a focus on the visual aspect of visual question answering. The paper points out that a model can reach decent performance on many VQA benchmarks based only on scene regularities and the question at hand while ignoring the visual input. VQA 2.0 is balanced in the sense that every question is accompanied by two images that lead to different answers, so that a successful model must pay attention to the visual content of a given image.
- **GQA** (Hudson and Manning, 2019) is another visual question answering dataset, constructed by leveraging scene graphs to create 22 million questions for their corresponding images. The programmatic construction of the dataset allowed for each question to be accompanied by a functional program which characterizes the question semantics, and for the distribution of answers to be tuned to minimize bias.

6 Conclusion

We have presented a review of the field of multi-task learning, covering the three broad directions of architecture design, optimization techniques, and task relationship learning. Currently, key techniques for the construction of multi-task neural networks include shared feature extractors with task-specific decoders, varying parameter sharing schemes in existing network architectures, sharing and recombination of neural network modules, learning what to share, and fine-grained parameter sharing. The most prominent directions within optimization are per-task loss weighting, such as by uncertainty or learning speed, regularization with L_2 and trace norms, gradient modulation and replacement to avoid conflicting gradients between tasks, and multi-objective optimization. Finally, several methods have been proposed to learn relationships between tasks, such as large-scale empirical studies to determine which tasks exhibit positive learning dynamics when learned simultaneously, comparing representations of networks to determine task similarity, and learning task embeddings.

Despite the progress the community has made so far to develop multi-task learning for deep networks, there is one direction of research that has had less development than others, and that we have not discussed at all so far: theory. This shouldn't come as a surprise, given that this is also true of deep learning in general. Still, many non-neural multi-task learning methods are motivated and justified by strong theory (Baxter, 2000; Ben-David and Borbely, 2008; Zhang, 2015; Lounici et al., 2009), but aside from a small pool of recent work (Shui et al., 2019; Ndirango and Lee, 2019; D'Eramo et al., 2020; Wu et al., 2020; Zhang et al., 2020; Bettgenhäuser et al., 2020), there is a lack of theoretical understanding of MTL with deep neural networks. This is an important area to promote a deeper understanding of the field as a whole, and we hope to see more development in this direction in the coming years.

We believe that the development of multi-task learning (and the related fields of meta-learning, transfer learning, and continuous/lifelong learning) is an important step towards developing artificial intelligence with more human-like qualities. In order to build machines that can learn as quickly and robustly as humans, we must create techniques for learning general underlying concepts which are applicable between tasks and applying these concepts to new and unfamiliar situations. Building systems that truly exhibit these qualities will require approaches from many different directions, likely including many that researchers haven't yet discovered. The field has come a long way, but continued effort from the research community is needed to fully achieve the potential of multi-task methods.

References

- Alessandro Achille, Michael Lam, Rahul Tewari, Avinash Ravichandran, Subhansu Maji, Charless C Fowlkes, Stefano Soatto, and Pietro Perona. Task2vec: Task embedding for meta-learning. In *Proceedings of the IEEE International Conference on Computer Vision*, pages 6430–6439, 2019.
- Chanho Ahn, Eunwoo Kim, and Songhwai Oh. Deep elastic networks with model selection for multi-task learning. In *Proceedings of the IEEE International Conference on Computer Vision*, pages 6529–6538, 2019.
- Md Shad Akhtar, Dushyant Singh Chauhan, Deepanway Ghosal, Soujanya Poria, Asif Ekbal, and Pushpak Bhattacharyya. Multi-task learning for multi-modal emotion recognition and sentiment analysis. *arXiv preprint arXiv:1905.05812*, 2019.
- Ilge Akkaya, Marcin Andrychowicz, Maciek Chociej, Mateusz Litwin, Bob McGrew, Arthur Petron, Alex Paino, Matthias Plappert, Glenn Powell, Raphael Ribas, et al. Solving rubik’s cube with a robot hand. *arXiv preprint arXiv:1910.07113*, 2019.
- Ferran Alet, Tomás Lozano-Pérez, and Leslie P Kaelbling. Modular meta-learning. *arXiv preprint arXiv:1806.10166*, 2018.
- Héctor Martínez Alonso and Barbara Plank. When is multitask learning effective? semantic sequence prediction under varying data conditions. *arXiv preprint arXiv:1612.02251*, 2016.
- Jacob Andreas, Marcus Rohrbach, Trevor Darrell, and Dan Klein. Neural module networks. In *Proceedings of the IEEE Conference on Computer Vision and Pattern Recognition*, pages 39–48, 2016.
- Jacob Andreas, Dan Klein, and Sergey Levine. Modular multitask reinforcement learning with policy sketches. In *International Conference on Machine Learning*, pages 166–175, 2017.
- Stanislaw Antol, Aishwarya Agrawal, Jiasen Lu, Margaret Mitchell, Dhruv Batra, C Lawrence Zitnick, and Devi Parikh. Vqa: Visual question answering. In *Proceedings of the IEEE international conference on computer vision*, pages 2425–2433, 2015.
- Andreas Argyriou, Theodoros Evgeniou, and Massimiliano Pontil. Convex multi-task feature learning. *Machine Learning*, 73(3):243–272, January 2008. doi: 10.1007/s10994-007-5040-8. URL <https://doi.org/10.1007/s10994-007-5040-8>.
- Tadas Baltrusaitis, Chaitanya Ahuja, and Louis-Philippe Morency. Multimodal machine learning: A survey and taxonomy. *IEEE Trans. Pattern Anal. Mach. Intell.*, 41(2):423–443, February 2019. ISSN 0162-8828. doi: 10.1109/TPAMI.2018.2798607. URL <https://doi.org/10.1109/TPAMI.2018.2798607>.
- Jonathan Baxter. A model of inductive bias learning. *Journal of artificial intelligence research*, 12:149–198, 2000.
- Charles Beattie, Joel Z Leibo, Denis Teplyashin, Tom Ward, Marcus Wainwright, Heinrich Küttler, Andrew Lefrancq, Simon Green, Víctor Valdés, Amir Sadik, et al. Deepmind lab. *arXiv preprint arXiv:1612.03801*, 2016.
- Marc G Bellemare, Yavar Naddaf, Joel Veness, and Michael Bowling. The arcade learning environment: An evaluation platform for general agents. *Journal of Artificial Intelligence Research*, 47:253–279, 2013.
- Shai Ben-David and Reba Schuller Borbely. A notion of task relatedness yielding provable multiple-task learning guarantees. *Mach. Learn.*, 73(3):273–287, December 2008. ISSN 0885-6125. doi: 10.1007/s10994-007-5043-5. URL <https://doi.org/10.1007/s10994-007-5043-5>.
- Yoshua Bengio, Jérôme Louradour, Ronan Collobert, and Jason Weston. Curriculum learning. In *Proceedings of the 26th Annual International Conference on Machine Learning, ICML ’09*, page 41–48, New York, NY, USA, 2009. Association for Computing Machinery. ISBN 9781605585161. doi: 10.1145/1553374.1553380. URL <https://doi.org/10.1145/1553374.1553380>.
- Yoshua Bengio, Nicholas Léonard, and Aaron Courville. Estimating or propagating gradients through stochastic neurons for conditional computation. *arXiv preprint arXiv:1308.3432*, 2013.
- Gabriele Bettgenhäuser, Michael A Hedderich, and Dietrich Klakow. Learning functions to study the benefit of multitask learning. *arXiv preprint arXiv:2006.05561*, 2020.
- Joachim Bingel and Anders Søgaard. Identifying beneficial task relations for multi-task learning in deep neural networks. *arXiv preprint arXiv:1702.08303*, 2017.
- Ondřej Bojar, Christian Buck, Christian Federmann, Barry Haddow, Philipp Koehn, Johannes Leveling, Christof Monz, Pavel Pecina, Matt Post, Herve Saint-Amant, Radu Soricut, Lucia Specia, and Aleš Tamchyna. Findings of the 2014 workshop on statistical machine translation. In *Proceedings of the Ninth Workshop on Statistical Machine Translation*, pages 12–58, Baltimore, Maryland, USA, June 2014. Association for Computational Linguistics. doi: 10.3115/v1/W14-3302. URL <https://www.aclweb.org/anthology/W14-3302>.

- Samuel R. Bowman, Gabor Angeli, Christopher Potts, and Christopher D. Manning. A large annotated corpus for learning natural language inference. In *Proceedings of the 2015 Conference on Empirical Methods in Natural Language Processing*, pages 632–642, Lisbon, Portugal, September 2015. Association for Computational Linguistics. doi: 10.18653/v1/D15-1075. URL <https://www.aclweb.org/anthology/D15-1075>.
- Felix JS Bragman, Ryutaro Tanno, Sebastien Ourselin, Daniel C Alexander, and Jorge Cardoso. Stochastic filter groups for multi-task cnns: Learning specialist and generalist convolution kernels. In *Proceedings of the IEEE International Conference on Computer Vision*, pages 1385–1394, 2019.
- Cristian Bucila, Rich Caruana, and Alexandru Niculescu-Mizil. Model compression. In *Proceedings of the 12th ACM SIGKDD International Conference on Knowledge Discovery and Data Mining, KDD '06*, page 535–541, New York, NY, USA, 2006. Association for Computing Machinery. ISBN 1595933395. doi: 10.1145/1150402.1150464. URL <https://doi.org/10.1145/1150402.1150464>.
- Ignacio Cases, Clemens Rosenbaum, Matthew Riemer, Atticus Geiger, Tim Klinger, Alex Tamkin, Olivia Li, Sandhini Agarwal, Joshua D. Greene, Dan Jurafsky, Christopher Potts, and Lauri Karttunen. Recursive routing networks: Learning to compose modules for language understanding. In *Proceedings of the 2019 Conference of the North American Chapter of the Association for Computational Linguistics: Human Language Technologies, Volume 1 (Long and Short Papers)*, pages 3631–3648, Minneapolis, Minnesota, June 2019. Association for Computational Linguistics. doi: 10.18653/v1/N19-1365. URL <https://www.aclweb.org/anthology/N19-1365>.
- Michael B Chang, Abhishek Gupta, Sergey Levine, and Thomas L Griffiths. Automatically composing representation transformations as a means for generalization. *arXiv preprint arXiv:1807.04640*, 2018.
- Arslan Chaudhry, Marc’ Aurelio Ranzato, Marcus Rohrbach, and Mohamed Elhoseiny. Efficient lifelong learning with a-gem. *arXiv preprint arXiv:1812.00420*, 2018.
- Danqi Chen and Christopher Manning. A fast and accurate dependency parser using neural networks. In *Proceedings of the 2014 Conference on Empirical Methods in Natural Language Processing (EMNLP)*, pages 740–750, Doha, Qatar, October 2014. Association for Computational Linguistics. doi: 10.3115/v1/D14-1082. URL <https://www.aclweb.org/anthology/D14-1082>.
- Junkun Chen, Kaiyu Chen, Xinchu Chen, Xipeng Qiu, and Xuanjing Huang. Exploring shared structures and hierarchies for multiple nlp tasks. *arXiv preprint arXiv:1808.07658*, 2018.
- Xinlei Chen, Hao Fang, Tsung-Yi Lin, Ramakrishna Vedantam, Saurabh Gupta, Piotr Dollár, and C Lawrence Zitnick. Microsoft coco captions: Data collection and evaluation server. *arXiv preprint arXiv:1504.00325*, 2015.
- Zhao Chen, Vijay Badrinarayanan, Chen-Yu Lee, and Andrew Rabinovich. Gradnorm: Gradient normalization for adaptive loss balancing in deep multitask networks, 2017.
- Sumanth Chennupati, Ganesh Sistu, Senthil Yogamani, and Samir A Rawashdeh. Multinet++: Multi-stream feature aggregation and geometric loss strategy for multi-task learning, 2019.
- Kevin Clark, Minh-Thang Luong, Urvashi Khandelwal, Christopher D Manning, and Quoc V Le. Bam! born-again multi-task networks for natural language understanding. *arXiv preprint arXiv:1907.04829*, 2019.
- Ronan Collobert and Jason Weston. A unified architecture for natural language processing: Deep neural networks with multitask learning. In *Proceedings of the 25th International Conference on Machine Learning, ICML '08*, page 160–167, New York, NY, USA, 2008. Association for Computing Machinery. ISBN 9781605582054. doi: 10.1145/1390156.1390177. URL <https://doi.org/10.1145/1390156.1390177>.
- Ronan Collobert, Jason Weston, Léon Bottou, Michael Karlen, Koray Kavukcuoglu, and Pavel Kuksa. Natural language processing (almost) from scratch. *Journal of machine learning research*, 12(Aug):2493–2537, 2011.
- Marius Cordts, Mohamed Omran, Sebastian Ramos, Timo Rehfeld, Markus Enzweiler, Rodrigo Benenson, Uwe Franke, Stefan Roth, and Bernt Schiele. The cityscapes dataset for semantic urban scene understanding. In *Proceedings of the IEEE conference on computer vision and pattern recognition*, pages 3213–3223, 2016.
- Matthieu Courbariaux, Yoshua Bengio, and Jean-Pierre David. Binaryconnect: Training deep neural networks with binary weights during propagations. In *Advances in neural information processing systems*, pages 3123–3131, 2015.
- Jifeng Dai, Kaiming He, and Jian Sun. Instance-aware semantic segmentation via multi-task network cascades. In *Proceedings of the IEEE Conference on Computer Vision and Pattern Recognition*, pages 3150–3158, 2016.
- Harm De Vries, Florian Strub, Sarath Chandar, Olivier Pietquin, Hugo Larochelle, and Aaron Courville. Guesswhat?! visual object discovery through multi-modal dialogue. In *Proceedings of the IEEE Conference on Computer Vision and Pattern Recognition*, pages 5503–5512, 2017.
- Carlo D’Eramo, Davide Tateo, Andrea Bonarini, Marcello Restelli, and Jan Peters. Sharing knowledge in multi-task deep reinforcement learning. In *International Conference on Learning Representations*, 2020. URL <https://openreview.net/forum?id=rkgpv2VFvr>.

- Coline Devin, Abhishek Gupta, Trevor Darrell, Pieter Abbeel, and Sergey Levine. Learning modular neural network policies for multi-task and multi-robot transfer. In *2017 IEEE International Conference on Robotics and Automation (ICRA)*, pages 2169–2176. IEEE, 2017.
- Jacob Devlin, Ming-Wei Chang, Kenton Lee, and Kristina Toutanova. Bert: Pre-training of deep bidirectional transformers for language understanding. *arXiv preprint arXiv:1810.04805*, 2018.
- Carl Doersch and Andrew Zisserman. Multi-task self-supervised visual learning. In *Proceedings of the IEEE International Conference on Computer Vision*, pages 2051–2060, 2017.
- Daxiang Dong, Hua Wu, Wei He, Dianhai Yu, and Haifeng Wang. Multi-task learning for multiple language translation. In *Proceedings of the 53rd Annual Meeting of the Association for Computational Linguistics and the 7th International Joint Conference on Natural Language Processing (Volume 1: Long Papers)*, pages 1723–1732, Beijing, China, July 2015. Association for Computational Linguistics. doi: 10.3115/v1/P15-1166. URL <https://www.aclweb.org/anthology/P15-1166>.
- Johann Dréo. Pareto front. *Wikipedia Commons*, 2006. URL https://commons.wikimedia.org/wiki/File:Front_pareto.svg.
- Yunshu Du, Wojciech M. Czarnecki, Siddhant M. Jayakumar, Razvan Pascanu, and Balaji Lakshminarayanan. Adapting auxiliary losses using gradient similarity, 2018.
- Long Duong, Trevor Cohn, Steven Bird, and Paul Cook. Low resource dependency parsing: Cross-lingual parameter sharing in a neural network parser. In *Proceedings of the 53rd Annual Meeting of the Association for Computational Linguistics and the 7th International Joint Conference on Natural Language Processing (Volume 2: Short Papers)*, pages 845–850, Beijing, China, July 2015. Association for Computational Linguistics. doi: 10.3115/v1/P15-2139. URL <https://www.aclweb.org/anthology/P15-2139>.
- Kshitij Dwivedi and Gemma Roig. Representation similarity analysis for efficient task taxonomy & transfer learning. In *Proceedings of the IEEE Conference on Computer Vision and Pattern Recognition*, pages 12387–12396, 2019.
- Jean-Antoine Désidéri. Multiple-gradient descent algorithm (mgda) for multiobjective optimization. *Comptes Rendus Mathématique*, 350(5):313 – 318, 2012. ISSN 1631-073X. doi: <https://doi.org/10.1016/j.crma.2012.03.014>. URL <http://www.sciencedirect.com/science/article/pii/S1631073X12000738>.
- Lasse Espeholt, Hubert Soyer, Remi Munos, Karen Simonyan, Volodymyr Mnih, Tom Ward, Yotam Doron, Vlad Firoiu, Tim Harley, Iain Dunning, et al. Impala: Scalable distributed deep-rl with importance weighted actor-learner architectures. *arXiv preprint arXiv:1802.01561*, 2018.
- Theodoros Evgeniou and Massimiliano Pontil. Regularized multi-task learning. In *Proceedings of the Tenth ACM SIGKDD International Conference on Knowledge Discovery and Data Mining, KDD '04*, page 109–117, New York, NY, USA, 2004. Association for Computing Machinery. ISBN 1581138881. doi: 10.1145/1014052.1014067. URL <https://doi.org/10.1145/1014052.1014067>.
- Chrisantha Fernando, Dylan Banarse, Charles Blundell, Yori Zwols, David Ha, Andrei A Rusu, Alexander Pritzel, and Daan Wierstra. Pathnet: Evolution channels gradient descent in super neural networks. *arXiv preprint arXiv:1701.08734*, 2017.
- Jonathan Frankle and Michael Carbin. The lottery ticket hypothesis: Finding sparse, trainable neural networks. *arXiv preprint arXiv:1803.03635*, 2018.
- Yuan Gao, Jiayi Ma, Mingbo Zhao, Wei Liu, and Alan L Yuille. Nddr-cnn: Layerwise feature fusing in multi-task cnns by neural discriminative dimensionality reduction. In *Proceedings of the IEEE Conference on Computer Vision and Pattern Recognition*, pages 3205–3214, 2019.
- Yuan Gao, Haoping Bai, Zequn Jie, Jiayi Ma, Kui Jia, and Wei Liu. Mtl-nas: Task-agnostic neural architecture search towards general-purpose multi-task learning. In *Proceedings of the IEEE/CVF Conference on Computer Vision and Pattern Recognition*, pages 11543–11552, 2020.
- Ting Gong, Tyler Lee, Cory Stephenson, Venkata Renduchintala, Suchismita Padhy, Anthony Ndirango, Gokce Keskin, and Oguz H. Elibol. A comparison of loss weighting strategies for multi task learning in deep neural networks, 2019.
- Yash Goyal, Tejas Khot, Douglas Summers-Stay, Dhruv Batra, and Devi Parikh. Making the v in vqa matter: Elevating the role of image understanding in visual question answering. In *Proceedings of the IEEE Conference on Computer Vision and Pattern Recognition*, pages 6904–6913, 2017.
- Michelle Guo, Albert Haque, De-An Huang, Serena Yeung, and Li Fei-Fei. Dynamic task prioritization for multitask learning. In Vittorio Ferrari, Martial Hebert, Cristian Sminchisescu, and Yair Weiss, editors, *Computer Vision – ECCV 2018*, pages 282–299, Cham, 2018. Springer International Publishing. ISBN 978-3-030-01270-0.

- Tuomas Haarnoja, Aurick Zhou, Pieter Abbeel, and Sergey Levine. Soft actor-critic: Off-policy maximum entropy deep reinforcement learning with a stochastic actor. *arXiv preprint arXiv:1801.01290*, 2018.
- Kazuma Hashimoto, Caiming Xiong, Yoshimasa Tsuruoka, and Richard Socher. A joint many-task model: Growing a neural network for multiple nlp tasks. *arXiv preprint arXiv:1611.01587*, 2016.
- Kaiming He, Xiangyu Zhang, Shaoqing Ren, and Jian Sun. Deep residual learning for image recognition. In *The IEEE Conference on Computer Vision and Pattern Recognition (CVPR)*, June 2016.
- Nicolas Heess, Greg Wayne, Yuval Tassa, Timothy Lillicrap, Martin Riedmiller, and David Silver. Learning and transfer of modulated locomotor controllers. *arXiv preprint arXiv:1610.05182*, 2016.
- Matteo Hessel, Hubert Soyer, Lasse Espeholt, Wojciech Czarnecki, Simon Schmitt, and Hado van Hasselt. Multi-task deep reinforcement learning with popart, 2018.
- Timothy Hospedales, Antreas Antoniou, Paul Micaelli, and Amos Storkey. Meta-learning in neural networks: A survey. *arXiv preprint arXiv:2004.05439*, 2020.
- Jie Hu, Li Shen, and Gang Sun. Squeeze-and-excitation networks. In *Proceedings of the IEEE Conference on Computer Vision and Pattern Recognition (CVPR)*, June 2018.
- Drew A Hudson and Christopher D Manning. Gqa: A new dataset for real-world visual reasoning and compositional question answering. In *Proceedings of the IEEE Conference on Computer Vision and Pattern Recognition*, pages 6700–6709, 2019.
- Sergey Ioffe and Christian Szegedy. Batch normalization: Accelerating deep network training by reducing internal covariate shift. *arXiv preprint arXiv:1502.03167*, 2015.
- Max Jaderberg, Volodymyr Mnih, Wojciech Marian Czarnecki, Tom Schaul, Joel Z Leibo, David Silver, and Koray Kavukcuoglu. Reinforcement learning with unsupervised auxiliary tasks. *arXiv preprint arXiv:1611.05397*, 2016.
- Stephen James, Michael Bloesch, and Andrew J Davison. Task-embedded control networks for few-shot imitation learning. *arXiv preprint arXiv:1810.03237*, 2018.
- Eric Jang, Shixiang Gu, and Ben Poole. Categorical reparameterization with gumbel-softmax. *arXiv preprint arXiv:1611.01144*, 2016.
- Sébastien Jean, Orhan Firat, and Melvin Johnson. Adaptive scheduling for multi-task learning. *arXiv preprint arXiv:1909.06434*, 2019.
- Lukasz Kaiser, Aidan N Gomez, Noam Shazeer, Ashish Vaswani, Niki Parmar, Llion Jones, and Jakob Uszkoreit. One model to learn them all. *arXiv preprint arXiv:1706.05137*, 2017.
- Alex Kendall, Yarin Gal, and Roberto Cipolla. Multi-task learning using uncertainty to weigh losses for scene geometry and semantics, 2017.
- Tushar Khot, A. Sabharwal, and Peter Clark. Scitail: A textual entailment dataset from science question answering. In *AAAI*, 2018.
- Louis Kirsch, Julius Kunze, and David Barber. Modular networks: Learning to decompose neural computation. In *Advances in Neural Information Processing Systems*, pages 2408–2418, 2018.
- Dan Klein and Christopher D. Manning. Accurate unlexicalized parsing. In *Proceedings of the 41st Annual Meeting on Association for Computational Linguistics - Volume 1*, ACL '03, page 423–430, USA, 2003. Association for Computational Linguistics. doi: 10.3115/1075096.1075150. URL <https://doi.org/10.3115/1075096.1075150>.
- Nikolaus Kriegeskorte. Representational similarity analysis – connecting the branches of systems neuroscience. *Frontiers in Systems Neuroscience*, 2008. doi: 10.3389/neuro.06.004.2008. URL <https://doi.org/10.3389/neuro.06.004.2008>.
- Ranjay Krishna, Yuke Zhu, Oliver Groth, Justin Johnson, Kenji Hata, Joshua Kravitz, Stephanie Chen, Yannis Kalantidis, Li-Jia Li, David A Shamma, et al. Visual genome: Connecting language and vision using crowdsourced dense image annotations. *International journal of computer vision*, 123(1):32–73, 2017.
- Tejas D Kulkarni, Karthik Narasimhan, Ardavan Saeedi, and Josh Tenenbaum. Hierarchical deep reinforcement learning: Integrating temporal abstraction and intrinsic motivation. In *Advances in neural information processing systems*, pages 3675–3683, 2016.
- Abhishek Kumar and Hal Daume III. Learning task grouping and overlap in multi-task learning. *arXiv preprint arXiv:1206.6417*, 2012.

- Brenden M. Lake, Ruslan Salakhutdinov, and Joshua B. Tenenbaum. Human-level concept learning through probabilistic program induction. *Science*, 350(6266):1332–1338, 2015. ISSN 0036-8075. doi: 10.1126/science.aab3050. URL <https://science.sciencemag.org/content/350/6266/1332>.
- Lin Lan, Zhenguo Li, Xiaohong Guan, and Pinghui Wang. Meta reinforcement learning with task embedding and shared policy. *arXiv preprint arXiv:1905.06527*, 2019.
- Giwoong Lee, Eunho Yang, and Sung Hwang. Asymmetric multi-task learning based on task relatedness and loss. In Maria Florina Balcan and Kilian Q. Weinberger, editors, *Proceedings of The 33rd International Conference on Machine Learning*, volume 48 of *Proceedings of Machine Learning Research*, pages 230–238, New York, New York, USA, 20–22 Jun 2016. PMLR. URL <http://proceedings.mlr.press/v48/leeb16.html>.
- Hae Beom Lee, Eunho Yang, and Sung Ju Hwang. Deep asymmetric multi-task feature learning. In *International Conference on Machine Learning*, pages 2956–2964, 2018.
- Changsheng Li, Junchi Yan, Fan Wei, Weishan Dong, Qingshan Liu, and Hongyuan Zha. Self-paced multi-task learning. *arXiv preprint arXiv:1604.01474*, 2016.
- Jason Liang, Elliot Meyerson, and Risto Miikkulainen. Evolutionary architecture search for deep multitask networks. In *Proceedings of the Genetic and Evolutionary Computation Conference*, pages 466–473, 2018.
- Tsung-Yi Lin, Michael Maire, Serge Belongie, James Hays, Pietro Perona, Deva Ramanan, Piotr Dollár, and C Lawrence Zitnick. Microsoft coco: Common objects in context. In *European conference on computer vision*, pages 740–755. Springer, 2014.
- Tsung-Yi Lin, Priya Goyal, Ross Girshick, Kaiming He, and Piotr Dollár. Focal loss for dense object detection. In *Proceedings of the IEEE international conference on computer vision*, pages 2980–2988, 2017.
- Xi Lin, Hui-Ling Zhen, Zhenhua Li, Qing-Fu Zhang, and Sam Kwong. Pareto multi-task learning. In *Advances in Neural Information Processing Systems*, pages 12060–12070, 2019.
- Hanxiao Liu, Karen Simonyan, and Yiming Yang. Darts: Differentiable architecture search. *arXiv preprint arXiv:1806.09055*, 2018.
- Pengfei Liu, Xipeng Qiu, and Xuanjing Huang. Recurrent neural network for text classification with multi-task learning. *arXiv preprint arXiv:1605.05101*, 2016a.
- Pengfei Liu, Xipeng Qiu, and Xuanjing Huang. Deep multi-task learning with shared memory. *arXiv preprint arXiv:1609.07222*, 2016b.
- Pengfei Liu, Xipeng Qiu, and Xuanjing Huang. Adversarial multi-task learning for text classification. *arXiv preprint arXiv:1704.05742*, 2017.
- S. Liu, E. Johns, and A. J. Davison. End-to-end multi-task learning with attention. In *2019 IEEE/CVF Conference on Computer Vision and Pattern Recognition (CVPR)*, pages 1871–1880, 2019.
- Shengchao Liu, Yingyu Liang, and Anthony Gitter. Loss-balanced task weighting to reduce negative transfer in multi-task learning. In *Proceedings of the AAAI Conference on Artificial Intelligence*, volume 33, pages 9977–9978, 2019a.
- Xiaodong Liu, Jianfeng Gao, Xiaodong He, Li Deng, Kevin Duh, and Ye-yi Wang. Representation learning using multi-task deep neural networks for semantic classification and information retrieval. In *Proceedings of the 2015 Conference of the North American Chapter of the Association for Computational Linguistics: Human Language Technologies*, pages 912–921, Denver, Colorado, May–June 2015a. Association for Computational Linguistics. doi: 10.3115/v1/N15-1092. URL <https://www.aclweb.org/anthology/N15-1092>.
- Xiaodong Liu, Pengcheng He, Weizhu Chen, and Jianfeng Gao. Multi-task deep neural networks for natural language understanding. *arXiv preprint arXiv:1901.11504*, 2019b.
- Xiaodong Liu, Pengcheng He, Weizhu Chen, and Jianfeng Gao. Improving multi-task deep neural networks via knowledge distillation for natural language understanding. *arXiv preprint arXiv:1904.09482*, 2019c.
- Ziwei Liu, Ping Luo, Xiaogang Wang, and Xiaoou Tang. Deep learning face attributes in the wild. In *Proceedings of the IEEE international conference on computer vision*, pages 3730–3738, 2015b.
- Mingsheng Long, Zhangjie Cao, Jianmin Wang, and S Yu Philip. Learning multiple tasks with multilinear relationship networks. In *Advances in neural information processing systems*, pages 1594–1603, 2017.
- David Lopez-Paz and Marc’Aurelio Ranzato. Gradient episodic memory for continual learning. In *Advances in neural information processing systems*, pages 6467–6476, 2017.
- Karim Lounici, Massimiliano Pontil, Alexandre B Tsybakov, and Sara Van De Geer. Taking advantage of sparsity in multi-task learning. *arXiv preprint arXiv:0903.1468*, 2009.

- Jiasen Lu, Vedanuj Goswami, Marcus Rohrbach, Devi Parikh, and Stefan Lee. 12-in-1: Multi-task vision and language representation learning. In *Proceedings of the IEEE/CVF Conference on Computer Vision and Pattern Recognition*, pages 10437–10446, 2020.
- Yongxi Lu, Abhishek Kumar, Shuangfei Zhai, Yu Cheng, Tara Javidi, and Rogerio Feris. Fully-adaptive feature sharing in multi-task networks with applications in person attribute classification. In *Proceedings of the IEEE Conference on Computer Vision and Pattern Recognition*, pages 5334–5343, 2017.
- Minh-Thang Luong, Quoc V Le, Ilya Sutskever, Oriol Vinyals, and Lukasz Kaiser. Multi-task sequence to sequence learning. *arXiv preprint arXiv:1511.06114*, 2015.
- Jiaqi Ma, Zhe Zhao, Xinyang Yi, Jilin Chen, Lichan Hong, and Ed H. Chi. Modeling task relationships in multi-task learning with multi-gate mixture-of-experts. In *Proceedings of the 24th ACM SIGKDD International Conference on Knowledge Discovery & Data Mining, KDD '18*, page 1930–1939, New York, NY, USA, 2018. Association for Computing Machinery. ISBN 9781450355520. doi: 10.1145/3219819.3220007. URL <https://doi.org/10.1145/3219819.3220007>.
- Arun Mallya, Dillon Davis, and Svetlana Lazebnik. Piggyback: Adapting a single network to multiple tasks by learning to mask weights. In *Proceedings of the European Conference on Computer Vision (ECCV)*, pages 67–82, 2018.
- Kevis-Kokitsi Maninis, Ilija Radosavovic, and Iasonas Kokkinos. Attentive single-tasking of multiple tasks. In *Proceedings of the IEEE Conference on Computer Vision and Pattern Recognition*, pages 1851–1860, 2019.
- Mitchell P. Marcus, Beatrice Santorini, and Mary Ann Marcinkiewicz. Building a large annotated corpus of English: The Penn Treebank. *Computational Linguistics*, 19(2):313–330, 1993. URL <https://www.aclweb.org/anthology/J93-2004>.
- Bryan McCann, Nitish Shirish Keskar, Caiming Xiong, and Richard Socher. The natural language decathlon: Multitask learning as question answering. *arXiv preprint arXiv:1806.08730*, 2018.
- Elliot Meyerson and Risto Miikkulainen. Beyond shared hierarchies: Deep multitask learning through soft layer ordering. *arXiv preprint arXiv:1711.00108*, 2017.
- Kaisa Miettinen. *Nonlinear multiobjective optimization*, volume 12 of *International series in operations research and management science*. Kluwer, 1998. ISBN 978-0-7923-8278-2.
- Risto Miikkulainen, Jason Liang, Elliot Meyerson, Aditya Rawal, Daniel Fink, Olivier Francon, Bala Raju, Hormoz Shahrzad, Arshak Navruzyan, Nigel Duffy, et al. Evolving deep neural networks. In *Artificial Intelligence in the Age of Neural Networks and Brain Computing*, pages 293–312. Elsevier, 2019.
- Ishan Misra, Abhinav Shrivastava, Abhinav Gupta, and Martial Hebert. Cross-stitch networks for multi-task learning. In *Proceedings of the IEEE Conference on Computer Vision and Pattern Recognition*, pages 3994–4003, 2016.
- Anthony Ndirango and Tyler Lee. Generalization in multitask deep neural classifiers: a statistical physics approach. In *Advances in Neural Information Processing Systems*, pages 15862–15871, 2019.
- Alejandro Newell, Lu Jiang, Chong Wang, Li-Jia Li, and Jia Deng. Feature partitioning for efficient multi-task architectures. *arXiv preprint arXiv:1908.04339*, 2019.
- Duy-Kien Nguyen and Takayuki Okatani. Improved fusion of visual and language representations by dense symmetric co-attention for visual question answering. In *Proceedings of the IEEE Conference on Computer Vision and Pattern Recognition*, pages 6087–6096, 2018.
- Duy-Kien Nguyen and Takayuki Okatani. Multi-task learning of hierarchical vision-language representation. In *Proceedings of the IEEE Conference on Computer Vision and Pattern Recognition*, pages 10492–10501, 2019.
- German I Parisi, Ronald Kemker, Jose L Part, Christopher Kanan, and Stefan Wermter. Continual lifelong learning with neural networks: A review. *Neural Networks*, 2019.
- Emilio Parisotto, Jimmy Lei Ba, and Ruslan Salakhutdinov. Actor-mimic: Deep multitask and transfer reinforcement learning. *arXiv preprint arXiv:1511.06342*, 2015.
- Lucas Pascal, Pietro Michiardi, Xavier Bost, Benoit Huet, and Maria A Zuluaga. Maximum roaming multi-task learning. *arXiv preprint arXiv:2006.09762*, 2020.
- Ethan Perez, Florian Strub, Harm De Vries, Vincent Dumoulin, and Aaron Courville. Film: Visual reasoning with a general conditioning layer. In *Thirty-Second AAAI Conference on Artificial Intelligence*, 2018.
- Lerrel Pinto and Abhinav Gupta. Learning to push by grasping: Using multiple tasks for effective learning. In *2017 IEEE International Conference on Robotics and Automation (ICRA)*, pages 2161–2168. IEEE, 2017.

- Bryan A Plummer, Liwei Wang, Chris M Cervantes, Juan C Caicedo, Julia Hockenmaier, and Svetlana Lazebnik. Flickr30k entities: Collecting region-to-phrase correspondences for richer image-to-sentence models. In *Proceedings of the IEEE international conference on computer vision*, pages 2641–2649, 2015.
- Subhojeet Pramanik, Priyanka Agrawal, and Aman Hussain. Omninet: A unified architecture for multi-modal multi-task learning. *arXiv preprint arXiv:1907.07804*, 2019.
- Prajit Ramachandran and Quoc V. Le. Diversity and depth in per-example routing models. In *International Conference on Learning Representations*, 2019. URL <https://openreview.net/forum?id=BkxWJnC9tX>.
- Sylvestre-Alvise Rebuffi, Hakan Bilen, and Andrea Vedaldi. Efficient parametrization of multi-domain deep neural networks. In *Proceedings of the IEEE Conference on Computer Vision and Pattern Recognition*, pages 8119–8127, 2018.
- Clemens Rosenbaum, Tim Klinger, and Matthew Riemer. Routing networks: Adaptive selection of non-linear functions for multi-task learning. *arXiv preprint arXiv:1711.01239*, 2017.
- Clemens Rosenbaum, Ignacio Cases, Matthew Riemer, and Tim Klinger. Routing networks and the challenges of modular and compositional computation. *arXiv preprint arXiv:1904.12774*, 2019.
- Sebastian Ruder. An overview of multi-task learning in deep neural networks. *arXiv preprint arXiv:1706.05098*, 2017.
- Sebastian Ruder, Joachim Bingel, Isabelle Augenstein, and Anders Søgaard. Latent multi-task architecture learning. In *Proceedings of the AAAI Conference on Artificial Intelligence*, volume 33, pages 4822–4829, 2019.
- Andrei A Rusu, Sergio Gomez Colmenarejo, Caglar Gulcehre, Guillaume Desjardins, James Kirkpatrick, Razvan Pascanu, Volodymyr Mnih, Koray Kavukcuoglu, and Raia Hadsell. Policy distillation. *arXiv preprint arXiv:1511.06295*, 2015.
- Victor Sanh, Thomas Wolf, and Sebastian Ruder. A hierarchical multi-task approach for learning embeddings from semantic tasks. In *Proceedings of the AAAI Conference on Artificial Intelligence*, volume 33, pages 6949–6956, 2019.
- John Schulman, Filip Wolski, Prafulla Dhariwal, Alec Radford, and Oleg Klimov. Proximal policy optimization algorithms. *arXiv preprint arXiv:1707.06347*, 2017.
- Ozan Sener and Vladlen Koltun. Multi-task learning as multi-objective optimization. In *Advances in Neural Information Processing Systems*, pages 527–538, 2018.
- Sahil Sharma, Ashutosh Jha, Parikshit Hegde, and Balaraman Ravindran. Learning to multi-task by active sampling. *arXiv preprint arXiv:1702.06053*, 2017.
- Changjian Shui, Mahdieh Abbasi, Louis-Émile Robitaille, Boyu Wang, and Christian Gagné. A principled approach for learning task similarity in multitask learning. *arXiv preprint arXiv:1903.09109*, 2019.
- Nathan Silberman, Derek Hoiem, Pushmeet Kohli, and Rob Fergus. Indoor segmentation and support inference from rgb-d images. In *Computer Vision – ECCV 2012*, pages 746–760, Berlin, Heidelberg, 2012. Springer Berlin Heidelberg. ISBN 978-3-642-33715-4.
- Ayan Sinha, Zhao Chen, Vijay Badrinarayanan, and Andrew Rabinovich. Gradient adversarial training of neural networks. *arXiv preprint arXiv:1806.08028*, 2018.
- Anders Søgaard and Yoav Goldberg. Deep multi-task learning with low level tasks supervised at lower layers. In *Proceedings of the 54th Annual Meeting of the Association for Computational Linguistics (Volume 2: Short Papers)*, pages 231–235, Berlin, Germany, August 2016. Association for Computational Linguistics. doi: 10.18653/v1/P16-2038. URL <https://www.aclweb.org/anthology/P16-2038>.
- Jie Song, Yixin Chen, Xinchao Wang, Chengchao Shen, and Mingli Song. Deep model transferability from attribution maps. In *Advances in Neural Information Processing Systems*, pages 6182–6192, 2019.
- Nitish Srivastava, Geoffrey Hinton, Alex Krizhevsky, Ilya Sutskever, and Ruslan Salakhutdinov. Dropout: A simple way to prevent neural networks from overfitting. *Journal of Machine Learning Research*, 15(56):1929–1958, 2014. URL <http://jmlr.org/papers/v15/srivastava14a.html>.
- Trevor Standley, Amir R Zamir, Dawn Chen, Leonidas Guibas, Jitendra Malik, and Silvio Savarese. Which tasks should be learned together in multi-task learning? *arXiv preprint arXiv:1905.07553*, 2019.
- Gjorgji Strezoski, Nanne van Noord, and Marcel Worring. Many task learning with task routing. In *Proceedings of the IEEE International Conference on Computer Vision*, pages 1375–1384, 2019a.
- Gjorgji Strezoski, Nanne van Noord, and Marcel Worring. Learning task relatedness in multi-task learning for images in context. In *Proceedings of the 2019 on International Conference on Multimedia Retrieval*, pages 78–86, 2019b.

- Sainbayar Sukhbaatar, Jason Weston, Rob Fergus, et al. End-to-end memory networks. In *Advances in neural information processing systems*, pages 2440–2448, 2015.
- Tianxiang Sun, Yunfan Shao, Xiaonan Li, Pengfei Liu, Hang Yan, Xipeng Qiu, and Xuanjing Huang. Learning sparse sharing architectures for multiple tasks. *arXiv preprint arXiv:1911.05034*, 2019a.
- Ximeng Sun, Rameswar Panda, and Rogerio Feris. Adashare: Learning what to share for efficient deep multi-task learning. *arXiv preprint arXiv:1911.12423*, 2019b.
- Ilya Sutskever, Oriol Vinyals, and Quoc V Le. Sequence to sequence learning with neural networks. In *Advances in neural information processing systems*, pages 3104–3112, 2014.
- Yee Teh, Victor Bapst, Wojciech M Czarnecki, John Quan, James Kirkpatrick, Raia Hadsell, Nicolas Heess, and Razvan Pascanu. Distral: Robust multitask reinforcement learning. In *Advances in Neural Information Processing Systems*, pages 4496–4506, 2017.
- Hado P van Hasselt, Arthur Guez, Matteo Hessel, Volodymyr Mnih, and David Silver. Learning values across many orders of magnitude. In *Advances in Neural Information Processing Systems*, pages 4287–4295, 2016.
- Simon Vandenhende, Stamatios Georgoulis, Bert De Brabandere, and Luc Van Gool. Branched multi-task networks: deciding what layers to share. *arXiv preprint arXiv:1904.02920*, 2019.
- Simon Vandenhende, Stamatios Georgoulis, and Luc Van Gool. Mti-net: Multi-scale task interaction networks for multi-task learning. *arXiv preprint arXiv:2001.06902*, 2020.
- Alex Wang, Amanpreet Singh, Julian Michael, Felix Hill, Omer Levy, and Samuel R Bowman. Glue: A multi-task benchmark and analysis platform for natural language understanding. *arXiv preprint arXiv:1804.07461*, 2018.
- Ralph Weischedel, Martha Palmer, Mitchell Marcus, Eduard Hovy, Sameer Pradhan, Lance Ramshaw, Nianwen Zue, Ann Taylor, Jeff Kaufman, Michelle Franchini, Mohammed El-Bachouti, Robert Belvin, and Ann Houston. Ontonotes release 5.0. *Linguistic Data Consortium*, 2013.
- Ronald J. Williams. Simple statistical gradient-following algorithms for connectionist reinforcement learning. *Machine Learning*, 8(3-4):229–256, May 1992. doi: 10.1007/bf00992696. URL <https://doi.org/10.1007/bf00992696>.
- Catherine Wong and Andrea Gesmundo. Transfer learning to learn with multitask neural model search. *arXiv preprint arXiv:1710.10776*, 2017.
- Sen Wu, Hongyang R Zhang, and Christopher Ré. Understanding and improving information transfer in multi-task learning. *arXiv preprint arXiv:2005.00944*, 2020.
- Dan Xu, Wanli Ouyang, Xiaogang Wang, and Nicu Sebe. Pad-net: Multi-tasks guided prediction-and-distillation network for simultaneous depth estimation and scene parsing. In *Proceedings of the IEEE Conference on Computer Vision and Pattern Recognition*, pages 675–684, 2018a.
- Yichong Xu, Xiaodong Liu, Yelong Shen, Jingjing Liu, and Jianfeng Gao. Multi-task learning with sample re-weighting for machine reading comprehension, 2018b.
- Ruihan Yang, Huazhe Xu, Yi Wu, and Xiaolong Wang. Multi-task reinforcement learning with soft modularization. *arXiv preprint arXiv:2003.13661*, 2020.
- Yongxin Yang and Timothy Hospedales. Deep multi-task representation learning: A tensor factorisation approach. *arXiv preprint arXiv:1605.06391*, 2016a.
- Yongxin Yang and Timothy M Hospedales. Trace norm regularised deep multi-task learning. *arXiv preprint arXiv:1606.04038*, 2016b.
- Peter Young, Alice Lai, Micah Hodosh, and Julia Hockenmaier. From image descriptions to visual denotations: New similarity metrics for semantic inference over event descriptions. *Transactions of the Association for Computational Linguistics*, 2:67–78, 2014. doi: 10.1162/tacl_a_00166. URL <https://www.aclweb.org/anthology/Q14-1006>.
- Tianhe Yu, Deirdre Quillen, Zhanpeng He, Ryan Julian, Karol Hausman, Chelsea Finn, and Sergey Levine. Meta-world: A benchmark and evaluation for multi-task and meta reinforcement learning. *arXiv preprint arXiv:1910.10897*, 2019.
- Tianhe Yu, Saurabh Kumar, Abhishek Gupta, Sergey Levine, Karol Hausman, and Chelsea Finn. Gradient surgery for multi-task learning. *arXiv preprint arXiv:2001.06782*, 2020.
- Amir R Zamir, Alexander Sax, William Shen, Leonidas J Guibas, Jitendra Malik, and Silvio Savarese. Taskonomy: Disentangling task transfer learning. In *Proceedings of the IEEE conference on computer vision and pattern recognition*, pages 3712–3722, 2018.
- Andy Zeng, Shuran Song, Stefan Welker, Johnny Lee, Alberto Rodriguez, and Thomas Funkhouser. Learning synergies between pushing and grasping with self-supervised deep reinforcement learning. In *2018 IEEE/RSJ International Conference on Intelligent Robots and Systems (IROS)*, pages 4238–4245. IEEE, 2018.

- Amy Zhang, Shagun Sodhani, Khimya Khetarpal, and Joelle Pineau. Multi-task reinforcement learning as a hidden-parameter block mdp. *arXiv preprint arXiv:2007.07206*, 2020.
- Yu Zhang. Multi-task learning and algorithmic stability. In *Proceedings of the Twenty-Ninth AAAI Conference on Artificial Intelligence*, pages 3181–3187, 2015.
- Yu Zhang and Qiang Yang. A survey on multi-task learning. *arXiv preprint arXiv:1707.08114*, 2017.
- Zhanpeng Zhang, Ping Luo, Chen Change Loy, and Xiaoou Tang. Facial landmark detection by deep multi-task learning. In David Fleet, Tomas Pajdla, Bernt Schiele, and Tinne Tuytelaars, editors, *Computer Vision – ECCV 2014*, pages 94–108, Cham, 2014. Springer International Publishing. ISBN 978-3-319-10599-4.
- Zhenyu Zhang, Zhen Cui, Chunyan Xu, Yan Yan, Nicu Sebe, and Jian Yang. Pattern-affinitive propagation across depth, surface normal and semantic segmentation. In *Proceedings of the IEEE Conference on Computer Vision and Pattern Recognition*, pages 4106–4115, 2019.
- Xiangyun Zhao, Haoxiang Li, Xiaohui Shen, Xiaodan Liang, and Ying Wu. A modulation module for multi-task learning with applications in image retrieval. In Vittorio Ferrari, Martial Hebert, Cristian Sminchisescu, and Yair Weiss, editors, *Computer Vision – ECCV 2018*, pages 415–432, Cham, 2018. Springer International Publishing. ISBN 978-3-030-01246-5.
- Feng Zheng, Cheng Deng, Xing Sun, Xinyang Jiang, Xiaowei Guo, Zongqiao Yu, Feiyue Huang, and Rongrong Ji. Pyramidal person re-identification via multi-loss dynamic training, 2018.
- Fuzhen Zhuang, Zhiyuan Qi, Keyu Duan, Dongbo Xi, Yongchun Zhu, Hengshu Zhu, Hui Xiong, and Qing He. A comprehensive survey on transfer learning. *arXiv preprint arXiv:1911.02685*, 2019.
- Barret Zoph and Quoc V Le. Neural architecture search with reinforcement learning. *arXiv preprint arXiv:1611.01578*, 2016.