

# THE LATTICE OF VARIETIES OF MONOIDS

SERGEY V. GUSEV, EDMOND W. H. LEE, AND BORIS M. VERNIKOV

*In memory of Professor Lev N. Shevrin (1935–2021)*

ABSTRACT. We survey results devoted to the lattice of varieties of monoids. Along with known results, some unpublished results are given with proofs. A number of open questions and problems are also formulated.

## CONTENTS

1. Introduction .....	1
<b>Part 1. The lattice <math>\text{MON}</math> and its sublattices</b> .....	5
2. Initial information .....	5
3. The covering property .....	8
4. Varietal lattices with complex structures .....	12
5. Structure of certain sublattices of $\text{MON}$ .....	16
<b>Part 2. Varieties with restrictions to subvariety lattices</b> .....	20
6. Identities and related conditions .....	20
7. Finiteness conditions .....	28
8. Other restrictions .....	33
<b>Part 3. Distinctive elements in <math>\text{MON}</math></b> .....	38
9. Special elements .....	38
10. Definable varieties and sets of varieties .....	43
References .....	44

## 1. INTRODUCTION

1.1. **General remarks.** A *variety* is a class of algebras of the same type that is closed under the formation of subalgebras, homomorphic images, and arbitrary direct products. By the celebrated Birkhoff’s theorem [5], varieties are precisely classes of algebras satisfying a given set of identities and so can be investigated, in principle, by both semantic and syntactic methods. The theory of varieties is one of the most fruitful branches of modern general algebra. As McKenzie *et al.* [61, p. 244] capaciously said, “in order to guide research and organize knowledge, we group algebras into varieties.” Moreover, according to Hobby and McKenzie [36, p. 12], grouping algebras into varieties “has proved so fruitful that it has no serious competitor.” Varieties of algebras have been systematically examined since the 1950s. Significant contributions to this area were made by many authoritative figures, such as G. Grätzer, B. Jónsson, A. I. Mal’cev, R. N. McKenzie, A. Tarski, and several others.

The family of all varieties of algebras of a given type forms a lattice under set-theoretical inclusion, and the examination of such lattices is one of the main research directions in the theory of varieties. “The study of such lattices reveals an

---

2020 *Mathematics Subject Classification.* Primary 20M07, secondary 08B15.

*Key words and phrases.* Monoid, variety, lattice of varieties.

The first and third authors were supported by the Ministry of Science and Higher Education of the Russian Federation (project FEUZ-2020-0016).

extraordinary rich structure in varieties and helps to organize our knowledge about individual algebras and important families of algebras” [61, p. vii].

The present article is devoted to a survey of work on the lattice  $\text{MON}$  of all varieties of monoids, where monoids are considered as semigroups equipped with an additional 0-ary operation that fixes the identity element. It is astute to compare the investigation of the lattice  $\text{MON}$  with that of the lattice  $\text{SEM}$  of all varieties of semigroups since the latter lattice has been the subject of intensive examination that started as early as the 1960s. Over 200 articles on the lattice  $\text{SEM}$  have so far been published; several survey articles have also been written [2, 15, 86, 97], with Shevrin *et al.* [86] being the most complete and up to date, while Vernikov [97] focused on special elements of  $\text{SEM}$ .

The situation with the study of the lattice  $\text{MON}$  differs sharply from that of  $\text{SEM}$ . The first article concerning the lattice  $\text{MON}$  was published by Head [35] back in the 1960s. For the next 50 years or so, results established in this area were scarce and fragmented: since the pioneering work of Head [35], only two more articles published before 2018—by Pollák [73] and Wismath [102]—were devoted, in whole or to a large extent, to the study of the lattice  $\text{MON}$ . Significant information on this lattice can also be deduced from the work of Vachuska [93] on varieties of monoids with an additional unary operation. Intermediate results related to  $\text{MON}$  can also be found in several articles that were mainly devoted to the study of identities of monoids; see, for example, Jackson [40] and Lee [53, 55, 57]. In practically every case, an explicit description of the subvariety lattice of some variety is exhibited.

Recently, interest in the lattice  $\text{MON}$  has grown significantly. Since 2018, many results that are fully or partially devoted to this lattice have been established [19–32, 42, 43, 58, 103]. In view of the large amount of information on the lattice  $\text{MON}$  accumulated to date, the time seems ripe to survey these results and discuss directions of further research. The present article aims to achieve these goals. To this end, it is natural to rely on the much richer experience in studying the lattice  $\text{SEM}$ . In Shevrin *et al.* [86], three main directions of research of  $\text{SEM}$  were proposed:

- (i) examine properties of the whole lattice  $\text{SEM}$  and the structure of its important sublattices;
- (ii) characterize varieties with given properties of their subvariety lattices;
- (iii) describe varieties that occupy, in a sense, a distinctive position in  $\text{SEM}$ .

In the study of the lattice  $\text{MON}$ , we note that presently, there are both significant advances and numerous open problems in the “monoid versions” of all three aforementioned directions.

Since the amount of information on the structure of the lattice  $\text{MON}$  available to date is still relatively small, we are able to mention all articles known to us that are, partially or fully, within the scope of the survey.

While organizing this survey, we found a number of natural open questions that were not difficult to answer using existing results and techniques. All such results are included in the survey with explicit proofs as a rule or, sometimes, with explanation on how they can be deduced from known results.

The structure of the article is outlined in the table of contents. The article consists of ten sections. Sections 2–10 are grouped into three parts which correspond to the three research directions in (i)–(iii) above.

**1.2. Lattices of pseudovarieties.** A strong motivation for investigating monoid varieties comes from computer science, more specifically from the theory of languages. We briefly outline this important connection and refer the reader to the monographs by Almeida [3] and Rhodes and Steinberg [76] for a comprehensive treatment.

A *language* over an alphabet  $X$  is an arbitrary subset of the free monoid  $F^1$  over  $X$ . To each language  $L \subseteq F^1$  is assigned its *syntactic monoid*  $M_L$  defined as the

quotient of  $F^1$  over the largest congruence  $\rho$  such that  $L$  is a union of  $\rho$ -classes. The syntactic monoid captures several crucial properties of  $L$ ; in particular, a language over a finite alphabet is regular if and only if its syntactic monoid is finite.

The correspondence  $L \mapsto M_L$  is neither injective nor surjective even when its input is restricted to regular languages. It was Eilenberg [14] who realized that this correspondence is bijective if the input and output are raised to the level of certain classes of regular languages and finite monoids, respectively. The classes on the language side, commonly called *varieties of regular languages*, are closed under certain natural language-theoretical operations; the classes on the monoid side are precisely *pseudovarieties*—classes of finite monoids that are closed under the formation of submonoids, homomorphic images, and finitary direct products. For any variety  $\mathbf{V}$  of algebras of any type, the class  $\mathbf{V}_{\text{fin}}$  of all finite members from  $\mathbf{V}$  is a pseudovariety, but not all pseudovarieties arise in this manner. Pseudovarieties that are not of the form  $\mathbf{V}_{\text{fin}}$  include the class of all finite groups and the class of all finite monoids that are *aperiodic* in the sense that all subgroups are trivial.

Both varieties of regular languages and pseudovarieties of finite monoids form complete lattices under inclusion, and Eilenberg's correspondence is an isomorphism between these two lattices. Therefore, results concerning lattices of pseudovarieties can be reinterpreted in terms of regular languages. Conversely, language theory distinguishes certain varieties of regular languages by their combinatorial or logical properties and thus motivates the study of the algebraic counterparts of these distinguished varieties. An important example is the class of star-free languages, whose algebraic counterpart is the pseudovariety of aperiodic monoids; see Schützenberger [82]. This is one of the reasons why the lattice  $\mathbf{APER}$  of varieties of aperiodic monoids is a prominent sublattice of  $\mathbf{MON}$ .

Although the focus of the present survey is only on monoid varieties, many results overviewed will be applicable to monoid pseudovarieties, due to the following result of Aglianó and Nation [1]: if  $\mathbf{P}$  is a pseudovariety of algebras of any type and  $K_{\mathbf{P}}$  is the class of subvariety lattices of varieties generated by monoids in  $\mathbf{P}$ , then the lattice of all subpseudovarieties of  $\mathbf{P}$  is a homomorphic image of a sublattice of an ultraproduct of lattices from  $K_{\mathbf{P}}$ . In particular, any positive universal sentence that holds in the subvariety lattice of a monoid variety  $\mathbf{V}$ , such as any lattice identity, also holds in the subpseudovariety lattice of  $\mathbf{V}_{\text{fin}}$ . Further, if  $\mathbf{V}$  is *locally finite*—that is, every finitely generated monoid in  $\mathbf{V}$  is finite—then the mapping  $\mathbf{X} \mapsto \mathbf{X}_{\text{fin}}$  is an isomorphism between the lattice of subvarieties of  $\mathbf{V}$  and the lattice of subpseudovarieties of  $\mathbf{V}_{\text{fin}}$ ; see Hall and Johnston [33, Theorem 5.3].

Throughout this survey, for many finite monoids  $M$ , the subvariety lattice of the monoid variety  $\text{var } M$  generated by  $M$  will be explicitly described. As a result of the aforementioned isomorphism, each of these subvariety lattices is isomorphic to the subpseudovariety lattice of the monoid pseudovariety generated by  $M$ .

**1.3. Terminology and notation.** We assume that the reader is familiar with rudiments of semigroup theory, lattice theory, and universal algebra. We adopt standard terminology and notation from Clifford and Preston [12] and Howie [37] for semigroups and monoids, Grätzer [18] for lattices, and Burris and Sankappanavar [11] and McKenzie *et al.* [61] for universal algebra.

The monoid obtained by adjoining a new identity element to a semigroup  $S$  is denoted by  $S^1$ . The free semigroup and the free monoid over a countably infinite alphabet  $X$  are denoted by  $F$  and  $F^1$ , respectively. As usual, elements of  $X$  and  $F^1$  are called *letters* and *words*, respectively; the empty word is the identity element of  $F^1$ . Words, unlike letters, are written in bold. The two words forming an identity are connected by the symbol  $\approx$ , while the symbol  $=$  denotes, among other things, the equality relation on the free semigroup or monoid.

Let  $\mathbf{T}$  denote the trivial variety of algebras of any type. We use the standard symbol  $\mathbb{N}$  for the set of all natural numbers. For any  $n \in \mathbb{N}$ , let  $\mathbf{A}_n$  denote the variety of Abelian groups of exponent dividing  $n$ ; in particular,  $\mathbf{A}_1 = \mathbf{T}$ . We will often put *sem* in the subscript to distinguish between a particular semigroup object and its monoid namesake. For instance, the variety of all commutative [respectively, semilattice] monoids is denoted by  $\mathbf{COM}$  [respectively,  $\mathbf{SL}$ ], the corresponding semigroup variety is denoted by  $\mathbf{COM}_{\text{sem}}$  [respectively,  $\mathbf{SL}_{\text{sem}}$ ]. The variety of all monoids [respectively, semigroups] is denoted by  $\mathbf{MON}$  [respectively,  $\mathbf{SEM}$ ]. A variety of monoids [respectively, semigroups] is *proper* if it is different from  $\mathbf{MON}$  [respectively,  $\mathbf{SEM}$ ]. The variety of monoids [respectively, semigroups] defined by an identity system  $\Sigma$  is denoted by  $\text{var } \Sigma$  [respectively,  $\text{var}_{\text{sem}} \Sigma$ ]. The variety of monoids generated by a monoid  $M$  is denoted by  $\text{var } M$ .

A semigroup or monoid is *completely regular* if it is a union of groups. A variety of semigroups or monoids is *commutative* [respectively, *periodic*, *completely regular*] if it consists of commutative [respectively, periodic, completely regular] semigroups or monoids; a variety of semigroups [respectively, monoids] is *overcommutative* if it contains the variety  $\mathbf{COM}_{\text{sem}}$  [respectively,  $\mathbf{COM}$ ]. In accordance with the above convention, the lattice of all periodic [respectively, commutative, overcommutative, completely regular] varieties of monoids is denoted by  $\mathbf{PER}$  [respectively,  $\mathbf{COM}$ ,  $\mathbf{OC}$ ,  $\mathbf{CR}$ ], while the eponymous varietal lattice in the semigroup case is denoted by  $\mathbf{PER}_{\text{sem}}$  [respectively,  $\mathbf{COM}_{\text{sem}}$ ,  $\mathbf{OC}_{\text{sem}}$ ,  $\mathbf{CR}_{\text{sem}}$ ].

For a possibly empty set  $W$  of words, let  $I(W)$  denote the set of all words that are not subwords of any word from  $W$ . It is clear that  $I(W)$  is an ideal of  $F^1$ . Let  $S(W)$  denote the Rees quotient monoid  $F^1/I(W)$ . Since every Rees quotient monoid  $S(W)$  in the present article involves a singleton set  $W = \{\mathbf{w}\}$ , it is more convenient to write  $S(\mathbf{w})$  instead of  $S(\{\mathbf{w}\})$ . Monoids of the form  $S(W)$  appeared in the literature as early as the 1940s; their construction was attributed by Morse and Hedlund [62] to R. P. Dilworth. One of the earliest discovered examples of non-finitely based finite semigroups, due to Perkins [67] in the 1960s, is the monoid  $S(\{xyzyx, xzyxy, xyxy, x^2z\})$ . Since the beginning of the millennium, such monoids were consistently and systematically used in the articles of M. Jackson, O. B. Sapir, and other authors; see Jackson and Lee [42, Remark 2.4] for more references.

For a variety  $\mathbf{X}$  of algebras, we denote its subvariety lattice by  $L(\mathbf{X})$ . If  $\mathbf{X}$  is a variety of monoids or semigroups, then we denote by  $\overline{\mathbf{X}}$  the variety *dual to*  $\mathbf{X}$ , that is, the variety consisting of anti-isomorphic images of algebras from  $\mathbf{X}$ .

**1.4. Why do  $\mathbf{MON}$  and  $\mathbf{SEM}$  satisfy different properties?** Since semigroups and monoids are closely related types of algebras, it seems plausible that the varieties they generate should have subvariety lattices that satisfy more or less similar properties. However, this is very far from the case. Significant differences between the lattices  $\mathbf{SEM}$  and  $\mathbf{MON}$  can already be found in some early works, such as Head [35] and Pollák [73]; see Subsections 5.1 and 3.1, respectively. Throughout the article, we will often highlight differences in properties of these two lattices. In some cases, the lattices  $\mathbf{SEM}$  and  $\mathbf{MON}$  satisfy similar properties, but such instances are rare. In this subsection, we briefly discuss what causes the mentioned differences.

When we deal with identities of monoids, we can “eliminate” all occurrences of a letter by substituting 1 for it. This fundamentally affects the deducibility of identities and essentially changes the structure of varietal lattices. We give a simple but striking example:

$$\mathbf{K} = \text{var}_{\text{sem}}\{x^2 \approx yzy\}.$$

The lattice  $L(\mathbf{K})$  is extremely complex because it contains an isomorphic copy of every finite lattice [99, Lemma 3]. But the monoid variety  $\text{var}\{x^2 \approx yzy\}$  is trivial because every monoid in it satisfies the identity  $1 \approx z$ . A deeper reason leading to

significant differences between the lattices **MON** and **SEM** will be elaborated at the end of Subsection 2.3.

## Part 1. The lattice **MON** and its sublattices

### 2. INITIAL INFORMATION

**2.1. Embedding of **MON** in **SEM**.** The following easily verifiable result plays a fundamental role in the study of the lattice **MON**. It was explicitly noted, for example, in Almeida [3, Section 7.1] and Jackson and Lee [42, Subsection 1.1].

**Proposition 2.1.** *The mapping from **MON** into **SEM** that sends a monoid variety generated by a monoid  $M$  to the semigroup variety generated by the semigroup reduct of  $M$  is an embedding of the lattice **MON** into the lattice **SEM**.*

Proposition 2.1 allows us to transfer various results on **SEM** to results on **MON**. Concrete examples of how Proposition 2.1 enables us to obtain new information about the lattice **MON** will appear repeatedly below.

**2.2. Some basic properties of **MON**.** Before proceeding to the discussion of specific properties of the lattice **MON**, we note that this lattice possesses all textbook properties of subvariety lattices of varieties of algebras: it is complete, atomic, and coalgebraic, and its cocompact elements are precisely all finitely based monoid varieties. Several more specific properties that hold in subvariety lattices of all varieties of algebras are listed in Lampe [51].

A description of the atoms of the lattice **SEM** was found back in the 1950s [47]; the following result is thus deducible from Proposition 2.1.

**Observation 2.2.** *The varieties  $\mathbf{A}_p$ , where  $p$  ranges over the primes, and **SL** are the only atoms of the lattice **MON**.*

The variety **SEM** is join-irreducible in the lattice **SEM** and this lattice does not have coatoms; see Evans [15, Section X]. These properties also hold for monoid varieties.

### Observation 2.3.

- a) *The variety **MON** is join-irreducible in the lattice **MON**.*
- b) *The lattice **MON** does not have coatoms.*

*Proof.* a) This follows from Proposition 2.1 and the aforementioned fact that the variety **SEM** is join-irreducible in **SEM**.

b) Consider any proper monoid variety  $\mathbf{V} = \text{var}\{\mathbf{u}_i \approx \mathbf{v}_i \mid i \in I\}$ . Let  $\xi$  denote the substitution that maps every letter  $x$  to  $x^2$ . Then  $\mathbf{V}^* = \text{var}\{\xi(\mathbf{u}_i) \approx \xi(\mathbf{v}_i) \mid i \in I\}$  is a variety such that  $\mathbf{V} \subset \mathbf{V}^* \subset \mathbf{MON}$ , so that  $\mathbf{V}$  is not a coatom of **MON**.  $\square$

Recall that a lattice  $\langle L; \vee, \wedge \rangle$  with a least element 0 is *0-distributive* if it satisfies the following implication:

$$\forall x, y, z \in L : \quad x \wedge z = y \wedge z = 0 \longrightarrow (x \vee y) \wedge z = 0.$$

Lattices of varieties of classical types of algebras such as groups, rings, semigroups, and lattices are well known to be 0-distributive. For semigroup varieties, this is a folklore result; see, for example, Shevrin *et al.* [86, Section 1]. Varieties of monoids are of no exception to this trend.

**Observation 2.4.** *The lattice **MON** is 0-distributive.*

To prove this result, it suffices to check that whenever an atom of **MON** is not contained in two monoid varieties, then it is not contained in their join. This easily follows from Proposition 2.1 and the fact that the lattice **SEM** is 0-distributive.

It is evident that the map  $\delta$  [respectively,  $\delta_{\text{sem}}$ ] that sends every variety  $\mathbf{V}$  to its dual  $\overline{\mathbf{V}}$  is an automorphism of the lattice  $\text{MON}$  [respectively,  $\text{SEM}$ ]. It is known that there exist infinitely many non-trivial injective endomorphisms of the lattice  $\text{SEM}$  different from  $\delta_{\text{sem}}$  (see Shevrin *et al.* [86, Section 1]), but the question of whether there exists a non-trivial automorphism of  $\text{SEM}$  different from  $\delta_{\text{sem}}$  remains open so far. The following question is still open too.

**Question 2.5.** Does a non-trivial automorphism [injective endomorphism] of  $\text{MON}$  different from  $\delta$  exist?

**2.3. Basic sublattices of  $\text{MON}$ .** The lattice  $\text{MON}$  has several interesting and important sublattices. First,  $\text{MON}$  is a disjoint union of two big sublattices: the ideal  $\text{PER}$  of all periodic varieties and the coideal  $\text{OC}$  of all overcommutative varieties. The class of all completely regular monoid varieties forms a sublattice  $\text{CR}$  in  $\text{PER}$ . In turn, the lattice  $\text{CR}$  contains the sublattice  $\text{GR}$  of all periodic group varieties. The “antipode” of  $\text{GR}$  and one more sublattice in  $\text{PER}$  is the lattice  $\text{APER}$  of all aperiodic varieties that was first introduced in Subsection 1.2. The intersection of the lattices  $\text{CR}$  and  $\text{APER}$  coincides with the lattice  $\text{BAND}$  of all varieties of band monoids, where  $\text{BAND} = \text{var}\{x \approx x^2\}$  is the largest element. To conclude the list of the main sublattices of the lattice  $\text{MON}$ , we mention the lattice  $\text{COM}$  of all commutative varieties of monoids. The sublattices of the lattice  $\text{MON}$  mentioned above and their relative location within  $\text{MON}$  are shown in Fig. 1.

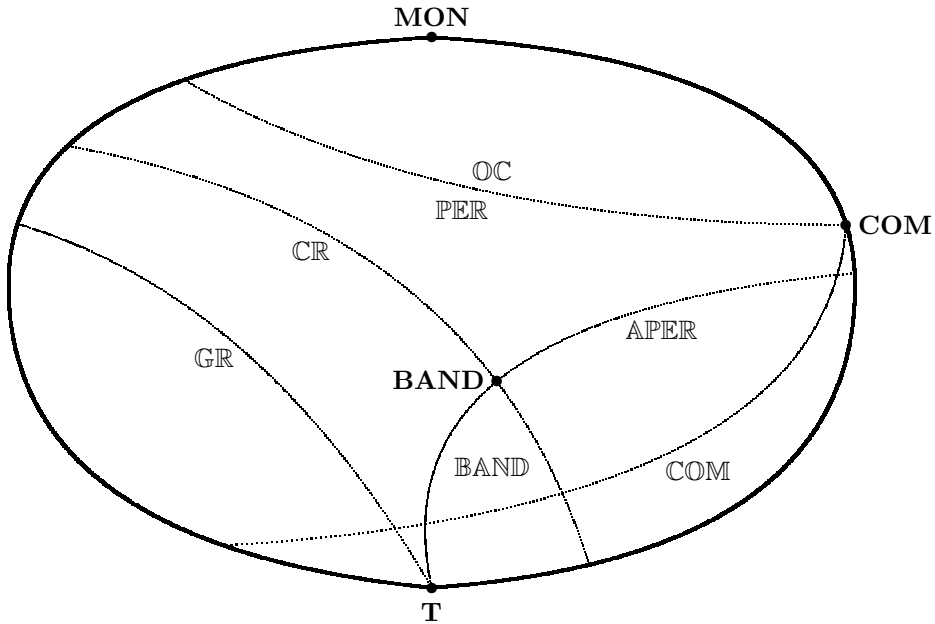

FIGURE 1. The “map” of the lattice  $\text{MON}$

The lattices  $\text{COM}$ ,  $\text{CR}$ , and  $\text{BAND}$  were examined by Head [35], Vachuska [93], and Wismath [102], respectively. We discuss results of these articles in greater detail in Section 5.

The lattice  $\text{OC}$  has not been systematically examined but some of its properties follow from known results. For instance, the lattice  $\text{OC}_{\text{sem}}$  is residually finite [100, Corollary 2.3]; the following result is thus deducible from Proposition 2.1.

**Proposition 2.6.** *The lattice  $\text{OC}$  is residually finite.*

Further properties of  $\text{OC}$  will be established in the next two sections; see Corollary 3.4, Remark 4.12, and Corollary 4.14.

The lattice **MON** does not contain analogues of two important sublattices of **SEM**: the lattice  $\mathbf{NIL}_{\text{sem}}$  of nil-varieties of semigroups and the lattice  $\mathbf{PERM}_{\text{sem}}$  of all *permutative* varieties, that is, varieties satisfying an identity of the form

$$x_1 x_2 \cdots x_n \approx x_{\pi(1)} x_{\pi(2)} \cdots x_{\pi(n)},$$

where  $\pi$  is a non-trivial permutation of the set  $\{1, 2, \dots, n\}$ . The semigroup variety **K** given on page 4 is an example of a nil-variety, while every variety of commutative semigroups is permutative.

The lattice  $\mathbf{NIL}_{\text{sem}}$  has a very complex structure; see Shevrin *et al.* [86, Section 7]; in particular, it does not satisfy any non-trivial identity [45, 49]. However, since every nil-monoid is obviously singleton, the lattice **MON** does not contain non-trivial nil-varieties.

The lattice  $\mathbf{PERM}_{\text{sem}}$  also does not satisfy any non-trivial identity [10]. It is obvious, however, that every permutative monoid is commutative. Thus, in the monoid case, the lattice of permutative varieties “collapses” to the lattice **COM**, whose structure turns out to be very simple; see Theorem 5.1.

At first glance, it seems that the absence of non-trivial nil-varieties and non-commutative permutative varieties from the lattice **MON** should greatly simplify the study of this lattice. This is true up to a certain extent, for example, the lattice **COM** has a much simpler structure than the lattice  $\mathbf{COM}_{\text{sem}}$ . But the opposite turns out to be more prevalent. In general, the study of the lattice **MON** tends to be more complex due to the absence of the two aforementioned types of varieties. The solutions of many problems related to the lattice **SEM** began with the construction of counterexamples that allowed one to find strong necessary conditions, and thereby greatly narrow the field for further investigation. These counterexamples are often constructed from permutative or nil-varieties. With fewer opportunities to construct analogous counterexamples in the case of monoids, the investigation of many problems related to monoid varieties is severely hindered. This is the case, for example, in the study of varieties of monoids with a modular or distributive subvariety lattice; see Subsections 6.2 and 6.3.

**2.4. Minimal forbidden subvarieties for certain classes of varieties.** All sublattices of the lattice **MON** introduced in Subsection 2.3 can be considered as (non-ordered) classes of varieties. All these classes, with the exception of **OC**, can be characterized by minimal “forbidden subvarieties”. Corresponding results are summarized in Table 1. We use here and below the following notation:

$$\begin{aligned} \mathbf{C}_n &= \text{var}\{x^n \approx x^{n+1}\}, \\ \mathbf{D}_1 &= \text{var}\{x^2 \approx x^3, x^2 y \approx xyx \approx yx^2\}, \\ \mathbf{LRB} &= \text{var}\{xyx \approx xy\}, \\ \text{and } \mathbf{RRB} &= \text{var}\{xyx \approx yx\}. \end{aligned}$$

Note that  $\mathbf{C}_1 = \mathbf{SL}$  and  $\mathbf{C}_{n+1} = \text{var } S(x^n)$  for any  $n \in \mathbb{N}$ ; this readily follows from Almeida [3, Corollary 6.1.5]. The variety  $\mathbf{D}_1$  belongs to a countably infinite series of varieties  $\mathbf{D}_k$  which will be defined in Subsection 6.1.

The result in line 1 of Table 1 is generally known, while the result in line 2 holds because the varieties  $\mathbf{A}_p$  with prime  $p$  are the only atoms of the lattice of group varieties. The results in lines 3 and 4 are well known; see Gusev and Vernikov [31, Lemma 2.1 and Corollary 2.6]. The result in line 5 immediately follows from the results in lines 2 and 4.

Finally, the result in line 6 is new and due to Gusev. One can discuss it in greater detail. Since every commutative monoid variety is finitely based [35], it follows from Zorn’s lemma that every non-commutative monoid variety contains a minimal non-commutative subvariety. To classify all minimal non-commutative monoid varieties, we need to describe, in particular, all minimal non-Abelian varieties of periodic

TABLE 1. A characterization of certain classes of monoid varieties

	A variety $\mathbf{V}$ of monoids lies in	if and only if $\mathbf{V}$ does not contain
1	PER	COM
2	APER	$\mathbf{A}_p$ for all prime $p$
3	GR	SL
4	CR	$\mathbf{C}_2$
5	BAND	$\mathbf{A}_p$ for all prime $p$ and $\mathbf{C}_2$
6	COM	$\mathbf{D}_1$ , <b>LRB</b> , <b>RRB</b> , and all minimal non-Abelian group varieties

groups. This problem is extremely difficult in view of the following result. Recall that a variety of algebras is *locally finite* if every finitely generated member is finite.

**Theorem 2.7** (Kozhevnikov [50, Theorem 5 and its proof]). *For every sufficiently large prime  $p$ , there exist uncountably many periodic, non-locally finite (in particular, non-Abelian), non-finitely based group varieties whose proper subvarieties are all contained in  $\mathbf{A}_p$ .*

Therefore, it is natural to consider only the non-group case.

**Theorem 2.8.** *The varieties  $\mathbf{D}_1$ , **LRB**, and **RRB** are the only non-group minimal non-commutative varieties of monoids.*

In comparison, there are precisely five non-group minimal non-commutative varieties of semigroups [7].

To prove Theorem 2.8, we need the following result.

**Lemma 2.9** (Gusev and Vernikov [31, Lemma 2.14]). *Any monoid variety that is neither completely regular nor commutative contains  $\mathbf{D}_1$ .*

*Proof of Theorem 2.8.* Let  $\mathbf{V}$  be any non-group minimal non-commutative monoid variety. By Lemma 2.9, we may assume that  $\mathbf{V}$  is completely regular. Let  $\mathbf{V}_{\text{sem}}$  denote the semigroup variety generated by the semigroup reduct of a monoid that generates  $\mathbf{V}$ . Then the variety  $\mathbf{V}_{\text{sem}}$  is non-commutative and completely regular. Therefore, there exists a minimal non-commutative completely regular subvariety  $\mathbf{X}$  of  $\mathbf{V}_{\text{sem}}$ . If  $\mathbf{X}$  is a group variety, then  $\mathbf{V}$  contains a non-Abelian group that generates  $\mathbf{X}$ ; but this is impossible because  $\mathbf{V}$  is a non-group minimal non-commutative monoid variety. Thus,  $\mathbf{X}$  is a non-group variety. In view of Biryukov [7, Theorem 2], there exist only two non-group completely regular minimal non-commutative semigroup varieties:  $\mathbf{LZ} = \text{var}_{\text{sem}}\{xy \approx x\}$  and  $\mathbf{RZ} = \text{var}_{\text{sem}}\{xy \approx y\}$ . Suppose that  $\mathbf{X} = \mathbf{LZ}$ . The variety  $\mathbf{LZ}$  is generated by the 2-element left zero semigroup  $L_2$ . Since  $\mathbf{V}_{\text{sem}}$  contains the semigroup  $L_2$  and is generated by a monoid,  $L_2^1 \in \mathbf{V}_{\text{sem}}$  by Jackson [41, Lemma 1.1]. It is well known that  $\text{var } L_2^1 = \mathbf{LRB}$ , so that  $\mathbf{LRB} \subseteq \mathbf{V}$  by Proposition 2.1. Since  $\mathbf{V}$  is a minimal non-commutative monoid variety, we have  $\mathbf{V} = \mathbf{LRB}$ . By symmetry, if  $\mathbf{X} = \mathbf{RZ}$ , then  $\mathbf{V} = \mathbf{RRB}$ .  $\square$

### 3. THE COVERING PROPERTY

Let  $S$  be a partially ordered set and  $x, y \in S$ . Then  $y$  is a *cover* of  $x$  if  $x < y$  and there are no elements  $z \in S$  such that  $x < z < y$ . If every non-maximal element of  $S$  has a cover, then  $S$  has the *covering property*. As Shevrin *et al.* [86, Section 3] accurately narrated:

The study of the cover relation in varietal lattices attracted considerable attention on the early stage of development of the theory of varieties. Evidently, there were anticipations that the structure



of lattices of varieties can be revealed by moving “upward”: from the trivial variety to its covers, that is, atoms, from the atoms to their covers, etc. Although this hope with respect to “big” varietal lattices such as  $\mathbf{SEM}$  has turned out to be somewhat naive, investigations of the cover relation in  $\mathbf{SEM}$  and related varietal lattices have brought a number of interesting results.

The above also closely describes the situation with the lattice  $\mathbf{MON}$ .

**3.1. The existence of covers.** General properties of coalgebraic lattices imply that every proper variety of semigroups [respectively, monoids] defined by finitely many identities has a cover in  $\mathbf{SEM}$  [respectively,  $\mathbf{MON}$ ]. However, there exist varieties of semigroups and monoids that cannot be defined by finitely many identities. Trakhtman [90, Theorem 1] proved that the subvariety lattice of any overcommutative semigroup variety has the covering property. It follows that the lattice  $\mathbf{SEM}$  has this property because  $\mathbf{SEM}$  is nothing but the subvariety lattice of the overcommutative variety  $\mathbf{SEM}$ . Further details concerning the covering property in  $\mathbf{SEM}$  can be found in Shevrin *et al.* [86, Section 3] or Volkov [101, Section 3].

The analog of the aforementioned result of Trakhtman [90] for the lattice  $\mathbf{MON}$  does not hold. To give some corresponding examples, we need some notation. Let

$$\mathbf{M}_1 = \text{var}\{y^2x_1^2x_2^2 \cdots x_k^2y \approx yx_1^2x_2^2 \cdots x_k^2y^2 \mid k \in \mathbb{N}\}$$

and for each  $k \in \mathbb{N}$ , let  $\mathbf{N}_k = \text{var}\{\mathbf{p}_k \approx \mathbf{q}_k\}$ , where

$$\begin{aligned} \mathbf{p}_k &= yxt_1t_2 \cdots t_kzyt_kt_{k-1} \cdots t_1xz \\ \text{and } \mathbf{q}_k &= yxt_1t_2 \cdots t_kzxyt_kt_{k-1} \cdots t_1xz. \end{aligned}$$

Define

$$\mathbf{N} = \bigwedge_{k \in \mathbb{N}} \mathbf{N}_k = \text{var}\{\mathbf{p}_k \approx \mathbf{q}_k \mid k \in \mathbb{N}\}.$$

**Theorem 3.1.** *The varieties  $\mathbf{M}_1$  and  $\mathbf{N}$  have no covers in  $\mathbf{MON}$ . Therefore, the lattice  $\mathbf{MON}$  does not have the covering property.*

The variety  $\mathbf{M}_1$ , due to Pollák [73, Theorem 1], is the first published example of an overcommutative variety with no covers in  $\mathbf{MON}$ ; other overcommutative examples can also be deduced from more recent results, such as Jackson [39, Proposition 4.1] and O.B. Sapir [79, proof of Lemma 5.1]. In contrast, the variety  $\mathbf{N}$  is aperiodic; it is a new example that is due to Gusev. The following intermediate result is required to show that  $\mathbf{N}$  has no covers in  $\mathbf{MON}$ .

**Lemma 3.2.** *Let  $n, k \in \mathbb{N}$ . Suppose that the variety  $\mathbf{N}_k$  satisfies a non-trivial identity  $\mathbf{u} \approx \mathbf{v}$ . If  $\mathbf{u}$  coincides with one of the words  $\mathbf{p}_n$  or  $\mathbf{q}_n$ , then  $\mathbf{v}$  coincides with the other word and  $k \geq n$ .*

*Proof.* The *content* of a word  $\mathbf{w}$ , denoted by  $\text{con}(\mathbf{w})$ , is the set of letters occurring in  $\mathbf{w}$ . The *head* of a word  $\mathbf{w}$ , denoted by  $h(\mathbf{w})$ , is the first letter of  $\mathbf{w}$ . A letter is *multiple* in a word  $\mathbf{w}$  if it occurs at least twice in  $\mathbf{w}$ . Let  $\lambda$  denote the empty word.

By assumption, there is a deduction of the identity  $\mathbf{u} \approx \mathbf{v}$  from the identity  $\mathbf{p}_k \approx \mathbf{q}_k$ , that is, a sequence  $\mathbf{u} = \mathbf{w}_0, \mathbf{w}_1, \dots, \mathbf{w}_m = \mathbf{v}$  of words, where for each  $i = 0, 1, \dots, m-1$ , there exist words  $\mathbf{a}_i, \mathbf{b}_i \in F^1$  and an endomorphism  $\xi_i$  on  $F^1$  such that  $\{\mathbf{w}_i, \mathbf{w}_{i+1}\} = \{\mathbf{a}_i\xi_i(\mathbf{p}_k)\mathbf{b}_i, \mathbf{a}_i\xi_i(\mathbf{q}_k)\mathbf{b}_i\}$ . By induction on  $m$ , it suffices to consider the case when  $\mathbf{u} = \mathbf{a}\xi(\mathbf{s})\mathbf{b}$  and  $\mathbf{v} = \mathbf{a}\xi(\mathbf{t})\mathbf{b}$  for some  $\mathbf{a}, \mathbf{b} \in F^1$ , endomorphism  $\xi$  on  $F^1$ , and words  $\{\mathbf{s}, \mathbf{t}\} = \{\mathbf{p}_k, \mathbf{q}_k\}$ . Since any subword of  $\mathbf{u}$  of length greater than 1 occurs only once in  $\mathbf{u}$  and all letters occurring in  $\mathbf{s}$  are multiple, the following result holds.

**Observation 3.3.** *For any letter  $a \in \text{con}(\mathbf{s})$ , the word  $\xi(a)$  is either empty or a letter.*

If  $\xi(x) = \lambda$ , then  $\xi(\mathbf{s}) = \xi(\mathbf{t})$ , whence  $\mathbf{u} = \mathbf{v}$ ; but this contradicts the assumption that the identity  $\mathbf{u} \approx \mathbf{v}$  is non-trivial. Thus,  $\xi(x) \neq \lambda$ . Observation 3.3 now implies that  $\xi(x)$  is a letter. We use this fact below without further reference.

We are going to verify that  $\mathbf{a} = \lambda$ . Arguing by contradiction, suppose that  $\mathbf{a} \neq \lambda$ . The letter  $y$  occurs in each of the words  $\mathbf{u}$  and  $\mathbf{v}$  exactly twice. Since  $\mathbf{a} \neq \lambda$  and  $y = h(\mathbf{u}) = h(\mathbf{a}\xi(\mathbf{s})\mathbf{b})$ , we have  $y \in \text{con}(\mathbf{a})$ , whence  $y$  appears in  $\xi(\mathbf{s})\mathbf{b}$  at most once. Then  $y \notin \text{con}(\xi(\mathbf{s}))$  because every letter in  $\xi(\mathbf{s})$  is multiple. Hence, either  $y$  is multiple in  $\mathbf{a}$  or  $y \in \text{con}(\mathbf{b})$ . Suppose that  $y$  is multiple in  $\mathbf{a}$ . Then the word  $\xi(\mathbf{s})\mathbf{b}$  is a suffix of the word  $t_n t_{n-1} \cdots t_1 x z$ ; in particular,  $\xi(\mathbf{s})$  is a subword of the word  $t_n t_{n-1} \cdots t_1 x z$ . But this is impossible because the latter word does not contain multiple letters and every letter from  $\mathbf{s}$  is multiple. Thus, the case when  $y$  is multiple in  $\mathbf{a}$  is impossible, whence  $y \in \text{con}(\mathbf{b})$ . It follows that the word  $y t_1 t_2 \cdots t_n x z$  is a suffix of  $\mathbf{b}$ . Therefore, since all letters in the word  $\xi(\mathbf{s})$  are multiple, we have  $y, z, t_1, t_2, \dots, t_n \notin \text{con}(\xi(\mathbf{s}))$ . It follows that  $\xi(\mathbf{s}) = \lambda$ , a contradiction.

Hence,  $\mathbf{a} = \lambda$ . Analogous arguments imply that  $\mathbf{b} = \lambda$ . We see that  $\mathbf{u} = \xi(\mathbf{s})$  and  $\mathbf{v} = \xi(\mathbf{t})$ . In particular, these equalities and Observation 3.3 imply that  $k \geq n$ .

As observed above, the word  $\xi(x)$  is a letter. Suppose that  $\xi(y) = \lambda$ . Then  $h(\xi(\mathbf{s})) = \xi(x)$ . Since  $\xi(\mathbf{s}) = \mathbf{u}$  and  $h(\mathbf{u}) = y$ , we obtain  $\xi(x) = y$ . The equality  $\xi(\mathbf{s}) = \mathbf{u}$  implies that the word  $y t_n t_{n-1} \cdots t_1 x z$  is a suffix of  $\xi(\mathbf{s})$ . On the other hand, the word  $\xi(\mathbf{s})$  has a suffix  $\xi(x)\xi(z) = y\xi(z)$ . This implies that  $\xi(z) = t_n t_{n-1} \cdots t_1 x z$ , which contradicts Observation 3.3. Therefore,  $\xi(y) \neq \lambda$ . Now Observation 3.3 again applies the conclusion that  $\xi(y)$  is a letter. Since  $y = h(\mathbf{s})$ , we have  $\xi(y) = h(\xi(\mathbf{s}))$ . But  $\xi(\mathbf{s}) = \mathbf{u}$  and  $h(\mathbf{u}) = y$ . Thus,  $\xi(y) = y$ . Analogous arguments imply that  $\xi(z) = z$ .

Further, the word  $\mathbf{s}$  has the prefix  $yx$ . Therefore, the word  $\xi(\mathbf{s})$  has the prefix  $\xi(y)\xi(x) = y\xi(x)$ . On the other hand, the word  $\mathbf{u} = \xi(\mathbf{s})$  has the prefix  $yx$ . Since  $\xi(x)$  is a letter, we have  $\xi(x) = x$ . Then  $\xi(t_1 t_2 \cdots t_k) = t_1 t_2 \cdots t_n$  and  $\xi(t_k t_{k-1} \cdots t_1) = t_n t_{n-1} \cdots t_1$ .

The number of occurrences of the letter  $x$  in the word  $\xi(\mathbf{p}_k)$  [respectively,  $\xi(\mathbf{q}_k)$ ] is a multiple of two [respectively, three]. However, the letter  $x$  occurs in the word  $\mathbf{p}_n$  [respectively,  $\mathbf{q}_n$ ] exactly two [respectively, three] times. Therefore, if  $\mathbf{u} = \mathbf{p}_n$ , then  $\mathbf{s} = \mathbf{p}_k$ . This fact and the arguments in the previous paragraph imply that  $\mathbf{v} = \mathbf{q}_n$ . Finally, if  $\mathbf{u} = \mathbf{q}_n$ , then  $\mathbf{s} = \mathbf{q}_k$ , whence  $\mathbf{v} = \mathbf{p}_n$ .  $\square$

*Proof of Theorem 3.1.* Since  $\mathbf{M}_1$  has no covers in  $\text{MON}$  [73, Theorem 1], it suffices to consider  $\mathbf{N}$ . By the lemma in Pollák [73], it suffices to verify that the following statements hold for any  $n \in \mathbb{N}$ :

- (i) the identity  $\mathbf{p}_n \approx \mathbf{q}_n$  follows from the identity  $\mathbf{p}_{n+1} \approx \mathbf{q}_{n+1}$ ;
- (ii) if the variety  $\mathbf{N}$  satisfies the identity  $\mathbf{p}_{n+1} \approx \mathbf{u}$  and the identity  $\mathbf{u} \approx \mathbf{v}$  follows from the identity  $\mathbf{p}_n \approx \mathbf{q}_n$ , then  $\mathbf{u} = \mathbf{v}$ .

To verify claim (i), it suffices to note that if we substitute 1 for  $t_{n+1}$  in the identity  $\mathbf{p}_{n+1} \approx \mathbf{q}_{n+1}$ , then we obtain the identity  $\mathbf{p}_n \approx \mathbf{q}_n$ . Claim (ii) follows from Lemma 3.2.  $\square$

Since the variety  $\mathbf{M}_1$  is overcommutative and the variety  $\mathbf{N}$  is aperiodic and so also periodic, the following result holds.

**Corollary 3.4.** *The lattices PER, APER, and OC do not have the covering property.*

On the other hand, the lattices COM, BAND, CR, and GR have the covering property. Specifically, the covering property for the lattices COM and BAND follows from Head [35] and Wismath [102], respectively (see Theorems 5.1 and 5.2); as for the lattices CR and GR, it suffices to refer to the proof of Proposition 3.5 in Subsection 8.1.

**3.2. The number of covers.** It is fundamental to question how many covers a variety can have, if it has any at all. There exist monoid varieties with infinitely many covers, with the trivial variety  $\mathbf{T}$  being a mundane example; see Observation 2.2. The following result, the proof of which is deferred to Subsection 8.1, provides some non-trivial examples.

**Proposition 3.5.** *Every completely regular monoid variety has infinitely many covers in the lattice  $\mathbf{MON}$ .*

Non-completely regular varieties with infinitely many covers also exist. For instance, for any  $n \in \mathbb{N}$  and prime  $p$ , the variety  $\mathbf{C}_n \vee \mathbf{A}_p$  covers  $\mathbf{C}_n$ ; this follows from the description of the lattice  $\mathbf{COM}$  [35] (see Theorem 5.1).

It follows from Theorem 2.7 that for all sufficiently large prime  $p$ , the group variety  $\mathbf{A}_p$  has uncountably many covers in  $\mathbf{GR}$ .

**Question 3.6.** Is there a non-completely regular variety of monoids with uncountably many covers in  $\mathbf{MON}$ ? More specifically, is there an aperiodic variety of monoids with uncountably many covers in  $\mathbf{APER}$ ?

This question is presently open but has been affirmatively answered within the context of semigroup varieties. Indeed, Trakhtman exhibited a semigroup variety with uncountably many covers in  $\mathbf{SEM}$ ; these varieties are all aperiodic and non-completely regular [90, Theorem 2].

We now consider varieties with very few covers. There exist monoid varieties with a finite number of covers and moreover, with a unique cover. This follows from the following universal-algebraic result.

**Proposition 3.7.** *Let  $\mathbf{X}$  be any variety of algebras and  $\mathbf{V}$  be any proper subvariety of  $\mathbf{X}$  defined within  $\mathbf{X}$  by a single identity  $\mathbf{u} \approx \mathbf{v}$  with the following property: if  $\mathbf{V}$  satisfies an identity of the form  $\mathbf{u} \approx \mathbf{w}$ , then  $\mathbf{w} \in \{\mathbf{u}, \mathbf{v}\}$ . Then  $\mathbf{V}$  has a unique cover  $\mathbf{U}$  in the lattice  $L(\mathbf{X})$  and  $\mathbf{U}$  is the meet of all subvarieties of  $\mathbf{X}$  that properly contain  $\mathbf{V}$ .*

*Proof.* The variety  $\mathbf{V}$  is finitely based within  $\mathbf{X}$ . As it is generally known, this implies that  $\mathbf{V}$  has at least one cover in the lattice  $L(\mathbf{X})$ . Let  $\mathbf{U}$  be a cover of  $\mathbf{V}$  in  $L(\mathbf{X})$  and  $\mathbf{W}$  be a variety such that  $\mathbf{V} \subset \mathbf{W} \subseteq \mathbf{X}$ . Then it is clear that either  $\mathbf{U} \subseteq \mathbf{W}$  or  $\mathbf{U} \wedge \mathbf{W} = \mathbf{V}$ . Suppose that  $\mathbf{U} \wedge \mathbf{W} = \mathbf{V}$ . Then there is a deduction of the identity  $\mathbf{u} \approx \mathbf{v}$  from the identities of the varieties  $\mathbf{U}$  and  $\mathbf{W}$ , that is, a sequence  $\mathbf{u} = \mathbf{w}_0, \mathbf{w}_1, \dots, \mathbf{w}_n = \mathbf{v}$  of words such that for each  $i = 0, 1, \dots, n-1$ , the identity  $\mathbf{w}_i \approx \mathbf{w}_{i+1}$  holds in either  $\mathbf{U}$  or  $\mathbf{W}$ . In any case, the identity  $\mathbf{w}_i \approx \mathbf{w}_{i+1}$  holds in  $\mathbf{V}$ . Then by hypothesis,  $\mathbf{w}_i \in \{\mathbf{u}, \mathbf{v}\}$  for all  $i = 0, 1, \dots, n$ . This contradicts the assumption that  $\mathbf{V}$  is a proper subvariety of  $\mathbf{U}$  and  $\mathbf{W}$ . Therefore,  $\mathbf{U} \subseteq \mathbf{W}$ . This evidently implies the required conclusion.  $\square$

**Remark 3.8.** *The hypothesis of Proposition 3.7 holds whenever  $\mathbf{X} = \mathbf{MON}$  and  $\mathbf{V}$  is either  $\mathbf{COM}$ ,  $\mathbf{N}_k$  for any  $k \in \mathbb{N}$ , or*

$$\mathbf{M}_2 = \text{var}\{yxyzxz \approx yxzyxz\}.$$

*Proof.* It is well known and easily shown that if  $\mathbf{V} = \mathbf{COM} = \text{var}\{xy \approx yx\}$  satisfies  $xy \approx \mathbf{v}$ , then  $\mathbf{v} \in \{xy, yx\}$ . If  $\mathbf{V} = \mathbf{N}_k = \text{var}\{\mathbf{p}_k \approx \mathbf{q}_k\}$  satisfies  $\mathbf{p}_k \approx \mathbf{v}$ , then  $\mathbf{v} \in \{\mathbf{p}_k, \mathbf{q}_k\}$  by Lemma 3.2. Finally, if  $\mathbf{V} = \mathbf{M}_2 = \text{var}\{yxyzxz \approx yxzyxz\}$  satisfies  $yxyzxz \approx \mathbf{v}$ , then it follows from Gusev [20, proof of Lemma 3.2] that  $\mathbf{v} \in \{yxyzxz, yxzyxz\}$ .  $\square$

Proposition 3.7 and Remark 3.8 imply the following result.

**Corollary 3.9.** *Each of the varieties  $\mathbf{COM}$ ,  $\mathbf{M}_2$ , and  $\mathbf{N}_k$  for any  $k \in \mathbb{N}$  has a unique cover in the lattice  $\mathbf{MON}$ .*

Corollary 3.9 shows that varieties with a unique cover in **MON** include both overcommutative varieties and aperiodic ones.

**Remark 3.10.** *The variety  $\mathbf{COM} \vee \mathbf{D}_1$  is the unique cover of  $\mathbf{COM}$ .*

*Proof.* Let  $\mathbf{V}$  be any monoid variety such that  $\mathbf{COM} \subset \mathbf{V}$ . Then evidently,  $\mathbf{V}$  is neither completely regular nor commutative. Since  $\mathbf{D}_1 \subseteq \mathbf{V}$  by Lemma 2.9, the inclusion  $\mathbf{COM} \vee \mathbf{D}_1 \subseteq \mathbf{V}$  follows.  $\square$

#### 4. VARIETAL LATTICES WITH COMPLEX STRUCTURES

**4.1. Varietal lattices without non-trivial identities.** It is general knowledge that the lattice of all group varieties is not only modular but also Arguesian. In contrast, the lattice **SEM** and even some of its sublattices do not satisfy any non-trivial lattice identity. The proofs of these results rely heavily upon a classical result in lattice theory concerning the lattice  $\Pi_n$  of all partitions of the set  $\{1, 2, \dots, n\}$ .

**Lemma 4.1** (Sachs [77]). *The class  $\{\Pi_n \mid n \in \mathbb{N}\}$  does not satisfy any non-trivial lattice identity. Consequently, the lattice  $\Pi_\infty$  of all partitions of  $\mathbb{N}$  also does not satisfy any non-trivial lattice identity.*

For each  $n \in \mathbb{N}$ , the lattice dual to  $\Pi_n$  is embeddable in  $\mathbf{COM}_{\text{sem}}$  and  $\mathbf{OC}_{\text{sem}}$  [10,100], while the lattice dual to  $\Pi_\infty$  is isomorphic to a subinterval of  $L(\text{var}_{\text{sem}}\{x^2 \approx x^3\})$  [9]. Therefore, by Lemma 4.1, the sublattices  $\mathbf{COM}_{\text{sem}}$ ,  $\mathbf{OC}_{\text{sem}}$ , and  $\mathbf{APER}_{\text{sem}}$  of **SEM** do not satisfy any non-trivial identity.

As for the lattice **MON**, the question of whether it satisfies a non-trivial identity remained open until recently. In 2018, Gusev [19] proved that for any  $n \in \mathbb{N}$ , the lattice dual to  $\Pi_n$  is a homomorphic image of some sublattice of **OC**. It follows from Lemma 4.1 that **OC**, and so also **MON**, do not satisfy any non-trivial identity.

Stronger results were more recently established. Let  $\mathbf{M}_3$  denote the variety of monoids defined by the identities

$$\begin{aligned}\sigma_1 &: xyzxty \approx yzxty, \\ \sigma_2 &: xtyzxy \approx xtyzyx, \\ \sigma_3 &: xzxyty \approx xzyty\end{aligned}$$

and define  $\mathbf{M}_4 = \mathbf{M}_3 \wedge \text{var}\{x^3 \approx x^4, x^3y \approx yx^3\}$ .

**Theorem 4.2** (Gusev and Lee [27, Theorems 3.1 and 4.1]). *For any  $n \in \mathbb{N}$ , the lattice  $\Pi_n$  is anti-isomorphic to*

- a) *some subinterval of  $L(\mathbf{M}_4)$ ;*
- b) *some subinterval of  $[\mathbf{COM}, \mathbf{M}_3]$ .*

*Consequently, the lattices **APER** and **OC** do not satisfy any non-trivial identity.*

An even stronger result is given in Corollary 4.14 below.

Now since every subvariety of  $\mathbf{M}_4$  is finitely based [54], some subvariety of  $\mathbf{M}_4$  must be minimal with respect to having a subvariety lattice that does not satisfy any non-trivial identity. But an explicit example has not yet been found.

**Problem 4.3.**

- a) Find a monoid variety that is minimal with respect to having a subvariety lattice that does not satisfy any non-trivial identity.
- b) Describe monoid varieties that are minimal with respect to having a subvariety lattice that does not satisfy any non-trivial identity.

**4.2. Finitely universal varieties.** A variety  $\mathbf{X}$  of algebras is *finitely universal* if every finite lattice is embeddable in  $L(\mathbf{X})$ . Pudlák and Tůma [74] proved that every finite lattice is embeddable in  $\Pi_n$  for some  $n \in \mathbb{N}$ . It follows that a variety  $\mathbf{X}$  is finitely universal if and only if for any  $n \in \mathbb{N}$ , the lattice  $L(\mathbf{X})$  contains an anti-isomorphic copy of  $\Pi_n$ .

Examples of finitely universal semigroup varieties have been available since the early 1970s [9, 10]. Moreover, the varieties  $\mathbf{COM}_{\text{sem}}$  and  $\mathbf{K}$  on page 4 are minimal finitely universal semigroup varieties; see Shevrin *et al.* [86, Section 12].

However, examples of finitely universal monoid varieties have been elusive for a long time, and their existence has only recently been questioned [42, Question 6.3]. Now Theorem 4.2 provides an affirmative answer since it implies that the variety  $\mathbf{M}_4$  is finitely universal. It turns out that  $\mathbf{M}_4$  is the smallest finitely universal monoid variety currently known, but a minimal example has not been found.

**Problem 4.4.**

- a) Find an example of a minimal finitely universal monoid variety.
- b) Characterize minimal finitely universal monoid varieties.

The following question is also open.

**Question 4.5.** Is there a finitely universal variety of monoids that does not contain any minimal finitely universal variety?

Recall that a variety of algebras is *finitely generated* if it is generated by a finite algebra. Although the variety  $\mathbf{M}_4$  is not finitely generated [57, Theorem 5.1], it is contained in some finitely generated variety [27, Theorem 5.1].

**Proposition 4.6.** *There exists a finitely generated finitely universal monoid variety.*

The smallest possible order of a semigroup that generates a finitely universal variety is four, and up to isomorphism and anti-isomorphism, there are precisely four examples [52]. But similar information for finitely universal monoid varieties is presently unknown.

**Problem 4.7.** Find the smallest possible order of a monoid that generates a finitely universal monoid variety.

Up to isomorphism and anti-isomorphism, every monoid of order five or less, with one exception, generates a monoid variety with finitely many subvarieties [60] and so is not finitely universal; the exception is the monoid  $P_2^1$ , where

$$P_2 = \langle a, b \mid a^2 = ab = a, b^2a = b^2 \rangle = \{a, b, ba, b^2\}.$$

Let  $\mathbf{P}_2^1$  denote the variety generated by  $P_2^1$ . It follows from Lee and Li [59] that

$$\mathbf{P}_2^1 = \text{var}\{xyz \approx xyxzx, \sigma_2\}$$

(the identity basis for  $\mathbf{P}_2^1$  published earlier [89, Lemma 9] turns out to be incorrect).

**Proposition 4.8** (Gusev *et al.* [29]). *The lattice  $L(\mathbf{P}_2^1)$  is given in Fig. 2. In particular, the variety  $\mathbf{P}_2^1$  is not finitely universal because every element in  $L(\mathbf{P}_2^1)$  has at most two covers.*

A description of the main varieties in Fig. 2 requires the following words:

$$\mathbf{b}_{k,m} = x_{k-1}x_kx_{k-2}x_{k-1} \cdots x_{m-1}x_m,$$

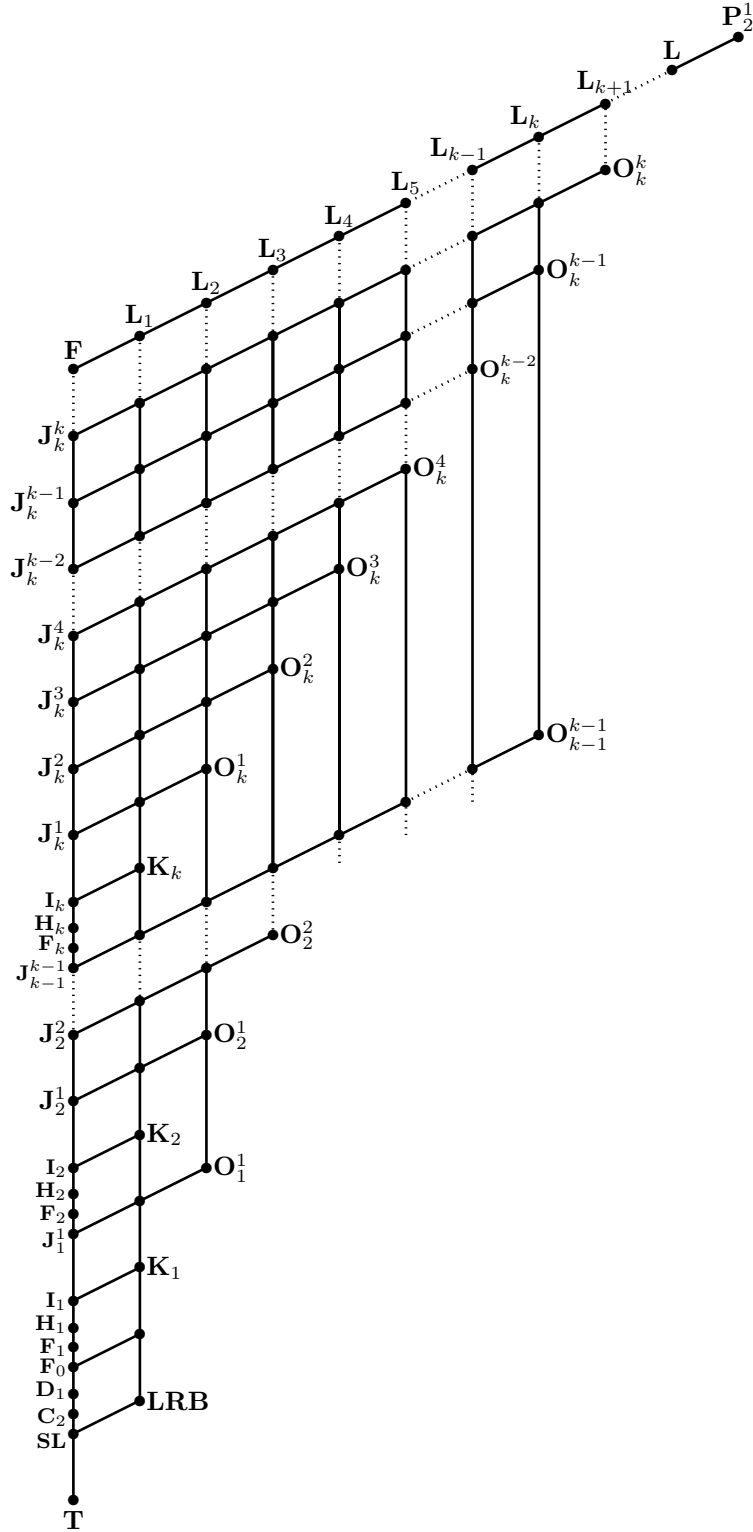

FIGURE 2. The lattice  $L(\mathbf{P}_2^1)$

where  $k, m \in \mathbb{N}$  with  $m \leq k$ . For brevity, write  $\mathbf{b}_k = \mathbf{b}_{k,1}$  and  $\mathbf{b}_0 = \lambda$ . Then

$$\begin{aligned} \mathbf{F} &= \text{var}\{xyx \approx xyx^2, x^2y \approx x^2yx, x^2y^2 \approx y^2x^2\}, \\ \mathbf{F}_0 &= \mathbf{F} \wedge \text{var}\{x^2y \approx xyx\}, \\ \mathbf{F}_k &= \mathbf{F} \wedge \text{var}\{x_k y_k x_{k-1} x_k y_k \mathbf{b}_{k-1} \approx y_k x_k x_{k-1} x_k y_k \mathbf{b}_{k-1}\}, \\ \mathbf{H}_k &= \mathbf{F} \wedge \text{var}\{x x_k x \mathbf{b}_k \approx x_k x^2 \mathbf{b}_k\}, \\ \mathbf{I}_k &= \mathbf{F} \wedge \text{var}\{y_1 y_0 x_k y_1 \mathbf{b}_k \approx y_1 y_0 y_1 x_k \mathbf{b}_k\}, \\ \mathbf{J}_k^m &= \mathbf{F} \wedge \text{var}\left\{ \begin{array}{l} y_{m+1} y_m x_k y_{m+1} \mathbf{b}_{k,m} y_m \mathbf{b}_{m-1} \\ \approx y_{m+1} y_m y_{m+1} x_k \mathbf{b}_{k,m} y_m \mathbf{b}_{m-1} \end{array} \right\}, \\ \mathbf{K}_k &= \mathbf{P}_2^1 \wedge \text{var}\{y_1 y_0 x_k y_1 \mathbf{b}_k \approx y_1 y_0 y_1 x_k \mathbf{b}_k\}, \\ \mathbf{L} &= \mathbf{P}_2^1 \wedge \text{var}\{(xy)^2 \approx x^2 y^2\}, \\ \mathbf{L}_k &= \mathbf{P}_2^1 \wedge \text{var}\{y_k x_{k-1} x y_k x \mathbf{b}_{k-1} \approx y_k x_{k-1} y_k x^2 \mathbf{b}_{k-1}\}, \\ \text{and } \mathbf{O}_k^m &= \mathbf{P}_2^1 \wedge \text{var}\left\{ \begin{array}{l} y_{m+1} y_m x_k y_{m+1} \mathbf{b}_{k,m} y_m \mathbf{b}_{m-1} \\ \approx y_{m+1} y_m y_{m+1} x_k \mathbf{b}_{k,m} y_m \mathbf{b}_{m-1} \end{array} \right\}. \end{aligned}$$

Only the sublattice  $L(\mathbf{F})$  of  $L(\mathbf{P}_2^1)$  requires further elaboration. The subvarieties of  $\mathbf{F}$  form a chain that begins with  $\mathbf{T} \subset \mathbf{SL} \subset \mathbf{C}_2 \subset \mathbf{D}_1 \subset \mathbf{F}_0$ , followed successively by the intervals  $[\mathbf{F}_1, \mathbf{F}_2], [\mathbf{F}_2, \mathbf{F}_3], [\mathbf{F}_3, \mathbf{F}_4], \dots$ , where each  $[\mathbf{F}_k, \mathbf{F}_{k+1}]$  is the chain

$$\mathbf{F}_k \subset \mathbf{H}_k \subset \mathbf{I}_k \subset \mathbf{J}_k^1 \subset \mathbf{J}_k^2 \subset \dots \subset \mathbf{J}_k^k \subset \mathbf{F}_{k+1}$$

consisting of  $k + 4$  varieties.

**Corollary 4.9.** *The monoid variety generated by any monoid of order five or less is not finitely universal. Consequently, the smallest possible order of a monoid that generates a finitely universal monoid variety is at least six.*

For any  $k, m \in \mathbb{N}$  such that  $k < m$ , define the *Burnside monoid variety*

$$\mathbf{B}_{k,m} = \text{var}\{x^k \approx x^m\}.$$

It is clear that the proper inclusions

$$\mathbf{B}_{1,2} \subset \mathbf{B}_{2,3} \subset \mathbf{B}_{3,4} \subset \dots \subset \mathbf{B}_{k,k+1} \subset \dots$$

hold and that every aperiodic monoid variety is contained in  $\mathbf{B}_{k,k+1}$  for all sufficiently large  $k$ . It follows from Theorem 4.2 that the variety  $\mathbf{B}_{3,4}$  is finitely universal. In contrast, the variety  $\mathbf{B}_{1,2} = \mathbf{BAND}$  is not finitely universal because the lattice  $\mathbf{BAND}$  is distributive [102]; see Theorem 5.2. It is currently unknown if the remaining case  $\mathbf{B}_{2,3}$  is finitely universal.

**Question 4.10** (Gusev and Lee [27, Question 6.1]). Is the Burnside monoid variety  $\mathbf{B}_{2,3} = \text{var}\{x^2 \approx x^3\}$  finitely universal?

**4.3. Lattice universal varieties.** A variety  $\mathbf{X}$  of algebras is *lattice universal* if the lattice  $L(\mathbf{X})$  contains an interval anti-isomorphic to  $\Pi_\infty$ . Simple arguments show that if a variety  $\mathbf{X}$  is lattice universal, then  $L(\mathbf{X})$  contains the lattice of all varieties of algebras of any fixed finite or countably infinite type. Recall that the Burnside semigroup variety  $\text{var}_{\text{sem}}\{x^2 \approx x^3\}$  and therefore, the variety  $\mathbf{SEM}$ , are lattice universal [9]. It is therefore natural to question if the same holds true in  $\mathbf{MON}$ .

**Question 4.11.**

- Does the lattice  $\mathbf{MON}$  contain an anti-isomorphic copy of  $\Pi_\infty$ ?
- Does there exist a lattice universal variety of monoids?

We note that a locally finite variety of algebras of any type is not lattice universal. This immediately follows from three folklore results: the subvariety lattice of any locally finite variety of algebras is algebraic, the lattice  $\Pi_\infty$  is not coalgebraic, and any subinterval of an algebraic lattice is again algebraic.

Since the lattice dual to  $\Pi_\infty$  is not embeddable in  $\mathbb{OC}_{\text{sem}}$  [100, Corollary 2.4], it follows from Proposition 2.1 that the same holds true for  $\mathbb{OC}$ .

**Remark 4.12.** *The lattice dual to  $\Pi_\infty$  is not embeddable in  $\mathbb{OC}$ .*

**4.4. Varietal lattices without non-trivial quasi-identities.** Since the class of all finite lattices does not satisfy any non-trivial quasi-identity [8, Corollary 1 after Theorem 3] and every finite lattice is embeddable in  $\Pi_n$  for some  $n \in \mathbb{N}$ , a stronger version of Lemma 4.1 holds.

**Lemma 4.13.** *The class  $\{\Pi_n \mid n \in \mathbb{N}\}$  does not satisfy any non-trivial quasi-identity. Consequently, the lattice  $\Pi_\infty$  of all partitions of  $\mathbb{N}$  also does not satisfy any non-trivial quasi-identity.*

Combining this lemma with the aforementioned results of Burris and Nelson [9] and Volkov [100], we deduce that the lattices  $\mathbb{APER}_{\text{sem}}$  and  $\mathbb{OC}_{\text{sem}}$  do not satisfy any non-trivial quasi-identity. By Theorem 4.2 and Lemma 4.13, similar results also hold within the lattice  $\mathbb{MON}$ .

**Corollary 4.14** (Gusev and Lee [27, Remark 1.3]). *The lattices  $\mathbb{APER}$  and  $\mathbb{OC}$  do not satisfy any non-trivial quasi-identity.*

On the other hand, the lattices  $\mathbb{COM}$  and  $\mathbb{BAND}$  are distributive, while the lattice  $\mathbb{CR}$  is modular; see Theorems 5.1 and 5.2 and Proposition 5.6.

## 5. STRUCTURE OF CERTAIN SUBLATTICES OF $\mathbb{MON}$

**5.1. The lattice  $\mathbb{COM}$ .** It is known since the 1960s that the lattice  $\mathbb{COM}_{\text{sem}}$  is countably infinite; this result holds because Perkins [67] has shown that every variety of commutative semigroups is finitely based. Some characterization of this lattice is provided by Kisielewicz [48]; see also Shevrin *et al.* [86, Section 8]. Nevertheless, the lattice  $\mathbb{COM}_{\text{sem}}$  has a very complex structure; in particular, it does not satisfy any non-trivial identity [10].

However, it turns out that the complexity of the lattice  $\mathbb{COM}_{\text{sem}}$  is concentrated exclusively in its nil-part, that is, the lattice of commutative nil-varieties of semigroups. More precisely, every periodic commutative semigroup variety is the join of a nil-variety and a variety generated by a semigroup with an identity element; this folklore result, first explicitly noted without proof in Korjakov [49], follows from Volkov [99, proof of Proposition 1]. The lattice of commutative nil-varieties has quite a complex structure. In particular, by Korjakov [49], it contains an anti-isomorphic copy of the lattice  $\Pi_n$  for any  $n \in \mathbb{N}$ , whence it does not satisfy any non-trivial identity. But nil-varieties “disappear” in the case of monoids; see Subsection 2.3. As for the lattice consisting of varieties generated by commutative semigroups with an identity element, it is isomorphic to  $\mathbb{COM}$  by Proposition 2.1. The structure of the lattice  $\mathbb{COM}$  turns out to be very simple.

**Theorem 5.1** (Head [35]). *The lattice  $\mathbb{COM}$  is obtained by adjoining a greatest element (the variety  $\mathbf{COM}$ ) to the direct product of the lattice of natural numbers under division (the lattice of Abelian periodic group varieties) and the chain*

$$\mathbf{T} \subset \mathbf{SL} = \mathbf{C}_1 \subset \mathbf{C}_2 \subset \mathbf{C}_3 \subset \cdots .$$

*In particular, if  $\mathbf{V}$  is a commutative monoid variety, then either  $\mathbf{V} = \mathbf{COM}$  or  $\mathbf{V} = \mathbf{A}_k \vee \mathbf{X}$  for some  $k \in \mathbb{N}$  and some variety  $\mathbf{X}$  from the above chain.*



5.2. **The lattice BAND.** A complete description of the lattice  $\mathbb{BAND}_{\text{sem}}$  of all varieties of idempotent semigroups was independently found by Biryukov [6], Fennemore [16], and Gerhard [17]. This well-known lattice is countably infinite and distributive; see, for example, Evans [15, Fig. 4] and Shevrin *et al.* [86, Fig. 2].

A complete description of the lattice  $\mathbb{BAND}$  was given by Wismath [102]. To describe this lattice, let  $\mathbf{B}_2 = \mathbf{LRB}$  and for  $n \geq 3$ , define

$$\mathbf{B}_n = \text{var}\{x \approx x^2, \mathbf{r}_n \approx \mathbf{s}_n\},$$

where

$$\mathbf{r}_n = \begin{cases} x_1x_2x_3 & \text{for } n = 3, \\ \mathbf{r}_{n-1}x_n & \text{for even } n \geq 4, \\ x_n\mathbf{r}_{n-1} & \text{for odd } n \geq 5 \end{cases}$$

and  $\mathbf{s}_n = \begin{cases} x_1x_2x_3x_1x_3x_2x_3 & \text{for } n = 3, \\ \mathbf{s}_{n-1}x_n\mathbf{r}_n & \text{for even } n \geq 4, \\ \mathbf{r}_nx_n\mathbf{s}_{n-1} & \text{for odd } n \geq 5. \end{cases}$

**Theorem 5.2** (Wismath [102]). *The lattice  $\mathbb{BAND}$  is given in Fig. 3.*

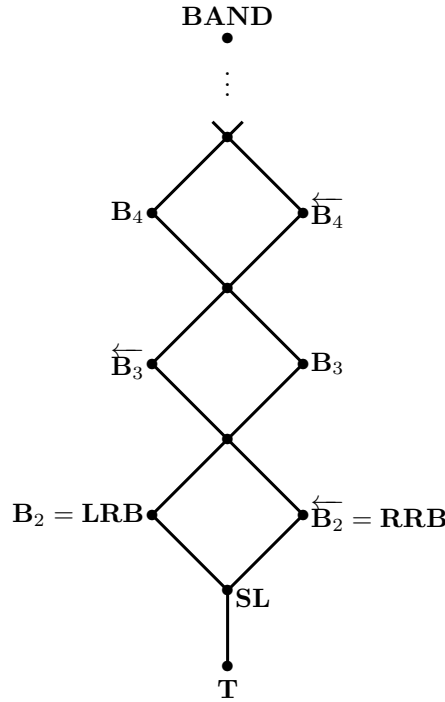

FIGURE 3. The lattice  $\mathbb{BAND}$

We see that the lattice  $\mathbb{BAND}$  is countably infinite and distributive. In fact, by Proposition 2.1, the distributivity and countability (but not infinitum) of  $\mathbb{BAND}$  is inherited from  $\mathbb{BAND}_{\text{sem}}$ .

5.3. **The lattice CR.** Completely regular semigroups can be treated as *unary semigroups*, that is, semigroups with an additional unary operation. Indeed, for any element  $a$  of a completely regular semigroup  $S$ , denote by  $a^{-1}$  the inverse element of  $a$  in the maximal subgroup of  $S$  that contains  $a$ . The mapping  $a \mapsto a^{-1}$  is a natural unary operation on  $S$ . The identities

$$(xy)z \approx x(yz), \quad xx^{-1}x \approx x, \quad xx^{-1} \approx x^{-1}x, \quad (x^{-1})^{-1} \approx x$$

define the variety of all unary completely regular semigroups within the variety of all algebras of type  $(2, 1)$ ; denote this variety by  $\mathbf{UCR}_{\text{sem}}$  and its subvariety lattice by  $\mathbf{UCR}_{\text{sem}}$ . Important information about the structure of  $\mathbf{UCR}_{\text{sem}}$  can be found in the monograph by Petrich and Reilly [69].

Every variety of completely regular semigroups can be considered as a variety of unary completely regular semigroups. Indeed, since such a variety satisfies the identity  $x \approx x^{n+1}$  for some  $n \in \mathbb{N}$ , the element  $x^{2n-1}$  is inverse to  $x$ , whence the operation of inversion is definable in the language of multiplication. Therefore, the lattice  $\mathbf{CR}_{\text{sem}}$  is naturally embedded in  $\mathbf{UCR}_{\text{sem}}$ . Practically, all information about the lattice  $\mathbf{CR}_{\text{sem}}$  that is known so far arises as the “projection” on  $\mathbf{SEM}$  of results about the lattice  $\mathbf{UCR}_{\text{sem}}$ ; see Shevrin *et al.* [86, Section 6]. A description of  $\mathbf{UCR}_{\text{sem}}$  and some of its important sublattices can be found in Polák [70–72].

Now we turn to varieties of completely regular monoids. By analogy with the semigroup case, a monoid with an additional unary operation is called a *unary monoid*. Completely regular monoids can be treated as unary monoids with the same interpretation of the unary operation as in the semigroup case. Let  $\mathbf{UCR}$  denote the variety of all unary completely regular monoids and  $\mathbf{UCR}$  denote the lattice of all unary completely regular monoid varieties.

The same arguments as in the semigroup case show that varieties of completely regular monoids can be considered as varieties of unary completely regular monoids. Therefore, the lattice  $\mathbf{CR}$  is naturally embedded in  $\mathbf{UCR}$ . There has not been any articles devoted specifically to the lattice  $\mathbf{CR}$ , but the lattice  $\mathbf{UCR}$  was studied and characterized by Vachuska [93].

The following statement is a unary completely regular analog of Proposition 2.1.

**Proposition 5.3** (Vachuska [93, Lemma 2.1 and Theorem 2.2]). *The mapping from  $\mathbf{UCR}$  into  $\mathbf{UCR}_{\text{sem}}$  that sends a variety of unary completely regular monoids generated by a unary monoid  $M$  to the variety of unary completely regular semigroups generated by the unary semigroup reduct of  $M$  is an embedding of the lattice  $\mathbf{UCR}$  into  $\mathbf{UCR}_{\text{sem}}$ .*

Recall that an element  $x$  of a lattice  $\langle L; \vee, \wedge \rangle$  is *neutral* if

$$\forall y, z \in L : (x \vee y) \wedge (y \vee z) \wedge (z \vee x) = (x \wedge y) \vee (y \wedge z) \vee (z \wedge x).$$

It is well known that if  $a$  is a neutral element in a lattice  $L$ , then  $L$  is decomposable into a subdirect product of the principal ideal and the principal filter of  $L$  generated by  $a$ ; see Grätzer [18, Theorem 254], for instance.

Given that the variety  $\mathbf{SL}_{\text{sem}}$  of semilattices is a neutral element of the lattice  $\mathbf{UCR}_{\text{sem}}$  [34], it follows from Proposition 5.3 that the variety  $\mathbf{SL}$  of semilattice monoids is a neutral element of the lattice  $\mathbf{UCR}$ . Therefore,  $\mathbf{UCR}$  is a subdirect product of the coideal  $[\mathbf{SL}, \mathbf{UCR}]$  and the 2-element chain  $L(\mathbf{SL})$ . To describe the lattice  $\mathbf{UCR}$ , it is thus sufficient to characterize the coideal  $[\mathbf{SL}, \mathbf{UCR}]$ , which is performed in Vachuska [93]. This is the monoid analog of results of Polák [70, 71].

To describe the results in Vachuska [93], we need some definitions and notation. Let  $U^1$  denote the free unary monoid over a countably infinite alphabet with the unary operation  $^{-1}$ . Elements of  $U^1$  are called *unary words* or simply *words*. For any  $\mathbf{u} \in U^1$ , let  $\text{con}(\mathbf{u})$  denote the set of letters occurring in  $\mathbf{u}$ . If  $|\text{con}(\mathbf{u})| > 1$ , then let  $0(\mathbf{u})$  [respectively,  $1(\mathbf{u})$ ] denote the unary word obtained from the longest initial [respectively, terminal] segment of the word  $\mathbf{u}$  that contains  $|\text{con}(\mathbf{u})| - 1$  letters by omitting all opening brackets such that the segment does not contain the corresponding closing ones [respectively, all expressions in the form  $)^{-1}$  such that the segment does not contain the corresponding opening brackets]. For example, if  $\mathbf{u} = x((yx)^{-1}z)^{-1}x$ , then  $0(\mathbf{u}) = x(yx)^{-1}$  and  $1(\mathbf{u}) = xzx$ . If  $|\text{con}(\mathbf{u})| = 1$ , then define  $0(\mathbf{u}) = 1(\mathbf{u}) = \lambda$ .

For an arbitrary fully invariant congruence  $\sim$  on  $U^1$ , define the relation  $\approx$  on  $U^1$  recursively as follows: if  $\mathbf{u} = \lambda$ , then  $\mathbf{u} \approx \mathbf{v}$  if and only if  $\mathbf{v} = \lambda$ ; if  $|\text{con}(\mathbf{u})| = 1$ , then  $\mathbf{u} \approx \mathbf{v}$  if and only if  $\text{con}(\mathbf{u}) = \text{con}(\mathbf{v})$  and  $\mathbf{u} \sim \mathbf{v}$ ; if  $|\text{con}(\mathbf{u})| > 1$ , then  $\mathbf{u} \approx \mathbf{v}$  if and only if  $\text{con}(\mathbf{u}) = \text{con}(\mathbf{v})$ ,  $\mathbf{u} \sim \mathbf{v}$ ,  $0(\mathbf{u}) \approx 0(\mathbf{v})$ , and  $1(\mathbf{u}) \approx 1(\mathbf{v})$ . For any variety  $\mathbf{V}$  of unary completely regular monoids, let  $\sim_{\mathbf{V}}$  denote the fully invariant congruence on  $U^1$  that corresponds to  $\mathbf{V}$ . Define a relation  $\rho$  on  $\mathbf{UCR}$  by  $\mathbf{V} \rho \mathbf{W}$  if and only if  $\approx_{\mathbf{V}} = \approx_{\mathbf{W}}$ ; this relation is a complete lattice congruence on  $\mathbf{UCR}$  [93, Proposition 4.6]. The lattice obtained by adjoining a new least element 0 to  $\mathbf{UCR}/\rho$  is denoted by  $(\mathbf{UCR}/\rho)_0$ . Let  $\Lambda$  be the partially ordered set in Fig. 4.

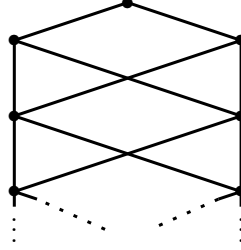

FIGURE 4. The partially ordered set  $\Lambda$

**Theorem 5.4** (Vachuska [93, Theorem 3.1]). *The coideal  $[\mathbf{SL}, \mathbf{UCR}]$  of the lattice  $\mathbf{UCR}$  is embeddable in the lattice of all isotone mappings from  $\Lambda$  into  $(\mathbf{UCR}/\rho)_0$ .*

In fact, the image of the coideal  $[\mathbf{SL}, \mathbf{UCR}]$  under the embedding mentioned in Theorem 5.4 is explicitly described in Vachuska [93]. Thus, the study of the lattice  $\mathbf{UCR}$  is reduced to the study of the lattice  $\mathbf{UCR}/\rho$ . Note also that in view of Vachuska [93, Theorem 3.1 and Lemma 5.2], the coideal  $[\mathbf{SL}, \mathbf{UCR}]$  is a subdirect product of countably many copies of the lattice  $(\mathbf{UCR}/\rho)_0$ .

The construction in Vachuska [93], which we reproduced above in order to state Theorem 5.4, almost literally repeats the construction introduced by Polák [70, 71]. The main result of these two articles states that the coideal  $[\mathbf{SL}_{\text{sem}}, \mathbf{UCR}_{\text{sem}}]$  of the lattice  $\mathbf{UCR}_{\text{sem}}$  is embeddable in the lattice of all isotone mappings from  $\Lambda$  into the ordinal sum of the 3-element non-chain meet-semilattice and  $\mathbf{UCR}_{\text{sem}}/\rho$ , where the congruence  $\rho$  on  $\mathbf{UCR}_{\text{sem}}$  is defined in exactly the same way as above; see Polák [71, Theorem 3.6].

The description of the lattice  $\mathbf{BAND}$  in Subsection 5.2 is in fact a very partial case of the results of Vachuska [93]. The lattice  $\mathbf{BAND}/\rho$  is singleton and this gives a presentation of  $\mathbf{BAND}$  as a certain lattice of isotone mappings from  $\Lambda$  into the 2-element lattice.

A semigroup  $S$  is *regular* if for any  $a \in S$ , there exists some  $x \in S$  such that  $axa = a$ . A regular semigroup is *orthodox* if its idempotents form a subsemigroup. The class of all completely regular orthodox semigroups [respectively, monoids] forms a subvariety in  $\mathbf{UCR}_{\text{sem}}$  [respectively,  $\mathbf{UCR}$ ] defined within  $\mathbf{UCR}_{\text{sem}}$  [respectively,  $\mathbf{UCR}$ ] by the identity  $(xx^{-1}yy^{-1})^2 \approx xx^{-1}yy^{-1}$ . The lattice of all completely regular orthodox semigroup [respectively, monoid] varieties is denoted by  $\mathbf{UOCR}_{\text{sem}}$  [respectively,  $\mathbf{UOCR}$ ]. The construction in Polák [70, 71] turns out to be more transparent if restricted to  $\mathbf{UOCR}_{\text{sem}}$ . The lattice  $\mathbf{UOCR}_{\text{sem}}/\rho$  is isomorphic to the lattice of all varieties of groups, and Polák [72, Theorem 4.2(2)] has obtained a presentation of  $\mathbf{UOCR}_{\text{sem}}$  as a precisely described sublattice of the direct product of countably many copies of the lattice of varieties of groups. We note that an analogous presentation for the lattice of all completely regular orthodox varieties in plain semigroup setting (without the unary operation in the language) was found earlier by Rasin [75]. The following proposition is a consequence of the mentioned result from Polák [72] together with Proposition 5.3.

**Proposition 5.5.** *The lattice  $\mathbf{UOCR}$  is a sublattice of the direct product of countably many copies of the lattice of varieties of groups.*

Along with the results of Polák [70–72], another fundamental achievement in the study of the lattice  $\mathbf{UCR}_{\text{sem}}$  is the proof that this lattice is Arguesian and therefore, modular. This was established in three different ways by Pastijn [64, 65] and Petrich and Reilly [68]. This result and Proposition 5.3 imply the following assertion.

**Proposition 5.6.** *The lattice  $\mathbf{UCR}$  is Arguesian and therefore, modular. Consequently, the lattice  $\mathbf{CR}$  possesses the same properties.*

## Part 2. Varieties with restrictions to subvariety lattices

The restrictions on subvariety lattices of monoid varieties considered in this part are divided into three groups and given in Sections 6–8. The first group includes lattice identities and related conditions. The second group consists of finiteness conditions, that is, conditions satisfied by any finite lattice. The third group contains other conditions that seem worthy of attention, such as decomposability into a direct product, properties related to the notion of lattice dualism, and the property of being a complemented lattice and related conditions.

### 6. IDENTITIES AND RELATED CONDITIONS

The study of identities and related conditions traditionally attracts great attention when varietal lattices for algebras of various types are considered. As we have already mentioned in Section 4, the lattice  $\mathbf{MON}$  does not satisfy any non-trivial identity or even quasi-identity. In this section, we consider a number of conditions of the aforementioned type for subvariety lattices of monoid varieties. We consider in detail the modular and distributive laws, as well as the property of being a chain. In addition, the Arguesian law and semimodular property are also discussed.

**6.1. Chain varieties.** A variety of algebras is a *chain variety* if its subvariety lattice is a chain. Since being a chain is a much stronger property than satisfying the distributive law, the study of chain varieties can be considered a first step in the investigation of varieties with a distributive lattice of subvarieties. For this reason, classifying chain varieties is typical for the initial stage of studying lattices of varieties of algebras of various types.

In the cases of semigroups and monoids, classifying chain varieties includes the problem of identifying chain varieties of periodic groups. In the locally finite case, the latter problem was solved by Artamonov [4]. But a complete classification of chain group varieties is extremely difficult because by Theorem 2.7, there exist uncountably many non-locally finite group varieties whose subvariety lattice is isomorphic to the 3-element chain.

Non-group chain varieties of semigroups were completely listed by Sukhanov [88]. Gusev and Vernikov [31] found a complete classification of non-group chain varieties of monoids. To formulate this result, we need some notation. For any  $n \in \mathbb{N}$ , let  $S_n$  denote the full symmetric group on the set  $\{1, 2, \dots, n\}$ . For arbitrary permutations  $\pi, \tau \in S_n$ , define the words

$$\mathbf{w}_n(\pi, \tau) = \left( \prod_{i=1}^n z_i t_i \right) x \left( \prod_{i=1}^n z_{\pi(i)} z_{n+\tau(i)} \right) x \left( \prod_{i=n+1}^{2n} t_i z_i \right)$$

and  $\mathbf{w}'_n(\pi, \tau) = \left( \prod_{i=1}^n z_i t_i \right) x^2 \left( \prod_{i=1}^n z_{\pi(i)} z_{n+\tau(i)} \right) \left( \prod_{i=n+1}^{2n} t_i z_i \right).$

Several varieties involving the identities  $\sigma_1$ ,  $\sigma_2$ , and  $\sigma_3$  from Subsection 4.1 are also required:

$$\begin{aligned} \mathbf{D} &= \text{var}\{x^2 \approx x^3, x^2y \approx yx^2, \sigma_1, \sigma_2, \sigma_3\}, \\ \mathbf{D}_k &= \mathbf{D} \wedge \text{var}\{x^2y_1y_2 \cdots y_k \approx xy_1xy_2x \cdots xy_kx\}, k \in \mathbb{N}, \\ \mathbf{M}_5 &= \text{var} \left\{ \begin{array}{l} x^2y \approx yx^2, x^2yz \approx xyxzx, \\ \sigma_1, \sigma_2, \mathbf{w}_n(\pi, \tau) \approx \mathbf{w}'_n(\pi, \tau) \end{array} \middle| n \in \mathbb{N}, \pi, \tau \in S_n \right\}, \\ \mathbf{M}_6 &= \text{var}\{x^2y \approx yx^2, x^2yz \approx xyxzx, \sigma_2, \sigma_3\}, \\ \text{and } \mathbf{M}_7 &= \mathbf{M}_6 \wedge \text{var}\{xyzxy \approx yxzyx\}. \end{aligned}$$

**Theorem 6.1** (Gusev and Vernikov [31, Corollary 7.1]). *The varieties  $\mathbf{B}_2, \overleftarrow{\mathbf{B}}_2, \mathbf{C}_n, \mathbf{D}, \mathbf{D}_k, \mathbf{F}, \overleftarrow{\mathbf{F}}, \mathbf{F}_\ell, \overleftarrow{\mathbf{F}}_\ell, \mathbf{H}_k, \overleftarrow{\mathbf{H}}_k, \mathbf{I}_k, \overleftarrow{\mathbf{I}}_k, \mathbf{J}_k^m, \overleftarrow{\mathbf{J}}_k^m, \mathbf{M}_5, \mathbf{M}_6, \overleftarrow{\mathbf{M}}_6, \mathbf{M}_7$ , and  $\overleftarrow{\mathbf{M}}_7$ , where  $\ell \in \mathbb{N} \cup \{0\}$  and  $k, m, n \in \mathbb{N}$  with  $m \leq k$ , are the only non-group chain varieties of monoids.*

The partially ordered set of all non-group chain varieties of monoids together with the variety  $\mathbf{T}$  is shown in Fig. 5.

We note that a number of chain varieties of monoids were found prior to the full classification in Theorem 6.1. The lattice  $L(\mathbf{C}_n)$  was described in Head [35], while the lattices  $L(\mathbf{B}_2)$  and  $L(\overleftarrow{\mathbf{B}}_2)$  can be found in Wismath [102] (see Theorems 5.1 and 5.2); the lattices  $L(\mathbf{D})$  and  $L(\mathbf{F}_0)$  were described by Lee [53, 57]; and the lattices  $L(\mathbf{M}_5)$  and  $L(\mathbf{M}_7)$  were described by Jackson [40]. The remaining varieties— $\mathbf{F}, \mathbf{F}_k, \mathbf{H}_k, \mathbf{I}_k, \mathbf{J}_k^m, \mathbf{M}_6$ , and their duals—were found by Gusev and Vernikov [31].

Every non-group chain variety of semigroups is contained in a maximal chain variety, while any non-group non-chain variety of semigroups contains some minimal non-chain subvariety [88, Corollary 2]. However, these statements do not hold for monoid varieties. Indeed, the variety  $\mathbf{C}_n$  with  $n \geq 3$  is not contained in a maximal chain variety (see Fig. 5), while non-chain varieties of monoids that do not contain any minimal non-chain subvariety exist [31, Corollary 7.4]. Another significant feature of the monoid case is that  $\mathbf{M}_5$  is a non-finitely based non-group chain variety of monoids [40, Proposition 5.1], while all non-group chain varieties of semigroups are finitely based. Since the set of all finitely based group varieties is countably infinite, Theorem 2.7 implies that there are uncountably many group chain varieties without finite identity basis. However, explicit examples of non-finitely based chain group varieties have not been found so far.

There is one more interesting consequence of Theorem 6.1.

**Corollary 6.2** (Gusev and Vernikov [31, Corollary 7.6]). *Every non-group chain variety of monoids is contained in some finitely generated variety and so is locally finite.*

But by Theorem 2.7, this result does not hold for group varieties.

**6.2. Modularity.** One of the most profound advances in the study of the lattice  $\mathbf{SEM}$ , due to Volkov in the early 1990s, is the complete description of semigroup varieties with a modular subvariety lattice. A full account of its proof, along with several of related results, occupied seven articles that were published in 1989–2004; see Shevrin *et al.* [86, Section 11] for more details.

One would hope to replicate Volkov's achievement in the lattice  $\mathbf{MON}$ .

**Problem 6.3.** Describe varieties of monoids with a modular subvariety lattice.

Presently, this problem is very far from being solved; some complications are highlighted at the end of Subsection 2.3. However, there exist results that are relevant to solving Problem 6.3. Recall that any monoid variety that is commutative

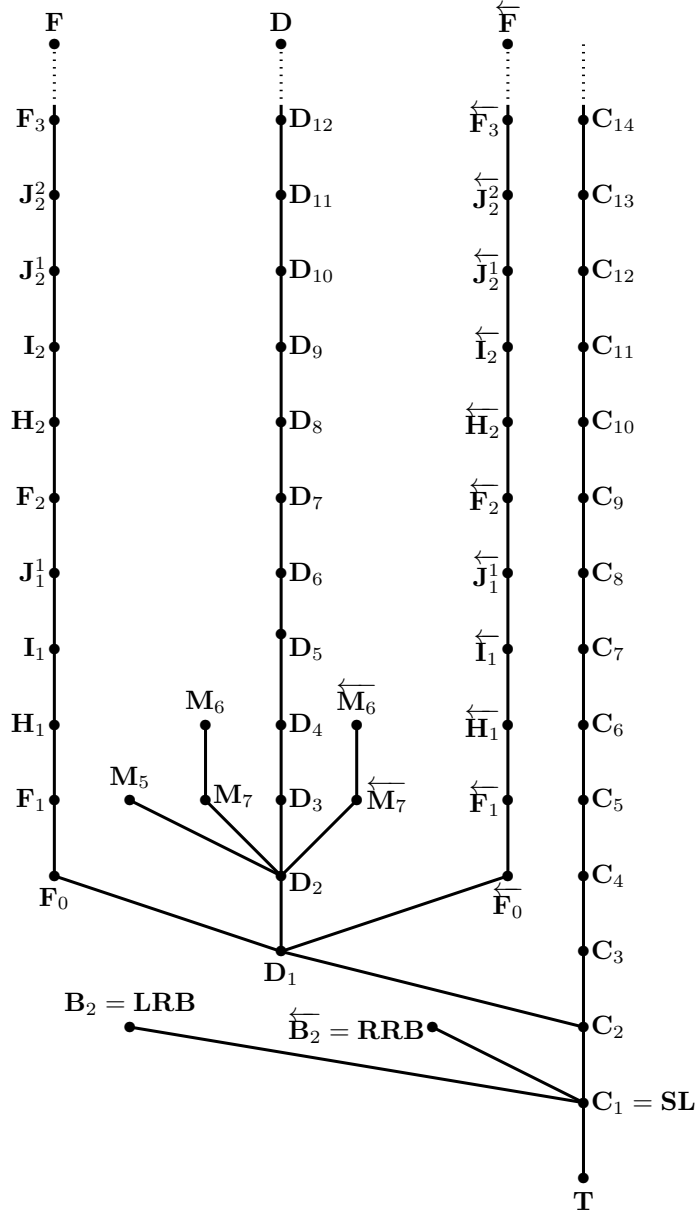

FIGURE 5. All non-group chain varieties of monoids with  $\mathbf{T}$

or completely regular has a modular subvariety lattice; see Theorem 5.1 and Proposition 5.6. The first example of a monoid variety with a non-modular subvariety lattice was published by Lee [55] in 2012: the variety  $\mathbf{A}_0^1 \vee \mathbf{LRB} \vee \mathbf{RRB}$  with  $\mathbf{A}_0^1 = \text{var } A_0^1$ , where

$$A_0 = \langle a, b \mid a^2 = a, b^2 = b, ba = 0 \rangle = \{a, b, ab, 0\};$$

see Fig. 6. In contrast, the first examples of semigroup varieties with a non-modular subvariety lattice were discovered independently by Ježek [44] and Schwabauer [83] back in the late 1960s.

Now we formulate three necessary conditions for a monoid variety to have a modular subvariety lattice.

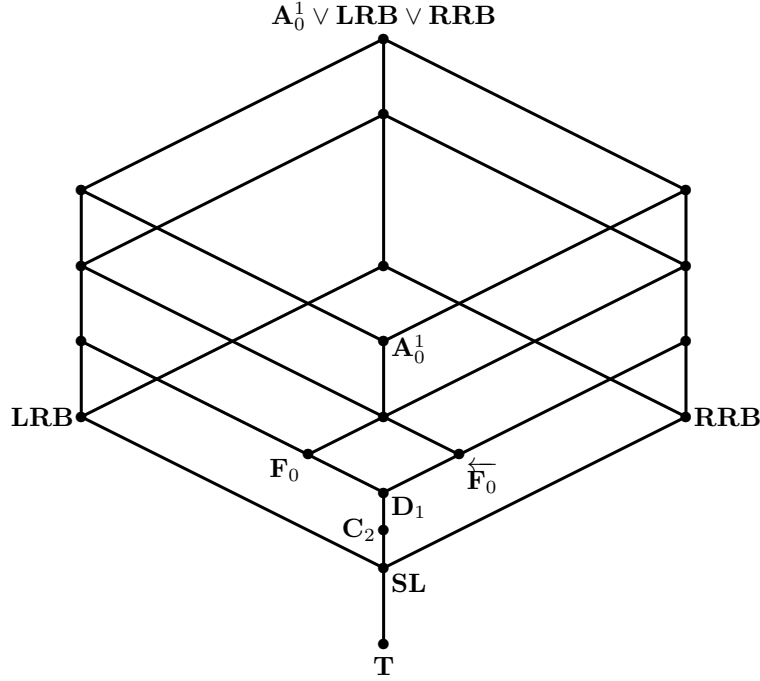

FIGURE 6. The lattice  $L(\mathbf{A}_0^1 \vee \mathbf{LRB} \vee \mathbf{RRB})$

**Proposition 6.4** (M. V. Volkov, unpublished). *If  $\mathbf{X}$  is a non-completely regular monoid variety with a modular subvariety lattice, then every completely regular subvariety of  $\mathbf{X}$  is commutative.*

*Proof.* This follows from Gusev [20, Lemma 3.1] and line 4 of Table 1.  $\square$

Note that the non-modularity of the lattice  $L(\mathbf{A}_0^1 \vee \mathbf{LRB} \vee \mathbf{RRB})$  follows from Proposition 6.4.

**Proposition 6.5.** *If  $\mathbf{X}$  is a monoid variety with a modular subvariety lattice and  $\mathbf{C}_3 \subseteq \mathbf{X}$ , then  $\mathbf{X}$  is a variety of monoids with central idempotents.*

*Proof.* This is a consequence of Gusev [23, Lemma 2] and Gusev and Vernikov [31, Lemma 4.1 and Proposition 4.2].  $\square$

**Proposition 6.6.** *If  $\mathbf{X}$  is a monoid variety with a modular subvariety lattice and  $\mathbf{F}_0 \subseteq \mathbf{X}$ , then  $\mathbf{X} \subseteq \mathbf{B}_{2,k}$  for some  $k \geq 3$ .*

*Proof.* This can be easily deduced from Gusev [23, Lemma 2] and Gusev and Vernikov [31, Lemma 2.5].  $\square$

To date, up to duality, there are only three explicit examples of monoid varieties with non-modular subvariety lattice that are not covered by Propositions 6.4–6.6:

$$\mathbf{M}_6 \vee \overleftarrow{\mathbf{M}}_7, \quad \mathbf{M}_8 = \text{var } S_8^1, \quad \text{and} \quad \mathbf{M}_9 = \text{var } M_9,$$

where

$$S_8 = \left\langle a, b, c \mid \begin{array}{l} a^2 = a, b^2 = b^3, bcb^2 = bcb, \\ ca = c, abc = ac = ba = b^2c = 0 \end{array} \right\rangle \\ = \{a, b, c, ab, ab^2, b^2, bc, bcb, cb, cb^2, 0\}$$

$$\text{and } M_9 = \langle a, g \mid a^3 = 0, g^2 = 1, ag = a, ga^2 = a^2 \rangle = \{a, g, a^2, ga, 0, 1\}.$$

The lattice  $L(\mathbf{M}_6 \vee \overleftarrow{\mathbf{M}}_7)$ , modulo the interval  $[\mathbf{M}_7 \vee \overleftarrow{\mathbf{M}}_7, \mathbf{M}_6 \vee \overleftarrow{\mathbf{M}}_7]$ , is given in Gusev [21], while the lattices  $L(\mathbf{M}_8)$  and  $L(\mathbf{M}_9)$  are due to Gusev and O. B. Sapir [30] and Lee [58], respectively; see Figs. 7–9. The undefined varieties in Figs. 8 and 9 are  $\mathbf{M}_{10} = \text{var } S_{10}^1$  and  $\mathbf{M}_{11} = \text{var } M_{11}$ , where

$$S_{10} = \left\langle a, b, c \mid \begin{array}{l} a^2 = a^3, b^2 = b^3, bcb^2 = bcb, \\ c^2 = ba = ca = ac = b^2c = ab^2 = 0 \end{array} \right\rangle$$

$$= \{a, b, c, cb, cb^2, b^2, bc, bcb, ab, abc, abcb, a^2, a^2b, a^2bc, a^2bcb, 0\}$$

and  $M_{11} = \langle a, g \mid a^2 = 0, g^2 = 1, ag = a \rangle = \{a, g, ga, 0, 1\}$ .

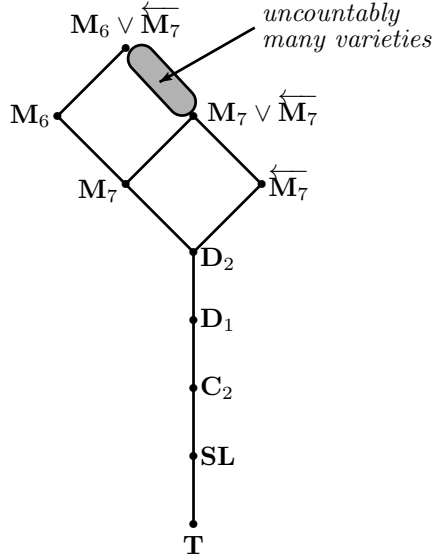

FIGURE 7. The lattice  $L(\mathbf{M}_6 \vee \overleftarrow{\mathbf{M}}_7)$

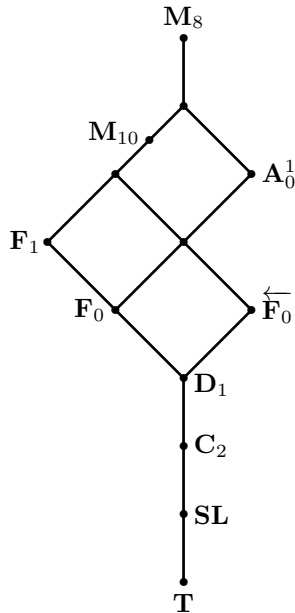
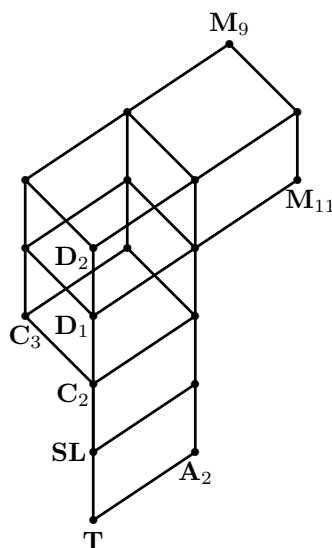

FIGURE 8. The lattice  $L(\mathbf{M}_8)$



FIGURE 9. The lattice  $L(\mathbf{M}_9)$ 

A variety  $\mathbf{X}$  of algebras is *almost modular* if its subvariety lattice is not modular but the subvariety lattice of each proper subvariety of  $\mathbf{X}$  is modular. Up to duality,  $\mathbf{C}_2 \vee \mathbf{LRB}$ ,  $\mathbf{A}_0^1 \vee \mathbf{F}_1$ , and  $\mathbf{M}_9$  are the only monoid varieties currently known to be almost modular. The varieties  $\mathbf{C}_2 \vee \mathbf{LRB}$  and  $\mathbf{A}_0^1 \vee \mathbf{F}_1$  are aperiodic, while  $\mathbf{M}_9$  is of period two.

**Question 6.7.** Is there a way to generalize  $\mathbf{M}_9$  to an almost modular variety of any odd prime period?

In conclusion of this subsection, we suggest the following problems as feasible stepping stones toward solving Problem 6.3.

**Problem 6.8.**

- a) Describe varieties of monoids with central idempotents whose subvariety lattice is modular.
- b) Describe overcommutative varieties of monoids whose subvariety lattice is modular.

In view of Proposition 6.5, Part b) of Problem 6.8 is a particular case of Part a).

**6.3. Distributivity.** Volkov's contributions to semigroup varieties with a modular subvariety lattice, mentioned at the beginning of Subsection 6.2, contains essential information about semigroup varieties with a distributive subvariety lattice, which results in an almost complete description modulo group varieties; see Shevrin *et al.* [86, Section 11].

Although the lattice  $\mathbb{G}\mathbb{R}$  of periodic group varieties is modular, a description of periodic group varieties with distributive subvariety lattice has remained very elusive, especially in view of Theorem 2.7. Therefore, in the investigation of distributive lattices of monoid varieties, it is logical to focus on non-group varieties.

**Problem 6.9.** Describe varieties of monoids with a distributive subvariety lattice modulo varieties of groups.

**Problem 6.10.** Describe aperiodic varieties of monoids with a distributive subvariety lattice.

Similar to Problem 6.3, both Problems 6.9 and 6.10 are very far from being completely solved. Some reasons that complicate the solution of these problems are highlighted at the end of Subsection 2.3.

Recall from Theorems 5.1 and 5.2 that the lattices  $\mathbb{COM}$  and  $\mathbb{BAND}$  are distributive. Overcommutative varieties with a distributive subvariety lattice also exist, obvious examples are the variety  $\mathbf{COM}$  and its unique cover  $\mathbf{COM} \vee \mathbf{D}_1$ ; see Remark 3.10. In contrast, the subvariety lattice of every overcommutative semigroup variety does not satisfy any non-trivial identity [10]. Another class of varieties with a distributive subvariety lattice is the class of chain varieties. In addition to commutative, band, and chain varieties, a number of examples of monoid varieties with the distributive subvariety lattice are given in or can be extracted from Figs. 6–15. Notable progress in solving Problem 6.10 has recently been made when a characterization was found for all varieties of aperiodic monoids with central idempotents whose subvariety lattice is distributive [25]. To describe these varieties, several new words are required: define  $S_0 = S_1$  and for  $m, k, \ell \in \mathbb{N} \cup \{0\}$  and  $\rho \in S_{m+k+\ell}$ , let

$$\mathbf{c}_{m,k,\ell}(\rho) = \left( \prod_{i=1}^m z_i t_i \right) xyt \left( \prod_{i=m+1}^{m+k} z_i t_i \right) x \left( \prod_{i=1}^{m+k+\ell} z_i \rho \right) y \left( \prod_{i=m+k+1}^{m+k+\ell} t_i z_i \right)$$

$$\text{and } \mathbf{c}'_{m,k,\ell}(\rho) = \left( \prod_{i=1}^m z_i t_i \right) yxt \left( \prod_{i=m+1}^{m+k} z_i t_i \right) x \left( \prod_{i=1}^{m+k+\ell} z_i \rho \right) y \left( \prod_{i=m+k+1}^{m+k+\ell} t_i z_i \right),$$

and let  $\overleftarrow{\mathbf{c}}_{m,k,\ell}(\rho)$  and  $\overleftarrow{\mathbf{c}}'_{m,k,\ell}(\rho)$  be the words obtained by writing  $\mathbf{c}_{m,k,\ell}(\rho)$  and  $\mathbf{c}'_{m,k,\ell}(\rho)$  in reverse order. Then for each  $n \in \mathbb{N}$ , define the varieties

$$\mathbf{Q}_n = \text{var} \left\{ \begin{array}{l} x^n \approx x^{n+1}, x^2 y \approx y x^2, \\ \mathbf{w}_n(\pi, \tau) \approx \mathbf{w}'_n(\pi, \tau), \\ \mathbf{c}_{m,k,\ell}(\rho) \approx \mathbf{c}'_{m,k,\ell}(\rho), \\ \overleftarrow{\mathbf{c}}_{m,k,\ell}(\rho) \approx \overleftarrow{\mathbf{c}}'_{m,k,\ell}(\rho) \end{array} \middle| \begin{array}{l} n \in \mathbb{N}, \pi, \tau \in S_n, \\ m, k, \ell \in \mathbb{N} \cup \{0\}, \\ \rho \in S_{m+k+\ell} \end{array} \right\},$$

$$\mathbf{R}_n = \text{var} \{x^n \approx x^{n+1}, x^n y \approx y x^n, x^2 y \approx x y x\},$$

$$\text{and } \mathbf{S}_n = \text{var} \{x^n \approx x^{n+1}, x^2 y \approx y x^2, \sigma_2, \sigma_3\}.$$

**Theorem 6.11** (Gusev [25, Theorem 1.1]). *A variety of aperiodic monoids with central idempotents has a distributive subvariety lattice if and only if it is contained in  $\mathbf{Q}_n$ ,  $\mathbf{R}_n$ ,  $\overleftarrow{\mathbf{R}}_n$ ,  $\mathbf{S}_n$ , or  $\overleftarrow{\mathbf{S}}_n$  for some  $n \in \mathbb{N}$ .*

The structure of the lattices  $L(\mathbf{Q}_n)$ ,  $L(\mathbf{R}_n)$ , and  $L(\mathbf{S}_n)$  are so complicated that it is impossible to fully illustrate them with clarity. But it is possible to exhibit the subvariety lattice of some subvarieties of  $\mathbf{S}_n$ , such as  $\mathbf{D} \vee \mathbf{M}_6$  [32, Corollary 5.3]; see Fig. 10.

The following provides some reasonable problems the solutions of which would further contribute toward solving Problem 6.9 completely.

**Problem 6.12.**

- a) Describe varieties of aperiodic monoids with commuting idempotents whose subvariety lattice is distributive.
- b) Describe overcommutative varieties of monoids whose subvariety lattice is distributive.

Besides characterizing varieties having a distributive subvariety lattice, another approach toward solving Problem 6.9 is to locate substantial examples of varieties with a subvariety lattice that is modular but not distributive. The first and currently only known example was recently found: the variety  $\mathbf{M}_{12} \vee \overleftarrow{\mathbf{M}}_{12}$ , where  $\mathbf{M}_{12} = \text{var } S(x^2 y)$ .

**Proposition 6.13** (Gusev and Lee [28]). *The lattice  $L(\mathbf{M}_{12} \vee \overleftarrow{\mathbf{M}}_{12})$  is modular but not distributive; see Fig. 11.*

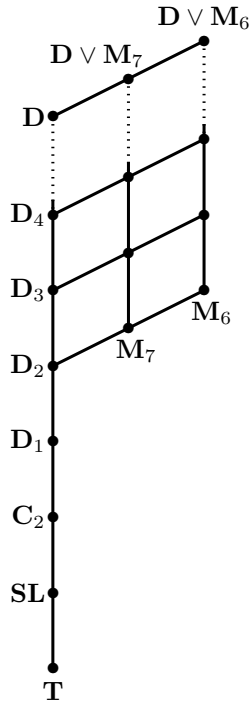

FIGURE 10. The lattice  $L(\mathbf{D} \vee \mathbf{M}_6)$

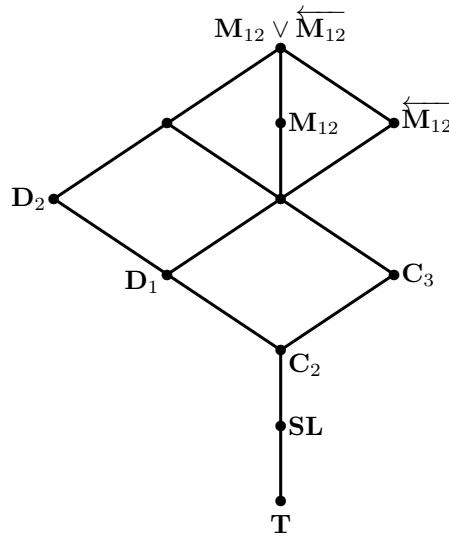

FIGURE 11. The lattice  $L(\mathbf{M}_{12} \vee \overleftarrow{\mathbf{M}}_{12})$

**6.4. Other identities and related restrictions.** Besides the distributive and modular laws, another important lattice identity is the Arguesian law; see Grätzer [18, Subsection V.4.4], for instance. It is general knowledge that any Arguesian lattice is modular but the converse is false. For subvariety lattices of semigroup varieties, the properties of being modular and Arguesian are equivalent [86, Theorem 11.2]. However, it is unknown if the same holds true for subvariety lattices of monoid varieties.

**Question 6.14.** Is there a variety of monoids whose subvariety lattice is modular but not Arguesian?

The following result concerning a variety  $\mathbf{X}$  and its greatest group subvariety  $\text{Gr}(\mathbf{X})$  can be deduced from Rasin [75, Corollary 5] and Proposition 2.1 or from Polák [72] and Proposition 5.3.

**Proposition 6.15.** *For any variety  $\mathbf{X}$  of orthodox completely regular monoids, the lattices  $L(\mathbf{X})$  and  $L(\text{Gr}(\mathbf{X}))$  satisfy the same non-trivial identities.*

It is unknown if Proposition 6.15 holds for other non-orthodox varieties.

**Question 6.16.** Is the analog of Proposition 6.15 true for arbitrary varieties of completely regular monoids?

In order to estimate the complexness of the class of monoid varieties whose subvariety lattice satisfies a non-trivial identity, it is useful to establish whether or not this class is closed under joins. The following question is presently open.

**Question 6.17.** Are there monoid varieties  $\mathbf{X}_1$  and  $\mathbf{X}_2$  such that each of the lattices  $L(\mathbf{X}_1)$  and  $L(\mathbf{X}_2)$  satisfies some non-trivial identity, while the lattice  $L(\mathbf{X}_1 \vee \mathbf{X}_2)$  does not satisfy any non-trivial identity?

For comparison, we note that the analogous question for semigroup varieties is answered in the affirmative. For instance, it is long known that the subvariety lattices of  $\mathbf{X}_1 = \text{var}_{\text{sem}} L_2^1$  and  $\mathbf{X}_2 = \text{var}_{\text{sem}} S(x)$  are distributive and of width two [15], but since the join  $\mathbf{X}_1 \vee \mathbf{X}_2$  is finitely universal [27, Subsection 6.3], its subvariety lattice does not satisfy any non-trivial identity.

Recall that a lattice  $\langle L; \vee, \wedge \rangle$  is

$$\begin{aligned} \text{upper semimodular if} \quad & \forall x, y \in L : x \text{ covers } x \wedge y \longrightarrow x \vee y \text{ covers } y; \\ \text{lower semimodular if} \quad & \forall x, y \in L : x \vee y \text{ covers } x \longrightarrow y \text{ covers } x \wedge y. \end{aligned}$$

The subvariety lattice of a semigroup variety is upper semimodular if and only if it is modular, while there is a semigroup variety whose subvariety lattice is lower semimodular but not modular; see Shevrin *et al.* [86, Subsection 11.3]. Analog of the latter claim for monoid varieties is true because the lattice  $L(\mathbf{M}_9)$  is lower semimodular but not modular; see Fig. 9. We do not know whether the analog of the former claim holds true or not.

**Question 6.18.** Is there a monoid variety whose subvariety lattice is upper semimodular but not modular?

A number of other restrictions to a subvariety lattice related to the subject matter of this section were considered for lattices of semigroup varieties with varying degrees of success. These restrictions include upper and lower semidistributivity, belonging to an arbitrary given quasi-variety of modular lattices or certain other lattice quasi-varieties, and the property of having width two; see Shevrin *et al.* [86, Section 11]. For monoid varieties, all these restrictions have not yet been considered in the literature.

## 7. FINITENESS CONDITIONS

As usual, by *finiteness condition* for lattices, we mean a lattice property that holds in every finite lattice. Some of the most important finiteness conditions on a lattice include the property of being finite, the ascending chain condition, and the descending chain condition. Another interesting finiteness condition is the property of having a *finite width* in the sense that all anti-chains in the lattice are finite. The investigation of varieties of semigroups or monoids with such restrictions on their subvariety lattices seems important and interesting, but it turns out to be very

difficult. As a result, for each of the above finiteness condition  $\theta$ , semigroup varieties whose subvariety lattice satisfies  $\theta$  have so far not been completely described. Moreover, all corresponding problems are very far from being completely solved, even modulo group varieties; see Shevrin *et al.* [86, Section 10].

Regarding subvariety lattices of monoid varieties, none of the aforementioned finiteness conditions has been systematically examined. For the finite width condition, not much is known beyond chain varieties. For the other three conditions—being finite and satisfying the ascending chain and descending chain conditions—only several examples are published and analogs of Proposition 6.15 can be easily deduced from known results. Since very few examples are available, we are able to describe them all in this section.

**7.1. Small varieties.** A variety of algebras with a finite subvariety lattice is said to be *small*. Small varieties of monoids have not yet been specifically studied. However, results of Rasin [75] and Proposition 2.1 (or results of Polák [72] and Proposition 5.3) imply the following result.

**Proposition 7.1.** *For any variety  $\mathbf{X}$  of orthodox completely regular monoids,  $\mathbf{X}$  is small if and only if  $\text{Gr}(\mathbf{X})$  is small and  $\text{BAND} \not\leq \mathbf{X}$ .*

It is unknown if Proposition 7.1 holds for other non-orthodox varieties.

**Question 7.2.** Is the analog of Proposition 7.1 true for arbitrary varieties of completely regular monoids?

A *Cross variety* is a variety that is finitely based, finitely generated, and small. Practically, all current information on small varieties outside the completely regular case is a certain number of examples obtained in the study of Cross varieties. Every finitely generated group variety is Cross [63], but the analog of this result does not hold for semigroup or monoid varieties; for instance, there exist finitely generated varieties of semigroups [91] and of monoids [42, 43] that are both non-finitely based and with uncountably many subvarieties.

Cross monoid varieties constitute an important subclass of the class of small monoid varieties. A non-Cross variety is *almost Cross* if all its proper subvarieties are Cross. It is natural to investigate almost Cross varieties since by Zorn's lemma, every non-Cross variety contains an almost Cross subvariety. Many articles are devoted to Cross or almost Cross monoid varieties. We will not survey all these works here since it is outside the scope of this survey. We restrict our attention to only articles in which the Cross or almost Cross property of a variety is established through a complete description of its subvariety lattice. Further, we will only exhibit here Cross varieties and almost Cross varieties that have not appeared above.

Most known examples of almost Cross monoid varieties arise in the study of *limit varieties*, that is, non-finitely based varieties whose proper subvarieties are all finitely based. It follows from Zorn's lemma that every non-finitely based variety contains a limit subvariety; this is a main motivation to study limit varieties.

By Theorem 2.7, there are uncountably many limit varieties of periodic groups. However, explicit examples of such varieties have not yet been found. Presently, up to duality, there are only five explicit examples of non-group limit varieties of monoids whose subvariety lattices are known. The first two of these five examples, due to Jackson [40], are the varieties  $\mathbf{M}_5$  and  $\mathbf{M}_7 \vee \overleftarrow{\mathbf{M}}_7$ ; their subvariety lattices can be found inside Figs. 5 and 7, respectively.

The third limit monoid variety, due to Zhang and Luo [103], is the variety  $\mathbf{M}_{13} \vee \overleftarrow{\mathbf{M}}_{13}$ , where  $\mathbf{M}_{13}$  is generated by the monoid  $S^1$  obtained from

$$S = \langle a, b, c \mid a^2 = a, b^2 = b, ab = ca = 0, ac = cb = c \rangle = \{a, b, c, ba, bc, 0\}.$$

The lattice  $L(\mathbf{M}_{13} \vee \overleftarrow{\mathbf{M}}_{13})$  is shown in Fig. 12; the undefined variety here is  $\mathbf{Q} = \text{var } Q^1$ , where

$$Q = \langle a, b, c \mid a^2 = a, ab = b, ca = c, ac = ba = cb = 0 \rangle = \{a, b, c, bc, 0\}.$$

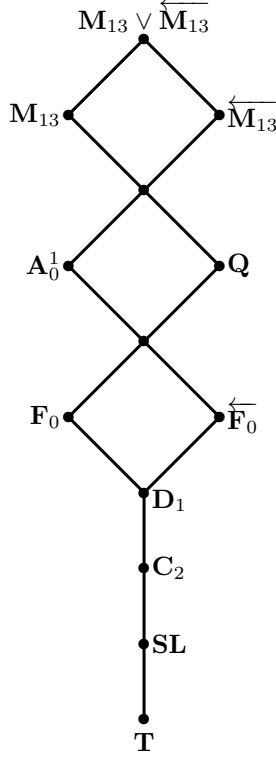

FIGURE 12. The lattice  $L(\mathbf{M}_{13} \vee \overleftarrow{\mathbf{M}}_{13})$

The fourth example of a limit monoid variety, constructed by Gusev [22], is

$$\mathbf{M}_{14} = \text{var} \left\{ \begin{array}{l} x^2 y^2 \approx y^2 x^2, \quad xyx \approx xyx^2, \quad xyzxy \approx yxzxy, \quad \left| \begin{array}{l} n \in \mathbb{N}, \\ \pi \in S_n \end{array} \right. \\ xyxztx \approx xyxzttx, \quad \mathbf{v}_n(\pi) \approx \mathbf{v}'_n(\pi) \end{array} \right\},$$

where

$$\mathbf{v}_n(\pi) = xz_{\pi(1)}z_{\pi(2)} \cdots z_{\pi(n)}x \left( \prod_{i=1}^n t_i z_i \right)$$

$$\text{and } \mathbf{v}'_n(\pi) = x^2 z_{\pi(1)}z_{\pi(2)} \cdots z_{\pi(n)} \left( \prod_{i=1}^n t_i z_i \right).$$

The lattice  $L(\mathbf{M}_{14})$  is shown in Fig. 13, where

$$\mathbf{M}_{15} = \mathbf{M}_{14} \wedge \text{var}\{\sigma_3\} \quad \text{and} \quad \mathbf{M}_{16} = \mathbf{M}_{14} \wedge \text{var}\{yx^2zy \approx yxzy\}.$$

Finite monoids that generate the variety  $\mathbf{M}_{14}$  and each of its subvarieties can be found in O. B. Sapir [80, Theorem 7.1].

Finally, the fifth limit monoid variety, due to Gusev and O. B. Sapir [30], is the variety  $\mathbf{M}_8$ ; the lattice  $L(\mathbf{M}_8)$  is shown in Fig. 8. A few more explicit examples of limit varieties of aperiodic monoids have recently been found [29, 81], but descriptions of their subvariety lattices are unknown.

The aforementioned examples of limit varieties play an important role in describing almost Cross varieties in some important classes of monoid varieties. For instance, the limit varieties  $\mathbf{M}_5$  and  $\mathbf{M}_7 \vee \overleftarrow{\mathbf{M}}_7$ , together with  $\mathbf{D}$ , are the only almost

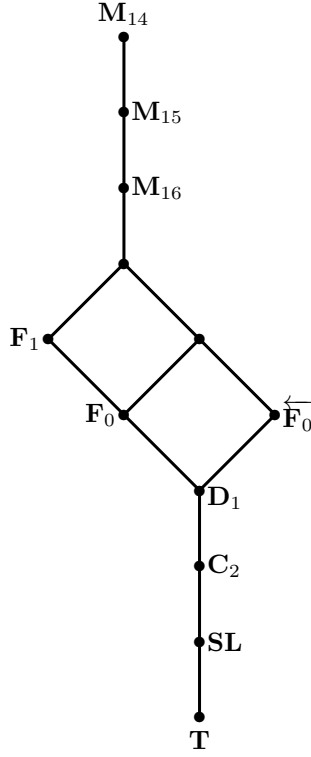

FIGURE 13. The lattice  $L(\mathbf{M}_{14})$

Cross varieties of aperiodic monoids with central idempotents [56]; this result was recently generalized to varieties of aperiodic monoids with commuting idempotents.

**Proposition 7.3** (Gusev [26]). *The varieties  $\mathbf{M}_5$ ,  $\mathbf{M}_7 \vee \overleftarrow{\mathbf{M}}_7$ ,  $\mathbf{M}_{14}$ ,  $\overleftarrow{\mathbf{M}}_{14}$ ,  $\mathbf{D}$ ,  $\mathbf{F}$ ,  $\overleftarrow{\mathbf{F}}$ ,*

$$\mathbf{Y} = \text{var}\{xyx \approx xyx^2, x^2y^2 \approx y^2x^2, xyzxy \approx yxzxy, x^2yzy \approx xyxzy \approx yx^2zy\},$$

*and  $\overleftarrow{\mathbf{Y}}$  are the only almost Cross varieties of aperiodic monoids with commuting idempotents.*

The lattice  $L(\mathbf{Y})$  is given in Fig. 14; the undefined varieties in this lattice are

$$\mathbf{Y}_n = \mathbf{Y} \wedge \text{var}\{xyt_1\mathbf{f}_1t_2\mathbf{f}_2 \cdots t_{n+1}\mathbf{f}_{n+1} \approx yxt_1\mathbf{f}_1t_2\mathbf{f}_2 \cdots t_{n+1}\mathbf{f}_{n+1}\},$$

where  $\mathbf{f}_{2i-1} = x$  and  $\mathbf{f}_{2i} = y$  for all  $i \in \mathbb{N}$  [26, Proposition 3.1].

One more countably infinite series of Cross monoid varieties,  $\mathbf{E}_n$  with  $n \in \mathbb{N}$ , and an almost Cross variety  $\mathbf{E}_\infty$  will be described in Subsection 7.2.

It is obvious that the class of small varieties of any algebras is closed under meets. In general, however, this class need not be closed under joins or covers. In particular, M. V. Sapir [78] has shown that the class of small semigroup varieties is closed under neither joins nor covers. The same result also holds for monoid varieties due to examples of Gusev [21] and Jackson and Lee [42].

**Proposition 7.4.** *The class of small monoid varieties is closed under neither joins nor covers.*

*Proof.* This class is not closed under joins because there exist pairs  $(\mathbf{X}_1, \mathbf{X}_2)$  of Cross varieties for which the join  $\mathbf{X}_1 \vee \mathbf{X}_2$  is non-small, for example,  $(\mathbf{M}_6, \overleftarrow{\mathbf{M}}_7)$  [21, Theorem 1.1(ii)],  $(\mathbf{C}_3, \mathbf{A}_0^1 \vee \mathbf{LRB} \vee \mathbf{RRB})$ , and  $(\mathbf{C}_3, \mathbf{G})$ , where  $\mathbf{G}$  is any finitely generated non-Abelian group variety [42, Subsection 3.2]. It is also not closed under

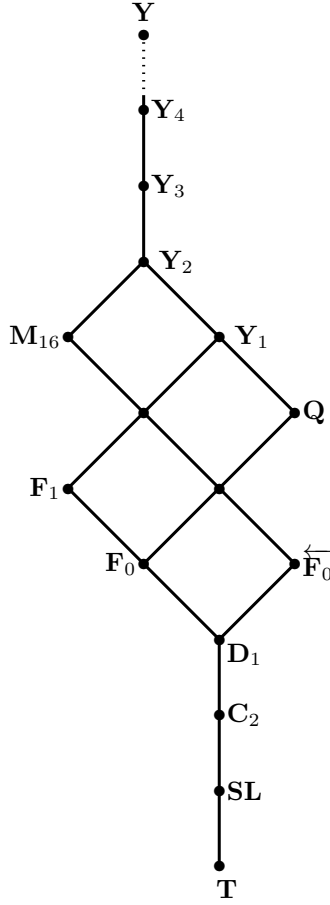
FIGURE 14. The lattice  $L(\mathbf{Y})$ 

covers since the Cross variety  $\mathbf{M}_6$  is covered by the non-small variety  $\mathbf{M}_6 \vee \overleftarrow{\mathbf{M}}_7$  [21, Theorem 1.1(i)]; see Fig. 7.  $\square$

It is of interest to note that each of the joins  $\mathbf{X}_1 \vee \mathbf{X}_2$  given in the proof of Proposition 7.4 has the extreme property of containing uncountably many subvarieties. Therefore the following question is relevant: are there two small semigroup varieties whose join contains uncountably many subvarieties? This question, first posed by Jackson [38, Question 3.15], remains open; it is one of only a few questions where the answer is known for monoid varieties but unknown for semigroup varieties. Another example will be given in Subsection 7.2.

**7.2. The ascending and descending chain conditions.** It is convenient to say that a variety  $\mathbf{X}$  *satisfies ACC* [respectively, *DCC*] if the lattice  $L(\mathbf{X})$  satisfies the ascending chain condition [respectively, descending chain condition].

First, we mention here two results that can be deduced from Rasin [75, Corollaries 7 and 8] and Proposition 2.1 (or from Polák [72] and Proposition 5.3).

**Proposition 7.5.** *For any variety  $\mathbf{X}$  of orthodox completely regular monoids,*

- a)  $\mathbf{X}$  *satisfies ACC if and only if*  $\text{Gr}(\mathbf{X})$  *satisfies ACC and*  $\mathbf{BAND} \not\subseteq \mathbf{X}$ ;
- b)  $\mathbf{X}$  *satisfies DCC if and only if*  $\text{Gr}(\mathbf{X})$  *satisfies DCC.*

It is unknown if Proposition 7.5 holds for other non-orthodox varieties.

**Question 7.6.** Is the analog of Proposition 7.5 true for arbitrary varieties of completely regular monoids?



We have little information about monoid varieties satisfying ACC or DCC outside the completely regular case. M. V. Sapir [78] demonstrated that the class of semigroup varieties that satisfy DCC is closed under neither joins nor covers. But whether or not the class of semigroup varieties that satisfy ACC is closed under joins or covers remains an open question [86, Question 10.2]. This is another question—after the one given at the end of Subsection 7.1—where the answer is unknown for semigroup varieties but known for monoid varieties.

**Proposition 7.7.** *The class of monoid varieties that satisfy ACC and the class of monoid varieties that satisfy DCC are closed under neither joins nor covers.*

*Proof.* These two classes are not closed under joins because for any of the explicit pairs  $(\mathbf{X}_1, \mathbf{X}_2)$  of Cross varieties given in the proof of Proposition 7.4, the join  $\mathbf{X}_1 \vee \mathbf{X}_2$  violates both ACC and DCC [21, 42]. The two classes are also not closed under covers because the Cross variety  $\mathbf{M}_6$  in Fig. 7 is covered by the variety  $\mathbf{M}_6 \vee \overleftarrow{\mathbf{M}}_7$  which violates both ACC and DCC; specifically, the subinterval  $[\mathbf{M}_7 \vee \overleftarrow{\mathbf{M}}_7, \mathbf{M}_6 \vee \overleftarrow{\mathbf{M}}_7]$  of  $L(\mathbf{M}_6 \vee \overleftarrow{\mathbf{M}}_7)$  violates the ascending and descending chain conditions [21].  $\square$

There exist monoid varieties that satisfy DCC but violate ACC, for example, **BAND**, **COM**, **D**, **F**, and **Y**; see Figs. 3, 5, and 14 and Theorem 5.1. These varieties are all non-finitely generated; a finitely generated example is the variety  $\mathbf{E} = \text{var } E^1$ , where

$$E = \langle a, b, c \mid a^2 = ab = 0, b^2 = bc = b, c^2 = cb = c, ba = ca = a \rangle = \{a, b, c, ac, 0\}.$$

The lattice  $L(\mathbf{E})$  is described in Jackson and Lee [42]; see Fig. 15. The undefined varieties in  $L(\mathbf{E})$  are

$$\mathbf{E}_n = \begin{cases} \mathbf{E} \wedge \text{var}\{\mathbf{e}_1 t_1 \mathbf{e}_2 t_2 \cdots \mathbf{e}_n t_n x^2 y^2 \approx \mathbf{e}_1 t_1 \mathbf{e}_2 t_2 \cdots \mathbf{e}_n t_n y^2 x^2\} & \text{if } n \in \mathbb{N}, \\ \mathbf{E} \wedge \text{var}\{x^2 y^2 t x^2 y^2 \approx x^2 y^2 t y^2 x^2\} & \text{if } n = \infty, \end{cases}$$

where  $\mathbf{e}_{2i-1} = x^2$  and  $\mathbf{e}_{2i} = y^2$  for all  $i \in \mathbb{N}$ .

The following question remains open.

**Question 7.8.** Is there a monoid variety that satisfies ACC but violates DCC?

Note that an example of a semigroup variety that satisfies ACC but violates DCC can be found in M. V. Sapir [78].

The following question was first posed in Aïzenštat and Boguta [2] and later repeated in Shevrin *et al.* [86, Question 10.3]: is there a non-small semigroup variety that satisfies both ACC and DCC? This question remains open so far, and it is natural to formulate it for monoid varieties.

**Question 7.9.** Is there a non-small monoid variety that satisfies both ACC and DCC?

## 8. OTHER RESTRICTIONS

In this section, we consider three different types of restrictions on a subvariety lattice of monoid varieties: decomposability into a direct product, self-duality, and complementability and related conditions. These properties have not yet been considered for monoid varieties, but substantial information—up to complete classification in some cases—easily follows from known results.

**8.1. Decomposability into a direct product.** A variety of algebras is *decomposable* if its subvariety lattice is decomposable into a direct product of non-singleton lattices. Decomposable varieties of semigroups were studied by Vernikov; see Shevrin *et al.* [86, Subsection 13.3].

Two varieties of algebras  $\mathbf{X}_1$  and  $\mathbf{X}_2$  of the same type are *disjoint* if  $\mathbf{X}_1 \wedge \mathbf{X}_2 = \mathbf{T}$ . Simple lattice-theoretic arguments show that if  $\langle L; \vee, \wedge \rangle$  is a modular, 0-distributive

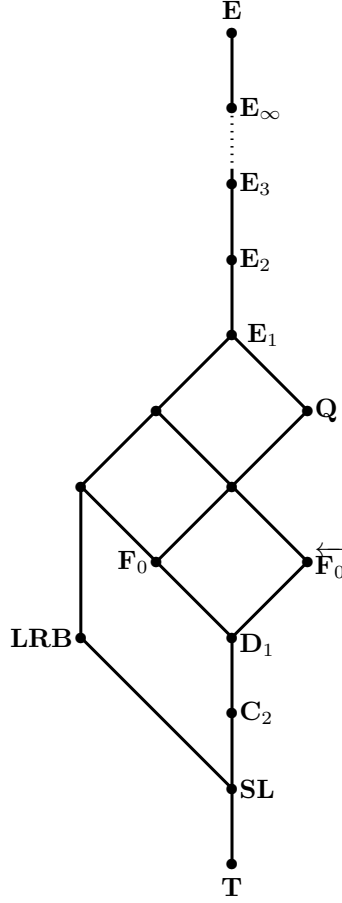
FIGURE 15. The lattice  $L(\mathbf{E})$ 

lattice and  $x, y \in L$  are such that  $x \wedge y = 0$ , then the interval  $[0, x \vee y]$  in  $L$  is isomorphic to the direct product of the intervals  $[0, x]$  and  $[0, y]$ . Combining this claim with Observation 2.4 and Proposition 5.6, we obtain the following result.

**Proposition 8.1.** *If  $\mathbf{V}$  is a completely regular monoid variety such that  $\mathbf{V} = \mathbf{X}_1 \vee \mathbf{X}_2$  for some disjoint varieties  $\mathbf{X}_1$  and  $\mathbf{X}_2$ , then  $L(\mathbf{V}) \cong L(\mathbf{X}_1) \times L(\mathbf{X}_2)$ . Therefore, a completely regular monoid variety is decomposable if and only if it is the join of two non-trivial disjoint varieties.*

Since the lattice  $\mathbb{C}\mathbb{R}_{\text{sem}}$  is modular and 0-distributive, the semigroup analog of Proposition 8.1 is valid as well.

Recall that Proposition 3.5 states that every completely regular monoid variety has an infinite number of covers in the lattice  $\mathbb{M}\mathbb{O}\mathbb{N}$ . We are now ready to provide a proof of this result.

*Proof of Proposition 3.5.* Let  $\mathbf{V}$  be any completely regular monoid variety. The join of an arbitrary infinite family of group atoms of  $\mathbb{M}\mathbb{O}\mathbb{N}$  equals  $\mathbf{C}\mathbf{O}\mathbf{M}$ . Therefore,  $\mathbf{V}$  contains only a finite number of varieties of the form  $\mathbf{A}_p$  with prime  $p$ . In other words, there is an infinite set  $\Pi$  of prime numbers such that  $\mathbf{A}_p \not\subseteq \mathbf{V}$  for any  $p \in \Pi$ . Now we can apply Observation 2.2 and Proposition 8.1 with the conclusion that  $\mathbf{V} \vee \mathbf{A}_p$  covers  $\mathbf{V}$  for any  $p \in \Pi$ .  $\square$

Some necessary conditions of decomposability can also be established for varieties of monoids that are not completely regular.

**Proposition 8.2.** *Suppose that  $\mathbf{V}$  is any non-completely regular monoid variety such that  $L(\mathbf{V}) \cong L(\mathbf{X}_1) \times L(\mathbf{X}_2)$  for some non-trivial subvarieties  $\mathbf{X}_1$  and  $\mathbf{X}_2$  of  $\mathbf{V}$ . Then either  $\mathbf{X}_1$  or  $\mathbf{X}_2$  equals  $\mathbf{A}_n$  for some  $n \geq 2$ .*

*Proof.* Clearly,  $\mathbf{X}_1$  and  $\mathbf{X}_2$  are disjoint. Further, since  $\mathbf{V}$  is not completely regular,  $\mathbf{C}_2 \subseteq \mathbf{V}$  by line 4 of Table 1. Since the lattice  $L(\mathbf{C}_2)$  has only one atom,  $\mathbf{C}_2$  is contained in either  $\mathbf{X}_1$  or  $\mathbf{X}_2$ , say, in  $\mathbf{X}_1$ . Then  $\mathbf{SL} \subset \mathbf{C}_2 \subseteq \mathbf{X}_1$ . It follows that  $\mathbf{SL} \not\subseteq \mathbf{X}_2$  because  $\mathbf{X}_1$  and  $\mathbf{X}_2$  are disjoint. Now we can apply line 3 of Table 1 and conclude that  $\mathbf{X}_2$  is a group variety. Suppose that  $\mathbf{X}_2$  is non-Abelian. Then  $\mathbf{D}_1 \subset \mathbf{C}_2 \vee \mathbf{X}_2$  [20, Lemma 3.1], whence  $\mathbf{D}_1 \vee \mathbf{X}_2 \subseteq \mathbf{C}_2 \vee \mathbf{X}_2$ ; the reverse inclusion is evident, so that  $\mathbf{D}_1 \vee \mathbf{X}_2 = \mathbf{C}_2 \vee \mathbf{X}_2$ . Since the lattice  $L(\mathbf{D}_1)$  has only one atom (see Fig. 5), the inclusion  $\mathbf{D}_1 \subseteq \mathbf{X}_1$  follows. We see that  $\mathbf{C}_2 \subset \mathbf{D}_1 \subseteq \mathbf{X}_1$  but  $\mathbf{C}_2 \vee \mathbf{X}_2 = \mathbf{D}_1 \vee \mathbf{X}_2$ . This contradicts the claim that  $L(\mathbf{V}) \cong L(\mathbf{X}_1) \times L(\mathbf{X}_2)$ . Consequently,  $\mathbf{X}_2$  is an Abelian group variety, that is,  $\mathbf{X}_2 = \mathbf{A}_n$  for some  $n \geq 2$ .  $\square$

**Proposition 8.3.** *Let  $\mathbf{V}$  be an aperiodic monoid variety with a unique cover  $\mathbf{U}$  in  $\text{MON}$  such that  $\mathbf{U}$  is a meet of all varieties that properly contain  $\mathbf{V}$ . If a monoid variety  $\mathbf{W}$  is decomposable, then  $\mathbf{V} \not\subseteq \mathbf{W}$ .*

*Proof.* By Proposition 3.5, the variety  $\mathbf{V}$  is not completely regular. Suppose that  $\mathbf{W}$  is decomposable and  $\mathbf{V} \subseteq \mathbf{W}$ . Then  $\mathbf{W}$  is not completely regular too. According to Proposition 8.2,  $L(\mathbf{W}) \cong L(\mathbf{X}) \times L(\mathbf{A}_n)$  for some subvariety  $\mathbf{X}$  of  $\mathbf{W}$  and some  $n \geq 2$  such that  $\mathbf{A}_n \subseteq \mathbf{W}$ . Since  $\mathbf{U}$  is a meet of all subvarieties of  $\mathbf{X}$  that properly contain  $\mathbf{V}$  and maximal aperiodic monoid varieties do not exist, the variety  $\mathbf{U}$  is aperiodic. Hence  $\mathbf{U} \not\subseteq \mathbf{A}_n$ . On the other hand,  $\mathbf{U} \subset \mathbf{V} \vee \mathbf{A}_n$  by the choice of  $\mathbf{U}$ , which implies that  $\mathbf{U} \vee \mathbf{A}_n \subseteq \mathbf{V} \vee \mathbf{A}_n$ . The reverse inclusion is evident, thus  $\mathbf{U} \vee \mathbf{A}_n = \mathbf{V} \vee \mathbf{A}_n$ . Since  $\mathbf{U}$  is aperiodic, the lattice  $L(\mathbf{U})$  has only one atom, whence  $\mathbf{U} \subseteq \mathbf{X}$ . We see that  $\mathbf{V} \subset \mathbf{U} \subseteq \mathbf{X}$  but  $\mathbf{V} \vee \mathbf{A}_n = \mathbf{U} \vee \mathbf{A}_n$ . This contradicts the claim that  $L(\mathbf{W}) \cong L(\mathbf{X}) \times L(\mathbf{A}_n)$ .  $\square$

In particular, Propositions 3.7 and 8.3 and Remark 3.8 imply the following result.

**Remark 8.4.** *Every decomposable monoid variety does not contain any of the varieties  $\mathbf{M}_2$  and  $\mathbf{N}_k$  for any  $k \in \mathbb{N}$ .*

In view of Proposition 8.2, if  $\mathbf{V}$  is a non-completely regular decomposable monoid variety, then  $\mathbf{V} = \mathbf{A}_n \vee \mathbf{X}$  for some  $n \geq 2$  and  $\mathbf{X} \subseteq \mathbf{V}$  such that  $\mathbf{A}_n \wedge \mathbf{X} = \mathbf{T}$ . To describe all decomposable varieties, it is natural to first of all consider the case when the variety  $\mathbf{X}$  is aperiodic. This leads to the following problem which seems to be very difficult.

**Problem 8.5.** Let  $n \geq 2$ . Describe all aperiodic monoid varieties  $\mathbf{X}$  such that  $L(\mathbf{A}_n \vee \mathbf{X}) \cong L(\mathbf{A}_n) \times L(\mathbf{X})$ .

Remark 8.4 shows that there are aperiodic varieties  $\mathbf{X}$  that do not satisfy the property indicated in Problem 8.5. A weakened variant of this problem (Problem 8.10) will be posed in Subsection 8.2.

**8.2. Hereditarily selfdual varieties.** A variety of algebras is *selfdual* if it has a selfdual subvariety lattice. Natural examples of selfdual varieties are small chain varieties. It is clear from Figs. 13 and 14 that  $\mathbf{M}_{14}$ ,  $\mathbf{Y}_5$ , and the varieties dual to them are selfdual.

**Proposition 8.6.**

- a) A commutative monoid variety  $\mathbf{V}$  is selfdual if and only if  $\mathbf{V} \neq \mathbf{COM}$ .
- b) A variety of band monoids is selfdual if and only if it coincides with  $\mathbf{T}$ ,  $\mathbf{SL}$ ,  $\mathbf{B}_k$ , or  $\overline{\mathbf{B}}_k$  for some  $k \geq 2$ .

Parts a) and b) of this proposition follow from Theorems 5.1 and 5.2, respectively.

The problem of describing selfdual varieties of semigroups or monoids is very difficult and has not received much attention. One approach to the problem is to consider a stronger property: a variety of algebras is *hereditarily selfdual* if all its subvarieties are selfdual. Hereditarily selfdual varieties of semigroups, modulo chain group varieties, were described by Vernikov [94, Theorem 1].

Being hereditarily selfdual is quite a strong restriction on a variety, but varieties with this property is of some interest. Indeed, as we will see below, hereditarily selfdual varieties of monoids (and as well as semigroups) occupy an intermediate position between the fully studied class of small chain varieties (see Theorem 6.1 and Fig. 5) and the class of varieties with a distributive subvariety lattice, which is still far from completely classified (see Subsection 6.3). Thus, the investigation of hereditarily selfdual varieties of monoids can be considered an intermediate step in the study of monoid varieties with a distributive lattice of subvarieties.

It is evident that every small chain variety of any algebras is hereditarily selfdual. The following assertion shows that, in a large class of varieties of algebras that includes both semigroup varieties and monoid ones, the consideration of hereditarily selfdual varieties is reduced, in a sense, to the problem of “interaction” between small chain varieties.

**Proposition 8.7** (Vernikov [94, Proposition 2]). *Suppose that  $\mathbf{V}$  is any variety of algebras such that any two different atoms in the lattice  $L(\mathbf{V})$  are covered by their join. Then  $\mathbf{V}$  is hereditarily selfdual if and only if  $L(\mathbf{V})$  is a direct product of a finite number of finite chains.*

In particular, if a hereditarily selfdual variety  $\mathbf{V}$  satisfies the hypothesis of Proposition 8.7, then the lattice  $L(\mathbf{V})$  is distributive.

The fact that any two different atoms of  $\mathbf{MON}$  are covered by their join follows from Observation 2.2 and Proposition 8.1.

Proposition 8.6 immediately implies that a commutative monoid variety  $\mathbf{V}$  is hereditarily selfdual if and only if  $\mathbf{V} \neq \mathbf{COM}$ . A description of hereditarily selfdual completely regular monoid varieties modulo chain group varieties follows from Propositions 8.1 and 8.7 and Theorem 6.1.

**Proposition 8.8.** *A completely regular monoid variety  $\mathbf{V}$  is hereditarily selfdual if and only if  $\mathbf{V} = \mathbf{G}_1 \vee \mathbf{G}_2 \vee \cdots \vee \mathbf{G}_k \vee \mathbf{X}$  for some pairwise disjoint small chain group varieties  $\mathbf{G}_1, \mathbf{G}_2, \dots, \mathbf{G}_k$  and some  $\mathbf{X} \in \{\mathbf{T}, \mathbf{SL}, \mathbf{LRB}, \mathbf{RRB}\}$ .*

As for hereditarily selfdual monoid varieties that are not completely regular, combining Proposition 8.7 with line 4 of Table 1 and Proposition 8.2, we obtain the following necessary condition.

**Proposition 8.9.** *Suppose that  $\mathbf{V}$  is any non-completely regular monoid variety that is hereditarily selfdual. Then  $\mathbf{V} = \mathbf{A}_n \vee \mathbf{X}$  for some  $n \in \mathbb{N}$  and small chain variety  $\mathbf{X}$  such that  $\mathbf{C}_2 \subseteq \mathbf{X}$ .*

We note that by Proposition 8.6, the variety  $\mathbf{A}_n \vee \mathbf{C}_k$  is hereditarily selfdual for any  $n, k \in \mathbb{N}$ . In view of Proposition 8.9, the problem of completely classifying hereditarily selfdual monoid varieties modulo chain group varieties is equivalent to the following problem.

**Problem 8.10.** Find all non-group small chain varieties of monoids  $\mathbf{X}$  such that  $L(\mathbf{A}_n \vee \mathbf{X}) \cong L(\mathbf{A}_n) \times L(\mathbf{X})$  for any  $n \geq 2$ .

In view of Proposition 8.6 and Fig. 5, to solve this problem, it suffices to consider the cases when a small chain variety  $\mathbf{X}$  contains  $\mathbf{D}_1$  and is contained in one of the following varieties:  $\mathbf{D}$ ,  $\mathbf{F}$ ,  $\mathbf{M}_5$ , and  $\mathbf{M}_6$ .

**8.3. Complementability and related properties.** A lattice  $\langle L; \vee, \wedge \rangle$  with 0 and 1 is a *lattice with upper semicomplements* if, for any  $x \in L \setminus \{0\}$ , there exists some  $y \in L \setminus \{1\}$  such that  $x \vee y = 1$ .

**Theorem 8.11.** *For any variety  $\mathbf{V}$  of monoids, the following are equivalent:*

- a)  $L(\mathbf{V})$  is a lattice with upper semicomplements;
- b)  $L(\mathbf{V})$  is a lattice with complements;
- c)  $L(\mathbf{V})$  is a finite Boolean algebra;
- d)  $\mathbf{V}$  is the join of a finite number of atoms of the lattice  $\mathbf{MON}$ .

For convenience of references, we formulate the following result which immediately follows from the main result of Vernikov and Volkov [98].

**Lemma 8.12.** *Conditions b)–d) of Theorem 8.11 are equivalent for any variety  $\mathbf{V}$  of groups.*

*Proof of Theorem 8.11.* By Dierks *et al.* [13, Corollary 1], conditions a) and b) are equivalent for varieties of arbitrary algebras.<sup>1</sup> Since the implication c)  $\rightarrow$  d) is evident, it remains to verify the implications b)  $\rightarrow$  c) and d)  $\rightarrow$  b).

b)  $\rightarrow$  c) If  $\mathbf{V} \not\supseteq \mathbf{SL}$ , then  $\mathbf{V}$  is a group variety by line 3 of Table 1, whence  $L(\mathbf{V})$  is a finite Boolean algebra by Lemma 8.12. Therefore, assume that  $\mathbf{V} \supseteq \mathbf{SL}$ . Let  $\mathbf{U}$  be the complement of  $\mathbf{SL}$  in  $L(\mathbf{V})$ . Then  $\mathbf{U}$  is a group variety. Since  $\mathbf{V} = \mathbf{U} \vee \mathbf{SL}$ , Proposition 8.1 implies that  $L(\mathbf{V})$  is a direct product of  $L(\mathbf{U})$  and the 2-element chain  $L(\mathbf{SL})$ . If a subvariety  $\mathbf{X}$  of  $\mathbf{U}$  has no complements in  $L(\mathbf{U})$ , then the variety  $\mathbf{X} \vee \mathbf{SL}$  has no complements in  $L(\mathbf{V})$ . Therefore,  $L(\mathbf{U})$  is a lattice with complements. Then  $L(\mathbf{U})$  is a finite Boolean algebra by Lemma 8.12, whence  $L(\mathbf{V})$  is a finite Boolean algebra too.

d)  $\rightarrow$  b) Let  $\mathbf{V} = \bigvee_{i=1}^n \mathbf{X}_i$ , where  $\mathbf{X}_1, \mathbf{X}_2, \dots, \mathbf{X}_n$  are distinct atoms of the lattice  $\mathbf{MON}$ . If  $\mathbf{X}_1, \mathbf{X}_2, \dots, \mathbf{X}_n$  are group varieties, then it suffices to refer to Lemma 8.12. Suppose now that one of the varieties  $\mathbf{X}_1, \mathbf{X}_2, \dots, \mathbf{X}_n$ , say  $\mathbf{X}_n$ , coincides with  $\mathbf{SL}$ . Then  $\mathbf{U} = \bigvee_{i=1}^{n-1} \mathbf{X}_i$  is a group variety with  $\mathbf{V} = \mathbf{U} \vee \mathbf{SL}$ . As in the previous paragraph, Proposition 8.1 implies that  $L(\mathbf{V})$  is a direct product of  $L(\mathbf{U})$  and the 2-element chain  $L(\mathbf{SL})$ . By Lemma 8.12, the lattice  $L(\mathbf{U})$  has complements, so that the lattice  $L(\mathbf{V})$  also has complements.  $\square$

In view of Observation 2.2, Theorem 8.11 gives a complete classification of monoid varieties that possess the properties in a)–c), as well as all standard stronger versions of complementability, such as relative complementness, uniqueness of complements, etc.

One can note that the exact analog of Theorem 8.11 is true for semigroup varieties; see Shevrin *et al.* [86, Theorem 13.1] or Vernikov and Volkov [98, Proposition 1] and Dierks *et al.* [13, Corollary 1]. This is one of the few cases when the properties of the lattices  $\mathbf{SEM}$  and  $\mathbf{MON}$  completely coincide, and this coincidence is not a consequence of Proposition 2.1; other examples of the same type are given by Proposition 8.7 or by Proposition 8.1 and its semigroup analog.

The lattice property of having *lower semicomplements*—a property dual to having upper semicomplements—is not interesting for varietal lattices since by very simple lattice-theoretical arguments, a complete atomic lattice is a lattice with lower semicomplements if and only if its greatest element is the join of all its atoms. This fact and Theorem 8.11 immediately imply the following result.

**Observation 8.13.** *The subvariety lattice of a monoid variety  $\mathbf{V}$  is a lattice with lower semicomplements if and only if either  $L(\mathbf{V})$  is a lattice with complements or  $\mathbf{V} = \mathbf{COM}$ .*

<sup>1</sup>Before the publication of Dierks *et al.* [13], Vernikov [95, Theorem 1(f)] proved that a) and b) are equivalent for varieties of algebras with a 0-distributive subvariety lattice. In view of Observation 2.4, this implies the equivalence of these two claims for monoid varieties.

The exact semigroup analog of this result does not hold because the lattice  $\mathbf{SEM}$  contains non-commutative atoms, namely the varieties  $\mathbf{LZ}$  and  $\mathbf{RZ}$ . To obtain such an analog, one should change the equality  $\mathbf{V} = \mathbf{COM}$  to  $\mathbf{V} = \mathbf{COM} \vee \mathbf{X}$ , where  $\mathbf{X}$  is any of the following varieties:  $\mathbf{T}$ ,  $\mathbf{LZ}$ ,  $\mathbf{RZ}$ , and  $\mathbf{LZ} \vee \mathbf{RZ}$ .

### Part 3. Distinctive elements in $\mathbf{MON}$

#### 9. SPECIAL ELEMENTS

**9.1. Concrete types of special elements.** In lattice theory, considerable attention is given to the study of so-called special elements of different types. We will mention nine types of special elements: neutral, standard, costandard, distributive, codistributive, cancellable, modular, lower-modular, and upper-modular elements. Neutral elements were defined in Subsection 5.3. Note that an element  $x$  in a lattice  $\langle L; \vee, \wedge \rangle$  is neutral if and only if, for all  $y, z \in L$ , the sublattice of  $L$  generated by  $x, y$ , and  $z$  is distributive; see Grätzer [18, Theorem 254], for instance. An element  $x \in L$  is

<i>standard</i> if	$\forall y, z \in L : (x \vee y) \wedge z = (x \wedge z) \vee (y \wedge z);$
<i>distributive</i> if	$\forall y, z \in L : x \vee (y \wedge z) = (x \vee y) \wedge (x \vee z);$
<i>cancellable</i> if	$\forall y, z \in L : x \vee y = x \vee z \ \& \ x \wedge y = x \wedge z \longrightarrow y = z;$
<i>modular</i> if	$\forall y, z \in L : y \leq z \longrightarrow (x \vee y) \wedge z = (x \wedge z) \vee y;$
<i>lower-modular</i> if	$\forall y, z \in L : x \leq y \longrightarrow x \vee (y \wedge z) = y \wedge (x \vee z).$

*Costandard*, *codistributive*, and *upper-modular* elements are defined dually to standard, distributive, and lower-modular ones, respectively.<sup>2</sup> Significant information about special elements in a lattice can be found in Grätzer [18, Section III.2] or Stern [87, Sections 2.1 and 2.2], for instance.

There exist several interrelations between the different types of elements defined above. It is evident that a neutral element is both standard and costandard, a [co]standard element is cancellable, a cancellable element is modular, and a [co]distributive element is lower-modular [respectively, upper-modular]. It is also well known that a [co]standard element is [co]distributive; see Grätzer [18, Theorem 253], for instance. A summary of these interrelations is given in Fig. 16.

Over the past 15 years, a number of articles were devoted to the examination of elements of the aforementioned types in the lattice  $\mathbf{SEM}$  and some of its sublattices, such as  $\mathbf{COM}_{\mathbf{sem}}$  and  $\mathbf{OC}_{\mathbf{sem}}$ . Initial results were overviewed in Shevrin *et al.* [86, Section 14]. Significantly more results were systematized in a more recent survey by Vernikov [97] devoted entirely to the problems under discussion. Results concerning the lattice  $\mathbf{SEM}$  that were in this survey or obtained later can be briefly summarized as follows. Six types of elements in  $\mathbf{SEM}$ —neutral, standard, costandard, distributive, cancellable, and lower-modular—have been completely determined. For codistributive, modular, and upper-modular elements in  $\mathbf{SEM}$ , strong necessary conditions and descriptions in wide and important partial cases have been found. For modular elements, a non-trivial sufficient condition is known too. Further, some interrelations between special elements of different types in  $\mathbf{SEM}$  that do not hold in abstract lattices have also been found; specifically, for any variety  $\mathbf{X}$  of semigroups,  $\mathbf{X}$  is standard if and only if  $\mathbf{X}$  is distributive,  $\mathbf{X}$  is costandard if and only if  $\mathbf{X}$  is neutral, and  $\mathbf{X}$  is modular whenever  $\mathbf{X}$  is lower-modular. For

<sup>2</sup>Modular, upper-modular, lower-modular, and cancellable elements are named differently in a number of works. In particular, modular [respectively, upper-modular, cancellable] elements are called left modular [respectively, right modular, separating] in Stern [87]. The term “modular element” is used in the literature not only in the sense defined above but also in a number of other ways.

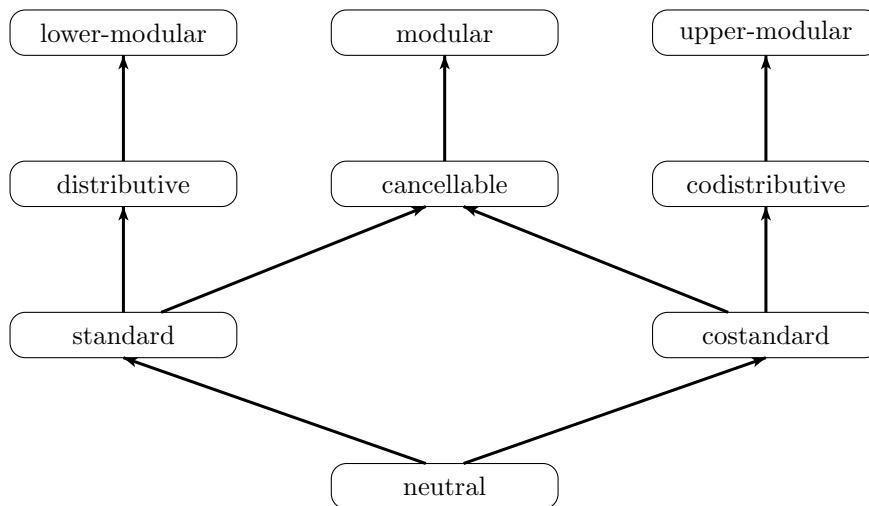

FIGURE 16. Interrelations between types of special elements in lattices

a description of all cancellable elements in  $\mathbf{SEM}$ , see Shaprynskii *et al.* [85, Theorem 1.1]; results on other special elements described in this paragraph can be found in Vernikov [97, Section 3].

Regarding special elements in the lattice  $\mathbf{MON}$ , not much is known until recently, when some significant progress has been made [20, 23, 24, 28]. To date, the exact six types of special elements—neutral, standard, costandard, distributive, cancellable, and lower-modular—are completely described in the lattice  $\mathbf{MON}$  as in the lattice  $\mathbf{SEM}$ . However, as we will see below, the interrelations between the types of special elements in the lattices  $\mathbf{MON}$  and  $\mathbf{SEM}$  differ drastically. The aforementioned classifications of the six types of special elements are summarized in the following three theorems.

**Theorem 9.1** (Gusev [20, 23, 24]). *For any monoid variety  $\mathbf{V}$ , the following are equivalent:*

- a)  $\mathbf{V}$  is a lower-modular element in  $\mathbf{MON}$ ;
- b)  $\mathbf{V}$  is a distributive element in  $\mathbf{MON}$ ;
- c)  $\mathbf{V}$  is a standard element in  $\mathbf{MON}$ ;
- d)  $\mathbf{V}$  is a neutral element in  $\mathbf{MON}$ ;
- e)  $\mathbf{V}$  coincides with  $\mathbf{T}$ ,  $\mathbf{SL}$ , or  $\mathbf{MON}$ .

Specifically, the equivalences d)  $\leftrightarrow$  e), c)  $\leftrightarrow$  e), and a)  $\leftrightarrow$  b)  $\leftrightarrow$  e) were established in the articles [20, 23, 24], respectively.

The number of neutral elements of a lattice can be considered as a kind of measure of its complexity. The least and the greatest elements of any lattice  $L$ , if they exist, are neutral in  $L$ . The existence of a unique neutral element of the lattice  $\mathbf{MON}$  that is different from  $\mathbf{T}$  and  $\mathbf{MON}$  once again demonstrates how complex this lattice is. For comparison, we note that the lattice  $\mathbf{SEM}$  contains exactly three neutral elements that are different from  $\mathbf{T}$  and  $\mathbf{SEM}$ : the variety  $\mathbf{SL}_{\mathbf{sem}}$  of semilattices, the variety  $\mathbf{ZM}$  of semigroups with zero multiplication, and their join  $\mathbf{SL}_{\mathbf{sem}} \vee \mathbf{ZM}$ ; see Shevrin *et al.* [86, Theorem 14.2] or Vernikov [97, Theorem 3.4]. We note also that the lattice  $\mathbf{CR}$  has infinitely many neutral elements; in particular, it follows from Trotter [92] and Proposition 5.3 that every variety of band monoids is neutral in  $\mathbf{CR}$ .

The four types of special elements in Theorem 9.1a)–d) coincide in the lattice  $\mathbf{MON}$ , and there are only three of them:  $\mathbf{T}$ ,  $\mathbf{SL}$ , and  $\mathbf{MON}$ . This differs sharply

from the situation with the lattice  $\mathbb{SEM}$ , where the set of all lower-modular elements of  $\mathbb{SEM}$  is uncountably infinite, the set of all standard elements of  $\mathbb{SEM}$  is countably infinite, and the set of all neutral elements of  $\mathbb{SEM}$  is finite [97, Theorems 3.2–3.4]. Further, an element of  $\mathbb{SEM}$  is standard if and only if it is distributive [97, Theorem 3.3].

**Theorem 9.2** (Gusev [20, Theorem 1.2]). *For any monoid variety  $\mathbf{V}$ , the following are equivalent:*

- a)  $\mathbf{V}$  is a modular and upper-modular element in  $\mathbb{MON}$ ;
- b)  $\mathbf{V}$  is a costandard element in  $\mathbb{MON}$ ;
- c)  $\mathbf{V}$  is one of the varieties  $\mathbf{T}$ ,  $\mathbf{SL}$ ,  $\mathbf{C}_2$ , or  $\mathbf{MON}$ .

Contrary to the semigroup case, we see from Theorems 9.1 and 9.2 that for elements in the lattice  $\mathbb{MON}$ , the properties of being neutral and costandard are not equivalent, while the properties of being neutral and standard are equivalent. Besides that, Theorems 9.1 and 9.2 imply that any standard element of  $\mathbb{MON}$  is costandard but the converse does not hold. In contrast, in the lattice  $\mathbb{SEM}$ , any costandard element is standard but the converse is false; see Vernikov [97, Theorems 3.3 and 3.4].

**Theorem 9.3** (Gusev and Lee [28]). *A monoid variety is a cancellable element of the lattice  $\mathbb{MON}$  if and only if it coincides with  $\mathbf{T}$ ,  $\mathbf{SL}$ ,  $\mathbf{C}_2$ ,  $\mathbf{D}_1$ , or  $\mathbf{MON}$ .*

Theorem 9.3 shows that there are only five cancellable elements in the lattice  $\mathbb{MON}$ . In contrast, the set of all cancellable elements of the lattice  $\mathbb{SEM}$  is countably infinite [85, Theorem 1.1].

Some results on upper-modular elements and codistributive elements of  $\mathbb{MON}$  are also available.

**Proposition 9.4** (Gusev [20, Propositions 1.3 and 1.4]).

- a) *Every proper monoid variety that is an upper-modular element of the lattice  $\mathbb{MON}$  is either commutative or completely regular.*
- b) *Every commutative monoid variety is a codistributive element of the lattice  $\mathbb{MON}$ .*

Since any codistributive element of a lattice is upper-modular, Proposition 9.4 completely reduces the problem of describing codistributive or upper-modular elements in  $\mathbb{MON}$  to completely regular varieties.

However, there are some essential difficulties here. The lattice  $\mathbb{GR}$  is modular but not distributive. Therefore, it contains a sublattice isomorphic to the 5-element modular non-distributive lattice  $L_5$  in Fig. 17. Clearly, if a group variety  $\mathbf{G}$  is one of three pairwise non-comparable elements  $a, b, c \in L_5$ , then  $\mathbf{G}$  is a non-codistributive element of  $\mathbb{MON}$ . We see that an examination of codistributive elements of  $\mathbb{MON}$  is closely related to that of group varieties with a distributive subvariety lattice, but as observed earlier, classifying such group varieties is extremely difficult; see Theorem 2.7. Therefore, it is logical to restrict our attention to codistributive elements of  $\mathbb{MON}$  that are aperiodic varieties. Combining this restriction with the observation from the previous paragraph, it suffices to examine varieties of band monoids that are codistributive elements of  $\mathbb{MON}$ . But to date, we do not even know the answer to the following question.

**Question 9.5.** Is there a variety of band monoids that is a non-codistributive element of the lattice  $\mathbb{MON}$ ?

In other words, is there a variety  $\mathbf{B}$  of band monoids such that the equality

$$\mathbf{B} \wedge (\mathbf{X}_1 \vee \mathbf{X}_2) = (\mathbf{B} \wedge \mathbf{X}_1) \vee (\mathbf{B} \wedge \mathbf{X}_2)$$

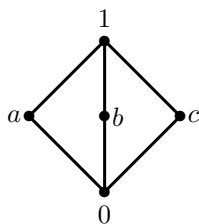

FIGURE 17. The lattice  $L_5$ 

fails for some monoid varieties  $\mathbf{X}_1$  and  $\mathbf{X}_2$ ? It follows from Pastijn and Trotter [66, Corollary 5.9] and Proposition 2.1 that this equality holds whenever the varieties  $\mathbf{X}_1$  and  $\mathbf{X}_2$  both are locally finite.

The following analog of Question 9.5 is also open.

**Question 9.6.** Is there a variety of band monoids that is a non-upper-modular element of the lattice  $\mathbf{MON}$ ?

Note that the analogs of Questions 9.5 and 9.6 for semigroup varieties are also currently open. Besides that, we do not know of examples of upper-modular but non-codistributive elements of  $\mathbf{MON}$ . This makes the following question relevant.

**Question 9.7.** Is every upper-modular element of  $\mathbf{MON}$  codistributive?

Regarding the modularity of an element in  $\mathbf{MON}$ , a necessary condition has recently been found.

**Proposition 9.8** (Gusev and Lee [28, Proposition 4.3]). *Every proper monoid variety that is a modular element of the lattice  $\mathbf{MON}$  satisfies the identities  $x^2 \approx x^3$  and  $x^2y \approx yx^2$ .*

However, no modular element of  $\mathbf{MON}$  is currently known to be non-cancellable.

**Question 9.9.** Is every modular element of  $\mathbf{MON}$  cancellable?

We summarize in Fig. 18 all known interrelations between different types of elements in the lattice  $\mathbf{MON}$ . Dashed arrows in this figure correspond to interrelations for which it is unknown whether they hold or not. Green ovals correspond to completely described types of elements, while yellow ovals correspond to those about which partial information is known.

**9.2. Id-elements.** All types of special elements introduced above, except cancellable elements, are defined by the same scheme. Namely, we take a particular lattice identity and consider it as an open formula. Then, one of the letters is left free while all the others are subjected to a universal quantifier.<sup>3</sup> This approach can easily be generalized in a natural way to an arbitrary lattice identity.

Let  $\varepsilon$  be a lattice identity of the form  $\mathbf{s} \approx \mathbf{t}$ , where  $\mathbf{s}$  and  $\mathbf{t}$  are terms in the language of lattice operations  $\vee$  and  $\wedge$ . Suppose that these terms depend on letters  $x_1, \dots, x_n$  and  $1 \leq i \leq n$ . Then an element  $x$  of a lattice  $L$  is an  $(\varepsilon, i)$ -element of  $L$  if for all  $x_1, \dots, x_{i-1}, x_{i+1}, \dots, x_n \in L$ , the equality

$$\mathbf{s}(x_1, \dots, x_{i-1}, x, x_{i+1}, \dots, x_n) = \mathbf{t}(x_1, \dots, x_{i-1}, x, x_{i+1}, \dots, x_n)$$

holds. An element of a lattice  $L$  is an *Id-element* of  $L$  if it is an  $(\varepsilon, i)$ -element of  $L$  for some non-trivial identity  $\varepsilon$  depending on letters  $x_1, \dots, x_n$  with  $1 \leq i \leq n$ .

<sup>3</sup>Formally speaking, the definitions of modular, lower-modular, and upper-modular elements are based on a lattice quasi-identity rather than an identity. But we give such definitions for the sake of brevity only. Since the modularity law may be written as an identity, it is fairly easy to redefine these types of elements in the language of lattice identities.

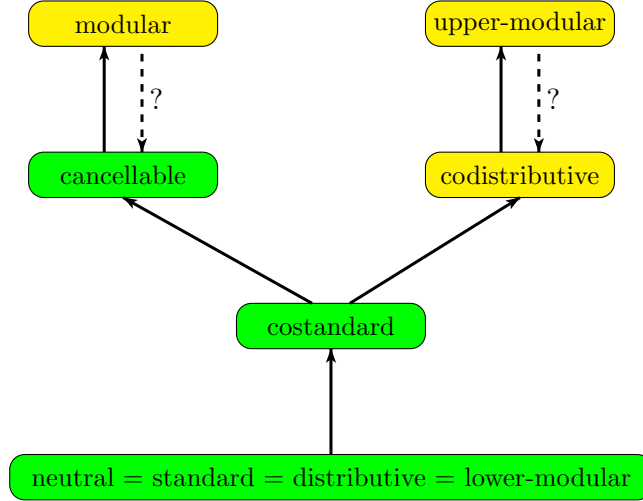
FIGURE 18. Interrelations between types of elements in the lattice  $\text{MON}$ 

For an element  $a$  of a lattice  $L$ , we put  $(a) = \{x \in L \mid x \leq a\}$ . If  $a \in L$  and the lattice  $(a)$  satisfies the identity  $\mathbf{p}(x_1, \dots, x_n) \approx \mathbf{q}(x_1, \dots, x_n)$ , then

$$\mathbf{p}(a \wedge x_1, \dots, a \wedge x_n) = \mathbf{q}(a \wedge x_1, \dots, a \wedge x_n)$$

for all  $x_1, \dots, x_n \in L$  because  $a \wedge x_1, \dots, a \wedge x_n \in (a)$ . Therefore, in this situation,  $a$  is an  $(\varepsilon, n+1)$ -element of  $L$  with the following identity  $\varepsilon$  depending on letters  $x_1, \dots, x_{n+1}$ :

$$\mathbf{p}(x_{n+1} \wedge x_1, \dots, x_{n+1} \wedge x_n) \approx \mathbf{q}(x_{n+1} \wedge x_1, \dots, x_{n+1} \wedge x_n).$$

So, we have the following statement from Shaprynskiĭ [84]: if  $a$  is an element of a lattice  $L$  such that the ideal  $(a)$  of  $L$  satisfies some non-trivial identity, then  $a$  is an Id-element of  $L$ .

A monoid [respectively, semigroup] variety is an *Id-variety* if it is an Id-element of the lattice  $\text{MON}$  [respectively,  $\text{SEM}$ ]. The following assertion is a specialization of the aforementioned result for the lattice  $\text{MON}$ . The analogous claim is true for semigroup varieties.

**Observation 9.10.** *If  $\mathbf{V}$  is a monoid variety and the lattice  $L(\mathbf{V})$  satisfies some non-trivial identity, then  $\mathbf{V}$  is an Id-variety.*

It is verified by Shaprynskiĭ [84, Theorems 1 and 2] that all proper overcommutative semigroup varieties are non-Id-varieties and there exist periodic non-Id-varieties of semigroups. The analog of the former fact does not hold for monoid varieties. Indeed, by Proposition 9.4b), the variety  $\text{COM}$  is an Id-variety; this follows also from Observation 9.10 and the fact that the lattice  $L(\text{COM})$  is distributive by Theorem 5.1. As noted in Subsection 6.2, the lattice  $L(\text{COM} \vee \mathbf{D}_1)$  is also distributive. In view of Observation 9.10, the variety  $\text{COM} \vee \mathbf{D}_1$  provides one more example of overcommutative Id-variety of monoids. The following question is still open.

**Question 9.11.** Is there a [periodic] non-Id-variety of monoids?

The proof of Theorem 2 in Shaprynskiĭ [84] implies that if a lattice  $L$  contains a sublattice  $K$  that is anti-isomorphic to  $\Pi_\infty$ , then  $K$  contains an element that is not an Id-element of  $L$ . Thus, an affirmative answer to Question 4.11a) implies an affirmative answer to Question 9.11.

## 10. DEFINABLE VARIETIES AND SETS OF VARIETIES

**10.1. Definability.** A subset  $A$  of a lattice  $\langle L; \vee, \wedge \rangle$  is *definable* in  $L$  if there exists a first-order formula  $\Phi(x)$  with one free variable  $x$  in the language of lattice operations  $\vee$  and  $\wedge$  with the following property: for an element  $z \in L$ , the sentence  $\Phi(z)$  is true if and only if  $z \in A$ . An element  $a \in L$  is *definable* in  $L$  if the set  $\{a\}$  is definable in  $L$ .

The importance of definable elements and subsets of a lattice is due to their close connection with automorphisms of the lattice. Indeed, it is clear that if a subset  $A$  of a lattice  $L$  is definable in  $L$  and  $\varphi$  is any automorphism of  $L$ , then  $\varphi(a) \in A$  for all  $a \in A$ ; in particular, if  $a$  is definable in  $L$ , then  $\varphi(a) = a$ .

The notion of definable sets of elements deeply generalizes, in a sense, the notion of special elements. Indeed, if  $\varepsilon$  is a lattice identity depending on the letters  $x_1, \dots, x_n$  and  $1 \leq i \leq n$ , then the set of all  $(\varepsilon, i)$ -elements of a lattice  $L$  is evidently definable in  $L$ . The same is true for the set of all cancellable elements of a lattice.

Definable elements and subsets of the lattice  $\mathbf{SEM}$  have been examined by Ježek and McKenzie [46] and Vernikov [96]; see also Shevrin *et al.* [86, Section 15]. In particular, an arbitrary commutative semigroup variety is definable in  $\mathbf{SEM}$  [86, Corollary 15.1]. For brevity, we say that a monoid variety or a set of monoid varieties is *definable* if it is definable in  $\mathbf{MON}$ . There has not been any work devoted to the study of definable monoid varieties or sets of monoid varieties, but some results on this topic can be easily deduced from existing results.

**Proposition 10.1.** *The set of all varieties of commutative [overcommutative, periodic, group, Abelian group, aperiodic, completely regular, band] monoid varieties and each of the varieties  $\mathbf{COM}$ ,  $\mathbf{BAND}$ , and  $\mathbf{C}_n$  for any  $n \in \mathbb{N}$  are all definable.*

*Proof.* The set of all atoms of an arbitrary lattice  $L$  is definable in  $L$ . Further, if  $L$  is a complete lattice and a subset  $A$  of  $L$  is definable in  $L$ , then the element  $\bigvee A$  is also definable in  $L$ . The variety  $\mathbf{COM}$  is the join of all atoms of the lattice  $\mathbf{MON}$  and so is definable. This immediately implies definability of the classes of all commutative, all overcommutative, and all periodic varieties (as varieties  $\mathbf{V}$  with  $\mathbf{V} \subseteq \mathbf{COM}$ ,  $\mathbf{COM} \subseteq \mathbf{V}$ , and  $\mathbf{COM} \not\subseteq \mathbf{V}$ , respectively).

Further, the variety  $\mathbf{C}_1 = \mathbf{SL}$  is definable because it is a unique neutral element of the lattice  $\mathbf{MON}$  different from the least and the greatest elements of this lattice; see Theorem 9.1. This allows us to prove definability of the sets of all group varieties (as varieties  $\mathbf{V}$  with  $\mathbf{SL} \not\subseteq \mathbf{V}$ , see line 3 of Table 1), all Abelian group varieties (as varieties that are commutative and group varieties simultaneously), and all aperiodic varieties (as varieties that do not contain group atoms of the lattice  $\mathbf{MON}$ ).

The variety  $\mathbf{C}_2$  is definable because it is a unique costandard but non-neutral element of  $\mathbf{MON}$ ; see Theorems 9.1 and 9.2. Then we have definability of the sets of all completely regular varieties (as varieties  $\mathbf{V}$  with  $\mathbf{C}_2 \not\subseteq \mathbf{V}$ , see line 4 of Table 1) and all band varieties (as varieties that are completely regular and aperiodic simultaneously). The variety  $\mathbf{BAND}$  is then definable as the greatest band variety.

It remains to check that the variety  $\mathbf{C}_n$  with any  $n \geq 3$  is definable. Here we use the fact that the set of all chain varieties is definable. Then the variety  $\mathbf{C}_3$  is definable because it is a unique commutative chain variety that covers  $\mathbf{C}_2$ ; see Fig. 5. Finally, let  $n \geq 4$ . By induction on  $n$ , the variety  $\mathbf{C}_n$  is definable because it is a unique chain variety that covers  $\mathbf{C}_{n-1}$ ; see Fig. 5 again.  $\square$

However, the following question remains open.

**Question 10.2.** Is every commutative monoid variety definable?

Proposition 10.1 and Theorem 5.1 reduce this question to the following: is the variety  $\mathbf{A}_n$  definable for each  $n \geq 2$ ? Note that, for any  $n \geq 2$ , the variety of Abelian

groups of exponent  $n$  (considered as a semigroup variety) is definable in the lattice  $\mathbf{SEM}$ ; see Shevrin *et al.* [86, Corollary 15.1] or Vernikov [96, Theorem 5.7].

**10.2. Semidefinability.** If  $\mathbf{V}$  is a monoid variety such that  $\mathbf{V} \neq \overleftarrow{\mathbf{V}}$ , then  $\mathbf{V}$  is evidently non-definable because for an arbitrary first-order formula  $\Phi(x)$  in the lattice language, the sentences  $\Phi(\mathbf{V})$  and  $\Phi(\overleftarrow{\mathbf{V}})$  are true or false simultaneously. The following definition is thus very natural: a monoid variety  $\mathbf{V}$  is *semidefinable* if the set  $\{\mathbf{V}, \overleftarrow{\mathbf{V}}\}$  is definable.

**Proposition 10.3.** *Every variety of band monoids is semidefinable.*

*Proof.* It is evident that every definable variety is semidefinable and if a variety  $\mathbf{V}$  is semidefinable, then the variety  $\mathbf{V} \vee \overleftarrow{\mathbf{V}}$  is definable. The varieties  $\mathbf{SL}$  and  $\mathbf{BAND}$  are definable by Proposition 10.1. By Fig. 3, it suffices to check that the set  $\{\mathbf{B}_n, \overleftarrow{\mathbf{B}}_n\}$ , for any  $n \geq 2$ , is definable. We will use the fact that the set of all band varieties is definable by Proposition 10.1. The set  $\{\mathbf{B}_2, \overleftarrow{\mathbf{B}}_2\}$  is definable because  $\mathbf{B}_2$  and  $\overleftarrow{\mathbf{B}}_2$  are the only varieties of band monoids that cover  $\mathbf{SL}$ ; see Fig. 3. By induction on  $n$ , for any  $n > 2$ , the set  $\{\mathbf{B}_n, \overleftarrow{\mathbf{B}}_n\}$  is definable because  $\mathbf{B}_n$  and  $\overleftarrow{\mathbf{B}}_n$  are the only varieties of band monoids that cover  $\mathbf{B}_{n-1} \vee \overleftarrow{\mathbf{B}}_{n-1}$ ; see Fig. 3 again.  $\square$

One can verify semidefinability of many other monoid varieties. For example, it is easy to check that each non-group chain variety of monoids is semidefinable.

It is clear that the set of all semidefinable varieties is countably infinite. Since the lattice  $\mathbf{MON}$  is uncountably infinite, non-semidefinable monoid varieties exist, but we do not know of any explicit example.

**Problem 10.4.** Find an example of a non-semidefinable monoid variety.

This problem is closely related to Question 2.5a). Indeed, if Question 2.5a) is affirmatively answered, and if  $\varphi$  is a non-trivial automorphism of the lattice  $\mathbf{MON}$  that is different from  $\delta$ , then any variety  $\mathbf{V}$  such that  $\varphi(\mathbf{V}) \neq \mathbf{V}$  is non-semidefinable.

**Acknowledgements.** The authors are indebted to Marcel Jackson and Olga Sapir for very helpful discussions, and to Mikhail Volkov for important information on pseudovarieties in Subsection 1.2.

#### REFERENCES

- [1] P. Aglianó and J. B. Nation, *Lattices of pseudovarieties*, J. Austral. Math. Soc. Ser. A, **46** (1989), 177–183.
- [2] A. Ya. Aizenštat and B. K. Boguta, *On the lattice of semigroup varieties*, in: E. S. Lyapin (ed.), *Polugruppovye Mnogoobraziya i Polugruppy Endomorfizmov (Semigroup Varieties and Semigroups of Endomorphisms)*, Leningrad: Leningrad State Pedagogical Institute (1979), 3–46 [Russian; Engl. translation: Fourteen Papers Translated from the Russian, Amer. Math. Soc. Transl., Ser. 2, **134** (1987), 5–32].
- [3] J. Almeida, *Finite Semigroups and Universal Algebra*, World Scientific, Singapore, 1994.
- [4] V. A. Artamonov, *Chain varieties of groups*, Trudy Seminara Imeni I. G. Petrovskogo (Proc. of the Seminar Named After I. G. Petrovskij), **3** (1978), 3–8 [Russian].
- [5] G. Birkhoff, *On the structure of abstract algebras*, Proc. Cambridge Philos. Soc., **31** (1935), 433–454.
- [6] A. P. Biryukov, *Varieties of idempotent semigroups*, Algebra i Logika, **9** (1970), 255–273 [Russian; Engl. translation: Algebra and Logic, **9** (1970), 153–164].
- [7] A. P. Biryukov, *Minimal non-commutative varieties of semigroups*, Sibirskij Matem. J., **17** (1976), 677–681 [Russian; Engl. translation: Siberian Math. J., **17** (1976), 520–523].
- [8] A. I. Budkin and V. A. Gorbunov, *On theory of quasivarieties of algebraic systems*, Algebra i Logika, **14** (1975), 123–142 [Russian; Engl. translation: Algebra and Logic, **14** (1975), 73–84].
- [9] S. Burris and E. Nelson, *Embedding the dual of  $\Pi_\infty$  in the lattice of equational classes of semigroups*, Algebra Universalis, **1** (1971), 248–253.

- [10] S. Burris and E. Nelson, *Embedding the dual of  $\Pi_m$  in the lattice of equational classes of commutative semigroups*, Proc. Amer. Math. Soc., **30** (1971), 37–39.
- [11] S. Burris and H. P. Sankappanavar, *A Course in Universal Algebra*, Graduate Texts in Mathematics, **78**, Springer-Verlag, Berlin—Heidelberg—New York, 1981.
- [12] A. H. Clifford and G. B. Preston, *The Algebraic Theory of Semigroups*. Vol. I, Amer. Math. Soc., Providence, Rhode Island, 1961.
- [13] V. Dierks, M. Erne, and J. Reinhold, *Complements in lattices of varieties and equational theories*, Algebra Universalis, **31** (1994), 506–515.
- [14] S. Eilenberg, *Automata, Languages, and Machines*. Vol. B, Academic Press, New York, 1976.
- [15] T. Evans, *The lattice of semigroup varieties*, Semigroup Forum, **2** (1971), 1–43.
- [16] C. F. Fennemore, *All varieties of bands. I, II*, Math. Nachr., **48** (1971), 237–252, 253–262.
- [17] J. A. Gerhard, *The lattice of equational classes of idempotent semigroups*, J. Algebra, **15** (1970), 195–224.
- [18] G. Grätzer, *Lattice Theory: Foundation*, Springer Basel AG, 2011.
- [19] S. V. Gusev, *On the lattice of overcommutative varieties of monoids*, Izv. Vyssh. Uchebn. Zaved. Matem. No. 5 (2018), 28–32 [Russian; Engl. translation: Russ. Math. Iz. VUZ, **62**, No. 5 (2018), 23–26].
- [20] S. V. Gusev, *Special elements of the lattice of monoid varieties*, Algebra Universalis, **79** (2018), Article 29, 1–12.
- [21] S. V. Gusev, *On the ascending and descending chain conditions in the lattice of monoid varieties*, Siberian Electronic Math. Reports, **16** (2019), 983–997.
- [22] S. V. Gusev, *A new example of a limit variety of monoids*, Semigroup Forum, **101** (2020), 102–120.
- [23] S. V. Gusev, *Standard elements of the lattice of monoid varieties*, Algebra i Logika, **59** (2020), 615–626 [Russian; Engl. translation: Algebra and Logic, **59** (2021), 415–422].
- [24] S. V. Gusev, *Distributive and lower-modular elements of the lattice of monoid varieties*, Siberian Math. J., to appear; available at: <http://arxiv.org/abs/2201.08036>.
- [25] S. V. Gusev, *Varieties of aperiodic monoids with central idempotents whose subvariety lattice is distributive*, Monatsh. Math., to appear; DOI: 10.1007/s00605-022-01717-x.
- [26] S. V. Gusev, *Cross varieties of aperiodic monoids with commuting idempotents*, submitted; available at: <http://arxiv.org/abs/2004.03470>.
- [27] S. V. Gusev and E. W. H. Lee, *Varieties of monoids with complex lattices of subvarieties*, Bull. London Math. Soc., **52** (2020), 762–775.
- [28] S. V. Gusev and E. W. H. Lee, *Cancellable elements of the lattice of monoid varieties*, Acta Math. Hungar., **165** (2021), 156–168.
- [29] S. V. Gusev, Y. X. Li, and W. T. Zhang, *Limit varieties of monoids satisfying a certain identity*, Algebra Colloq., to appear; available at: <http://arxiv.org/abs/2107.07120v2>.
- [30] S. V. Gusev and O. B. Sapir, *Classification of limit varieties of  $J$ -trivial monoids*, Commun. Algebra, **50** (2022), 3007–3027.
- [31] S. V. Gusev and B. M. Vernikov, *Chain varieties of monoids*, Dissert. Math., **534** (2018), 1–73.
- [32] S. V. Gusev and B. M. Vernikov, *Two weaker variants of congruence permutability for monoid varieties*, Semigroup Forum, **103** (2021), 106–152.
- [33] T. E. Hall and K. G. Johnston, *The lattice of pseudovarieties of inverse semigroups*, Pacif. J. Math., **138** (1989), 73–88.
- [34] T. E. Hall and P. R. Jones, *On the lattice of varieties of bands of groups*, Pacif. J. Math., **91** (1980), 327–337.
- [35] T. J. Head, *The varieties of commutative monoids*, Nieuw Arch. Wiskunde. III Ser., **16** (1968), 203–206.
- [36] D. Hobby and R. N. McKenzie, *The Structure of Finite Algebras*, Amer. Math. Soc., Providence, Rhode Island, 1988.
- [37] J. M. Howie, *Fundamentals of Semigroup Theory*, 2nd ed., Clarendon Press, Oxford, 1995.
- [38] M. Jackson, *Finite semigroups whose varieties have uncountably many subvarieties*, J. Algebra, **228** (2000), 512–535.
- [39] M. Jackson, *Finite semigroups with infinite irredundant identity bases*, Int. J. Algebra Comput., **15** (2005), 405–422.
- [40] M. Jackson, *Finiteness properties of varieties and the restriction to finite algebras*, Semigroup Forum, **70** (2005), 159–187; *Erratum to “Finiteness properties of varieties and the restriction to finite algebras”*, Semigroup Forum, **96** (2018), 197–198.
- [41] M. Jackson, *Syntactic semigroups and the finite basis problem*, in: V. B. Kudryavtsev and I. G. Rosenberg (eds.), *Structural Theory of Automata, Semigroups, and Universal Algebra*, NATO Sci. Ser. II, Math. Phys. Chem., **207**, Springer, Dordrecht, 2005, 159–167.
- [42] M. Jackson and E. W. H. Lee, *Monoid varieties with extreme properties*, Trans. Amer. Math. Soc., **370** (2018), 4785–4812.

- [43] M. Jackson and W. T. Zhang, *From A to B to Z*, Semigroup Forum, **103** (2021), 165–190.
- [44] J. Ježek, *Primitive classes of algebras with unary and nullary operations*, Colloq. Math., **20** (1969), 159–179.
- [45] J. Ježek, *Intervals in lattices of varieties*, Algebra Universalis, **6** (1976), 147–158.
- [46] J. Ježek and R. N. McKenzie, *Definability in the lattice of equational theories of semigroups*, Semigroup Forum, **46** (1993), 199–245.
- [47] J. Kalicki and D. Scott, *Equational completeness of abstract algebras*, Proc. Koninkl. Nederl. Akad. Wetensch. Ser. A, **58** (1955), 650–659.
- [48] A. Kisielewicz, *Varieties of commutative semigroups*, Trans. Amer. Math. Soc., **342** (1994), 275–306.
- [49] I. O. Korjakov, *A sketch of the lattice of commutative nilpotent semigroup varieties*, Semigroup Forum, **24** (1982), 285–317.
- [50] P. A. Kozhevnikov, *On nonfinitely based varieties of groups of large prime exponent*, Commun. Algebra, **40** (2012), 2628–2644.
- [51] W. A. Lampe, *Further properties of lattices of equational theories*, Algebra Universalis, **28** (1991), 459–486.
- [52] E. W. H. Lee, *Minimal semigroups generating varieties with complex subvariety lattices*, Int. J. Algebra Comput., **17** (2007), 1553–1572.
- [53] E. W. H. Lee, *On the variety generated by some monoid of order five*, Acta Sci. Math. (Szeged), **74** (2008), 509–537.
- [54] E. W. H. Lee, *Maximal Specht varieties of monoids*, Mosc. Math. J., **12** (2012), 787–802.
- [55] E. W. H. Lee, *Varieties generated by 2-testable monoids*, Studia Sci. Math. Hungar., **49** (2012), 366–389.
- [56] E. W. H. Lee, *Almost Cross varieties of aperiodic monoids with central idempotents*, Beitr. Algebra Geom., **54** (2013), 121–129.
- [57] E. W. H. Lee, *Inherently non-finitely generated varieties of aperiodic monoids with central idempotents*, Zapiski Nauchnykh Seminarov POMI (Notes of Sci. Seminars of the St Petersburg Branch of the Math. Institute of the Russ. Acad. Sci.), **423** (2014), 166–182; see also J. Math. Sci., **209** (2015), 588–599.
- [58] E. W. H. Lee, *A minimal pseudo-complex monoid*, Arch. Math. (Basel), to appear.
- [59] E. W. H. Lee and J. R. Li, *Minimal non-finitely based monoids*, Dissert. Math., **475** (2011), 1–65.
- [60] E. W. H. Lee and W. T. Zhang, *The smallest monoid that generates a non-Cross variety*, Xiamen Daxue Xuebao Ziran Kexue Ban, **53** (2014), 1–4 [Chinese].
- [61] R. N. McKenzie, G. F. McNulty and W. F. Taylor, *Algebras. Lattices. Varieties. Vol. I*, Wadsworth & Brooks/Cole, Monterey, 1987.
- [62] M. Morse and G. A. Hedlund, *Unending chess, symbolic dynamics and a problem in semigroups*, Duke Math. J., **11** (1944), 1–7.
- [63] S. Oates and M. B. Powell, *Identical relations in finite groups*, J. Algebra, **1** (1964), 11–39.
- [64] F. J. Pastijn, *The lattice of completely regular semigroup varieties*, J. Austral. Math. Soc. Ser. A, **49** (1990), 24–42.
- [65] F. J. Pastijn, *Commuting fully invariant congruences on free completely regular semigroups*, Trans. Amer. Math. Soc., **323** (1991), 79–92.
- [66] F. J. Pastijn and P. G. Trotter, *Complete congruences on lattices of varieties and of pseudovarieties*, Int. J. Algebra and Comput., **8** (1998), 171–201.
- [67] P. Perkins, *Bases for equational theories of semigroups*, J. Algebra, **11** (1969), 298–314.
- [68] M. Petrich and N. R. Reilly, *The modularity of the lattice of varieties of completely regular semigroups and related representations*, Glasgow Math. J., **32** (1990), 137–152.
- [69] M. Petrich and N. R. Reilly, *Completely Regular Semigroups*, John Wiley & Sons, Inc., New York, 1999.
- [70] L. Polák, *On varieties of completely regular semigroups. I*, Semigroup Forum, **32** (1985), 97–123.
- [71] L. Polák, *On varieties of completely regular semigroups. II*, Semigroup Forum, **36** (1987), 253–284.
- [72] L. Polák, *On varieties of completely regular semigroups. III*, Semigroup Forum, **37** (1988), 1–30.
- [73] Gy. Pollák, *Some lattices of varieties containing elements without cover*, in: A. de Luca (ed.), *Non Commutative Structures in Algebra and Geometric Combinatorics*, Quad. Ric. Sci., **109** (1981), 91–96.
- [74] P. Pudlák and J. Tůma, *Every finite lattice can be embedded in a finite partition lattice*, Algebra Universalis, **10** (1980), 74–95.
- [75] V. V. Rasin, *Varieties of orthodox cliffordian semigroups*, Izv. Vyssh. Uchebn. Zaved. Matem., No. 11 (1982), 82–85 [Russian; Engl. translation: Soviet Math. Iz. VUZ, **26**, No. 11 (1982), 107–110].

- [76] J. Rhodes and B. Steinberg, *The  $q$ -Theory of Finite Semigroups*, Springer Monographs in Mathematics, Springer, New York, 2009.
- [77] D. Sachs, *Identities in finite partition lattices*, Proc. Amer. Math. Soc., **12** (1961), 944–945.
- [78] M. V. Sapir, *On Cross semigroup varieties and related questions*, Semigroup Forum, **42** (1991), 345–364.
- [79] O. B. Sapir, *Finitely based words*, Int. J. Algebra Comput., **10** (2000), 457–480.
- [80] O. B. Sapir, *Limit varieties of  $J$ -trivial monoids*, Semigroup Forum, **103** (2021), 236–260.
- [81] O. B. Sapir, *Limit varieties generated by finite non- $J$ -trivial aperiodic monoids*, submitted; available at: <http://arxiv.org/abs/2012.13598>.
- [82] M. P. Schützenberger, *On finite monoids having only trivial subgroups*, Information and Control, **8** (1965), 190–194.
- [83] R. Schwabauer, *A note on commutative semigroups*, Proc. Amer. Math. Soc., **20** (1969), 503–504.
- [84] V. Yu. Shaprynskiĭ, *Periodicity of special elements of the lattice of semigroup varieties*, Trudy Instituta Matematiki i Mekhaniki Uralskogo Otdelenija RAN (Proc. Institute of Math. and Mech. of the Ural Branch of the Russ. Acad. Sci.), **18**, No. 3 (2012), 282–286 [Russian].
- [85] V. Yu. Shaprynskiĭ, D. V. Skokov, and B. M. Vernikov, *Cancellable elements of the lattices of varieties of semigroups and epigroups*, Commun. Algebra, **47** (2019), 4697–4712.
- [86] L. N. Shevrin, B. M. Vernikov, and M. V. Volkov, *Lattices of semigroup varieties*, Izv. Vyssh. Uchebn. Zaved. Matem., No. 3 (2009), 3–36 [Russian; Engl. translation: Russ. Math. Iz. VUZ, **53**, No. 3 (2009), 1–28].
- [87] M. Stern, *Semimodular Lattices. Theory and Applications*, Cambridge Univ. Press, 1999.
- [88] E. V. Sukhanov, *Almost linear varieties of semigroups*, Matem. Zametki, **32** (1982), 469–476 [Russian; Engl. translation: Math. Notes, **32** (1982), 714–717].
- [89] A. V. Tishchenko, *The finiteness of a base of identities for five-element monoids*, Semigroup Forum, **20** (1980), 171–186.
- [90] A. N. Trakhtman, *Covering elements in the lattice of varieties of algebras*, Matem. Zametki, **15** (1974), 307–312 [Russian; Engl. translation: Math. Notes, **15** (1974), 174–177].
- [91] A. N. Trakhtman, *A six-element semigroup generating a variety with uncountably many subvarieties*, in: L. N. Shevrin (ed.), *Algebraicheskie Sistemy i Ikh Mnogoobraziya* (Algebraic Systems and Their Varieties), Sverdlovsk: Ural State University (1988), 138–143 [Russian].
- [92] P. G. Trotter, *Subdirect decompositions of the lattice of varieties of completely regular semigroups*, Bull. Austral. Math. Soc., **39** (1989), 343–351.
- [93] C. Vachuska, *On the lattice of completely regular monoid varieties*, Semigroup Forum, **46** (1993), 168–186.
- [94] B. M. Vernikov, *Dualities in lattices of semigroup varieties*, Semigroup Forum, **40** (1990), 59–76.
- [95] B. M. Vernikov, *Semicomplements in lattices of varieties*, Algebra Universalis, **29** (1992), 227–231.
- [96] B. M. Vernikov, *Proofs of definability of some varieties and sets of varieties of semigroups*, Semigroup Forum, **84** (2012), 374–392.
- [97] B. M. Vernikov, *Special elements in lattices of semigroup varieties*, Acta Sci. Math. (Szeged), **81** (2015), 79–109; an extended version is available at <http://arxiv.org/abs/1309.0228>.
- [98] B. M. Vernikov and M. V. Volkov, *Complements in lattices of varieties and quasivarieties*, Izv. Vyssh. Uchebn. Zaved. Matem., No. 11 (1982), 17–20 [Russian; Engl. translation: Soviet Math. Iz. VUZ, **26**, No. 11 (1982), 19–24].
- [99] M. V. Volkov, *Semigroup varieties with modular subvariety lattice*, Izv. Vyssh. Uchebn. Zaved. Matem., No. 6 (1989), 51–60 [Russian; Engl. translation: Soviet Math. Iz. VUZ, **33**, No. 6 (1989), 48–58].
- [100] M. V. Volkov, *Young diagrams and the structure of the lattice of overcommutative semigroup varieties*, in: P. M. Higgins (ed.), *Transformation Semigroups*. Proc. Int. Conf. Held at the Univ. Essex. Colchester: University of Essex (1994), 99–110.
- [101] M. V. Volkov, *György Pollák’s work on the theory of semigroup varieties: its significance and its influence so far*, Acta Sci. Math. (Szeged), **68** (2002), 875–894.
- [102] S. L. Wismath, *The lattice of varieties and pseudovarieties of band monoids*, Semigroup Forum, **33** (1986), 187–198.
- [103] W. T. Zhang and Y. F. Luo, *A new example of limit variety of aperiodic monoids*, manuscript; available at: <http://arxiv.org/abs/1901.02207>.

SERGEY V. GUSEV: INSTITUTE OF NATURAL SCIENCES AND MATHEMATICS, URAL FEDERAL UNIVERSITY, LENINA STR. 51, 620000 EKATERINBURG, RUSSIA

*Email address:* `sergey.gusb@gmail.com`

EDMOND W. H. LEE: DEPARTMENT OF MATHEMATICS, NOVA SOUTHEASTERN UNIVERSITY, FORT LAUDERDALE, FLORIDA 33314, USA

*Email address:* `edmond.lee@nova.edu`

BORIS M. VERNIKOV: INSTITUTE OF NATURAL SCIENCES AND MATHEMATICS, URAL FEDERAL UNIVERSITY, LENINA STR. 51, 620000 EKATERINBURG, RUSSIA

*Email address:* `bvernikov@gmail.com`