

ON A NONTRIVIAL KNOT PROJECTION UNDER (1, 3) HOMOTOPY

NOBORU ITO AND YUSUKE TAKIMURA

ABSTRACT. In 2001, Östlund formulated the question: are Reidemeister moves of types 1 and 3 sufficient to describe a homotopy from any generic immersion of a circle in a two-dimensional plane to an embedding of the circle? The positive answer to this question was treated as a conjecture (Östlund conjecture). In 2014, Hagge and Yazinski disproved the conjecture by showing the first counterexample with a minimal crossing number of 16. This example is naturally extended to counterexamples with given even minimal crossing numbers more than 14. This paper obtains the first counterexample with a minimal crossing number of 15. This example is naturally extended to counterexamples with given odd minimal crossing numbers more than 13.

1. INTRODUCTION

A *knot projection* is the image of a generic immersion of a circle into a 2-sphere. Thus, any self-intersection of a knot projection is a transverse double point, which is simply called a *double point*. A *trivial knot projection* is a knot projection with no double points. Any two knot projections are related by a finite sequence of Reidemeister moves of types 1, 2, and 3. Here, Reidemeister moves of types 1, 2, and 3, denoted by RI, RII, and RIII, are defined in Fig. 1. If two knot projections

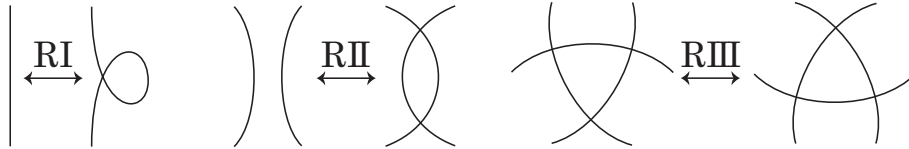

FIGURE 1. RI, RII, and RIII

P and P' are related by a finite sequence generated by RI and RIII, then P and P' are *(1, 3) homotopic*. The relation becomes an equivalence relation and is called *(1, 3) homotopy*.

In 2001 [2], Östlund formulated a question as follows:

Östlund Question. *Are Reidemeister moves RI and RIII sufficient to obtain a homotopy from any generic immersion $S^1 \rightarrow \mathbb{R}^2$ to an embedding?*

Key words and phrases. knot projections; Östlund conjecture; Reidemeister moves; spherical curves.

MSC2010: 57Q35, 57M25.

In [1], Hagge and Yazinski obtained an answer to this question as follows ([1] treated the positive answer to Östlund’s question as “his conjecture”, and thus, we call it *Östlund Conjecture*):

Hagge-Yazinski Theorem. *A homotopy from the trivial knot projection to P_{HY} that appears as Fig. 2 cannot be obtained by a finite sequence generated by Reidemeister moves RI and RIII.*

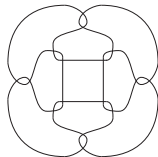

FIGURE 2. Hagge-Yazinski’s example P_{HY}

For a given knot projection P , let $c_{\min}(P) = \min\{ \text{the number of double points of } P' \mid P' \text{ and } P \text{ are related by a finite sequence generated by RI and RIII} \}$. We call $c_{\min}(P)$ the *minimal crossing number* of P .

As a step further, it is easy to find a vast generalization of the Hagge-Yazinski Theorem; there exists an infinite family of counterexamples of the Östlund Conjecture, i.e., non-trivial knot projections under $(1, 3)$ homotopy (Remark 1). However, every knot projection of this family has an even minimal crossing number.

In this paper, we find a counterexample of the conjecture with an odd minimal crossing number. We show the non-triviality of the example by using Hagge-Yazinski techniques [1]. This example is naturally extended to an infinite family of knot projections, each of which is a knot projection with a given odd minimal crossing number. Similar to Remark 1, Theorem 1 naturally implies a knot projection P such that $c_{\min}(P) = 2i + 13$ ($i \in \mathbb{Z}_{>0}$).

Theorem 1. *The knot projection, shown in Fig. 3, and the trivial knot projection cannot be $(1, 3)$ homotopic.*

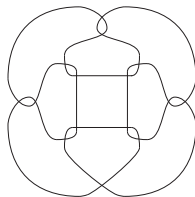

FIGURE 3. A knot projection

2. PROOF OF THEOREM 1

As shown in Fig. 4, any P_0 can be decomposed into seven boxes and arcs with no double points. Each box is equivalent to $[0, 1] \times [0, 1]$ under sphere isotopy and in each box, there is a part of a knot projection, called $(3, 3)$ -tangle (cf. Definition 1).

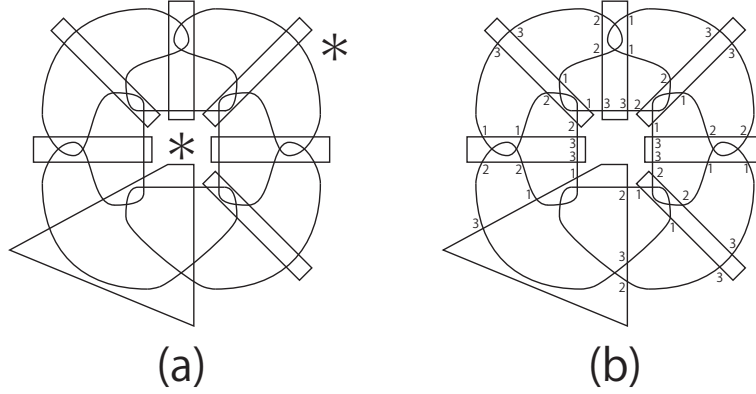

FIGURE 4. (a): seven boxes and two starred polygons and (b) the configuration of strands

Definition 1 ((s, t) -tangle). Let s and t be positive integers such that $s + t$ is even. An unoriented (s, t) -tangle is the image of a generic immersion of $(s + t)/2$ arcs into $[0, 1] \times [0, 1]$ such that:

- The boundary points of the arcs map bijectively to $s + t$ points $\{1, 2, \dots, s\} \times \{1\}, \{1, 2, \dots, t\} \times \{0\}$.
- Near the endpoints, the arcs are perpendicular to the boundary $[0, 1]$.

An image of the map of a single arc is called a *strand*.

Definition 2 (polygon, r -gon). Let P be a nontrivial knot projection and let r be a positive integer. For each connected component D of $S^2 \setminus P$, ∂D consists of a circle with double point(s). Then, $D \cup \partial D$ is called a *polygon*. If ∂D has exactly r double point(s), $D \cup \partial D$ is also called r -gon.

Each of the seven boxes satisfies the following four conditions, called the *box property* consisting of Rules (1)–(3):

- (1) There exist exactly two polygons, called *starred polygons*, each having at least four sides partially outside boxes and each completely containing seven boxes' sides with no intersections with the knot projection.
- (2) Choose and fix one of the starred polygons. Because we fix our gazing direction based on the selected starred polygon, we can define the *left-side* and *right-side* of each box. Strand 1 (resp. 2) is a strand that begins and ends on the left-side (resp. right-side) in each box. Strand 3 has one endpoint on the left-side and another endpoint on the right-side of each box. Strands 1 and 2; for each pair, strands 1 and 2 intersect at exactly 2 double points.
- (3) No double points are placed outside the boxes. Each endpoint of strand 3 on the left-side is connected to the endpoint of strand 2 on the right-side of the adjacent box. Each endpoint of a strand 3 on the right-side is connected to the endpoint of strand 1 on the left-side of the adjacent box. The left pairs of strands 1 and 2 are connected to each other.

We consider an inductive proof with respect to the number of Reidemeister moves, RI or RIII, applied to P_0 . This induction proves the existence of seven boxes

satisfying the box property, which implies that P_0 cannot be $(1, 3)$ homotopic to the trivial knot projection (cf. Rule (2)). Now we prove the claim. Let n be the number of Reidemeister moves applied to P_0 .

First, for the case where $n = 0$, there exist seven boxes such that the box property holds. Second, we assume the existence of seven boxes such that the box property holds for n and prove the $(n + 1)$ th case. Let 1a (resp. 1b) be RI increasing (resp. decreasing) the number of double points. In the following, we show the $(n + 1)$ th claim for each Reidemeister move within a box and outside or partially outside the boxes. From the assumption (Rule (1)), the definition of two starred polygons for the n th case are well-defined. We call each starred polygon an n th *starred polygon*.

2.1. RI or RIII occurring within a box. Let us consider a single move (RI or RIII) occurring entirely within one of the boxes. This move fixes the endpoints of the strands, and thus Rule (2) and Rule (3) are satisfied. That is, if we assume that the n th case is true, we can define the same number of boxes satisfying Rules (2) and (3) for the $(n + 1)$ th case after the application of RI or RIII within a box.

From the above condition, we can prove Rule (1) using Rules (2) and (3) even if the order of the endpoints of the strands is changed for a side. Let P_n and P_{n+1} be knot projections. Let F_{n+1} be a polygon of P_{n+1} corresponding to an n th starred polygon F_n of P_n where P_{n+1} is obtained by applying a single Reidemeister move to P_n within a box (Fig. 5).

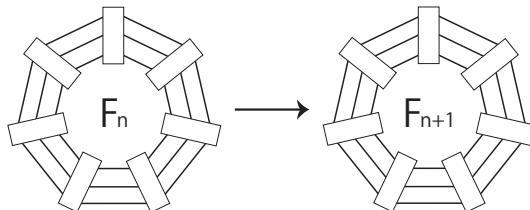

FIGURE 5. F_n and F_{n+1}

Suppose that F_{n+1} is an r -gon. Polygon F_{n+1} faces no successive strands of type 3 with no double points, within two successive boxes. This is because strand 3 is connected to the endpoints of strands 1 or 2 and there is no double point outside the boxes as per Rule (3). Here, note that from Rule (2), any strand with endpoints on left- and right-sides is strand 3. Thus, proceeding along the boundary of F_{n+1} , we encounter boxes containing at least four vertices of F_{n+1} that are inside the boxes, which implies $r \geq 4$. Thus, Rule (1) also holds for the $(n + 1)$ th case.

In conclusion, if the $(n + 1)$ th move is within a box, there exist seven boxes such that the box property holds.

2.2. 1a not occurring within a box. Note that we assume the existence of boxes such that the box property holds for the n th case. If the $(n + 1)$ th move is 1a and is outside the boxes, we can redefine the box by sphere isotopy, as shown in Fig. 6. If this 1a is not completely outside the boxes, we can use a similar modification.

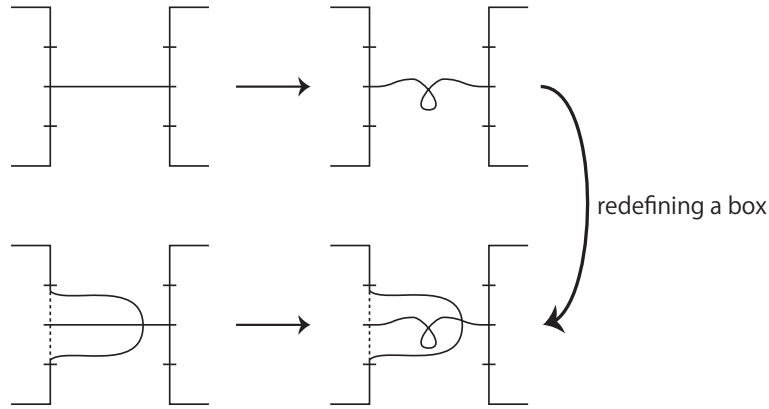

FIGURE 6. Redefining a box

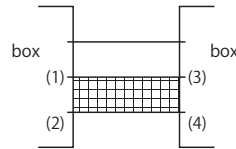

FIGURE 7. Each of endpoints (1), (2), (3), and (4) connects to strand 1, 2, or 3.

2.3. 1b not occurring within a box. If the $(n + 1)$ th move is 1b and not occurring within a box, there exists a 1-gon to be removed for the n th case. The two possibilities of the 1-gon are considered as follows.

- From Fig. 7, we can see the 1-gon of 1b containing a region having two sides outside the boxes. If one of the two sides is directly connected to either strand 1 or 2, then the 1-gon has at least two double points, which is a contradiction (there is no 1-gon with two double points). If one of the two sides is directly connected to strand 3 that is connected strand 1 or 2 in the adjacent box, then this also implies a contradiction similar to the case above.
- For 1-gon of 1b containing an n th starred polygon, by the induction assumption, it has at least $r (\geq 4)$ vertices, which is a contradiction.

2.4. RIII not occurring within a box. If the $(n + 1)$ th move is a single RIII, we focus on the 3-gon T_n for the n th case with respect to the single RIII, as shown in Fig. 8. If T_n is not in a box, it contains a region having two sides outside the box, as shown in Fig. 9. This is because T_n cannot contain a starred polygon (= r -gon, $r \geq 4$) by the induction assumption.

Further, if T_n is not inside a box, at least one vertex of T_n is inside a box. If not, there is an arc inside a box, as shown in Fig. 10, which starts and ends on the same side. However, by the induction assumption and Rule (2) of the box property for the n th case, the arc should be either strand 1 or 2, which is a contradiction because an arc has no intersection whereas both strand 1 and 2 have intersections.

FIGURE 8. 3-gon T_n for the n th case with respect to a single RIIIFIGURE 9. A region contained by the 3-gon appearing in the n th case

FIGURE 10. Impossible case

By the induction assumption, there is no double point outside the boxes for the n th case. Thus, if T_n is not inside a box, there are exactly two cases of local arrangements of boxes. Case 1 is when one vertex of T_n is inside a box and two vertices of T_n are in another box. Case 2 is when all three vertices are in different boxes (Fig. 11). As a result, for Case 1 (resp. Case 2), by sphere isotopy, we can

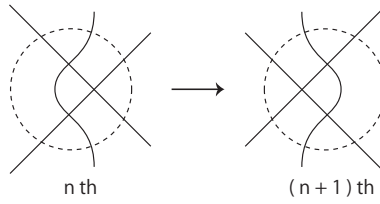
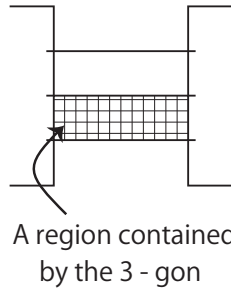
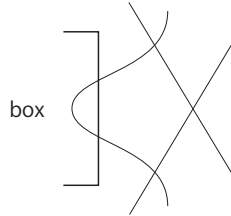
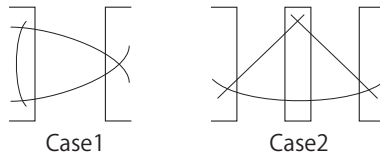

FIGURE 11. Case 1 (left) and Case 2 (right)

redefine one box (resp. two boxes), as shown in Fig. 12.

Here, it is easy to see that this redefinition satisfies Rules (1)–(3). Thus, the $(n+1)$ th case holds and this completes the proof. \square

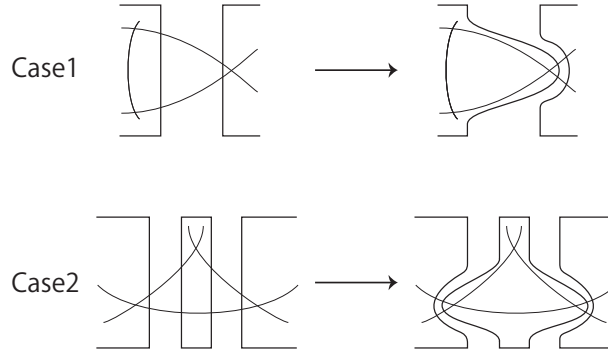

FIGURE 12. Redefining box(es) for Case 1 (upper) and Case 2 (lower)

Remark 1. For positive integers $l \geq 1$, $m \geq 1$, and $n \geq 4$, let $P(l, m, n)$ be a knot projection, as defined in Fig. 13. It is easy to see that P_{HY} is extended to $P(l, m, n)$. It is also elementary to find that for any positive integer i , there exists

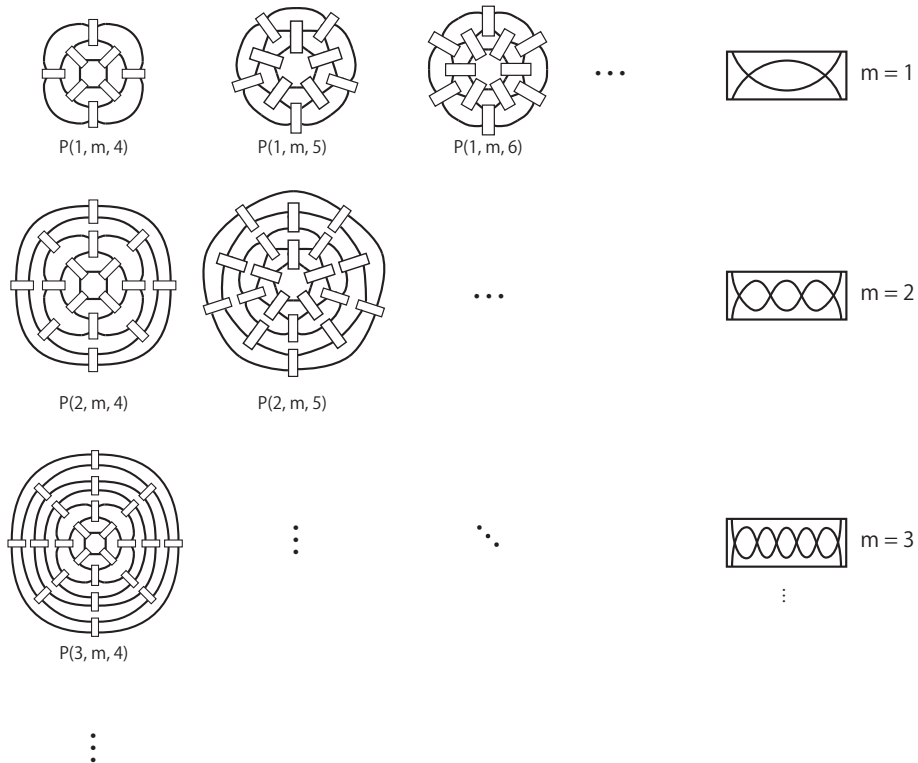
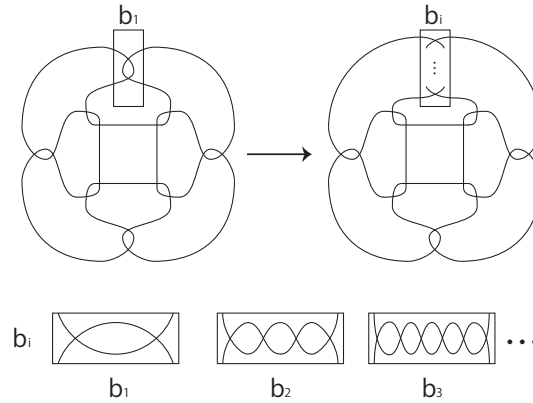

FIGURE 13. $P(l, m, n)$

a knot projection with $c_{\min}(P) = 2i + 14$ (see Fig. 14).

FIGURE 14. A knot projection P with $c_{\min}(P) = 2i + 14$

ACKNOWLEDGEMENTS

The authors would like to thank Professor Takahiro Kitayama for his useful comments at the conference: Intelligence of Low-dimensional Topology, RIMS, Kyoto University, held in May 2015. We also thank Professor Tomoo Yokoyama for his comments on our earlier work at the seminar: KUAMS, ACCA-JP, Sakajo CREST seminar, Kyoto University, held in November 2014. The work of N. Ito was partially supported by the JSPS Japanese-German Graduate Externship and a Waseda University Grant for Special Research Projects (Project number: 2015K-342). N. Ito is a project researcher of Grant-in-Aid for Scientific Research (S) 24224002 (April 2016–).

REFERENCES

- [1] T. Hagge and J. Yazinski, On the necessity of Reidemeister move 2 for simplifying immersed planar curves, *Banach Center Publ.* **103** (2014), 101–110.
- [2] O.-P. Östlund, Invariants of knot diagrams and diagrammatic knot invariants, Ph.D. Thesis, Uppsala Univ., 2001.

WASEDA INSTITUTE FOR ADVANCED STUDY, 1-6-1 NISHI WASEDA, SHINJUKU-KU, TOKYO, 169-8050, JAPAN

Email address: noboru@moegi.waseda.jp

(CURRENT ADDRESS) GRADUATE SCHOOL OF MATHEMATICAL SCIENCES, THE UNIVERSITY OF TOKYO, 3-8-1, KOMABA, MEGURO-KU, TOKYO, 153-8914, JAPAN

Email address, (Current): noboru@ms.u-tokyo.ac.jp

GAKUSHUIN BOYS' JUNIOR HIGH SCHOOL, 1-5-1, MEJIRO, TOSHIMA-KU, TOKYO, 171-0031, JAPAN

Email address: Yusuke.Takimura@gakushuin.ac.jp