

A CATEGORIFICATION OF THE CARTAN-EILENBERG FORMULA

JUN MAILLARD

ABSTRACT. We prove a categorification of the stable elements formula of Cartan and Eilenberg. Our formula expresses the derived category and the stable module category of a group as a bilimit of the corresponding categories for the p -subgroups.

A classical theorem by Cartan and Eilenberg [CE56, Theorem 10.1] presents the mod p cohomology of a finite group G as a subalgebra of the cohomology of any p -Sylow subgroup S of G . The formalism of fusion systems provides a compact formula to express this result in terms of the fusion category $\mathcal{F}_S(G)$ (definition 2.1):

$$H^*(G; \mathbb{F}_p) \simeq \lim_{P \in \mathcal{F}_S(G)^{\text{op}}} H^*(P; \mathbb{F}_p)$$

This formula actually holds [Par17] for any cohomological Mackey functor \mathcal{M} :

$$\mathcal{M}(G) \simeq \lim_{P \in \mathcal{F}_S(G)^{\text{op}}} \mathcal{M}(P)$$

We prove a categorified Cartan-Eilenberg formula (theorem 3.9) for any p -monadic Mackey 2-functor \mathbb{M} (definitions 3.2 and 3.7):

$$\mathbb{M}(G) \cong \text{bilim}_{P \in \hat{\mathcal{T}}_S(G)^{\text{op}}} \mathbb{M}(P)$$

For instance, the left-hand side can stand for the categories of group representations $\mathbb{M}(G) = \text{mod}(\mathbb{k}G)$, the stable categories of group representations $\mathbb{M}(G) = \text{stmod}(\mathbb{k}G)$ or the derived categories of the group algebras $\mathbb{M}(G) = \text{D}(\mathbb{k}G)$. (There are other examples, see remark 3.8.) We can let G range over all finite groupoids and these mappings then describe the values on objects of 2-functors $\mathbb{M}: (\mathbf{gpd}^{\text{f}})^{\text{op}} \rightarrow \mathbf{Cat}$ from the 2-category of finite groupoids, with faithful functors as 1-morphisms, to the 2-category of small categories.

This categorification requires us to replace the fusion category $\mathcal{F}_S(G)$ by an extended transporter category $\hat{\mathcal{T}}_S(G)$ (definition 2.4) and the classical limit by a pseudo bilimit (definition 1.5) taken in the 2-category of categories.

Through a 2-finality argument, using the criterion of [Mai21b], the bilimit in theorem 3.9 can be reinterpreted as a descent-shaped bilimit. Theorem 3.9 thus states that the functor \mathbb{M} is a 2-sheaf, which allows us to recover the main theorem of [Bal15]. More details on this point can be found in [Mai21a].

The article is organized as follows. In section 1, we recall classical definitions concerning bicategories and relevant notations. In section 2, we give a quick summary of the classical categorical formalism of fusion in groups and introduce our generalization. In section 3, we state and prove the main theorem. In section 4, we explain how to retrieve the classical Cartan-Eilenberg formula, and similar results, from our categorified formula.

2010 *Mathematics Subject Classification.* 18A05, 18A30, 18C15, 18C20, 18D05, 20C05, 20L05.

Key words and phrases. Categorification, fusion of finite groups, bilimits.

Author supported by Project ANR ChroK (ANR-16-CE40-0003) and Labex CEMPI (ANR-11-LABX-0007-01).

Acknowledgements. This work is a part of a PhD thesis under the supervision of Ivo Dell’Ambrogio.

1. BICATEGORICAL NOTIONS

1.1. Usual definitions and conventions. We will follow the naming conventions of [JY21] for bicategorical notions. In particular, the terms *2-category* and *2-functor* denote the *strict* ones; *bicategory* and *pseudofunctor* refer to the strong but (possibly) non-strict variants. We will use the term *(2,1)-category* for a *2-category* with only invertible *2-morphisms*, and the term *(2,1)-functor* for a *2-functor* between *(2,1)-categories*.

We recall some usual constructions and properties of *2-categories* we will use, and introduce some notations.

1.1. Notation. We use the symbol \simeq to denote an *isomorphism* between two objects (in a 1-category) and the symbol \cong to denote an *equivalence* between two objects (in a *2-category*).

1.2. Definition. Let \mathbf{C} be a *2-category*. The *opposite 2-category* \mathbf{C}^{op} of \mathbf{C} is the *2-category* with:

- *Objects:* the objects of \mathbf{C}
- *Hom-categories:* $\mathbf{C}^{\text{op}}(A, B) = \mathbf{C}(B, A)$

1.3. Notation. We use the notation $[\mathbf{A}, \mathbf{B}]$ for the *2-category* of pseudofunctors, pseudonatural transformations and modifications, between two *2-categories* \mathbf{A} and \mathbf{B} .

1.4. Notation. Let \mathbf{I}, \mathbf{C} be *2-categories* and T be an object of \mathbf{C} . The constant *2-functor* $\mathbf{I} \rightarrow \mathbf{C}$ with value T is denoted by ΔT .

1.5. Definition. Let \mathbf{I}, \mathbf{C} be *2-categories* and $\mathbb{D}: \mathbf{I} \rightarrow \mathbf{C}$ be a *2-functor*. A (*pseudo*) *bilimit* of \mathbb{D} is an object L of \mathbf{C} and a family of equivalences

$$\Psi_T: \mathbf{C}(T, L) \cong [\mathbf{I}, \mathbf{C}](\Delta T, \mathbb{D})$$

pseudonatural in T . When it exists, the bilimit of \mathbb{D} is unique up to equivalence and the object L is noted $\text{bilim}_{\mathbf{I}} \mathbb{D}$.

We call the canonical pseudonatural transformation $\Psi_L(\text{Id}_L)$ the *standard cone* of the bilimit L .

1.6. Definition. Let \mathbf{C} be a *2-category*. Let $f: a \rightarrow c$ and $g: b \rightarrow c$ be two 1-morphisms of \mathbf{C} with the same target. A *2-pullback* of f and g is a bilimit of the diagram:

$$a \xrightarrow{f} c \xleftarrow{g} b$$

1.7. Notation. We write $(f|g)$ for the *2-pullback* of f and g . We will use the following naming scheme for the structural 1- and 2-morphisms:

$$\begin{array}{ccc}
 & c & \\
 f \nearrow & & \nwarrow g \\
 a & & b \\
 \xleftarrow{(f|g)} & \xrightarrow{\cong} & \xrightarrow{(f|g)} \\
 & (f|g) &
 \end{array}$$

1.8. Definition. Let \mathbf{C} be a *(2,1)-category*. Fix a *(2,1)-functor* $\mathbb{F}: \mathbf{I} \rightarrow \mathbf{C}$ and an object c of \mathbf{C} . The *slice* \mathbb{F}/c is the *(2,1)-category* with:

- *Objects*: the pairs (i, f) consisting of an object i of \mathbf{I} and a morphism $f: \mathbb{F}i \rightarrow c$
- *Morphisms* $(i, f) \rightarrow (i', f')$: the pairs (u, μ) consisting of a morphism $u: i \rightarrow i'$ of \mathbf{I} and a 2-isomorphism $\mu: f \Rightarrow f'\mathbb{F}(u)$ of \mathbf{C} :

$$\begin{array}{ccc} \mathbb{F}i & \xrightarrow{\mathbb{F}u} & \mathbb{F}i' \\ & \searrow \mu \swarrow \sim & \\ f & \rightarrow c \leftarrow & f' \end{array}$$

- *2-Morphisms* $(u, \mu) \Rightarrow (v, \nu)$: the 2-morphisms $\alpha: u \Rightarrow v$ of \mathbf{I} satisfying:

$$\begin{array}{ccc} \mathbb{F}i & \xrightarrow{\mathbb{F}v} & \mathbb{F}i' \\ \mathbb{F}\alpha \uparrow & & \uparrow \\ \mathbb{F}i & \xrightarrow{\mathbb{F}u} & \mathbb{F}i' \\ & \searrow \mu \swarrow \sim & \\ f & \rightarrow c \leftarrow & f' \end{array} = \begin{array}{ccc} \mathbb{F}i & \xrightarrow{\mathbb{F}v} & \mathbb{F}i' \\ & \searrow \nu \swarrow \sim & \\ f & \rightarrow c \leftarrow & f' \end{array}$$

- Compositions are induced by the compositions of \mathbf{I} and \mathbf{C} .

A slice 2-category \mathbb{F}/c is endowed with a canonical forgetful 2-functor:

$$\left\{ \begin{array}{ll} \mathbb{F}/c & \rightarrow \mathbf{I} \\ (i, f) & \mapsto i \\ (u, \mu) & \mapsto u \\ \alpha & \mapsto \alpha \end{array} \right.$$

1.2. Adjunctions and monads. We recall the definitions of adjunctions and monads, and some of their basic properties in \mathbf{Cat} .

1.9. Definition. Let C, D be two categories. An adjunction between C and D is a quadruple $(\ell, r, \eta, \epsilon)$ of a functor $\ell: C \rightarrow D$, a functor $r: D \rightarrow C$, a natural transformation $\eta: \text{Id}_C \Rightarrow r\ell$ and a natural transformation $\epsilon: \ell r \Rightarrow \text{Id}_D$, such that:

$$(1.10) \quad \text{Id}_\ell = \epsilon\ell \circ \ell\eta$$

$$(1.11) \quad \text{Id}_r = r\epsilon \circ \eta r$$

We write an adjunction $\ell \dashv r$, with the natural transformations η and ϵ omitted. The natural transformation η is called the *unit* of the adjunction and the natural transformation ϵ is called the *counit*.

1.12. Definition. Let C be a category. A monad on C is a monoid object in the monoidal category $\mathbf{Cat}(C, C)$ of endofunctors of C , that is, a triple (\mathbb{T}, η, μ) consisting of a functor $\mathbb{T}: C \rightarrow C$, a natural transformation $\eta: \text{Id}_C \Rightarrow \mathbb{T}$ and a natural transformation $\mu: \mathbb{T} \circ \mathbb{T} \Rightarrow \mathbb{T}$ such that the following diagrams commute:

$$\begin{array}{ccc} \mathbb{T} \circ \mathbb{T} \circ \mathbb{T} & \xrightarrow{\mathbb{T}\mu} & \mathbb{T} \circ \mathbb{T} \\ \mu\mathbb{T} \downarrow & & \downarrow \mu \\ \mathbb{T} \circ \mathbb{T} & \xrightarrow{\mu} & \mathbb{T} \end{array} \quad \begin{array}{ccc} \mathbb{T} \circ \mathbb{T} & \xleftarrow{\mathbb{T}\eta} & \mathbb{T} & \xrightarrow{\eta\mathbb{T}} & \mathbb{T} \circ \mathbb{T} \\ & \searrow \mu & \parallel & \swarrow \mu & \\ & & \mathbb{T} & & \end{array}$$

1.13. Proposition. Let C, D be two categories and $(\ell: C \rightarrow D, r: D \rightarrow C, \eta, \epsilon)$ be an adjunction $\ell \dashv r$ between C and D . Then the triple $(r\ell, \eta, r\epsilon\ell)$ defines a monad on C .

1.14. Definition. Let C be a category and \mathbb{T} be a monad on C . The *Eilenberg-Moore category* $C^\mathbb{T}$ of \mathbb{T} is the category with:

- *Objects*: the pairs (c, f) with c an object of C and $f: \mathbb{T}c \rightarrow c$ a morphism of C .
- *Morphisms* $(c, f) \rightarrow (c', f')$: the morphisms $g: c \rightarrow c'$ such that the following square commutes:

$$\begin{array}{ccc} \mathbb{T}c & \xrightarrow{\mathbb{T}g} & \mathbb{T}c' \\ f \downarrow & & \downarrow f' \\ c & \xrightarrow{g} & c' \end{array}$$

- *Composition* is induced by the composition of C .

There is a canonical functor

$$U: \begin{cases} C^{\mathbb{T}} & \rightarrow C \\ (c, f) & \mapsto c \\ g & \mapsto g \end{cases}$$

and a natural transformation $\bar{\mu}: \mathbb{T}U \Rightarrow U$ with components

$$\bar{\mu}_{(c,f)} = f$$

1.15. Definition. Let C be a category and (\mathbb{T}, η, μ) be a monad on C . A *left module* on \mathbb{T} , or left \mathbb{T} -module, is a category D endowed with a functor $V: D \rightarrow C$ and a natural transformation $\nu: \mathbb{T}V \Rightarrow V$ such that the following diagrams commute

$$\begin{array}{ccc} \mathbb{T}\mathbb{T}V & \xrightarrow{\mu V} & \mathbb{T}V \\ \mathbb{T}\nu \downarrow & & \downarrow \nu \\ \mathbb{T}V & \xrightarrow{\nu} & V \end{array} \quad \begin{array}{ccc} V & \xrightarrow{\eta V} & \mathbb{T}V \\ \parallel & \swarrow \nu & \\ V & & \end{array}$$

1.16. Definition. Let C be a category and (\mathbb{T}, η, μ) be a monad on C . The *2-category of left \mathbb{T} -modules* is the category with:

- *Objects*: the left \mathbb{T} -modules.
- *1-morphisms* $(D, V, \nu) \rightarrow (E, W, \omega)$: the pairs (X, χ) consisting of a functor $X: D \rightarrow E$ and a natural isomorphism $\chi: V \xrightarrow{\sim} WX$ such that:

$$\chi \circ \nu = \omega X \circ \mathbb{T}\chi$$

- *2-morphisms* $(X, \chi) \Rightarrow (X', \chi')$: the natural transformations $\psi: X \Rightarrow X'$ such that:

$$\begin{array}{ccc} \begin{array}{ccc} D & \xrightarrow{X'} & E \\ \psi \uparrow & & \\ D & \xrightarrow{X} & E \\ \chi \nearrow & & \\ V & & W \\ \downarrow & & \downarrow \\ C & & C \end{array} & = & \begin{array}{ccc} D & \xrightarrow{X'} & E \\ & \nearrow \chi' & \\ V & & W \\ \downarrow & & \downarrow \\ C & & C \end{array} \end{array}$$

1.17. Proposition. Let C be a category and \mathbb{T} be a monad on C . The Eilenberg-Moore category $C^{\mathbb{T}}$ endowed with U and $\bar{\mu}$ (definition 1.14) is a left module on \mathbb{T} (definition 1.15).

Moreover it is terminal among the left modules on \mathbb{T} in the following sense: if (D, V, ν) is another left module on \mathbb{T} , there is a unique functor $K: D \rightarrow C^{\mathbb{T}}$ such that $V = UK$ and $\nu = \bar{\mu}K$.

1.18. *Remark.* The left \mathbb{T} -module $(C^\mathbb{T}, U, \bar{\mu})$ of proposition 1.17 is pseudo biterminal in the 2-category of left \mathbb{T} -modules (definition 1.16): for any other left \mathbb{T} -module (D, V, ν) , there is a 1-morphism $(K, \kappa): (D, V, \nu) \rightarrow (C^\mathbb{T}, U, \bar{\mu})$, unique up to a unique 2-isomorphism.

1.3. **String diagrams.** The proof of our main result is an extensive manipulation of string diagrams. We recall the general ideas of string diagrams, and introduce our notations. A fully detailed description of string diagrams can be found in [JY21, §3.7].

String diagrams are used to depict natural transformations. They are the dual diagrams of the “usual” pasting diagrams.

- An object A is represented by a labeled surface

A

- A 1-morphism $f: A \rightarrow B$ is represented by a labeled vertical edge

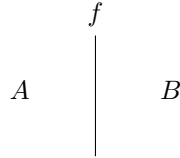

with the source on the left and the target on the right.

- A 2-morphism $\phi: f \Rightarrow g: A \rightarrow B$ is represented by a labeled vertex

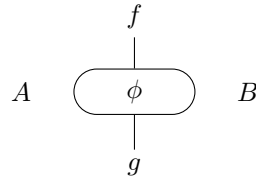

with the source above and the target below. The identity 1-morphisms may be omitted.

- We will occasionally represent identity 2-morphisms by a white dot, that is, the string diagram

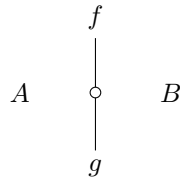

is the identity between the 1-morphisms f and g .

- When dealing with an adjunction $\ell \dashv r$, units and counits will be represented by black dots. For instance, the string diagram



is the unit of the adjunction $\ell \dashv r$.

1.19. *Remark.* The notation for the unit and the counit of an adjunction $\ell \dashv r$ gives a simple interpretation of the unit-counit laws (eq. (1.10) and eq. (1.11)):

$$\begin{array}{ccc} \ell & & \ell \\ | & = & \text{---} \\ \ell & & \ell \end{array} \quad \begin{array}{ccc} r & & r \\ | & = & \text{---} \\ r & & r \end{array}$$

1.4. **1-categories as 2-categories.** A 1-category can be seen as a $(2, 1)$ -category, with only identities as 2-morphisms, and a 1-functor between 1-categories can itself be viewed as a 2-functor. Hence all the constructions on 2-categories can be applied to 1-categories and 1-functors. Reciprocally there are several ways to extract 1-categories from bicategories.

1.20. **Definition.** Let \mathbf{C} be a bicategory with only invertible 2-morphisms. The *truncated category* $\tau_1\mathbf{C}$ is the category where:

- *Objects* are the objects c of \mathbf{C} .
- *Morphisms* $c \rightarrow c'$ are the classes of 1-morphisms $c \rightarrow c'$ of \mathbf{C} up to 2-isomorphism.
- *Composition* is induced by the composition of \mathbf{C} .

There is a canonical projection pseudofunctor $\pi: \mathbf{C} \rightarrow \tau_1\mathbf{C}$.

1.21. **Proposition.** Let \mathbf{C} be a bicategory with only invertible 2-morphisms and \mathbf{D} be a 1-category seen as a 2-category. Let $\mathbb{F}: \mathbf{C} \rightarrow \mathbf{D}$ be a pseudofunctor. Then there is a unique 1-functor $\tau_1\mathbb{F}: \tau_1\mathbf{C} \rightarrow \mathbf{D}$ factoring \mathbb{F} through π :

$$\begin{array}{ccc} \mathbf{C} & & \mathbf{D} \\ \pi \downarrow & \searrow \mathbb{F} & \\ \tau_1\mathbf{C} & \xrightarrow{\tau_1\mathbb{F}} & \mathbf{D} \end{array}$$

1.22. **Definition.** Let \mathbf{C} be a $(2, 1)$ -category. The *underlying category* $\mathbf{C}^{(1)}$ is the category where:

- *Objects* are the objects c of \mathbf{C} .
- *Morphisms* $c \rightarrow c'$ are the 1-morphisms of \mathbf{C} .
- *Composition* is induced by the composition of \mathbf{C} .

There is a canonical inclusion 2-functor $\iota: \mathbf{C}^{(1)} \rightarrow \mathbf{C}$.

1.23. **Proposition.** Let \mathbf{C} be a $(2, 1)$ -category and \mathbf{D} be a 1-category. Let $\mathbb{F}: \mathbf{C} \rightarrow \mathbf{D}$ be a 2-functor. Then the bilimit of \mathbb{F} , if it exists, can be expressed as either of the following two ordinary limits in \mathbf{D} :

$$\text{bilim}_{\mathbf{C}} \mathbb{F} \simeq \lim_{\tau_1\mathbf{C}} \tau_1\mathbb{F} \simeq \lim_{\mathbf{C}^{(1)}} \mathbb{F} \circ \iota$$

2. A 2-CATEGORICAL FRAMEWORK FOR FUSION THEORY

2.1. The classical Cartan-Eilenberg formula.

2.1. **Definition.** Let G be a finite group and S be a p -Sylow subgroup of G . The *fusion system* $\mathcal{F}_S(G)$ of G is the category with:

- *Objects:* the subgroups P of S .
- *Morphisms* $P \rightarrow Q$: the group morphisms $P \rightarrow Q$ induced by the conjugation action of G :

$$\mathcal{F}_S(G)(P, Q) = \{c_g : p \mapsto gpg^{-1} \mid g \in G, gPg^{-1} \subset Q\}.$$

- *Composition* is the composition of group morphisms.

The fusion system $\mathcal{F}_S(G)$ of a group G is canonically endowed with a forgetful functor to the category gp of finite groups:

$$U: \begin{cases} \mathcal{F}_S(G) & \rightarrow & \text{gp} \\ P & \mapsto & P \\ f & \mapsto & f \end{cases}$$

The Cartan-Eilenberg formula [CE56, Theorem 10.1] expresses the cohomology (with trivial coefficients) of a group G as a limit over the fusion system $\mathcal{F}_S(G)$ of G in the category $\mathbb{F}_p\text{Alg}^{\text{gr}}$ of graded \mathbb{F}_p -algebras:

2.2. Proposition. *For any finite group G and p -Sylow S of G :*

$$H^*(G; \mathbb{F}_p) \simeq \lim_{\mathcal{F}_S(G)^{\text{op}}} H^*(-; \mathbb{F}_p) \circ U$$

2.3. Definition. Let G be a finite group and S be a p -Sylow of G . The *transporter category* $\mathcal{T}_S(G)$ is the category with:

- *Objects:* the subgroups P of S .
- *Morphisms* $P \rightarrow Q$: the elements g of G such that $gPg^{-1} \subset Q$:

$$\mathcal{T}_S(G)(P, Q) = \{g \in G \mid gPg^{-1} \subset Q\}.$$

- *Composition* is given by the multiplication of G .

The transporter category $\mathcal{T}_S(G)$ of a group G is also canonically endowed with a forgetful functor to the category gp of finite groups:

$$U: \begin{cases} \mathcal{F}_S(G) & \rightarrow & \text{gp} \\ P & \mapsto & P \\ g & \mapsto & c_g : p \mapsto gpg^{-1} \end{cases}$$

This forgetful functor $U: \mathcal{T}_S(G) \rightarrow \text{gp}$ factors through $\mathcal{F}_S(G)$. The comparison functor $\pi: \mathcal{T}_S(G) \rightarrow \mathcal{F}_S(G)$ is the identity on objects and full.

$$\begin{array}{ccc} \mathcal{T}_S(G) & \xrightarrow{\pi} & \mathcal{F}_S(G) \\ & \searrow U & \swarrow U \\ & \text{gp} & \end{array}$$

Note that the functor π is a final functor, in the sense of [Mac71, §IX.3], since it is the identity on objects and full. Hence, there is a canonical isomorphism:

$$\lim_{\mathcal{F}_S(G)^{\text{op}}} H^*(-; \mathbb{F}_p) \circ U \simeq \lim_{\mathcal{T}_S(G)^{\text{op}}} H^*(-; \mathbb{F}_p) \circ U$$

In particular, the Cartan-Eilenberg formula can equivalently be stated as:

$$H^*(G; \mathbb{F}_p) \simeq \lim_{\mathcal{T}_S(G)^{\text{op}}} H^*(-; \mathbb{F}_p) \circ U$$

2.2. The extended transporter (2,1)-category of a group. We present a 2-categorification $\hat{\mathcal{T}}_S(G)$ of the transporter category. This 2-category will have a role similar to the one the fusion category $\mathcal{F}_S(G)$ and the transporter category $\mathcal{T}_S(G)$ have in the classical Cartan-Eilenberg formula.

Mostly for convenience, rather than restricting our attention to the category of finite groups gp , we should consider the (2, 1)-category of finite groupoids \mathbf{gpd} . It inherits all its structure of 2-category from the usual structure of 2-category on \mathbf{Cat} , the category of small categories, functors and natural transformations. The finite groups are viewed in \mathbf{gpd} as the groupoids with exactly one object. We should also note that the 2-morphisms of \mathbf{gpd} are relevant from the point of view of the fusion

in groups. Indeed, given two parallel morphisms $\phi, \psi: H \rightarrow G$ between groups, a 2-morphism $\phi \Rightarrow \psi$ is precisely an element g of G such that:

$$\forall h \in H, \phi(h) = g\psi(h)g^{-1}$$

The 2-full subcategory of \mathbf{gpd} with faithful functors as 1-morphisms is denoted by \mathbf{gpd}^f .

2.4. Definition. Let G be a group and S be a p -Sylow of G . Denote by $i: S \rightarrow G$ the inclusion, seen as a 1-morphism of \mathbf{gpd}^f . The *extended transporter category* $\hat{\mathcal{T}}_S(G)$ is the $(2, 1)$ -category with:

- *Objects:* the pairs $(P, j_P: P \rightarrow S)$ of a finite groupoid P and a faithful functor $j_P: P \rightarrow S$.
- *1-Morphisms* $(P, j_P) \rightarrow (Q, j_Q)$: the pairs (a, α) of a faithful functor $a: P \rightarrow Q$ and 2-morphisms $\alpha: ij_Q a \Rightarrow ij_P$ in \mathbf{gpd}^f .
- *2-Morphisms* $(a, \alpha) \Rightarrow (b, \beta)$: the 2-morphisms $\phi: \alpha \Rightarrow \beta$ in \mathbf{gpd}^f , such that:

$$\begin{array}{ccc} & G & \\ & \nearrow & \nwarrow \\ P & & Q \\ & \searrow & \nearrow \\ & G & \\ & \nwarrow & \nearrow \\ & P & \end{array} \begin{array}{c} \beta \Uparrow \\ \downarrow b \\ \phi \Uparrow \\ \downarrow a \end{array} \begin{array}{c} \nwarrow ij_Q \\ \downarrow \alpha \\ \nwarrow ij_P \end{array} = \begin{array}{ccc} & G & \\ & \nearrow & \nwarrow \\ P & & Q \\ & \searrow & \nearrow \\ & G & \\ & \nwarrow & \nearrow \\ & P & \end{array} \begin{array}{c} \downarrow \alpha \\ \downarrow a \end{array}$$

- *Compositions* are induced by the obvious pasting of diagrams in \mathbf{gpd}^f .

The extended transporter category is endowed with a forgetful 2-functor:

$$\mathbb{U}: \begin{cases} \hat{\mathcal{T}}_S(G) & \rightarrow \mathbf{gpd}^f \\ (P, j_P) & \mapsto P \\ (a, \alpha) & \mapsto a \\ \phi & \mapsto \phi \end{cases}$$

2.5. Remark. Since $i: S \rightarrow G$ is a faithful functor between 1-object groupoids, the factorization of a functor $i_P: P \rightarrow G$ through i , if it exists, is unique. Hence the objects of the transporter 2-category $\hat{\mathcal{T}}_S(G)$ could equivalently be described as pairs $(P, i_P: P \rightarrow G)$ such that the faithful functor i_P factors through i :

$$i_P = ij_P \text{ for some } j_P: P \rightarrow S$$

2.6. Remark. The underlying 1-category $\hat{\mathcal{T}}_S(G)^{(1)}$ is quite similar to the classical $\mathcal{T}_S(G)$. Actually, the main difference is the addition of finite coproducts. In section 4, we choose not to distinguish them. Since we are working with product-preserving functors (over the opposite categories), this is not really a problem.

2.7. Remark. Biequivalently, the extended transporter category $\hat{\mathcal{T}}_S(G)$ can be defined as follows, using generic constructions of bicategories. Consider the slice $(2, 1)$ -category \mathbf{gpd}^f/G . Then we can define the extended transporter category $\hat{\mathcal{T}}_S(G)$ as the 2-category of subobjects of (S, i) in \mathbf{gpd}^f/G , that is, the full, 2-full subcategory of \mathbf{gpd}^f/G over objects $(P, i_P: P \rightarrow G)$ such that i_P factors (up to some isomorphism) through $i: S \rightarrow G$:

$$\begin{array}{ccc} P & \xrightarrow{\quad} & S \\ & \searrow & \swarrow \\ & G & \end{array} \begin{array}{c} \exists \cong \\ \downarrow i_P \\ \downarrow i \end{array}$$

In this construction, the forgetful 2-functor

$$\mathbb{U}: \hat{\mathcal{T}}_S(G) \rightarrow \mathbf{gpd}^f$$

appears as the restriction of the forgetful 2-functor $\mathbf{gpd}^f/G \rightarrow \mathbf{gpd}^f$.

2.8. *Remark.* Note that there is a canonical way to recover the group G from the 2-functor \mathbb{U} as a pseudo bicolimit:

$$G \cong \operatorname{bicolim}_{\hat{\mathcal{T}}_S(G)} \mathbb{U}$$

Indeed there is a canonical way to endow G with a cocone structure over \mathbb{U} , hence to define a comparison morphism from the bilimit to G . Then, by noticing that the endomorphisms of the trivial group $(\{e\}, \{e\} \rightarrow S)$ in $\hat{\mathcal{T}}_S(G)$ is precisely the group G , one can construct another morphism from G to the bilimit, which is a pseudoinverse of the canonical comparison morphism. A detailed proof can be found in [Mai21a, Proposition 4.2.9].

3. GROUP REPRESENTATIONS AS BILIMITS

3.1. **Group representations as Mackey 2-functors.** In this section, \mathbb{k} is a commutative $\mathbb{Z}_{(p)}$ -algebra (that is, every prime integer different from p is invertible in \mathbb{k}), for instance a field of characteristic p .

3.1. **Notation.** Let G be a finite group.

- The category $\operatorname{mod}(\mathbb{k}G)$ is the category of \mathbb{k} -linear representations of finite dimension of the group G .
- The category $\operatorname{stmod}(\mathbb{k}G)$ is the stable category of \mathbb{k} -linear representations of finite dimension of the group G , for \mathbb{k} a field of characteristic p .
- The category $\operatorname{D}(\mathbb{k}G)$ is the (bounded) derived category of the finite dimensional $\mathbb{k}G$ -modules.

The three mappings $G \mapsto \operatorname{mod}(\mathbb{k}G)$, $G \mapsto \operatorname{stmod}(\mathbb{k}G)$ and $G \mapsto \operatorname{D}(\mathbb{k}G)$ extend to 2-functors $\mathbb{M}: (\mathbf{gpd}^f)^{\operatorname{op}} \rightarrow \mathbf{Add}$ from the opposite of the 2-category of finite groupoids (with faithful 1-morphisms), to the 2-category of small additive categories. The image $\mathbb{M}(f)$ of a group morphism $f: H \rightarrow G$, noted f^* , is the *restriction* along f ; similarly, given a 2-morphism $\alpha: f \Rightarrow g$ in \mathbf{gpd}^f , $\alpha^*: f^* \Rightarrow g^*$ denotes the image $\mathbb{M}(\alpha)$. We can see that these three 2-functors are *cohomological Mackey 2-functors with values in \mathbb{k} -linear idempotent-complete categories*, as we now explain.

3.2. **Definition.** A *Mackey 2-functor* is a 2-functor $\mathbb{M}: (\mathbf{gpd}^f)^{\operatorname{op}} \rightarrow \mathbf{Add}$ satisfying the following four axioms:

(Mack 1) *Additivity:* If $i_G: G \rightarrow G \sqcup H$ and $i_H: H \rightarrow G \sqcup H$ are the canonical inclusions into a coproduct of groupoids, then the induced functor

$$(i_G^*, i_H^*): \mathbb{M}(G \sqcup H) \rightarrow \mathbb{M}(G) \times \mathbb{M}(H)$$

is an equivalence.

(Mack 2) If $f: H \rightarrow G$ is a 1-morphism in \mathbf{gpd}^f , its image f^* has both a left adjoint $f_!$ and a right adjoint f_* :

$$f_! \dashv f^* \dashv f_*$$

(Mack 3) *Beck-Chevalley property:* For any 2-pullback square in \mathbf{gpd}^f (see notation 1.7)

$$\begin{array}{ccc} K & \xrightarrow{f} & G \\ (\underline{f}|g) \uparrow & \searrow \lambda & \uparrow g \\ (f|g) & \xrightarrow{(f|g)} & L \end{array}$$

the mates $\lambda_! : (f|g)_!(\underline{f}|g)^* \Rightarrow g^*f_!$ of λ^* and $(\lambda^{-1})_* : g^*f_* \Rightarrow (f|g)_*(\underline{f}|g)^*$ of $(\lambda^{-1})^*$ are invertible, where:

$$(3.3) \quad \lambda_! = \begin{array}{c} \text{---} (f|g)^* \text{---} (f|g)_! \\ | \qquad | \\ \bullet \qquad \bullet \\ | \qquad | \\ \text{---} \lambda^* \text{---} \\ | \qquad | \\ f_! \qquad g^* \end{array} \qquad \lambda_* = \begin{array}{c} f_* \qquad g^* \\ | \qquad | \\ \bullet \qquad \bullet \\ | \qquad | \\ \text{---} (\lambda^{-1})^* \text{---} \\ | \qquad | \\ (f|g)_* \qquad (f|g)^* \end{array}$$

(Mack 4) *Ambidexterity*: For any 1-morphism $f: H \rightarrow G$ in \mathbf{gpd}^f , the left and right adjoints of f^* are isomorphic:

$$f_! \simeq f_*$$

3.4. Notation. A 2-functor $\mathbb{M}: (\mathbf{gpd}^f)^{\text{op}} \rightarrow \mathbf{Cat}$ which only satisfies the axioms (Mack 2) and (Mack 3) is said to have the *Beck-Chevalley property*.

A 2-functor $\mathbb{M}: (\mathbf{gpd}^f)^{\text{op}} \rightarrow \mathbf{Cat}$ which only satisfies one half of the axioms (Mack 2) and (Mack 3) is said to have the *left Beck-Chevalley property* or *right Beck-Chevalley property*, accordingly.

3.5. Definition. A *cohomological Mackey 2-functor* is a Mackey 2-functor \mathbb{M} such that for any inclusion of groups $i: H \rightarrow G$ the composite natural transformation

$$\text{Id}_{\mathbb{M}(G)} \xrightarrow{\eta} i_*i^* \simeq i_!i^* \xrightarrow{\epsilon} \text{Id}_{\mathbb{M}(G)}$$

is equal to $[G : H]\sigma$, for some 2-isomorphism σ . In particular, if \mathbb{M} takes values in \mathbb{k} -linear categories, the composite natural transformation $\epsilon\eta$ above is invertible whenever $[G : H]$ is coprime to p , since \mathbb{k} is a $\mathbb{Z}_{(p)}$ -algebra.

The following comparison theorem between $\mathbb{M}(G)$ and the associated Eilenberg-Moore category appears in [BD21]; we reproduce here its short proof.

3.6. Theorem. *Let \mathbb{M} be a cohomological Mackey 2-functor (definition 3.2 and definition 3.5) with values in \mathbb{k} -linear idempotent-complete categories.*

Then, for any finite group G and subgroup $i: H \rightarrow G$ with $[G : H]$ coprime to p , the adjunction $i_! \dashv i^$ is monadic. That is, the canonical comparison functor*

$$\mathbb{M}(G) \rightarrow \mathbb{M}(H)^\Gamma$$

*is an equivalence, where $\Gamma = i^*i_!$ is the monad induced by i .*

Proof. Recall that $\epsilon: i_!i^* \Rightarrow \text{Id}_{\mathbb{M}(G)}$ is the counit of the adjunction $i_! \dashv i^*$ and $\eta: \text{Id}_{\mathbb{M}(G)} \Rightarrow i_*i^*$ is the unit of the adjunction $i^* \dashv i_*$.

Since \mathbb{M} is cohomological and $[G : H]$ is coprime to p , the natural transformation $\epsilon\eta$ is invertible. Hence ϵ admits a section, and the adjunction $i_! \dashv i^*$ is monadic, by [Bal15, Lemma 2.10]. \square

This naturally leads to the following definition:

3.7. Definition. A *p -monadic Mackey 2-functor* is a Mackey 2-functor \mathbb{M} such that, for any inclusion of groups $i: H \rightarrow G$ with index coprime to p , the canonical comparison functor

$$\mathbb{M}(G) \rightarrow \mathbb{M}(H)^\Gamma$$

is an equivalence, where $\Gamma = i^*i_!$ is the monad induced by i .

3.8. *Remark.* By theorem 3.6, any cohomological Mackey 2-functor with values in \mathbb{k} -linear idempotent-complete categories is p -monadic. This includes the 2-functors $\text{mod}(\mathbb{k}-)$, $\text{stmod}(\mathbb{k}-)$ and $\text{D}(\mathbb{k}-)$; other examples can be found in [BD20, Chapter 4].

For instance, the mapping $G \mapsto \text{coMack}_{\mathbb{k}}(G)$ associating to a group G the category of cohomological G -local Mackey 1-functors extends to a cohomological Mackey 2-functor. This is a corollary of [BD20, Proposition 7.3.2] applied to the cohomological Mackey 2-functor $S(G) = \text{perm}_{\mathbb{k}}(G)$ of permutations $\mathbb{k}G$ -modules and the Yoshida theorem [Web00], characterizing the category of cohomological Mackey 1-functors as

$$\text{coMack}_{\mathbb{k}}(G) \cong \text{Fun}_+(\text{perm}_{\mathbb{k}}(G), \text{Ab}).$$

3.2. The main theorem.

3.9. **Theorem.** *Let $\mathbb{M}: (\mathbf{gpd}^f)^{\text{op}} \rightarrow \mathbf{Add}$ be a p -monadic Mackey 2-functor (definition 3.7). Then, for any finite group G and any p -Sylow S of G , there is an equivalence*

$$\mathbb{M}(G) \cong \text{bilim}_{\hat{\mathcal{T}}_S(G)^{\text{op}}} \mathbb{M} \circ \mathbb{U}$$

where $\hat{\mathcal{T}}_S(G)$ is the extended transporter 2-category of G (definition 2.4).

Using the p -monadicity, theorem 3.9 is a corollary of the following result:

3.10. **Theorem.** *Let $\mathbb{M}: (\mathbf{gpd}^f)^{\text{op}} \rightarrow \mathbf{Cat}$ be a 2-functor with the left Beck-Chevalley property (notation 3.4).*

For any finite group G with a p -Sylow subgroup $i: S \rightarrow G$, there is an equivalence

$$\mathbb{M}(S)^{\mathbb{T}} \cong \text{bilim}_{\hat{\mathcal{T}}_S(G)^{\text{op}}} \mathbb{M} \circ \mathbb{U}$$

where $\mathbb{T} = i^*i_!$ is the monad induced by i .

3.11. *Remark.* The equivalence of theorem 3.10 is reminiscent of the Bénabou-Roubaud theorem [BR70]. This is actually an instance of a generalization to 2-categories; a more precise statement is in [Mai21a, Theorem 3.2.1]. Nonetheless, the essential arguments of the proof are already present in this article.

We will now construct the equivalence of theorem 3.10. Let L be the bilimit:

$$L = \text{bilim}_{\hat{\mathcal{T}}_S(G)^{\text{op}}} \mathbb{M} \circ \mathbb{U}$$

Its standard cone (definition 1.5) is denoted by \mathcal{L}_{\bullet} . In the rest of this section, we will:

- construct a functor $A: L \rightarrow \mathbb{M}(S)^{\mathbb{T}}$,
- construct a functor $B: \mathbb{M}(S)^{\mathbb{T}} \rightarrow L$, and
- show that the functors A and B are mutual pseudoinverses.

This will prove theorem 3.10.

3.3. **Construction of a comparison functor $L \rightarrow \mathbb{M}(S)^{\mathbb{T}}$.** Recall that $\mathbb{M}(S)^{\mathbb{T}}$ has a canonical structure of left module on \mathbb{T} consisting of the forgetful functor $U: \mathbb{M}(S)^{\mathbb{T}} \rightarrow \mathbb{M}(S)$ and a natural transformation $\bar{\mu}: \mathbb{T}U \Rightarrow U$. Moreover, it is terminal among the left modules on \mathbb{T} (proposition 1.17).

One can define a structure of left \mathbb{T} -module for the bilimit L as follows. There is an obvious functor $L \rightarrow \mathbb{M}(S)$, namely the component \mathcal{L}_S of the standard cone.

Hence, we have:

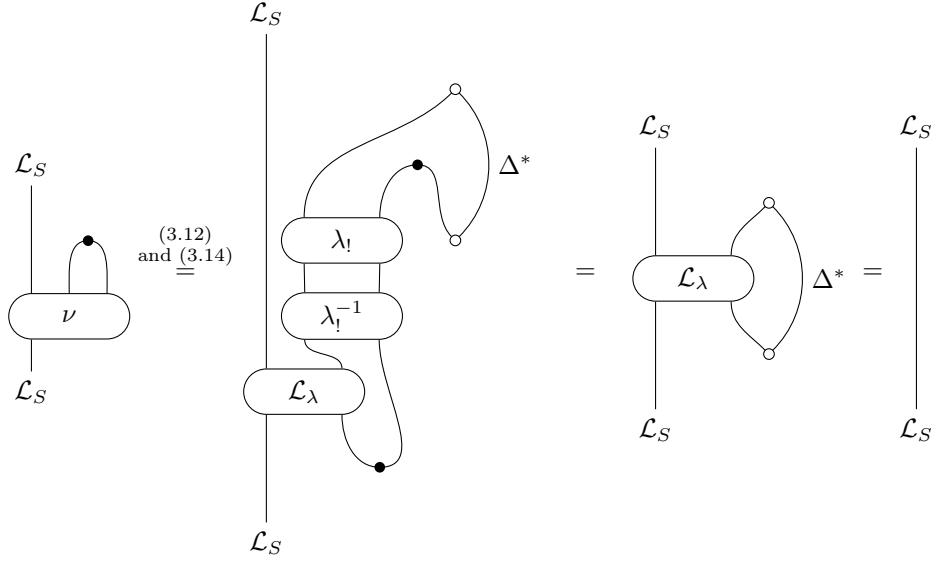

□

3.15. Proposition. *The action ν is associative.*

Proof. We introduce another 2-pullback square

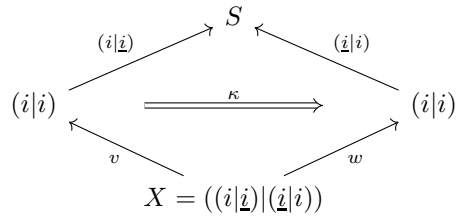

The universal property of $(i|i)$ allows us to define a morphism $\nabla: X \rightarrow (i|i)$ such that

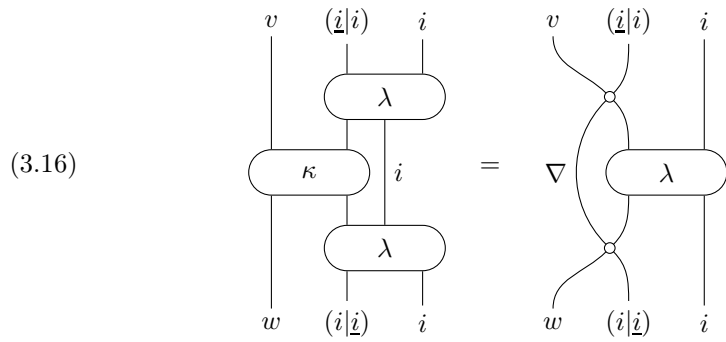

Applying the 2-functor \mathbb{M} on eq. (3.16) yields

$$(3.17) \quad \begin{array}{c} i^* \quad (\underline{i}|i)^* \quad v^* \\ \text{---} \lambda^* \text{---} \\ | \\ i^* \quad \text{---} \kappa^* \text{---} \\ | \\ \lambda^* \text{---} \\ | \\ i^* \quad (\underline{i}|\underline{i})^* \quad w^* \end{array} = \begin{array}{c} i^* \quad (\underline{i}|i)^* \quad v^* \\ \text{---} \lambda^* \text{---} \nabla^* \\ | \\ i^* \quad (\underline{i}|\underline{i})^* \quad w^* \end{array}$$

Similarly, the compatibility between the cone \mathcal{L} and the 2-morphisms of $\hat{\mathcal{T}}_S(G)$ provides the equation

$$(3.18) \quad \begin{array}{c} \mathcal{L}_S \quad (\underline{i}|i)^* \quad v^* \\ \text{---} \mathcal{L}_\lambda \text{---} \\ | \\ \mathcal{L}_S \quad \text{---} \kappa^* \text{---} \\ | \\ \mathcal{L}_\lambda \text{---} \\ | \\ \mathcal{L}_S \quad (\underline{i}|\underline{i})^* \quad w^* \end{array} = \begin{array}{c} \mathcal{L}_S \quad (\underline{i}|i)^* \quad v^* \\ \text{---} \mathcal{L}_\lambda \text{---} \nabla^* \\ | \\ \mathcal{L}_S \quad (\underline{i}|\underline{i})^* \quad w^* \end{array}$$

We can now prove the associativity of ν . We want to prove :

$$(3.19) \quad \begin{array}{c} \mathcal{L}_S \quad i! \quad i^* \quad i! \quad i^* \\ \text{---} \nu \text{---} \\ | \\ \nu \text{---} \\ | \\ \mathcal{L}_S \end{array} = \begin{array}{c} \mathcal{L}_S \quad i! \quad i^* \quad i! \quad i^* \\ \text{---} \nu \text{---} \\ | \\ \mathcal{L}_S \end{array}$$

Consider the mate $\kappa_!$ of κ^* :

$$\kappa_! = \begin{array}{c} v^* \quad w! \\ | \quad | \\ \text{---} \kappa^* \text{---} \\ | \\ (\underline{i}|\underline{i})! \quad (\underline{i}|i)^* \end{array}$$

Since λ_i and κ_i are invertible, eq. (3.19) is equivalent to the equation:

(3.20)

Expanding the definitions of ν and κ_i on the left-hand side of eq. (3.20) leads to the following computation:

(3.12)

(3.3)

Diagrammatic equation (3.18) showing the simplification of a product of two \mathcal{L}_λ boxes into a single \mathcal{L}_λ box with a ∇^* operator. The left side consists of two \mathcal{L}_λ boxes stacked vertically. The top box has inputs \mathcal{L}_S and $(i|i)^*$, and outputs v^* and $w!$. The bottom box has inputs \mathcal{L}_S and $(i|i)^*$, and outputs v^* and $w!$. A κ^* box is placed between them, with its inputs connected to the v^* and $w!$ outputs of the top box, and its outputs connected to the v^* and $w!$ outputs of the bottom box. The right side shows a single \mathcal{L}_λ box with inputs \mathcal{L}_S and $(i|i)^*$, and outputs v^* and $w!$. A ∇^* operator is placed to the right of the box, with its inputs connected to the v^* and $w!$ outputs of the box, and its outputs connected to the v^* and $w!$ outputs of the box. The equation is labeled (3.18) with an equals sign.

To simplify the right-hand side of eq. (3.20), first note that we have the following relation:

Diagrammatic equation (3.21) showing the simplification of a λ^* box with a ν box. The left side shows a ν box with inputs \mathcal{L}_S and $(i|i)^*$, and outputs \mathcal{L}_S and $(i|i)^*$. A λ^* box is placed to the right, with its inputs connected to the \mathcal{L}_S and $(i|i)^*$ outputs of the ν box, and its outputs connected to the \mathcal{L}_S and $(i|i)^*$ outputs of the ν box. The right side shows a $\lambda!$ box with inputs \mathcal{L}_S and $(i|i)^*$, and outputs \mathcal{L}_S and $(i|i)^*$. The equation is labeled (3.21) with an equals sign.

Diagrammatic equation (3.12) showing the simplification of a \mathcal{L}_λ box with a loop. The left side shows a \mathcal{L}_λ box with inputs \mathcal{L}_S and $(i|i)^*$, and outputs \mathcal{L}_S and $(i|i)^*$. A loop is formed by the \mathcal{L}_λ box and a \mathcal{L}_λ box. The right side shows a single \mathcal{L}_λ box with inputs \mathcal{L}_S and $(i|i)^*$, and outputs \mathcal{L}_S and $(i|i)^*$. The equation is labeled (3.12) with an equals sign.

Then, by expanding the definitions of $\lambda!$ and $\kappa!$ in the right-hand side of eq. (3.20), we get:

Diagrammatic equation (3.3) showing the expansion of $\lambda!$ and $\kappa!$ boxes. The left side shows a ν box with inputs \mathcal{L}_S and $(i|i)^*$, and outputs \mathcal{L}_S and $(i|i)^*$. Two $\lambda!$ boxes are placed to the right, with their inputs connected to the \mathcal{L}_S and $(i|i)^*$ outputs of the ν box, and their outputs connected to the \mathcal{L}_S and $(i|i)^*$ outputs of the ν box. A $\kappa!$ box is placed to the right, with its inputs connected to the \mathcal{L}_S and $(i|i)^*$ outputs of the ν box, and its outputs connected to the \mathcal{L}_S and $(i|i)^*$ outputs of the ν box. The right side shows a ν box with inputs \mathcal{L}_S and $(i|i)^*$, and outputs \mathcal{L}_S and $(i|i)^*$. Two λ^* boxes are placed to the right, with their inputs connected to the \mathcal{L}_S and $(i|i)^*$ outputs of the ν box, and their outputs connected to the \mathcal{L}_S and $(i|i)^*$ outputs of the ν box. A κ^* box is placed to the right, with its inputs connected to the \mathcal{L}_S and $(i|i)^*$ outputs of the ν box, and its outputs connected to the \mathcal{L}_S and $(i|i)^*$ outputs of the ν box. The equation is labeled (3.3) with an equals sign.

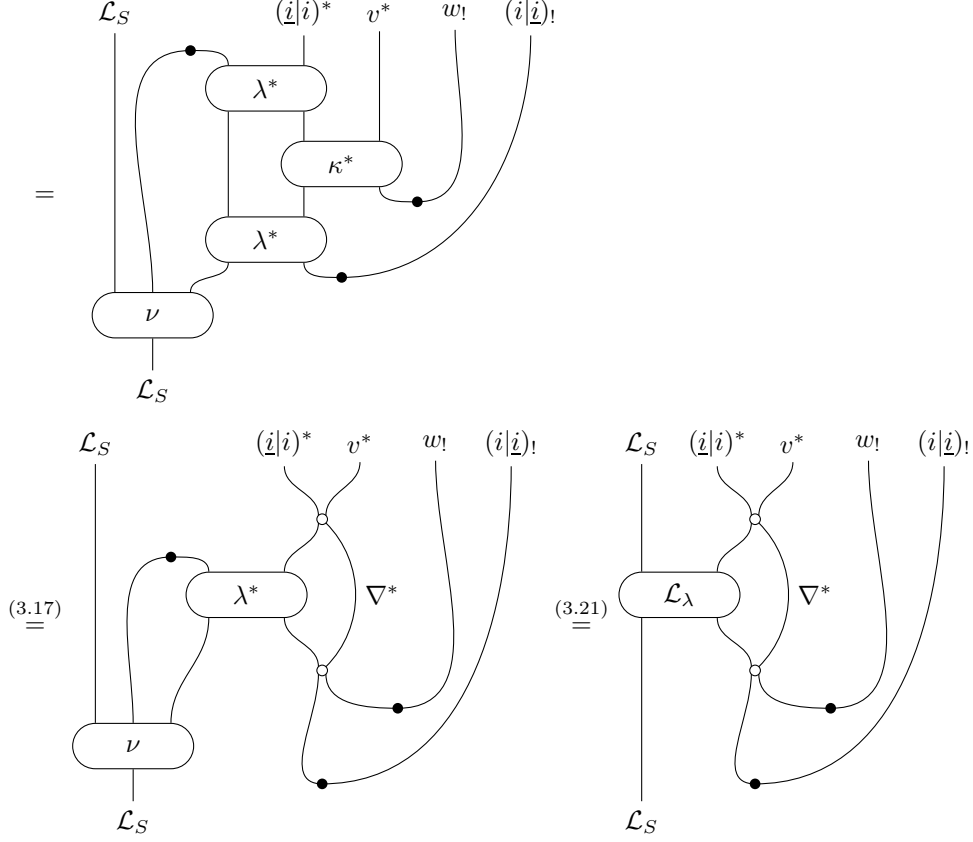

Thus eq. (3.20) holds, and so does eq. (3.19). □

By the universal property of $\mathbb{M}(S)^\top$ (proposition 1.17) applied to the left \mathbb{T} -module (L, \mathcal{L}_S, ν) , we have:

3.22. Proposition. *There is a unique functor $A: L \rightarrow \mathbb{M}(S)^\top$ fitting in the diagram*

$$\begin{array}{ccc}
 L & \xrightarrow{\quad A \quad} & \mathbb{M}(S)^\top \\
 \searrow \mathcal{L}_S & & \swarrow U \\
 & \mathbb{M}(S) &
 \end{array}$$

and satisfying $\bar{\mu}A = \nu$.

3.4. The comparison functor $\mathbb{M}(S)^\top \rightarrow L$. In the reverse direction, giving a functor $B: \mathbb{M}(S)^\top \rightarrow L$ is equivalent (definition 1.5) to giving a pseudonatural transformation $\phi: \Delta\mathbb{M}(S)^\top \Rightarrow \mathbb{M} \circ \cup$ between 2-functors $\hat{\mathcal{T}}_S(G) \rightarrow \mathbf{Cat}$. Define the components of ϕ as follows:

- for any object (P, j_P) of $\hat{\mathcal{T}}_S(G)$,

$$\phi_{(P, j_P)}: \mathbb{M}(S)^\top \xrightarrow{U} \mathbb{M}(S) \xrightarrow{j_P^*} \mathbb{M}(P)$$

- for any 1-morphism $(a, \alpha): (P, j_P) \rightarrow (Q, j_Q)$, that is a 1-morphism $a: P \rightarrow Q$ and a 2-morphism $\alpha: ij_Q a \Rightarrow ij_P$ in \mathbf{gpd}^f ,

$$(3.23) \quad \phi_{(a,\alpha)} = \begin{array}{c} U \qquad j_Q^* \ a^* \\ | \qquad | \\ \bullet \\ | \\ \text{---} \alpha^* \text{---} \\ | \\ U \qquad j_P^* \\ | \\ U \end{array}$$

3.24. Proposition. *The natural transformation $\phi_{(a,\alpha)}$ is invertible.*

Proof. Consider

$$\psi_{(a,\alpha)} = \begin{array}{c} U \qquad j_P^* \\ | \qquad | \\ \bullet \\ | \\ \text{---} (\alpha^*)^{-1} \text{---} \\ | \\ U \qquad j_Q^* \ a^* \\ | \\ U \end{array}$$

We can check, using the associativity and the unitality of the action $\bar{\mu}$, and the definition of the multiplication μ of \mathbb{T} , that $\psi_{(a,\alpha)} \circ \phi_{(a,\alpha)} = \text{Id}$ and $\phi_{(a,\alpha)} \circ \psi_{(a,\alpha)} = \text{Id}$. \square

3.25. Proposition. *The family of functors and natural transformations ϕ is a pseudonatural transformation $\phi: \Delta\mathbb{M}(S)^\mathbb{T} \Rightarrow \mathbb{M} \circ \mathbb{U}$.*

Proof. This is done by the following straightforward computations.

$$\phi_{(\text{Id}, \text{Id})} = \begin{array}{c} U \qquad j_P^* \\ | \qquad | \\ \bullet \\ | \\ \text{---} \text{Id}^* \text{---} \\ | \\ U \qquad j_P^* \\ | \\ U \end{array} = \begin{array}{c} U \qquad j_P^* \\ | \qquad | \\ \bullet \\ | \\ \text{---} \text{---} \\ | \\ U \qquad j_P^* \\ | \\ U \end{array} = \begin{array}{c} U \qquad j_P^* \\ | \qquad | \\ U \qquad j_P^* \end{array} = \text{Id}_{j_P^* U}$$

For any composable morphisms $(a, \alpha): (P, j_P) \rightarrow (Q, j_Q)$ and $(b, \beta): (Q, j_Q) \rightarrow (R, j_R)$, using the associativity of the action $\bar{\mu}$ and the definition of the multiplication μ of

the monad \mathbb{T} :

$$\begin{aligned}
 \phi_{(a,\alpha)} \circ a^* \phi_{(b,\beta)} &= \begin{array}{c} U \quad j_R^* \quad b^* \quad a^* \\ \beta^* \\ \bar{\mu} \\ \alpha^* \\ \bar{\mu} \\ U \quad j_P^* \end{array} = \begin{array}{c} U \quad j_R^* \quad b^* \quad a^* \\ \beta^* \\ \mu \\ \bar{\mu} \\ U \quad j_P^* \end{array} \\
 &= \begin{array}{c} U \quad j_R^* \quad b^* \quad a^* \\ \beta^* \\ \alpha^* \\ \bar{\mu} \\ U \quad j_P^* \end{array} = \begin{array}{c} U \quad j_R^* \quad b^* \quad a^* \\ \alpha^* \circ a^* \beta^* \\ \bar{\mu} \\ U \quad j_P^* \end{array} \\
 &= \phi_{(b,\beta) \circ (a,\alpha)}
 \end{aligned}$$

For any 2-morphism $\zeta: (a, \alpha) \Rightarrow (b, \beta)$ between parallel morphisms $(P, j_P) \rightarrow (Q, j_Q)$ in $\widehat{\mathcal{T}}_S(G)$, we compute:

$$\begin{aligned}
 \phi_{(b,\beta)} \circ \phi_{(Q,j_Q)}(\zeta^*) &= \begin{array}{c} U \quad j_Q^* \quad a^* \\ \zeta^* \\ \beta^* \\ \bar{\mu} \\ U \quad j_P^* \end{array} = \begin{array}{c} U \quad j_Q^* \quad a^* \\ \alpha^* \\ \bar{\mu} \\ U \quad j_P^* \end{array} = \phi_{(a,\alpha)}
 \end{aligned}$$

These equalities show the pseudonaturality of ϕ . □

Hence, by the universal property of the bilimit:

3.26. Proposition. *There exists a unique (up-to 2-isomorphism) functor*

$$B: \mathbb{M}(S)^\mathbb{T} \rightarrow L$$

and a modification $m: \phi \cong \mathcal{L} \cdot B$.

3.5. The functors A and B are mutually pseudoinverse.

3.27. Proposition. *The composite $AB: \mathbb{M}(S)^\mathbb{T} \rightarrow \mathbb{M}(S)^\mathbb{T}$ is isomorphic to the identity functor.*

them. On any object (P, j_P) define n_P as

$$n_P: \tilde{\mathcal{L}}_P = \mathcal{L}_P B A \xrightarrow{m_P A} \phi_P A = j_P^* U A = j_P^* \mathcal{L}_S = \mathcal{L}_P$$

The family of morphisms (n_P) is an invertible modification between the cones $\tilde{\mathcal{L}}$ and ϕA . Thus, it suffices to check that ϕA and \mathcal{L} are indeed the same cones. Their components at any object (P, j_P) coincide; we still have to check that the components at any morphism (a, α) are equal.

At the morphism $(\text{Id}, \lambda) : ((i|i), (i|\underline{i})) \rightarrow ((i|i), (\underline{i}|i))$ of $\hat{\mathcal{T}}_S(G)$, we have:

$$\begin{aligned} \phi_{(\text{Id}, \lambda)} A &= \begin{array}{c} A \quad U \quad (i|i)^* \\ | \quad | \quad | \\ | \quad | \quad | \\ | \quad | \quad | \\ A \quad U \quad (i|\underline{i})^* \end{array} \quad \stackrel{(3.22)}{=} \quad \begin{array}{c} \mathcal{L}_S \quad (i|i)^* \\ | \quad | \\ | \quad | \\ | \quad | \\ \mathcal{L}_S \quad (i|\underline{i})^* \end{array} \\ &\stackrel{(3.12)}{=} \begin{array}{c} \mathcal{L}_S \quad (i|i)^* \\ | \quad | \\ | \quad | \\ | \quad | \\ \mathcal{L}_\lambda \quad \lambda^{-1} \end{array} \quad \stackrel{(3.3)}{=} \quad \begin{array}{c} \mathcal{L}_S \quad (i|i)^* \\ | \quad | \\ | \quad | \\ | \quad | \\ \mathcal{L}_\lambda \quad \lambda^{-1} \end{array} \\ &\stackrel{(3.3)}{=} \begin{array}{c} \mathcal{L}_S \quad (i|i)^* \\ | \quad | \\ | \quad | \\ | \quad | \\ \mathcal{L}_\lambda \quad (i|\underline{i})^* \end{array} = \mathcal{L}_\lambda \end{aligned}$$

For any morphism $(a, \alpha) : (P, j_P) \rightarrow (Q, j_Q)$ there is a (unique) morphism of groupoids $\nabla_\alpha : P \rightarrow (i|i)$ such that

$$(i|\underline{i})\nabla_\alpha = j_Q a \quad (i|\underline{i})\nabla_\alpha = j_P \quad \lambda \nabla_\alpha = \alpha$$

Hence,

$$\phi_{(a, \alpha)} A = \begin{array}{c} A \quad U \quad j_Q^* a^* \\ | \quad | \quad | \\ | \quad | \quad | \\ | \quad | \quad | \\ A \quad U \quad j_P^* \end{array} = \begin{array}{c} A \quad U \quad j_Q^* a^* \\ | \quad | \quad | \\ | \quad | \quad | \\ | \quad | \quad | \\ A \quad U \quad j_P^* \end{array} \quad \nabla_\alpha^*$$

4.3. Proposition. *The category $L_{\mathbb{D}}$, with its canonical cone, is a bilimit of \mathbb{D} :*

$$L_{\mathbb{D}} \cong \underset{\mathbf{I}}{\text{bilim}} \mathbb{D}$$

Proof. The category $L_{\mathbb{D}}$ is an explicit description of the category $[\Delta 1, \mathbb{D}]$ of the (pseudo)cones over \mathbb{D} with vertex 1, the category with exactly one object and its identity morphism.

In turn, $[\Delta 1, \mathbb{D}]$ is a model of the bilimit of \mathbb{D} by the following classical equivalence, pseudonatural in $X \in \mathbf{Cat}$:

$$\mathbf{Cat}(X, [\Delta 1, \mathbb{D}]) \cong \mathbf{Cat}(1, [\Delta X, \mathbb{D}]) \cong [\Delta X, \mathbb{D}]$$

□

We now fix a 2-diagram $\mathbb{D}: \mathbf{I} \rightarrow \mathbf{Cat}$ and two objects d, d' of $L_{\mathbb{D}}$. By definition:

$$(4.4) \quad L_{\mathbb{D}}(d, d') = \{(\delta_i: d_i \rightarrow d'_i)_i \mid \text{the squares (4.2) commute}\}$$

We can define an associated 1-diagram on the underlying 1-category $\mathbf{I}^{(1)}$ of \mathbf{I} , obtained by forgetting the 2-morphisms, as follows:

4.5. Definition. The diagram $\mathbb{D}_{d,d'}: \mathbf{I}^{(1)} \rightarrow \mathbf{Set}$ is:

$$\mathbb{D}_{d,d'}: \begin{cases} i & \mapsto \mathbb{D}i(d_i, d'_i) \\ f: i \rightarrow j & \mapsto \mathbb{D}j(d_f^{-1}, d'_f) \circ \mathbb{D}f \end{cases}$$

4.6. Proposition. *There is an isomorphism:*

$$L_{\mathbb{D}}(d, d') \simeq \lim_{\mathbf{I}^{(1)}} \mathbb{D}_{d,d'}$$

Proof. The limit $\lim_{\mathbf{I}^{(1)}} \mathbb{D}_{d,d'}$ has an explicit description, as a limit in \mathbf{Set} :

$$\lim_{\mathbf{I}^{(1)}} \mathbb{D}_{d,d'} = \{(\delta_i \in \mathbb{D}_{d,d'}(i))_i \mid \forall f: i \rightarrow j, \mathbb{D}_{d,d'}(f)(\delta_i) = \delta_j\}$$

Unfolding the definitions, we precisely get back the set of (4.4). □

4.7. Remark. The expression of the diagram $\mathbb{D}_{d,d'}$ simplifies when the objects d and d' are such that, for all $f: i \rightarrow j$, $d_f = d'_f = \text{Id}$:

$$\mathbb{D}_{d,d'}: \begin{cases} i & \mapsto \mathbb{D}i(d_i, d'_i) \\ f: i \rightarrow j & \mapsto \mathbb{D}f \end{cases}$$

4.8. Example. We can use these results to recover the Cartan-Eilenberg formula for the Tate cohomology $\hat{H}^*(G; \mathbb{k})$ of a finite group G over a field \mathbb{k} of characteristic p . Indeed, for any finite group G , the Tate cohomology groups can be recovered as Hom-sets of $\text{stmod}(\mathbb{k}G)$:

$$\text{stmod}(\mathbb{k}G)(\Omega^n \mathbb{k}, \mathbb{k}) = \hat{H}^n(G; \mathbb{k})$$

Fix a finite group G and a p -Sylow S of G . We consider the 2-diagram:

$$\mathbb{D} = \text{stmod}(\mathbb{k}-) \circ \cup: \hat{\mathcal{T}}_S(G)^{\text{op}} \rightarrow \mathbf{Cat}$$

Note that, for any n , $\Omega^n \mathbb{k} \in \text{stmod}(\mathbb{k}G)$ can be seen as an object of $L_{\mathbb{D}}$ satisfying the conditions of remark 4.7. Hence we have:

$$\begin{aligned} \hat{H}^n(G; \mathbb{k}) &= \text{stmod}(\mathbb{k}G)(\Omega^n \mathbb{k}, \mathbb{k}) \\ &\simeq \lim_{P \in \hat{\mathcal{T}}_S(G)^{\text{op}}} \text{stmod}(\mathbb{k}P)(\Omega^n \mathbb{k}, \mathbb{k}) \\ &= \lim_{P \in \hat{\mathcal{T}}_S(G)^{\text{op}}} \hat{H}^n(P; \mathbb{k}) \end{aligned}$$

The Cartan-Eilenberg formula for the usual group cohomology $H^*(G; \mathbb{k})$ can be similarly recovered from the 2-functor $\text{D}(\mathbb{k}-)$.

4.2. Categorical invariants. Another way to exploit theorem 3.9 is to try to factor \mathbb{M} as a composite of two 2-functors

$$\mathbb{M}: (\mathbf{gpd}^f)^{\text{op}} \xrightarrow{\tilde{\mathbb{M}}} \mathbf{C} \xrightarrow{W} \mathbf{Cat}$$

where $\tilde{\mathbb{M}}$ is product preserving, $W: \mathbf{C} \rightarrow \mathbf{Cat}$ reflects bilimits, and to find a bilimit-preserving 2-functor

$$H: \mathbf{C} \rightarrow \mathbf{D}$$

to a 1-category \mathbf{D} . In this case, for any finite group G with p -Sylow S :

$$\begin{aligned} H \circ \tilde{\mathbb{M}}(G) &\simeq H\left(\text{bilim}_{\hat{\mathcal{T}}_S(G)^{\text{op}}} \tilde{\mathbb{M}} \circ U\right) \\ (4.9) \quad &\simeq \text{bilim}_{\hat{\mathcal{T}}_S(G)^{\text{op}}} H \circ \tilde{\mathbb{M}} \circ U \\ &\simeq \lim_{\mathcal{T}_S(G)^{\text{op}}} H \circ \tilde{\mathbb{M}} \circ U \quad (\text{by proposition 1.23}) \end{aligned}$$

4.10. Example. We sketch an example of application, taking $\mathbb{M} = \text{stmod}(\mathbb{k}-)$. We can factor it through the 2-category $\mathbf{Add}_{\bullet}^{\text{gr}}$ of graded additive categories with a distinguished object, choosing the trivial module \mathbb{k} in each $\text{stmod}(\mathbb{k}G)$ and graduating by the Heller shift Ω . The forgetful functor $\mathbf{Add}_{\bullet}^{\text{gr}} \rightarrow \mathbf{Cat}$ reflects bilimits. Then consider the well-defined bilimit-preserving 2-functor to the 1-category of rings:

$$H: \begin{cases} \mathbf{Add}_{\bullet}^{\text{gr}} & \rightarrow \text{Ring} \\ (C, \bullet_C) & \mapsto C^*(\bullet_C, \bullet_C) \\ (F: C \rightarrow D, u: F(\bullet_C) \xrightarrow{\sim} \bullet_D) & \mapsto D(u^{-1}, u) \circ F \\ \alpha & \mapsto \text{Id} \end{cases}$$

Note that, for any finite group G :

$$H \circ \tilde{\mathbb{M}}(G) = \text{stmod}(\mathbb{k}G)^*(\mathbb{k}, \mathbb{k}) = \hat{H}^*(G; \mathbb{k})$$

Hence by eq. (4.9), we obtain the same Cartan-Eilenberg formula as in example 4.8:

$$\begin{aligned} \hat{H}^*(G; \mathbb{k}) &= H \circ \tilde{\mathbb{M}}(G) \\ &\simeq \lim_{\mathcal{T}_S(G)} H \circ \tilde{\mathbb{M}} \circ U \\ &= \lim_{P \in \mathcal{T}_S(G)} \hat{H}^*(P; \mathbb{k}) \end{aligned}$$

It would be interesting to find other factorizations and bilimit-preserving 2-functors H with value in a 1-category for the various p -monadic Mackey 2-functors: this would give possibly new “Cartan-Eilenberg formulas”.

REFERENCES

- [Bal15] Paul Balmer. “Stacks of Group Representations”. In: *Journal of the European Mathematical Society* 17.1 (2015), pp. 189–228. ISSN: 1435-9855. DOI: 10.4171/JEMS/501.
- [BD20] Paul Balmer and Ivo Dell’Ambrogio. *Mackey 2-Functors and Mackey 2-Motives*. Zuerich, Switzerland: European Mathematical Society Publishing House, July 31, 2020. ISBN: 978-3-03719-209-2. DOI: 10.4171/209.
- [BD21] Paul Balmer and Ivo Dell’Ambrogio. *Cohomological Mackey 2-Functors*. 2021. arXiv: 2103.03974 [math.CT]. Preprint.
- [BR70] Jean Bénabou and Jacques Roubaud. “Monades et Descente”. In: *C. R. Acad. Sci. Paris Sér. A-B* 270 (1970), A96–A98. ISSN: 0151-0509.
- [CE56] Henri Cartan and Samuel Eilenberg. *Homological Algebra*. Princeton University Press, Princeton, N. J., 1956, pp. xv+390.

- [JY21] Niles Johnson and Donald Yau. *2 Dimensional Categories*. New York: Oxford University Press, 2021. ISBN: 978-0-19-887137-8.
- [Mac71] Mac Lane Saunders. *Categories for the Working Mathematician*. Graduate Texts in Mathematics. New York: Springer-Verlag, 1971. ISBN: 978-0-387-90036-0.
- [Mai21a] Jun Maillard. “Finite Group Representations through 2-Sheaves”. PhD thesis. Université de Lille, 2021.
- [Mai21b] Jun Maillard. *On 2-Final 2-Functors*. 2021. arXiv: 2101.08727 [math.CT]. Preprint, 16 pages.
- [Par17] Sejong Park. “Mislin’s Theorem for Fusion Systems through Mackey Functors”. In: *Communications in Algebra* 45.4 (Apr. 3, 2017), pp. 1409–1415. ISSN: 0092-7872, 1532-4125. DOI: 10.1080/00927872.2016.1175607.
- [Web00] Peter Webb. “A Guide to Mackey Functors”. In: *Handbook of Algebra, Vol. 2*. Vol. 2. Handb. Algebr. Elsevier/North-Holland, Amsterdam, 2000, pp. 805–836.

UNIV. LILLE, CNRS, UMR 8524 - LABORATOIRE PAUL PAINLEVÉ, F-59000 LILLE, FRANCE
Email address: jun.maillard@gmail.com
URL: <http://math.univ-lille1.fr/~jmaillard>