

CF-MOVES FOR VIRTUAL LINKS

KODAI WADA

ABSTRACT. Oikawa defined an unknotting operation on virtual knots, called a CF-move, and gave a classification of 2-component virtual links up to CF-moves by the virtual linking number and his n -invariant. In particular, it was proved that a CF-move characterizes the information contained in the virtual linking number for 2-component odd virtual links. In this paper, we extend this result by classifying odd virtual links and almost odd virtual links with arbitrary number of components up to CF-moves, using the virtual linking number. Moreover, we extend Oikawa's n -invariant and introduce two invariants for 3-component even virtual links. Using these invariants together with the virtual linking number, we classify 3-component even virtual links up to CF-moves. As a result, a classification of 3-component virtual links up to CF-moves is provided.

1. INTRODUCTION

Virtual links were introduced by Kauffman in [4] as a generalization of classical links in the 3-sphere. For an integer $\mu \geq 1$, a μ -component virtual link diagram is the image of an immersion of μ circles into the plane, whose singularities are only transverse double points. Such double points are divided into *classical crossings* and *virtual crossings* as shown in Figure 1.1. A μ -component virtual link is an equivalence class of μ -component virtual link diagrams under *generalized Reidemeister moves*, which consist of classical Reidemeister moves R1–R3 and virtual Reidemeister moves V1–V4 as shown in Figure 1.2. A 1-component virtual link is also called a *virtual knot*. Throughout this paper, all virtual links are assumed to be ordered and oriented.

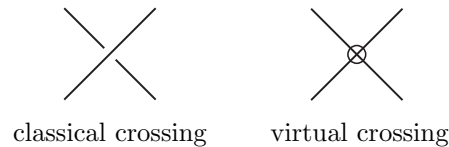

FIGURE 1.1. Two types of double points on virtual link diagrams

In virtual knot and link theory, we do not allow to use two local moves as shown in Figure 1.3. These moves are called the *forbidden moves*. Any virtual knot can be deformed into the trivial knot by forbidden moves (cf. [2, 3, 8]). Generally, the μ -component virtual links $L = K_1 \cup \cdots \cup K_\mu$ up to forbidden moves are classified by the (i, j) -linking numbers $\text{Lk}(K_i, K_j) \in \mathbb{Z}$ ($1 \leq i \neq j \leq \mu$) completely (cf. [1, 7, 10]).

2020 *Mathematics Subject Classification*. Primary 57K12; Secondary 57K10.

Key words and phrases. virtual link, crossing change, forbidden move, CF-move, linking number, Gauss diagram.

This work was supported by JSPS KAKENHI Grant Number JP19J00006.

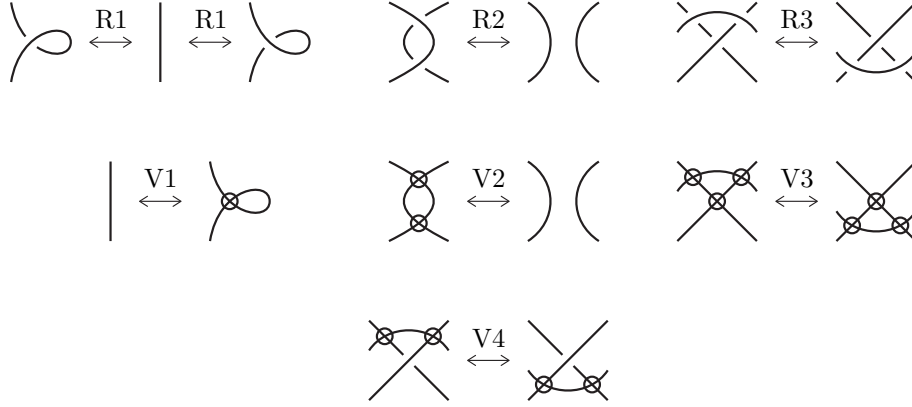

FIGURE 1.2. Generalized Reidemeister moves



FIGURE 1.3. Forbidden moves

A *CF-move* introduced by Oikawa in [9] is a local move on virtual link diagrams as shown in Figure 1.4. It is considered as a combination of crossing changes and a forbidden move. Two virtual links are *CF-equivalent* if their diagrams are related by a finite sequence of generalized Reidemeister moves and CF-moves. In [9, Theorem 1.2], Oikawa proved that any virtual knot is CF-equivalent to the trivial knot, i.e. a CF-move is an unknotting operation. Moreover, he defined an invariant $n(L) \in \mathbb{N} \cup \{0\}$ of a 2-component virtual link $L = K_1 \cup K_2$ with $\text{Lk}(K_1, K_2) \equiv \text{Lk}(K_2, K_1) \pmod{2}$. Then using the virtual linking number $\text{vlk}(K_1, K_2) = -\frac{1}{2}(\text{Lk}(K_1, K_2) - \text{Lk}(K_2, K_1))$ and $n(L)$, a classification of 2-component virtual links up to CF-equivalence was given in [9, Theorem 1.7] as follows.

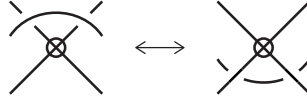

FIGURE 1.4. A CF-move

Theorem 1.1 ([9]). *Let $L = K_1 \cup K_2$ and $L' = K'_1 \cup K'_2$ be 2-component virtual links.*

- (i) *Assume that $\text{vlk}(K_1, K_2)$ is not an integer. Then L and L' are CF-equivalent if and only if $\text{vlk}(K_1, K_2) = \text{vlk}(K'_1, K'_2)$.*
- (ii) *Assume that $\text{vlk}(K_1, K_2)$ is an integer. Then L and L' are CF-equivalent if and only if $\text{vlk}(K_1, K_2) = \text{vlk}(K'_1, K'_2)$ and $n(L) = n(L')$.*

This paper aims to extend this theorem to virtual links with three or more components. To this end, we consider the *parity* for every component of a μ -component virtual link $L = K_1 \cup \dots \cup K_\mu$. For $1 \leq i \leq \mu$, the i th component K_i of

L is called *odd* if one encounters an odd number of classical crossings in going along the i th component of a diagram of L ; otherwise it is called *even*. We say that L is *odd* if every component of L is odd. On the other hand, we say that L is *even* if every component of L is even (cf. [6]). For example, all virtual knots and classical links are even. In the case $\mu = 2$, it follows that $L = K_1 \cup K_2$ is odd if and only if $\text{vlk}(K_1, K_2)$ is not an integer, and that it is even if and only if $\text{vlk}(K_1, K_2)$ is an integer. There are virtual links with three or more components that are neither odd nor even. In particular, we say that L is *almost odd* if some component of L is even and the other components are odd. We remark that if L is odd, then μ is an even integer. On the other hand, if L is almost odd, then μ is an odd integer.

For odd virtual links and almost odd virtual links, we have the following.

Theorem 1.2. *For two μ -component odd or almost odd virtual links $L = K_1 \cup \dots \cup K_\mu$ and $L' = K'_1 \cup \dots \cup K'_\mu$, the following are equivalent.*

- (i) L and L' are CF-equivalent.
- (ii) $\text{Lk}(K_i, K_j) - \text{Lk}(K_j, K_i) = \text{Lk}(K'_i, K'_j) - \text{Lk}(K'_j, K'_i)$ for any $1 \leq i < j \leq \mu$.

By the classification of welded links, which are a quotient of virtual links by the “over” forbidden move in the left of Figure 1.3, up to crossing changes given in [1, Theorem 1], Theorem 1.2 means that CF-equivalence coincides with the equivalence relation generated by crossing changes and forbidden moves for odd virtual links and almost odd virtual links. Note that the difference $\text{Lk}(K_i, K_j) - \text{Lk}(K_j, K_i)$ in Theorem 1.2 is written as $\text{vlk}_{ij} - \text{vlk}_{ji}$ in [1]. For odd virtual links and almost odd virtual links, a CF-move is indeed a combination of crossing changes and a forbidden move.

For even virtual links, we only consider the case of three components. For a 3-component even virtual link $L = K_1 \cup K_2 \cup K_3$, we define an invariant $n(K_i, K_j) \in \mathbb{N} \cup \{0\}$ ($1 \leq i < j \leq 3$) as an extension of Oikawa’s n -invariant given in [9] (Definition 4.3). Moreover, we introduce two invariants $\tau_0(L), \tau_1(L) \in \mathbb{Z}$ of L (Definition 4.7). Then we have the following.

Theorem 1.3. *For two 3-component even virtual links $L = K_1 \cup K_2 \cup K_3$ and $L' = K'_1 \cup K'_2 \cup K'_3$, the following are equivalent.*

- (i) L and L' are CF-equivalent.
- (ii) $\text{Lk}(K_i, K_j) - \text{Lk}(K_j, K_i) = \text{Lk}(K'_i, K'_j) - \text{Lk}(K'_j, K'_i)$ and $n(K_i, K_j) = n(K'_i, K'_j)$ for any $1 \leq i < j \leq 3$, and $\tau_0(L) - \tau_1(L) = \tau_0(L') - \tau_1(L')$.

Since a 3-component virtual link is either almost odd or even, a complete classification of 3-component virtual links up to CF-equivalence is provided by Theorems 1.2 and 1.3.

2. GAUSS DIAGRAMS UP TO CF-MOVES

In this section, we review the definition of Gauss diagrams and give a normal form of a μ -component virtual link up to CF-equivalence in terms of Gauss diagrams (Proposition 2.3).

A *Gauss diagram* is a disjoint union of ordered and oriented circles together with signed and oriented chords whose endpoints lie disjointly on the circles. Throughout this paper, all circles of a Gauss diagram are assumed to be oriented counterclockwise and arranged in increasing order from left to right. A chord in a Gauss diagram is called a *self-chord* if both endpoints lie on the same circle of the Gauss diagram;

otherwise it is called a *nonsel-chord*. In particular, a self-chord is *free* if its endpoints are adjacent on the circle. Aonsel-chord is *of type (i, j)* if it is oriented from the i th circle to the j th one ($i \neq j$).

Given a μ -component virtual link diagram with n classical crossings, its Gauss diagram is defined to be the union of μ circles and n chords connecting the preimage of each classical crossing. Each chord is equipped with the sign of the corresponding classical crossing, and oriented from the over-crossing to the under-crossing. By definition, the virtual Reidemeister moves V1–V4 on virtual link diagrams do not affect the corresponding Gauss diagrams. On the other hand, the classical Reidemeister moves R1–R3 change the Gauss diagrams as shown in Figure 2.1. Here, there are several kinds of R3 depending on the signs and orientations of chords, and one of them is shown in the figure. The others are generated by R1, R2, and this R3 (cf. [11]). Therefore, a virtual link can be considered as an equivalence class of Gauss diagrams under Reidemeister moves R1–R3 (cf. [2, 4]).

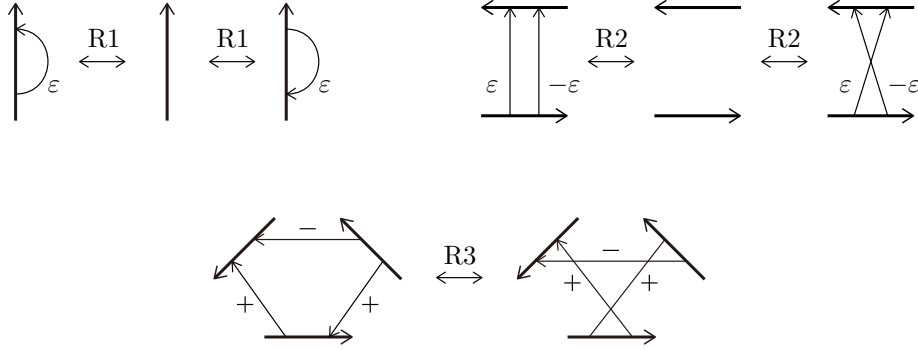

FIGURE 2.1. Reidemeister moves on Gauss diagrams with $\varepsilon \in \{\pm 1\}$

A *CF-move* on Gauss diagrams is a local move as shown in Figure 2.2. Two Gauss diagrams G and G' are *CF-equivalent* if they are related by a finite sequence of Reidemeister moves R1–R3 and CF-moves. It is denoted by $G \sim G'$. We emphasize that two virtual links are CF-equivalent if and only if their Gauss diagrams are CF-equivalent.

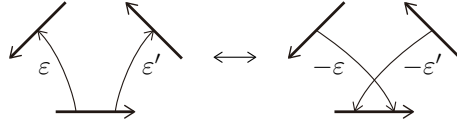

FIGURE 2.2. A CF-move on Gauss diagrams with $\varepsilon, \varepsilon' \in \{\pm 1\}$

Lemma 2.1. *If two Gauss diagrams are related by a local move as shown in Figure 2.3, then they are CF-equivalent.*

Proof. The proof in the case $\varepsilon\varepsilon' = 1$ follows from Figure 2.4, and that in the case $\varepsilon\varepsilon' = -1$ follows from Figure 2.5. \square

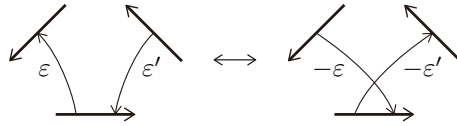

FIGURE 2.3. Exchanging two consecutive initial and terminal endpoints of a pair of chords

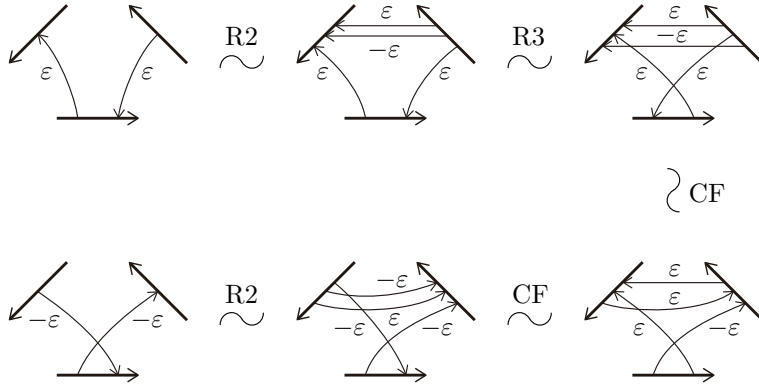

FIGURE 2.4. Proof of Lemma 2.1 in the case $\varepsilon\varepsilon' = 1$

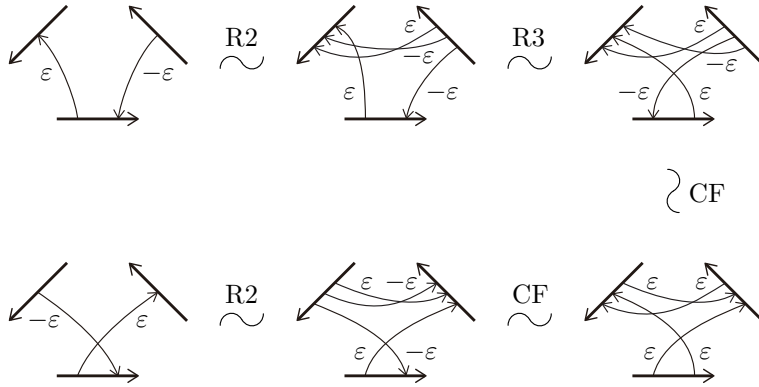

FIGURE 2.5. Proof of Lemma 2.1 in the case $\varepsilon\varepsilon' = -1$

Remark 2.2. By Lemma 2.1, any two consecutive endpoints of a pair of chords γ and γ' can be exchanged up to CF-equivalence, although the signs and orientations of γ and γ' are altered. Therefore, up to CF-equivalence, we can deform every self-chord in a Gauss diagram into a free chord, and remove it by an R1-move. In particular, any Gauss diagram of a virtual knot is CF-equivalent to the one without chords, which represents the trivial knot. This is an alternative proof of [9, Theorem 1.2] in terms of Gauss diagrams.

For $1 \leq i \neq j \leq \mu$ and an integer $a_{ij} \in \mathbb{Z}$, let $G_{ij}(a_{ij})$ be the Gauss diagram with μ circles C_1, \dots, C_μ , which consists of only $|a_{ij}|$ horizontal nonself-chords of type (i, j) with sign ε_{ij} , where $a_{ij} = \varepsilon_{ij}|a_{ij}|$. Let G and G' be Gauss diagrams with μ circles C_1, \dots, C_μ and C'_1, \dots, C'_μ , respectively. We put C_1, \dots, C_μ on top and

C'_1, \dots, C'_μ on bottom. As shown in Figure 2.6, for every $i \in \{1, \dots, \mu\}$, we connect C_i and C'_i by an unknotted arc, and then form a new circle $C_i \# C'_i$ by surgery along the unknotted arc. The Gauss diagram consisting of μ circles $C_1 \# C'_1, \dots, C_\mu \# C'_\mu$ is called a *connected sum* of G and G' and denoted by $G \# G'$. An example is shown in Figure 2.7.

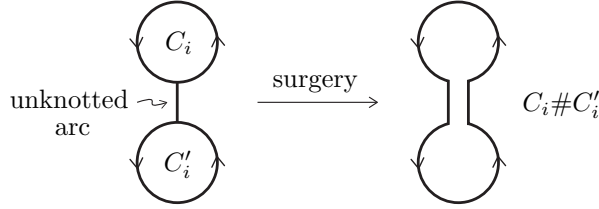

FIGURE 2.6. Forming a new circle $C_i \# C'_i$ from two circles C_i and C'_i by surgery along an unknotted arc

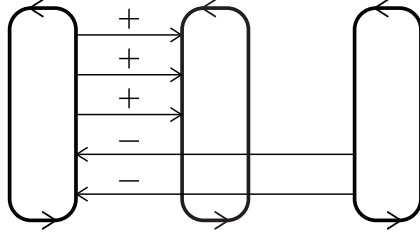

FIGURE 2.7. A connected sum $G_{12}(3) \# G_{31}(-2)$ of two Gauss diagrams $G_{12}(3)$ and $G_{31}(-2)$ in the case $\mu = 3$

Proposition 2.3. *Any Gauss diagram G of a μ -component virtual link is CF-equivalent to $\#_{1 \leq i < j \leq \mu} (G_{ij}(a_{ij}) \# G_{ji}(a_{ji}))$ for some $a_{ij}, a_{ji} \in \mathbb{Z}$, where the connected sum runs over all $i \neq j \in \{1, \dots, \mu\}$ in lexicographic order of i and j .*

Proof. By Remark 2.2, we may assume that every circle C_i of G has no self-chords up to CF-equivalence. For the nonself-chords in G , we move the endpoints by Lemma 2.1 to obtain parallel nonself-chords connecting C_i and C_j that are arranged in lexicographic order of $i \neq j \in \{1, \dots, \mu\}$ from top to bottom. For each $1 \leq i < j \leq \mu$, we make the parallel nonself-chords connecting C_i and C_j so that the nonself-chords of type (i, j) are arranged above those of type (j, i) . If two consecutive nonself-chords of the same type have opposite signs, then we cancel them by an R2-move. Finally G is CF-equivalent to $\#_{1 \leq i < j \leq \mu} (G_{ij}(a_{ij}) \# G_{ji}(a_{ji}))$ for some $a_{ij}, a_{ji} \in \mathbb{Z}$. \square

3. PROOF OF THEOREM 1.2

Let $L = K_1 \cup \dots \cup K_\mu$ be a μ -component virtual link and G its Gauss diagram with μ circles C_1, \dots, C_μ . For $1 \leq i \neq j \leq \mu$, the (i, j) -linking number of L is defined to be the sum of signs of all nonself-chords of type (i, j) in G . It is denoted by $\text{Lk}(K_i, K_j)$. This integer $\text{Lk}(K_i, K_j)$ is an invariant of the virtual link L (cf. [2, Section 1.7]). It can be seen that the difference $\text{Lk}(K_i, K_j) - \text{Lk}(K_j, K_i)$ is equal

to $-2\text{vlk}(K_i, K_j)$, where $\text{vlk}(K_i, K_j)$ denotes virtual linking number of K_i and K_j given in [9, 10]. Therefore, the following result is obtained from Theorem 1.1.

Lemma 3.1. *For any $1 \leq i < j \leq \mu$, the difference $\text{Lk}(K_i, K_j) - \text{Lk}(K_j, K_i)$ is invariant under CF-moves.*

For $1 \leq i \leq \mu$, the i th circle C_i of G is called *odd* if the number of all endpoints of self-/nonself-chords on C_i is an odd integer; otherwise it is called *even*. Since Reidemeister moves and CF-moves do not change the parity of the number of endpoints on C_i , the parity of C_i is preserved under CF-equivalence. We emphasize that the i th component K_i of L is odd if and only if C_i is odd, and that it is even if and only if C_i is even.

Lemma 3.2. *Let G be a Gauss diagram with an odd circle C . Let G' be a Gauss diagram obtained from G by altering the sign and orientation of a nonself-chord γ that is attached to C . Then G and G' are CF-equivalent.*

Proof. A CF-equivalence from G to G' is given as follows. First, we use Lemma 2.1 to slide the endpoint of γ on C along the circle C until it returns to the original position. Since C is odd, γ encounters an even number of endpoints during this process. Therefore, γ still has the same sign and orientation. On the other hand, the signs and orientations of the other nonself-chords that are attached to C are altered. Note that those of all self-chords in C are preserved. Next, we add a free chord in C by an R1-move, and slide one endpoint of the free chord along C until it is next to the other endpoint by Lemma 2.1. Then the signs and orientations of all nonself-chords that are attached to C , including γ , are altered, and those of all self-chords in C are preserved. Finally, we delete the free chord by an R1-move. The obtained Gauss diagram is G' . \square

Proposition 3.3. *Any Gauss diagram G of a μ -component odd or almost odd virtual link $L = K_1 \cup \cdots \cup K_\mu$ is CF-equivalent to $\#_{1 \leq i < j \leq \mu} G_{ij}(b_{ij})$ for some $b_{ij} \in \mathbb{Z}$. Moreover, we have $\text{Lk}(K_i, K_j) - \text{Lk}(K_j, K_i) = b_{ij}$ for any $1 \leq i < j \leq \mu$.*

Proof. Since the proofs in the cases of odd virtual links and almost odd virtual links are similar, we only consider the case where L is almost odd. Without loss of generality, we may assume that the μ th circle C_μ of G is even and the other circles $C_1, \dots, C_{\mu-1}$ are odd.

By Proposition 2.3, G is CF-equivalent to $\#_{1 \leq i < j \leq \mu} (G_{ij}(a_{ij})\#G_{ji}(a_{ji}))$ for some $a_{ij}, a_{ji} \in \mathbb{Z}$. Since $C_1, \dots, C_{\mu-1}$ are odd, we apply Lemma 3.2 to nonself-chords that are attached to C_i for $1 \leq i \leq \mu-1$ in order to obtain $\#_{1 \leq i < j \leq \mu} (G_{ij}(a_{ij})\#G_{ij}(-a_{ji}))$. Moreover, we obtain $\#_{1 \leq i < j \leq \mu} G_{ij}(a_{ij} - a_{ji})$ from it by R2-moves. Therefore, G is CF-equivalent to $\#_{1 \leq i < j \leq \mu} G_{ij}(b_{ij})$ for $b_{ij} = a_{ij} - a_{ji} \in \mathbb{Z}$.

Let $L' = K'_1 \cup \cdots \cup K'_\mu$ be the μ -component almost odd virtual link represented by $\#_{1 \leq i < j \leq \mu} G_{ij}(b_{ij})$. Since the sum of signs of all nonself-chords of type (i, j) in $\#_{1 \leq i < j \leq \mu} G_{ij}(b_{ij})$ is equal to b_{ij} and that of type (j, i) is equal to zero, we have $\text{Lk}(K'_i, K'_j) - \text{Lk}(K'_j, K'_i) = b_{ij}$ ($1 \leq i < j \leq \mu$). Since L and L' are CF-equivalent, Lemma 3.1 implies that $\text{Lk}(K_i, K_j) - \text{Lk}(K_j, K_i) = b_{ij}$. \square

Proof of Theorem 1.2. (i) \Rightarrow (ii): This follows from Lemma 3.1 directly.

(ii) \Rightarrow (i): By Proposition 3.3, any Gauss diagrams of L and L' are CF-equivalent to $\#_{1 \leq i < j \leq \mu} G_{ij}(b_{ij})$ and $\#_{1 \leq i < j \leq \mu} G_{ij}(b'_{ij})$ for some $b_{ij}, b'_{ij} \in \mathbb{Z}$, respectively. Moreover, we have $\text{Lk}(K_i, K_j) - \text{Lk}(K_j, K_i) = b_{ij}$ and $\text{Lk}(K'_i, K'_j) - \text{Lk}(K'_j, K'_i) = b'_{ij}$

($1 \leq i < j \leq \mu$). Since $\text{Lk}(K_i, K_j) - \text{Lk}(K_j, K_i) = \text{Lk}(K'_i, K'_j) - \text{Lk}(K'_j, K'_i)$, we have $b_{ij} = b'_{ij}$, and therefore $\#_{1 \leq i < j \leq \mu} G_{ij}(b_{ij}) = \#_{1 \leq i < j \leq \mu} G_{ij}(b'_{ij})$. \square

4. PROOF OF THEOREM 1.3

Throughout this section, we consider a 3-component *even* virtual link $L = K_1 \cup K_2 \cup K_3$ and its Gauss diagram G with three circles C_1, C_2 , and C_3 .

First we extend Oikawa's n -invariant given in [9, Definition 1.6] to the 3-component even virtual link L from the Gauss diagram point of view. We use the equivalence relation among the nonself-chords in G connecting C_i and C_j ($1 \leq i < j \leq 3$) defined in [5, Section 6]. Let γ and γ' be nonself-chords connecting C_i and C_j . The endpoints of γ and γ' on C_i divide the circle C_i into two arcs. Let α_i be one of the two arcs. Similarly, the endpoints of γ and γ' on C_j divide C_j into two arcs, and let α_j be one of the two arcs. See Figure 4.1. We say that γ and γ' are *equivalent* if the number of all endpoints of self-/nonself-chords on $\alpha_i \cup \alpha_j$ is an even integer. In particular, γ is equivalent to itself. Since C_i and C_j are even, the equivalence relation between γ and γ' does not depend on the choice of arcs α_i and α_j .

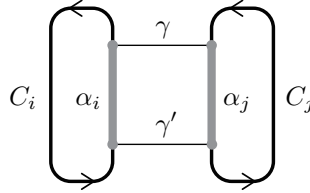

FIGURE 4.1. A pair of arcs α_i and α_j for nonself-chords γ and γ' connecting C_i and C_j

For $1 \leq i < j \leq 3$, we fix a nonself-chord γ_0 connecting C_i and C_j . Let $\sigma(C_i, C_j; \gamma_0)$ be the sum of signs of all nonself-chords connecting C_i and C_j , which are equivalent to γ_0 , including γ_0 itself. On the other hand, let $\bar{\sigma}(C_i, C_j; \gamma_0)$ be the sum of signs of all nonself-chords connecting C_i and C_j , which are not equivalent to γ_0 . We remark that $\sigma(C_i, C_j; \gamma_0) + \bar{\sigma}(C_i, C_j; \gamma_0) = \text{Lk}(K_i, K_j) + \text{Lk}(K_j, K_i)$. Denote by $n(C_i, C_j; \gamma_0)$ the absolute value of the difference $\sigma(C_i, C_j; \gamma_0) - \bar{\sigma}(C_i, C_j; \gamma_0)$. Note that $n(C_i, C_j; \gamma_0) = n(C_j, C_i; \gamma_0)$ by definition.

Example 4.1. Let G be the Gauss diagram with three circles C_1, C_2 , and C_3 in Figure 4.2, which represents a 3-component even virtual link. Let $\gamma_0, \dots, \gamma_8$ be the nonself-chords in G as shown in the figure. Choose γ_0 as a fixed nonself-chord connecting C_1 and C_2 . By definition, γ_0 and γ_1 are equivalent to γ_0 . On the other hand, γ_2, γ_3 , and γ_4 are not equivalent to γ_0 . Therefore, we have $n(C_1, C_2; \gamma_0) = 3$. Similarly, choosing γ_5 as a fixed nonself-chord connecting C_1 and C_3 , we have $n(C_1, C_3; \gamma_5) = 3$. Moreover, since γ_8 is the only one nonself-chord connecting C_2 and C_3 , it follows that $n(C_2, C_3; \gamma_8) = 1$.

Lemma 4.2. *For any $1 \leq i < j \leq 3$, the nonnegative integer $n(C_i, C_j; \gamma_0)$ is an invariant of L . Moreover, it is invariant under CF-moves.*

Since the proof is obtained from the proofs of Proposition 3.1 and Lemma 3.2 in [9] by interpreting in terms of Gauss diagrams, we omit it here. By Lemma 4.2, the following definition is well-defined.

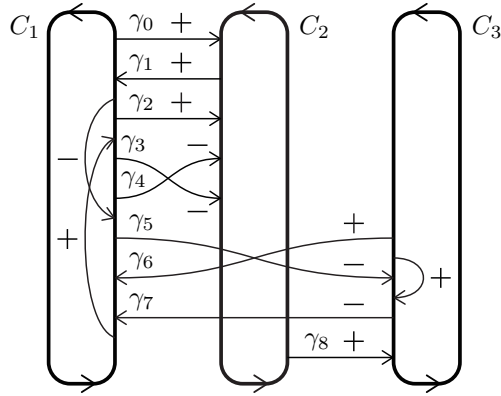

FIGURE 4.2. A Gauss diagram representing a 3-component even virtual link

Definition 4.3. The *Oikawa invariant* of K_i and K_j in L is the nonnegative integer $n(C_i, C_j; \gamma_0)$ for any nonself-chord γ_0 in G connecting C_i and C_j ($1 \leq i < j \leq 3$). It is denoted by $n(K_i, K_j)$.

Remark 4.4. Consider a Gauss diagram G with three circles C_1, C_2 , and C_3 associated with a 3-component classical link diagram (i.e. a link diagram without virtual crossings). Fix a nonself-chord γ_0 in G connecting C_i and C_j ($1 \leq i < j \leq 3$). It can be seen that all nonself-chords connecting C_i and C_j are equivalent to γ_0 . Therefore, if $L = K_1 \cup K_2 \cup K_3$ is a 3-component classical link (i.e. a link having a classical link diagram), then $n(K_i, K_j) = |\text{Lk}(K_i, K_j) + \text{Lk}(K_j, K_i)| = 2|\text{lk}(K_i, K_j)|$, where $\text{lk}(K_i, K_j)$ denotes the classical linking number of K_i and K_j .

Now we introduce two invariants $\tau_0(L)$ and $\tau_1(L)$ of L . Let γ, γ' , and γ'' be nonself-chords in G connecting C_1 and C_2 , C_1 and C_3 , and C_2 and C_3 , respectively. The endpoints of γ and γ' on C_1 divide the circle C_1 into two arcs. Let α_1 be one of the two arcs. Similarly, the endpoints of γ and γ'' on C_2 divide C_2 into two arcs, and let α_2 be one of the two arcs. The endpoints of γ' and γ'' on C_3 divide C_3 into two arcs, and let α_3 be one of the two arcs. See Figure 4.3. A triple $(\gamma, \gamma', \gamma'')$ of the three nonself-chords is called *even* if the number of all endpoints of self-/nonself-chords on $\alpha_1 \cup \alpha_2 \cup \alpha_3$ is an even integer; otherwise it is called *odd*. Since C_1, C_2 , and C_3 are even, the parity of $(\gamma, \gamma', \gamma'')$ does not depend on the choice of arcs α_1, α_2 , and α_3 .

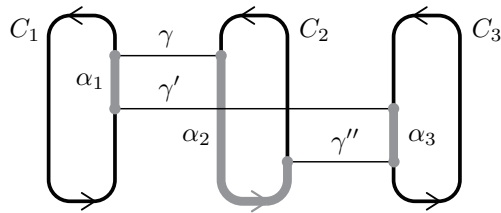

FIGURE 4.3. A triple of arcs α_1, α_2 , and α_3 for nonself-chords γ, γ' , and γ''

Let $T_0(G)$ be the set of even triples $(\gamma, \gamma', \gamma'')$ in G , and $T_1(G)$ the set of odd triples $(\gamma, \gamma', \gamma'')$ in G . For $k = 0, 1$, denote by $\tau_k(G)$ the sum of signs of all triples in $T_k(G)$, where the *sign* of a triple $(\gamma, \gamma', \gamma'') \in T_k(G)$ is the product of signs of γ, γ' , and γ'' .

Example 4.5. Consider the Gauss diagram G given in Example 4.1. By definition, we have

$$T_0(G) = \left\{ (\gamma_0, \gamma_6, \gamma_8), (\gamma_1, \gamma_6, \gamma_8), (\gamma_2, \gamma_5, \gamma_8), (\gamma_2, \gamma_7, \gamma_8), \right. \\ \left. (\gamma_3, \gamma_5, \gamma_8), (\gamma_3, \gamma_7, \gamma_8), (\gamma_4, \gamma_5, \gamma_8), (\gamma_4, \gamma_7, \gamma_8) \right\}$$

and

$$T_1(G) = \left\{ (\gamma_0, \gamma_5, \gamma_8), (\gamma_0, \gamma_7, \gamma_8), (\gamma_1, \gamma_5, \gamma_8), (\gamma_1, \gamma_7, \gamma_8), \right. \\ \left. (\gamma_2, \gamma_6, \gamma_8), (\gamma_3, \gamma_6, \gamma_8), (\gamma_4, \gamma_6, \gamma_8) \right\}.$$

Therefore, it follows that $\tau_0(G) = 4$ and $\tau_1(G) = -5$.

Lemma 4.6. *The integers $\tau_0(G)$ and $\tau_1(G)$ are invariants of L . Moreover, the difference $\tau_0(G) - \tau_1(G)$ is invariant under CF-moves.*

Proof. Let G' be a Gauss diagram obtained from G by one of Reidemeister moves and CF-moves.

For an R1-move or R3-move, we have $T_k(G) = T_k(G')$ ($k = 0, 1$). This implies that $\tau_k(G) = \tau_k(G')$.

For an R2-move, which adds a pair of chords γ and γ' with opposite signs, if γ and γ' are self-chords, then $T_k(G) = T_k(G')$, and therefore $\tau_k(G) = \tau_k(G')$ ($k = 0, 1$). If γ and γ' are nonself-chords, then $T_k(G') = T_k(G) \cup T_k(G'; \gamma, \gamma')$ ($k = 0, 1$), where $T_0(G'; \gamma, \gamma')$ denotes the set of even triples in G' that contain γ or γ' , and where $T_1(G'; \gamma, \gamma')$ denotes the set of odd triples in G' that contain γ or γ' . Since the sum of signs of all triples in $T_k(G'; \gamma, \gamma')$ is zero, we have $\tau_k(G) = \tau_k(G')$ ($k = 0, 1$).

For a CF-move, which exchanges two consecutive initial/terminal endpoints of a pair of chords γ and γ' , if γ and γ' are self-chords, then $T_k(G) = T_k(G')$, and therefore $\tau_k(G) = \tau_k(G')$ ($k = 0, 1$). If at least one of γ and γ' is a nonself-chord, then for a triple $t \in T_k(G)$ that contains γ or γ' , it follows that $t \in T_k(G')$ ($\tilde{0} = 1, \tilde{1} = 0$) and the sign of t is altered. For a triple $t \in T_k(G)$ that does not contain γ and γ' , it follows that $t \in T_k(G')$ and the sign of t is preserved ($k = 0, 1$). Hence, we have $\tau_0(G) - \tau_1(G) = \tau_0(G') - \tau_1(G')$. \square

Lemma 4.6 guarantees the well-definedness of the following definition.

Definition 4.7. The τ_k -invariant of L is the integer $\tau_k(G)$ for any Gauss diagram G of L ($k = 0, 1$). It is denoted by $\tau_k(L)$.

Remark 4.8. Consider a Gauss diagram G with three circles C_1, C_2 , and C_3 associated with a 3-component classical link diagram. It can be seen that for any three nonself-chords γ, γ' , and γ'' in G connecting C_1 and C_2 , C_1 and C_3 , and C_2 and C_3 , respectively, their triple $(\gamma, \gamma', \gamma'')$ is even. Therefore, if L is classical, then $\tau_0(L) = (\text{Lk}(K_1, K_2) + \text{Lk}(K_2, K_1))(\text{Lk}(K_1, K_3) + \text{Lk}(K_3, K_1))(\text{Lk}(K_2, K_3) + \text{Lk}(K_3, K_2)) = 8\text{lk}(K_1, K_2)\text{lk}(K_1, K_3)\text{lk}(K_2, K_3)$ and $\tau_1(L) = 0$.

For convenience of explanation, let $G(a_{12}, a_{21}; a_{13}, a_{31}; a_{23}, a_{32})$ denote the Gauss diagram $\#_{1 \leq i < j \leq 3}(G_{ij}(a_{ij})\#G_{ji}(a_{ji}))$ in the case $\mu = 3$ given in Proposition 2.3.

Lemma 4.9. *Let $L = K_1 \cup K_2 \cup K_3$ be the 3-component virtual link represented by $G(a_{12}, a_{21}; a_{13}, a_{31}; a_{23}, a_{32})$ for some $a_{ij} \in \mathbb{Z}$. Then L is even if and only if*

$$a_{12} + a_{21} \equiv a_{13} + a_{31} \equiv a_{23} + a_{32} \pmod{2}.$$

Proof. Since the number of endpoints on C_1 is equal to $|a_{12}| + |a_{21}| + |a_{13}| + |a_{31}|$, C_1 is even if and only if $a_{12} + a_{21} \equiv a_{13} + a_{31} \pmod{2}$. Similarly, C_2 is even if and only if $a_{12} + a_{21} \equiv a_{23} + a_{32} \pmod{2}$. Moreover, since the number of endpoints on all circles C_1, C_2 , and C_3 is an even integer, if C_1 and C_2 are even, then C_3 is also even. Therefore, we have the conclusion. \square

Lemma 4.10. *Let $L = K_1 \cup K_2 \cup K_3$ be the 3-component virtual link represented by $G(a_{12}, a_{21}; a_{13}, a_{31}; a_{23}, a_{32})$ for some $a_{ij} \in \mathbb{Z}$. If L is even, then we have $\text{Lk}(K_i, K_j) - \text{Lk}(K_j, K_i) = a_{ij} - a_{ji}$ and $n(K_i, K_j) = |a_{ij} + a_{ji}|$ for any $1 \leq i < j \leq 3$, and $\tau_0(L) - \tau_1(L) = (a_{12} + a_{21})(a_{13} + a_{31})(a_{23} + a_{32})$.*

Proof. Since the sum of signs of all nonself-chords of type (i, j) is equal to a_{ij} and that of type (j, i) is equal to a_{ji} , we have $\text{Lk}(K_i, K_j) - \text{Lk}(K_j, K_i) = a_{ij} - a_{ji}$ ($1 \leq i < j \leq 3$).

Choose and fix a nonself-chord γ_0 connecting C_i and C_j ($1 \leq i < j \leq 3$). By definition, all nonself-chords connecting C_i and C_j are equivalent to γ_0 . The sum of their signs is equal to $a_{ij} + a_{ji}$. Therefore, since $\sigma(C_i, C_j; \gamma_0) = a_{ij} + a_{ji}$ and $\bar{\sigma}(C_i, C_j; \gamma_0) = 0$, it follows that $n(K_i, K_j) = |a_{ij} + a_{ji}|$.

For any three nonself-chords $\gamma, \gamma',$ and γ'' in $G = G(a_{12}, a_{21}; a_{13}, a_{31}; a_{23}, a_{32})$ connecting C_1 and C_2, C_1 and C_3 , and C_2 and C_3 , respectively, their triple $(\gamma, \gamma', \gamma'')$ is even by definition. Therefore, we have $\tau_0(G) = (a_{12} + a_{21})(a_{13} + a_{31})(a_{23} + a_{32})$ and $\tau_1(G) = 0$, which implies that $\tau_0(L) - \tau_1(L) = (a_{12} + a_{21})(a_{13} + a_{31})(a_{23} + a_{32})$. \square

Lemma 4.11. *We have the following CF-equivalent Gauss diagrams of 3-component virtual links.*

- (i) $G(a_{12}, a_{21}; a_{13}, a_{31}; a_{23}, a_{32}) \sim G(-a_{21}, -a_{12}; -a_{31}, -a_{13}; a_{23}, a_{32})$.
- (ii) $G(a_{12}, a_{21}; a_{13}, a_{31}; a_{23}, a_{32}) \sim G(-a_{21}, -a_{12}; a_{13}, a_{31}; -a_{32}, -a_{23})$.
- (iii) $G(a_{12}, a_{21}; a_{13}, a_{31}; a_{23}, a_{32}) \sim G(a_{12}, a_{21}; -a_{31}, -a_{13}; -a_{32}, -a_{23})$.

Proof. Since the proofs of (i), (ii), and (iii) are similar, we only show (i). Figure 4.4 indicates the proof. More precisely, (2) is obtained from (1) by an R1-move adding a free chord γ in C_1 . Applying Lemma 2.1, we slide the terminal endpoint of γ along C_1 with respect to the orientation of C_1 until it is next to the initial endpoint. Then (3) is obtained from (2). We delete γ by an R1-move, and use Lemma 2.1 to exchange the positions of the nonself-chords of type (i, j) and those of type (j, i) for $(i, j) = (1, 2), (1, 3)$. Finally (4) is obtained from (3). \square

Proof of Theorem 1.3. (i) \Rightarrow (ii): This follows from Lemmas 3.1, 4.2, and 4.6 directly.

(ii) \Rightarrow (i): Let G and G' be Gauss diagrams of L and L' , respectively. By Proposition 2.3, we have

$$G \sim G(a_{12}, a_{21}; a_{13}, a_{31}; a_{23}, a_{32})$$

for some $a_{ij} \in \mathbb{Z}$ and

$$G' \sim G(a'_{12}, a'_{21}; a'_{13}, a'_{31}; a'_{23}, a'_{32})$$

for some $a'_{ij} \in \mathbb{Z}$. Since $\text{Lk}(K_i, K_j) - \text{Lk}(K_j, K_i) = \text{Lk}(K'_i, K'_j) - \text{Lk}(K'_j, K'_i)$ and $n(K_i, K_j) = n(K'_i, K'_j)$, by Lemma 4.10 we have $a_{ij} - a_{ji} = a'_{ij} - a'_{ji}$ and $|a_{ij} + a_{ji}| = |a'_{ij} + a'_{ji}|$ ($1 \leq i < j \leq 3$). Therefore, there are the following cases to consider.

- (1) $a_{12} = a'_{12}, a_{21} = a'_{21}, a_{13} = a'_{13}, a_{31} = a'_{31}, a_{23} = a'_{23}, a_{32} = a'_{32}$.

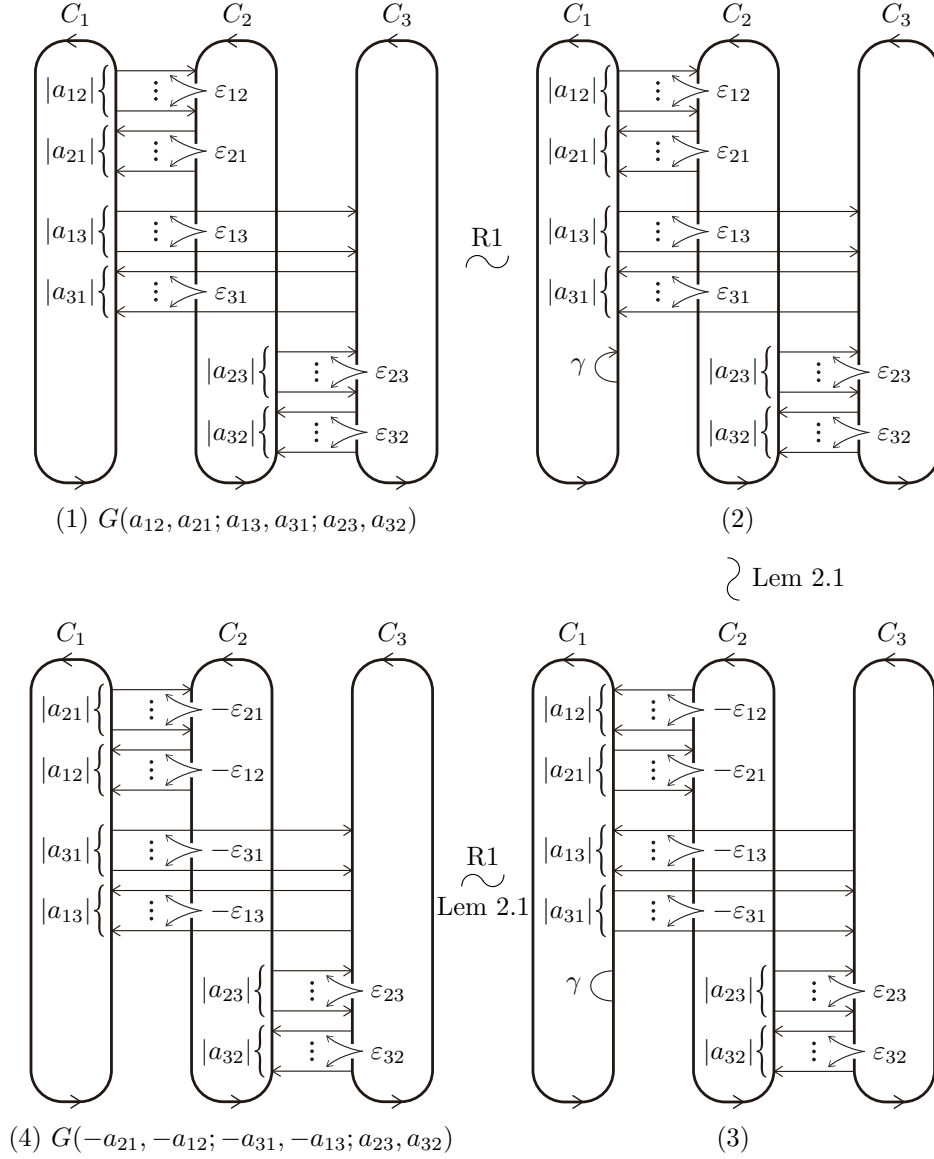

FIGURE 4.4. Proof of Lemma 4.11(i)

- (2) $a_{12} = -a'_{21}, a_{21} = -a'_{12}, a_{13} = -a'_{31}, a_{31} = -a'_{13}, a_{23} = a'_{23}, a_{32} = a'_{32}$.
- (3) $a_{12} = -a'_{21}, a_{21} = -a'_{12}, a_{13} = a'_{13}, a_{31} = a'_{31}, a_{23} = -a'_{32}, a_{32} = -a'_{23}$.
- (4) $a_{12} = a'_{12}, a_{21} = a'_{21}, a_{13} = -a'_{31}, a_{31} = -a'_{13}, a_{23} = -a'_{32}, a_{32} = -a'_{23}$.
- (5) $a_{12} = -a'_{21}, a_{21} = -a'_{12}, a_{13} = a'_{13}, a_{31} = a'_{31}, a_{23} = a'_{23}, a_{32} = a'_{32}$.
- (6) $a_{12} = a'_{12}, a_{21} = a'_{21}, a_{13} = -a'_{31}, a_{31} = -a'_{13}, a_{23} = a'_{23}, a_{32} = a'_{32}$.
- (7) $a_{12} = a'_{12}, a_{21} = a'_{21}, a_{13} = a'_{13}, a_{31} = a'_{31}, a_{23} = -a'_{32}, a_{32} = -a'_{23}$.
- (8) $a_{12} = -a'_{21}, a_{21} = -a'_{12}, a_{13} = -a'_{31}, a_{31} = -a'_{13}, a_{23} = -a'_{32}, a_{32} = -a'_{23}$.

Since $\tau_0(L) - \tau_1(L) = \tau_0(L') - \tau_1(L')$, Lemma 4.10 implies that

$$(a_{12} + a_{21})(a_{13} + a_{31})(a_{23} + a_{32}) = (a'_{12} + a'_{21})(a'_{13} + a'_{31})(a'_{23} + a'_{32}).$$

This indicates that Cases (5)–(8) do not occur. Hence, it is enough to consider Cases (1)–(4).

In Case (1), we have

$$G \sim G(a_{12}, a_{21}; a_{13}, a_{31}; a_{23}, a_{32}) = G(a'_{12}, a'_{21}; a'_{13}, a'_{31}; a'_{23}, a'_{32}) \sim G'.$$

In Case (2), it follows from Lemma 4.11(i) that

$$\begin{aligned} G &\sim G(a_{12}, a_{21}; a_{13}, a_{31}; a_{23}, a_{32}) \\ &= G(-a'_{21}, -a'_{12}; -a'_{31}, -a'_{13}; a'_{23}, a'_{32}) \\ &\sim G(a'_{12}, a'_{21}; a'_{13}, a'_{31}; a'_{23}, a'_{32}) \sim G'. \end{aligned}$$

Cases (3) and (4) are shown similarly. \square

We conclude this paper with a result that gives a relation among the classifying invariants $\text{Lk}(K_i, K_j) - \text{Lk}(K_j, K_i)$, $n(K_i, K_j)$, and $\tau_0(L) - \tau_1(L)$ of Theorem 1.3.

Proposition 4.12. *Let $L = K_1 \cup K_2 \cup K_3$ be a 3-component even virtual link, and let x_{ij}, y_{ij} , and z be integers ($1 \leq i < j \leq 3$). Assume that $\text{Lk}(K_i, K_j) - \text{Lk}(K_j, K_i) = x_{ij}$, $n(K_i, K_j) = |y_{ij}|$, and $\tau_0(L) - \tau_1(L) = z$. Then we have*

$$x_{12} \equiv x_{13} \equiv x_{23} \equiv y_{12} \equiv y_{13} \equiv y_{23} \pmod{2}$$

and

$$|z| = |y_{12}y_{13}y_{23}|.$$

Proof. By Proposition 2.3, L is CF-equivalent to a 3-component even virtual link represented by $G(a_{12}, a_{21}; a_{13}, a_{31}; a_{23}, a_{32})$ for some $a_{ij} \in \mathbb{Z}$. By Lemmas 3.1, 4.2, 4.6, and 4.10, we have $\text{Lk}(K_i, K_j) - \text{Lk}(K_j, K_i) = a_{ij} - a_{ji}$, $n(K_i, K_j) = |a_{ij} + a_{ji}|$ ($1 \leq i < j \leq 3$), and $\tau_0(L) - \tau_1(L) = (a_{12} + a_{21})(a_{13} + a_{31})(a_{23} + a_{32})$. The assumption implies that

$$x_{ij} = a_{ij} - a_{ji}, |y_{ij}| = |a_{ij} + a_{ji}| \quad (1 \leq i < j \leq 3),$$

and

$$z = (a_{12} + a_{21})(a_{13} + a_{31})(a_{23} + a_{32}).$$

Since L is even, we have $a_{12} + a_{21} \equiv a_{13} + a_{31} \equiv a_{23} + a_{32} \pmod{2}$ by Lemma 4.9. Therefore, it follows that

$$x_{12} \equiv x_{13} \equiv x_{23} \equiv y_{12} \equiv y_{13} \equiv y_{23} \pmod{2}.$$

Moreover, since $|y_{ij}| = |a_{ij} + a_{ji}|$ ($1 \leq i < j \leq 3$) and $z = (a_{12} + a_{21})(a_{13} + a_{31})(a_{23} + a_{32})$, we have $|z| = |y_{12}y_{13}y_{23}|$. \square

REFERENCES

- [1] B. Audoux, P. Bellingeri, J.-B. Meilhan, and E. Wagner, *Extensions of some classical local moves on knot diagrams*, Michigan Math. J. **67** (2018), no. 3, 647–672.
- [2] M. Goussarov, M. Polyak, and O. Viro, *Finite-type invariants of classical and virtual knots*, Topology **39** (2000), no. 5, 1045–1068.
- [3] T. Kanenobu, *Forbidden moves unknot a virtual knot*, J. Knot Theory Ramifications **10** (2001), no. 1, 89–96.
- [4] L. H. Kauffman, *Virtual knot theory*, European J. Combin. **20** (1999), no. 7, 663–690.
- [5] J.-B. Meilhan, S. Satoh, and K. Wada, *Classification of 2-component virtual links up to Ξ -moves*, preprint (2020), arXiv:2002.08305.
- [6] H. A. Miyazawa, K. Wada, and A. Yasuhara, *Linking invariants of even virtual links*, J. Knot Theory Ramifications **26** (2017), no. 12, 1750072, 12 pp.
- [7] T. Nasybullov, *Classification of fused links*, J. Knot Theory Ramifications **25** (2016), no. 14, 1650076, 21 pp.

- [8] S. Nelson, *Unknotting virtual knots with Gauss diagram forbidden moves*, J. Knot Theory Ramifications **10** (2001), no. 6, 931–935.
- [9] T. Oikawa, *On a local move for virtual knots and links*, J. Knot Theory Ramifications **18** (2009), no. 11, 1577–1596.
- [10] T. Okabayashi, *Forbidden moves for virtual links*, Kobe J. Math. **22** (2005), no. 1–2, 49–63.
- [11] M. Polyak, *Minimal generating sets of Reidemeister moves*, Quantum Topol. **1** (2010), no. 4, 399–411.

DEPARTMENT OF MATHEMATICS, GRADUATE SCHOOL OF SCIENCE, OSAKA UNIVERSITY, 1-1
MACHIKANEYAMA-CHO, TOYONAKA, OSAKA 560-0043, JAPAN
Email address: ko-wada@cr.math.sci.osaka-u.ac.jp