

Covalent hadronic molecules induced by shared light quarks

Hua-Xing Chen*

School of Physics, Southeast University, Nanjing 210094, China

(Dated: August 31, 2022)

After examining Feynman diagrams corresponding to the $\bar{D}^{(*)}\Sigma_c^{(*)}$, $\bar{D}^{(*)}\Lambda_c$, $D^{(*)}\bar{K}^*$, and $D^{(*)}\bar{D}^{(*)}$ hadronic molecular states, we propose a possible binding mechanism induced by shared light quarks. This mechanism is similar to the covalent bond in chemical molecules induced by shared electrons. We use the method of QCD sum rules to calculate its corresponding light-quark-exchange diagrams, and the obtained results indicate a model-independent hypothesis: the light-quark-exchange interaction is attractive when the shared light quarks are totally antisymmetric so that obey the Pauli principle. We build a toy model with four parameters to formulize this picture, and estimate binding energies of some possibly-existing covalent hadronic molecules. A unique feature of this picture is that binding energies of the $(I)J^P = (0)1^+ D\bar{B}^*/D^*\bar{B}$ hadronic molecules are much larger than those of the $(I)J^P = (0)1^+ DD^*/\bar{B}\bar{B}^*$ ones, while the $(I)J^P = (1/2)1/2^+ \bar{D}\Sigma_c/\bar{D}\Sigma_b/B\Sigma_c/B\Sigma_b$ hadronic molecules have similar binding energies.

Keywords: hadronic molecule, covalent bond, QCD sum rules

I. INTRODUCTION

Since the discovery of the $X(3872)$ by Belle in 2003 [1], lots of charmonium-like XYZ states were discovered in the past two decades [2]. Some of these structures may contain four quarks and are good candidates for hidden-charm tetraquark states. In recent years the LHCb Collaboration continually observed six P_c/P_{cs} states [3–6], which contain five quarks and are good candidates for hidden-charm pentaquark states. Although there is still a long way to fully understand how the strong interaction binds these quarks and antiquarks together, the above exotic structures have become one of the most intriguing research topics in hadron physics. Their theoretical and experimental studies are significantly improving our understanding of the non-perturbative behaviors of the strong interaction at the low energy region. We refer to the reviews [7–22] and references therein for detailed discussions.

Some of the XYZ and P_c/P_{cs} states can be interpreted as hadronic molecular states, which consist of two conventional hadrons [23–32]. For example, the P_c states were proposed to be the $\bar{D}^{(*)}\Sigma_c^{(*)}$ hadronic molecular states in Refs. [33–39] bound by the one-meson-exchange interaction Π_M , as depicted in Fig. 2(a). Besides, we know from QCD that there can be the double-gluon-exchange interaction Π_G between $\bar{D}^{(*)}$ and $\Sigma_c^{(*)}$, as depicted in Fig. 2(b).

In this paper we propose another possible interaction between $\bar{D}^{(*)}$ and $\Sigma_c^{(*)}$ induced by the light-quark-exchange term Π_Q , as depicted in Fig. 2(c). This term indicates that $\bar{D}^{(*)}$ and $\Sigma_c^{(*)}$ are exchanging and so sharing two light up/down quarks, as depicted in Fig. 1. It can induce an interaction between $\bar{D}^{(*)}$ and $\Sigma_c^{(*)}$, either

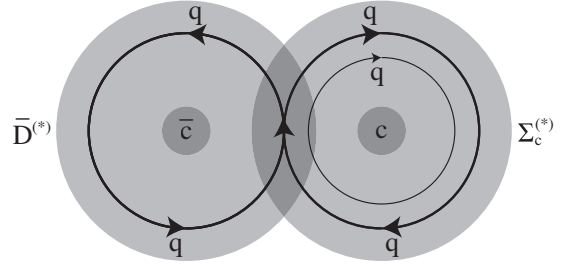

FIG. 1: Possible binding mechanism induced by shared light quarks, described by the light-quark-exchange term Π_Q . Here q denotes a light up/down quark.

attractive or repulsive. Note that the two interactions, Π_M at the hadron level and Π_Q at the quark-gluon level, can overlap with each other. The quark-exchange effect has been studied in Ref. [40] by Hoodbhoy and Jaffe to explain the European Muon Collaboration (EMC) effect in three-nucleon systems, and later used in Refs. [41, 42] to study some other nuclei. We also refer to Ref. [43] for some relevant discussions.

In this paper we shall systematically examine the Feynman diagrams corresponding to the $\bar{D}^{(*)}\Sigma_c^{(*)}$, $\bar{D}^{(*)}\Lambda_c$, $D^{(*)}\bar{K}^*$, and $D^{(*)}\bar{D}^{(*)}$ hadronic molecular states. We shall apply the method of QCD sum rules to investigate the light-quark-exchange term Π_Q , and study its contributions to these states. Based on the obtained results, we shall study the binding mechanism induced by shared light quarks. This mechanism is somewhat similar to the covalent bond in chemical molecules induced by shared electrons, so we call such hadronic molecules “covalent hadronic molecules”.

Based on the obtained results, we shall further propose a model-independent hypothesis: *the light-quark-exchange interaction is attractive when the shared light quarks are totally antisymmetric so that obey the Pauli principle*. We shall apply this hypothesis to predict some

*Electronic address: hxchen@seu.edu.cn

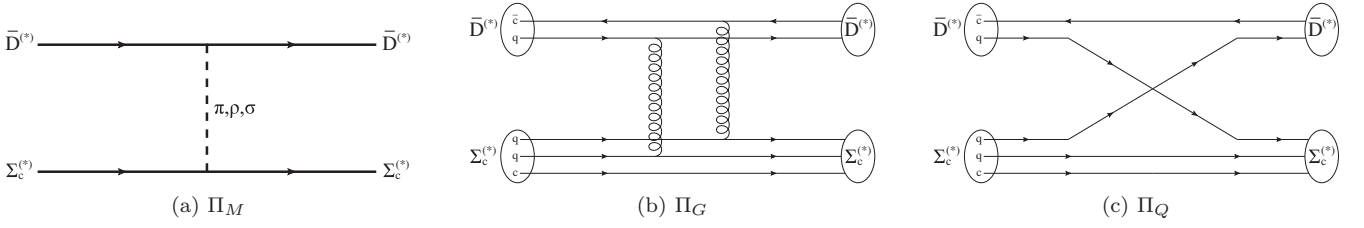

FIG. 2: Feynman diagrams between $\bar{D}^{(*)}$ and $\Sigma_c^{(*)}$ corresponding to : a) the one-meson-exchange interaction Π_M , b) the double-gluon-exchange interaction Π_G , and c) the light-quark-exchange interaction Π_Q . Here q denotes a light up/down quark.

possibly-existing covalent hadronic molecules. We shall also build a toy model to formulize this picture and estimate their binding energies. Our model has four parameters, which are fixed by considering the P_c/P_{cs} and the recently observed T_{cc}^+ [44, 45] as possible covalent hadronic molecules.

Take the $X(3872)$ as another example. We shall find that the light-quark-exchange term Π_Q does not contribute to the $D^{(*)}\bar{D}^{(*)}$ molecules, suggesting the $D^{(*)}\bar{D}^{(*)}$ covalent hadronic molecules not to exist. However, there can still be the $D^{(*)}\bar{D}^{(*)}$ hadronic molecules induced by some other binding mechanisms, such as the one-meson-exchange interaction [23–32]. Especially, the $X(3872)$ can be interpreted as such a $D\bar{D}^*$ hadronic molecule, while it was suggested to be a compact tetraquark state in Refs. [46–50], a conventional $c\bar{c}$ state in Refs. [51, 52], and the mixture of a $c\bar{c}$ state with the $D\bar{D}^*$ component in Refs. [53, 54].

This paper is organized as follows. In Sec. II we systematically investigate correlation functions of the $D^-\Sigma_c^{++}$, $\bar{D}^0\Sigma_c^+$, $I = 1/2 \bar{D}\Sigma_c$, and $I = 3/2 \bar{D}\Sigma_c$ hadronic molecules. In Sec. III we apply the method of QCD sum rules to investigate the light-quark-exchange term Π_Q , and study its contributions to these molecules. In Sec. IV we follow the same procedures and study the $\bar{D}^*\Sigma_c/\bar{D}\Sigma_c^*/\bar{D}^*\Sigma_c^*$, $\bar{D}^{(*)}\Lambda_c$, $D^{(*)}\bar{K}^*$, and $D^{(*)}\bar{D}^{(*)}$ hadronic molecules. Based on the obtained QCD sum rule results, we propose the above hypothesis in Sec. V, and predict more possibly-existing covalent hadronic molecules. In Sec. VI we build a toy model to formulize the covalent hadronic molecule picture, and the obtained results are summarized and discussed in Sec. VII.

II. CORRELATION FUNCTIONS OF $D^-\Sigma_c^{++}/\bar{D}^0\Sigma_c^+/\bar{D}\Sigma_c$ MOLECULES

In this section we investigate correlation functions of the $D^-\Sigma_c^{++}$, $\bar{D}^0\Sigma_c^+$, $I = 1/2 \bar{D}\Sigma_c$, and $I = 3/2 \bar{D}\Sigma_c$ hadronic molecular states.

A. $D^-\Sigma_c^{++}$ correlation function

In this subsection we investigate correlation function of the $D^-\Sigma_c^{++}$ molecule. Firstly, we investigate correlation functions of the D^- meson and the Σ_c^{++} baryon. Their corresponding interpolating currents are

$$J^{D^-}(x) = \bar{c}_a(x)\gamma_5 d_a(x), \quad (1)$$

$$J^{\Sigma_c^{++}}(x) = \frac{1}{\sqrt{2}}\epsilon^{abc}u_a^T(x)\mathbb{C}\gamma^\mu u_b(x)\gamma_\mu\gamma_5 c_c(x), \quad (2)$$

where $a \dots c$ are color indices; $\mathbb{C} = i\gamma_2\gamma_0$ is the charge-conjugation operator; the coefficient $1/\sqrt{2}$ is an isospin factor.

We write down two-point correlation functions of the D^- meson and the Σ_c^{++} baryon in the coordinate space:

$$\begin{aligned} \Pi^{D^-}(x) &= \langle 0|\mathbb{T}[J^{D^-}(x)J^{D^-,\dagger}(0)]|0\rangle \\ &= -\text{Tr}\left[\mathbf{iS}_q^{aa'}(x)\gamma_5\mathbf{iS}_c^{a'a}(-x)\gamma_5\right], \end{aligned} \quad (3)$$

$$\begin{aligned} \Pi^{\Sigma_c^{++}}(x) &= \langle 0|\mathbb{T}[J^{\Sigma_c^{++}}(x)\bar{J}^{\Sigma_c^{++}}(0)]|0\rangle \\ &= \epsilon^{abc}\epsilon^{a'b'c'}\text{Tr}\left[\mathbf{iS}_q^{bb'}(x)\gamma^\mu\mathbb{C}(\mathbf{iS}_q^{aa'}(x))^T\mathbb{C}\gamma^\mu\right] \\ &\quad \times \gamma_\mu\gamma_5\mathbf{iS}_c^{c'c}(x)\gamma_{\mu'}\gamma_5. \end{aligned} \quad (4)$$

Their corresponding Feynman diagrams are depicted in Fig. 3(a) and Fig. 3(b), respectively. In the present study we do not differentiate propagators of the light up and down quarks, and use $\mathbf{iS}_q^{ab}(x) = \mathbf{iS}_{\text{up}}^{ab}(x) = \mathbf{iS}_{\text{down}}^{ab}(x)$ to denote both of them in the coordinate space; besides, we use $\mathbf{iS}_c^{ab}(x)$ to denote propagator of the heavy charm quark in the coordinate space:

$$\begin{aligned} \mathbf{iS}_q^{ab}(x) &= \langle 0|\mathbb{T}[u^a(x)\bar{u}^b(0)]|0\rangle \\ &= \langle 0|\mathbb{T}[d^a(x)\bar{d}^b(0)]|0\rangle, \end{aligned} \quad (5)$$

$$\mathbf{iS}_c^{ab}(x) = \langle 0|\mathbb{T}[c^a(x)\bar{c}^b(0)]|0\rangle. \quad (6)$$

Then we put the D^- meson and the Σ_c^{++} baryon at the same location, and construct a composite current corre-

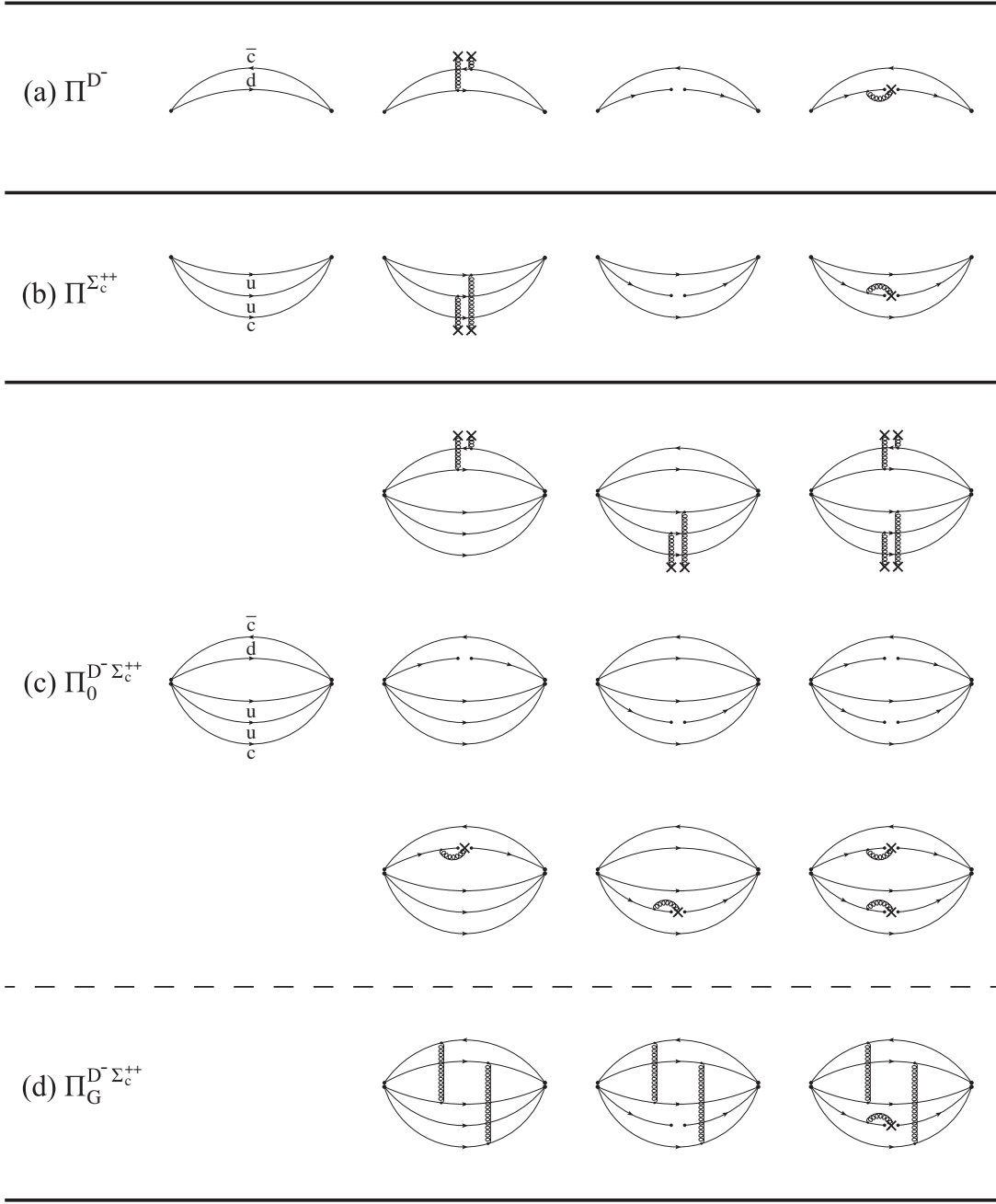

FIG. 3: Feynman diagrams corresponding to: a) $\Pi^{D^-}(x)$, b) $\Pi^{\Sigma_c^{++}}(x)$, c) $\Pi_0^{D^- \Sigma_c^{++}}(x)$, and d) $\Pi_G^{D^- \Sigma_c^{++}}(x)$. $\Pi^{D^-}(x)$ and $\Pi^{\Sigma_c^{++}}(x)$ are correlation functions of the D^- meson and the Σ_c^{++} baryon, respectively. The correlation function of the $D^- \Sigma_c^{++}$ molecule satisfies $\Pi^{D^- \Sigma_c^{++}}(x) = \Pi_0^{D^- \Sigma_c^{++}}(x) + \Pi_G^{D^- \Sigma_c^{++}}(x)$ with $\Pi_0^{D^- \Sigma_c^{++}}(x) = \Pi^{D^-}(x) \times \Pi^{\Sigma_c^{++}}(x)$.

sponding to the $D^- \Sigma_c^{++}$ molecule,

$$\begin{aligned}
 J^{D^- \Sigma_c^{++}}(x) &= J^{D^-}(x) \times J^{\Sigma_c^{++}}(x) \\
 &= [\bar{c}_d(x) \gamma_5 d_d(x)] \\
 &\times \frac{1}{\sqrt{2}} [\epsilon^{abc} u_a^T(x) \mathbf{C} \gamma^\mu u_b(x) \gamma_\mu \gamma_5 c_c(x)].
 \end{aligned} \tag{7}$$

Its correlation function in the coordinate space is

$$\begin{aligned}
 &\Pi^{D^- \Sigma_c^{++}}(x) \\
 &= \langle 0 | \mathbb{T} [J^{D^- \Sigma_c^{++}}(x) \bar{J}^{D^- \Sigma_c^{++}}(0)] | 0 \rangle \\
 &= -\text{Tr} [\mathbf{iS}_q^{dd'}(x) \gamma_5 \mathbf{iS}_c^{d'd}(-x) \gamma_5] \\
 &\times \epsilon^{abc} \epsilon^{a'b'c'} \text{Tr} [\mathbf{iS}_q^{bb'}(x) \gamma^{\mu'} \mathbf{C} (\mathbf{iS}_q^{aa'}(x))^T \mathbf{C} \gamma^\mu \\
 &\quad \times \gamma_\mu \gamma_5 \mathbf{iS}_c^{cc'}(x) \gamma_\mu \gamma_5] \\
 &= \Pi_0^{D^- \Sigma_c^{++}}(x) + \Pi_G^{D^- \Sigma_c^{++}}(x),
 \end{aligned} \tag{8}$$

where

$$\Pi_0^{D^-\Sigma_c^{++}}(x) = \Pi^{D^-}(x) \times \Pi^{\Sigma_c^{++}}(x), \quad (9)$$

is the leading term contributed by non-correlated D^- and Σ_c^{++} , and $\Pi_G^{D^-\Sigma_c^{++}}(x)$ describes the double-gluon-exchange interaction between them. Their corresponding Feynman diagrams are depicted in Fig. 3(c) and Fig. 3(d), respectively.

The double-gluon-exchange term $\Pi_G^{D^-\Sigma_c^{++}}(x)$ is at the $\mathcal{O}(\alpha_s^2)$ order, and it is expected to be suppressed according to the OZI rule. In the present study we shall not pay much attention to it, while we shall investigate another more important term from the next subsection.

B. $\bar{D}^0\Sigma_c^+$ correlation function

In this subsection we investigate correlation function of the $\bar{D}^0\Sigma_c^+$ molecule. The interpolating currents cor-

Their correlation functions in the coordinate space are:

$$\Pi^{\bar{D}^0}(x) = -\text{Tr} \left[\mathbf{iS}_q^{aa'}(x)\gamma_5 \mathbf{iS}_c^{a'a}(-x)\gamma_5 \right], \quad (13)$$

$$\Pi^{\Sigma_c^+}(x) = \epsilon^{abc}\epsilon^{a'b'c'} \text{Tr} \left[\mathbf{iS}_q^{bb'}(x)\gamma^{\mu'} \mathbb{C}(\mathbf{iS}_q^{aa'}(x))^T \mathbb{C}\gamma^\mu \right] \times \gamma_\mu \gamma_5 \mathbf{iS}_c^{cc'}(x)\gamma_{\mu'}\gamma_5, \quad (14)$$

$$\begin{aligned} \Pi^{\bar{D}^0\Sigma_c^+}(x) &= -\text{Tr} \left[\mathbf{iS}_q^{dd'}(x)\gamma_5 \mathbf{iS}_c^{d'd}(-x)\gamma_5 \right] \times \epsilon^{abc}\epsilon^{a'b'c'} \text{Tr} \left[\mathbf{iS}_q^{bb'}(x)\gamma^{\mu'} \mathbb{C}(\mathbf{iS}_q^{aa'}(x))^T \mathbb{C}\gamma^\mu \right] \gamma_\mu \gamma_5 \mathbf{iS}_c^{cc'}(x)\gamma_{\mu'}\gamma_5 \\ &\quad + \text{Tr} \left[\mathbf{iS}_q^{da'}(x)\gamma^{\mu'} \mathbb{C}(\mathbf{iS}_q^{bb'}(x))^T \mathbb{C}\gamma^\mu \mathbf{iS}_q^{ad'}(x)\gamma_5 \mathbf{iS}_c^{d'd}(-x)\gamma_5 \right] \gamma_\mu \gamma_5 \mathbf{iS}_c^{cc'}(x)\gamma_{\mu'}\gamma_5 \\ &= \Pi_0^{\bar{D}^0\Sigma_c^+}(x) + \Pi_G^{\bar{D}^0\Sigma_c^+}(x) + \Pi_Q^{\bar{D}^0\Sigma_c^+}(x). \end{aligned} \quad (15)$$

In the above expressions, $\Pi^{\bar{D}^0}(x)$ and $\Pi^{\Sigma_c^+}(x)$ are correlation functions of \bar{D}^0 and Σ_c^+ , respective; $\Pi_0^{\bar{D}^0\Sigma_c^+}(x) = \Pi^{\bar{D}^0}(x) \times \Pi^{\Sigma_c^+}(x)$ is the leading term contributed by non-correlated \bar{D}^0 and Σ_c^+ , and $\Pi_G^{\bar{D}^0\Sigma_c^+}(x)$ describes the double-gluon-exchange interaction between them. Their corresponding Feynman diagrams are depicted in Fig. 4(a-d).

Compared to the case of $D^-\Sigma_c^{++}$, we find

$$\Pi^{\bar{D}^0}(x) = \Pi^{D^-}(x), \quad (16)$$

$$\Pi^{\Sigma_c^+}(x) = \Pi^{\Sigma_c^{++}}(x), \quad (17)$$

$$\Pi_0^{\bar{D}^0\Sigma_c^+}(x) = \Pi_0^{D^-\Sigma_c^{++}}(x), \quad (18)$$

$$\Pi_G^{\bar{D}^0\Sigma_c^+}(x) = \Pi_G^{D^-\Sigma_c^{++}}(x), \quad (19)$$

responding to the \bar{D}^0 meson, the Σ_c^+ baryon, and the $\bar{D}^0\Sigma_c^+$ molecule are

$$J^{\bar{D}^0}(x) = \bar{c}_a(x)\gamma_5 u_a(x), \quad (10)$$

$$J^{\Sigma_c^+}(x) = \epsilon^{abc} u_a^T(x) \mathbb{C}\gamma^\mu d_b(x) \gamma_\mu \gamma_5 c_c(x), \quad (11)$$

$$\begin{aligned} J^{\bar{D}^0\Sigma_c^+}(x) &= J^{\bar{D}^0}(x) \times J^{\Sigma_c^+}(x) \\ &= [\bar{c}_d(x)\gamma_5 u_d(x)] \\ &\quad \times [\epsilon^{abc} u_a^T(x) \mathbb{C}\gamma^\mu d_b(x) \gamma_\mu \gamma_5 c_c(x)]. \end{aligned} \quad (12)$$

while there exists an extra term,

$$\begin{aligned} \Pi_Q^{\bar{D}^0\Sigma_c^+}(x) &= \text{Tr} \left[\mathbf{iS}_q^{da'}(x)\gamma^{\mu'} \mathbb{C}(\mathbf{iS}_q^{bb'}(x))^T \mathbb{C}\gamma^\mu \right. \\ &\quad \left. \mathbf{iS}_q^{ad'}(x)\gamma_5 \mathbf{iS}_c^{d'd}(-x)\gamma_5 \right] \\ &\quad \times \gamma_\mu \gamma_5 \mathbf{iS}_c^{cc'}(x)\gamma_{\mu'}\gamma_5. \end{aligned} \quad (20)$$

Its corresponding Feynman diagrams are depicted in Fig. 4(e). This term describes the light-quark-exchange effect between \bar{D}^0 and Σ_c^+ , *i.e.*, \bar{D}^0 and Σ_c^+ are exchanging and so sharing two light up quarks. It can induce an interaction between \bar{D}^0 and Σ_c^+ , either attractive or repulsive. This term is color-unconfined, *i.e.*, its contribution decreases as the distance between \bar{D}^0 and Σ_c^+ increases; besides, the two exchanged/shared light quarks have the same color. We shall further study it numerically in Sec. III C.

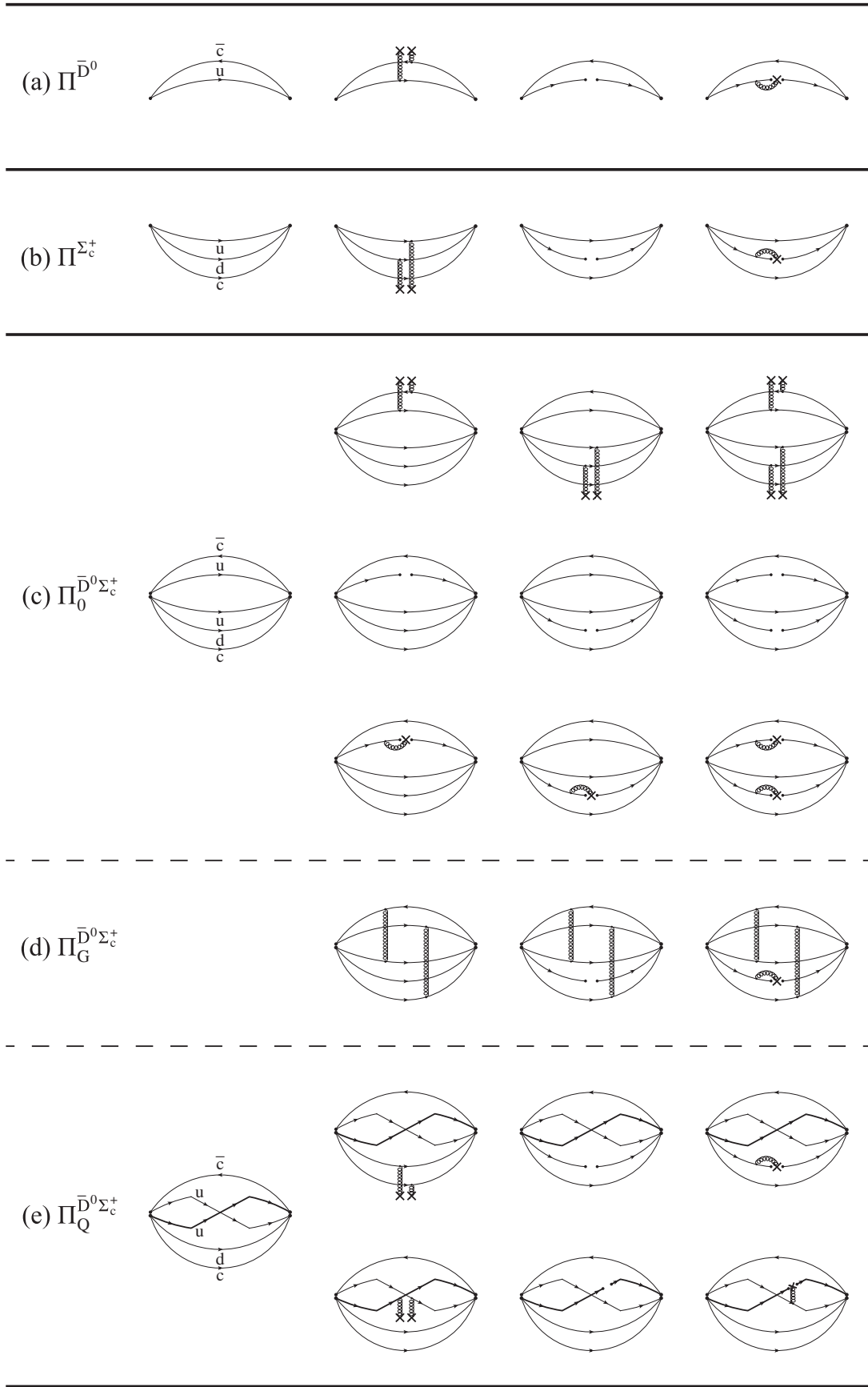

FIG. 4: Feynman diagrams corresponding to: a) $\Pi^{\bar{D}^0}(x)$, b) $\Pi^{\Sigma_c^+}(x)$, c) $\Pi_0^{\bar{D}^0\Sigma_c^+}(x)$, d) $\Pi_G^{\bar{D}^0\Sigma_c^+}(x)$, and e) $\Pi_Q^{\bar{D}^0\Sigma_c^+}(x)$. $\Pi^{\bar{D}^0}(x)$ and $\Pi^{\Sigma_c^+}(x)$ are correlation functions of the \bar{D}^0 meson and the Σ_c^+ baryon, respectively. The correlation function of the $\bar{D}^0\Sigma_c^+$ molecule satisfies $\Pi^{\bar{D}^0\Sigma_c^+}(x) = \Pi_0^{\bar{D}^0\Sigma_c^+}(x) + \Pi_G^{\bar{D}^0\Sigma_c^+}(x) + \Pi_Q^{\bar{D}^0\Sigma_c^+}(x)$ with $\Pi_0^{\bar{D}^0\Sigma_c^+}(x) = \Pi^{\bar{D}^0}(x) \times \Pi^{\Sigma_c^+}(x)$.

C. $I = 1/2$ $\bar{D}\Sigma_c$ correlation function

In this subsection we investigate correlation function of the $I = 1/2$ $\bar{D}\Sigma_c$ molecule. Its corresponding interpolating current is

$$J^{\bar{D}\Sigma_c}(x) = \sqrt{\frac{1}{3}}J^{\bar{D}^0\Sigma_c^+}(x) - \sqrt{\frac{2}{3}}J^{D^-\Sigma_c^{++}}(x), \quad (21)$$

$$\begin{aligned} \Pi^{\bar{D}\Sigma_c}(x) &= -\text{Tr} \left[\mathbf{iS}_q^{dd'}(x)\gamma_5 \mathbf{iS}_c^{d'd}(-x)\gamma_5 \right] \times \epsilon^{abc}\epsilon^{a'b'c'} \text{Tr} \left[\mathbf{iS}_q^{bb'}(x)\gamma^{\mu'} \mathbb{C}(\mathbf{iS}_q^{aa'}(x))^T \mathbb{C}\gamma^\mu \right] \gamma_\mu \gamma_5 \mathbf{iS}_c^{cc'}(x)\gamma_{\mu'}\gamma_5 \\ &\quad - \text{Tr} \left[\mathbf{iS}_q^{da'}(x)\gamma^{\mu'} \mathbb{C}(\mathbf{iS}_q^{bb'}(x))^T \mathbb{C}\gamma^\mu \mathbf{iS}_q^{ad'}(x)\gamma_5 \mathbf{iS}_c^{d'd}(-x)\gamma_5 \right] \gamma_\mu \gamma_5 \mathbf{iS}_c^{cc'}(x)\gamma_{\mu'}\gamma_5 \\ &= \Pi_0^{\bar{D}\Sigma_c}(x) + \Pi_G^{\bar{D}\Sigma_c}(x) + \Pi_Q^{\bar{D}\Sigma_c}(x). \end{aligned} \quad (22)$$

Compared to the case of $\bar{D}^0\Sigma_c^+$ given in Eq. (15), only the terms $\Pi_Q^{\bar{D}\Sigma_c}(x)$ and $\Pi_Q^{\bar{D}^0\Sigma_c^+}(x)$ are different/opposite:

$$\Pi_0^{\bar{D}\Sigma_c}(x) = \Pi_0^{\bar{D}^0\Sigma_c^+}(x), \quad (23)$$

$$\Pi_G^{\bar{D}\Sigma_c}(x) = \Pi_G^{\bar{D}^0\Sigma_c^+}(x), \quad (24)$$

$$\Pi_Q^{\bar{D}\Sigma_c}(x) = -\Pi_Q^{\bar{D}^0\Sigma_c^+}(x). \quad (25)$$

Accordingly, if the term $\Pi_Q(x)$ induces a repulsive interaction to the $\bar{D}^0\Sigma_c^+$ molecule, it would induce an attractive interaction to the $I = 1/2$ $\bar{D}\Sigma_c$ molecule; and vice versa. We shall further study it numerically in Sec. III A. For completeness, we explicitly list that the term $\Pi_Q^{\bar{D}\Sigma_c}(x)$ is contributed separately by:

$$\begin{aligned} \langle 0|\mathbb{T} \left[\sqrt{\frac{1}{3}}J^{\bar{D}^0\Sigma_c^+}(x)\sqrt{\frac{1}{3}}\bar{J}^{\bar{D}^0\Sigma_c^+}(0) \right] |0\rangle &\rightarrow -\frac{1}{3}\Pi_Q^{\bar{D}\Sigma_c}(x), \\ \langle 0|\mathbb{T} \left[\sqrt{\frac{2}{3}}J^{D^-\Sigma_c^{++}}(x)\sqrt{\frac{2}{3}}\bar{J}^{D^-\Sigma_c^{++}}(0) \right] |0\rangle &\rightarrow 0, \\ -\langle 0|\mathbb{T} \left[\frac{J^{\bar{D}^0\Sigma_c^+}(x)}{\sqrt{3}}\sqrt{\frac{2}{3}}\bar{J}^{D^-\Sigma_c^{++}}(0) \right] |0\rangle &\rightarrow \frac{2}{3}\Pi_Q^{\bar{D}\Sigma_c}(x), \\ -\langle 0|\mathbb{T} \left[\sqrt{\frac{2}{3}}J^{D^-\Sigma_c^{++}}(x)\frac{\bar{J}^{\bar{D}^0\Sigma_c^+}(0)}{\sqrt{3}} \right] |0\rangle &\rightarrow \frac{2}{3}\Pi_Q^{\bar{D}\Sigma_c}(x). \end{aligned} \quad (26)$$

D. $I = 3/2$ $\bar{D}\Sigma_c$ correlation function

For completeness, we investigate correlation function of the $I = 3/2$ $\bar{D}\Sigma_c$ molecule in this subsection. Its corresponding interpolating current is

$$J_{I=3/2}^{\bar{D}\Sigma_c}(x) = \sqrt{\frac{2}{3}}J^{\bar{D}^0\Sigma_c^+}(x) + \sqrt{\frac{1}{3}}J^{D^-\Sigma_c^{++}}(x), \quad (27)$$

with the correlation function in the coordinate space

with the correlation function to be

$$\Pi_{I=3/2}^{\bar{D}\Sigma_c}(x) = \Pi_0^{\bar{D}\Sigma_c}(x) + \Pi_G^{\bar{D}\Sigma_c}(x) - 2\Pi_Q^{\bar{D}\Sigma_c}(x). \quad (28)$$

In the above expression $\Pi_0^{\bar{D}\Sigma_c}(x)$, $\Pi_G^{\bar{D}\Sigma_c}(x)$, and $\Pi_Q^{\bar{D}\Sigma_c}(x)$ are taken from the $I = 1/2$ $\bar{D}\Sigma_c$ molecule.

Compared to Eq. (22), if the term $\Pi_Q(x)$ induces an attractive interaction to the $I = 1/2$ $\bar{D}\Sigma_c$ molecule, it would induce a repulsive interaction to the $I = 3/2$ $\bar{D}\Sigma_c$ molecule; and vice versa.

III. QCD SUM RULE STUDIES OF $D^-\Sigma_c^{++}/\bar{D}^0\Sigma_c^+/\bar{D}\Sigma_c$ MOLECULES

In this section we apply the method of QCD sum rules [55, 56] to investigate the light-quark-exchange term $\Pi_Q(x)$, and study its contributions to the $D^-\Sigma_c^{++}$, $\bar{D}^0\Sigma_c^+$, $I = 1/2$ $\bar{D}\Sigma_c$, and $I = 3/2$ $\bar{D}\Sigma_c$ hadronic molecular states.

In QCD sum rule analyses we consider the two-point correlation function in the momentum space:

$$\begin{aligned} \Pi(q^2) &= \text{i} \int d^4x e^{iqx} \langle 0|\mathbb{T} [J(x)\bar{J}(0)] |0\rangle \\ &= \text{i} \int d^4x e^{iqx} \Pi(x), \end{aligned} \quad (29)$$

where $J(x)$ is an interpolating current. We generally assume it to be a composite current, coupling to the molecular state $X \equiv |YZ\rangle$ through

$$\langle 0|J|X\rangle = f_X u_X. \quad (30)$$

We write $\Pi(q^2)$ in the form of dispersion relation as

$$\Pi(q^2) = \int_{s_{\text{cl}}}^{\infty} \frac{\rho(s)}{s - q^2 - \text{i}\epsilon} ds, \quad (31)$$

where $s_< = 4m_c^2$ is the physical threshold and $\rho(s) \equiv \text{Im}\Pi(s)/\pi$ is the spectral density.

At the quark-gluon level we calculate $\Pi(q^2)$ using the method of operator product expansion (OPE) up to certain order. According to Eqs. (8), (15), (22), and (28), we further separate it into

$$\Pi(q^2) \approx \Pi_0(q^2) + \Pi_Q(q^2), \quad (32)$$

and define their imaginary parts to be $\rho_0(s)$ and $\rho_Q(s)$. Here we have omitted the other term $\Pi_G(q^2)$, since the light-quark-exchange term $\Pi_Q(q^2)$ is much larger.

At the hadron level we evaluate the spectral density by inserting intermediate hadron states $\sum_n |n\rangle\langle n|$:

$$\begin{aligned} \rho(s) &= \sum_n \delta(s - M_n^2) \langle 0|J|n\rangle \langle n|\bar{J}|0\rangle \\ &= f_X^2 \delta(s - M_X^2) + \text{continuum}, \end{aligned} \quad (33)$$

where we have adopted a parametrization of one pole dominance for the ground state X together with a continuum contribution.

Given $X \equiv |YZ\rangle$ to be a molecular state, its mass M_X can be expanded as

$$\begin{aligned} M_X &= M_Y + M_Z + \Delta M \\ &\equiv M_0 + \Delta M. \end{aligned} \quad (34)$$

Then we insert Eq. (33) into Eq. (31), and expand it as

$$\begin{aligned} \Pi(q^2) &= \frac{f_X^2}{M_X^2 - q^2} + \dots \\ &\approx \frac{f_X^2}{M_0^2 - q^2} - \frac{2M_0 f_X^2}{(M_0^2 - q^2)^2} \Delta M + \dots. \end{aligned} \quad (35)$$

The former term is contributed by the non-correlated Y and Z , and the latter term is contributed by their interactions. Compared to Eq. (32), we further obtain:

$$\Pi_0(q^2) = \frac{f_X^2}{M_0^2 - q^2} + \dots, \quad (36)$$

$$\Pi_Q(q^2) = -\frac{2M_0 f_X^2}{(M_0^2 - q^2)^2} \Delta M + \dots. \quad (37)$$

We perform the Borel transformation to the above correlation functions at both hadron and quark-gluon levels. After assuming contributions from the continuum to be approximated by the OPE spectral densities $\rho_0(s)$ and $\rho_Q(s)$ above a threshold value s_0 , we arrive at two sum rule equations:

$$f_X^2 e^{-M_0^2/M_B^2} = \Pi_0(M_B^2, s_0) = \int_{s_<}^{s_0} e^{-s/M_B^2} \rho_0(s) ds, \quad (38)$$

$$-\frac{2M_0 f_X^2}{M_B^2} \Delta M e^{-M_0^2/M_B^2} = \Pi_Q(M_B^2, s_0) = \int_{s_<}^{s_0} e^{-s/M_B^2} \rho_Q(s) ds. \quad (39)$$

There are two free parameters in Eqs. (38) and (39): the Borel mass M_B and the threshold value s_0 . Differentiating Eq. (38) with respect to $1/M_B^2$, we obtain

$$M_0^2 = \frac{\int_{s_<}^{s_0} e^{-s/M_B^2} s \rho(s) ds}{\int_{s_<}^{s_0} e^{-s/M_B^2} \rho(s) ds}. \quad (40)$$

Given $M_0 = M_Y + M_Z$, this equation can be used to relate M_B and s_0 , so that there is only one free parameter left.

Dividing Eq. (39) by Eq. (38), we obtain

$$-\frac{2M_0}{M_B^2} \Delta M = \frac{\Pi_Q}{\Pi_0} = \frac{\int_{s_<}^{s_0} e^{-s/M_B^2} \rho_Q(s) ds}{\int_{s_<}^{s_0} e^{-s/M_B^2} \rho_0(s) ds}. \quad (41)$$

This equation can be used to calculate ΔM .

We shall use Eq. (41) to study contributions of the term $\Pi_Q(x)$ to the $D^-\Sigma_c^{++}$, $\bar{D}^0\Sigma_c^+$, $I = 1/2 \bar{D}\Sigma_c$, and

$I = 3/2 \bar{D}\Sigma_c$ hadronic molecular states, separately in the following subsections. Before doing this, we note that ΔM is actually not the binding energy, but relates to some potential $V(r)$ between Y and Z induced by exchanged/shared light quarks. We use the $I = 1/2 \bar{D}\Sigma_c$ hadronic molecular state as an example to qualitatively discuss this. After transforming the local current $J^{\bar{D}\Sigma_c}(x)$ defined in Eq. (21) into its non-local form:

$$\begin{aligned} &J^{\bar{D}\Sigma_c}(x, y) \\ &= \sqrt{\frac{1}{3}} J^{\bar{D}^0\Sigma_c^+}(x, y) - \sqrt{\frac{2}{3}} J^{D^-\Sigma_c^{++}}(x, y) \\ &= \sqrt{\frac{1}{3}} J^{\bar{D}^0}(x) J^{\Sigma_c^+}(y) - \sqrt{\frac{2}{3}} J^{D^-}(x) J^{\Sigma_c^{++}}(y), \end{aligned} \quad (42)$$

we calculate its non-local correlation function in the coordinate space to be:

$$\begin{aligned}
\Pi^{\bar{D}\Sigma_c}(x, y; x', y') &\equiv \langle 0 | \mathbb{T} \left[J^{\bar{D}\Sigma_c}(x, y) \bar{J}^{\bar{D}\Sigma_c}(x', y') \right] | 0 \rangle \\
&= -\text{Tr} \left[\mathbf{iS}_q^{dd'}(\Delta x) \gamma_5 \mathbf{iS}_c^{d'd}(-\Delta x) \gamma_5 \right] \times \epsilon^{abc} \epsilon^{a'b'c'r} \text{Tr} \left[\mathbf{iS}_q^{bb'}(\Delta x) \gamma^{\mu'} \mathbb{C}(\mathbf{iS}_q^{aa'}(\Delta x))^T \mathbb{C} \gamma^\mu \right] \gamma_\mu \gamma_5 \mathbf{iS}_c^{cc'}(\Delta x) \gamma_{\mu'} \gamma_5 \\
&\quad - \text{Tr} \left[\mathbf{iS}_q^{da'}(\Delta x - r) \gamma^{\mu'} \mathbb{C}(\mathbf{iS}_q^{bb'}(\Delta x))^T \mathbb{C} \gamma^\mu \mathbf{iS}_q^{ad'}(\Delta x + r) \gamma_5 \mathbf{iS}_c^{d'd}(-\Delta x) \gamma_5 \right] \gamma_\mu \gamma_5 \mathbf{iS}_c^{cc'}(\Delta x) \gamma_{\mu'} \gamma_5 \\
&= \Pi_0^{\bar{D}\Sigma_c}(\Delta x) + \Pi_G^{\bar{D}\Sigma_c}(\Delta x, r) + \Pi_Q^{\bar{D}\Sigma_c}(\Delta x, r). \tag{43}
\end{aligned}$$

In the above expression we have assumed that $y - y' = x - x' = \Delta x$ and $y - x = y' - x' = r$. The leading term $\Pi_0^{\bar{D}\Sigma_c}(\Delta x)$ does not change with the parameter r , while the light-quark-exchange term $\Pi_Q^{\bar{D}\Sigma_c}(\Delta x, r)$ decreases as $|r| \rightarrow \infty$. Accordingly, we arrive at:

- Because we are using local currents in QCD sum rule analyses,

$$V(|r| = 0) = \Delta M. \tag{44}$$

- Because the term $\Pi_Q(x)$ is color-unconfined, its contribution decreases as r increases:

$$V(|r| \rightarrow \infty) \rightarrow 0. \tag{45}$$

We may build a model and use the light-quark-exchange potential $V(r)$ to derive the binding energy of X , but this will not be done in the present study. Other than this, we shall calculate ΔM and qualitatively study several hadronic molecules possibly bound by this potential, through which we shall propose a model-independent hypothesis for such molecules.

The binding mechanism induced by the light-quark-exchange potential $V(r)$ is somewhat similar to the covalent bond in chemical molecules induced by shared electrons, so we call such hadronic molecules ‘‘covalent hadronic molecules’’.

A. $I = 1/2$ $\bar{D}\Sigma_c$ sum rules

In this subsection we apply QCD sum rules to study the $I = 1/2$ $\bar{D}\Sigma_c$ molecule. We have calculated its correlation function at the leading order of α_s and up to the $D(\text{imension}) = 10$ terms, including the perturbative term, the quark condensate $\langle \bar{q}q \rangle$, the gluon condensate $\langle g_s^2 GG \rangle$, the quark-gluon mixed condensate $\langle g_s \bar{q}\sigma Gq \rangle$, and their combinations $\langle \bar{q}q \rangle^2$, $\langle \bar{q}q \rangle \langle g_s \bar{q}\sigma Gq \rangle$, $\langle \bar{q}q \rangle^3$, and $\langle g_s \bar{q}\sigma Gq \rangle^2$. The extracted spectral density

$$\rho^{\bar{D}\Sigma_c}(s) = \rho_0^{\bar{D}\Sigma_c}(s) + \rho_Q^{\bar{D}\Sigma_c}(s), \tag{46}$$

is given in Appendix A.

To perform numerical analyses, we use the following values for various QCD sum rule parameters in the

present study [2, 57–65]:

$$\begin{aligned}
m_s &= 96_{-4}^{+8} \text{ MeV}, \\
m_c &= 1.275_{-0.035}^{+0.025} \text{ GeV}, \\
\langle \bar{q}q \rangle &= -(0.240 \pm 0.010)^3 \text{ GeV}^3, \\
\langle \bar{s}s \rangle &= (0.8 \pm 0.1) \times \langle \bar{q}q \rangle, \\
\langle g_s^2 GG \rangle &= 0.48 \pm 0.14 \text{ GeV}^4, \\
\langle g_s \bar{q}\sigma Gq \rangle &= -M_0^2 \times \langle \bar{q}q \rangle, \\
\langle g_s \bar{s}\sigma Gs \rangle &= -M_0^2 \times \langle \bar{s}s \rangle, \\
M_0^2 &= 0.8 \pm 0.2 \text{ GeV}^2,
\end{aligned} \tag{47}$$

where the running mass in the \overline{MS} scheme is used for the charm quark.

There are two free parameters in Eqs. (38) and (39): the Borel mass M_B and the threshold value s_0 . We use Eq. (40) to constrain them by setting [2]:

$$\begin{aligned}
M_0^{\bar{D}\Sigma_c} &= \frac{1}{3} \times (M_{\bar{D}^0} + M_{\Sigma_c^+}) + \frac{2}{3} \times (M_{D^-} + M_{\Sigma_c^{++}}) \\
&= 4321.66 \text{ MeV}. \tag{48}
\end{aligned}$$

The derived relation between M_B and s_0 is depicted in Fig. 5, which will be used in the following calculations.

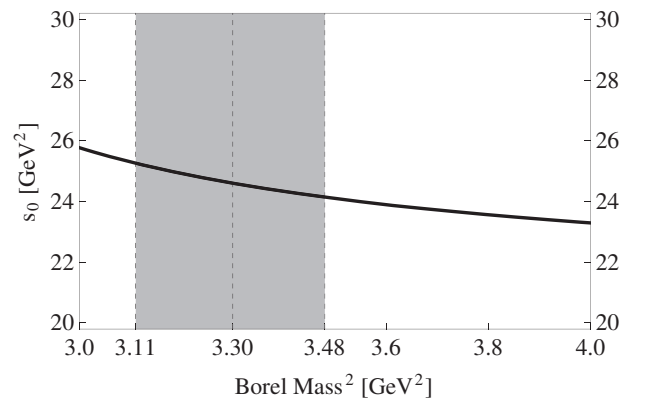

FIG. 5: Relation between the Borel mass M_B and the threshold value s_0 , constrained by Eq. (40).

There are two criteria to constrain the Borel mass M_B . The first criterion is to insure the convergence of the OPE series, by requiring the $D = 10$ terms $m_c \langle \bar{q}q \rangle^3$ and

$(g_s \bar{q} \sigma G q)^2$ to be less than 15%:

$$\text{Convergence} \equiv \left| \frac{\Pi^{D=10}(\infty, M_B)}{\Pi(\infty, M_B)} \right| \leq 15\%. \quad (49)$$

This criterion determines the lower limit of M_B . As shown in Fig. 6 using the solid curve, we find it to be $(M_B^{min})^2 = 3.11 \text{ GeV}^2$.

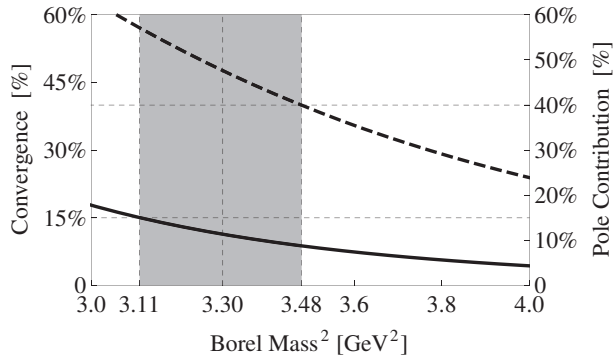

FIG. 6: Convergence (solid) and Pole-Contribution (dashed) as functions of the Borel mass M_B .

The second criterion is to insure the validity of one-pole parametrization, by requiring the pole contribution to be larger than 40%:

$$\text{Pole-Contribution} \equiv \frac{\Pi(s_0(M_B), M_B)}{\Pi(\infty, M_B)} \geq 40\%. \quad (50)$$

This determines the upper limit of M_B . As shown in Fig. 6 using the dashed curve, we find it to be $(M_B^{max})^2 = 3.48 \text{ GeV}^2$.

Altogether we extract the working region of M_B to be $3.11 \text{ GeV}^2 < M_B^2 < 3.48 \text{ GeV}^2$, where we use Eq. (41) to calculate the mass correction to be

$$\Delta M_{I=1/2, J=1/2}^{\bar{D}\Sigma_c} = -95 \text{ MeV}. \quad (51)$$

We show its variation in Fig. 7 with respect to the Borel mass M_B . It is shown in a broader region $3.0 \text{ GeV}^2 \leq M_B^2 \leq 4.0 \text{ GeV}^2$, and we find it quite stable inside the above Borel window.

The mass correction $\Delta M_{I=1/2, J=1/2}^{\bar{D}\Sigma_c}$ given in Eq. (51) is negative, suggesting the light-quark-exchange potential $V_{I=1/2, J=1/2}^{\bar{D}\Sigma_c}(r)$ to be attractive, so there can be the $\bar{D}\Sigma_c$ covalent molecule of $I = 1/2$ and $J = 1/2$.

B. $D^-\Sigma_c^{++}$ sum rules

As shown in Eq. (8), the light-quark-exchange term $\Pi_Q(x)$ does not contribute to the correlation function of the $D^-\Sigma_c^{++}$ molecule, so the $D^-\Sigma_c^{++}$ covalent molecule does not exist.

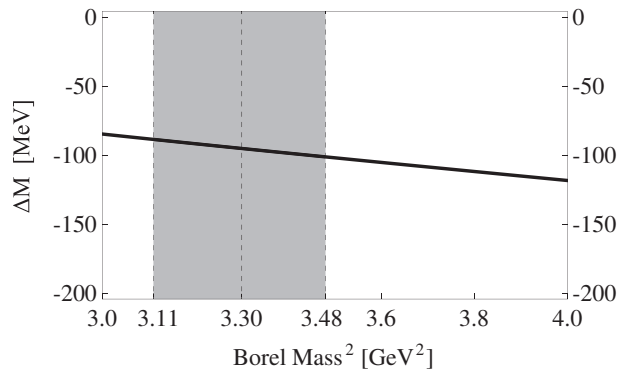

FIG. 7: The mass correction $\Delta M_{I=1/2, J=1/2}^{\bar{D}\Sigma_c}$ as a function of the Borel mass M_B .

C. $\bar{D}^0\Sigma_c^+$ sum rules

We follow Sec. III A to study the $\bar{D}^0\Sigma_c^+$ molecule, and calculate its mass correction to be

$$\Delta M_{J=1/2}^{\bar{D}^0\Sigma_c^+} \approx -\Delta M_{I=1/2, J=1/2}^{\bar{D}\Sigma_c} = 95 \text{ MeV}. \quad (52)$$

This result suggests $V_{J=1/2}^{\bar{D}^0\Sigma_c^+}(r)$ to be repulsive, so the $\bar{D}^0\Sigma_c^+$ covalent molecule does not exist.

D. $I = 3/2$ $\bar{D}\Sigma_c$ sum rules

We follow Sec. III A to study the $I = 3/2$ $\bar{D}\Sigma_c$ molecule, and calculate its mass correction to be

$$\Delta M_{I=3/2, J=1/2}^{\bar{D}\Sigma_c} \approx -2\Delta M_{I=1/2, J=1/2}^{\bar{D}\Sigma_c} = 190 \text{ MeV}. \quad (53)$$

This result suggests $V_{I=3/2, J=1/2}^{\bar{D}\Sigma_c}(r)$ to be repulsive, so the $\bar{D}\Sigma_c$ covalent molecule of $I = 3/2$ and $J = 1/2$ does not exist.

IV. MORE HADRONIC MOLECULES

In this section we follow the procedures used in Sec. III A and study more possibly-existing covalent hadronic molecules. We shall investigate the $\bar{D}^*\Sigma_c/\bar{D}\Sigma_c^*/\bar{D}^*\Sigma_c^*$ molecules, the $\bar{D}^{(*)}\Lambda_c$ molecules, the $D^{(*)}\bar{K}^*$ molecules, and the $D^{(*)}\bar{D}^{(*)}$ molecules, separately in the following subsections.

A. $\bar{D}^*\Sigma_c/\bar{D}\Sigma_c^*/\bar{D}^*\Sigma_c^*$ molecules

In this subsection we investigate the light-quark-exchange term $\Pi_Q(x)$ and study its contributions to the $\bar{D}^*\Sigma_c/\bar{D}\Sigma_c^*/\bar{D}^*\Sigma_c^*$ molecules.

The current corresponding to the $\bar{D}^*\Sigma_c$ molecule is

$$\begin{aligned} J_\alpha^{\bar{D}^*\Sigma_c}(x) &= J_\alpha^{\bar{D}^*}(x) \times J^{\Sigma_c}(x) \\ &= [\bar{c}_d(x)\gamma_\alpha q_d(x)] \times [\epsilon^{abc} q_a^\dagger(x)\mathbb{C}\gamma^\mu q_b(x)\gamma_\mu\gamma_5 c_c(x)]. \end{aligned} \quad (54)$$

Its correlation function is

$$\begin{aligned} &\Pi_{\alpha\beta}^{\bar{D}^*\Sigma_c}(q^2) \\ &= i \int d^4x e^{iqx} \langle 0 | \mathbb{T} [J_\alpha^{\bar{D}^*\Sigma_c}(x) \bar{J}_\beta^{\bar{D}^*\Sigma_c}(0)] | 0 \rangle \\ &= \mathcal{G}_{\alpha\beta}^{3/2}(q^2) \Pi_{J=3/2}^{\bar{D}^*\Sigma_c}(q^2) + \mathcal{G}_{\alpha\beta}^{1/2}(q^2) \Pi_{J=1/2}^{\bar{D}^*\Sigma_c}(q^2), \end{aligned} \quad (55)$$

where $\Pi_{J=3/2}^{\bar{D}^*\Sigma_c}(q^2)$ and $\Pi_{J=1/2}^{\bar{D}^*\Sigma_c}(q^2)$ are contributed by the spin-3/2 and spin-1/2 components, respectively. $\mathcal{G}_{\alpha\beta}^{3/2}(q^2)$ and $\mathcal{G}_{\alpha\beta}^{1/2}(q^2)$ are coefficients of the spin-3/2 and spin-1/2 propagators, respectively:

$$\begin{aligned} \mathcal{G}_{\alpha\beta}^{3/2}(q^2) &= \left(g_{\alpha\beta} - \frac{\gamma_\alpha\gamma_\beta}{3} - \frac{q_\alpha\gamma_\beta - q_\beta\gamma_\alpha}{3M} - \frac{2q_\alpha q_\beta}{3M^2} \right) \\ &\quad \times (\not{q} + M), \end{aligned} \quad (56)$$

$$\mathcal{G}_{\alpha\beta}^{1/2}(q) = q_\alpha q_\beta \times (\not{q} + M). \quad (57)$$

In the present study we have only calculated the terms proportional to the Lorentz coefficient $g_{\alpha\beta}$, so we can only extract the mass correction to the spin-3/2 $\bar{D}^*\Sigma_c$ molecule. We find it negative for the $I = 1/2$ one:

$$\Delta M_{I=1/2, J=3/2}^{\bar{D}^*\Sigma_c} = -89 \text{ MeV}. \quad (58)$$

This result suggests $V_{I=1/2, J=3/2}^{\bar{D}^*\Sigma_c}(r)$ to be attractive, so there can be the $\bar{D}^*\Sigma_c$ covalent molecule of $I = 1/2$ and $J = 3/2$.

Similarly, we use the current

$$\begin{aligned} J_\alpha^{\bar{D}\Sigma_c}(x) &= J^{\bar{D}}(x) \times J_{\alpha_2}^{\Sigma_c}(x) \\ &= [\bar{c}_d(x)\gamma_5 q_d(x)] \times [\epsilon^{abc} q_a^\dagger(x)\mathbb{C}\gamma^\mu q_b(x)P_{\alpha_2}^{3/2}c_c(x)], \end{aligned} \quad (59)$$

to perform QCD sum rule analyses and study the $\bar{D}\Sigma_c^*$ molecule. Here $P_{\alpha_2}^{3/2}$ is the spin-3/2 projection operator

$$P_{\alpha\mu}^{3/2} = g_{\alpha\mu} - \frac{1}{4}\gamma_\alpha\gamma_\mu. \quad (60)$$

We calculate its mass correction to be

$$\Delta M_{I=1/2, J=3/2}^{\bar{D}\Sigma_c^*} = -86 \text{ MeV}. \quad (61)$$

This result suggests $V_{I=1/2, J=3/2}^{\bar{D}\Sigma_c^*}(r)$ to be attractive, so there can be the $\bar{D}\Sigma_c^*$ covalent molecule of $I = 1/2$ and $J = 3/2$.

The current corresponding to the $\bar{D}^*\Sigma_c^*$ molecule is

$$\begin{aligned} J_{\alpha_1\alpha_2}^{\bar{D}^*\Sigma_c^*}(x) &= J_{\alpha_1}^{\bar{D}^*}(x) \times J_{\alpha_2}^{\Sigma_c^*}(x) \\ &= [\bar{c}_d(x)\gamma_{\alpha_1} q_d(x)] \times [\epsilon^{abc} q_a^\dagger(x)\mathbb{C}\gamma^\mu q_b(x)P_{\alpha_2}^{3/2}c_c(x)]. \end{aligned} \quad (62)$$

Its correlation function is

$$\begin{aligned} &\Pi_{\alpha_1\alpha_2, \beta_1\beta_2}^{\bar{D}^*\Sigma_c^*}(q^2) \\ &= i \int d^4x e^{iqx} \langle 0 | \mathbb{T} [J_{\alpha_1\alpha_2}^{\bar{D}^*\Sigma_c^*}(x) \bar{J}_{\beta_1\beta_2}^{\bar{D}^*\Sigma_c^*}(0)] | 0 \rangle \\ &= \mathcal{G}_{\alpha_1\alpha_2, \beta_1\beta_2}^{5/2}(q^2) \Pi_{J=5/2}^{\bar{D}^*\Sigma_c^*}(q^2) \\ &\quad + \mathcal{G}_{\alpha_1\alpha_2, \beta_1\beta_2}^{3/2}(q^2) \Pi_{J=3/2}^{\bar{D}^*\Sigma_c^*}(q^2) \\ &\quad + \mathcal{G}_{\alpha_1\alpha_2, \beta_1\beta_2}^{1/2}(q^2) \Pi_{J=1/2}^{\bar{D}^*\Sigma_c^*}(q^2) + \dots, \end{aligned} \quad (63)$$

where $\Pi_{J=5/2}^{\bar{D}^*\Sigma_c^*}(q^2)$, $\Pi_{J=3/2}^{\bar{D}^*\Sigma_c^*}(q^2)$, and $\Pi_{J=1/2}^{\bar{D}^*\Sigma_c^*}(q^2)$ are contributed by the spin-5/2, spin-3/2, and spin-1/2 components, respectively. $\mathcal{G}_{\alpha_1\alpha_2, \beta_1\beta_2}^{5/2}(q^2)$, $\mathcal{G}_{\alpha_1\alpha_2, \beta_1\beta_2}^{3/2}(q^2)$, and $\mathcal{G}_{\alpha_1\alpha_2, \beta_1\beta_2}^{1/2}(q^2)$ are coefficients of the spin-5/2, spin-3/2, and spin-1/2 propagators, respectively:

$$\begin{aligned} \mathcal{G}_{\alpha_1\alpha_2, \beta_1\beta_2}^{5/2}(q^2) &= (\not{q} + M) \\ &\quad \times \left(\frac{g_{\alpha_1\beta_1}g_{\alpha_2\beta_2}}{2} + \frac{g_{\alpha_1\beta_2}g_{\alpha_2\beta_1}}{2} - \frac{g_{\alpha_1\alpha_2}g_{\beta_1\beta_2}}{4} \right), \end{aligned} \quad (64)$$

$$\begin{aligned} \mathcal{G}_{\alpha_1\alpha_2, \beta_1\beta_2}^{3/2}(q^2) &= (\not{q} + M) \\ &\quad \times \left(\frac{g_{\alpha_1\beta_1}g_{\alpha_2\beta_2}}{2} - \frac{g_{\alpha_1\beta_2}g_{\alpha_2\beta_1}}{2} \right), \end{aligned} \quad (65)$$

$$\mathcal{G}_{\alpha_1\alpha_2, \beta_1\beta_2}^{1/2}(q^2) = (\not{q} + M) \times g_{\alpha_1\alpha_2}g_{\beta_1\beta_2}. \quad (66)$$

In the present study we have calculated the terms proportional to the three Lorentz coefficients $g_{\alpha_1\beta_1}g_{\alpha_2\beta_2}$, $g_{\alpha_1\beta_2}g_{\alpha_2\beta_1}$, and $g_{\alpha_1\alpha_2}g_{\beta_1\beta_2}$, so we can extract mass corrections to all the three $I = 1/2$ $\bar{D}^*\Sigma_c^*$ molecules of $J = 5/2$, $J = 3/2$, and $J = 1/2$:

$$\Delta M_{I=1/2, J=5/2}^{\bar{D}^*\Sigma_c^*} = -107 \text{ MeV}, \quad (67)$$

$$\Delta M_{I=1/2, J=3/2}^{\bar{D}^*\Sigma_c^*} = -47 \text{ MeV}, \quad (68)$$

$$\Delta M_{I=1/2, J=1/2}^{\bar{D}^*\Sigma_c^*} = 3.5 \text{ MeV}. \quad (69)$$

These results suggest $V_{I=1/2, J=5/2}^{\bar{D}^*\Sigma_c^*}(r)$ to be attractive, so there can be the $\bar{D}^*\Sigma_c^*$ covalent molecule of $I = 1/2$ and $J = 5/2$.

For completeness, we show variations of $\Delta M^{\bar{D}^*\Sigma_c^*}$ in Fig. 8 with respect to the Borel mass M_B . Besides, we study the $I = 3/2$ $\bar{D}^*\Sigma_c/\bar{D}\Sigma_c^*/\bar{D}^*\Sigma_c^*$ molecules and obtain

$$\Delta M_{I=3/2}^{\bar{D}^*\Sigma_c/\bar{D}\Sigma_c^*/\bar{D}^*\Sigma_c^*} \approx -2\Delta M_{I=1/2}^{\bar{D}^*\Sigma_c/\bar{D}\Sigma_c^*/\bar{D}^*\Sigma_c^*}. \quad (70)$$

B. $\bar{D}^{(*)}\Lambda_c$ molecules

In this subsection we investigate the light-quark-exchange term $\Pi_Q(x)$ and study its contributions to the $\bar{D}^{(*)}\Lambda_c$ molecules.

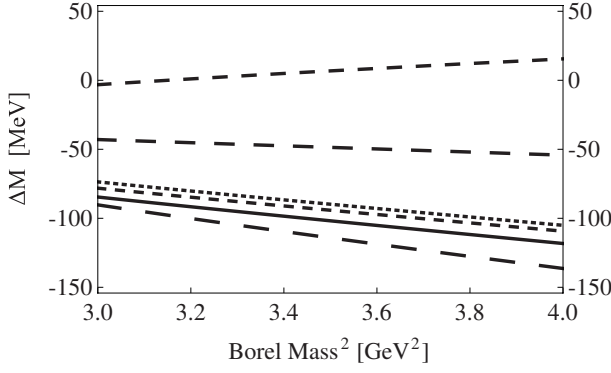

FIG. 8: Mass corrections $\Delta M^{\bar{D}^{(*)}\Sigma_c^{(*)}}$ as functions of the Borel mass M_B . The curves from top to bottom correspond to $\Delta M_{I=1/2, J=1/2}^{\bar{D}^*\Sigma_c^*}$, $\Delta M_{I=1/2, J=3/2}^{\bar{D}^*\Sigma_c^*}$, $\Delta M_{I=1/2, J=3/2}^{\bar{D}^*\Sigma_c}$, $\Delta M_{I=1/2, J=3/2}^{\bar{D}\Sigma_c^*}$, $\Delta M_{I=1/2, J=1/2}^{\bar{D}\Sigma_c}$, and $\Delta M_{I=1/2, J=5/2}^{\bar{D}^*\Sigma_c^*}$, respectively.

The currents corresponding to the $\bar{D}\Lambda_c$ and $\bar{D}^*\Lambda_c$ molecules are

$$J^{\bar{D}\Lambda_c}(x) = J^{\bar{D}}(x) \times J^{\Lambda_c}(x) \quad (71)$$

$$= [\bar{c}_d(x)\gamma_5 q_d(x)] \times [\epsilon^{abc} q_a^T(x) \mathbb{C} \gamma_5 q_b(x) c_c(x)],$$

$$J_{\alpha}^{\bar{D}^*\Lambda_c}(x) = J_{\alpha}^{\bar{D}^*}(x) \times J^{\Lambda_c}(x) \quad (72)$$

$$= [\bar{c}_d(x)\gamma_{\alpha} q_d(x)] \times [\epsilon^{abc} q_a^T(x) \mathbb{C} \gamma_5 q_b(x) c_c(x)].$$

We use them to perform QCD sum rule analyses, and calculate mass corrections to the $\bar{D}\Lambda_c$ molecule of $J = 1/2$ and the $\bar{D}^*\Lambda_c$ molecule of $J = 3/2$. We find both of them to be positive. However, we do not obtain the mass correction to the $\bar{D}^*\Lambda_c$ molecule of $J = 1/2$, just like the $\bar{D}^*\Sigma_c$ molecule of $J = 1/2$. These results suggest $V_{I=1/2, J=1/2}^{\bar{D}\Lambda_c}(r)$ and $V_{I=1/2, J=3/2}^{\bar{D}^*\Lambda_c}(r)$ to be both repulsive, so the $J = 1/2$ $\bar{D}\Lambda_c$ and $J = 3/2$ $\bar{D}^*\Lambda_c$ covalent molecules do not exist.

C. $D^{(*)}\bar{K}^*$ molecules

In this subsection we investigate the light-quark-exchange term $\Pi_Q(x)$ and study its contributions to the $D^{(*)}\bar{K}^*$ molecules. We do not investigate the $D^{(*)}\bar{K}$ molecules in the present study, because their bare masses $M_{D^{(*)}} + M_{\bar{K}}$ can not be easily reached within the present QCD sum rule approach, due to the nature of K mesons as Nambu-Goldstone bosons.

The current corresponding to the $D\bar{K}^*$ molecule is

$$J_{\alpha}^{D\bar{K}^*}(x) = J^{\bar{D}}(x) \times J_{\alpha}^{\bar{K}^*}(x) \quad (73)$$

$$= [\bar{q}_a(x)\gamma_5 c_a(x)] \times [\bar{q}_b(x)\gamma_{\alpha} s_b(x)].$$

Its correlation function is

$$\begin{aligned} & \Pi_{\alpha\beta}^{D\bar{K}^*}(q^2) \quad (74) \\ &= i \int d^4x e^{iqx} \langle 0 | \mathbb{T} [J_{\alpha}^{D\bar{K}^*}(x) J_{\beta}^{D\bar{K}^* \dagger}(0)] | 0 \rangle \\ &= \left(g_{\alpha\beta} - \frac{q_{\alpha} q_{\beta}}{q^2} \right) \Pi^{D\bar{K}^*}(q^2) + \dots \end{aligned}$$

We use $J_{\alpha}^{D\bar{K}^*}(x)$ to perform QCD sum rule analyses, and calculate its mass correction to be

$$\Delta M_{I=0, J=1}^{D\bar{K}^*} = -180 \text{ MeV}. \quad (75)$$

This suggests $V_{I=0, J=1}^{D\bar{K}^*}(r)$ to be attractive, so there can be the $D\bar{K}^*$ covalent molecule of $I = 0$ and $J = 1$.

The current corresponding to the $D^*\bar{K}^*$ molecule is

$$\begin{aligned} J_{\alpha_1\alpha_2}^{D^*\bar{K}^*}(x) &= J_{\alpha_1}^{\bar{D}^*}(x) \times J_{\alpha_2}^{\bar{K}^*}(x) \quad (76) \\ &= [\bar{q}_a(x)\gamma_{\alpha_1} c_a(x)] \times [\bar{q}_b(x)\gamma_{\alpha_2} s_b(x)]. \end{aligned}$$

Its correlation function is

$$\begin{aligned} & \Pi_{\alpha_1\alpha_2, \beta_1\beta_2}^{D^*\bar{K}^*}(q^2) \quad (77) \\ &= i \int d^4x e^{iqx} \langle 0 | \mathbb{T} [J_{\alpha_1\alpha_2}^{D^*\bar{K}^*}(x) J_{\beta_1\beta_2}^{D^*\bar{K}^* \dagger}(0)] | 0 \rangle \\ &= \mathcal{G}_{\alpha_1\alpha_2, \beta_1\beta_2}^2(q^2) \Pi_{J=2}^{D^*\bar{K}^*}(q^2) \\ &+ \mathcal{G}_{\alpha_1\alpha_2, \beta_1\beta_2}^1(q^2) \Pi_{J=1}^{D^*\bar{K}^*}(q^2) \\ &+ \mathcal{G}_{\alpha_1\alpha_2, \beta_1\beta_2}^0(q^2) \Pi_{J=0}^{D^*\bar{K}^*}(q^2) + \dots, \end{aligned}$$

where $\Pi_{J=2}^{D^*\bar{K}^*}(q^2)$, $\Pi_{J=1}^{D^*\bar{K}^*}(q^2)$, and $\Pi_{J=0}^{D^*\bar{K}^*}(q^2)$ are contributed by the spin-2, spin-1, and spin-0 components, respectively. $\mathcal{G}_{\alpha_1\alpha_2, \beta_1\beta_2}^2(q^2)$, $\mathcal{G}_{\alpha_1\alpha_2, \beta_1\beta_2}^1(q^2)$, and $\mathcal{G}_{\alpha_1\alpha_2, \beta_1\beta_2}^0(q^2)$ are coefficients of the spin-2, spin-1, and spin-0 propagators, respectively:

$$\mathcal{G}_{\alpha_1\alpha_2, \beta_1\beta_2}^2(q^2) = \frac{g_{\alpha_1\beta_1} g_{\alpha_2\beta_2}}{2} + \frac{g_{\alpha_1\beta_2} g_{\alpha_2\beta_1}}{2} - \frac{g_{\alpha_1\alpha_2} g_{\beta_1\beta_2}}{4}, \quad (78)$$

$$\mathcal{G}_{\alpha_1\alpha_2, \beta_1\beta_2}^1(q^2) = \frac{g_{\alpha_1\beta_1} g_{\alpha_2\beta_2}}{2} - \frac{g_{\alpha_1\beta_2} g_{\alpha_2\beta_1}}{2}, \quad (79)$$

$$\mathcal{G}_{\alpha_1\alpha_2, \beta_1\beta_2}^0(q^2) = g_{\alpha_1\alpha_2} g_{\beta_1\beta_2}. \quad (80)$$

We use $J_{\alpha_1\alpha_2}^{D^*\bar{K}^*}(x)$ to perform QCD sum rule analyses, and extract mass corrections to the three isoscalar $D^*\bar{K}^*$ molecules of $J = 2$, $J = 1$, and $J = 0$:

$$\Delta M_{I=0, J=2}^{D^*\bar{K}^*} = -119 \text{ MeV}, \quad (81)$$

$$\Delta M_{I=0, J=1}^{D^*\bar{K}^*} = -46 \text{ MeV}, \quad (82)$$

$$\Delta M_{I=0, J=0}^{D^*\bar{K}^*} = -4.5 \text{ MeV}. \quad (83)$$

These results suggest $V_{I=0, J=2}^{D^*\bar{K}^*}(r)$ to be attractive, so there can be the $D^*\bar{K}^*$ covalent molecule of $I = 0$ and $J = 2$.

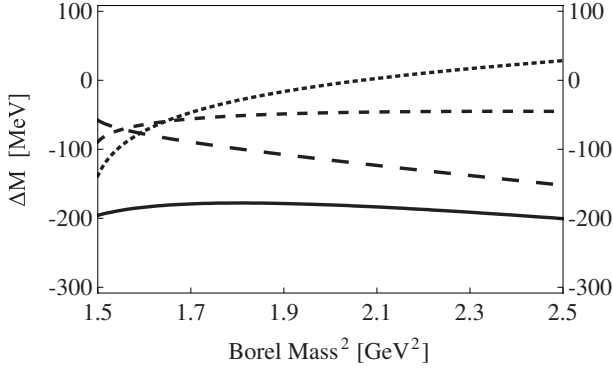

FIG. 9: Mass corrections $\Delta M^{D^{(*)}\bar{K}^*}$ as functions of the Borel mass M_B . The curves from top to bottom correspond to $\Delta M_{I=0,J=0}^{D^*\bar{K}^*}$ (short-dashed), $\Delta M_{I=0,J=1}^{D^*\bar{K}^*}$ (middle-dashed), $\Delta M_{I=0,J=2}^{D^*\bar{K}^*}$ (long-dashed), and $\Delta M_{I=0,J=1}^{D\bar{K}^*}$ (solid), respectively.

We show variations of $\Delta M^{D^{(*)}\bar{K}^*}$ in Fig. 9 with respect to the Borel mass M_B . Especially, $V_{I=0,J=0}^{D^*\bar{K}^*}(r)$ depends significantly on the Borel mass M_B and so also on the threshold value s_0 , for which we refer to Sec. V for relevant model-independent discussions.

For completeness, we study the isovector $D^{(*)}\bar{K}^*$ molecules and obtained

$$\Delta M_{I=1}^{D\bar{K}^*/D^*\bar{K}^*} \approx -\Delta M_{I=0}^{D\bar{K}^*/D^*\bar{K}^*}. \quad (84)$$

D. $D^{(*)}\bar{D}^{(*)}$ molecules

The light-quark-exchange term $\Pi_Q(x)$ does not contribute to correlation functions of the $D^{(*)}\bar{D}^{(*)}$ molecules, suggesting the $D^{(*)}\bar{D}^{(*)}$ covalent molecules not to exist. However, there can still be the $D^{(*)}\bar{D}^{(*)}$ hadronic molecular states induced by some other binding mechanisms, such as the one-meson-exchange interaction [23–32].

V. COVALENT HADRONIC MOLECULE

In the previous section we have applied QCD sum rules to study the binding mechanism induced by shared light quarks. This mechanism is somewhat similar to the covalent bond in chemical molecules induced by shared electrons, so we call such hadronic molecules “covalent hadronic molecules”. Recalling that the two shared electrons must spin in opposite directions (and so totally antisymmetric obeying the Pauli principle) in order to form a chemical covalent bond, our QCD sum rule results indicate a similar behavior: *the light-quark-exchange interaction is attractive when the shared light quarks are totally antisymmetric so that obey the Pauli principle* (these quarks may spin in the same direction given their flavor structure capable of being antisymmetric).

In this section we qualitatively study the above hypothesis. Its logical chain is quite straightforward. We assume the two light quarks q_A inside Y and q_B inside Z are totally antisymmetric. Hence, q_A and q_B obey the Pauli principle, so that they can be exchanged and shared. By doing this, wave-functions of Y and Z overlap with each other, so that they are attracted and there can be the covalent hadronic molecule $X = |YZ\rangle$. This picture has been depicted in Fig. 1. We believe it better and more important than our QCD sum rule results, given it to be model independent and more easily applicable.

We apply it to study several examples as follows. The two exchanged light quarks have the same color and so the symmetric color structure; besides, we assume their orbital structure to be S -wave and so also symmetric; consequently, we only need to investigate their spin and flavor structures.

a. $\bar{D}^{(*)0}[\bar{c}_1 u_2] - \Lambda_c^+[u_3 d_4 c_5]$ *covalent molecules*. Let us exchange u_2 inside $\bar{D}^{(*)0}$ and u_3 inside Λ_c^+ . u_3 and d_4 inside Λ_c^+ spin in opposite directions, u_2 and d_4 also need to spin in opposite directions in order to form another Λ_c^+ , so u_2 and u_3 spin in the same direction with the symmetric spin structure. The flavor structure of u_2 and u_3 is also symmetric, so they are totally symmetric (**S**=symmetric and **A**=antisymmetric):

	color	flavor	spin	orbital	total
$u_2 \leftrightarrow u_3$	S	S	S	S	S

Accordingly, the $\bar{D}^{(*)}\Lambda_c$ covalent molecules do not exist. This is consistent with our QCD sum rule result obtained in Sec. IV B.

b. $\bar{D}^0[\bar{c}_1 u_2] - \Sigma_c^+[u_3 d_4 c_5]$ *covalent molecule*. Let us exchange u_2 inside \bar{D}^0 and u_3 inside Σ_c^+ . \bar{c}_1 and u_2 inside \bar{D}^0 spin in opposite directions, \bar{c}_1 and u_3 also need to spin in opposite directions in order to form another \bar{D}^0 , so u_2 and u_3 spin in the same direction with the symmetric spin structure. The flavor structure of u_2 and u_3 is also symmetric, so they are totally symmetric:

	color	flavor	spin	orbital	total
$u_2 \leftrightarrow u_3$	S	S	S	S	S

Accordingly, the $\bar{D}^0\Sigma_c^+$ covalent molecule does not exist, consistent with Sec. III C.

c. $\bar{D}[\bar{c}_1 q_2] - \Sigma_c[q_3 q_4 c_5]$ *covalent molecule* ($q = u/d$). After including the isospin symmetry, the exchange can take place between up and down quarks. Let us exchange q_2 inside \bar{D} and q_3 inside Σ_c . As discussed above, they have the symmetric spin structure, so they can be totally antisymmetric as long as their flavor structure is antisymmetric:

	color	flavor	spin	orbital	total
$q_2 \leftrightarrow q_3$	S	A	S	S	A

Accordingly, there can be the $I = 1/2 \bar{D}\Sigma_c$ covalent molecule, but not the $I = 3/2$ one. This is consistent

with our QCD sum rule result obtained in Sec. III A and Sec. III D. Similarly, we derive that there can be the $I = 1/2 \bar{D}\Sigma_c^*$ and $I = 0 \bar{D}\bar{K}^*$ covalent molecules, consistent with Sec. IV A and Sec. IV C.

d. $J = 5/2 \bar{D}^*[\bar{c}_1 q_2] - \Sigma_c^*[q_3 q_4 c_5]$ covalent molecule. Let us exchange q_2 inside \bar{D}^* and q_3 inside Σ_c^* . In the $J_z = +5/2$ component, all the quarks/antiquark spin in the same direction, so q_2 and q_3 have the symmetric spin structure. They can be totally antisymmetric as long as their flavor structure is antisymmetric:

	color	flavor	spin	orbital	total
$q_2 \leftrightarrow q_3$	S	A	S	S	A

Accordingly, there can be the $I = 1/2 \bar{D}^*\Sigma_c^*$ covalent molecule of $J = 5/2$, but not the $I = 3/2$ one. This is consistent with our QCD sum rule result obtained in Sec. IV A. Similarly, we derive that there can be the $D^*\bar{K}^*$ covalent molecule of $I = 0$ and $J = 2$, consistent with Sec. IV C.

e. $J = 0 D^*[c_1 \bar{q}_2] - \bar{K}^*[s_3 \bar{q}_4]$ covalent molecule. Let us exchange \bar{q}_2 inside D^* and \bar{q}_4 inside \bar{K}^* . We perform the spin decomposition (see Appendix B):

$$\begin{aligned} & |1_{c\bar{q}} \otimes 1_{s\bar{q}}; J = 0\rangle \\ &= \frac{\sqrt{3}}{2} |0_{cs} \otimes 0_{\bar{q}\bar{q}}; J = 0\rangle - \frac{1}{2} |1_{cs} \otimes 1_{\bar{q}\bar{q}}; J = 0\rangle. \end{aligned} \quad (85)$$

Hence, there exists both $s_{\bar{q}_2\bar{q}_4} = 0$ (75%) and $s_{\bar{q}_2\bar{q}_4} = 1$ (25%) components. The former becomes attractive when $I = 1$, and the latter becomes attractive when $I = 0$:

	color	flavor	spin	orbital	total
$\bar{q}_2 \leftrightarrow \bar{q}_4$	S	S	A	S	A
$\bar{q}_2 \leftrightarrow \bar{q}_4$	S	A	S	S	A

It is well known that there are both the para-hydrogen and ortho-hydrogen, where the two protons spin in opposite directions and in the same direction, respectively. Similarly, there might be two $J = 0 D^*\bar{K}^*$ covalent molecules, *i.e.*, the two components $|0_{cs} \otimes 0_{\bar{q}\bar{q}}; J = 0\rangle$ of $I = 1$ and $|1_{cs} \otimes 1_{\bar{q}\bar{q}}; J = 0\rangle$ of $I = 0$. However, our QCD sum rule studies performed in Sec. IV C can not differentiate these two hyperfine structures, because there we have summed over the D^* and \bar{K}^* polarizations.

It is useful to generally discuss how many light quarks at most are there in the lowest orbit ($q = u/d$):

1. In the $\bar{D}^{(*)}[\bar{c}_1 q_2]K^{(*)}[s_3 q_4]$ covalent molecule, the two exchanged light quarks q_2 and q_4 have the same color and so the symmetric color structure; besides, we assume their orbital structure to be S -wave and so also symmetric; consequently, there are two possible configurations satisfying the Pauli principle (**S**=symmetric and **A**=antisymmetric):

	color	flavor	spin	orbital	total
$q_2 \leftrightarrow q_4$	S	A	S	S	A
$q_2 \leftrightarrow q_4$	S	S	A	S	A

Hence, two antiquarks can share (at most) two quarks, with the quantum numbers either $(I)J^P = (0)1^+$ or $(1)0^+$.

2. In the $\bar{D}^{(*)}[\bar{c}_1 q_2] - \Sigma_c^{(*)}[q_3 q_4 c_5]$ covalent molecule, there are three light up/down quarks. We assume the two exchanged quarks to be q_2 and q_3 with the same color. There are also two possible configurations:

	color	flavor	spin	orbital	total
$q_2 \leftrightarrow q_3$	S	A	S	S	A
$q_2 \leftrightarrow q_4$	A	S	S	S	A
$q_3 \leftrightarrow q_4$	A	S	S	S	A
$q_2 \leftrightarrow q_3$	S	S	A	S	A
$q_2 \leftrightarrow q_4$	A	S	S	S	A
$q_3 \leftrightarrow q_4$	A	S	S	S	A

They satisfy the condition that any two of the three light quarks are totally antisymmetric so that obey the Pauli principle. Hence, one quark and one antiquark can share (at most) three quarks, with either $(I)J^P = (\frac{1}{2})\frac{3}{2}^+$ or $(\frac{3}{2})\frac{1}{2}^+$. However, the $\bar{D}^{(*)}\Lambda_c$ system does not satisfy this condition.

3. In the $\Sigma_c^{(*)}[q_1 q_2 c_3] - \Sigma_b^{(*)}[q_4 q_5 c_6]$ covalent molecule, there are four light up/down quarks. We assume that q_1 and q_4 can be exchanged with the same color, and q_2 and q_5 can also be exchanged with the same color. There can be four possible configurations:

	color	flavor	spin	orbital	total
$q_1 \leftrightarrow q_4$	S	A	S	S	A
$q_2 \leftrightarrow q_5$	S	A	S	S	A
$q_1 \leftrightarrow q_2$	A	S	S	S	A
$q_1 \leftrightarrow q_5$	A	S	S	S	A
$q_2 \leftrightarrow q_4$	A	S	S	S	A
$q_4 \leftrightarrow q_5$	A	S	S	S	A
$q_1 \leftrightarrow q_4$	S	S	A	S	A
$q_2 \leftrightarrow q_5$	S	A	S	S	A
...					
$q_1 \leftrightarrow q_4$	S	A	S	S	A
$q_2 \leftrightarrow q_5$	S	S	A	S	A
...					
$q_1 \leftrightarrow q_4$	S	S	A	S	A
$q_2 \leftrightarrow q_5$	S	S	A	S	A
...					

They satisfy that any two of the four light quarks are totally antisymmetric so that obey the Pauli principle. Hence, two quarks can share (at most) four quarks, with $(I)J^P = (0)2^+/(1)1^+/(2)0^+$. However, neither $\Sigma_c^{(*)}\Lambda_b$ nor $\Lambda_b\Lambda_b$ satisfies this condition.

We apply the above model-independent hypothesis to qualitatively predict more covalent hadronic molecules:

- Induced by shared light up/down quarks, there can be the $I = 0$ $\bar{D}^{(*)}[\bar{c}q]-B^{(*)}[\bar{b}q]$, $I = 0$ $\bar{D}^{(*)}[\bar{c}q]-\Xi_c^{(*)}[csq]$, $I = 0$ $\Sigma_c^{(*)}[cq]-\Sigma_b^{(*)}[bqq]$, and $I = 1/2$ $\Sigma_c^{(*)}[cq]-\Xi_b^{(*)}[bsq]$ covalent molecules, etc. We roughly estimate their binding energies to be at the 10 MeV level, considering the P_c/P_{cs} and $X_0(2900)$ [66, 67] as possible covalent hadronic molecules. We list them in Table I, which are still waiting to be carefully analysed.
- If the strange quark is also exchangeable, there can be the $\bar{D}_s^{(*)}[\bar{c}s]-B^{(*)}[\bar{b}q]$ and $\bar{D}_s^{(*)}[\bar{c}s]-\Xi_c^{(*)}[csq]$ covalent molecules, etc. These states are induced by shared light up/down/strange quarks, with the $SU(3)$ light flavor structure to be antisymmetric.
- If the heavy-quark-exchange interaction is negligible, there might be the $I = 0$ $\bar{D}^{(*)}[\bar{c}q]-\bar{D}^{(*)}[\bar{c}q]$, $I = 0$ $\Sigma_c^{(*)}[cq]-\Sigma_c^{(*)}[cq]$, and $I = 1/2$ $\Sigma_c^{(*)}[cq]-\Xi_c^{(*)}[csq]$ covalent molecules, etc. These states are still induced by shared light up/down quarks.
- Especially, we propose to search for the $D^{*-}[\bar{c}d]-K^{*0}[\bar{s}d]$, $D^{*-}[\bar{c}d]-D^{*-}[\bar{c}d]$, and $D^{*-}[\bar{c}d]-B^{*0}[bd]$ covalent molecules of $I = 1$ and $J = 0$. These states might exist, when the two light quarks spin in opposite directions and the two antiquarks also spin in opposite directions, just like the para-hydrogen.

VI. A TOY MODEL TO FORMULIZE COVALENT HADRONIC MOLECULES

In the previous section we have qualitatively discussed the hypothesis: *the light-quark-exchange interaction is attractive when the shared light quarks are totally antisymmetric so that obey the Pauli principle*. In this section we further build a toy model to quantitatively formulize it, and estimate binding energies of some possibly-existing covalent hadronic molecules.

We shall use the following formula to estimate binding energies of the $\bar{D}^{(*)}\Sigma_c^{(*)}$, $D^{(*)}\bar{B}^{(*)}$, and $\Sigma_c^{(*)}\Sigma_b^{(*)}$ hadronic molecules:

$$B = N_A A - N_R R - N\epsilon - \kappa \langle \lambda_c \cdot \lambda_{\bar{c}/b} s_c \cdot s_{\bar{c}/b} \rangle. \quad (86)$$

This formula will be explained in Sec. VIA in details, and similar formulae are used for some other covalent hadronic molecules. There are altogether four parameters:

$$A \sim 30 \text{ MeV}, \quad (87)$$

$$R \sim 17 \text{ MeV}, \quad (88)$$

$$\epsilon \sim 6 \text{ MeV}, \quad (89)$$

$$\kappa \sim 13 \text{ MeV}, \quad (90)$$

which are estimated by considering the P_c/P_{cs} and the recently observed T_{cc}^+ as possible covalent hadronic molecules.

A. Parameters

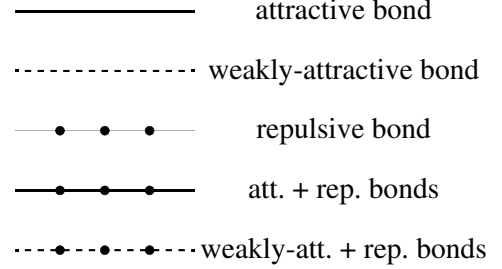

FIG. 10: (Weakly-)Attractive and repulsive covalent hadronic bonds as well as their combinations. In the present study we take into account the attractive bond and its combination with the repulsive bond, whose bond energies are estimated to be $A \sim 30$ MeV and $A - R \sim 13$ MeV, respectively.

As discussed in the previous section, there exists the attractive interaction when exchanging up and down quarks with the configuration:

	color	flavor	spin	orbital	total
$q \leftrightarrow q'$	S	A	S	S	A

These two light up/down quarks have the same color and their relative orbital structure is S -wave. Besides, they have the antisymmetric flavor structure and the symmetric spin structure, so with the quantum numbers $(I)J^P = (0)1^+$. We use the attractive bond energy A to describe this attraction, which is estimated to be $A \sim 30$ MeV for each bond, with N_A the number of such bonds. It is illustrated in Fig. 10 using the solid curve.

As discussed in the previous section, the two exchanged light up/down quarks can form another configuration of $(I)J^P = (1)0^+$:

	color	flavor	spin	orbital	total
$q \leftrightarrow q'$	S	S	A	S	A

However, its induced interaction is weaker, so we do not take this configuration into account in the present study. It is illustrated in Fig. 10 using the dashed curve.

There exists an $(I)J^P = (0)0^+$ up-down quark pair inside the proton/neutron with the configuration:

	color	flavor	spin	orbital	total
$q_1 \leftrightarrow q_2$	A	A	A	S	A

One can not exchange q_1 (nor q_2) with another light up/down quark q_3 , at the same time keeping: a) any

TABLE I: Possibly-existing covalent hadronic molecules $|(I)J^P\rangle$ induced by shared light up/down quarks, derived from the hypothesis that *the light-quark-exchange interaction is attractive when the shared light quarks are totally antisymmetric so that obey the Pauli principle*. Here, q and s denote the light up/down and strange quarks, respectively; Q and Q' denote two different heavy quarks; the symbols $[AB] = AB - BA$ and $\{AB\} = AB + BA$ denote the antisymmetric and symmetric $SU(3)$ light flavor structures, respectively. The states with \checkmark have been confirmed in QCD sum rule calculations of the present study, but the states with $?$ and $??$ have not. This is because the latter contain relatively-polarized components, while one needs to sum over polarizations of these components within QCD sum rule method and so can not differentiate these hyperfine structures. Moreover, the states with $??$ contain light up/down quarks with the symmetric flavor/isospin structure, whose masses are (probably) considerably larger than their partners with the antisymmetric flavor/isospin structure. The states without any identification are still waiting to be carefully analysed in our future QCD sum rule studies.

	$ \bar{Q}q, \frac{1}{2}0^-\rangle$	$ \bar{Q}q, \frac{1}{2}1^-\rangle$	$ Q[qq], 0\frac{1}{2}^+\rangle$	$ Q\{qq\}, 1\frac{1}{2}^+\rangle$	$ Q\{qq\}, 1\frac{3}{2}^+\rangle$	$ Q[sq], \frac{1}{2}\frac{1}{2}^+\rangle$	$ Q\{sq\}, \frac{1}{2}\frac{1}{2}^+\rangle$	$ Q\{sq\}, \frac{1}{2}\frac{3}{2}^+\rangle$
$ \bar{Q}'q, \frac{1}{2}0^-\rangle$	$ (0)0^+\rangle$	$ (0)1^+\rangle$ (\checkmark)	–	$ (\frac{1}{2})\frac{1}{2}^-\rangle$ (\checkmark)	$ (\frac{1}{2})\frac{3}{2}^-\rangle$ (\checkmark)	$ (0)\frac{1}{2}^-\rangle$	$ (0)\frac{1}{2}^-\rangle$	$ (0)\frac{3}{2}^-\rangle$
$ \bar{Q}'q, \frac{1}{2}1^-\rangle$		$ (0)0^+\rangle$ (?) $ (1)0^+\rangle$ (??) $ (0)1^+\rangle$ (?) $ (1)1^+\rangle$ (??) $ (0)2^+\rangle$ (\checkmark)	–	$ (\frac{1}{2})\frac{1}{2}^-\rangle$ (?) $ (\frac{3}{2})\frac{1}{2}^-\rangle$ (??) $ (\frac{1}{2})\frac{3}{2}^-\rangle$ (\checkmark) $ (\frac{3}{2})\frac{3}{2}^-\rangle$ (??)	$ (\frac{1}{2})\frac{1}{2}^-\rangle$ (?) $ (\frac{3}{2})\frac{1}{2}^-\rangle$ (??) $ (\frac{1}{2})\frac{3}{2}^-\rangle$ (?) $ (\frac{3}{2})\frac{3}{2}^-\rangle$ (??) $ (\frac{1}{2})\frac{5}{2}^-\rangle$ (\checkmark)	$ (0)\frac{1}{2}^-\rangle$ $ (0)\frac{3}{2}^-\rangle$	$ (0)\frac{1}{2}^-\rangle$ $ (1)\frac{1}{2}^-\rangle$ $ (0)\frac{3}{2}^-\rangle$ $ (1)\frac{3}{2}^-\rangle$	$ (0)\frac{1}{2}^-\rangle$ $ (1)\frac{1}{2}^-\rangle$ $ (0)\frac{3}{2}^-\rangle$ $ (1)\frac{3}{2}^-\rangle$ $ (0)\frac{5}{2}^-\rangle$
$ Q[qq], 0\frac{1}{2}^+\rangle$			–	–	–	–	–	–
$ Q\{qq\}, 1\frac{1}{2}^+\rangle$				$ (0)1^+\rangle$ $ (1)0/1^+\rangle$ $ (2)0/1^+\rangle$	$ (0)1/2^+\rangle$ $ (1)1/2^+\rangle$ $ (2)1^+\rangle$	$ (\frac{1}{2})0/1^+\rangle$	$ (\frac{1}{2})0/1^+\rangle$ $ (\frac{3}{2})0/1^+\rangle$	$ (\frac{1}{2})1/2^+\rangle$ $ (\frac{3}{2})1/2^+\rangle$
$ Q\{qq\}, 1\frac{3}{2}^+\rangle$					$ (0)1/2/3^+\rangle$ $ (1)0/1/2^+\rangle$ $ (2)0/1^+\rangle$	$ (\frac{1}{2})1/2^+\rangle$	$ (\frac{1}{2})1/2^+\rangle$ $ (\frac{3}{2})1/2^+\rangle$	$ (\frac{1}{2})0/1/2/3^+\rangle$ $ (\frac{3}{2})0/1/2^+\rangle$

two of the three light quarks are totally antisymmetric, and b) the proton/neutron remains unchanged. As an example, we exchange $q_1 \leftrightarrow q_3$ and keep (b), but then (a) is not satisfied:

	color	flavor	spin	orbital	total
$q_1 \leftrightarrow q_2$	A	A	A	S	A
$q_2 \leftrightarrow q_3$	A	A	A	S	A
$q_1 \leftrightarrow q_3$	S	S	S	S	S

Therefore, the above up-down quark pair is in some sense “saturated”. This suggests that the $(I)J^P = (0)0^+$ up-down quark pairs inside protons/neutrons can not be exchanged, so they are capable of forming repulsive cores in the nucleus.

We use the repulsive bond energy R to describe the repulsion between two repulsive cores, which is estimated to be $R \sim 17$ MeV for each bond, with N_R the number of

such bonds. It is illustrated in Fig. 10 using the dotted curve. Besides, we shall find in Sec. VIC and Sec. VID that the two charm quarks can also form such repulsive cores in $D^{(*)}D^{(*)}$ and $\Sigma_c^{(*)}\Sigma_c^{(*)}$ hadronic molecules, etc.

The third parameter is the residual energy ϵ , which is estimated to be $\epsilon \sim 6$ MeV for each component hadron, with N the number of components. We use it to describe the part of kinetic energy that can not be absorbed into A and R .

The fourth parameter κ relates to the spin splitting. We use the following term to describe the interaction between the c and \bar{c} quarks when investigating $\bar{D}^{(*)}\Sigma_c^{(*)}$ hadronic molecules:

$$\mathcal{H}_{spin} = -\kappa \langle \lambda_c \cdot \lambda_{\bar{c}} s_c \cdot s_{\bar{c}} \rangle, \quad (91)$$

where κ is estimated to be $\kappa \sim 13$ MeV; s_c and $s_{\bar{c}}$ are spins of the c and \bar{c} quarks; λ_c and $\lambda_{\bar{c}}$ are their color charges. We use a similar term to describe the interaction

between the c and b quarks when investigating $D^{(*)}\bar{B}^{(*)}$ and $\Sigma_c^{(*)}\Sigma_b^{(*)}$ hadronic molecules:

$$\mathcal{H}'_{spin} = -\kappa \langle \lambda_c \cdot \lambda_b s_c \cdot s_b \rangle. \quad (92)$$

However, we do not include such terms when investigating $D^{(*)}D^{(*)}$ and $\Sigma_c^{(*)}\Sigma_c^{(*)}$ hadronic molecules, since the interaction between two charm quarks has been (partly) taken into account in the repulsive bond energy R . Note that the spin splitting effect in hadronic molecules still needs to be updated with future experiments, since we do not well understand it at this moment. See Sec. **VIG** for more discussions.

B. Nucleus

Taking the proton/neutron as the combination of an $(I)J^P = (0)0^+$ up-down quark pair together with another up/down quark, we can estimate binding energies of the ${}^2\text{H}$, ${}^3\text{H}$, ${}^3\text{He}$, and ${}^4\text{He}$, as illustrated in Fig. **11**. In the present study we do not investigate other nuclei consisting of more nucleons, because there are at most two up and two down quarks in the lowest orbit. See Sec. **VIF** for relevant studies on the hypernucleus.

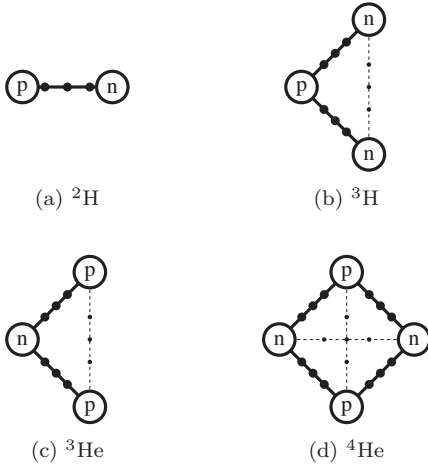

FIG. 11: Illustration of the ${}^2\text{H}$, ${}^3\text{H}$, ${}^3\text{He}$, and ${}^4\text{He}$ in our model. The shape of ${}^4\text{He}$ is a tetrahedron other than a square.

The ${}^2\text{H}$ contains two shared light up/down quarks with the configuration of $(I)J^P = (0)1^+$:

	color	flavor	spin	orbital	total
$q_1 \leftrightarrow q_2$	S	A	S	S	A

We estimate its binding energy to be

$$B_{I=0, J=1}^{2\text{H}} = A - R - 2\epsilon \sim 1 \text{ MeV}. \quad (93)$$

The ${}^3\text{H}$ and ${}^3\text{He}$ both contain three shared light up/down quarks with the configuration of $(I)J^P =$

$(1/2)1/2^+$:

	color	flavor	spin	orbital	total
$q_1 \leftrightarrow q_2$	S	A	S	S	A
$q_1 \leftrightarrow q_3$	S	A	S	S	A
$q_2 \leftrightarrow q_3$	S	S	A	S	A

We estimate their binding energies to be

$$B_{I=1/2, J=1/2}^{3\text{H}/3\text{He}} = 2A - 2R - 3\epsilon \sim 8 \text{ MeV}. \quad (94)$$

The ${}^4\text{He}$ contains four shared light up/down quarks with the configuration of $(I)J^P = (0)0^+$:

	color	flavor	spin	orbital	total
$q_1 \leftrightarrow q_2$	S	S	A	S	A
$q_1 \leftrightarrow q_3$	S	A	S	S	A
$q_1 \leftrightarrow q_4$	S	A	S	S	A
$q_2 \leftrightarrow q_3$	S	A	S	S	A
$q_2 \leftrightarrow q_4$	S	A	S	S	A
$q_3 \leftrightarrow q_4$	S	S	A	S	A

We estimate its binding energy to be

$$B_{I=0, J=0}^{4\text{He}} = 4A - 4R - 4\epsilon \sim 28 \text{ MeV}. \quad (95)$$

C. $D^{(*)}D^{(*)}/D^{(*)}\bar{B}^{(*)}/\bar{B}^{(*)}\bar{B}^{(*)}$ molecules

The $(I)J^P = (0)0^+$ DD hadronic molecule does not exist due to the Bose-Einstein statistics. So do the D^*D^* molecules of $(I)J^P = (0)0^+$ and $(I)J^P = (0)2^+$. Actually, we can construct their corresponding currents, and explicitly prove them to be zero.

Similar to Sec. **II**, we investigate the $(I)J^P = (0)1^+$ DD^* hadronic molecule through its corresponding current:

$$\begin{aligned} \sqrt{2}J_\alpha^{DD^*} &= J_\alpha^{D^+D^{*0}} - J_\alpha^{D^0D^{*+}} \\ &= J^{D^+} \times J_\alpha^{D^{*0}} - J^{D^0} \times J_\alpha^{D^{*+}} \\ &= \bar{d}_a \gamma_5 c_a \bar{u}_b \gamma_\alpha c_b - \bar{u}_a \gamma_5 c_a \bar{d}_b \gamma_\alpha c_b. \end{aligned} \quad (96)$$

Its correlation function

$$\Pi_{\alpha\beta}^{DD^*}(x) = \langle 0 | \mathbb{T} \left[J_\alpha^{DD^*}(x) J_\beta^{DD^* \dagger}(0) \right] | 0 \rangle, \quad (97)$$

can be separated into (omitting the subscripts $\alpha\beta$ for simplicity):

$$\begin{aligned} \Pi^{DD^*}(x) &= \Pi_0^{DD^*}(x) + \Pi_G^{DD^*}(x) + \Pi_Q^{DD^*}(x) \\ &= \Pi_0^{DD^*}(x) + \Pi_G^{DD^*}(x) \\ &\quad + \Pi_q^{DD^*}(x) + \Pi_c^{DD^*}(x) + \Pi_{qc}^{DD^*}(x), \end{aligned} \quad (98)$$

where

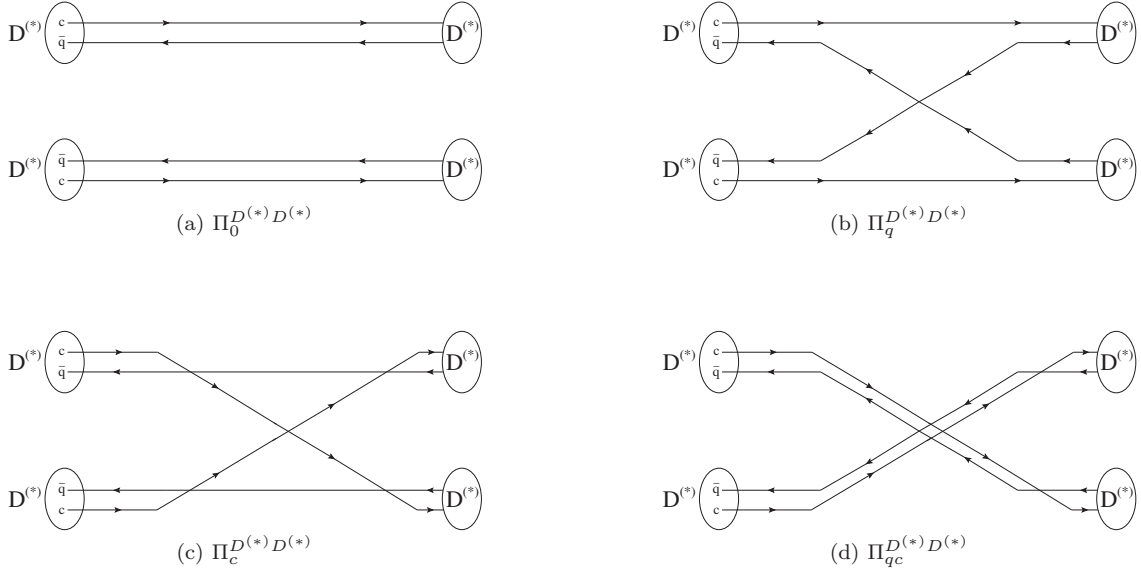

FIG. 12: Feynman diagrams between two charmed mesons corresponding to : a) the leading term $\Pi_0^{D^{(*)}D^{(*)}}(x) = \Pi^{D^{(*)}}(x) \times \Pi^{D^{(*)}}(x)$ contributed by two non-correlated charmed mesons, b) the light-quark-exchange interaction $\Pi_q^{D^{(*)}D^{(*)}}$, c) the heavy-quark-exchange interaction $\Pi_c^{D^{(*)}D^{(*)}}$, and d) the interaction $\Pi_{qc}^{D^{(*)}D^{(*)}}$ exchanging both light and heavy quarks. Here q denotes a light up/down quark.

$$\Pi_0^{DD^*}(x) = \Pi^D(x) \times \Pi^{D^*}(x) \quad (99)$$

$$= -\text{Tr} \left[\mathbf{iS}_q^{a'a}(-x)\gamma_5 \mathbf{iS}_c^{aa'}(x)\gamma_5 \right] \text{Tr} \left[\mathbf{iS}_q^{b'b}(-x)\gamma_\alpha \mathbf{iS}_c^{bb'}(x)\gamma_\beta \right],$$

$$\Pi_q^{DD^*}(x) = -\text{Tr} \left[\mathbf{iS}_q^{b'a}(-x)\gamma_5 \mathbf{iS}_c^{aa'}(x)\gamma_5 \mathbf{iS}_q^{a'b}(-x)\gamma_\alpha \mathbf{iS}_c^{bb'}(x)\gamma_\beta \right], \quad (100)$$

$$\Pi_c^{DD^*}(x) = +\text{Tr} \left[\mathbf{iS}_q^{a'a}(-x)\gamma_5 \mathbf{iS}_c^{ab'}(x)\gamma_\beta \mathbf{iS}_q^{b'b}(-x)\gamma_\alpha \mathbf{iS}_c^{ba'}(x)\gamma_5 \right], \quad (101)$$

$$\Pi_{qc}^{DD^*}(x) = +\text{Tr} \left[\mathbf{iS}_q^{b'a}(-x)\gamma_5 \mathbf{iS}_c^{ab'}(x)\gamma_\beta \right] \text{Tr} \left[\mathbf{iS}_q^{a'b}(-x)\gamma_\alpha \mathbf{iS}_c^{ba'}(x)\gamma_5 \right]. \quad (102)$$

Their corresponding Feynman diagrams (without condensates) are depicted in Fig. 12. We calculate them using QCD sum rules and find:

- The term $\Pi_{qc}^{DD^*}(x)$ exchanging both light and heavy quarks simply vanishes, *i.e.*, $\Pi_{qc}^{DD^*}(x) = 0$.
- The term $\Pi_q^{DD^*}(x)$ exchanging light quarks is positive, so its induced interaction is attractive.
- The term $\Pi_c^{DD^*}(x)$ exchanging heavy charm quarks is negative, so its induced interaction is repulsive.
- The terms $\Pi_c^{DD^*}(x)$ and $\Pi_q^{DD^*}(x)$ are almost opposite, *i.e.*, $\Pi_c^{DD^*}(x) \approx -\Pi_q^{DD^*}(x)$.

Therefore, our QCD sum rule results suggest that the two charm quarks in $D^{(*)}D^{(*)}$ hadronic molecules are

capable of forming repulsive cores. Accordingly, we can estimate binding energies of $D^{(*)}D^{(*)}/\bar{B}^{(*)}\bar{B}^{(*)}$ hadronic molecules, as illustrated in Fig. 13(a).

The $(I)J^P = (0)1^+ DD^*$ hadronic molecule contains two shared light antiquarks with the configuration of $(I)J^P = (0)1^+$:

	color	flavor	spin	orbital	total
$\bar{q}_1 \leftrightarrow \bar{q}_2$	S	A	S	S	A

We estimate its binding energy to be

$$B_{I=0,J=1}^{DD^*} = A - R - 2\epsilon \sim 1 \text{ MeV}, \quad (103)$$

suggesting it possible to interpret the recently observed T_{cc}^+ [44, 45] as the $(I)J^P = (0)1^+ DD^*$ covalent hadronic molecule.

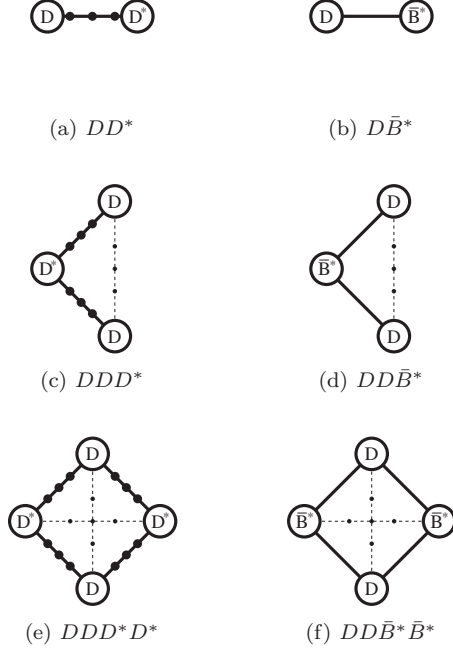

FIG. 13: Illustration of the hadronic molecules DD^* and $D\bar{B}^*$ of $(I)J^P = (0)1^+$, DDD^* and $DD\bar{B}^*$ of $(I)J^P = (1/2)1^+$, and DDD^*D^* and $DD\bar{B}^*B^*$ of $(I)J^P = (0)0^+/(0)2^+$ in our model.

The $(I)J^P = (0)1^+$ $D^*D^*/\bar{B}\bar{B}^*/\bar{B}^*B^*$ hadronic molecules have similar binding energies:

$$B_{I=0, J=1}^{D^*D^*/\bar{B}\bar{B}^*/\bar{B}^*B^*} = A - R - 2\epsilon \sim 1 \text{ MeV}. \quad (104)$$

However, in the above estimations we have not considered the spin splitting effect, and we have also not considered the long-range light-meson-exchange interaction. These uncertainties prevent us to well determine whether these hadronic molecules exist or not.

Different from $D^{(*)}D^{(*)}$ and $\bar{B}^{(*)}\bar{B}^{(*)}$ molecules, the charm and bottom quarks in $D^{(*)}\bar{B}^{(*)}$ hadronic molecules can not be exchanged, so they are not capable of forming repulsive cores, *i.e.*, there does not exist the Feynman diagram corresponding to Fig. 12(c). In this case we include the spin splitting effect described by the parameter κ , and estimate binding energies of $D^{(*)}\bar{B}^{(*)}$ hadronic molecules to be

$$\begin{aligned} B_{I=0, J=0}^{D\bar{B}} &= A - 2\epsilon - 1.33\kappa \sim 1 \text{ MeV}, \\ B_{I=0, J=1}^{D\bar{B}^*/D^*\bar{B}} &= A - 2\epsilon + 0.44\kappa \sim 24 \text{ MeV}, \\ B_{I=0, J=0}^{D^*\bar{B}^*} &= A - 2\epsilon - 1.33\kappa \sim 1 \text{ MeV}, \\ B_{I=0, J=1}^{D^*\bar{B}^*} &= A - 2\epsilon + 4\kappa \sim 70 \text{ MeV}, \\ B_{I=0, J=2}^{D^*\bar{B}^*} &= A - 2\epsilon - 1.33\kappa \sim 1 \text{ MeV}. \end{aligned} \quad (105)$$

Especially, binding energies of the $(I)J^P = (0)1^+$ $D\bar{B}^*/D^*\bar{B}$ covalent hadronic molecules are much larger than those of the $(I)J^P = (0)1^+$ $DD^*/\bar{B}\bar{B}^*$ molecules.

In the above estimations we have assumed that the charm and bottom quarks form the symmetric color representation $\mathbf{6}_c$, so that

$$\langle \lambda_c \cdot \lambda_b \rangle = \frac{16}{3}. \quad (106)$$

Besides, we need to perform the spin decomposition from the $|s_{c\bar{q}}, s_{b\bar{q}'}; J\rangle$ basis to the $|s_{cb}, s_{\bar{q}\bar{q}'}; J\rangle$ basis (see Appendix B), and select the components satisfying $s_{\bar{q}\bar{q}'} = 1$ to evaluate $\langle s_c \cdot s_b \rangle$. Take the $(I)J^P = (0)1^+$ $D\bar{B}^*$ molecule as an example, we obtain

$$\begin{aligned} &\langle 0_{c\bar{q}}, 1_{b\bar{q}'}; 1 | s_c \cdot s_b | 0_{c\bar{q}}, 1_{b\bar{q}'}; 1 \rangle \\ &\rightarrow \frac{4}{3} \times \left(\frac{1}{4} \langle 0_{cb}, 1_{\bar{q}\bar{q}'}; 1 | s_c \cdot s_b | 0_{cb}, 1_{\bar{q}\bar{q}'}; 1 \rangle \right. \\ &\quad \left. + \frac{1}{2} \langle 1_{cb}, 1_{\bar{q}\bar{q}'}; 1 | s_c \cdot s_b | 1_{cb}, 1_{\bar{q}\bar{q}'}; 1 \rangle \right) \\ &= -0.0833. \end{aligned} \quad (107)$$

We further use $D^{(*)}$ to compose multi- $D^{(*)}$ hadronic molecules, such as the DDD^* and DDD^*D^* molecules, etc. As illustrated in Fig. 13(c,e), their structures are similar to the ${}^3\text{He}$ and ${}^4\text{He}$, respectively. We estimate their binding energies to be:

$$\begin{aligned} B_{I=1/2, J=1}^{DDD^*} &= 2A - 2R - 3\epsilon \sim 8 \text{ MeV}, \\ B_{I=0, J=0,2}^{DDD^*D^*} &= 4A - 4R - 4\epsilon \sim 28 \text{ MeV}. \end{aligned} \quad (108)$$

Besides, our model supports the existence of the $DD\bar{B}^*$ and $DD\bar{B}^*B^*$ hadronic molecules, etc. As illustrated in Fig. 13(d,f), they have much larger binding energies:

$$\begin{aligned} B_{I=1/2, J=1}^{DD\bar{B}^*} &= 2A - 3\epsilon + 0.89\kappa \sim 54 \text{ MeV}, \\ B_{I=0, J=0,2}^{DD\bar{B}^*B^*} &= 4A - 4\epsilon + 1.78\kappa \sim 119 \text{ MeV}. \end{aligned} \quad (109)$$

More examples can be found in Table II.

D. $\Sigma_c^{(*)}\Sigma_c^{(*)}/\Sigma_c^{(*)}\Sigma_b^{(*)}/\Sigma_b^{(*)}\Sigma_b^{(*)}$ molecules

We follow Sec. VIC and find that the two charm quarks in $\Sigma_c^{(*)}\Sigma_c^{(*)}$ hadronic molecules also form repulsive cores. Accordingly, we can estimate binding energies of $\Sigma_c^{(*)}\Sigma_c^{(*)}/\Sigma_b^{(*)}\Sigma_b^{(*)}$ hadronic molecules, as illustrated in Fig. 14(a).

The $(I)J^P = (0)1^+$ $\Sigma_c[q_1q_2c]\Sigma_c[q_3q_4c]$ hadronic molecule contains four shared light up/down quarks with

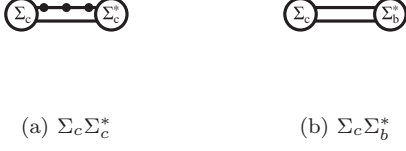

FIG. 14: Illustration of the hadronic molecules $\Sigma_c \Sigma_c^*$ and $\Sigma_c \Sigma_b^*$ of $(I)J^P = (0)1^+/(0)2^+$ in our model.

the configuration of $(I)J^P = (0)2^+$:

	color	flavor	spin	orbital	total
$q_1 \leftrightarrow q_3$	S	A	S	S	A
$q_2 \leftrightarrow q_4$	S	A	S	S	A
$q_1 \leftrightarrow q_2$	A	S	S	S	A
$q_1 \leftrightarrow q_4$	A	S	S	S	A
$q_2 \leftrightarrow q_3$	A	S	S	S	A
$q_3 \leftrightarrow q_4$	A	S	S	S	A

We estimate its binding energy to be

$$B_{I=0, J=1}^{\Sigma_c \Sigma_c} = 2A - R - 2\epsilon \sim 31 \text{ MeV}. \quad (110)$$

The $I = 0$ $\Sigma_c \Sigma_c^*/\Sigma_c^* \Sigma_c^*$ hadronic molecules have similar binding energies:

$$B_{I=0}^{\Sigma_c \Sigma_c^*/\Sigma_c^* \Sigma_c^*} = 2A - R - 2\epsilon \sim 31 \text{ MeV}. \quad (111)$$

So do their corresponding $\Sigma_b^{(*)} \Sigma_b^{(*)}$ hadronic molecules. However, the $(I)J^P = (0)0^+$ $\Sigma_c \Sigma_c/\Sigma_c^* \Sigma_c^*$ and $\Sigma_b \Sigma_b/\Sigma_b^* \Sigma_b^*$ hadronic molecules do not exist due to the Fermi-Dirac statistics.

Different from $\Sigma_c^{(*)} \Sigma_c^{(*)}$ and $\Sigma_b^{(*)} \Sigma_b^{(*)}$ molecules, the charm and bottom quarks in $\Sigma_c^{(*)} \Sigma_b^{(*)}$ hadronic molecules can not be exchanged, so they are not capable of forming repulsive cores. In this case we include the spin splitting effect described by the parameter κ , and estimate binding energies of $\Sigma_c^{(*)} \Sigma_b^{(*)}$ hadronic molecules to be

$$\begin{aligned} B_{I=0, J=1}^{\Sigma_c \Sigma_b} &= 2A - 2\epsilon - 1.33\kappa \sim 31 \text{ MeV}, \\ B_{I=0, J=1}^{\Sigma_c \Sigma_b^*/\Sigma_c^* \Sigma_b} &= 2A - 2\epsilon - 1.33\kappa \sim 31 \text{ MeV}, \\ B_{I=0, J=2}^{\Sigma_c \Sigma_b^*/\Sigma_c^* \Sigma_b} &= 2A - 2\epsilon + 0.8\kappa \sim 58 \text{ MeV}, \\ B_{I=0, J=1}^{\Sigma_c^* \Sigma_b^*} &= 2A - 2\epsilon - 1.33\kappa \sim 31 \text{ MeV}, \\ B_{I=0, J=2}^{\Sigma_c^* \Sigma_b^*} &= 2A - 2\epsilon + 4\kappa \sim 100 \text{ MeV}, \\ B_{I=0, J=3}^{\Sigma_c^* \Sigma_b^*} &= 2A - 2\epsilon - 1.33\kappa \sim 31 \text{ MeV}. \end{aligned} \quad (112)$$

E. $\bar{D}^{(*)} \Sigma_c^{(*)}/\bar{D}^{(*)} \Sigma_b^{(*)}/B^{(*)} \Sigma_c^{(*)}/B^{(*)} \Sigma_b^{(*)}$ molecules

The charm and anti-charm quarks in $\bar{D}^{(*)} \Sigma_c^{(*)}$ hadronic molecules can not be exchanged, so they are not capable of forming repulsive cores. Accordingly, we include the spin splitting effect described by the parameter κ , and estimate their binding energies to be

$$\begin{aligned} B_{I=1/2, J=1/2}^{\bar{D} \Sigma_c} &= A - 2\epsilon - 0.67\kappa \sim 9 \text{ MeV}, \\ B_{I=1/2, J=3/2}^{\bar{D} \Sigma_c^*} &= A - 2\epsilon + 0.33\kappa \sim 22 \text{ MeV}, \\ B_{I=1/2, J=1/2}^{\bar{D}^* \Sigma_c} &= A - 2\epsilon - 0.67\kappa \sim 9 \text{ MeV}, \\ B_{I=1/2, J=3/2}^{\bar{D}^* \Sigma_c} &= A - 2\epsilon + 0.33\kappa \sim 22 \text{ MeV}, \\ B_{I=1/2, J=1/2}^{\bar{D}^* \Sigma_c^*} &= A - 2\epsilon - 0.67\kappa \sim 9 \text{ MeV}, \\ B_{I=1/2, J=3/2}^{\bar{D}^* \Sigma_c^*} &= A - 2\epsilon + 1.83\kappa \sim 42 \text{ MeV}, \\ B_{I=1/2, J=5/2}^{\bar{D}^* \Sigma_c^*} &= A - 2\epsilon - 0.67\kappa \sim 9 \text{ MeV}. \end{aligned} \quad (113)$$

Similarly, we can estimate binding energies of $\bar{D}^{(*)} \Sigma_b^{(*)}/B^{(*)} \Sigma_c^{(*)}/B^{(*)} \Sigma_b^{(*)}$ hadronic molecules, which are the same as their corresponding $\bar{D}^{(*)} \Sigma_c^{(*)}$ ones.

These hadronic molecules all contain three shared light up/down quarks with the configuration of $(I)J^P = (1/2)3/2^+$:

	color	flavor	spin	orbital	total
$q_1 \leftrightarrow q_2$	S	A	S	S	A
$q_1 \leftrightarrow q_3$	A	S	S	S	A
$q_2 \leftrightarrow q_3$	A	S	S	S	A

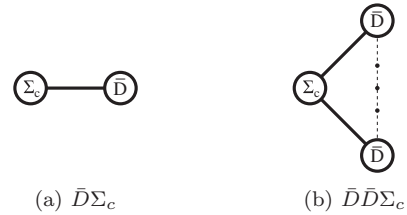

FIG. 15: Illustration of the hadronic molecules $\bar{D} \Sigma_c$ of $(I)J^P = (1/2)1/2^-$ and $\bar{D} \bar{D} \Sigma_c$ of $(I)J^P = (0)1/2^+$ in our model.

We further use two charmed mesons and one $\Sigma_c^{(*)}$ baryon to compose $\bar{D}^{(*)} \bar{D}^{(*)} \Sigma_c^{(*)}$ hadronic molecules. Especially, the $\bar{D}[\bar{c}q_1] \bar{D}[\bar{c}'q_2] \Sigma_c[q_3q_4c]$ illustrated in Fig. 15(b) contains four shared light up/down quarks

with the configuration of $(I)J^P = (0)2^+$:

	color	flavor	spin	orbital	total
$q_1 \leftrightarrow q_3$	S	A	S	S	A
$q_2 \leftrightarrow q_4$	S	A	S	S	A
$q_1 \leftrightarrow q_2$	A	S	S	S	A
$q_1 \leftrightarrow q_4$	A	S	S	S	A
$q_2 \leftrightarrow q_3$	A	S	S	S	A
$q_2 \leftrightarrow q_4$	A	S	S	S	A

We estimate its binding energy to be:

$$B_{I=0, J=1/2}^{\bar{D}\bar{D}\Sigma_c} = 2A - 3\epsilon - 1.33\kappa \sim 25 \text{ MeV}. \quad (114)$$

More examples can be found in Table II.

F. Molecules with strangeness

In the previous subsections we only consider the up and down quarks as exchanged light quarks, and in this subsection we further take the light strange quark into account. We introduce another parameter S to describe the attractive interaction induced by the shared strange and up/down quarks with the configuration of either $(I)J^P = (1/2)0^+$ or $(1/2)1^+$:

	color	flavor	spin	orbital	total
$s \leftrightarrow q$	S	S	A	S	A
$s \leftrightarrow q$	S	A	S	S	A

This parameter is estimated to be $S \sim 20$ MeV for each bond, with N_S the number of such bonds. We still use the solid curve to illustrate it, but this solid curve is slightly thinner than that denoting the attractive bond A .

Taking the Λ hyperon as the combination of an $(I)J^P = (0)0^+$ up-down quark pair together with a strange quark, we can estimate binding energies of some hypernuclei. Considering that there are at most two up, two down, and two strange quarks in the lowest orbit, we obtain:

$$\begin{aligned} B_{I=0}^{3\Lambda\text{H}} &= A + 2S - 3R - 3\epsilon \sim 1 \text{ MeV}, \\ B_{I=1/2}^{4\Lambda\text{H}/4\Lambda\text{He}} &= 2A + 3S - 5R - 4\epsilon \sim 11 \text{ MeV}, \quad (115) \\ B_{I=0}^{5\Lambda\text{He}} &= 4A + 3S - 7R - 5\epsilon \sim 31 \text{ MeV}, \\ B_{I=0}^{6\Lambda\Lambda\text{He}} &= 4A + 6S - 10R - 6\epsilon \sim 34 \text{ MeV}. \end{aligned}$$

We illustrate these hypernuclei in Fig. 16. More possibly-existing covalent hadronic molecules with strangeness can be found in Table II.

G. Discussions on the spin splitting effect

In the present study we investigate the spin splitting effect through Eqs. (91) and (92) with the same parameter

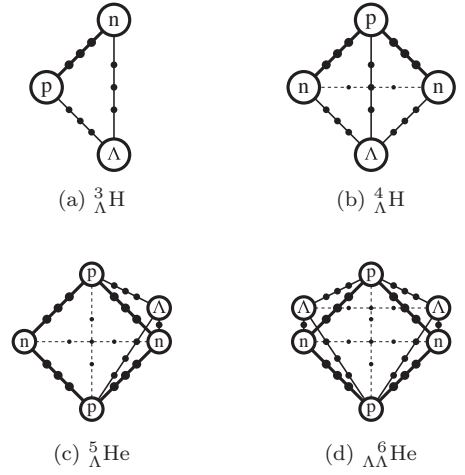

FIG. 16: Illustration of the ${}^3_{\Lambda}\text{H}$, ${}^4_{\Lambda}\text{H}$, ${}^5_{\Lambda}\text{He}$, and ${}^6_{\Lambda\Lambda}\text{He}$ in our model. The shape of $ppnn$ in the subfigures (c) and (d) is a tetrahedron other than a square.

$\kappa \sim 13$ MeV. These two equations are used for $\bar{D}^{(*)}\Sigma_c^{(*)}$ and $D^{(*)}\bar{B}^{(*)}/\Sigma_c^{(*)}\Sigma_b^{(*)}$ hadronic molecules, respectively; while we do not include such terms when investigating $D^{(*)}D^{(*)}/\Sigma_c^{(*)}\Sigma_c^{(*)}$ hadronic molecules, since the interaction between two charm quarks has been (partly) taken into account in the repulsive bond energy R .

Because we do not well understand the spin splitting effect in hadronic molecules at this moment, we still need to update it with future experiments, and there can be other approaches better describing it. We take $\bar{D}^{(*)}\Sigma_c^{(*)}$ hadronic molecules as an example, and discuss several possible improvements.

Firstly, it is possible to use two different κ 's for Eqs. (91) and (92). It is also possible to use some formulae other than Eqs. (91) and (92), such as the spin-spin interaction,

$$\mathcal{H}''_{spin} = -\kappa' \langle s_{\bar{D}^{(*)}} \cdot s_{\Sigma_c^{(*)}} \rangle, \quad (116)$$

or the spin-orbit interaction, etc.

Secondly, in the present study we perform the spin decomposition from the $|s_{\bar{c}q_1}, s_{q_2q_3c}; J\rangle_{s_{q_2q_3}=1}$ basis to the $|s_{\bar{c}c}, s_{q_1q_2q_3}; J\rangle_{s_{q_2q_3}=1}$ basis, and select the components satisfying $s_{q_1q_2q_3} = 3/2$ to evaluate $\langle s_c \cdot s_{\bar{c}} \rangle$. This is because the three light up/down quarks of $(I)J^P = (1/2)3/2^+$ are assumed to supply the attraction forming $\bar{D}^{(*)}\Sigma_c^{(*)}$ hadronic molecules in our model, while the two heavy quarks c/\bar{c} are assumed to be freely polarised. If this is not the case and c/\bar{c} are also fully polarised, there might be two $\bar{D}\Sigma_c^*$ hadronic molecules with either $s_{\bar{c}c} = 0$

or $s_{\bar{c}c} = 1$ (see Appendix B):

$$|s_{\bar{c}q_1}, s_{q_2q_3c}; J\rangle_{s_{q_2q_3}=1} \rightarrow |s_{\bar{c}c}, s_{q_1q_2q_3}; J\rangle_{s_{q_2q_3}=1},$$

$$|0, \frac{3}{2}; \frac{3}{2}\rangle \rightarrow |0, \frac{3}{2}; \frac{3}{2}\rangle, \quad (117)$$

$$|0, \frac{3}{2}; \frac{3}{2}\rangle \rightarrow |1, \frac{3}{2}; \frac{3}{2}\rangle. \quad (118)$$

It can be seen from the recent LHCb experiment [6] that there might be two peaks near the $\bar{D}\Sigma_c^*$ threshold, and we propose to further study them as well as the $P_c(4440)^+$ and $P_c(4457)^+$ in order to better understand the spin splitting effect of hadronic molecules in future experiments.

To end this section, we further simplify our toy model by neglecting the spin splitting effect described by the parameter $\kappa \sim 13$ MeV, and estimate binding energies of some possibly-existing covalent hadronic molecules through the simplified formula,

$$B = N_{AA} + N_{SS} - N_{RR} - N_{\epsilon}, \quad (119)$$

which still have four parameters $A \sim 30$ MeV, $S \sim 20$ MeV, $R \sim 17$ MeV, and $\epsilon \sim 6$ MeV. The obtained results are summarized in Table II,

Very quickly, we arrive at the unique feature of our covalent hadronic molecule picture: binding energies of the $(I)J^P = (0)1^+ D\bar{B}^*/D^*\bar{B}$ hadronic molecules are much larger than those of the $(I)J^P = (0)1^+ DD^*/\bar{B}\bar{B}^*$ ones, while the $(I)J^P = (1/2)1/2^+ \bar{D}\Sigma_c/\bar{D}\Sigma_b/B\Sigma_c/B\Sigma_b$ hadronic molecules have similar binding energies. This is due to that the two identical heavy quarks in $DD^*/\bar{B}\bar{B}^*$ hadronic molecules form repulsive cores, but the two different heavy quarks in $D\bar{B}^*/D^*\bar{B}$ and $\bar{D}\Sigma_c/\bar{D}\Sigma_b/B\Sigma_c/B\Sigma_b$ hadronic molecules do not.

VII. SUMMARY AND DISCUSSIONS

In this paper we systematically examine Feynman diagrams corresponding to the $\bar{D}^{(*)}\Sigma_c^{(*)}$, $\bar{D}^{(*)}\Lambda_c$, $D^{(*)}\bar{K}^*$, and $D^{(*)}\bar{D}^{(*)}$ hadronic molecular states. Take the $\bar{D}\Sigma_c$ molecule as an example, first we calculate correlation functions of \bar{D} and Σ_c in the coordinate space to be $\Pi^{\bar{D}}(x)$ and $\Pi^{\Sigma_c}(x)$, respectively. Then we calculate correlation functions of the $D^-\Sigma_c^{++}$, $\bar{D}^0\Sigma_c^+$, $I = 1/2 \bar{D}\Sigma_c$, and $I = 3/2 \bar{D}\Sigma_c$ molecules, separated into:

$$\begin{aligned} \Pi^{D^-\Sigma_c^{++}}(x) &= \Pi_0^{\bar{D}\Sigma_c}(x) + \Pi_G^{\bar{D}\Sigma_c}(x), \\ \Pi^{\bar{D}^0\Sigma_c^+}(x) &= \Pi_0^{\bar{D}\Sigma_c}(x) + \Pi_G^{\bar{D}\Sigma_c}(x) - \Pi_Q^{\bar{D}\Sigma_c}(x), \\ \Pi_{I=1/2}^{\bar{D}\Sigma_c}(x) &= \Pi_0^{\bar{D}\Sigma_c}(x) + \Pi_G^{\bar{D}\Sigma_c}(x) + \Pi_Q^{\bar{D}\Sigma_c}(x), \\ \Pi_{I=3/2}^{\bar{D}\Sigma_c}(x) &= \Pi_0^{\bar{D}\Sigma_c}(x) + \Pi_G^{\bar{D}\Sigma_c}(x) - 2\Pi_Q^{\bar{D}\Sigma_c}(x), \end{aligned}$$

where $\Pi_0^{\bar{D}\Sigma_c}(x) = \Pi^{\bar{D}}(x) \times \Pi^{\Sigma_c}(x)$ is the leading term contributed by non-correlated \bar{D} and Σ_c ; $\Pi_G^{\bar{D}\Sigma_c}$ describes the double-gluon-exchange interaction between

them, but we do not take it into account in the present study, because the other term $\Pi_Q^{\bar{D}\Sigma_c}$ is much larger.

The term $\Pi_Q^{\bar{D}\Sigma_c}$ describes the light-quark-exchange effect between \bar{D} and Σ_c , *i.e.*, \bar{D} and Σ_c are exchanging and so sharing light up/down quarks. We systematically study it using the method of QCD sum rules, and calculate the mass correction ΔM induced by this term. Note that the obtained results can be further applied to study production and decay properties of these hadronic molecular states [68–70]. The parameter ΔM is actually not the binding energy, because we are using local currents in QCD sum rule analyses. We can relate it to some potential $V(r)$ between \bar{D} and Σ_c induced by exchanged/shared light quarks, satisfying:

$$\begin{aligned} V(|r|=0) &= \Delta M, \\ V(|r|\rightarrow\infty) &\rightarrow 0. \end{aligned}$$

We systematically investigate the light-quark-exchange term Π_Q , and study its contributions to the $\bar{D}^{(*)}\Sigma_c^{(*)}$, $\bar{D}^{(*)}\Lambda_c$, $D^{(*)}\bar{K}^*$, and $D^{(*)}\bar{D}^{(*)}$ hadronic molecular states. We calculate their mass corrections, some of which are listed here:

$$\begin{aligned} \Delta M_{I=1/2, J=1/2}^{\bar{D}\Sigma_c} &= -95 \text{ MeV}, \\ \Delta M_{I=1/2, J=3/2}^{\bar{D}^*\Sigma_c} &= -89 \text{ MeV}, \\ \Delta M_{I=1/2, J=3/2}^{\bar{D}\Sigma_c^*} &= -86 \text{ MeV}, \\ \Delta M_{I=1/2, J=5/2}^{\bar{D}^*\Sigma_c^*} &= -107 \text{ MeV}, \\ \Delta M_{I=0, J=1}^{D\bar{K}^*} &= -180 \text{ MeV}, \\ \Delta M_{I=0, J=2}^{D^*\bar{K}^*} &= -119 \text{ MeV}. \end{aligned}$$

These results suggest their corresponding light-quark-exchange potentials $V(r)$ to be attractive, so there can be

- the $\bar{D}\Sigma_c$ covalent molecule of $I = 1/2$ and $J = 1/2$,
- the $\bar{D}^*\Sigma_c$ covalent molecule of $I = 1/2$ and $J = 3/2$,
- the $\bar{D}\Sigma_c^*$ covalent molecule of $I = 1/2$ and $J = 3/2$,
- the $\bar{D}^*\Sigma_c^*$ covalent molecule of $I = 1/2$ and $J = 5/2$,
- the $D\bar{K}^*$ covalent molecule of $I = 0$ and $J = 1$,
- the $D^*\bar{K}^*$ covalent molecule of $I = 0$ and $J = 2$.

The binding mechanism induced by shared light quarks is somewhat similar to the covalent bond in chemical molecules induced by shared electrons, so we call such hadronic molecules “covalent hadronic molecules”. Different from the chemical molecules, the internal structure of the hadrons and so the covalent hadronic molecules is much more complicated, since they contain not only the valence quarks but also the sea quarks and gluons.

TABLE II: Binding energies of some possibly-existing covalent hadronic molecules, estimated in our toy model through the simplified formula $B = N_A A + N_S S - N_R R - N\epsilon$, with $A \sim 30$ MeV, $S \sim 20$ MeV, $R \sim 17$ MeV, and $\epsilon \sim 6$ MeV. We do not take into account the spin splitting effect described by the parameter $\kappa \sim 13$ MeV here.

Molecules	Binding energies	Molecules	Binding energies
${}^2\text{H}, D^* D^{(*)} / \bar{B}^* \bar{B}^{(*)}$	1 MeV	$D^{(*)} \bar{B}^{(*)}$	18 MeV
${}^3\text{H}/{}^3\text{He}, D^* D^{(*)} D^{(*)} / \bar{B}^* \bar{B}^{(*)} \bar{B}^{(*)}$	8 MeV	$D^{(*)} D^{(*)} \bar{B}^{(*)} / D^{(*)} \bar{B}^{(*)} \bar{B}^{(*)}$	42 MeV
${}^4\text{He}, D^* D^* D^{(*)} D^{(*)} / \bar{B}^* \bar{B}^* \bar{B}^{(*)} \bar{B}^{(*)}$	28 MeV	$D^* D^{(*)} D^{(*)} \bar{B}^{(*)} / D^{(*)} \bar{B}^{(*)} \bar{B}^{(*)} \bar{B}^*$	62 MeV
		$D^{(*)} D^{(*)} \bar{B}^{(*)} \bar{B}^{(*)}$	96 MeV
$\Sigma_c^{(*)} \Sigma_c^{(*)} / \Sigma_b^{(*)} \Sigma_b^{(*)}$	31 MeV	$\Sigma_c^{(*)} \Sigma_b^{(*)}$	48 MeV
		$\bar{D}^{(*)} \Sigma_c^{(*)} / \bar{D}^{(*)} \Sigma_b^{(*)} / B^{(*)} \Sigma_c^{(*)} / B^{(*)} \Sigma_b^{(*)}$	18 MeV
		$\bar{D}^{(*)} \bar{D}^{(*)} \Sigma_c^{(*)}$	42 MeV
		$D^{(*)} \bar{B}_s^{(*)}$	8 MeV
${}^3_{\Lambda} \text{H}, D^* D^{(*)} D_s^{(*)}$	1 MeV	$D^{(*)} D^{(*)} \bar{B}_s^{(*)}$	35 MeV
${}^4_{\Lambda} \text{H}/{}^4_{\Lambda} \text{He}, D^* D^{(*)} D^{(*)} D_s^{(*)}$	11 MeV	$D^* D^{(*)} D^{(*)} \bar{B}_s^{(*)}$	62 MeV
${}^5_{\Lambda} \text{He}, D^* D^* D^{(*)} D^{(*)} D_s^{(*)}$	31 MeV	$D^* D^* D^{(*)} D^{(*)} \bar{B}_s^{(*)}$	82 MeV
${}^6_{\Lambda\Lambda} \text{He}, D^* D^* D^{(*)} D^{(*)} D_s^{(*)} D_s^{(*)}$	34 MeV	$D^* D^* D^{(*)} D^{(*)} \bar{B}_s^{(*)} \bar{B}_s^{(*)}$	136 MeV
$\Sigma_c^{(*)} \Xi_c^{(*)}$	21 MeV	$\Sigma_c^{(*)} \Xi_b^{(*)}$	38 MeV
$\Xi_c^{(*)} \Xi_c^{(*)}$	11 MeV	$\Xi_c^{(*)} \Xi_b^{(*)}$	28 MeV
$\Sigma_c^{(*)} \Xi_c^{(*)} \Xi_c^{(*)}$	71 MeV	$\Sigma_c^{(*)} \Xi_c^{(*)} \Xi_b^{(*)}$	105 MeV
		$\bar{D}^{(*)} \Xi_c^{(*)}$	18 MeV
		$\bar{D}^{(*)} \bar{D}^{(*)} \Xi_c^{(*)}$	35 MeV
		$\bar{D}^{(*)} \bar{D}^{(*)} \Xi_c^{(*)} \Xi_b^{(*)}$	116 MeV

In the present study we consider the covalent hadronic molecules induced only by the shared valence quarks.

Recalling that the two shared electrons must spin in opposite directions (and so totally antisymmetric obeying the Pauli principle) in order to form a chemical covalent bond, our QCD sum rule results indicate a similar hypothesis: *the light-quark-exchange interaction is attractive when the shared light quarks are totally antisymmetric so that obey the Pauli principle.*

Its logical chain is quite straightforward. We assume the two light quarks q_A inside Y and q_B inside Z are totally antisymmetric. Hence, q_A and q_B obey the Pauli principle, so that they can be exchanged and shared. By doing this, wave-functions of Y and Z overlap with each other, so that they are attracted and there can be the

covalent hadronic molecule $X = |YZ\rangle$. This picture has been depicted in Fig. 1. We believe it better and more important than our QCD sum rule results, given it to be model independent and more easily applicable.

We apply the above hypothesis to reanalysis the $\bar{D}^{(*)} \Sigma_c^{(*)}$, $\bar{D}^{(*)} \Lambda_c$, $D^{(*)} \bar{K}^*$, and $D^{(*)} \bar{D}^{(*)}$ hadronic molecules, and the obtained results are generally consistent with our QCD sum rule results. However, there can be more hyperfine structures allowed/predicted by the hypothesis, similar to the case of para-hydrogen and ortho-hydrogen with the two protons spinning in opposite directions and in the same direction, respectively. These hyperfine structures can not be differentiated in our QCD sum rule studies, since there we need to sum over polarizations.

We also apply the above hypothesis to predict more possibly-existing covalent hadronic molecules, as summarized in Table I. We build a toy model to formalize this picture and estimate their binding energies. Our model has four parameters, which are fixed by considering the P_c/P_{cs} and the recently observed T_{cc}^+ as possible covalent hadronic molecules. Some simplified results neglecting the spin splitting effect are summarized in Table II. Note that these results are obtained from the light-quark-exchange interaction only, and there can be some other interactions among hadrons, *e.g.*, the light-quark-exchange term $\Pi_Q(x)$ does not contribute to the $D^{(*)}\bar{D}^{(*)}$ molecules, suggesting that the $D^{(*)}\bar{D}^{(*)}$ covalent hadronic molecules do not exist, but there can still be the $D^{(*)}\bar{D}^{(*)}$ molecules possibly induced by the one-meson-exchange interaction. These interactions can also contribute to the binding energies given in Table II, which is one source of their theoretical uncertainties.

A unique feature of our covalent hadronic molecule picture is that binding energies of the $(I)J^P = (0)1^+ D\bar{B}^*/D^*\bar{B}$ hadronic molecules are much larger than those of the $(I)J^P = (0)1^+ DD^*/\bar{B}\bar{B}^*$ ones, while the $(I)J^P = (1/2)1/2^+ \bar{D}\Sigma_c/\bar{D}\Sigma_b/B\Sigma_c/B\Sigma_b$ hadronic molecules have similar binding energies. This is due to that the two identical heavy quarks in $DD^*/\bar{B}\bar{B}^*$ hadronic molecules form repulsive cores, but the two different heavy quarks in $D\bar{B}^*/D^*\bar{B}$ and $\bar{D}\Sigma_c/\bar{D}\Sigma_b/B\Sigma_c/B\Sigma_b$ hadronic molecules do not.

To end this paper, we note again that the one-meson-exchange interaction Π_M at the hadron level and the

light-quark-exchange interaction Π_Q at the quark-gluon level can overlap with each other. Hence, we attempt to understand the nuclear force based on the picture of covalent hadronic molecules very roughly: a) the $(I)J^P = (0)0^+$ up-down quark pairs inside protons/neutrons are in some sense ‘‘saturated’’, so they can not be exchanged and form repulsive cores in the nucleus; b) the other up/down quarks inside protons/neutrons can be freely exchanged/shared/moving, inducing some interactions among nucleons; c) in the multi-nucleon nucleus there can be many up/down quarks being shared, so its binding mechanism transfers into the ‘‘metallic’’ hadronic bond. Based on these understandings, we estimate binding energies of some nuclei using our toy model, as summarized in Table II. Finally, we propose another possibly-existing binding mechanism similar to the ‘‘ionic’’ bond, but it might only be observable in the quark-gluon plasma.

Acknowledgments

We thank Yan-Rui Liu and Li-Ming Zhang for helpful discussions. This project is supported by the National Natural Science Foundation of China under Grants No. 11722540 and No. 12075019, the Jiangsu Provincial Double-Innovation Program under Grant No. JSS-CRC2021488, and the Fundamental Research Funds for the Central Universities.

Appendix A: Spectral densities

In this appendix we list spectral densities extracted from the currents $J^{D^-\Sigma_c^{++}}$, $J^{\bar{D}^0\Sigma_c^+}$, $J^{\bar{D}\Sigma_c}$ of $I = 1/2$, and $J_{I=3/2}^{\bar{D}\Sigma_c}$. These currents are defined in Eqs. (7), (12), (21), and (27), respectively. In the following expressions, $\mathcal{F}(s) = [(\alpha + \beta)m_c^2 - \alpha\beta s]$, $\mathcal{H}(s) = [m_c^2 - \alpha(1 - \alpha)s]$, and the integration limits are $\alpha_{min} = \frac{1 - \sqrt{1 - 4m_c^2/s}}{2}$, $\alpha_{max} = \frac{1 + \sqrt{1 - 4m_c^2/s}}{2}$, $\beta_{min} = \frac{\alpha m_c^2}{\alpha s - m_c^2}$, and $\beta_{max} = 1 - \alpha$.

The spectral density $\rho^{\bar{D}\Sigma_c}(s)$ extracted from the current $J^{\bar{D}\Sigma_c}$ of $I = 1/2$ can be separated into

$$\rho^{\bar{D}\Sigma_c}(s) = \rho_0^{\bar{D}\Sigma_c}(s) + \rho_Q^{\bar{D}\Sigma_c}(s). \quad (\text{A1})$$

The leading term $\rho_0^{\bar{D}\Sigma_c}(s)$ is

$$\begin{aligned} \rho_0^{\bar{D}\Sigma_c}(s) = & m_c \left(\rho_1^{pert}(s) + \rho_1^{\langle \bar{q}q \rangle}(s) + \rho_1^{\langle GG \rangle}(s) + \rho_1^{\langle \bar{q}Gq \rangle}(s) + \rho_1^{\langle \bar{q}q \rangle^2}(s) + \rho_1^{\langle \bar{q}q \rangle \langle \bar{q}Gq \rangle}(s) + \rho_1^{\langle \bar{q}Gq \rangle^2}(s) + \rho_1^{\langle \bar{q}q \rangle^3}(s) \right) \\ & + \not{q} \left(\rho_2^{pert}(s) + \rho_2^{\langle \bar{q}q \rangle}(s) + \rho_2^{\langle GG \rangle}(s) + \rho_2^{\langle \bar{q}Gq \rangle}(s) + \rho_2^{\langle \bar{q}q \rangle^2}(s) + \rho_2^{\langle \bar{q}q \rangle \langle \bar{q}Gq \rangle}(s) + \rho_2^{\langle \bar{q}Gq \rangle^2}(s) + \rho_2^{\langle \bar{q}q \rangle^3}(s) \right), \end{aligned} \quad (\text{A2})$$

where

$$\begin{aligned} \rho_1^{pert}(s) &= \int_{\alpha_{min}}^{\alpha_{max}} d\alpha \int_{\beta_{min}}^{\beta_{max}} d\beta \left\{ \mathcal{F}(s)^5 \times \frac{(1 - \alpha - \beta)^3}{81920\pi^8\alpha^5\beta^4} \right\}, \\ \rho_1^{\langle \bar{q}q \rangle}(s) &= m_c \langle \bar{q}q \rangle \int_{\alpha_{min}}^{\alpha_{max}} d\alpha \int_{\beta_{min}}^{\beta_{max}} d\beta \left\{ \mathcal{F}(s)^3 \times \frac{-(1 - \alpha - \beta)^2}{1024\pi^6\alpha^3\beta^3} \right\}, \end{aligned}$$

$$\begin{aligned}
\rho_1^{\langle GG \rangle}(s) &= \langle g_s^2 GG \rangle \int_{\alpha_{min}}^{\alpha_{max}} d\alpha \int_{\beta_{min}}^{\beta_{max}} d\beta \left\{ m_c^2 \mathcal{F}(s)^2 \times \frac{(1-\alpha-\beta)^3 (\alpha^3 + \beta^3)}{98304\pi^8 \alpha^5 \beta^4} \right. \\
&\quad \left. + \mathcal{F}(s)^3 \times \frac{(\alpha + \beta - 1)(3\alpha^3 + \alpha^2(8\beta - 3) + \alpha(\beta - 1)\beta - (\beta - 1)^2\beta)}{98304\pi^8 \alpha^5 \beta^3} \right\}, \\
\rho_1^{\langle \bar{q}Gq \rangle}(s) &= m_c \langle g_s \bar{q} \sigma Gq \rangle \int_{\alpha_{min}}^{\alpha_{max}} d\alpha \int_{\beta_{min}}^{\beta_{max}} d\beta \left\{ \mathcal{F}(s)^2 \times \frac{3(1-\alpha-\beta)(\alpha + 2\beta - 1)}{2048\pi^6 \alpha^2 \beta^3} \right\}, \\
\rho_1^{\langle \bar{q}q \rangle^2}(s) &= \langle \bar{q}q \rangle^2 \int_{\alpha_{min}}^{\alpha_{max}} d\alpha \int_{\beta_{min}}^{\beta_{max}} d\beta \left\{ \mathcal{F}(s)^2 \times \frac{-1}{64\pi^4 \alpha^2 \beta} \right\}, \\
\rho_1^{\langle \bar{q}q \rangle \langle \bar{q}Gq \rangle}(s) &= \langle \bar{q}q \rangle \langle g_s \bar{q} \sigma Gq \rangle \int_{\alpha_{min}}^{\alpha_{max}} d\alpha \left\{ \int_{\beta_{min}}^{\beta_{max}} d\beta \left\{ \mathcal{F}(s) \times \frac{-1}{128\pi^4 \alpha^2} \right\} + \mathcal{H}(s) \times \frac{1}{64\pi^4 \alpha} \right\}, \\
\rho_1^{\langle \bar{q}Gq \rangle^2}(s) &= \langle g_s \bar{q} \sigma Gq \rangle^2 \left\{ \int_{\alpha_{min}}^{\alpha_{max}} d\alpha \left\{ \frac{(\alpha - 1)(2\alpha - 1)}{512\pi^4 \alpha} \right\} + \int_0^1 d\alpha \left\{ m_c^2 \delta \left(s - \frac{m_c^2}{\alpha(1-\alpha)} \right) \times \frac{-1}{512\pi^4 \alpha} \right\} \right\}, \\
\rho_1^{\langle \bar{q}q \rangle^3}(s) &= m_c \langle \bar{q}q \rangle^3 \int_{\alpha_{min}}^{\alpha_{max}} d\alpha \left\{ \frac{1}{24\pi^2} \right\}, \\
\rho_2^{pert}(s) &= \int_{\alpha_{min}}^{\alpha_{max}} d\alpha \int_{\beta_{min}}^{\beta_{max}} d\beta \left\{ \mathcal{F}(s)^5 \times \frac{(1-\alpha-\beta)^3}{40960\pi^8 \alpha^4 \beta^4} \right\}, \\
\rho_2^{\langle \bar{q}q \rangle}(s) &= m_c \langle \bar{q}q \rangle \int_{\alpha_{min}}^{\alpha_{max}} d\alpha \int_{\beta_{min}}^{\beta_{max}} d\beta \left\{ \mathcal{F}(s)^3 \times \frac{-(1-\alpha-\beta)^2}{512\pi^6 \alpha^2 \beta^3} \right\}, \\
\rho_2^{\langle GG \rangle}(s) &= \langle g_s^2 GG \rangle \int_{\alpha_{min}}^{\alpha_{max}} d\alpha \int_{\beta_{min}}^{\beta_{max}} d\beta \left\{ m_c^2 \mathcal{F}(s)^2 \times \frac{(1-\alpha-\beta)^3 (\alpha^3 + \beta^3)}{49152\pi^8 \alpha^4 \beta^4} \right. \\
&\quad \left. + \mathcal{F}(s)^3 \times \frac{(\alpha + \beta - 1)^2 (2\alpha + \beta)}{32768\pi^8 \alpha^3 \beta^3} \right\}, \\
\rho_2^{\langle \bar{q}Gq \rangle}(s) &= m_c \langle g_s \bar{q} \sigma Gq \rangle \int_{\alpha_{min}}^{\alpha_{max}} d\alpha \int_{\beta_{min}}^{\beta_{max}} d\beta \left\{ \mathcal{F}(s)^2 \times \frac{3(1-\alpha-\beta)(\alpha + 2\beta - 1)}{1024\pi^6 \alpha \beta^3} \right\}, \\
\rho_2^{\langle \bar{q}q \rangle^2}(s) &= \langle \bar{q}q \rangle^2 \int_{\alpha_{min}}^{\alpha_{max}} d\alpha \int_{\beta_{min}}^{\beta_{max}} d\beta \left\{ \mathcal{F}(s)^2 \times \frac{-1}{128\pi^4 \alpha \beta} \right\}, \\
\rho_2^{\langle \bar{q}q \rangle \langle \bar{q}Gq \rangle}(s) &= \langle \bar{q}q \rangle \langle g_s \bar{q} \sigma Gq \rangle \int_{\alpha_{min}}^{\alpha_{max}} d\alpha \left\{ \int_{\beta_{min}}^{\beta_{max}} d\beta \left\{ \mathcal{F}(s) \times \frac{-1}{256\pi^4 \alpha} \right\} + \mathcal{H}(s) \times \frac{1}{128\pi^4} \right\}, \\
\rho_2^{\langle \bar{q}Gq \rangle^2}(s) &= \langle g_s \bar{q} \sigma Gq \rangle^2 \left\{ \int_{\alpha_{min}}^{\alpha_{max}} d\alpha \left\{ \frac{(\alpha - 1)(2\alpha - 1)}{1024\pi^4} \right\} + \int_0^1 d\alpha \left\{ m_c^2 \delta \left(s - \frac{m_c^2}{\alpha(1-\alpha)} \right) \times \frac{-1}{1024\pi^4} \right\} \right\}, \\
\rho_2^{\langle \bar{q}q \rangle^3}(s) &= m_c \langle \bar{q}q \rangle^3 \int_{\alpha_{min}}^{\alpha_{max}} d\alpha \left\{ \frac{\alpha}{48\pi^2} \right\}.
\end{aligned}$$

The light-quark-exchange term $\rho_Q^{\bar{D}\Sigma_c}(s)$ is

$$\begin{aligned}
\rho_Q^{\bar{D}\Sigma_c}(s) &= m_c \left(\rho_3^{pert}(s) + \rho_3^{\langle \bar{q}q \rangle}(s) + \rho_3^{\langle GG \rangle}(s) + \rho_3^{\langle \bar{q}Gq \rangle}(s) + \rho_3^{\langle \bar{q}q \rangle^2}(s) + \rho_3^{\langle \bar{q}q \rangle \langle \bar{q}Gq \rangle}(s) + \rho_3^{\langle \bar{q}Gq \rangle^2}(s) + \rho_3^{\langle \bar{q}q \rangle^3}(s) \right) \\
&\quad + \not{q} \left(\rho_4^{pert}(s) + \rho_4^{\langle \bar{q}q \rangle}(s) + \rho_4^{\langle GG \rangle}(s) + \rho_4^{\langle \bar{q}Gq \rangle}(s) + \rho_4^{\langle \bar{q}q \rangle^2}(s) + \rho_4^{\langle \bar{q}q \rangle \langle \bar{q}Gq \rangle}(s) + \rho_4^{\langle \bar{q}Gq \rangle^2}(s) + \rho_4^{\langle \bar{q}q \rangle^3}(s) \right),
\end{aligned} \tag{A3}$$

where

$$\rho_3^{pert}(s) = \int_{\alpha_{min}}^{\alpha_{max}} d\alpha \int_{\beta_{min}}^{\beta_{max}} d\beta \left\{ \mathcal{F}(s)^5 \times \frac{(1-\alpha-\beta)^3}{983040\pi^8 \alpha^5 \beta^4} \right\},$$

$$\begin{aligned}
\rho_3^{\langle \bar{q}q \rangle}(s) &= m_c \langle \bar{q}q \rangle \int_{\alpha_{min}}^{\alpha_{max}} d\alpha \int_{\beta_{min}}^{\beta_{max}} d\beta \left\{ \mathcal{F}(s)^3 \times \frac{-(1-\alpha-\beta)^2}{3072\pi^6\alpha^3\beta^3} \right\}, \\
\rho_3^{\langle GG \rangle}(s) &= \langle g_s^2 GG \rangle \int_{\alpha_{min}}^{\alpha_{max}} d\alpha \int_{\beta_{min}}^{\beta_{max}} d\beta \left\{ m_c^2 \mathcal{F}(s)^2 \times \frac{(1-\alpha-\beta)^3(\alpha^3+\beta^3)}{1179648\pi^8\alpha^5\beta^4} \right. \\
&\quad \left. + \mathcal{F}(s)^3 \times \frac{(\alpha+\beta-1)^2(8\alpha^2+6\alpha\beta+\alpha-2(\beta-1)\beta)}{2359296\pi^8\alpha^5\beta^3} \right\}, \\
\rho_3^{\langle \bar{q}Gq \rangle}(s) &= m_c \langle g_s \bar{q}\sigma Gq \rangle \int_{\alpha_{min}}^{\alpha_{max}} d\alpha \int_{\beta_{min}}^{\beta_{max}} d\beta \left\{ \mathcal{F}(s)^2 \times \frac{(1-\alpha-\beta)(2\alpha^2+\alpha(6\beta-2)+(\beta-1)\beta)}{8192\pi^6\alpha^3\beta^3} \right\}, \\
\rho_3^{\langle \bar{q}q \rangle^2}(s) &= \langle \bar{q}q \rangle^2 \int_{\alpha_{min}}^{\alpha_{max}} d\alpha \int_{\beta_{min}}^{\beta_{max}} d\beta \left\{ \mathcal{F}(s)^2 \times \frac{-5}{1536\pi^4\alpha^2\beta} \right\}, \\
\rho_3^{\langle \bar{q}q \rangle \langle \bar{q}Gq \rangle}(s) &= \langle \bar{q}q \rangle \langle g_s \bar{q}\sigma Gq \rangle \int_{\alpha_{min}}^{\alpha_{max}} d\alpha \left\{ \int_{\beta_{min}}^{\beta_{max}} d\beta \left\{ \mathcal{F}(s) \times \frac{-6\alpha-5\beta}{3072\pi^4\alpha^2\beta} \right\} + \mathcal{H}(s) \times \frac{7}{3072\pi^4\alpha} \right\}, \\
\rho_3^{\langle \bar{q}Gq \rangle^2}(s) &= \langle g_s \bar{q}\sigma Gq \rangle^2 \left\{ \int_{\alpha_{min}}^{\alpha_{max}} d\alpha \left\{ \frac{4\alpha^2-3\alpha+5}{12288\pi^4\alpha} \right\} + \int_0^1 d\alpha \left\{ m_c^2 \delta \left(s - \frac{m_c^2}{\alpha(1-\alpha)} \right) \times \frac{-1}{6144\pi^4\alpha} \right\} \right\}, \\
\rho_3^{\langle \bar{q}q \rangle^3}(s) &= m_c \langle \bar{q}q \rangle^3 \int_{\alpha_{min}}^{\alpha_{max}} d\alpha \left\{ \frac{1}{288\pi^2} \right\}, \\
\rho_4^{pert}(s) &= \int_{\alpha_{min}}^{\alpha_{max}} d\alpha \int_{\beta_{min}}^{\beta_{max}} d\beta \left\{ \mathcal{F}(s)^5 \times \frac{(1-\alpha-\beta)^3}{491520\pi^8\alpha^4\beta^4} \right\}, \\
\rho_4^{\langle \bar{q}q \rangle}(s) &= m_c \langle \bar{q}q \rangle \int_{\alpha_{min}}^{\alpha_{max}} d\alpha \int_{\beta_{min}}^{\beta_{max}} d\beta \left\{ \mathcal{F}(s)^3 \times \frac{-5(1-\alpha-\beta)^2}{12288\pi^6\alpha^2\beta^3} \right\}, \\
\rho_4^{\langle GG \rangle}(s) &= \langle g_s^2 GG \rangle \int_{\alpha_{min}}^{\alpha_{max}} d\alpha \int_{\beta_{min}}^{\beta_{max}} d\beta \left\{ m_c^2 \mathcal{F}(s)^2 \times \frac{(1-\alpha-\beta)^3(\alpha^3+\beta^3)}{589824\pi^8\alpha^4\beta^4} \right. \\
&\quad \left. + \mathcal{F}(s)^3 \times \frac{(\alpha+\beta-1)(23\alpha^2+\alpha(7\beta-22)+8\beta^2-7\beta-1)}{2359296\pi^8\alpha^3\beta^3} \right\}, \\
\rho_4^{\langle \bar{q}Gq \rangle}(s) &= m_c \langle g_s \bar{q}\sigma Gq \rangle \int_{\alpha_{min}}^{\alpha_{max}} d\alpha \int_{\beta_{min}}^{\beta_{max}} d\beta \left\{ \mathcal{F}(s)^2 \times \frac{(1-\alpha-\beta)(14\alpha^2+\alpha(25\beta-14)+3(\beta-1)\beta)}{32768\pi^6\alpha^2\beta^3} \right\}, \\
\rho_4^{\langle \bar{q}q \rangle^2}(s) &= \langle \bar{q}q \rangle^2 \int_{\alpha_{min}}^{\alpha_{max}} d\alpha \int_{\beta_{min}}^{\beta_{max}} d\beta \left\{ \mathcal{F}(s)^2 \times \frac{-1}{384\pi^4\alpha\beta} \right\}, \\
\rho_4^{\langle \bar{q}q \rangle \langle \bar{q}Gq \rangle}(s) &= \langle \bar{q}q \rangle \langle g_s \bar{q}\sigma Gq \rangle \int_{\alpha_{min}}^{\alpha_{max}} d\alpha \left\{ \int_{\beta_{min}}^{\beta_{max}} d\beta \left\{ \mathcal{F}(s) \times \frac{-5\alpha-3\beta}{3072\pi^4\alpha\beta} \right\} + \mathcal{H}(s) \times \frac{7}{3072\pi^4} \right\}, \\
\rho_4^{\langle \bar{q}Gq \rangle^2}(s) &= \langle g_s \bar{q}\sigma Gq \rangle^2 \left\{ \int_{\alpha_{min}}^{\alpha_{max}} d\alpha \left\{ \frac{6\alpha^2-4\alpha+3}{12288\pi^4} \right\} + \int_0^1 d\alpha \left\{ \frac{-1}{4096\pi^4} \right\} \right\}, \\
\rho_4^{\langle \bar{q}q \rangle^3}(s) &= m_c \langle \bar{q}q \rangle^3 \int_{\alpha_{min}}^{\alpha_{max}} d\alpha \left\{ \frac{\alpha}{576\pi^2} \right\}.
\end{aligned}$$

The spectral densities $\rho^{D^-\Sigma_c^{++}}(s)$, $\rho^{\bar{D}^0\Sigma_c^+}(s)$, and $\rho_{I=3/2}^{\bar{D}\Sigma_c}(s)$ extracted from the currents $J^{D^-\Sigma_c^{++}}$, $J^{\bar{D}^0\Sigma_c^+}$, and $J_{I=3/2}^{\bar{D}\Sigma_c}$ are related to $\rho^{\bar{D}\Sigma_c}(s)$ through

$$\rho^{D^-\Sigma_c^{++}}(s) = \rho_0^{\bar{D}\Sigma_c}(s), \quad (\text{A4})$$

$$\rho^{\bar{D}^0\Sigma_c^+}(s) = \rho_0^{\bar{D}\Sigma_c}(s) - \rho_Q^{\bar{D}\Sigma_c}(s), \quad (\text{A5})$$

$$\rho_{I=3/2}^{\bar{D}\Sigma_c}(s) = \rho_0^{\bar{D}\Sigma_c}(s) - 2\rho_Q^{\bar{D}\Sigma_c}(s). \quad (\text{A6})$$

Appendix B: Spin decompositions

In this appendix we list some spin decompositions used in the present study. The transitions from the $|s_{c\bar{q}}, s_{c'\bar{q}'}; J\rangle$ basis to the $|s_{cc'}, s_{\bar{q}\bar{q}'}; J\rangle$ basis are:

$$\begin{aligned}
|s_{c\bar{q}}, s_{c'\bar{q}'}; J\rangle &\rightarrow |s_{cc'}, s_{\bar{q}\bar{q}'}; J\rangle, \\
|0, 0; 0\rangle &= \frac{1}{2} |0, 0; 0\rangle + \frac{\sqrt{3}}{2} |1, 1; 0\rangle, \\
|0, 1; 1\rangle &= \frac{1}{2} |0, 1; 1\rangle - \frac{1}{2} |1, 0; 1\rangle + \frac{1}{\sqrt{2}} |1, 1; 1\rangle, \\
|1, 0; 1\rangle &= -\frac{1}{2} |0, 1; 1\rangle + \frac{1}{2} |1, 0; 1\rangle + \frac{1}{\sqrt{2}} |1, 1; 1\rangle, \\
|1, 1; 0\rangle &= \frac{\sqrt{3}}{2} |0, 0; 0\rangle - \frac{1}{2} |1, 1; 0\rangle, \\
|1, 1; 1\rangle &= \frac{1}{\sqrt{2}} |0, 1; 1\rangle + \frac{1}{\sqrt{2}} |1, 0; 1\rangle, \\
|1, 1; 2\rangle &= |1, 1; 2\rangle.
\end{aligned} \tag{B1}$$

The transitions from the $|s_{\bar{c}q_1}, s_{q_2q_3c}; J\rangle_{s_{q_2q_3}=1}$ basis to the $|s_{\bar{c}c}, s_{q_1q_2q_3}; J\rangle_{s_{q_2q_3}=1}$ basis are:

$$\begin{aligned}
|s_{\bar{c}q_1}, s_{q_2q_3c}; J\rangle_{s_{q_2q_3}=1} &\rightarrow |s_{\bar{c}c}, s_{q_1q_2q_3}; J\rangle_{s_{q_2q_3}=1}, \\
|0, \frac{1}{2}; \frac{1}{2}\rangle &= \frac{1}{2} |0, \frac{1}{2}; \frac{1}{2}\rangle - \frac{1}{\sqrt{12}} |1, \frac{1}{2}; \frac{1}{2}\rangle - \sqrt{\frac{2}{3}} |1, \frac{3}{2}; \frac{1}{2}\rangle, \\
|1, \frac{1}{2}; \frac{1}{2}\rangle &= -\frac{1}{\sqrt{12}} |0, \frac{1}{2}; \frac{1}{2}\rangle + \frac{5}{6} |1, \frac{1}{2}; \frac{1}{2}\rangle - \frac{\sqrt{2}}{3} |1, \frac{3}{2}; \frac{1}{2}\rangle, \\
|1, \frac{1}{2}; \frac{3}{2}\rangle &= \frac{1}{\sqrt{3}} |0, \frac{3}{2}; \frac{3}{2}\rangle + \frac{1}{3} |1, \frac{1}{2}; \frac{3}{2}\rangle + \frac{\sqrt{5}}{3} |1, \frac{3}{2}; \frac{3}{2}\rangle, \\
|0, \frac{3}{2}; \frac{3}{2}\rangle &= \frac{1}{2} |0, \frac{3}{2}; \frac{3}{2}\rangle + \frac{1}{\sqrt{3}} |1, \frac{1}{2}; \frac{3}{2}\rangle - \sqrt{\frac{5}{12}} |1, \frac{3}{2}; \frac{3}{2}\rangle, \\
|1, \frac{3}{2}; \frac{1}{2}\rangle &= -\sqrt{\frac{2}{3}} |0, \frac{1}{2}; \frac{1}{2}\rangle - \frac{\sqrt{2}}{3} |1, \frac{1}{2}; \frac{1}{2}\rangle - \frac{1}{3} |1, \frac{3}{2}; \frac{1}{2}\rangle, \\
|1, \frac{3}{2}; \frac{3}{2}\rangle &= -\sqrt{\frac{5}{12}} |0, \frac{3}{2}; \frac{3}{2}\rangle + \frac{\sqrt{5}}{3} |1, \frac{1}{2}; \frac{3}{2}\rangle + \frac{1}{6} |1, \frac{3}{2}; \frac{3}{2}\rangle, \\
|1, \frac{3}{2}; \frac{5}{2}\rangle &= |1, \frac{3}{2}; \frac{5}{2}\rangle.
\end{aligned} \tag{B2}$$

The transitions from the $|s_{c_1q_3q_4}, s_{c_2q_5q_6}; J\rangle_{s_{q_3q_4}=1, s_{q_5q_6}=1}$ basis to the $|s_{c_1c_2}, s_{q_3q_4q_5q_6}; J\rangle_{s_{q_3q_4}=1, s_{q_5q_6}=1}$ basis are:

$$\begin{aligned}
|s_{c_1q_3q_4}, s_{c_2q_5q_6}; J\rangle_{s_{q_3q_4}=1, s_{q_5q_6}=1} &\rightarrow |s_{c_1c_2}, s_{q_3q_4q_5q_6}; J\rangle_{s_{q_3q_4}=1, s_{q_5q_6}=1}, \\
|\frac{1}{2}, \frac{1}{2}; 0\rangle &= \frac{1}{\sqrt{3}} |0, 0; 0\rangle + \sqrt{\frac{2}{3}} |1, 1; 0\rangle, \\
|\frac{1}{2}, \frac{1}{2}; 1\rangle &= \frac{\sqrt{2}}{3} |0, 1; 1\rangle - \frac{1}{\sqrt{27}} |1, 0; 1\rangle + \sqrt{\frac{20}{27}} |1, 2; 1\rangle, \\
|\frac{1}{2}, \frac{3}{2}; 1\rangle &= \frac{1}{3} |0, 1; 1\rangle - \sqrt{\frac{8}{27}} |1, 0; 1\rangle + \frac{1}{\sqrt{2}} |1, 1; 1\rangle - \sqrt{\frac{5}{54}} |1, 2; 1\rangle, \\
|\frac{1}{2}, \frac{3}{2}; 2\rangle &= -\frac{1}{\sqrt{3}} |0, 2; 2\rangle + \frac{1}{\sqrt{6}} |1, 1; 2\rangle + \frac{1}{\sqrt{2}} |1, 2; 2\rangle, \\
|\frac{3}{2}, \frac{1}{2}; 1\rangle &= \frac{1}{3} |0, 1; 1\rangle - \sqrt{\frac{8}{27}} |1, 0; 1\rangle - \frac{1}{\sqrt{2}} |1, 1; 1\rangle - \sqrt{\frac{5}{54}} |1, 2; 1\rangle, \\
|\frac{3}{2}, \frac{1}{2}; 2\rangle &= \frac{1}{\sqrt{3}} |0, 2; 2\rangle - \frac{1}{\sqrt{6}} |1, 1; 2\rangle + \frac{1}{\sqrt{2}} |1, 2; 2\rangle,
\end{aligned} \tag{B3}$$

$$\begin{aligned}
|\frac{3}{2}, \frac{3}{2}; 0\rangle &= \sqrt{\frac{2}{3}} |0, 0; 0\rangle - \frac{1}{\sqrt{3}} |1, 1; 0\rangle, \\
|\frac{3}{2}, \frac{3}{2}; 1\rangle &= \frac{\sqrt{5}}{3} |0, 1; 1\rangle + \sqrt{\frac{10}{27}} |1, 0; 1\rangle - \sqrt{\frac{2}{27}} |1, 2; 1\rangle, \\
|\frac{3}{2}, \frac{3}{2}; 2\rangle &= \frac{1}{\sqrt{3}} |0, 2; 2\rangle + \sqrt{\frac{2}{3}} |1, 1; 2\rangle, \\
|\frac{3}{2}, \frac{3}{2}; 3\rangle &= |1, 2; 3\rangle.
\end{aligned}$$

- [1] S. K. Choi *et al.* [Belle Collaboration], *Observation of a Narrow Charmoniumlike State in Exclusive $B^\pm \rightarrow K^\pm \pi^+ \pi^- J/\psi$ Decays*, *Phys. Rev. Lett.* **91**, 262001 (2003).
- [2] P. A. Zyla *et al.* [Particle Data Group], *Review of Particle Physics*, *PTEP* **2020**, 083C01 (2020).
- [3] R. Aaij *et al.* [LHCb Collaboration], *Observation of $J/\psi p$ Resonances Consistent with Pentaquark States in $\Lambda_b^0 \rightarrow J/\psi K^- p$ Decays*, *Phys. Rev. Lett.* **115**, 072001 (2015).
- [4] R. Aaij *et al.* [LHCb Collaboration], *Observation of a Narrow Pentaquark State, $P_c(4312)^+$, and of the Two-Peak Structure of the $P_c(4450)^+$* , *Phys. Rev. Lett.* **122**, 222001 (2019).
- [5] R. Aaij *et al.* [LHCb Collaboration], *Evidence of a $J/\psi \Lambda$ structure and observation of excited Ξ^- states in the $\Xi_b^- \rightarrow J/\psi \Lambda K^-$ decay*, *Sci. Bull.* **66** (2021), 1278-1287.
- [6] R. Aaij *et al.* [LHCb Collaboration], *Evidence for a new structure in the $J/\psi p$ and $J/\psi \bar{p}$ systems in $B_s^0 \rightarrow J/\psi p \bar{p}$ decays*, *Phys. Rev. Lett.* **128**, 062001 (2022).
- [7] H. X. Chen, W. Chen, X. Liu and S. L. Zhu, *The hidden-charm pentaquark and tetraquark states*, *Phys. Rept.* **639**, 1 (2016).
- [8] Y. R. Liu, H. X. Chen, W. Chen, X. Liu and S. L. Zhu, *Pentaquark and Tetraquark States*, *Prog. Part. Nucl. Phys.* **107**, 237 (2019).
- [9] H. X. Chen, W. Chen, X. Liu, Y. R. Liu and S. L. Zhu, *An updated review of the new hadron states*, [arXiv:2204.02649 [hep-ph]].
- [10] A. Hosaka, T. Iijima, K. Miyabayashi, Y. Sakai and S. Yasui, *Exotic hadrons with heavy flavors: X , Y , Z , and related states*, *PTEP* **2016**, 062C01 (2016).
- [11] J. M. Richard, *Exotic hadrons: review and perspectives*, *Few Body Syst.* **57**, 1185 (2016).
- [12] R. F. Lebed, R. E. Mitchell and E. S. Swanson, *Heavy-quark QCD exotica*, *Prog. Part. Nucl. Phys.* **93**, 143 (2017).
- [13] A. Esposito, A. Pilloni and A. D. Polosa, *Multiquark resonances*, *Phys. Rept.* **668**, 1 (2017).
- [14] A. Ali, J. S. Lange and S. Stone, *Exotics: Heavy pentaquarks and tetraquarks*, *Prog. Part. Nucl. Phys.* **97**, 123 (2017).
- [15] F. K. Guo, C. Hanhart, U. G. Meißner, Q. Wang, Q. Zhao, and B. S. Zou, *Hadronic molecules*, *Rev. Mod. Phys.* **90**, 015004 (2018).
- [16] S. L. Olsen, T. Skwarnicki, and D. Zieminska, *Nonstandard heavy mesons and baryons: Experimental evidence*, *Rev. Mod. Phys.* **90**, 015003 (2018).
- [17] M. Karliner, J. L. Rosner and T. Skwarnicki, *Multiquark States*, *Ann. Rev. Nucl. Part. Sci.* **68**, 17 (2018).
- [18] R. M. Albuquerque, J. M. Dias, K. P. Khemchandani, A. Martínez Torres, F. S. Navarra, M. Nielsen and C. M. Zanetti, *QCD sum rules approach to the X , Y and Z states*, *J. Phys. G* **46**, 093002 (2019).
- [19] F. K. Guo, X. H. Liu and S. Sakai, *Threshold cusps and triangle singularities in hadronic reactions*, *Prog. Part. Nucl. Phys.* **112**, 103757 (2020).
- [20] N. Brambilla, S. Eidelman, C. Hanhart, A. Nefediev, C. P. Shen, C. E. Thomas, A. Vairo and C. Z. Yuan, *The XYZ states: experimental and theoretical status and perspectives*, *Phys. Rept.* **873**, 1 (2020).
- [21] G. Yang, J. Ping and J. Segovia, *Tetra- and penta-quark structures in the constituent quark model*, *Symmetry* **12**, 1869 (2020).
- [22] X. K. Dong, F. K. Guo and B. S. Zou, *A survey of heavy-antiheavy hadronic molecules*, *Prog. Phys.* **41**, 65 (2021).
- [23] S. Weinberg, *Evidence That the Deuteron Is Not an Elementary Particle*, *Phys. Rev.* **137**, B672 (1965).
- [24] M. B. Voloshin and L. B. Okun, *Hadron Molecules and Charmonium Atom*, *JETP Lett.* **23**, 333 (1976) [*Pisma Zh. Eksp. Teor. Fiz.* **23**, 369 (1976)].
- [25] A. De Rujula, H. Georgi and S. L. Glashow, *Molecular Charmonium: A New Spectroscopy?* *Phys. Rev. Lett.* **38**, 317 (1977).
- [26] N. A. Tornqvist, *From the deuteron to deusons, an analysis of deuteron-like meson meson bound states*, *Z. Phys. C* **61**, 525 (1994).
- [27] M. B. Voloshin, *Interference and binding effects in decays of possible molecular component of $X(3872)$* , *Phys. Lett. B* **579**, 316 (2004).
- [28] F. E. Close and P. R. Page, *The $D^{*0} \bar{D}^0$ threshold resonance*, *Phys. Lett. B* **578**, 119 (2004).
- [29] C. Y. Wong, *Molecular states of heavy quark mesons*, *Phys. Rev. C* **69**, 055202 (2004).
- [30] E. Braaten and M. Kusunoki, *Low-energy universality and the new charmonium resonance at 3870 MeV*, *Phys. Rev. D* **69**, 074005 (2004).
- [31] E. S. Swanson, *Short range structure in the $X(3872)$* , *Phys. Lett. B* **588**, 189 (2004).
- [32] N. A. Tornqvist, *Isospin breaking of the narrow charmonium state of Belle at 3872 MeV as a deuson*, *Phys. Lett. B* **590**, 209 (2004).
- [33] J. J. Wu, R. Molina, E. Oset and B. S. Zou, *Prediction of Narrow N^* and Λ^* Resonances with Hidden Charm*

- above 4 GeV, *Phys. Rev. Lett.* **105**, 232001 (2010).
- [34] W. L. Wang, F. Huang, Z. Y. Zhang and B. S. Zou, $\Sigma_c \bar{D}$ and $\Lambda_c \bar{D}$ states in a chiral quark model, *Phys. Rev. C* **84**, 015203 (2011).
- [35] Z. C. Yang, Z. F. Sun, J. He, X. Liu and S. L. Zhu, Possible hidden-charm molecular baryons composed of an anti-charmed meson and a charmed baryon, *Chin. Phys. C* **36**, 6 (2012).
- [36] M. Karliner and J. L. Rosner, New Exotic Meson and Baryon Resonances from Doubly-Heavy Hadronic Molecules, *Phys. Rev. Lett.* **115**, 122001 (2015).
- [37] R. Chen, X. Liu, X. Q. Li and S. L. Zhu, Identifying exotic hidden-charm pentaquarks, *Phys. Rev. Lett.* **115**, 132002 (2015).
- [38] H. X. Chen, W. Chen, X. Liu, T. G. Steele and S. L. Zhu, Towards exotic hidden-charm pentaquarks in QCD, *Phys. Rev. Lett.* **115**, 172001 (2015).
- [39] M. Z. Liu, Y. W. Pan, F. Z. Peng, M. S. Sánchez, L. S. Geng, A. Hosaka and M. P. Valderrama, Emergence of a Complete Heavy-Quark Spin Symmetry Multiplet: Seven Molecular Pentaquarks in Light of the Latest LHCb Analysis, *Phys. Rev. Lett.* **122**, 242001 (2019).
- [40] P. Hoodbhoy and R. L. Jaffe, Quark Exchange in Nuclei and the E_{mc} Effect, *Phys. Rev. D* **35**, 113 (1987).
- [41] M. Modarres and K. Ghafoori-Tabrizi, Calculation of the E_{mc} Effect in Nuclear Matter With Quark Exchange, *J. Phys. G* **14**, 1479 (1988).
- [42] M. Modarres and F. Zolfagharpour, Quark exchange and valence quark distributions in A=3 mirror nuclei, *Nucl. Phys. A* **765**, 112 (2006).
- [43] F. Wang, Quark effects in nuclei, *Progr. Phys.* **9**, 297 (1989).
- [44] R. Aaij *et al.* [LHCb], Study of the doubly charmed tetraquark T_{cc}^+ , *Nature Commun.* **13**, 3351 (2022).
- [45] R. Aaij *et al.* [LHCb], Observation of an exotic narrow doubly charmed tetraquark, *Nature Phys.* **18**, 751-754 (2022).
- [46] L. Maiani, F. Piccinini, A. D. Polosa and V. Riquer, Di-quark-antidi-quarks with hidden or open charm and the nature of X(3872), *Phys. Rev. D* **71**, 014028 (2005).
- [47] L. Maiani, F. Piccinini, A. D. Polosa and V. Riquer, Z(4430) and a new paradigm for spin interactions in tetraquarks, *Phys. Rev. D* **89**, 114010 (2014).
- [48] H. Hogaasen, J. M. Richard and P. Sorba, Chromomagnetic mechanism for the X(3872) resonance, *Phys. Rev. D* **73**, 054013 (2006).
- [49] D. Ebert, R. N. Faustov and V. O. Galkin, Masses of heavy tetraquarks in the relativistic quark model, *Phys. Lett. B* **634**, 214 (2006).
- [50] N. Barnea, J. Vijande and A. Valcarce, Four-quark spectroscopy within the hyperspherical formalism, *Phys. Rev. D* **73**, 054004 (2006).
- [51] T. Barnes and S. Godfrey, Charmonium options for the X(3872), *Phys. Rev. D* **69**, 054008 (2004).
- [52] E. J. Eichten, K. Lane and C. Quigg, Charmonium levels near threshold and the narrow state X(3872) $\rightarrow \pi^+ \pi^- J/\psi$, *Phys. Rev. D* **69**, 094019 (2004).
- [53] C. Meng, Y. J. Gao and K. T. Chao, $B \rightarrow \chi_{c1}(1P, 2P)K$ decays in QCD factorization and X(3872), *Phys. Rev. D* **87**, 074035 (2013).
- [54] C. Meng, J. J. Sanz-Cillero, M. Shi, D. L. Yao and H. Q. Zheng, Refined analysis on the X(3872) resonance, *Phys. Rev. D* **92**, 034020 (2015).
- [55] M. A. Shifman, A. I. Vainshtein and V. I. Zakharov, QCD and Resonance Physics. Theoretical Foundations, *Nucl. Phys. B* **147**, 385 (1979).
- [56] L. J. Reinders, H. Rubinstein and S. Yazaki, Hadron Properties from QCD Sum Rules, *Phys. Rept.* **127**, 1 (1985).
- [57] K. C. Yang, W. Y. P. Hwang, E. M. Henley and L. S. Kisslinger, QCD sum rules and neutron proton mass difference, *Phys. Rev. D* **47**, 3001 (1993).
- [58] J. R. Ellis, E. Gardi, M. Karliner and M. A. Samuel, Renormalization-scheme dependence of Pade summation in QCD, *Phys. Rev. D* **54**, 6986 (1996).
- [59] M. Eidemuller and M. Jamin, Charm quark mass from QCD sum rules for the charmonium system, *Phys. Lett. B* **498**, 203 (2001).
- [60] S. Narison, QCD as a theory of hadrons (from partons to confinement), Camb. Monogr. Part. Phys. Nucl. Phys. Cosmol. **17**, 1 (2002).
- [61] V. Gimenez, V. Lubicz, F. Mescia, V. Porretti and J. Reyes, Operator product expansion and quark condensate from lattice QCD in coordinate space, *Eur. Phys. J. C* **41**, 535 (2005).
- [62] M. Jamin, Flavour-symmetry breaking of the quark condensate and chiral corrections to the Gell-Mann-Oakes-Renner relation, *Phys. Lett. B* **538**, 71 (2002).
- [63] B. L. Ioffe and K. N. Zybalyuk, Gluon condensate in charmonium sum rules with 3-loop corrections, *Eur. Phys. J. C* **27**, 229 (2003).
- [64] A. A. Ovchinnikov and A. A. Pivovarov, QCD Sum Rule Calculation Of The Quark Gluon Condensate, *Sov. J. Nucl. Phys.* **48**, 721 (1988) [*Yad. Fiz.* **48**, 1135 (1988)].
- [65] P. Colangelo and A. Khodjamirian, *At the Frontier of Particle Physics/Handbook of QCD*, World Scientific, Singapore, 2001.
- [66] R. Aaij *et al.* [LHCb Collaboration], A model-independent study of resonant structure in $B^+ \rightarrow D^+ D^- K^+$ decays, *Phys. Rev. Lett.* **125**, 242001 (2020).
- [67] R. Aaij *et al.* [LHCb Collaboration], Amplitude analysis of the $B^+ \rightarrow D^+ D^- K^+$ decay, *Phys. Rev. D* **102**, 112003 (2020).
- [68] H. X. Chen, Decay properties of P_c states through the Fierz rearrangement, *Eur. Phys. J. C* **80**, 945 (2020).
- [69] H. X. Chen, Hidden-charm pentaquark states through the current algebra: From their productions to decays, [arXiv:2011.07187 \[hep-ph\]](https://arxiv.org/abs/2011.07187).
- [70] H. X. Chen, Hadronic molecules in B decays, *Phys. Rev. D* **105**, 094003 (2022).