

VERTEX SEPARATORS, CHORDALITY AND VIRTUALLY FREE GROUPS

SAMUEL G. CORREGIDOR AND ÁLVARO MARTÍNEZ-PÉREZ⁽¹⁾

ABSTRACT. In this paper we consider some results obtained for graphs using minimal vertex separators and generalized chordality and translate them to the context of Geometric Group Theory. Using these new tools, we are able to give two new characterizations for a group to be virtually free. Furthermore, we prove that the Baumslag-Solitar group $BS(1, n)$ is k -chordal for some k if and only if $|n| < 3$ and we give an application of generalized chordality to the study of the word problem.

Keywords: vertex separator, chordality, hyperbolicity, quasi-isometry, tree, virtually free. *2020 AMS Subject Classification Numbers.* Primary: 20F65. Secondary: 20F10, 05C25

1. INTRODUCTION

In [25] the second author studied some relations between vertex separator sets, certain chordality properties that generalize being chordal and conditions for a graph to be quasi-isometric to a tree. Some of these ideas can be easily translated to the language of Geometric Group Theory. Moreover, some of the definitions can be re-written in new terms given a group presentation.

Thus, we introduce herein new tools in the context of Geometric Group Theory which can be used from either a more geometric or more algebraic approach.

Let Γ be a connected graph, we will understand it as a geodesical metric space. A subset $P \subseteq V(\Gamma)$ is an (a, b) -separator in Γ if the vertices a and b are in different connected components of $\Gamma \setminus P$.

A graph Γ satisfies the *bottleneck property* (BP) if there exists some constant $\Delta > 0$ so that given any two distinct points $x, y \in V(\Gamma)$ and a midpoint $c \in \Gamma$ such that $d_\Gamma(x, c) = d_\Gamma(y, c) = \frac{1}{2}d_\Gamma(x, y)$, then every xy -path intersects $N_\Delta(c)$. This is an equivalent definition to the original which was defined in [23], see Proposition 2 in [25].

Given $P \subseteq V(\Gamma)$, we denote:

$$\text{diam}(P) = \sup\{d_\Gamma(p, q) \mid p, q \in P\}$$

Then we have the following result for graphs.

Theorem 1.1 (Theorem 7, [25]). *Let Γ be a uniform graph. If every minimal vertex separator in Γ has diameter at most m , then Γ satisfies (BP) (i.e., Γ is quasi-isometric to a tree).*

This is translated in Section 3 to Geometric Group Theory. As a result, we obtain in Theorem 3.6 a new characterization for a group to be virtually free which is somehow a re-writting of (BP).

By a *cycle* in a graph we mean a simple closed curve γ , i.e., a path with different vertices, except for the last one, which is equal to the first vertex. Without loss of generality we will suppose that every cycle has length at least 3. A *shortcut* in γ is a path σ joining two vertices p, q in γ such that $L(\sigma) < d_\gamma(p, q)$, where $L(\sigma)$ denotes the length of the path σ and d_γ denotes the length metric on γ . A shortcut σ in γ between p, q is *strict* if $\sigma \cap \gamma = \{p, q\}$. In this case, we say that p, q are *shortcut vertices* in γ associated with σ .

A graph Γ is (k, m) -chordal if for every cycle γ in Γ with length $L(\gamma) \geq k$, there exists a shortcut σ such that $L(\sigma) \leq m$. The graph Γ is k -chordal if we make $m = \infty$.

Date: February 9, 2022.

⁽¹⁾ Supported in part by a grant from Ministerio de Ciencia, Innovación y Universidades (PGC2018-098321-B-I00), Spain.

A graph Γ is ε -densely (k, m) -chordal if for every cycle γ in Γ with length $L(\gamma) \geq k$, there exist strict shortcuts $\sigma_1, \dots, \sigma_r$ with $L(\sigma_i) \leq m \forall i$, and such that their associated shortcut vertices define an ε -dense subset in (γ, d_γ) . The graph Γ is ε -densely k -chordal if we make $m = \infty$.

Remark 1.2. *If Γ is ε -densely (k, m) -chordal, then Γ is $\lceil \varepsilon \rceil$ -densely $(\lceil k \rceil, \lceil m \rceil)$ -chordal. Therefore, we can suppose always that $\varepsilon, k, m \in \mathbb{N}$.*

We proved that this property characterizes being quasi-isometric to a tree for graphs:

Theorem 1.3 (Corollary 3, [25]). *A graph Γ is quasi-isometric to a tree if and only if it is ε -densely (k, m) -chordal for some ε, k, m .*

A group G is *virtually free* if it has a free subgroup of finite index. There are many characterizations of being virtually free in the literature. Let us recall here some of them.

Theorem 1.4. *Let Γ be the Cayley graph of a finitely generated group G , then the following are equivalent:*

- (1) G is virtually free.
- (2) The language of all words on $S^{\pm 1}$ representing the identity is context-free, where S is a finite generating set. (Muller-Schupp's Theorem [11, 26])
- (3) G is context-free. [11, 26]
- (4) There exist $k \geq 0$ such that every closed path in Γ is k -triangulable. [26]
- (5) The ends of Γ have finite diameter. [32]
- (6) Γ admits a uniform spanning tree. [32]
- (7) Γ is quasi-isometric to a Cayley graph of a free group. [11, 15]
- (8) Γ has finite strong tree-width. [21]
- (9) G is finitely presentable and $\text{asdim}\Gamma = 1$, where $\text{asdim}\Gamma$ is the asymptotic dimension. [13, 14, 18]
- (10) There exists a generating set of G and $k \geq 0$ such that every k -locally geodesic in G is a geodesic. [16]
- (11) There exists a generating set of G such that G admits a (regular) broomlike combing with respect to the generating set. [4]
- (12) G acts on a tree with finite stabilizers. [1, 7, 19]
- (13) G is the fundamental group of a finite graph of finite groups. [1, 7, 19]
- (14) Γ is quasi-isometric to a tree. [11, 30]
- (15) Γ satisfies (BP). [23]
- (16) G admits a finite presentation by some geodesic rewriting system. [16]
- (17) G is the universal group of a finite pregroup. [31]
- (18) The monadic second-order theory of Γ is decidable. [21, 27]
- (19) G admits a Stallings section. [29]
- (20) $\bar{\Gamma}$ is polygon hyperbolic. [2]
- (21) For any finite generating set, the corresponding Cayley graph is minor excluded. [20]

For some alternative proofs of some of these see also [1, 8].

In Section 4 we translate the definition of being ε -densely (k, m) -chordal to the language of Group Theory, see Theorem 4.8. In those terms, we give a new characterization of being virtually free in Corollary 4.12 which states the following:

Theorem 1.5. *A finitely generated group G is virtually free if and only if G is (i_0, k, m) -chordal for some i_0, k, m .*

In Section 5 we analyze the example of Baumslag-Solitar groups and prove that $BS(1, n)$ is k -chordal for some k if and only if $|n| < 3$.

The word problem in the group presentation $G = \langle S | R \rangle$ consists in finding an algorithm that takes as its input a word w over S and answers if w represents the trivial element in G or not. For many groups this

problem is undecidable. A group has solvable word problem if such an algorithm exists. For details about the word problem, see [10, 22].

In Section 6 we give an application of generalized chordality to the study of the word problem for groups. In particular we obtain Theorem 6.2 which states the following:

Theorem 1.6. *Let $G = \langle S|R \rangle$ be a finite group presentation. If G is k -chordal, then $\langle S|R \rangle$ admits a recursive isoperimetric function, i.e., $\langle S|R \rangle$ has a solvable word problem.*

Moreover, we obtain that if G is k -chordal, then there is an isoperimetric function f such that $f(n) = c2^{n-k}$ for some constant c .

Some groups are known to have solvable word problem: free groups, see [10]; finitely presented residually finite groups, see [10]; hyperbolic groups, [17], among others. In particular, it is well known that the free abelian group $\langle a, b | [a, b] \rangle$ has solvable word problem, see [22]. We prove again this fact to illustrate an application of Theorem 6.2 in search of groups with solvable word problem.

2. BACKGROUND

Let $(X, d_1), (Y, d_2)$ be metric spaces, $f : X \rightarrow Y$ and $a, b > 0$. The function f is an (a, b) -quasi-isometric embedding if

$$\frac{1}{a}d_1(x, y) - b \leq d_2(f(x), f(y)) \leq ad_1(x, y) + b, \forall x, y \in X.$$

Two functions $f, g : X \rightarrow Y$ are said to be at *finite distance* if there exists $\varepsilon > 0$ such that $d_2(f(x), g(x)) < \varepsilon$ for all $x \in X$. The function f is a *quasi-isometry* if f is a quasi-isometric embedding (there exist $a, b > 0$ such that f is an (a, b) -quasi-isometric embedding) and there exists a quasi-isometric embedding $g : Y \rightarrow X$ such that $f \circ g$ and Id_Y are at finite distance and $g \circ f$ and Id_X are also at finite distance. Let $\varepsilon > 0$ be a constant. A subset $D \subseteq X$ is said to be ε -dense if given a point $x \in X$ there exists $p \in D$ such that $d_1(x, p) < \varepsilon$. It is well known that f is a quasi-isometry if and only if f is a quasi-isometric embedding and $f(X)$ is ε -dense for some $\varepsilon > 0$, see [22] for details. It is said that two metric spaces are *quasi-isometric* if there is a quasi-isometry between both of them.

Given a metric space (X, d) , a *geodesic* from x to y is an isometry $\gamma : [0, L] \rightarrow X$ such that $\gamma(0) = x$ and $\gamma(L) = y$. Abusing the notation, we will identify the geodesic γ with its image and refer to this image as a geodesic. A metric space (X, d) is *geodesic* when there is a geodesic from x to y for every pair of points $x, y \in X$. It is important to note that geodesics do not have to be unique, for convenience, $[xy]$ will denote any such geodesic.

There are several definitions of Gromov δ -hyperbolic space which are equivalent although the constant δ may appear multiplied by some constant, see [6] for details. Since we will use geodesic spaces, it is natural to use the Rips condition on the triangles. Given three points x, y, z in a geodesic space (X, d) , a geodesic γ_1 from x to y , a geodesic γ_2 from y to z and a geodesic γ_3 from z to x , the union of these geodesics is a *geodesic triangle* and will be denoted by $T = \{x, y, z\}$ or $T = \{\gamma_1, \gamma_2, \gamma_3\}$ when we want to emphasize geodesics. T is δ -thin if any side (any geodesic γ_i) of T is contained in the δ -neighborhood of the union of the two other sides. A geodesic metric space (X, d) is δ -hyperbolic if every geodesic triangle in (X, d) is δ -thin. A geodesic metric space (X, d) is *hyperbolic* if (X, d) is δ -hyperbolic for some $\delta \geq 0$.

A connected graph Γ can be interpreted as a metric space with a length metric d_Γ by considering every edge $e \in E(\Gamma)$ as isometric to the interval $[0, 1]$. Therefore, the distance between any pair of points $x, y \in \Gamma$ will be the length of the shortest path in Γ joining x and y . In this paper we will assume that every graph is locally finite and connected. Thus, every graph is a geodesic metric space.

For any vertex $v \in V(\Gamma)$ and any constant $\varepsilon > 0$, let us denote:

$$S_\varepsilon(v) := \{w \in V(\Gamma) \mid d(v, w) = \varepsilon\},$$

$$B_\varepsilon(v) := \{w \in V(\Gamma) \mid d(v, w) < \varepsilon\},$$

$$N_\varepsilon(v) := \{w \in V(\Gamma) \mid d(v, w) \leq \varepsilon\}.$$

Let G be a group generated by a subset $S \subseteq G \setminus \{e\}$ and let $S^{\pm 1} = S \cup S^{-1}$. S is a generating set if every element of G can be written as a finite product of elements in $S^{\pm 1}$. G is finitely generated if there is a finite generator set. The *Cayley graph* of G with respect to S is a graph $\Gamma = \text{Cay}(G, S)$ whose set of vertices is G and whose set of edges is $\{\{g, gs\} \mid g \in G, s \in S^{\pm 1}\}$. Given two finite generating sets S and S' of G , then $\text{Cay}(G, S)$ and $\text{Cay}(G, S')$ are quasi-isometric (via id_G), see [22] for details. A finitely generated group G is *quasi-isometric* to a metric space (X, d) if there is a quasi-isometry between Γ and (X, d) . This is well defined because it does not depend on the chosen generating sets. Hyperbolicity is a well-known invariant under quasi-isometries. Therefore, it can be said that a finitely generated group G is *hyperbolic* if some Cayley graph Γ of G is hyperbolic.

3. VERTEX SEPARATORS AND VIRTUALLY FREE GROUPS

Definition 3.1. Let G be a group generated by S . We say $P \subseteq G$ is an (a, b) -separator with respect to S if for all $s_1, \dots, s_n \in S^{\pm 1}$ such that $b = as_1 \cdots s_n$, then there exists $0 < i < n$ such that $as_1 \cdots s_i \in P$. A vertex separator with respect to S is an (a, b) -separator with respect to S for some $a, b \in G$. A minimal vertex (a, b) -separator with respect to S is an (a, b) -separator with respect to S for some $a, b \in G$ such that no proper subset is an (a, b) -separator with respect to S .

If Γ is the Cayley graph of G with respect to S and $P \subset G = V(\Gamma)$, it is immediate that P is an (a, b) -separator in Γ if and only if P is an (a, b) -separator with respect to S .

Remark 3.2. Let G be a group generated by S . The equation $b = as_1 \cdots s_n$ can be read as $a^{-1}b = s_1 \cdots s_n$. Therefore, P is an (a, b) -separator with respect to S if and only if $a^{-1}P$ is an $(e, a^{-1}b)$ -separator with respect to S .

Let G be a group generated by S and $A \subseteq G$. We denote the diameter of A (with respect to S) as $\text{diam}(A) = \sup\{d_\Gamma(x, y) \mid x, y \in A\}$. The set of vertex separators between e and the rest of elements of G will be denoted as follows.

$$\text{Sep}(G) = \{P \mid P \text{ is a minimal } (e, x)\text{-separator with respect to } S \text{ for some } x \in G \setminus \{e\}\}.$$

We denote $\mathcal{D}(G) = \sup\{\text{diam}(P) \mid P \in \text{Sep}(G)\}$.

Theorem 3.3. Let G be a group generated by S . If $\mathcal{D}(G) < \infty$, then G is virtually free.

Proof. Suppose $\mathcal{D}(G) < \infty$. Let P be a minimal vertex separator between a and b . By Remark 3.2, $a^{-1}P \in \text{Sep}(G)$ and therefore $\text{diam}(P) = \text{diam}(a^{-1}P) < \mathcal{D}(G) < \infty$. By Theorem 1.1, $\text{Cay}(G, S)$ satisfies (BP), i.e., G is virtually free. \square

The following example shows that the converse is not true.

Example 3.4. Let $G = \mathbb{Z} \times \mathbb{Z}_4$ be a group generated by $S = \{(1, 0), (0, 1)\}$. Obviously, G is virtually free. However, $P = \mathbb{Z} \times \{1\} \cup \mathbb{Z} \times \{3\}$ is a minimal separator with infinite diameter, see Figure 1.

However, Theorem 3.3 can be improved to obtain a characterization for being virtually free in terms of minimal vertex separators. The result, Theorem 3.6 below, is quite a straightforward re-writing of Manning's Bottleneck Property.

Definition 3.5. Let G be a group generated by S . We say that $\mathcal{F} = \{P_x : x \in G \setminus N_1(e)\}$ is a k -separating family with respect to S if for every $x \in G \setminus N_1(e)$:

- (1) P_x is a minimal vertex (e, x) -separator with respect to S .
- (2) There is $v \in P_x$ such that $d(v, c) \leq k$, where c is some midpoint of a geodesic $[ex]$.

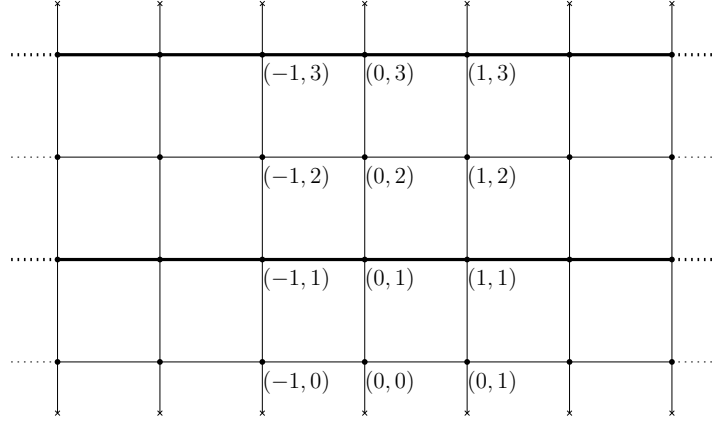

FIGURE 1. The Cayley graph of G with respect to S (the cross in vertical lines are glued). In bold the minimal vertex separator P .

From Lemma 1 in [25] it follows that for every finitely generated group there exists a $\frac{1}{2}$ -separating family and, therefore, a k -separating family for every $k \geq \frac{1}{2}$.

Given a k -separating family \mathcal{F} , we denote $\mathcal{D}(\mathcal{F}) = \sup\{\text{diam}(P) \mid P \in \mathcal{F}\}$ and

$$\hat{\mathcal{D}}(G) = \inf\{\mathcal{D}(\mathcal{F}) \mid \mathcal{F} \text{ is a } k\text{-separating family for some } k > 0\}.$$

Theorem 3.6. *Let G be a group generated by S . The group G is virtually free if and only if $\hat{\mathcal{D}}(G) < \infty$.*

Proof. Suppose that $\hat{\mathcal{D}}(G) < \infty$. Then there is a k -separating family, \mathcal{F} , such that $D = \sup\{\text{diam}(P_x) \mid P_x \in \mathcal{F}\} < \infty$. We claim that $\Gamma = \text{Cay}(G, S)$ satisfies (BP).

Consider an element $x \in G \setminus N_1(e)$ and a midpoint $m \in \Gamma = \text{Cay}(G, S)$ such that $d_\Gamma(x, m) = d_\Gamma(e, m) = \frac{1}{2}d_\Gamma(e, x)$.

If $d_\Gamma(e, x) = 2$, then (BP) is trivial. Suppose $d_\Gamma(e, x) > 2$. Then, there is some vertex $v \in P_x$ such that $d_\Gamma(v, m) \leq k$. Thus, since every ex -path contains a vertex in P_x and $\text{diam}(P_x) \leq D$, then every ex -path intersects $N_D(v) \subset N_{D+k}(m)$. Hence, (BP) is satisfied and therefore G is virtually free.

Suppose that G is virtually free. Then, (BP) is satisfied with some constant $\Delta > 0$. Thus, for every $x \in G \setminus N_1(e)$ and every midpoint $m \in \Gamma$ such that $d_\Gamma(x, m) = d_\Gamma(e, m) = \frac{1}{2}d_\Gamma(e, x)$, every ex -path intersects $N_\Delta(m)$. Pick a vertex $v_x \in N_{\frac{\Delta}{2}}(m)$, then $V(\Gamma) \cap N_{\Delta+\frac{\Delta}{2}}(v_x)$ contains a minimal (e, x) -separator P_x . The family $\mathcal{F} = \{P_x : x \in G \setminus N_1(e)\}$ is a $\frac{1}{2}$ -separating family with respect to S such that $\mathcal{D}(\mathcal{F}) \leq 2\Delta + 1$. Thus, $\hat{\mathcal{D}}(G) \leq \mathcal{D}(\mathcal{F}) < \infty$. \square

4. CHORDALITY ON GROUPS

Definition 4.1. *Let G be a group generated by S , $n > 2$ and $s_1, \dots, s_n \in S^{\pm 1}$. We say that $s_1 \cdots s_n = e$ is a simple relation in $S^{\pm 1}$ when*

$$s_p s_{p+1} \cdots s_{q-1} s_q = e \text{ if and only if } (p, q) = (1, n)$$

Remark 4.2. *Let γ be a cycle in Γ defined by $g_0, \dots, g_n = g_0$, then $u_1 \cdots u_n = e$ is a simple relation in $S^{\pm 1}$ where $u_k = g_{k-1}^{-1} g_k$, $k \in \{1, \dots, n\}$. On the other hand, if $s_1 \cdots s_n = e$ is a simple relation in $S^{\pm 1}$, then $g_0 = e$, $g_k = s_1 \cdots s_k$, $k \in \{1, \dots, n\}$, defines a cycle in Γ .*

Definition 4.3. *Let G be a group generated by S and $k, m \in \mathbb{N}$. We say that G is (k, m) -chordal with respect to S if for every simple relation $s_1 \cdots s_n = e$ in $S^{\pm 1}$ with $n \geq k$, then there exist $s'_1, \dots, s'_r \in S^{\pm 1}$ such that $s_i \cdots s_j = s'_1 \cdots s'_r$ with $r \leq \min\{m, j - i, n - j + i - 2\}$ for some $1 \leq i < j \leq n$. We say that G is k -chordal if we make $m = \infty$.*

By Remark 4.2, it is easy to check that a group is (k, m) -chordal with respect to S if and only if the Cayley graph Γ is (k, m) -chordal.

Remark 4.4. *A group G is $(k, 1)$ -chordal if for every simple relation $s_1 \cdots s_n = e$ in $S^{\pm 1}$ with $n \geq k$, then there exists $s \in S^{\pm 1}$ such that $s_i \cdots s_j = s$ for some $1 \leq i < j \leq n$ with $j - i < n - 2$.*

In [25] we proved the following:

Theorem 4.5. *If Γ is a $(k, 1)$ -chordal graph, then Γ is quasi-isometric to a tree.*

By Theorems 4.5 and 1.4 it is immediate the following:

Corollary 4.6. *Let G be a finitely generated group. If G is $(k, 1)$ -chordal, then G is virtually free.*

Definition 4.7. *Let G be a group generated by S and $i_0, k, m \in \mathbb{N}$. We say that G is (i_0, k, m) -chordal with respect to S if for every simple relation $s_1 \cdots s_n = e$ in $S^{\pm 1}$ with $n \geq k$, then there exist $s'_1, \dots, s'_r \in S^{\pm 1}$ such that $s_i \cdots s_j = s'_1 \cdots s'_r$ with $r \leq \min\{m, j - i, n - j + i - 2\}$ for some $1 \leq i \leq i_0$ and $i < j \leq n$. We say that G is $[i_0, k]$ -chordal if we make $m = \infty$.*

Theorem 4.8. *Let G be a group generated by S , $\Gamma = \text{Cay}(G, S)$ the Cayley graph and $k, m > 0$. Then, Γ is ε -densely (k, m) -chordal for some $\varepsilon > 0$ if and only if G is (i_0, k, m) -chordal with respect to S for some $i_0 > 0$.*

Proof. Let G be a group generated by S and suppose that the Cayley graph Γ is ε -densely (k, m) -chordal for some $\varepsilon, k, m \in \mathbb{N}$. Let $s_1 \cdots s_n = e$ be a simple relation in $S^{\pm 1}$ with $n \geq k$ and consider $i_0 = 2\varepsilon$. Then, define the cycle γ by $g_0 = e$, $g_l = s_1 \cdots s_l \forall l \in \{1, \dots, n\}$. Since $L(\gamma) = n \geq k$, then there exist strict shortcuts $\sigma_1, \dots, \sigma_t$ with $L(\sigma_i) \leq m \forall i$, and such that their associated shortcut vertices define an ε -dense subset in (γ, d_γ) . Therefore, there exists a shortcut σ_λ with $r = L(\sigma_\lambda) \leq m$ and associated shortcut vertices g_{i-1}, g_j , $i < j$, such that $1 \leq i \leq 2\varepsilon = i_0$. Since σ_λ is a path from g_{i-1} to g_j , then there exist $s'_1, \dots, s'_r \in S^{\pm 1}$ such that σ_λ is the path defined by $h_0 = g_{i-1}$, $h_l = g_{i-1}s'_1 \cdots s'_l$, $\forall l \in \{1, \dots, r\}$ where $r \leq \min\{j - i, n - j + i - 2\}$. Note that

$$g_{i-1}s_i \cdots s_j = g_j = h_r = g_{i-1}s'_1 \cdots s'_r$$

Thus, $s_i \cdots s_j = s'_1 \cdots s'_r$ with $r \leq \min\{m, j - i, n - j + i - 2\}$ with $i \leq i_0$ and G is (i_0, k, m) -chordal.

Reciprocally, suppose that G is (i_0, k, m) -chordal with respect to S for some $i_0, k, m \in \mathbb{N}$. Let γ be a cycle in Γ with length $L(\gamma) = n \geq k$ and let $\varepsilon = i_0$.

Fix a point $q \in \gamma$ and suppose p, p' two adjacent vertices such that $q \in [pp']$ and $q \neq p'$. Let us label the ordered vertices in γ as $g_0, \dots, g_n = g_0$ so that $p = g_0$ and $p' = g_1$. If we define $s_l = g_{l-1}^{-1}g_l$, $l \in \{1, \dots, n\}$, then $s_1 \cdots s_n = e$ is a simple relation. By hypothesis, there exist $i, j, r \in \mathbb{N}$, $s'_1, \dots, s'_r \in S^{\pm 1}$ such that $s_i \cdots s_j = s'_1 \cdots s'_r$ with $r \leq \min\{m, j - i, n - j + i - 2\}$ for some $1 \leq i \leq i_0$ and $i < j \leq n$. Let σ be the path defined by the vertices $h_0 = g_{i-1}$, $h_l = g_{i-1}s'_1 \cdots s'_l$, $l \in \{1, \dots, r\}$. Since $h_r = g_{i-1}s'_1 \cdots s'_r = g_{i-1}s_i \cdots s_j = g_j$ and $L(\sigma) = r \leq \min\{j - i, n - j + i - 2\} = d_\gamma(g_{i-1}, g_j)$, then σ contains an strict shortcut σ_0 with an associated shortcut vertex g_{i-1} . Since $q \in [g_0g_1]$, $d_\gamma(q, g_{i-1}) < i_0 = \varepsilon$ and $L(\sigma_0) \leq L(\sigma) = r \leq m$. \square

Remark 4.9. *In fact, from the proof we obtain that if Γ is ε -densely (k, m) -chordal, then G is $(2\varepsilon, k, m)$ -chordal. On the other hand, if G is (i_0, k, m) -chordal, then Γ is i_0 -densely (k, m) -chordal.*

Remark 4.10. *Theorem 4.8 remains true for $m' = m = \infty$.*

Hence, by Theorem 1.3, we get the following corollary.

Corollary 4.11. *A finitely generated group G is quasi-isometric to a tree if and only if G is (i_0, k, m) -chordal, for some i_0, k, m .*

Thus, by Theorem 1.4, we obtain the following result.

Corollary 4.12. *A finitely generated group G is virtually free if and only if G is (i_0, k, m) -chordal, for some i_0, k, m .*

Let us recall also the following results.

Theorem 4.13 (Theorem 4, [24]). *If a graph Γ is ε -densely (k, m) -chordal, then Γ is δ -hyperbolic with $\delta \leq \max\{\frac{k}{4}, \varepsilon + m\}$.*

Theorem 4.14 (Theorem 8, [24]). *If a graph Γ is δ -hyperbolic, then Γ is ε -densely k -chordal, with $\varepsilon = 2\delta + 1$ and $k = 4\delta + 3$.*

By Theorems 4.8, 4.13 and 4.14 we obtain also the following results.

Corollary 4.15. *If a finitely generated group G is (i_0, k, m) -chordal, then G is δ -hyperbolic, with $\delta \leq \max\{\frac{k}{4}, m + i_0\}$.*

Corollary 4.16. *If a finitely generated group G is δ -hyperbolic, then G is $[4\delta + 2, 4\delta + 3]$ -chordal.*

Many groups may satisfy being k -chordal. Let us see some examples.

Proposition 4.17. \mathbb{Z}^2 is 5-chordal.

Proof. Let γ be a cycle with length $L(\gamma) \geq 5$ and consider a simple relation $s_1 \cdots s_n = e$ associated with γ in the sense of Remark 4.2. Suppose without loss of generality that $s_1 = a$, then there is $1 < i < n$ such that $s_1 = \dots = s_{i-1} = a$ and $s_i = b^\varepsilon$, where $\varepsilon \in \{-1, 1\}$. Now, consider $i < j < n$ such that $s_i = \dots = s_{j-1} = b^\varepsilon$ and $s_j = a$ or $s_j = a^{-1}$. Since γ is a cycle, we can assume, by relabelling if necessary, that $s_j = a^{-1}$. If we denote $q = \varepsilon(j - i)$, $r = |q|$ and $s'_1 = \dots = s'_r = b^\varepsilon$, then we get the following equality, see Figure 2.

$$s_{i-1}s_i \cdots s_{j-1}s_j = ab^qa^{-1} = b^q = s'_1 \cdots s'_r$$

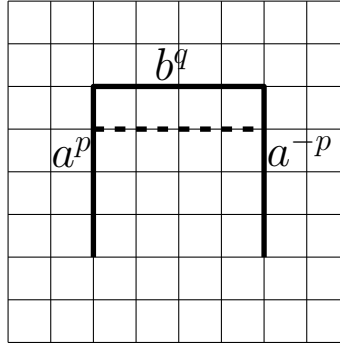

FIGURE 2. Shortcut $ab^qa^{-1} = b^q$.

Obviously $r < j - (i - 1)$. If $s'_1 \cdots s'_r$ defines a shortcut, we are done. Otherwise, if $r > n - j + (i - 1) - 2$, then γ is defined by $s_1 = a$, $s_2 = \dots = s_{r+1} = b^\varepsilon$, $s_{r+2} = a^{-1}$, $s_{r+3} = \dots = s_n = b^{-\varepsilon}$, therefore $s_1 \cdots s_n = ab^qa^{-1}b^{-q} = e$. If we denote $s'_1 = a^{-1}$, then we get the following equality, see Figure 3.

$$s_{r+1}s_{r+2}s_{r+3} = b^\varepsilon a^{-1} b^{-\varepsilon} = a^{-1} = s'_1$$

Since $L(\gamma) \geq 5$, then $|q| > 1$ and therefore s'_1 is a shortcut. □

In the general case, since n -hypercubes are Hamiltonian graphs, we conjecture that \mathbb{Z}^n is $(2^n + 1)$ -chordal, where 2^n is the number of vertices of an n -hypercube.

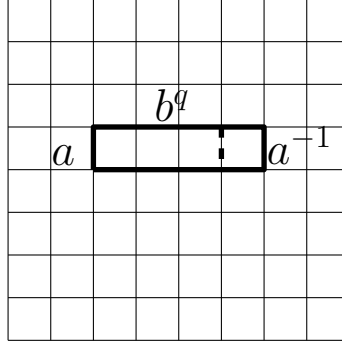
FIGURE 3. Shortcut $b^\varepsilon a^{-1} b^{-\varepsilon} = a^{-1}$.5. BAUMSLAG-SOLITAR GROUPS $BS(1, n)$

Definition 5.1. For integers m, n , the Baumslag-Solitar group is defined by following presentation:

$$BS(m, n) = \langle a, b \mid ba^m b^{-1} = a^n \rangle$$

We will focus on $G_n := BS(1, n)$, $n > 0$. Let Γ_n denote the corresponding Cayley 2-complex built from rectangles homeomorphic to $[0, 1] \times [0, 1]$, with both vertical sides labelled by b upward, the top horizontal side labelled by an a to the right, and the bottom horizontal side split into n edges each labelled by a to the right. See Figure 4.

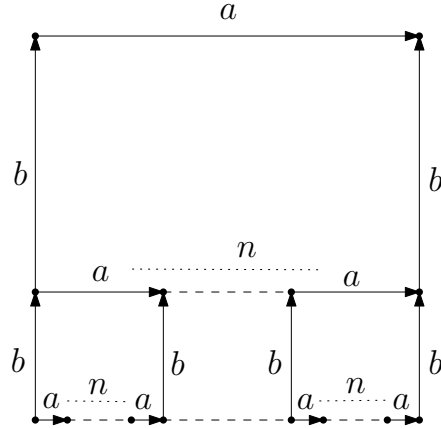
FIGURE 4. One part of the standard Cayley graph of G_n

Let T_n be a Cantor tree where each vertex, besides having n sons, has a father. Let us denote the horizontal projection as $\pi_n : \Gamma_n \rightarrow T_n$, see Figure 5. More details can be found in [12].

Proposition 5.2. Given $s, t \in \mathbb{N}$ and $\varepsilon, k, m > 0$ the following properties are equivalent.

- (1) $BS(s, t)$ is ε -densely (k, m) -chordal.
- (2) $BS(-s, t)$ is ε -densely (k, m) -chordal.
- (3) $BS(s, -t)$ is ε -densely (k, m) -chordal.
- (4) $BS(-s, -t)$ is ε -densely (k, m) -chordal.
- (5) $BS(t, s)$ is ε -densely (k, m) -chordal.
- (6) $BS(-t, s)$ is ε -densely (k, m) -chordal.

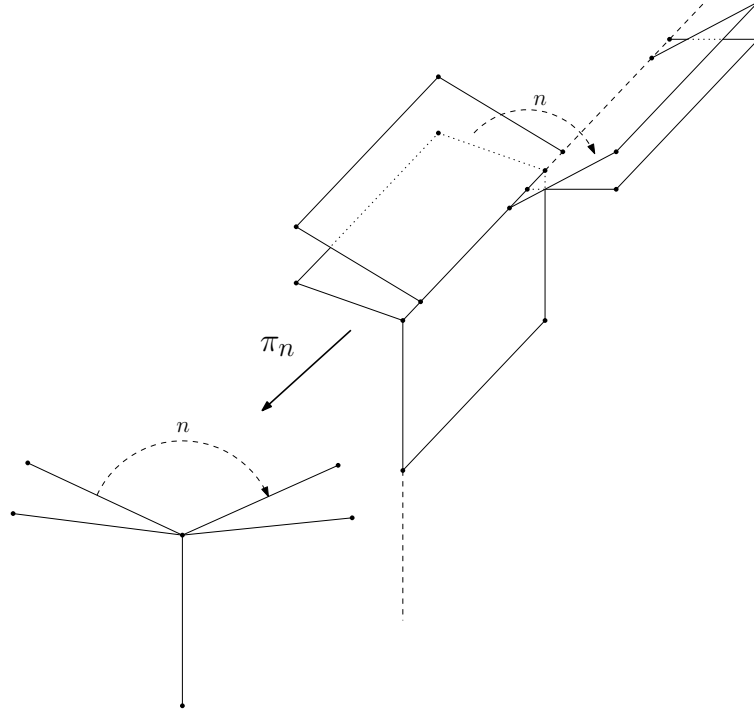
 FIGURE 5. The Cayley graph of G_n projected onto the Cantor tree T_n

- (7) $BS(t, -s)$ is ε -densely (k, m) -chordal.
 (8) $BS(-t, -s)$ is ε -densely (k, m) -chordal.

Proof. The corresponding Cayley 2-complex of the groups $BS(s, t)$, $BS(-s, t)$, $BS(s, -t)$ and $BS(-s, -t)$ are the same except for the orientation of some labels on the edges. Therefore, these groups have Cayley graphs quasi-isometric, providing the proof of (1) \Leftrightarrow (2) \Leftrightarrow (3) \Leftrightarrow (4).

Since the corresponding Cayley 2-complex of $BS(t, s)$ is a 180° rotation of the corresponding Cayley 2-complex of $BS(s, t)$, these groups have Cayley graphs quasi-isometric, providing the proof of (1) \Leftrightarrow (5).

The rest of equivalences are deduced by exchanging the role of the variables s, t . \square

Let us denote in G_n as a -edges the edges labelled by a and b -edges labelled by b .

Definition 5.3. Given $\omega = a^{\alpha_1} b^{\beta_1} \dots a^{\alpha_k} b^{\beta_k} \in G_n$ we say that $h_n(\omega) = \sum_i \beta_i$ is the height of ω . Given p any vertex in T_n we denote $\tilde{h}_n(p) = h_n(\omega)$ for some $\omega \in G_n$ such that $\pi_n(\omega) = p$. Also, given a b -edge $e = \{v, w\} \in G_n$, let $h_n(e) := \max\{h_n(v), h_n(w)\}$.

Remark 5.4. If $\omega_1, \omega_2 \in G_n$ are two points such that $\pi_n(\omega_1) = \pi_n(\omega_2)$, then $h_n(\omega_1) = h_n(\omega_2)$, i.e., $\tilde{h}_n(p)$ is well defined.

Given a vertex $q \in T_n$, let us define:

$$L_q := \{x \in \Gamma_n \mid d_{T_n}(\pi_n(x), q) = h_n(x) - \tilde{h}_n(q)\}.$$

Given $\omega \in L_q$, there is $\tilde{\omega} \in \pi_n^{-1}(q)$ such that $\tilde{\omega} b^{h(\omega) - h(\tilde{\omega})} = \omega$. We will consider $p_q : L_q \rightarrow \pi_n^{-1}(q)$ the vertical projection $p_q(\omega) = \tilde{\omega}$ and we will consider an order in $\pi_n^{-1}(q)$ where $x < y$ if $y = xa^\lambda$ for some $\lambda > 0$. See Figure 6.

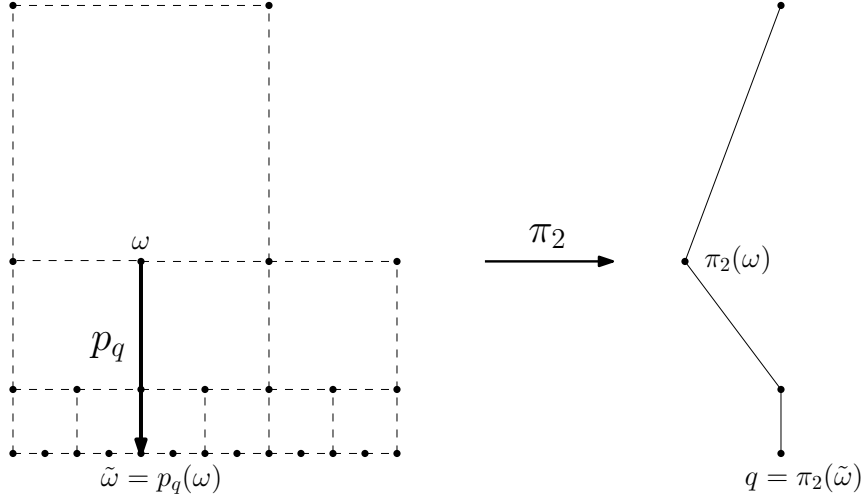
FIGURE 6. The projections p_q and π_n .

Definition 5.5. Given $x, y \in \Gamma_n$ we denote the geodesic path in T_n from $\pi_n(x)$ to $\pi_n(y)$ as $\tilde{\sigma}_n(x, y)$. We say that the point $q \in \tilde{\sigma}_n(x, y)$ such that $\tilde{h}_n(q) = \min \tilde{h}_n(\tilde{\sigma}_n(x, y))$ is the branching point between x and y .

Remark 5.6. Let $x, y \in \Gamma_n$ and γ be a path between x and y . If $q \in T_n$ is the branching point between x and y , then $\gamma \cap \pi_n^{-1}(q) \neq \emptyset$.

Definition 5.7. Let γ be a path in Γ_n between two vertices $x, y \in V(\Gamma_n)$. Suppose that γ is defined by the vertices $x_0 = x, x_i = x s_1 \cdots s_i$ for $i = 1, \dots, m$. We define the horizontal length of γ as follows:

$$H(\gamma) = |\{i \in \{1, \dots, m\} : \exists \varepsilon \in \{-1, 1\}, s_i = a^\varepsilon\}|.$$

Notice that given two vertices in G_n , the horizontal length is not an invariant on the geodesics joining them as the following example shows.

Example 5.8. In G_3 , a geodesic defined by a^3 and a geodesic defined by bab^{-1} connect the same pair of vertices but they do not have the same horizontal length. See Figure 7.

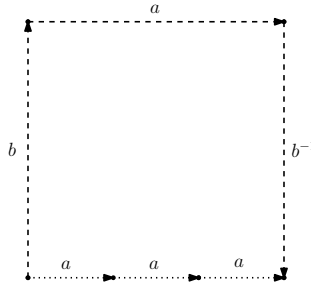
FIGURE 7. The geodesic given by a^3 has horizontal length 3 and the geodesic given by bab^{-1} has horizontal length 1.

Lemma 5.9. If σ is a geodesic in G_2 , then σ does not contain three b -edges e_1, e_2, e_3 with $h_n(e_1) = h_n(e_2) = h_n(e_3)$.

Proof. Consider that the geodesic σ is defined by the vertices v_0, v_1, \dots, v_n and let $s_i = v_{i-1}^{-1}v_i$ for every $1 \leq i \leq n$. Suppose that there exist three b -edges $e_1 = \{v_i, v_{i+1}\}, e_2 = \{v_j, v_{j+1}\}, e_3 = \{v_k, v_{k+1}\}$ with $i < j < k$ and $h_n(e_i) = h_n(e_j)$ for every $1 \leq i, j \leq 3$. Let us assume that these edges are consecutive with this property. Therefore, if $v_{i+1} = v_i b$, then $v_{j+1} = v_j b^{-1}$ and $v_{k+1} = v_k b$, and if $v_{i+1} = v_i b^{-1}$, then $v_{j+1} = v_j b$ and $v_{k+1} = v_k b^{-1}$.

Case 1. Suppose $v_{i+1} = v_i b$. Then, it is immediate to check that

$$v_i s_{j+2} \cdots s_k b s_{i+2} \cdots s_j = v_{k+1}$$

(notice that it has the same b -edges and a -edges with the same orientations at the same heights) and this defines a shortcut (two edges shorter) in σ between v_i and v_{k+1} leading to contradiction since σ is geodesic. See Figure 8.

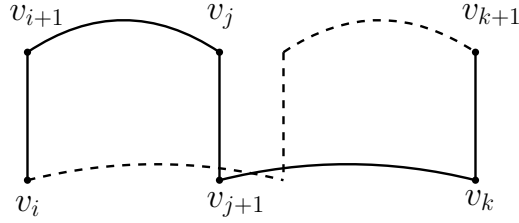

FIGURE 8. A shortcut in dashed line for Case 1.

Case 2. Suppose $v_{i+1} = v_i b^{-1}$. Then, it is immediate to check that

$$v_i s_{j+2} \cdots s_k b^{-1} s_{i+2} \cdots s_j = v_{k+1}$$

and this defines a shortcut (two edges shorter) in σ between v_i and v_{k+1} leading to contradiction. See Figure 9.

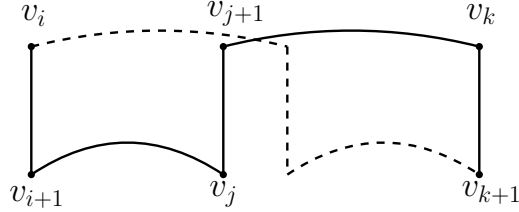

FIGURE 9. A shortcut in dashed line for Case 2.

□

Theorem 5.10. *The group G_2 is 6-chordal with respect to $\{a, b\}$.*

Proof. Let γ be a cycle in Γ_2 with length $L(\gamma) \geq 6$.

Case 1. Suppose that there are four consecutive vertices x_i with $1 \leq i \leq 4$ in γ such that $x_2 = x_1 b$, $x_3 = x_2 a$ and $x_4 = x_3 b^{-1}$. Then, $v_1 = x_1 a$, $v_2 = x_1 a^2 = x_4$ defines a shortcut between x_1 and x_4 and we are done.

Case 2. Suppose, otherwise, that there are not such four consecutive vertices. Consider $M = \max_{v \in V(\gamma)} \{h_2(v)\}$, $m = \min_{v \in V(\gamma)} \{h_2(v)\}$, $q_m \in \pi_2(\gamma)$ such that $\tilde{h}_2(q_m) = m$ and the vertical projection $p := p_{q_m} : L_{q_m} \rightarrow \pi^{-1}(q_m)$. Let us denote $V_q = V(\gamma) \cap \pi_2^{-1}(q)$ for some $q \in T_2$. Then, since there exists at least one a -edge $e = \{v, w\}$ with $h_2(v) = h_2(w) = M$ and we are not in case 1, there exist three consecutive vertices in the cycle $x_0, x, x_1 \in h_2^{-1}(M)$ with $p(x_0) < p(x) < p(x_1)$, i.e., $x_0 = x a^{-1}$, $x_1 = x a$. Since γ is a cycle, then

$$P = \{z \in \gamma \mid p(x) = p(z) \text{ and } \pi_2(x) \neq \pi_2(z)\} \neq \emptyset,$$

where z need not be a vertex.

Let $y \in P$ be such that $d_\gamma(x, y) = \min_{v \in P} d_\gamma(x, v)$ and we will consider that γ_y is the shortest path in the cycle γ that joins x and y . Fix $q_0 \in T_2$ the branching point between x and y and $m_0 = \tilde{h}_2(q_0)$.

Case 2a. Suppose that $y \in V(\gamma)$. Then x, y are in the same plane and $h_2(y) = m_0$. Thus, the vertical path from x to $xb^{-(M-m_0)} = y$ defines a shortcut between x and y .

Case 2b. Suppose that $y \notin V(\gamma)$. We can suppose that y is in an horizontal edge with vertices y_0, y_1 , see Figure 10. Suppose without loss of generality that $x_1, y_1 \in \gamma_y$.

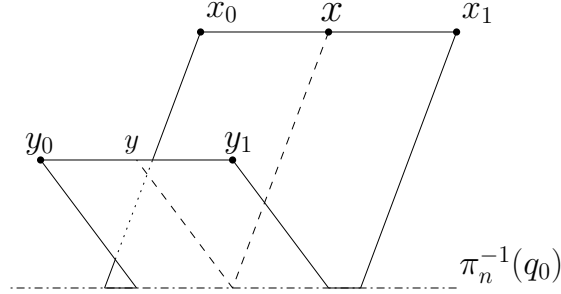

FIGURE 10. Case 2b.

If γ_y is not a geodesic, since it is the shortest path in the cycle, then there is a shortcut between x and y and we are done. Suppose, otherwise that γ_y is a geodesic. Then, by Lemma 5.9, there are not three b -edges in γ_y with the same height.

Suppose γ_y is defined by the vertices $x_1 = v_0, v_1, \dots, v_n = y_1$ and let $s_i = v_{i-1}^{-1}v_i$ for every $1 \leq i \leq n$.

Case 2b(i). Suppose $h_2(y) = h_2(x)$. Then, since $x_1s_2 \cdots s_n = y_1$ it is immediate to check that $xs_2 \cdots s_n = y_0$ (it has the same a -edges and b -edges with the same orientations at the same heights) and $d_\Gamma(x, y) \leq n - 1 + d_\Gamma(y_0, y) < n < L(\gamma_y)$ leading to contradiction since γ_y is a geodesic.

Case 2b(ii). Suppose $h_2(y) < h_2(x)$. Since there are not three b -edges in γ_y with the same height, it is immediate to see that all vertices in $\gamma_y \cap \pi^{-1}(q_0)$ must be consecutive. Also, since $b^{-1}a^kb = ab^{-1}a^{k-2}b$ and $b^{-1}a^{-k}b = a^{-1}b^{-1}a^{-k+2}b$ for every $2 \leq k \in \mathbb{Z}$ it is readily seen that $\gamma_y \cap \pi^{-1}(q_0)$ is a single edge, $\{v_i, v_{i+1}\}$ for some $0 < i < n$ (otherwise, these relations allow a shortcut in γ_y leading to contradiction).

Since $h_2(x_1) = M = \max_{v \in V(\gamma)} \{h_2(v)\}$ and there are not three b -edges in γ_y with the same height it follows that all b -edges $\{v_j, v_{j+1}\}$ with $j < i$ satisfy that $v_{j+1} = v_jb^{-1}$.

Also, let us see that all b -edges $\{v_j, v_{j+1}\}$ with $j > i$ satisfy that $v_{j+1} = v_jb$. Suppose otherwise that $v_{j+1} = v_jb^{-1}$ for some $j > i$. If $h_2(v_j) \leq h_2(y_1)$ then necessarily there must be three b -edges with the same height leading to contradiction with Lemma 5.9. If $h_2(y_1) < h_2(v_j) \leq h_2(x_1)$, then there are at least three b -edges with height $h_2(y_1) + 1$, one between $x_1 = v_0$ and v_i , one between v_i and v_j and one between v_j and $v_n = y_1$, leading to contradiction.

Therefore, $L(\gamma_y) = H(\gamma_y) + h_2(x_1) + h_2(y_1) - 2m_0$.

Let us build a new geodesic σ from x to y as follows. For each a -edge $\{v_j, v_{j+1}\}$ with $j > i$ and $v_{j+1} = v_ja^\varepsilon$ with $\varepsilon \in \{-1, 1\}$, consider any vertex v_k with $k < i$ such that $h_2(v_k) = h_2(v_j)$. Then it is readily seen that the path $xs_1 \cdots s_ka^\varepsilon s_{k+1} \cdots s_js_{j+2} \cdots s_n$ is also a path from x to y_1 with the same length as the restriction of γ_y joining x to y_1 . Therefore, repeating this change for every a -edge between the lowest a -edge and y_1 , we build a path σ from x to y such that $L(\sigma) = L(\gamma_y)$ and such that if $V(\sigma) \cap \pi_2^{-1}(q_m) = \{w_r, w_{r+1}\}$, $w_{s+1} = w_sb$ for every $s > r$, this is, σ is a path that after its lowest a -edge is just a vertical geodesic. Since γ_y is a geodesic, σ is also a geodesic from x to y containing x_1 and y_1 .

Let $l = h_2(x) - h_2(y)$. Then, let $z = xb^{-l}a$. By construction, notice that $p(y_1) < p(z) < p(x_1)$. If there is a vertex $w \neq x$ in σ such that $p(w) = p(x)$ then the vertical geodesic from x to w is a shortcut in σ leading to contradiction. Otherwise, there is a vertex w in σ such that $p(w) = p(z)$, see Figure 11.

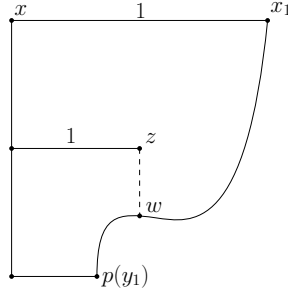

FIGURE 11. If there is no vertex $w \neq x$ in σ with $p(w) = p(x)$, then there is a vertex w in σ with $p(w) = p(z)$.

However, the path defined by $x, xb^{-1}, \dots, xb^{-l}, xb^{-l}a = z$ followed by the vertical geodesic from z to w has length $h_2(x) - h_2(w) + 1$ and is strictly shorter than the restriction of σ . Thus, this defines a shortcut in σ leading to contradiction. \square

By Proposition 5.2 and Theorem 5.10, we get the following result.

Corollary 5.11. *The groups $BS(1, 2)$, $BS(-1, 2)$, $BS(1, -2)$, $BS(-1, -2)$, $BS(2, 1)$, $BS(-2, 1)$, $BS(-2, -1)$ and $BS(-2, -1)$ are 6-chordal with respect to $\{a, b\}$.*

Lemma 5.12. *Let $n > 2$ and $x, y \in V(\Gamma_n)$. If there exists $k, k' \in \mathbb{N}$ such that $\tilde{x} = xb^k$, $\tilde{y} = yb^{k'}$ and $\tilde{y} = \tilde{x}a$, then there is a geodesic σ between x and y such that $\tilde{x}, \tilde{y} \in \sigma$.*

Proof. Let us denote σ the path between x and y defined by $b^k ab^{-k'}$. Then $L(\sigma) = k + k' + 1$. Let σ' be other path between x and y . Denote $h = \max\{h_n(x) : x \in \sigma\}$ and $h' = \max\{h_n(x') : x' \in \sigma'\}$.

If $h' \geq h$, then $L(\sigma') \geq h' - h_n(x) + h' - h_n(y) + H(\sigma') \geq k + k' + 1 = L(\sigma)$.

Suppose otherwise $h' < h$, then $n^{h-h'} + 2h' - h_n(x) - h_n(y) \leq L(\sigma')$. Since $n > 2$, then $2x + 1 \leq n^x$ for all $x \geq 1$. Therefore $2(h - h') + 1 \leq n^{h-h'}$.

$$\begin{aligned} 2h + 1 &\leq n^{h-h'} + 2h' \\ 2h - h_n(x) - h_n(y) + 1 &\leq n^{h-h'} + 2h' - h_n(x) - h_n(y) \\ L(\sigma) &\leq n^{h-h'} + 2h' - h_n(x) - h_n(y) \leq L(\sigma') \\ L(\sigma) &\leq L(\sigma') \end{aligned}$$

\square

Theorem 5.13. *G_n is not k -chordal with respect to $\{a, b\}$ for every $n > 2$, $k > 0$.*

Proof. Fix $N > 1$. Let us define the cycle γ_N by its vertices as follow. $x_0 = e$, $x_1 = a$, $x_2 = ab$, ..., $x_{N+1} = ab^N$, $x_{N+2} = ab^N a$, $x_{N+3} = ab^N ab^{-1}$, ..., $x_{2N+2} = ab^N ab^{-N}$, $x_{2N+3} = ab^N ab^{-N} a^{-1}$, $x_{2N+4} = ab^N ab^{-N} a^{-1} b$, ..., $x_{3N+3} = ab^N ab^{-N} a^{-1} b^N$, $x_{3N+4} = ab^N ab^{-N} a^{-1} b^N a^{-1}$, $x_{3N+5} = ab^N ab^{-N} a^{-1} b^N a^{-1} b^{-1}$, ..., $x_{4N+4} = ab^N ab^{-N} a^{-1} b^N a^{-1} b^{-N} = x_0$. See Figure 12.

Claim. γ_N has not shortcuts.

Let $x_i, x_j \in V(\gamma)$. Denote $L_1 = \{1, \dots, N + 1\}$, $L_2 = \{N + 2, \dots, 2N + 2\}$, $L_3 = \{2N + 3, \dots, 3N + 3\}$, $L_4 = \{3N + 4, \dots, 4N + 4\}$, $O = \pi_n(e)$.

Case 1. Suppose $i, j \in L_m$ for $m \in \{1, 2, 3, 4\}$. Since $p_O(x_i) = p_O(x_j)$, then γ_N defines a vertical geodesic between x_i and x_j . Therefore, there is not a shortcut between x_i and x_j .

Case 2. Suppose $i \in L_1, j \in L_2$ (or $i \in L_3, j \in L_4$). By Lemma 5.12, γ_N defines a geodesic between x_i and x_j and therefore there is not a shortcut between x_i and x_j .

Case 3. Suppose $i \in L_1, j \in L_3$ (or $i \in L_2, j \in L_4$). Let σ be a path between x_i and x_j . Suppose without loss of generality that $h_n(x_i) \geq h_n(x_j)$. Denote $h = \max\{h_n(x) : x \in \sigma\}$.

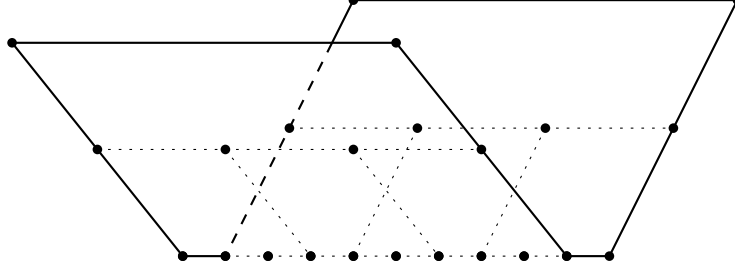
FIGURE 12. Example of γ_2 in G_3

If $h \geq N$, then $L(\sigma) \geq h_n(x_j) + h + (h - h_n(x_i)) + H(\sigma) \geq 2h + 2 + h_n(x_j) - h_n(x_i) \geq 2N + 2 + h_n(x_j) - h_n(x_i) = d_{\gamma_N}(x_i, x_j)$.

Otherwise, let us assume $h < N$. On one side $n^{N-h} + 1 \leq H(\sigma)$, on the other hand the number of edges in σ labelled by b is at least $H = h_n(x_i) + h_n(x_j) + 2(h - h_n(x_i))$, therefore $n^{N-h} + 1 + H \leq L(\sigma)$. Since $n > 2$, then $2x + 1 \leq n^x$ for all $x \geq 1$. Therefore $2(N - h) + 1 \leq n^{N-h}$.

$$\begin{aligned} 2(N - h) + 2 + H &\leq n^{N-h} + 1 + H \\ d_{\gamma_N}(x_i, x_j) = 2(N - h) + 2 + H &\leq n^{N-h} + 1 + H \leq L(\sigma) \\ d_{\gamma_N}(x_i, x_j) &\leq L(\sigma) \end{aligned}$$

Thus, there is not a shortcut between x_i and x_j .

Case 4. Suppose $i \in L_1, j \in L_4$ (or $i \in L_2, j \in L_3$). In this case, if σ is a path between x_i and x_j , then $H(\sigma) > 0$ and $L(\sigma) \geq h_n(x_i) + h_n(x_j) + H(\sigma) \geq h_n(x_i) + h_n(x_j) + 1 = d_{\gamma_N}(x_i, x_j)$

Therefore, σ is not a shortcut, and the proof of the claim is finished.

Suppose that G_n is k -chordal for some $k > 0$. Then γ_k has a shortcut, which contradicts the claim. \square

6. WORD PROBLEM

Let S be a finite set, $F(S)$ the free group generated by S and $R \subseteq F(S)$ a finite set. We consider a finite group presentation $G = \langle S | R \rangle$. We will denote $a =_H b$ the equality $a = b$ in the group H , for example, two different relators $r_1, r_2 \in R$ are equal in G , i.e., $r_1 =_G r_2$, but they are not equal in $F(S)$, i.e., $a \neq_{F(S)} b$. Let $\omega \in F(S)$ be such that $\omega =_G e$. The *area* of ω is defined as follows:

$$A(\omega) = \min\{m \mid \omega =_{F(S)} u_1 r_1^{\varepsilon_1} u_1^{-1} \cdots u_m r_m^{\varepsilon_m} u_m^{-1}, u_i \in F(S), r_i \in R, \varepsilon_i \in \{-1, 1\}\}$$

The *Dehn function* of the presentation $\langle S | R \rangle$ is defined as follow:

$$\text{Dehn}(n) = \max\{A(\omega) \mid \omega \in \langle\langle R \rangle\rangle, |\omega| \leq n\},$$

where $\langle\langle R \rangle\rangle = \{\prod_{i=1}^M u_i r_i^{\varepsilon_i} u_i^{-1} \mid M \in \mathbb{N}, u_i \in F(S), r_i \in R, \varepsilon_i \in \{-1, 1\}\}$. See [28].

A function $f : \mathbb{N} \rightarrow \mathbb{R}$ is an *isoperimetric function* for the presentation $\langle S | R \rangle$ if it is a non-decreasing function such that $\text{Dehn} \leq f$.

Theorem 6.1 (Theorem 1.1, [3]). *A finite presentation has a solvable word problem if and only if it admits a recursive isoperimetric function.*

Theorem 6.2. *Let $G = \langle S | R \rangle$ be a finite group presentation. If G is k -chordal, then $\langle S | R \rangle$ admits a recursive isoperimetric function, i.e., $\langle S | R \rangle$ has a solvable word problem.*

Proof. Suppose that G is k -chordal with respect to S . Since $\langle S | R \rangle$ is a finite presentation, then the set of words with length less than or equal to k is finite, and we can compute $c = \text{Dehn}(k)$. We define the following recursive function:

$$\begin{cases} f(n) = c & \text{if } n = 1, \dots, k \\ f(n) = 2f(n-1) = c2^{n-k} & \text{if } n > k \end{cases}$$

We claim that $\text{Dehn}(n) \leq 2\text{Dehn}(n-1)$ if $n > k$. In fact, let $\omega \in \langle\langle R \rangle\rangle$ such that $\text{Dehn}(n) = A(\omega)$ and suppose that $|\omega| = n > k$.

Suppose $\omega = s_1 \cdots s_n = e$ is a simple relation for some $s_1, \dots, s_n \in S^{\pm 1}$. Since G is k -chordal, then there exist $s'_1, \dots, s'_r \in S^{\pm 1}$ be such that $s_i \cdots s_j = s'_1 \cdots s'_r$ with $r \leq \min\{j-i, n-j+i-2\}$ for some $1 \leq i < j \leq n$. We can split $\bar{\omega} = \omega_1 \omega_2$ where $\omega_1 = s_{i+1} \cdots s_j s'_r{}^{-1} \cdots s'_1{}^{-1}$, $\omega_2 = s'_1 \cdots s'_r s_{j+1} \cdots s_n s_1 \cdots s_i$ and $\bar{\omega}$ is a cyclic conjugate of ω . Suppose that D_1 and D_2 define a van Kampen diagram for ω_1 and ω_2 over G (with base point $g = s_1 \cdots s_i$) respectively, see Figure 13.

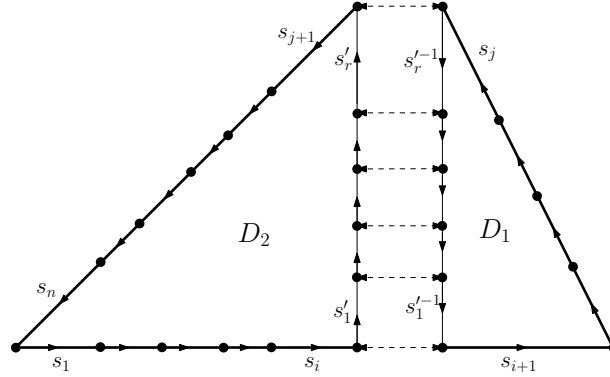

FIGURE 13. Van Kampen diagram for ω_1 at right and Van Kampen diagram for ω_2 at left.

If we join D_1 and D_2 through the common vertices s'_1, \dots, s'_r (see Figure 14), we obtain a van Kampen diagram D for $\bar{\omega}$ over G (with base point g).

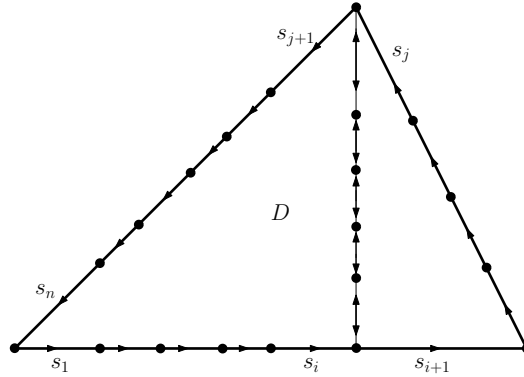

FIGURE 14. Van Kampen diagram for ω .

If $\omega = e$ is not a simple relation, then we can split $\bar{\omega} = \omega_1 \omega_2$ where $\omega_1 = e$, $\omega_2 = e$ and $\bar{\omega}$ is a rotation of ω .

Thus $\text{Dehn}(n) = A(\omega) = A(\bar{\omega}) \leq A(\omega_1) + A(\omega_2) \leq \text{Dehn}(n-1) + \text{Dehn}(n-1) = 2\text{Dehn}(n-1)$.

By induction, $\text{Dehn}(n) \leq f(n)$ for all $n \in \mathbb{N}$. We have shown that $\langle S|R \rangle$ admits a recursive isoperimetric function, and by Theorem 6.1, the word problem is solvable. \square

It is well known that finitely generated free abelian groups have solvable word problem. For the particular case of the group \mathbb{Z}^2 , since it is 5-chordal (Proposition 4.17), it follows also from Theorem 6.2 that \mathbb{Z}^2 has solvable word problem.

We have seen in Section 5 that G_2 is 6-chordal (Theorem 5.10). Therefore, by Theorem 6.2:

Corollary 6.3. *The Baumslag-Solitar group G_2 has solvable word problem.*

Given two functions $f, g : \mathbb{N} \rightarrow \mathbb{R}$, we will denote $f \preceq g$ if there exists $C > 0$ such that $f(n) \leq Cg(Cn + C) + Cn + C$ for all $n \in \mathbb{N}$. This gives an equivalence relation $f \approx g \iff f \preceq g$ and $g \preceq f$. We denote the exponential function in base m as $\exp_m(n) = m^n$. This simplifies the notation in some cases, for example, $\exp_m^k(n) = m^{m \cdots m^n}$.

Remark 6.4. *Let $G = \langle S|R \rangle$ be a finite group presentation. If G is k -chordal and $c = \text{Dehn}(k)$, then the Dehn function is bounded by the following function:*

$$\begin{cases} f(n) = c & \text{if } n = 1, \dots, k \\ f(n) = 2f(n-1) = c2^{n-k} & \text{if } n > k \end{cases}$$

Thus, if G is k -chordal, then $\text{Dehn} \preceq \exp_2$.

This idea provides us with a method to detect groups with solvable word problem that are not k -chordal for any $k \in \mathbb{N}$.

Example 6.5. *We will consider the group*

$$\Gamma_k = \langle a_1, \dots, a_k, t, p \mid t^{-1}a_it = a_i a_{i-1}, [t, a_1] = 1, [p, a_j t] = 1, i > 1, j > 0 \rangle$$

In [9], the authors prove that $\text{Dehn} \approx A_k$, where $A_3(n) = \exp_2^n(1)$ and $A_{m+1} \geq A_m$. By Theorem 6.1, Γ_k has a solvable word problem. However, if Γ_k were l -chordal, by Remark 6.4, then $\text{Dehn} \preceq \exp_2$, which is a contradiction for $k \geq 3$. Thus, we have shown that Γ_k is not chordal for $k \geq 3$.

7. ACKNOWLEDGMENTS

The authors are very grateful to Yago Antolín for his helpful comments and suggestions.

REFERENCES

- [1] Y. Antolín Pichel, On Cayley graphs of virtually free groups, *Groups Complex. Cryptol.* 3 (2011), no. 2, 301-327.
- [2] V. Araújo and Pedro V. Silva, Geometric characterizations of virtually free groups, *Journal of Algebra and Its Applications* Vol. 16, No. 09, 1750180 (2017).
- [3] N. Brady, T. Riley and H. Short, Dehn's Problems and Cayley Graphs. In: *The Geometry of the Word Problem for Finitely Generated Groups. Advanced Courses in Mathematics CRM Barcelona (Centre de Recerca Matemàtica)*. Birkhäuser Basel (2007)
- [4] M. R. Bridson and R. H. Gilman, A remark about combings of groups, *Internat. J. Algebra Comput.* 3 (1993), no. 4, 575-581.
- [5] M. Bridson and A. Haefliger, *Metric Spaces of Non-Positive Curvature*; Springer: Berlin, Germany, 1999.
- [6] S. Buyalo and V. Schroeder. *Elements of Asymptotic Geometry*. EMS Monographs in Mathematics. Germany (2007).
- [7] W. Dicks and M. J. Dunwoody, Groups acting on graphs, *Cambridge Stud. Adv. Math.* 17, CUP, Cambridge, 1989.
- [8] V. Diekert and A. Weiss. Context-Free Groups and Bass-Serre Theory. In Juan González-Meneses, Martin Lustig and Enric Ventura, editors, *Algorithmic and Geometric Topics Around Free Groups and Automorphisms, Advanced Courses in Mathematics - CRM Barcelona*. Birkhäuser, Basel, Switzerland, 2017.
- [9] W. Dison and T. Riley, Hydra groups, *Comment. Math. Helv.* 88 (2013), 507-540, DOI 10.4171/CMH/294.
- [10] C. Drutu and M. Kapovich *Geometric Group Theory*, AMS Colloquium publications, 63, (2018)
- [11] M. J. Dunwoody, The accessibility of finitely presented groups., *Invent. Math.* (3) 81 (1985),no. 3, 449-457.
- [12] D. B. A. Epstein, J. W. Cannon, D. F. Holt, S. V. F. Levy, M. S. Paterson and W. P. Thurston. *Word processing in groups*. Jones and Bartlett Publishers, Boston, MA, (1992)
- [13] K. Fujiwara and K. Whyte, A note on spaces of asymptotic dimension one, *Algebraic & Geometric Topology.* 7 (2007), 1063-1070.
- [14] T. Gentimis, Asymptotic dimension of finitely presented group, *Proc. Amer. Math. Soc.* 136 (2008), no. 12, 4103-4110.

- [15] E. Ghys and P. de la Harpe Editors, Sur les Groupes Hyperboliques d'après Mikhael Gromov, Progress in Mathematics. 83 Birkhuser, Boston, 1990.
- [16] R. H. Gilman, S. Hermiller, D. F. Holt and S. Rees, A characterization of virtually free groups, Arch. Math. 89 (2007), 289–295.
- [17] M. Gromov. Hyperbolic groups, Essays in Group Theory, volume 8 of Math. Sci. Res. Inst. Publ., pp. 75–263, Springer, 1987.
- [18] T. Januszkiewicz and J. Swiatkowski, Filling Invariants in Systolic Complexes and Groups, Geom. Topol. 11 (2007), 727–758.
- [19] A. Karrass, A. Pietrowski and D. Solitar, Finite and infinite cyclic extensions of free groups, J. Australian Math. Soc. 16 (1973), 458–466.
- [20] A. Khukhro, A characterisation of virtually free groups via minor exclusion, arXiv:2006.16918v1.
- [21] D. Kuske and M. Lohrey, Logical aspects of Cayley-graphs: the group case, Annals of Pure and Applied Logic Applied Logic. 131 (2005), 263–286.
- [22] C. Loh, Geometric Group Theory, An Introduction, Springer (2017).
- [23] J.F. Manning, Geometry of pseudocharacters. Geom. Topol. 2005, 9.
- [24] Á. Martínez-Pérez, Chordality properties and hyperbolicity on graphs, The electronic journal of combinatorics, 23(3) (2016).
- [25] Á. Martínez-Pérez, Generalized Chordality, Vertex Separators and Hyperbolicity on Graphs, Symmetry 2017, 10, 199.
- [26] D. E. Muller and Paul E. Schupp, Groups, the Theory of Ends, and Context-Free Languages, Journal of Computer and System Sciences 26, 295–310 (1983).
- [27] D. E. Muller and Paul E. Schupp, The theory of ends, pushdown automata, and second-order logic, Theoret. Comput. Sci. 37(1) (1985), 51–75.
- [28] H. Short, Diagrams and groups, in The Geometry of the Word Problem for Finitely Generated Groups, Birkhauser, (2007).
- [29] P. V. Silva, X. Soler-Escrivà and E. Ventura, Finite automata for Schreier graphs of virtually free groups, J. Group Theory 19 (2016), 25–54.
- [30] J. Stallings, On torsion free groups with infinitely many ends, Ann. of Math. 88 (1968), 312–334.
- [31] F. Rimlinger, Pregroups and Bass-Serre theory, Mem. Amer. Math. Soc. 65(361) (1987), viii+73.
- [32] W. Woess, Graphs and groups with Tree-Like properties, J. of Combinatorial Theory, Series B. 47 (1989), 361–371.

FACULTAD CC. MATEMÁTICAS, UNIVERSIDAD COMPLUTENSE DE MADRID, PLAZA DE CIENCIAS, 3. 28040 MADRID, SPAIN
 Email address: samuguti@ucm.es

FACULTAD CC. SOCIALES, UNIVERSIDAD DE CASTILLA-LA MANCHA, AVDA. REAL FÁBRICA DE SEDA, S/N. 45600 TALAVERA DE LA REINA, TOLEDO, SPAIN
 Email address: alvaro.martinezperez@uclm.es