

Deconfining $\mathcal{N} = 2$ SCFTs



or the Art of Brane Bending

Iñaki García Etxebarria,[‡] Ben Heidenreich,[‡] Matteo Lotito,[‡] Ajit Kumar Sorout[‡]

[‡]*Department of Mathematical Sciences,
Durham University, Durham, DH1 3LE, United Kingdom*

[‡]*Amherst Center for Fundamental Interactions,
Department of Physics, University of Massachusetts, Amherst, MA 01003 USA*

E-mail: inaki.garcia-etxebarria@durham.ac.uk, bheidenreich@umass.edu,
ajitkumar@umass.edu, mloitito@umass.edu

ABSTRACT: We introduce a systematic approach to constructing $\mathcal{N} = 1$ Lagrangians for a class of interacting $\mathcal{N} = 2$ SCFTs. We analyse in detail the simplest case of the construction, arising from placing branes at an orientifolded $\mathbb{C}^2/\mathbb{Z}_2$ singularity. In this way we obtain Lagrangian descriptions for all the $R_{2,k}$ theories. The rank one theories in this class are the E_6 Minahan-Nemeschansky theory and the $C_2 \times U(1)$ Argyres-Wittig theory. The Lagrangians that arise from our brane construction manifestly exhibit either the entire expected flavour symmetry group of the SCFT (for even k) or a full-rank subgroup thereof (for odd k), so we can compute the full superconformal index of the $\mathcal{N} = 2$ SCFTs, and also systematically identify the Higgsings associated to partial closing of punctures.

Contents

1	Introduction	2
2	Review	5
2.1	Deconfinement for isolated $\mathcal{N} = 1$ orientifold SCFTs	5
2.2	Phases of $\mathcal{C}_{\mathbb{C}}(\mathbb{F}_0)$	8
2.3	Brane tiling constructions	10
2.4	Deconfinement and quad CFTs	14
2.5	Flux assignments and duality	23
3	$\mathcal{N} = 1$ Lagrangians for the $R_{2,k}$ SCFTs	24
3.1	Even k	28
3.2	Odd k	33
4	Higgs branch deformations	40
4.1	Dimension of the Higgs branch for $R_{2,k}$	40
4.2	(A_1, D_4) Argyres-Douglas from partially closing $R_{2,2}$ punctures	43
5	Coulomb branch deformations	47
5.1	Even k Coulomb branch	47
5.2	Odd k Coulomb branch	49
6	Mass deformation	50
7	Conclusions and further directions	50
A	Superconformal index for $R_{2,2k}$	51

1 Introduction

During the last several years our understanding of four-dimensional $\mathcal{N} = 2$ superconformal field theories (SCFTs) has been greatly enhanced, particularly in the case in which these theories can be constructed by compactifying the six-dimensional $(2, 0)$ theory of type \mathfrak{g} on a punctured Riemann surface Σ [1]. These SCFTs often come in continuously connected families, forming a “conformal manifold”. The geometry of this conformal manifold can be understood as arising from the geometry of the Riemann surface Σ . Of particular interest are subloci of this manifold where Σ degenerates. In this case we sometimes have a weakly coupled Lagrangian description of the SCFT, but more often we end up with a collection of basic building blocks, given by three-punctured spheres, connected by a weak gauging of subgroups of their flavour groups.¹ The different degeneration limits of Σ are known as the different duality frames for the theory, and we say that the theories arising in these degeneration limits are dual to each other. We refer the reader to the nice reviews [3, 4] for a detailed explanation of these facts.

A particularly important case is the one where all three punctures are “full” punctures. The resulting SCFTs are known as the $T[\mathfrak{g}]$ theories. Except in the $\mathfrak{g} = A_1$ case, the $T[\mathfrak{g}]$ theories are intrinsically strongly coupled $\mathcal{N} = 2$ SCFTs. Other types of punctures can be obtained by Higgsing fields in the $T[\mathfrak{g}]$ theory, an operation known in the literature as “(partial) closing” of punctures. In addition, for our discussion it is important to introduce “twisted” punctures. Such punctures have the property that there is a monodromy around them acting as an outer automorphism of the $(2, 0)$ theory. In configurations with three punctures we have the possibility of twisting two of the punctures. The resulting twisted theories were analysed in detail in [2, 5, 6] and play an important role below.

Remarkably, much of the knowledge gained in the last few years about these $\mathcal{N} = 2$ SCFTs has been obtained without requiring any knowledge of a Lagrangian description, or perhaps more accurately, despite the fact that no Lagrangian is known. This situation has recently started to change. An important development was the construction — initiated by Maruyoshi and Song [7–9] and then further extended by a number of authors [10–13] — of $\mathcal{N} = 1$ preserving renormalization group flows connecting $\mathcal{N} = 2$ SCFTs. If the starting theory is Lagrangian, then this provides a Lagrangian theory in the universality class of the $\mathcal{N} = 2$ SCFTs at the end of the flow.

A second approach constructs $\mathcal{N} = 1$ Lagrangians by probing the $\mathcal{N} = 1$ preserving conformal manifold of the $\mathcal{N} = 2$ SCFTs. These deformations of the $\mathcal{N} = 2$ theory typically break the symmetry group of the target SCFT to a lower rank subgroup, but the resulting Lagrangians are still useful. There are some powerful constraints that any Lagrangian theory in the same conformal manifold should obey, and exploration of such constraints have led to the construction of Lagrangians for a number of important $\mathcal{N} = 2$ (and even $\mathcal{N} = 3$) SCFTs [14–17].

¹At least in most cases. In some rare cases one needs to refine this picture, see [2] for the detailed analysis of one such instance.

In this paper we introduce a third class of constructions, which take advantage of a number of recent results in the context of duality for $\mathcal{N} = 1$ SCFTs [18, 19]. We will review these results in detail below.² These results apply to the class of $\mathcal{N} = 1$ SCFTs that arise from isolated orientifolds of D3 branes probing isolated toric singularities. This is a large class of theories, and all have non-trivial conformal manifolds: the value of the string coupling provides an exactly marginal parameter, and in some exceptional low-rank³ cases some additional marginal deformations might exist. As in [18, 19], we will focus on the directions in the conformal manifold associated to the ambient string coupling, which persist for arbitrary rank (for sufficiently high rank the conformal manifold for this class of theories has complex dimension one, and is parametrised by the ambient string coupling). The physics at the cusps of the conformal manifold is very reminiscent of that appearing in $\mathcal{N} = 2$ class- \mathcal{S} theories: there is a class of isolated $\mathcal{N} = 1$ SCFTs, denoted by TO_k in [19], and the generic duality frame can be described in terms of a set of TO_k theories coupled via weak gauging of diagonal subgroups of their flavour symmetry groups.

Rather surprisingly, the situation regarding Lagrangian descriptions is much more developed in the $\mathcal{N} = 1$ case than in the $\mathcal{N} = 2$ case: there are known Lagrangians for *all* TO_k SCFTs. These Lagrangians are obtained by a rather natural operation in the string theory description, which we call *deconfinement*, as it generalizes the familiar notion of deconfinement of free antisymmetric tensors in the context of Seiberg duality [26–29]. We will review this operation below. Additionally, in some cases providing a Lagrangian description of the full theory, not only the TO_k sectors, requires *brane bending*: a (natural) deformation of overlapping branes in the system so that gauge couplings of some branes in the brane tiling become finite. An example of brane bending is given in figure 4(c) below. Using these two operations one can provide $\mathcal{N} = 1$ Lagrangians for *any* $\mathcal{N} = 1$ SCFT in the class described above.

These developments raise a very natural question: what are the analogues of brane bending and deconfinement in the $\mathcal{N} = 2$ setting? The answer is not straightforward, as $\mathcal{N} = 2$ theories do not fall in the class of theories analysed in [18, 19], and in fact we will not provide a complete answer in this paper. However, we make a small step in this direction by using our knowledge of the $\mathcal{N} = 1$ setting to derive Lagrangians, in a fairly systematic way, for a number of interesting $\mathcal{N} = 2$ SCFTs.

The basic argument goes as follows. Recall that the dualities in [18, 19] describe what happens to the field theory as we crank up the ambient string coupling, and switch descriptions to a new weakly coupled duality frame. The effect in the field theory is a deformation by an exactly marginal operator, moving us from one cusp in the conformal manifold to another.

We will combine this operation with partial resolution of the singularity. In particular,

²See also [20, 21] for earlier work on the class of string configurations we study in this paper, and [22–25] for recent work on $\mathcal{N} = 1$ dualities arising from orientifolded toric singularities.

³By rank we mean the number of mobile D3 branes probing the singularity, as measured by the F_5 flux at infinity.

we will study partial resolutions of the form^{4,5}

$$\rho: (\mathbb{C}^2/\mathbb{Z}_{2n} \times \mathbb{C}) + (\mathbb{C}^2/\mathbb{Z}_{2n} \times \mathbb{C}) \rightarrow Y^{2n,0}, \quad (1.1)$$

where the left hand side denotes a Calabi-Yau threefold that is smooth except at two points, each locally of the form $\mathbb{C}^2/\mathbb{Z}_{2n} \times \mathbb{C}$. The toric description of the partial resolution is (in the $n = 2$ case)

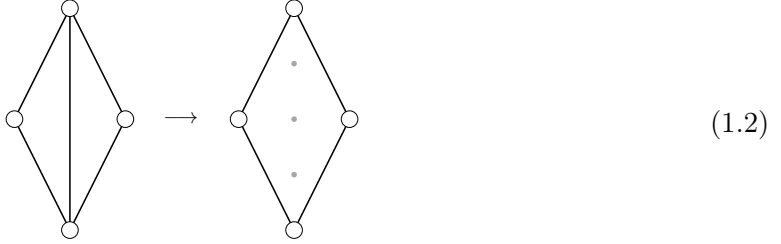

We are interested in what happens to the IR fixed point of the theory on branes probing the singularity under this operation. In order to encode this we introduce the notation $\mathcal{T}^\phi[X]$, to represent the CFT describing the IR fixed point of the theory of D3 branes probing the singular point in X , with additional data, such as possible orientifold planes and fluxes denoted generically by ϕ . In this notation, there is an induced map on the space of 4d CFTs, coming from turning on a baryonic vev (encoding the size of the exceptional cycle in the partial resolution) and integrating out massive modes

$$\rho^*(\mathcal{T}^\phi[Y^{2n,0}]) = \mathcal{T}^\alpha[\mathbb{C}^2/\mathbb{Z}_{2n} \times \mathbb{C}] + \mathcal{T}^\beta[\mathbb{C}^2/\mathbb{Z}_{2n} \times \mathbb{C}] \quad (1.3)$$

where now addition on the right hand side means that we have two decoupled SCFTs.

From the point of view of the string construction it is natural to expect that the effect of this operation in the field theory commutes with the duality, in the sense that the following diagram is commutative:

$$\begin{array}{ccc} \mathcal{T}^\phi[Y^{2n,0}] & \xrightarrow{\rho^*} & \mathcal{T}^\alpha[\mathbb{C}^2/\mathbb{Z}_{2n} \times \mathbb{C}] + \mathcal{T}^\beta[\mathbb{C}^2/\mathbb{Z}_{2n} \times \mathbb{C}] \\ \downarrow S & & \downarrow S \\ \mathcal{T}^{S(\phi)}[Y^{2n,0}] & \xrightarrow{\rho^*} & \mathcal{T}^{S(\alpha)}[\mathbb{C}^2/\mathbb{Z}_{2n} \times \mathbb{C}] + \mathcal{T}^{S(\beta)}[\mathbb{C}^2/\mathbb{Z}_{2n} \times \mathbb{C}] \end{array} \quad (1.4)$$

where we have denoted by S the action on the background data induced by taking the string coupling to infinity, so that we move to a different cusp in the conformal manifold. The assumption that (1.4) is commutative allows us to understand the behaviour of S-duality on $\mathcal{T}^\alpha[\mathbb{C}^2/\mathbb{Z}_{2n} \times \mathbb{C}]$ from the behavior of S-duality on $\mathcal{T}^\phi[Y^{2n,0}]$, which was understood in [18, 19], and the behaviour of ρ^* , which is reasonably well understood in the case of ordinary dimer models — see for instance [30] for a systematic approach.

⁴Here ρ is the “blow-down” map from the partially resolved space to the more singular one.

⁵We emphasise that this is a special case of a much more general construction. However, even the special case $n = 1$ (which we focus on in the present paper) will yield very interesting and nontrivial results.

For the sake of presentation, it will be convenient to introduce forgetful maps ρ_L^* and ρ_R^* that focus on each of the resulting SCFTs as follows

$$\rho_L^*(\mathcal{T}^\phi[Y^{2n}]) = \mathcal{T}^\alpha[\mathbb{C}^2/\mathbb{Z}_{2n} \times \mathbb{C}] \quad (1.5)$$

and similarly $\rho_R^* = \rho^* - \rho_L^*$. It is natural to conjecture that if (1.4) is commutative then the reduced version

$$\begin{array}{ccc} \mathcal{T}^\phi[Y^{2n,0}] & \xrightarrow{\rho_L^*} & \mathcal{T}^\alpha[\mathbb{C}^2/\mathbb{Z}_{2n} \times \mathbb{C}] \\ S \downarrow & & \downarrow S \\ \mathcal{T}^{S(\phi)}[Y^{2n,0}] & \xrightarrow{\rho_L^*} & \mathcal{T}^{S(\alpha)}[\mathbb{C}^2/\mathbb{Z}_{2n} \times \mathbb{C}] \end{array} \quad (1.6)$$

is also commutative, and similarly for ρ_R^* . This will be our fundamental assumption in the rest of the paper.

Choosing α , β and ϕ judiciously we can arrange for $\mathcal{T}^\alpha[\mathbb{C}^2/\mathbb{Z}_{2n} \times \mathbb{C}]$ to preserve $\mathcal{N} = 2$ supersymmetry, thereby connecting the results of [18, 19] to the large literature on $\mathcal{N} = 2$ dualities beginning with [1].

In this paper we initiate this program, by focusing exclusively on the simplest case, $n = 1$. The resulting singularity is known as the complex Calabi-Yau cone over $\mathbb{F}_0 = \mathbb{P}_1 \times \mathbb{P}_1$, or the real Calabi-Yau cone over $Y^{2,0}$, and can alternatively be described as a \mathbb{Z}_2 orbifold of the conifold. By following the logic above, we will be able to systematically construct Lagrangians for all the $R_{2,k}$ theories, with k even or odd. An important case that we will study in detail is $k = 3$, where $R_{2,3}$ is the rank one E_6 Minahan-Nemeschansky theory [31], also known as the $T[A_2]$ or more simply T_3 theory in the context of class \mathcal{S} . It is also interesting to consider $k = 2$, which engineers the Argyres-Wittig theory with global symmetry algebra $\mathfrak{usp}(4) \oplus \mathfrak{u}(1)$.

We have organised this paper as follows. We start in §2 by providing a short review of the main results that we will need from [18, 19]. Our main results are presented in §3, where we derive $\mathcal{N} = 1$ Lagrangians for the $R_{2,k}$ $\mathcal{N} = 2$ SCFTs using the strategy sketched above, and perform some standard checks. We proceed to further test these Lagrangian descriptions in a number of ways: the Higgs branch structure of the theories is studied in §4, the Coulomb branch in §5, and the result of turning on mass deformations is described in §6. In all cases we find perfect agreement with the expectations from previous $\mathcal{N} = 2$ results, whenever these exist. We finish by listing some conclusions and further directions in §7. The appendix collects explicit expressions for the $R_{2,2k}$ superconformal indices for $k = 1, 2, 3$.

2 Review

2.1 Deconfinement for isolated $\mathcal{N} = 1$ orientifold SCFTs

We will now briefly review some of the results in [18–21], placing particular emphasis on those that are particularly important for our discussion. We will not include derivations of the results, we refer the interested reader to the original works for proofs.

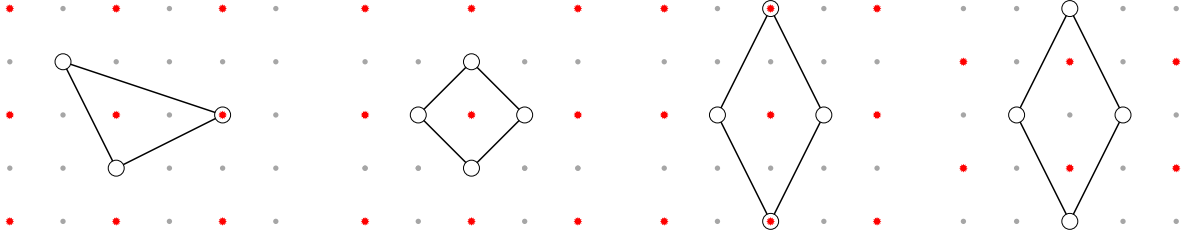

Figure 1: Examples of toric diagrams with choice of even sublattice. The first and third graphs describe cases where some vertices of the toric diagram lie within the chosen even sublattice. Such examples will not be considered in the present work.

Consider a toric⁶ Calabi-Yau threefold X , which we assume to be a cone with an isolated singularity at the origin. All toric Calabi-Yau threefolds can be described by providing a two-dimensional lattice polytope known as the *toric diagram*; those having isolated singularities have the additional property that the edges of the toric diagram do not hit any intermediate lattice points. We will consider IIB string theory on this background, in the presence of an orientifold action preserving the toric nature of the space. Such orientifold actions were classified in [19], they can be characterized by a choice of even sublattice for the toric \mathbb{Z}^2 lattice. For simplicity, we will restrict to cases where the orientifold action leaves only the isolated singularity at the origin fixed. In terms of the toric diagram this requires that none of the external vertices of the toric diagram are contained in the even sublattice defining the orientifold action, see figure 1 for examples.

We now place N D3 branes at the singular point of the geometry. For the moment we do not include an orientifold involution. This leads to an interacting $\mathcal{N} = 1$ SCFT in four dimensions with a marginal deformation which we can identify with the value of the IIB axio-dilaton.⁷ The axio-dilaton $\tau = C_0 + i/g_s$ of IIB takes values in the upper half-plane, but values related by modular transformations $g \in SL(2, \mathbb{Z})$ define the same physical theory:

$$\tau \rightarrow g(\tau) = \frac{a\tau + b}{c\tau + d}, \quad g = \begin{pmatrix} a & b \\ c & d \end{pmatrix}, \quad a, b, c, d \in \mathbb{Z}, \quad ad - bc = 1. \quad (2.1)$$

Because both the geometric background and the D3 branes map to themselves under $SL(2, \mathbb{Z})$, this implies that the $\mathcal{N} = 1$ SCFTs on N D3 branes with coupling τ is equivalent to that same theory with coupling $g(\tau)$. We have a weakly coupled Lagrangian description of the $\mathcal{N} = 1$ SCFT at those points related by an $SL(2, \mathbb{Z})$ transformation to $\tau = i\infty$. We will refer to such points in the conformal manifold as “cusps”. This situation is illustrated in figure 2(a), in which we map the upper half plane to a disk, shading the cusps in purple.

This discussion needs to be modified once we introduce orientifold planes. While the D3s, and by extension the F_5 flux created by the D3 branes, are $SL(2, \mathbb{Z})$ invariant, the H_3 and F_3

⁶We refer the reader unfamiliar with toric geometry to the excellent book [32]. A briefer introduction summarizing all the ideas that we will need can be found in [19].

⁷It is possible to have additional marginal deformations, but these will play no role in our discussion.

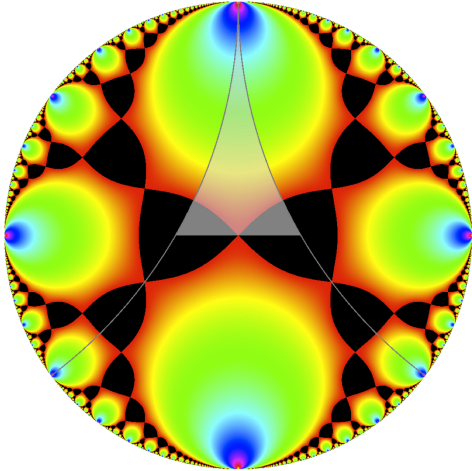

(a) Conformal manifold.

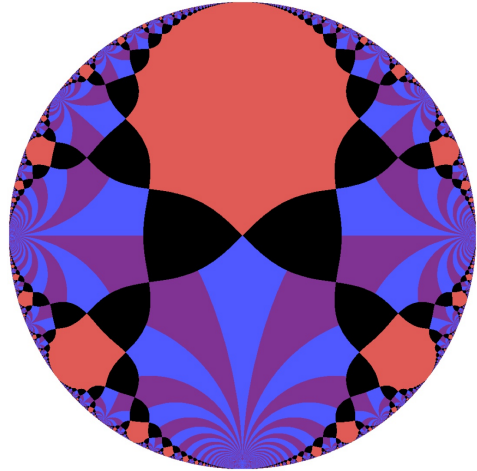

(b) Duality phases for the O3 theory.

Figure 2: (a) The upper half plane, conformally mapped to a disk. We have lightly shaded a copy of the fundamental region for $SL(2, \mathbb{Z})$. Every other point in the disk can be mapped to this region by a $SL(2, \mathbb{Z})$ transformation. The blue/purple regions correspond to regions where weakly coupled descriptions exist in some duality frame. (b) Partition of the conformal manifold of the $\mathcal{N} = 4$ $\mathfrak{so}(2N + 1)$ theory into regions where at weak coupling the valid description is in terms of a $\mathfrak{so}(2N + 1)$ algebra (pink) or $\mathfrak{usp}(2N)$ (blue/purple).

[Figures reproduced from [20].]

fluxes sourced by the orientifold transform as a $SL(2, \mathbb{Z})$ doublet. Introducing the notation $\mathcal{F}_3 := (F_3, H_3)$, we have:

$$g(\mathcal{F}_3) = \begin{pmatrix} a & b \\ c & d \end{pmatrix} \begin{pmatrix} F_3 \\ H_3 \end{pmatrix} = \begin{pmatrix} aF_3 + bH_3 \\ cF_3 + dH_3 \end{pmatrix}. \quad (2.2)$$

So we have additional data to keep track in determining the physics at the cusps: the precise CFT at the singularity depends on the pair (τ, \mathcal{F}_3) subject to the relation

$$(\tau, \mathcal{F}_3) \sim (g(\tau), g(\mathcal{F}_3)). \quad (2.3)$$

Note in particular that the physics at different cusps can depend quite strongly on the value of \mathcal{F}_3 . As a simple example, consider the case of N D3 branes probing an O3 plane in flat space. As discussed in [33] in this case \mathcal{F}_3 takes values in $\mathbb{Z}_2 \oplus \mathbb{Z}_2$ (we will explain and expand on this statement momentarily), so there are four possibilities for \mathcal{F}_3 . Assume that on a given cusp, in a duality frame where $g_s \ll 1$, we have a flux \mathcal{F}_3 . Then it was argued in [33] that the dynamics at this cusp is described by weakly coupled $\mathcal{N} = 4$ SYM with gauge algebra \mathfrak{g} ,

with⁸

\mathcal{F}_3	\mathfrak{g}	
(0, 0)	$\mathfrak{so}(2N)$	(2.4)
(1, 0)	$\mathfrak{so}(2N + 1)$	
(0, 1)	$\mathfrak{usp}(2N)$	
(1, 1)	$\mathfrak{usp}(2N)$	

Consider for instance the case that in one duality frame we have $g_s \ll 1$ and $\mathcal{F}_3 = (1, 0)$, and let us take $C_0 = 0$ for simplicity of exposition. This corresponds to a $\mathcal{N} = 4$ SYM theory with gauge algebra $\mathfrak{so}(2N + 1)$ and coupling $g_{\mathfrak{so}(2N+1)}^2 = g_s$ (in general the mapping is $C_0 + i/g_s = \frac{\theta}{2\pi} + i/g_{\text{YM}}^2$). By (2.3), and from the dictionary between flux and gauge algebra in [33], this is equivalent to having an $\mathcal{N} = 4$ theory with gauge algebra $\mathfrak{usp}(2N)$ with gauge coupling $g_{\mathfrak{usp}(2N)}^2 = g_s^{-1}$. This is in agreement with the standard prediction from Montonen-Olive duality [34, 35].

An alternative way of thinking about this duality is that if we fix the flux at one cusp, then every other cusp is decorated with a flux assignment, which gives rise to potentially different perturbative descriptions at different cusps. In the example above, this means that we can interpolate between the weakly coupled $\mathfrak{so}(2N + 1)$ and $\mathfrak{usp}(2N)$ $\mathcal{N} = 4$ theories by moving in the conformal manifold. This is illustrated in figure 2(b), where we have split the conformal manifold according to whether the weakly coupled description valid in each region has algebra $\mathfrak{so}(2N + 1)$ or $\mathfrak{usp}(2N)$. We will refer to the different decorated cusps of the conformal manifold as the *duality phases* of the theory, and we will say that two such phases are related by an $SL(2, \mathbb{Z})$ transformation g if the corresponding couplings are related by g .

2.2 Phases of $\mathcal{C}_{\mathbb{C}}(\mathbb{F}_0)$

The picture that we have discussed so far generalises in a beautiful way to a certain class of $\mathcal{N} = 1$ SCFTs, namely those arising from D3 branes probing an isolated toric singularity in the presence on a toric orientifold whose only fixed point is at the singularity of the geometry.

Consider a toric Calabi-Yau cone X_6 , with base X_5 . We assume that the only singularity of X_6 is at the base of the cone. We will quotient by an orientifold action $(-1)^{F_L} \Omega \sigma$, where $\sigma: X_6 \rightarrow X_6$ leaves only the origin invariant. This implies that it acts on X_5 freely. We additionally demand that σ preserves the toric structure of X_6 , or in other words that X_6/σ is still toric (although it will not be Calabi-Yau any more). Our working example will be the Calabi-Yau cone over $\mathbb{F}_0 = \mathbb{P}^1 \times \mathbb{P}^1$, which we denote by $\mathcal{C}_{\mathbb{C}}(\mathbb{F}_0)$. The toric diagram of this geometry is

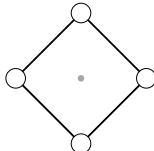

⁸The cases $\mathcal{F}_3 = (0, 1)$ and $\mathcal{F}_3 = (1, 1)$ are related by $\tau \rightarrow \tau + 1$, which induces a shift of the θ angle in the field theory, so they give rise to the same perturbative behaviour.

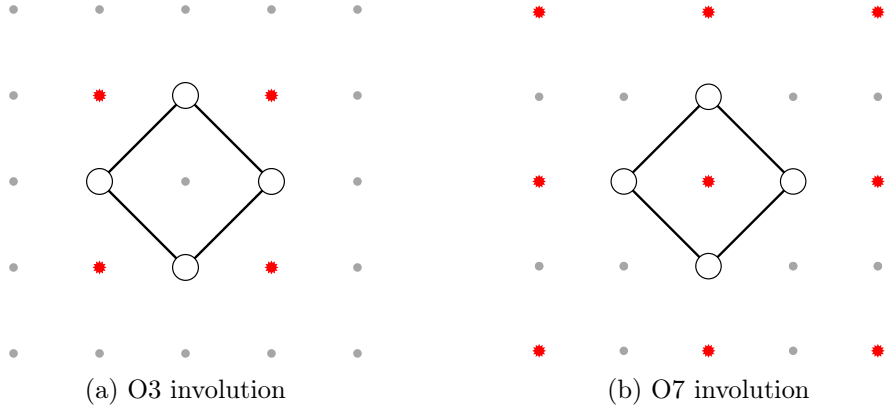

Figure 3: Two choices of even sublattices for \mathbb{Z}^2 . As explained in [19], these correspond to the two choices of toric involutions of $\mathcal{C}_{\mathbb{C}}(\mathbb{F}_0)$ with compact orientifold locus, up to equivalences. We have named the two involutions according to the kind of orientifold planes that arise when blowing up the singularity.

This Calabi-Yau threefold is a real cone over $(S^3 \times S^2)/\mathbb{Z}_2$.

In order to classify the SCFTs at the cusps, we first need to classify the possible orientifolds that we can put on the singularity: this involves fixing the geometric actions σ and the choices of discrete \mathcal{F}_3 flux. We then need to be able to describe the SCFT at the singularity for any such choices of σ and \mathcal{F}_3 . This program was completed in [19], building on previous work in [18, 20, 21]. In what follows we will review the results in [19], we refer the reader to that paper for derivations and a more detailed discussion.

As a first step, the choices of σ keeping X_6/σ toric can be classified by choosing an even sublattice of the \mathbb{Z}^2 lattice on which the toric diagram is defined. There are four choices for the origin of such an even sublattice, although in some cases — such as the \mathbb{F}_0 case of interest to us — various choices might be related by symmetries of the toric diagram, leading to equivalent physics. The resulting orientifold action will have a compact fixed locus iff none of the external vertices of the toric diagram is contained in the chosen even sublattice. Consider for instance the case of $X_6 = \mathcal{C}_{\mathbb{C}}(\mathbb{F}_0)$. In this case there are two inequivalent choices of σ keeping the orientifold locus isolated, shown in figure 3. It is convenient to refer to the resulting involutions according to the dimension of the fixed locus in the fully resolved geometry. In one case we obtain an O7 plane wrapping the exceptional \mathbb{F}_0 , while in the other case we obtain four O3 planes. Accordingly, we refer to the two involutions as “O7” and “O3”, respectively. The involution that leads to $\mathcal{N} = 2$ theories after partial resolution is the O3 one, so henceforth we will focus exclusively on this one.

The next step is to classify the \mathcal{F}_3 fluxes that one can turn on the orientifolded geometry. More precisely, we want to classify the flux as measured at infinity. The manifold at infinity, ignoring the 4d spacetime part, has topology X_5 , and \mathcal{F}_3 transforms as a doublet of $SL(2, \mathbb{Z})$,

so the flux at infinity is classified by elements of the cohomology with local coefficients⁹ $H^3(X_5; (\mathbb{Z} \oplus \mathbb{Z})_\rho)$, with ρ the action of $SL(2, \mathbb{Z})$ on the coefficient system. We refer the reader to [41] for the definition of cohomology with local coefficients, and [33, 42] for applications of this formalism in the perturbative and non-perturbative settings. In our case $\rho = (-1)^{F_L} \Omega = \begin{pmatrix} -1 & 0 \\ 0 & -1 \end{pmatrix}$, so elements of \mathcal{F}_3 are classified by $H^3(X_5; \tilde{\mathbb{Z}} \oplus \tilde{\mathbb{Z}}) = H^3(X_5; \tilde{\mathbb{Z}}) \oplus H^3(X_5; \tilde{\mathbb{Z}})$. Each summand is the group of degree-three cohomology classes with local \mathbb{Z} coefficients [41], twisted on the non-trivial \mathbb{Z}_2 cycle of X_5 . A more down-to-earth summary of all this, at least in our specific case, is to say that due to the orientifold action the NSNS and RR fluxes pick up a minus sign as we go around the non-contractible cycle in X_5/σ .

For an isolated toric singularity with n external vertices, and an isolated toric orientifold action, we have [19]

$$H^3(X_5; \tilde{\mathbb{Z}}) = \underbrace{\mathbb{Z}_2 \oplus \dots \oplus \mathbb{Z}_2}_{n-3 \text{ times}}. \quad (2.6)$$

For $X_6 = \mathcal{C}_{\mathbb{C}}(\mathbb{F}_0)$ we have $n = 4$ external vertices in the toric diagram (2.5), so

$$H^3(X_5; \tilde{\mathbb{Z}}) = \mathbb{Z}_2 \oplus \mathbb{Z}_2 \quad (2.7)$$

which implies that there are 16 possible values for the flux \mathcal{F}_3 classifying the orientifold type at the singularity (four for F_3 times four for H_3), and therefore 16 possible different flux decorations for a given cusp. Some of these flux choices are related by shifts of C_0 , and therefore lead to the same perturbative description.

We will give the detailed dictionary between \mathcal{F}_3 flux and field theory below, but for the moment let us simply state that there are three types of theories appearing at the cusps, which we will call phases I, II and III. (There is also a phase $\tilde{\text{II}}$ related to phase II. The \mathcal{F}_3 fluxes giving rise to these two phases are related by symmetries of the singularity, so phases II and $\tilde{\text{II}}$ are isomorphic as field theories. We will for the most part ignore $\tilde{\text{II}}$ in what follows.) These three phases are best understood in the language of brane tilings, as in figure 4. We write the perhaps more familiar quiver description of these theories below.

2.3 Brane tiling constructions

Let us briefly describe how to obtain (and interpret) the brane tilings in figure 4, referring the reader to [43–45] for the original works on brane tilings and their orientifolds, to [46] for a review and [19] for a more detailed analysis in the particular case that concerns us here. A brane tiling is a tiling of the torus by D5 branes (the white regions) and bound states of one D5 with ± 1 NS5 branes (the grey and orange regions). These two kinds of regions are separated by 1-cycles, which encode where NS5 branes end on the tiling. The winding numbers of these

⁹We will use cohomology to classify fluxes. A more precise characterisation, at least in the perturbative setting of interest to us, would involve K-theory [36]. See [37–39] for work classifying orientifolds from this perspective. Alternatively, we could work in F-theory, and classify those fluxes that preserve Poincaré invariance in 4d, see for instance [40].

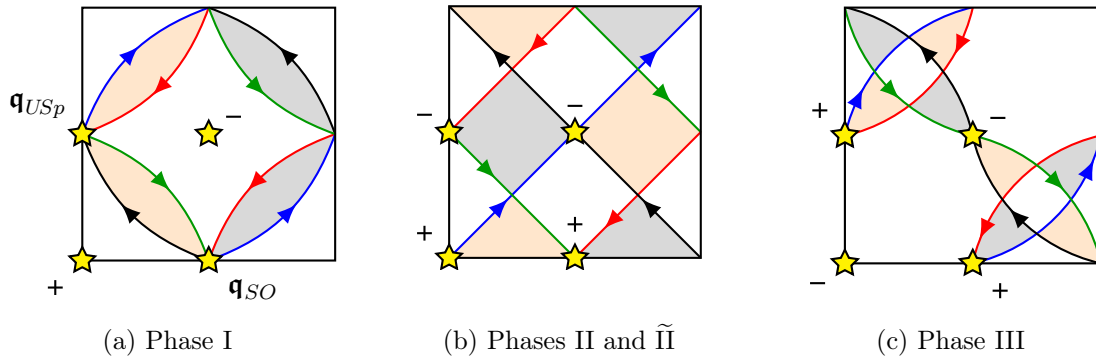

Figure 4: Theories arising at the cusps of the conformal manifold for the $\mathcal{C}_{\mathbb{C}}(\mathbb{F}_0)$ theory modded out by the O3 action, for different choices of flux. Due to the high degree of symmetry of $\mathcal{C}_{\mathbb{C}}(\mathbb{F}_0)$ some of the flux choices lead to isomorphic choices, which we have denoted as phases II and $\tilde{\text{II}}$ in this figure.

[Figures reproduced from [19].]

cycles on the T^2 reproduce the slopes of the external legs in the (p, q) -web diagram for the toric singularity. For our \mathbb{F}_0 example, this means that we have four NS5 branes ending on 1-cycles on the T^2 , with winding numbers $(1, 1)$, $(1, -1)$, $(-1, 1)$, and $(-1, -1)$. In the absence of orientifolds, regions of the T^2 covered by D5 branes lead to SU gauge factors, intersections of two NS5 branes lead to bifundamental matter between the D5s touching the intersection, and D5-NS5 bound states lead to superpotential couplings.

We are interested in orientifolded configurations, where the orientifold leaves four points fixed on the T^2 . These points are O5 planes intersecting the torus, and the sign annotation of the tiling indicates the type of orientifold plane we are dealing with. The orientifold projection acts on the gauge theory in a natural way: if two SU factors are exchanged by the orientifold action then a diagonal combination survives, while if a SU face is invariant then it is projected down to SO or USp depending on the orientifold sign. Similarly for matter content: two bifundamental multiplets exchanged by the orientifold action lead to a single chiral multiplet in the orientifolded theory, while a bifundamental mapped to itself leads to a symmetric or antisymmetric representation, depending on the sign of the orientifold action.

In order to obtain a configuration consistent under the orientifold action, it must be the case that the NS5 branes map to themselves under the orientifold action (up to orientation). This implies that each NS5 brane should pass through two fixed points. Up to isomorphism, and after some “brane bending”, this leads to the three phases in figure 4. The bending of branes accounts for the fact that if we draw the NS5s using straight lines on the T^2 then in phases I and III we would have overlapping NS5 branes, which leads to strongly coupled physics. In phase III bending the branes in a way compatible with the orientifold projection is a simple way of obtaining a Lagrangian theory in the same universality class as the theory being engineered by the string construction. Phase I has the further peculiarity that, even after bending the overlapping NS5 branes so they do not overlap any longer, we still have four

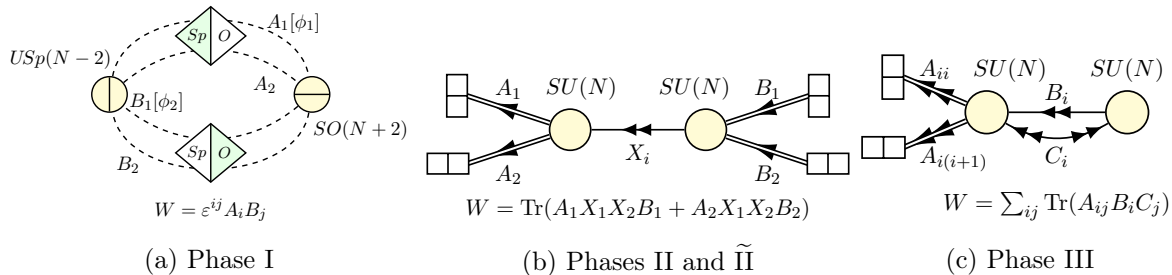

Figure 5: Quiver gauge theories arising from the brane tilings in figure 4.

[Figures reproduced from [19].]

NS5 branes intersecting at a point. This can also be resolved by a more advanced form of brane bending (which we refer to as “deconfinement”), described below.

Applying these rules, we read off the quiver theory associated to each brane tiling, with the results shown in figure 5. Let us start with phase II, which is the most conventional one. The quiver is shown in figure 5(b), and more explicitly we have a field content

	$SU(N)$	$SU(N)$	$U(1)_B$	$U(1)_X$	$U(1)_Y$	$U(1)_R$	
X_1	\square	$\bar{\square}$	$\frac{1}{N}$	1	0	$\frac{1}{2}$	
X_2	\square	$\bar{\square}$	$\frac{1}{N}$	-1	0	$\frac{1}{2}$	
B_1	$\bar{\square}$	$\mathbf{1}$	$-\frac{1}{N}$	0	$-1 - \frac{2}{N}$	$\frac{1}{2}$	(2.8a)
B_2	\square	$\mathbf{1}$	$-\frac{1}{N}$	0	$1 - \frac{2}{N}$	$\frac{1}{2}$	
A_1	$\mathbf{1}$	\square	$-\frac{1}{N}$	0	$1 + \frac{2}{N}$	$\frac{1}{2}$	
A_2	$\mathbf{1}$	\square	$-\frac{1}{N}$	0	$-1 + \frac{2}{N}$	$\frac{1}{2}$	

and superpotential

$$W = \text{Tr}(A_1 X_1 X_2 B_1 + A_2 X_1 X_2 B_2). \quad (2.8b)$$

We emphasize that the Lagrangian just described is *not* conformal. Instead, we are interested in the infrared superconformal fixed point to which this Lagrangian flows.

In fact, the Lagrangian is not even asymptotically free, due to the nonrenormalizable superpotential. There are two ways to view this deficiency: on the one hand, as described in [20] we can view the Lagrangian as an effective field theory with a UV cutoff set by the nonrenormalizable couplings and an IR dynamical scale. By an analysis similar to [20] using the methods of [47], one can easily check that one combination of the couplings (related to g_s) is neutral under all the spurious flavor symmetries, and thus not renormalized at any order, suggesting that there is a fixed line in the infrared. Moreover, this “exactly dimensionless” coupling sets the hierarchy between the UV cutoff and the IR dynamical scale, with this hierarchy becoming exponentially large for $g_s \ll 1$. Near this “cusp”, our ignorance of the (stringy) UV physics becomes unimportant, and the infrared SCFT is accurately described by the IR dynamics of the effective field theory.

An alternate and perhaps more sophisticated viewpoint is described in [19]. We view the effective Lagrangian as a recipe for reaching the desired infrared fixed line via a series of flows beginning at a free UV fixed point, as follows. Starting with the free theory obtained by turning off all the couplings, we produce a series of flows by turning the couplings on one by one, only selecting relevant (or marginally relevant) couplings at each step of the process. After each flow, the dimensions of the remaining couplings will change, but there is always a relevant operator until the last step,¹⁰ when the only coupling remaining to be switched on is exactly marginal (see [48]). The fixed point so reached is the “cusp” itself, whereas turning on this last coupling (now parameterizing an exactly marginal operator) moves us out along the fixed line away from the cusp, see figure 6.

Phase III is slightly more subtle, in that the string construction involves overlapping NS5 branes, give rise to strongly coupled sectors. Thus, there is no perturbative effective field theory description even arbitrarily close to the cusp. However, this is easily avoided by some straightforward brane bending which leads to the Lagrangian description in figure 5(c), with field content

	$SU(N)$	$SU(N)$	$U(1)_B$	$U(1)_X$	$U(1)_Y$	$U(1)_R$
B_1	\square	$\bar{\square}$	$\frac{1}{N}$	1	0	$\frac{1}{2}$
B_2	\square	$\bar{\square}$	$\frac{1}{N}$	-1	0	$\frac{1}{2}$
C_1	$\bar{\square}$	\square	$-\frac{1}{N}$	0	-1	$\frac{1}{2}$
C_2	$\bar{\square}$	\square	$-\frac{1}{N}$	0	1	$\frac{1}{2}$
A_{11}	$\mathbf{1}$	\square	0	-1	1	1
A_{22}	$\mathbf{1}$	\square	0	1	-1	1
A_{12}	$\mathbf{1}$	$\square\square$	0	-1	-1	1
A_{21}	$\mathbf{1}$	$\square\square$	0	1	1	1

(2.9a)

and superpotential

$$W = \sum_{ij} \text{Tr}(A_{ij} B_i C_j). \quad (2.9b)$$

Note that, due to the brane bending, this Lagrangian *does not* describe the correct stringy physics at any finite energy scale. However, we expect it to flow to the same infrared fixed point as the correct string theory, i.e., the deformations introduced by the brane bending are irrelevant in the infrared. This is guaranteed if the brane bending preserves all the flavor symmetries and if the infrared theory lacks flavor-singlet relevant operators. Indeed, the relevant, supersymmetry-preserving deformations of an $\mathcal{N} = 1$ SCFTs are superpotential operators carrying $U(1)_R$ charge $2/3 \leq r < 2$, hence the associated couplings are charged

¹⁰One way to see this is to note that the exactly dimensionless coupling combination referenced above involves all the individual couplings, and vanishes when any of them vanish. This combination remains neutral under the spurious flavor symmetries at each step, and thus remains exactly dimensionless (in the absence of accidental symmetries). Therefore, it is the product of couplings whose dimensions add to zero, and so at least one of these couplings is relevant (positive dimension) or else they are all exactly marginal.

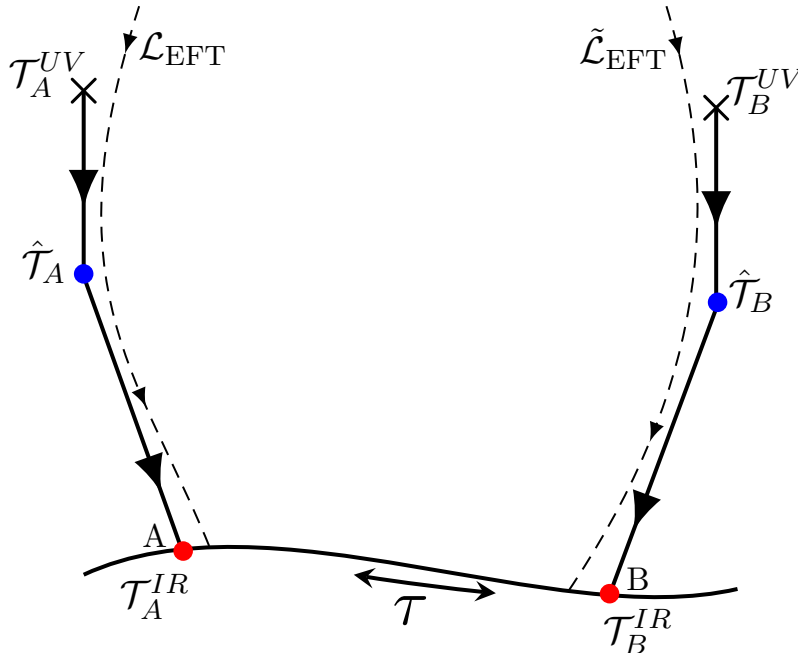

Figure 6: A schematic picture of S-duality in $\mathcal{N} = 1$ theories. Beginning with a free UV theory \mathcal{T}_A^{UV} , we turn on a sequence of relevant operators, producing a sequence of RG flows through intermediate CFTs $\hat{\mathcal{T}}_A$ until we reach an IR CFT \mathcal{T}_A^{IR} with one or more exactly marginal operators. These operators parameterize a fixed line on which \mathcal{T}_A^{IR} is a special point (typically with enhanced global symmetries) that we call a “cusp”. The fixed line can be reached directly by turning on all these operators simultaneously in the UV, but as some are dangerously irrelevant, the resulting EFT flow \mathcal{L}_{EFT} is typically not UV complete (except when the cusp is a free theory). S-duality occurs when multiple cusps lie on the same fixed line, or when non-trivial paths along the fixed line return to the same cusp (self-duality).

and the deformation breaks some of the flavor symmetries of the IR CFT. Thus, assuming no accidental abelian symmetries appear in the infrared (which can mix with $U(1)_R$), none of these relevant deformations can be induced by the brane bending, and we should reach the same infrared fixed point as the strongly coupled theory we started with.

These expectations are supported by very non-trivial checks, detailed in [19], due to the S-dualities relating different cusps on the conformal manifold, which are dynamically very nontrivial, but which follow a pattern that can be predicted by a simple analysis of torsion fluxes in the AdS dual, generalizing [33].

2.4 Deconfinement and quad CFTs

Phase I is much less familiar, even though (as argued in [19]) phases of this type turn out to be far more generic than the simpler cases considered above. As in phase III, the effective field theory arising from the string theory configuration does not admit a weakly coupled

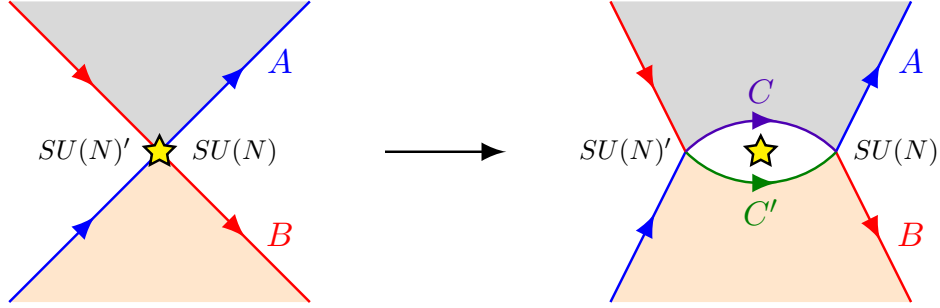

Figure 7: Antisymmetric tensor deconfinement as seen from the brane tiling point of view. On the left hand side we have two NS5 branes, A and B , intersecting on top of an orientifold plane (the star), giving rise to an antisymmetric representation of the $SU(N)$ flavour symmetry group, which here comes from the white wedge on the left/right (we denote by $SU(N)'$ its orientifold image). The deconfined description [27–29] arises from recombining the NS5 branes in a way that avoids the orientifold plane. 5-brane charge conservation requires the appearance of a D5 wrapping the disk bounded by the two new NS5 branes C and C' , leading to an extra (confining) USp factor.

[Figure reproduced from [18] with modifications.]

description at any energy scale, even arbitrarily close to the cusp. Rather, the physics is given by a weak gauging of diagonal subgroups of the symmetry group of strongly interacting SCFTs (heuristically, a “gluing of SCFTs” by weakly coupled sectors), very reminiscent of what happens in $\mathcal{N} = 2$ cases [1, 49]. In fact, we will see momentarily that resolutions of the singularity connect the SCFTs that arise in the $\mathcal{N} = 1$ case with those appearing in the $\mathcal{N} = 2$ case, as one might have guessed. Crucially, all of the $\mathcal{N} = 1$ SCFTs arising at the cusps can be obtained via a series of flows from a Lagrangian description, i.e., there are known non-conformal $\mathcal{N} = 1$ Lagrangian theories in the same universality class as the $\mathcal{N} = 1$ SCFTs arising at the cusps in the string configuration. This is the key point that makes many of the results in this paper possible.

The following construction explains why these theories exist. Recall that an intersection of two NS5 branes on top of an orientifold plane leads to two-index representations of the flavour $SU(N)$ symmetry group, as sketched on the left half of figure 7. We will only need to discuss the case of two-index antisymmetric representations. The strongly coupled SCFTs mentioned above are precisely those arising from $2k > 2$ NS5 branes intersecting atop an orientifold fixed point in the brane tiling. (Heuristically, the isolated SCFTs appearing at the cusps are interacting generalisations of the free antisymmetric chiral multiplet.)

In order to give Lagrangian descriptions of these SCFTs, we will reformulate the old idea of *deconfinement* [27–29] in the brane context. In these papers, the authors constructed confining $\mathcal{N} = 1$ theories that lead in the IR to a free chiral $\mathcal{N} = 1$ multiplet in the two-index antisymmetric representation of a $SU(N)$ flavour group. In the context of brane tilings, these deconfined descriptions for the antisymmetric can be understood as coming from a “bending”

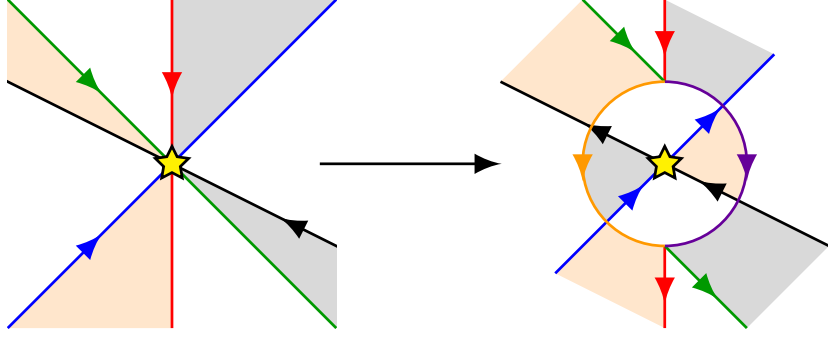

Figure 8: Deconfinement in the case of four NS5 brane intersecting on top of an orientifold point. Recombining two NS5s branes so that they avoid the intersection gives us a Lagrangian theory in the same universality class as the original theory. In this case we have kept two branes intersecting over the orientifold fixed point, leading to an antisymmetric chiral multiplet. It is possible to deconfine this multiplet if desired.

[Figure reproduced from [18] with modifications.]

of the brane system: while there is no motion in moduli space that moves the branes out of the fixed point, we can (at a cost in energy) recombine the brane system in a way that avoids the NS5 branes passing through the orientifold fixed point, as shown in figure 7. A careful analysis of the resulting brane system [18, 19] shows that it reproduces the deconfined description provided by [28, 29].¹¹ But crucially, the same brane bending operation can be applied in the $k > 1$ cases. We show the $k = 2$ example in figure 8. The Lagrangian theories that we write, although somewhat fearsome when written in quiver form, can be read off straightforwardly from this deconfined brane description.

The specific $\mathcal{N} = 1$ SCFTs arising in the $\mathcal{C}_{\mathbb{C}}(\mathbb{F}_0)$ case involve four NS5s intersecting over a fixed point. The resulting theories were denoted $\mathfrak{q}_{SO}^{\phi}(M)$ and $\mathfrak{q}_{USp}^{\phi}(M)$ in [18, 19]. We will now briefly review their properties to the extent needed for this paper. We refer to the original works for a more in-depth discussion.

The \mathfrak{q}_{USp} theories. This family of theories is parametrised by a positive integer M and a parity $\phi = \pm 1$. We denote an element of this family by $\mathfrak{q}_{USp}^{\phi}(M)$. The symmetry group of the SCFTs is $USp(2M) \times SU(M+4) \times U(1)^2 \times U(1)_R$. Crucially, there are known Lagrangian theories in the $\mathfrak{q}_{USp}^{\phi}(M)$ universality class. We denote these Lagrangian theories by $\mathcal{Q}_{USp}^A(M, F)$ and $\mathcal{Q}_{USp}^B(M, G)$, where F and G are positive integers such that $\phi = (-1)^F = (-1)^{G+M}$ and shifting F or G by even numbers leads to theories in the same universality class. The quiver and charge table for $\mathcal{Q}_{USp}^A(M, F)$ are shown in figure 9(a) and table 1, respectively. Note that

¹¹The deconfinement bubble, when seen from the point of view of the brane tiling, is one of the “geometrically inconsistent” tilings of [50, 51]. We hasten to emphasize that thanks to the orientifold projection, and despite the name “inconsistent” (which we will avoid), the configurations that we construct via this method are perfectly cromulent.

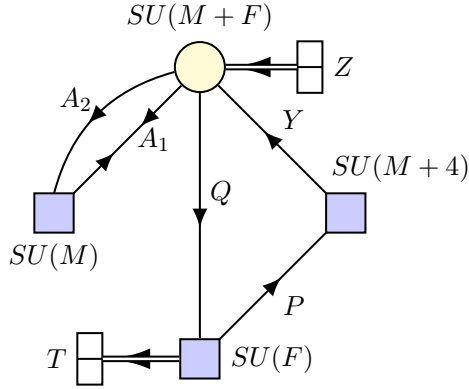

$$W = A_1 A_2 Z + P Q Y + T Q^2 Z$$

(a) Quiver and superpotential for \mathcal{Q}_{USp}^A .

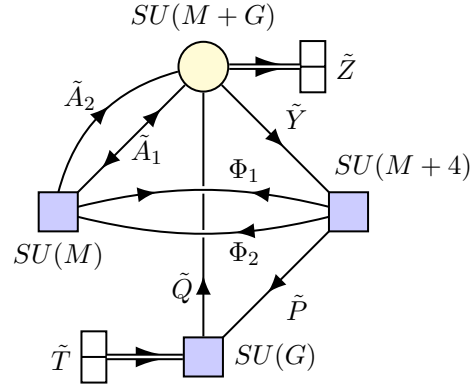

$$W = \tilde{A}_1 \tilde{A}_2 \tilde{Z} + \tilde{P} \tilde{Q} \tilde{Y} + \tilde{T} \tilde{Q}^2 \tilde{Z} + \Phi_1 \tilde{A}_1 \tilde{Y} + \Phi_2 \tilde{A}_2 \tilde{Y}$$

(b) Quiver and superpotential for \mathcal{Q}_{USp}^B .

Figure 9: Two Lagrangian descriptions of $\mathfrak{q}_{USp}^\phi(M)$, with $\phi = (-1)^F = (-1)^{G+M}$.

[Figures reproduced from [19] with modifications.]

	$SU(M+F)$	$SU(M)$	$SU(M+4)$	$SU(F)$	$U(1)_B$	$U(1)_X$	$U(1)_Y$	$U(1)_R$
A_1	\square	\square	$\mathbf{1}$	$\mathbf{1}$	$-\frac{1}{M+F}$	1	$\frac{M+4}{2(M+F)}$	$1 - \frac{M+4}{4(M+F)}$
A_2	\square	$\bar{\square}$	$\mathbf{1}$	$\mathbf{1}$	$-\frac{1}{M+F}$	-1	$\frac{M+4}{2(M+F)}$	$1 - \frac{M+4}{4(M+F)}$
Y	$\bar{\square}$	$\mathbf{1}$	\square	$\mathbf{1}$	$\frac{1}{M+F}$	0	$1 - \frac{M+4}{2(M+F)}$	$\frac{M+4}{4(M+F)}$
Z	$\bar{\square}$	$\mathbf{1}$	$\mathbf{1}$	$\mathbf{1}$	$\frac{2}{M+F}$	0	$-\frac{M+4}{M+F}$	$\frac{M+4}{2(M+F)}$
P	$\mathbf{1}$	$\mathbf{1}$	$\bar{\square}$	\square	$\frac{1}{F}$	0	$-1 + \frac{M+4}{2F}$	$2 + \frac{M-4}{4F}$
Q	\square	$\mathbf{1}$	$\mathbf{1}$	$\bar{\square}$	$-\frac{1}{M+F} - \frac{1}{F}$	0	$-\frac{M+4}{2F} + \frac{M+4}{2(M+F)}$	$-\frac{M-4}{4F} - \frac{M+4}{4(M+F)}$
T	$\mathbf{1}$	$\mathbf{1}$	$\mathbf{1}$	$\bar{\square}$	$\frac{2}{F}$	0	$\frac{M+4}{F}$	$2 + \frac{M-4}{2F}$

Table 1: The charge table for \mathcal{Q}_{USp}^A . The a -maximized R -charge is $U(1)_R^{\text{sc}} = U(1)_R + y_M U(1)_Y + (\frac{M+4}{4} y_M^2 - \frac{1}{3}) U(1)_B$ where y_M is the middle root of $9(M+4)y_M^3 + 9My_M^2 - 3(3M+4)y_M - M = 0$, varying between $y_0 = 0$ and $y_\infty \simeq -0.1018$.

although we only show $SU(M) \times U(1)_X \subset USp(2M)$ explicitly,¹² it is easy to see that the full symmetry group is indeed $USp(2M)$. Our reason for writing $SU(M) \times U(1)_X$ is that this is the subgroup that is readily apparent in the brane tiling construction.

A peculiarity of this deconfined description is that there is a field Q with negative a -maximized R -charge.¹³ This is a more extreme case of the common phenomenon (already

¹²To be precise, the global form of this subgroup is $U(M) = \frac{SU(M) \times U(1)_X}{\mathbb{Z}_M}$. In what follows, we will not track the global form of the global symmetry group for simplicity.

¹³Specifically, Q has negative a -maximized R -charge for $M \geq 6$ when $F = 1$, $M \geq 4$ when $F = 2$, $M \geq 3$ for $F = 3, 4, 5$ and $M \geq 2$ for larger F .

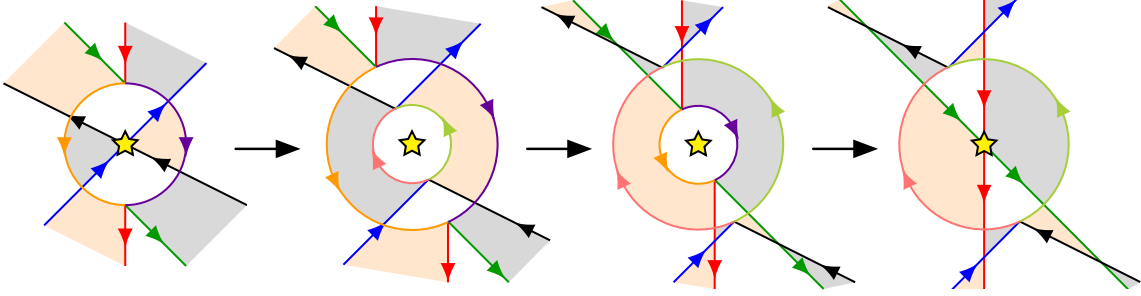

Figure 10: “Deconfinement duality” as seen from the brane tiling, which relates $\mathcal{Q}_{USp}^A(M, F)$ to $\mathcal{Q}_{USp}^B(M, G)$ with the constraint $\phi = (-1)^F = (-1)^{G+M}$.

[Figure reproduced from [18] with modifications.]

appearing in the conifold theory [52], for instance) in which fields in a Lagrangian have R -charges below the unitarity bound. As is well known, this is not a problem in the familiar cases: it is perfectly fine for Q to have negative R -charge, since it is not gauge invariant. It is only operators in the SCFT that need to have R -charges above the unitarity bound, but these operators are built out of gauge invariant combinations of fundamental fields, and in many cases (such as the conifold) it is easy to see that the gauge invariant operators do have R -charges above the unitarity bound.

In the theories at hand there is a second phenomenon at play: as explained in [18, 19], the $SU(F)$ symmetry is “trivial,” i.e., nothing is charged under this symmetry in the infrared. This can be shown by deconfining the antisymmetric tensor field Z in the $\mathcal{Q}_{USp}^A(M, F)$ Lagrangian, then switching to the Seiberg dual description of the $SU(M + F)$ gauge group and reconfining the deconfined USp gauge group (which happens to have the right number of flavors to be s-confining), as illustrated in brane tiling description in figure 10. This results in the $\mathcal{Q}_{USp}^B(M, G)$ Lagrangian, shown in figure 9(b) and table 2, where the $SU(G)$ flavor symmetry was introduced upon deconfinement and the $SU(F)$ becomes manifestly trivial upon reconfinement. The same process can be run in reverse, which brings us back to the $\mathcal{Q}_{USp}^A(M, F')$ Lagrangian, now with an a priori different $F' \neq F$. The only constraint is that $F + G + M$ is even (since $USp(n)$ is defined for even n), so the parity $\phi = (-1)^F = (-1)^{G+M} = (-1)^{F'}$ remains unchanged. Since different UV descriptions of the same infrared fixed point have different $SU(F)$ or $SU(G)$ symmetries, we conclude that these symmetries must be trivial.

Triviality implies that gauge invariant operators charged under $SU(F)$ or $SU(G)$ must disappear in the infrared. This removes many operators that would otherwise violate the unitarity bound. More generally, to the extent that we have been able to check, *all* operators appearing to violate the unitarity bound are lifted in the infrared, whether by this mechanism or due to other quantum effects. In many cases, this can be seen by choosing a convenient dual description in which the quantum effects in question become obvious, tree-level properties. Alternately, one can express the SCI in terms of a different R -symmetry (not the a -maximized,

	$SU(M+G)$	$SU(M)$	$SU(M+4)$	$SU(G)$	$U(1)_B$	$U(1)_X$	$U(1)_Y$	$U(1)_R$
\tilde{A}_1	$\bar{\square}$	$\bar{\square}$	$\mathbf{1}$	$\mathbf{1}$	$-\frac{1}{M+G}$	-1	$-\frac{M+4}{2(M+G)}$	$1 - \frac{M+4}{4(M+G)}$
\tilde{A}_2	$\bar{\square}$	\square	$\mathbf{1}$	$\mathbf{1}$	$-\frac{1}{M+G}$	1	$-\frac{M+4}{2(M+G)}$	$1 - \frac{M+4}{4(M+G)}$
\tilde{Y}	\square	$\mathbf{1}$	$\bar{\square}$	$\mathbf{1}$	$\frac{1}{M+G}$	0	$-1 + \frac{M+4}{2(M+G)}$	$\frac{M+4}{4(M+G)}$
\tilde{Z}	\square	$\mathbf{1}$	$\mathbf{1}$	$\mathbf{1}$	$\frac{2}{M+G}$	0	$\frac{M+4}{M+G}$	$\frac{M+4}{2(M+G)}$
\tilde{P}	$\mathbf{1}$	$\mathbf{1}$	\square	$\bar{\square}$	$\frac{1}{G}$	0	$1 - \frac{M+4}{2G}$	$2 + \frac{M-4}{4G}$
\tilde{Q}	$\bar{\square}$	$\mathbf{1}$	$\mathbf{1}$	\square	$-\frac{1}{M+G} - \frac{1}{G}$	0	$\frac{M+4}{2G} - \frac{M+4}{2(M+G)}$	$-\frac{M-4}{4G} - \frac{M+4}{4(M+G)}$
\tilde{T}	$\mathbf{1}$	$\mathbf{1}$	$\mathbf{1}$	$\bar{\square}$	$\frac{2}{G}$	0	$-\frac{M+4}{G}$	$2 + \frac{M-4}{2G}$
Φ_1	$\mathbf{1}$	\square	\square	$\mathbf{1}$	0	1	1	1
Φ_2	$\mathbf{1}$	$\bar{\square}$	\square	$\mathbf{1}$	0	-1	1	1

Table 2: The charge table for \mathcal{Q}_{USp}^B . Note that this can be obtained from table 1 by charge conjugating $U(1)_X$, $U(1)_Y$ and the non-abelian groups, replacing F with G and adding the mesons $\Phi_1 = A_1Y$ and $\Phi_2 = A_2Y$.

superconformal one) under which all the fundamental chiral superfields have charge $0 < r' < 2$. Computing the SCI order-by-order in this alternate basis, it is straightforward to check that all the problematic operators cancel from the index, up to the order computed.

Looking ahead, this subtlety will affect our Lagrangian description of the $R_{2,2n+1}$ theories with $n > 1$. So while this is a complication one should keep in mind in these cases (particularly when expanding the SCI), we believe that it is a purely technical one. In practice we often deal with this subtlety by computing the index in a modified basis, as described above, which is sufficient to check many dualities in great detail.

In order to keep track of the SCFTs in a concise way, and also to emphasize the fact that these sectors correspond to strongly coupled SCFTs even near the cusps, we introduce the “abstract quiver” notation in figure 11(a). The dashed lines correspond to the mesons $\Phi_1 = A_1Y$ and $\Phi_2 = A_2Y$, which are elementary fields in \mathcal{Q}_{USp}^B . We also indicate the parity $\phi = (-1)^F$ in the diagram (redundantly, next to each meson line, for reasons to be explained below).

In addition to the mesons $\Phi_{1,2}$, which combine into the bifundamental (\square, \square) representation of $USp(2M) \times SU(M+4)$, the \mathfrak{q}_{USp} theory contains baryons $\mathcal{A}_k, \mathcal{S}_k$, which can be expressed in terms of the \mathcal{Q}_{USp}^A fields as follows:¹⁴

$$\begin{aligned}
\mathcal{A}_k &= A_1^k A_2^{M-k} Q^F, & 0 \leq k \leq M, \\
\mathcal{S}_k &= Z^{\frac{F+k-4}{2}} R^{M+4-k}, & 0 \leq k \leq M+4, \quad (-1)^k = (-1)^F.
\end{aligned}
\tag{2.10}$$

Note that the baryons \mathcal{A}_k combine into the (irreducible) M -index antisymmetric tensor representation of $USp(2M)$.

¹⁴For simplicity we show the case $F > 2$. For $F = 1$ ($F = 2$) we have $\mathcal{S}_1 = P$ ($\mathcal{S}_0 = T$).

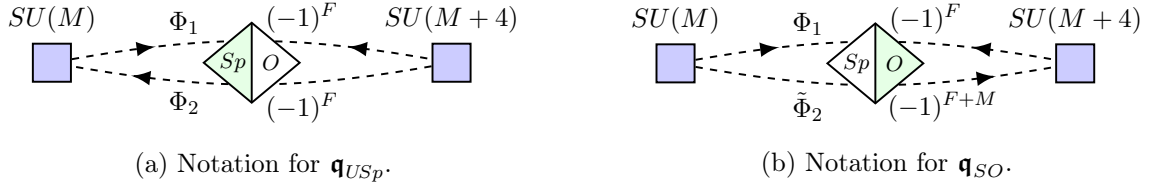

Figure 11: Abstract quiver notation for \mathfrak{q}_{USp} and \mathfrak{q}_{SO} . The dashed lines indicate the mesons Φ_1 and Φ_2 (\mathfrak{q}_{USp}) or $\tilde{\Phi}_2$ (\mathfrak{q}_{SO}), and the attached labels are their associated parities. The shaded half of the diamond distinguishes between \mathfrak{q}_{USp} and \mathfrak{q}_{SO} .

[Figures reproduced from [19] with modifications.]

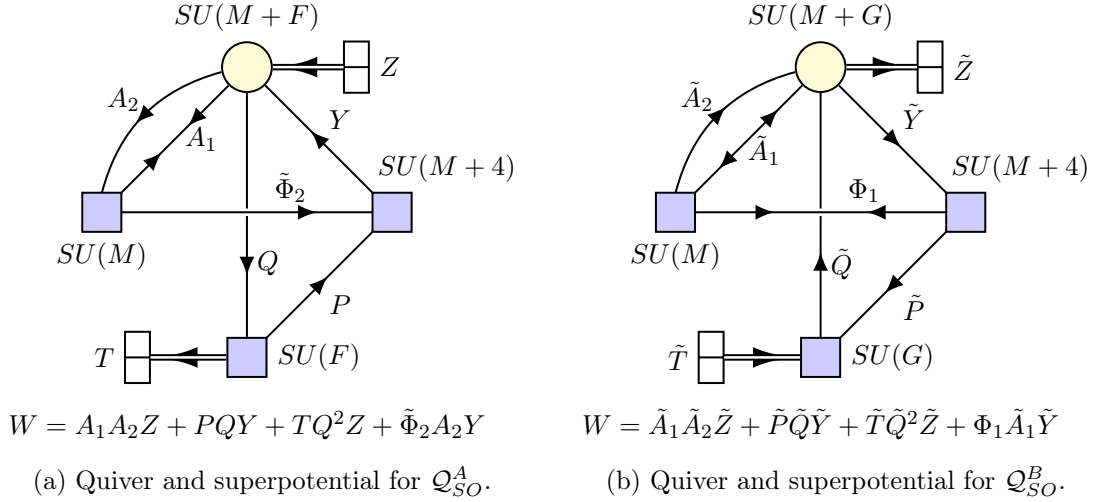

Figure 12: The two deconfined quivers for \mathfrak{q}_{SO} .

[Figures reproduced from [19] with modifications.]

The \mathfrak{q}_{SO} theories. A second family of theories that arise in the same context are the $\mathfrak{q}_{SO}^\phi(M)$ theories. These theories have global symmetry group $SU(M) \times \text{Spin}(2M+8) \times U(1)^2 \times U(1)_R$. Lagrangian theories in the $\mathfrak{q}_{SO}^\phi(M)$ universality class are also known, as shown in figure 12 and table 3, but unfortunately these Lagrangians do not preserve the full symmetry group of the theory, only a full-rank subgroup $SU(M) \times SU(M+4) \times U(1)^3 \times U(1)_R$, where $SU(M+4) \times U(1)_Y$ enhances to $\text{Spin}(2M+8)$ in the infrared under the standard embedding $U(n) \subset SO(2n)$.¹⁵

As before, there are two families of Lagrangians: $\mathcal{Q}_{SO}^A(M, F)$ and $\mathcal{Q}_{SO}^B(M, G)$, related by a deconfinement duality analogous to figure 10 for $(-1)^F = (-1)^{G+M}$. However, unlike before the Lagrangians $\mathcal{Q}_{SO}^A(M, F)$ and $\mathcal{Q}_{SO}^B(M, G)$ are isomorphic after relabeling $\tilde{A}_1 \rightarrow A_2$, $\tilde{A}_2 \rightarrow A_1$, $\Phi_1 \rightarrow \tilde{\Phi}_2$, charge conjugating the gauge group and $SU(M+4) \times U(1)_Y$, and identifying

¹⁵As with the \mathfrak{q}_{USp} theory, we are being somewhat imprecise about the global form of this manifest global symmetry group. In this case, the embedding $U(n) \subset SO(2n)$ lifts to $\tilde{U}(n) \subset \text{Spin}(2n)$ where $\tilde{U}(n)$ is a certain double-cover of $U(n)$, e.g., $\tilde{U}(2k) = \frac{SU(2k) \times U(1)}{\mathbb{Z}_k}$.

	$SU(M+F)$	$SU(M)$	$SU(M+4)$	$SU(F)$	$U(1)_B$	$U(1)_X$	$U(1)_Y$	$U(1)_R$
A_1	\square	\square	$\mathbf{1}$	$\mathbf{1}$	$-\frac{1}{M+F}$	1	$\frac{M+4}{2(M+F)}$	$1 - \frac{M+4}{4(M+F)}$
A_2	\square	$\bar{\square}$	$\mathbf{1}$	$\mathbf{1}$	$-\frac{1}{M+F}$	-1	$\frac{M+4}{2(M+F)}$	$1 - \frac{M+4}{4(M+F)}$
Y	$\bar{\square}$	$\mathbf{1}$	\square	$\mathbf{1}$	$\frac{1}{M+F}$	0	$1 - \frac{M+4}{2(M+F)}$	$\frac{M+4}{4(M+F)}$
Z	$\bar{\square}$	$\mathbf{1}$	$\mathbf{1}$	$\mathbf{1}$	$\frac{2}{M+F}$	0	$-\frac{M+4}{M+F}$	$\frac{M+4}{2(M+F)}$
P	$\mathbf{1}$	$\mathbf{1}$	$\bar{\square}$	\square	$\frac{1}{F}$	0	$-1 + \frac{M+4}{2F}$	$2 + \frac{M-4}{4F}$
Q	\square	$\mathbf{1}$	$\mathbf{1}$	$\bar{\square}$	$-\frac{1}{M+F} - \frac{1}{F}$	0	$-\frac{M+4}{2F} + \frac{M+4}{2(M+F)}$	$-\frac{M-4}{4F} - \frac{M+4}{4(M+F)}$
T	$\mathbf{1}$	$\mathbf{1}$	$\mathbf{1}$	\square	$\frac{2}{F}$	0	$\frac{M+4}{F}$	$2 + \frac{M-4}{2F}$
$\tilde{\Phi}_2$	$\mathbf{1}$	\square	$\bar{\square}$	$\mathbf{1}$	0	1	-1	1

Table 3: The charge table for \mathcal{Q}_{SO}^A , which can be obtained from table 1 by adding the elementary meson $\tilde{\Phi}_2$ (flipping $\Phi_2 = A_2 Y$). (Similarly, the charge table for \mathcal{Q}_{USp}^B can be obtained from table 2 by removing the elementary meson Φ_2 .) Doing so breaks $USp(2M) \rightarrow SU(M) \times U(1)_X$, but leads to the accidental enhancement $SU(M+4) \times U(1)_Y \rightarrow SO(2M+8)$ at the infrared fixed point. The a -maximized R -charge is $U(1)_R^{\text{sc}} = U(1)_R + x_M U(1)_X - (\frac{M}{4} x_M^2 + \frac{1}{3}) U(1)_B$ where x_M is the middle root of $9Mx_M^3 + 9(M+4)x_M^2 - 3(3M+8)x_M - (M+4) = 0$, varying between $x_0 \simeq -0.1381$ and $x_\infty \simeq -0.1018$.

$SU(G)$ with the charge conjugate of $SU(F)$. For odd M , combining the deconfinement duality and this isomorphism, we conclude that the two parities of F generate isomorphic CFTs. In fact, a more general class of deconfinement dualities shows that this remains true for even M [18], hence $\mathfrak{q}_{SO}^+(M) \cong \mathfrak{q}_{SO}^-(M)$, unlike $\mathfrak{q}_{USp}^+(M) \not\cong \mathfrak{q}_{USp}^-(M)$.

Note that the isomorphism between $\mathfrak{q}_{SO}^+(M)$ and $\mathfrak{q}_{SO}^-(M)$ involves the \mathbb{Z}_2 ‘‘parity’’ outer automorphism of $\text{Spin}(2M+8)$. For instance, the baryonic operators \mathcal{S}_k of the $\mathfrak{q}_{SO}^\phi(M)$ CFT (see (2.10)) combine into a Weyl spinor representation of $\text{Spin}(2M+8)$ whose chirality is determined by the flavor parity ϕ . For this reason, it is important to track F parity when the $\mathfrak{q}_{SO}(M)$ CFT is coupled to other sectors by a (partial) gauging of $\text{Spin}(2M+8)$ or by superpotential couplings to $\mathfrak{q}_{SO}(M)$ operators, as the \mathbb{Z}_2 outer automorphism acts nontrivially on these couplings.

In particular, when $\mathfrak{q}_{SO}(M)$ is embedded in a larger brane tiling, typically only $SU(M+4) \times U(1) \subset \text{Spin}(2M+8)$ remains unbroken, and we need to specify which precise subgroup this is. We do so as follows: consider the mesons $\Phi_1 = A_1 Y$ and $\tilde{\Phi}_2 = \tilde{A}_2 \tilde{Y}$, which are composites in \mathcal{Q}_{SO}^A and \mathcal{Q}_{SO}^B , respectively, and elementary fields in the other phase. We attach to each of these mesons a parity given by the F parity of the phase in which this meson is *composite* (this choice of convention allows us to use the same prescription for the \mathfrak{q}_{USp} case). That is, we assign parity $(-1)^F$ to Φ_1 and $(-1)^G$ to $\tilde{\Phi}_2$. The two parities are related by $(-1)^M$, so for any fixed M either parity can be specified (we will often specify both). Specifying these parities in figure 11(b) tells us which precise $SU(M+4) \times U(1)$ subgroup of

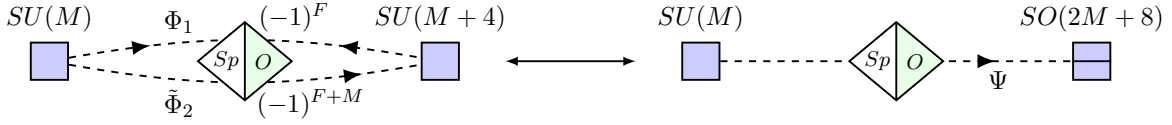

Figure 13: Comparison of different abstract quiver notations for the \mathfrak{q}_{SO} CFT. In the right-hand diagram the enhanced $\text{Spin}(2M + 8)$ symmetry is manifest.

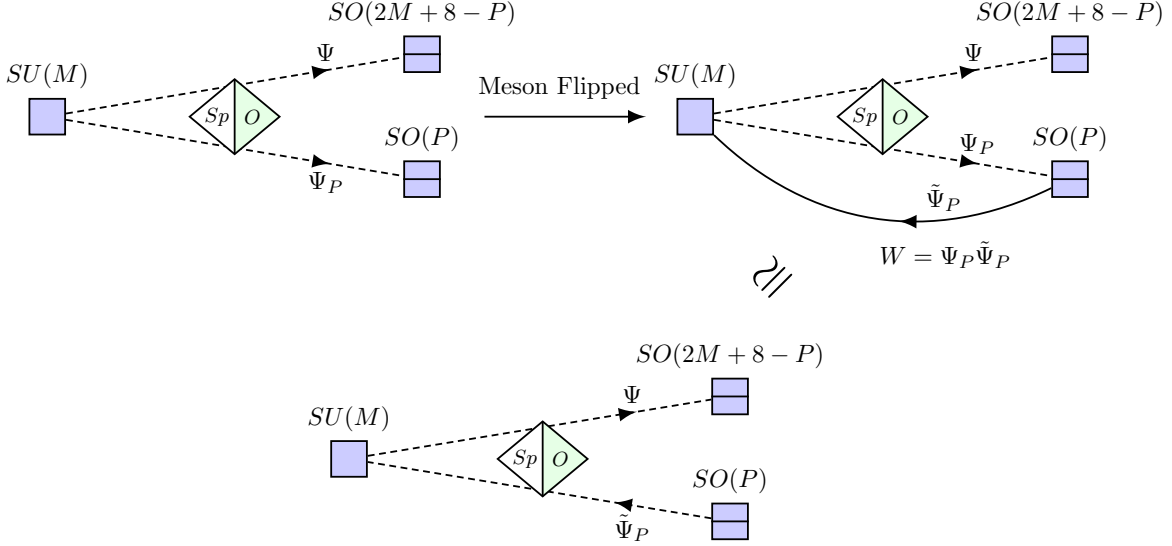

Figure 14: Partially flipping the \mathfrak{q}_{SO} CFT in the language of the abstract quiver.

$\text{Spin}(2M + 8)$ is realized in the brane tiling.

Finally, we discuss certain “partially flipped” versions of the \mathfrak{q}_{SO} theory that will appear in our construction of the $R_{2,k}$ theory for odd k . To simplify the discussion, we adopt an abstract quiver notation that makes the full $\text{Spin}(2M + 8)$ symmetry manifest, as shown in figure 13. Next, we decompose $\text{Spin}(2M + 8) \rightarrow \text{Spin}(2M + 8 - P) \times \text{Spin}(P)$, whereupon the meson Φ in the (\square, \square) representation of $SU(M) \times \text{Spin}(2M + 8)$ decomposes into mesons Ψ and Ψ_P in the $(\square, \square, \mathbf{1})$ and $(\square, \mathbf{1}, \square)$ representations of $SU(M) \times \text{Spin}(2M + 8 - P) \times \text{Spin}(P)$, respectively. Next, we flip the meson Ψ_P to obtain a meson $\tilde{\Psi}_P$ in the $(\bar{\square}, \mathbf{1}, \square)$ representation of $SU(M) \times \text{Spin}(2M + 8 - P) \times \text{Spin}(P)$.

The entire process is illustrated in figure 14. In this way, we obtain a closely related CFT with an $SU(M) \times \text{Spin}(2M + 8 - P) \times \text{Spin}(P) \times U(1)^2 \times U(1)_R$ symmetry. As we will see in §3.2, gauging part of the global symmetry of this theory (for $P = 2$ and even $M = k - 1$) generates a flow to the $R_{2,k}$ (odd k) CFT plus a free chiral multiplet.

A similar partial flipping can be applied to the \mathfrak{q}_{USp} theory, but as we will not make use of it in the present paper, the details are left as an exercise for the interested reader.

2.5 Flux assignments and duality

The map between fluxes at infinity and the choice of phase goes as follows. Choose a basis of $H^3(X_5; \tilde{\mathbb{Z}}) = \mathbb{Z}_2 \oplus \mathbb{Z}_2$ given by two elements $\langle a \rangle$ and $\langle b \rangle$.¹⁶ Then we can parametrise the NSNS flux in this basis by $H_3 = \alpha \langle a \rangle + \beta \langle b \rangle$. In terms of this basis, we have the following dictionary between phases and H_3 flux:

$$\begin{array}{c|cccc} \text{Phase:} & \text{I} & \text{II} & \tilde{\text{II}} & \text{III} \\ \hline H_3 \text{ torsion} & (00) & (10) & (01) & (11) \end{array} \quad (2.11)$$

Note that while the (10) and (01) choices of flux are different, they are related by symmetries of the geometry, and thus lead to isomorphic physics at the cusp.

This prescription covers the NSNS half of the dictionary between flux and physics at the cusp. Coming back to the case of O3 planes in flat space, this would be analogous to explaining that non-trivial NSNS torsion takes us from \mathfrak{so} to \mathfrak{usp} in the $\mathcal{N} = 4$ theory. As in that case, the choice of RR torsion is somewhat more subtle, and has to do with the ranks of the gauge factors. The RR torsion can also be parametrised as $F_3 = \alpha_F \langle a \rangle + \beta_F \langle b \rangle$. Recall that a shift of C_0 by 1 unit acts as $F_3 \rightarrow F_3 + H_3$, so for a given nonzero choice of H_3 there will be multiple assignments of F_3 that lead to the same perturbative physics. For instance, for phase II, with $H_3 = \langle a \rangle$, it is only the choice of β_F that can have an effect on the field theory. And indeed, for phase II one finds [19]

$$\text{II:} \quad \beta_F \equiv N \pmod{2}, \quad (2.12)$$

where N refers to the rank in figure 5(b). Similarly for phase III

$$\text{III:} \quad \alpha_F + \beta_F \equiv N \pmod{2} \quad (2.13)$$

with N as in figure 5(c). Finally, in the case of phase I in figure 5(a) we have two parities affecting the physics at the cusp. Let us denote $\phi_1 = (-1)^{F_1}$ and $\phi_2 = (-1)^{F_2}$. Then

$$\text{I:} \quad \beta_F \equiv F_1 \pmod{2} \quad (2.14)$$

$$\alpha_F \equiv F_2 \pmod{2}. \quad (2.15)$$

With this dictionary between fluxes and parities in hand we can now read the duality multiplets. We have defined N in figure 5 so that if the discrete flux agrees between two phases with the same choice of N , then the theories are in fact dual, so in what follows we will only specify the parities. In order to keep track of this, we denote phase I with parities ϕ_1 and ϕ_2 as $\text{I}^{\phi_1\phi_2}$, and we write II^ϕ and III^ϕ for phases II and III with $\phi := (-1)^N$.

Consider for example I^{++} . According to our discussion above, we have $H_3 = F_3 = 0$, so this phase is expected to be a $SL(2, \mathbb{Z})$ singlet. That is, all cusps in the conformal manifold induced by changing the IIB axio-dilaton have the same effective description. This is no longer

¹⁶These basis elements are associated to any two neighbouring non-compact divisors in the toric diagram for $\mathcal{C}_{\mathbb{C}}(\mathbb{F}_0)$. We refer to [19] for details of this construction.

true for I^{+-} . This phase has $H_3 = 0$ and $F_3 = \langle a \rangle$. Acting with the S generator of $SL(2, \mathbb{Z})$ we obtain $H_3 = \langle a \rangle$ and $F_3 = 0$, which corresponds to II^+ . So in this case we have a non-trivial duality between the ordinary cusp of type II (with N even) and a more exotic theory of type I, involving the \mathfrak{q}_{USp} and \mathfrak{q}_{SO} theories discussed above.

Other cases can be worked out similarly. For instance, I^{-+} is dual to \tilde{II}^+ and I^{--} is dual to III^+ . Perhaps more interestingly, the conformal manifold of the II^- theory involves cusps of type \tilde{II}^- and III^- , as one can readily verify. Since due to the very symmetric form of \mathbb{F}_0 phases II and \tilde{II} are isomorphic, we can think of this case as a duality between III^- and II^- .

3 $\mathcal{N} = 1$ Lagrangians for the $R_{2,k}$ SCFTs

In the previous section we have reviewed which kind of theories appear in the cusps of the conformal manifold of the $\mathcal{C}_{\mathbb{C}}(\mathbb{F}_0)$ SCFTs for different choices of discrete fluxes, and in particular we have given Lagrangians for all of them. We have also explained how all of these theories are related by S-duality. Coming back to the diagram (1.6), this provides all of the information that we need on the left-hand side of the diagram. Next, by Higgsing these theories we will obtain $\mathcal{N} = 1$ Lagrangians flowing to the $\mathcal{N} = 2$ theories that appear on the right-hand side of this diagram.

First, we will need to know the relation between the $\mathcal{N} = 2$ and $\mathcal{N} = 1$ symmetry groups. The following material is standard, so we will be brief. A longer discussion can be found in [3, 4, 53], for instance. Consider an $\mathcal{N} = 2$ SCFT with symmetry group G . What we mean by this is that the SCFT has symmetry group G and an R -symmetry group $SU(2)_R \times U(1)_r^{\mathcal{N}=2}$. The $\mathcal{N} = 2$ theory will have Coulomb and Higgs branches, which we explore by turning on operators neutral under $SU(2)_R$ and $U(1)_r^{\mathcal{N}=2}$ respectively.

The $\mathcal{N} = 2$ theory can be viewed as a $\mathcal{N} = 1$ SCFT, with an R -symmetry $U(1)_R$, and an additional global symmetry $U(1)_{\mathfrak{A}}$ (so, from the $\mathcal{N} = 1$ point of view, our theory has non- R global symmetry $G \times U(1)_{\mathfrak{A}}$). The $\mathcal{N} = 1$ generators can be written in terms of the $\mathcal{N} = 2$ generators as

$$\begin{aligned} U(1)_R &= \frac{2}{3}U(1)_R^{\mathcal{N}=2} + \frac{1}{3}U(1)_r^{\mathcal{N}=2}, \\ U(1)_{\mathfrak{A}} &= U(1)_R^{\mathcal{N}=2} - U(1)_r^{\mathcal{N}=2} \end{aligned} \tag{3.1}$$

where we have chosen a Cartan generator $U(1)_R^{\mathcal{N}=2}$ of $SU(2)_R$. Our conventions for $U(1)_R^{\mathcal{N}=2}$ are that the $U(1)_R^{\mathcal{N}=2}$ charge is twice the spin (so, for instance, the spin-1/2 representation of $SU(2)_R$ has $Q_R^{\mathcal{N}=2} = \pm 1$). Equivalently, we can write the $\mathcal{N} = 2$ generators in terms of the $\mathcal{N} = 1$ generators as

$$\begin{aligned} U(1)_R^{\mathcal{N}=2} &= U(1)_R + \frac{1}{3}U(1)_{\mathfrak{A}} \\ U(1)_r^{\mathcal{N}=2} &= U(1)_R - \frac{2}{3}U(1)_{\mathfrak{A}}. \end{aligned} \tag{3.2}$$

After establishing R charge relations between the $\mathcal{N} = 2$ and $\mathcal{N} = 1$ symmetry groups, we now consider the effect on the field theory of partially resolving the $\mathcal{C}_{\mathbb{C}}(\mathbb{F}_0)$ singularity to two copies of $\mathbb{C}^2/\mathbb{Z}_2 \times \mathbb{C}$. We choose to start by studying the effect of the partial resolution on phase III, for reasons that will become clear momentarily. By using the general methods of [30] (or simply by trial and error) it is easy to conclude that turning on a vev for C_1 proportional to the identity triggers the relevant partial resolution in the geometry, where we are using the nomenclature in the charge table (2.9a). We will refer to giving such a vev in a more gauge-invariant way as giving a vev to “ C_1^N ”, which is a shorthand for the gauge invariant baryon $\det(C_1)$.

This vev spontaneously breaks one linear combination of the four $U(1)$ symmetries of the parent theory, and Higgses the $SU(N) \times SU(N)$ gauge group to the diagonal $SU(N)$. After Higgsing, C_2 decomposes in $\text{Adj} \oplus \mathbf{1}$ and $B_{1,2}$ into two copies of $\square \oplus \bar{\square}$, where the superpotential (2.9b) gives the antisymmetric part of B_1 and the symmetric part of B_2 a mass with A_{11} and A_{21} , respectively. After integrating out the massive fields and dropping the decoupled chiral field v controlling the vev, an accidental $U(1)_z$ symmetry emerges in the infrared. Putting all the pieces together, relabeling the fields, and choosing a new basis for the $U(1)$ symmetries that will be convenient later, we obtain:

	$SU(N)$	$U(1)_x$	$U(1)_z$	$U(1)_{\mathcal{A}}$	$U(1)_R$
Φ	Adj	0	0	-2	$\frac{2}{3}$
S	\square	$\frac{1}{2} - \frac{1}{2N}$	$\frac{1}{N}$	1	$\frac{2}{3}$
S_b	$\bar{\square}$	$\frac{1}{2N} - \frac{1}{2}$	$-\frac{1}{N}$	1	$\frac{2}{3}$
A	\square	$-\frac{1}{2N} - \frac{1}{2}$	$\frac{1}{N}$	1	$\frac{2}{3}$
A_b	$\bar{\square}$	$\frac{1}{2N} + \frac{1}{2}$	$-\frac{1}{N}$	1	$\frac{2}{3}$
ϕ	1	0	0	-2	$\frac{2}{3}$

(3.3a)

with superpotential

$$W = \text{Tr}(A\Phi A_b + A\phi A_b + S\Phi S_b + S\phi S_b). \quad (3.3b)$$

This is the $\mathcal{N} = 1$ description of the $\mathcal{N} = 2$ theory with quiver (in $\mathcal{N} = 2$ notation)

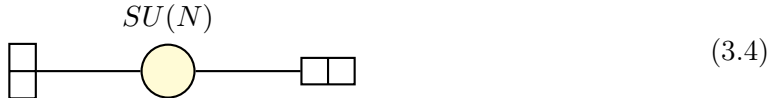

coupled to a gauge singlet chiral multiplet ϕ .

To understand the appearance of this “extra” chiral field ϕ , note that the previously-isolated singularity blows up into a \mathbb{P}^1 line of singularities following the partial resolution. Thus, we naturally interpret ϕ as the center of mass mode for the D3 brane stack moving

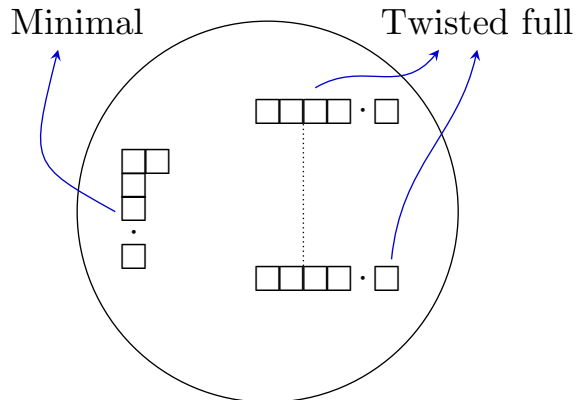

Figure 15: Class \mathcal{S} description of the $R_{2,k}$ theories.

along the \mathbb{P}^1 . In the decompactification limit $\mathbb{P}^1 \rightarrow \mathbb{C}$, $\mathcal{N} = 2$ SUSY is restored, and ϕ should be paired with a massless photon to complete an $\mathcal{N} = 2$ vector multiplet. Specifically, as dictated by ϕ 's superpotential interactions in (3.3b), the massless photon in question gauges the global symmetry $U(1)_z$ in (3.3a). Since D-branes naturally engineer $U(N)$ gauge theories rather than $SU(N)$ gauge theories, the appearance of this extra photon is not a surprise.¹⁷ However, as its interactions make it infrared free, this photon (along with ϕ) will decouple from the infrared CFT.

Thus, in order to focus on the interacting sector of the resulting $\mathcal{N} = 2$ SCFT, we omit this extra $U(1)$ and also remove its $\mathcal{N} = 2$ superpartner by adding a new singlet field $\bar{\phi}$ with opposite global charges and modifying the superpotential to

$$W = \text{Tr}(A\Phi A_b + A\phi A_b + S\Phi S_b + S\phi S_b) + \phi\bar{\phi}. \quad (3.5)$$

Following, e.g., [54], we refer to this operation (which can be applied to any gauge invariant operator ϕ) as “flipping ϕ ”. In this case, flipping ϕ gives it a mass, and after integrating it out we obtain the manifestly $\mathcal{N} = 2$ theory with quiver (3.4).

Our general strategy now allows us to give a Lagrangian description of the strongly coupled limit of this theory. Before doing that, we will briefly review what is known about this case in the class \mathcal{S} context. As it turns out, the strong coupling behaviour depends on whether N is even or odd — in agreement with our observation above that the duals of III^+ and III^- are rather different: the former is dual to I^- while the latter is dual to II^- .

The odd N case was studied from the class \mathcal{S} perspective in [55]. Setting $N = k + 1$ (where k is even), we have that the strongly coupled dual of (3.4) is given by $R_{2,k} \leftrightarrow USp(k)$, where $R_{2,k}$ is defined to be the SCFT arising from putting the six dimensional $A_k(2,0)$ theory

¹⁷Likewise, this is the result if we write the UV theory in (2.9b) as $U(N) \times U(N)$ gauge theory—reinstating the $U(1)$ factors that we have ignored until now—with the caveat that one of these $U(1)$ s is anomalous and so the associated photon gets a Green-Schwarz mass. Indeed, the “accidental” symmetry $U(1)_z$ can be viewed as arising from this anomalous $U(1)$.

$$\begin{array}{ccccc}
& & \mathcal{T} & & \\
& & \curvearrowright & & \\
& & SU(N) & & (SU(N)/\mathbb{Z}_2)_+ \xleftrightarrow{\mathcal{T}} (SU(N)/\mathbb{Z}_2)_- \\
& & \updownarrow \mathcal{S} & & \updownarrow \mathcal{S} \\
R_{2,k} \leftrightarrow SO(N+1)_+ & R_{2,k} \leftrightarrow \text{Spin}(N+1) & & R_{2,k} \leftrightarrow SO(N+1)_- & \\
& & \curvearrowleft & & \curvearrowleft \\
& & \mathcal{T} & & \mathcal{T}
\end{array}$$

Figure 16: Duality orbits of the quiver (3.4) for $N = 4m + 2$ ($N > 2$).

on a sphere with three punctures. Two of these punctures are full twisted punctures, and the other is a minimal untwisted puncture, see figure 15. We use the notation $\mathcal{T} \leftrightarrow G$ to indicate that we weakly gauge a subgroup G of the global symmetry group of the SCFT \mathcal{T} . The $R_{2,k}$ SCFT for k even has global symmetry group $USp(2k) \times U(1)$ and central charges

$$24a = 1 + \frac{19}{2}k + \frac{7}{2}k^2, \quad (3.6a)$$

$$12c = 1 + 5k + 2k^2. \quad (3.6b)$$

The $USp(2k)$ global symmetry has level $k_{USp(2k)} = k + 2$. Additionally, it has a Witten (or “global”) anomaly [56, 57]. The Argyres-Wittig theory [58] arises in the case $N = 3$, or equivalently $k = 2$.

The even N case was studied from the class \mathcal{S} perspective in §3.5.4 of [59]. Again setting $N = k + 1$, the S-dual is expected to be $R_{2,k} \leftrightarrow SO(k + 2)$, where the $R_{2,k}$ CFT for odd k has global symmetry $\text{Spin}(2k + 4) \times U(1)$ with level $k_{\text{Spin}(2k+4)} = 2k$.

To be precise, the S-dual depends on the global structure of the gauge group in the original quiver (3.4). Since N is even, there is a \mathbb{Z}_2 subgroup of the \mathbb{Z}_N center of $SU(N)$ under which two-index tensor reps are neutral, so we can choose the gauge group to be either $SU(N)$, $(SU(N)/\mathbb{Z}_2)_+$ or $(SU(N)/\mathbb{Z}_2)_-$, where in the latter cases the subscript indicates the absence (+) or presence (−) of a discrete theta angle [60, 61]. In each case, there is a \mathbb{Z}_2 one-form symmetry [62], which is either electric, magnetic, or dyonic, respectively.

Thus, the S-dual should have a \mathbb{Z}_2 one-form symmetry as well. This is the case, because the gauged subgroup is embedded as $SO(k + 2) \subset SU(k + 2) \subset \text{Spin}(2k + 4)$, implying that there are no $SO(k + 2)$ spinors in the spectrum. Thus, we can gauge either $\text{Spin}(k + 2)$, $SO(k + 2)_+$ or $SO(k + 2)_-$ where the subscript again indicates presence or absence of a discrete theta angle, and there is once again an electric, magnetic, or dyonic \mathbb{Z}_2 one-form symmetry in each case, respectively. Examining the class \mathcal{S} description, we conclude that electric and magnetic lines are exchanged by the duality as usual, which implies to the duality orbits shown in figures 16 and 17 (see [61] for the action of T in each case).

$$\begin{array}{ccc}
\begin{array}{c} T \\ \curvearrowright \\ SU(N) \\ \Uparrow S \\ R_{2,k} \leftrightarrow SO(N+1)_+ \\ \curvearrowleft \\ T \end{array} &
\begin{array}{c} T \\ \curvearrowright \\ (SU(N)/\mathbb{Z}_2)_+ \\ \Uparrow S \\ R_{2,k} \leftrightarrow \text{Spin}(N+1) \\ \curvearrowleft \\ T \end{array} &
\begin{array}{c} T \\ \curvearrowright \\ (SU(N)/\mathbb{Z}_2)_- \\ \Uparrow S \\ R_{2,k} \leftrightarrow SO(N+1)_- \\ \curvearrowleft \\ T \end{array}
\end{array}$$

Figure 17: Duality orbits of the quiver (3.4) for $N = 4m$.

For future reference, the central charges of the $R_{2,k}$ CFT with odd k are [63]

$$24a = -4 + \frac{9}{2}k + \frac{7}{2}k^2, \quad (3.7a)$$

$$12c = -1 + 3k + 2k^2. \quad (3.7b)$$

The case $N = 4$ gives rise to $R_{2,3}$, which is the E_6 Minahan-Nemeschansky theory [59], or equivalently the T_3 theory arising from putting the $A_2(2,0)$ theory on a sphere with three (untwisted) full punctures.

3.1 Even k

We now reproduce these results from a UV $\mathcal{N} = 1$ Lagrangian, constructed according to the general procedure outlined in the introduction. We start with the even k (i.e., odd N) case, as it is somewhat simpler.

The starting point is to identify the operator in phase II dual to C_1^N . This can be done, e.g., by matching the $U(1)^4$ charges of the gauge-invariant chiral operators in the dual descriptions. Referring to (2.8a), (2.9a), we see that

$$\begin{array}{c|cccc}
& U(1)_B & U(1)_X & U(1)_Y & U(1)_R \\
\hline
[C_1^N]_{\text{III}} & -1 & 0 & -N & \frac{N}{2} \\
[B_1^{N-1}B_2]_{\text{II}} & -1 & 0 & -N & \frac{N}{2}
\end{array} \quad (3.8)$$

so the phase II dual of C_1^N is $B_1^{N-1}B_2$, where we again use a condensed notation to refer to the gauge invariant baryonic operator built out of $N-1$ copies of B_1 and one B_2 . Turning on this vev triggers an RG flow, and after integrating out the massive states we end up with an accidental $U(1)$ in the infrared, just like in phase III. After relabeling the fields and choosing

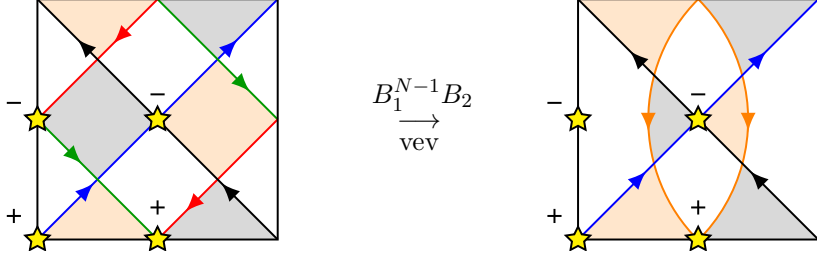

Figure 18: Effect of the Higgsing on the brane tiling for phase II.

an appropriate basis for the $U(1)$ symmetries, we obtain¹⁸

	$SU(N)$	$USp(N-1)$	$U(1)_x$	$U(1)_z$	$U(1)_\mathcal{R}$	$U(1)_R$
Y_1	$\bar{\square}$	1	0	1	$\frac{1}{N}$	$1 - \frac{1}{3N}$
Y_2	$\bar{\square}$	1	0	-1	$\frac{1}{N}$	$1 - \frac{1}{3N}$
A_1	\square	1	0	0	$-\frac{2(N+1)}{N}$	$\frac{2}{3N} + \frac{2}{3}$
A_2	\square	1	0	0	$-\frac{2}{N}$	$\frac{2}{3N}$
X_1	$\bar{\square}$	\square	$\frac{1}{2}$	0	$\frac{N+1}{N}$	$\frac{2}{3} - \frac{1}{3N}$
X_2	$\bar{\square}$	\square	$-\frac{1}{2}$	0	$\frac{N+1}{N}$	$\frac{2}{3} - \frac{1}{3N}$
S	1	\square	0	0	-2	$\frac{2}{3}$

(3.9a)

with superpotential

$$W = \text{Tr}(A_1 X_1 X_2 + A_2 S X_1 X_2 + A_2 Y_1 Y_2). \quad (3.9b)$$

As shown in figure 18, the Higgsing can also be understood from the point of view of the brane tiling. Turning on the vev for $B_1^{N-1} B_2$ induces a recombination of two of the NS5 branes. The recombined system of branes will relax to a configuration with two NS5 branes on top of each other, leading to a strongly coupled SCFT. As usual, we obtain a Lagrangian for this SCFT by bending the recombined branes slightly, yielding the Lagrangian description in (3.9). Based on the known class \mathcal{S} results above, we expect that the strongly coupled sector in the brane tiling is the $R_{2,N-1}$ theory. As an additional piece of evidence in favour of this idea, note that the weakly-coupled part of the tiling has a gauge group $USp(N-1)$, in agreement with the the class \mathcal{S} prediction.

This will indeed be the case, but we need to take care of one technical point first: in order to obtain the $\mathcal{N} = 2$ quiver theory (3.4) from partial resolution of phase III, we had to flip the singlet ϕ . Thus, to obtain the S-dual of theory from partial resolution of phase II, we must flip the operator dual to ϕ . As before, this operator can be identified by matching its

¹⁸Although we have not indicated it explicitly, there is naturally an extra “ $SO(1)$ ” gauge factor under which the Y_i fields are charged.

$U(1)^4$ charges with ϕ , whose charges are shown in (3.3a). Comparing with (3.9), we identify the gauge-invariant operator A_2^N as the dual of ϕ . The flipped theory is therefore:

	$SU(N)$	$USp(N-1)$	$U(1)_x$	$U(1)_z$	$U(1)_\mathfrak{R}$	$U(1)_R$
Y_1	$\bar{\square}$	1	0	1	$\frac{1}{N}$	$1 - \frac{1}{3N}$
Y_2	$\bar{\square}$	1	0	-1	$\frac{1}{N}$	$1 - \frac{1}{3N}$
A_1	\square	1	0	0	$-\frac{2(N+1)}{N}$	$\frac{2}{3N} + \frac{2}{3}$
A_2	\square	1	0	0	$-\frac{2}{N}$	$\frac{2}{3N}$
X_1	$\bar{\square}$	\square	$\frac{1}{2}$	0	$\frac{N+1}{N}$	$\frac{2}{3} - \frac{1}{3N}$
X_2	$\bar{\square}$	\square	$-\frac{1}{2}$	0	$\frac{N+1}{N}$	$\frac{2}{3} - \frac{1}{3N}$
S	1	\square	0	0	-2	$\frac{2}{3}$
$\bar{\phi}$	1	1	0	0	2	$\frac{4}{3}$

(3.10a)

with superpotential

$$W = \text{Tr}(A_1 X_1 X_2 + A_2 X_1 S X_2 + A_2 Y_1 Y_2) + \bar{\phi} A_2^N. \quad (3.10b)$$

Putting together the results of our analysis with the previous class \mathcal{S} analysis, we conclude that this Lagrangian theory is in the same universality class as $R_{2,N-1} \leftrightarrow USp(N-1)$ for odd N . To isolate $R_{2,N-1}$ itself, we set the $USp(N-1)$ gauge coupling to zero and remove the associated vector multiplets from the theory. In fact, the $\mathcal{N} = 2$ adjoint vector multiplet of $USp(N-1)$ includes the chiral field S in addition to the $\mathcal{N} = 1$ adjoint vector multiplet, so to preserve $\mathcal{N} = 2$ supersymmetry in the infrared, we also decouple and remove S .

In terms of the brane tiling, this corresponds to decompactifying in the horizontal direction, focusing in on the strongly coupled sector as depicted in figure 19. This sends the gauge and superpotential couplings associated to the $USp(N-1)$ vector multiplet to zero as the corresponding branes become infinitely large. Likewise, the vector multiplet components themselves either become non-normalizable or are pushed off to infinity, freezing these modes out of the theory.

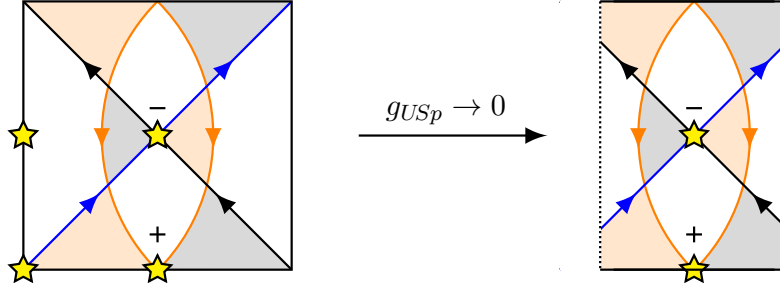

Figure 19: Sending the gauge coupling of the $USp(N-1)$ factor to 0. In terms of the brane tiling this amounts to stretching the torus horizontally so it becomes an infinite cylinder, or equivalently focusing on the region close to the SU factor.

The resulting Lagrangian theory has matter content

	$SU(N)$	$USp(2(N-1))$	$U(1)_z$	$U(1)_R$	$U(1)_R$
Y_1	$\bar{\square}$	1	1	$\frac{1}{N}$	$1 - \frac{1}{3N}$
Y_2	$\bar{\square}$	1	-1	$\frac{1}{N}$	$1 - \frac{1}{3N}$
A_1	\square	1	0	$-\frac{2(N+1)}{N}$	$\frac{2(N+1)}{3N}$
A_2	\square	1	0	$-\frac{2}{N}$	$\frac{2}{3N}$
X	$\bar{\square}$	\square	0	$\frac{1}{N} + 1$	$\frac{2}{3} - \frac{1}{3N}$
$\bar{\phi}$	1	1	0	2	$\frac{4}{3}$

(3.11a)

with superpotential

$$W = \text{Tr}(A_1 X^2 + A_2 Y_1 Y_2) + \bar{\phi} A_2^N. \quad (3.11b)$$

Note that decompactifying the brane tiling in this way manifestly enhances $USp(N-1) \rightarrow SU(N-1)$ due to the disappearance of the O5 plane generating the orientifold projection in question. However, the resulting Lagrangian accidentally acquires an even larger symmetry $USp(2(N-1)) \supset SU(N-1) \times U(1)_x$, which we have made manifest in table above.

We therefore conclude that the $\mathcal{N} = 1$ Lagrangian theory (3.11) flows to the $\mathcal{N} = 2$ $R_{2,N-1}$ SCFT. We now present a number of simple but stringent tests that support this conclusion.

First, note that the manifest symmetry group of the Lagrangian description matches with the symmetry group of the $R_{2,N-1}$ theory for k even: we find a $USp(2(N-1)) \times U(1)_z$ symmetry group which we identify with the flavour group of the $\mathcal{N} = 2$ SCFT, and an additional $U(1)_R \times U(1)_R$ which we identify with the manifest $\mathcal{N} = 1$ subgroup of the $SU(2)_R \times U(1)_r^{\mathcal{N}=2}$ R -symmetry of the $\mathcal{N} = 2$ SCFT.

Second, note that the $USp(2(N-1))$ global symmetry has a Witten anomaly [56], coming from the X fields, which give an odd number of chiral multiplets in the fundamental of

$USp(2(N-1))$. This agrees with the result in [57]. The a and c central charges are also straightforward to compute using [64, 65]

$$a = \frac{3}{32}(3 \operatorname{Tr} U(1)_R^3 - \operatorname{Tr} U(1)_R), \quad c = \frac{1}{32}(9 \operatorname{Tr} U(1)_R^3 - 5 \operatorname{Tr} U(1)_R). \quad (3.12)$$

where $U(1)_R$ is the R -symmetry appearing in the superconformal algebra, which can be determined by a -maximisation [66]. The $U(1)_R$ given above already maximizes a , so the calculation is straightforward, and we obtain

$$\operatorname{Tr} U(1)_R^3 = \frac{1}{27}(11k^2 + 35k - 2), \quad \operatorname{Tr} U(1)_R = -\frac{1}{3}(k^2 + k + 2). \quad (3.13)$$

Substituting into (3.12) we recover (3.6) as expected. Finally, we find a mixed anomaly

$$\operatorname{Tr}(USp(2k)^2 U(1)_R) = -\frac{1}{3}(k + 2) \quad (3.14)$$

which is $-\frac{1}{3}$ times the level of the $USp(2k)$ flavour current of the $R_{2,k}$ theory, as expected.¹⁹ Written in the $\mathcal{N} = 2$ basis, the complete set of non-vanishing anomaly coefficients are:

$$\begin{array}{l|l} USp(2k)^3 & 1 \bmod 2 \\ USp(2k)^2 U(1)_r & -(k + 2) \\ U(1)_z^2 U(1)_r & -2 \\ U(1)_r^3 & -(k^2 + k + 2) \\ SU(2)_R^2 U(1)_r & \frac{1}{2}(k^2 + 3k) \\ U(1)_r & -(k^2 + k + 2) \end{array} \quad (3.15)$$

Besides the checks of the conformal and mixed anomalies in (3.13) and (3.14), we are not aware of a computation of the other anomaly coefficients. These are therefore a prediction of our deconfined description.

As a final check, we will focus on the rank one Argyres-Wittig theory with symmetry $USp(4) \times U(1)$ [58], which is the case $N = 3$, i.e., the $R_{2,2}$ theory ($k = N - 1 = 2$). Expressions for the Hall-Littlewood index [67–70] of this theory were given explicitly in [55]. This index is an specialization of the full superconformal index, obtained as follows. Consider the usual variables for the superconformal index $p = tx$ and $q = t/x$, and denote the chemical potential for the $U(1)_R$ symmetry ν . Define $\tau := \nu(pq)^{\frac{1}{3}}$. The Hall-Littlewood index is then

$$\mathcal{I}_{\text{HL}}(\tau) := \mathcal{I}(p, q, \tau) \Big|_{p=q=0} \quad (3.16)$$

¹⁹ See, e.g., (A.4) of [53]. Note that we normalize the generators of $USp(2k)$ so that $\operatorname{Tr} USp(2k)^2 U(1)_R = 1$ for a fermion in the fundamental of $USp(2)$ with charge 1 under $U(1)_R$, which leads to a factor of 2 difference with the conventions in that paper.

where for simplicity we have turned off all chemical potentials for non- R symmetries. It is straightforward to compute this quantity from our quiver description using the techniques in [69]. We obtain

$$\mathcal{I}_{\text{HL}}(\tau) = 1 + 11\tau^2 + 10\tau^3 + 60\tau^4 + 80\tau^5 + 253\tau^6 + 350\tau^7 + 855\tau^8 + 1180\tau^9 + 2406\tau^{10} + \dots \quad (3.17)$$

This ought to be compared with the exact form of the index, which was found in [55]:

$$\mathcal{I}_{\text{HL}}(\tau) = \frac{1 + 2\tau + 8\tau^2 + 20\tau^3 + 41\tau^4 + 62\tau^5 + 87\tau^6 + 96\tau^7 + 87\tau^8 + \dots + \tau^{14}}{(1 - \tau)^8(1 + \tau)^6(1 + \tau + \tau^2)^4} \quad (3.18)$$

where the omitted terms in the numerator are palindromic (that is, the coefficient of τ^{7-m} is the same as that of τ^{7+m}). A Taylor expansion of this expression around $\tau = 0$ reproduces (3.17).

3.2 Odd k

We now repeat the same reasoning for even $N = k + 1$. The dual phase to III^+ is I^- . Phase I has the additional complication that it involves the strongly coupled \mathfrak{q}_{SO} and \mathfrak{q}_{USp} sectors. These can be deconfined, as reviewed in §2.2, leading to a Lagrangian theory in the same universality class with matter content

	$SU(N-1)$	$SU(N-1)$	$SO(N+2)$	$USp(N-2)$	$U(1)_B$	$U(1)_X$	$U(1)_Y$	$U(1)_R$
A_1	1	$\bar{\square}$	1	\square	$\frac{1}{2(N-1)}$	1	$\frac{N+2}{2(N-1)}$	$\frac{4-3N}{4-4N}$
A_2	1	$\bar{\square}$	1	\square	$\frac{1}{2(N-1)}$	-1	$\frac{N+2}{2(N-1)}$	$\frac{4-3N}{4-4N}$
Y	1	\square	\square	1	$\frac{1}{2-2N}$	0	$\frac{N-4}{2(N-1)}$	$\frac{N}{4(N-1)}$
Z	1	\square	1	1	$\frac{1}{1-N}$	0	$\frac{N+2}{1-N}$	$\frac{N}{2(N-1)}$
P	1	1	\square	1	$-\frac{1}{2}$	0	$\frac{N}{2}$	$\frac{N}{4}$
Q	1	$\bar{\square}$	1	1	$\frac{N}{2(N-1)}$	0	$-\frac{(N-2)(N+2)}{2(N-1)}$	$\frac{N^2-8N+8}{4-4N}$
A'_1	$\bar{\square}$	1	1	\square	$\frac{1}{2-2N}$	$\frac{N+2}{2(N-1)}$	-1	$\frac{4-3N}{4-4N}$
A'_2	$\bar{\square}$	1	1	\square	$\frac{1}{2-2N}$	$\frac{N+2}{2(N-1)}$	1	$\frac{4-3N}{4-4N}$
Y'	\square	1	\square	1	$\frac{1}{2(N-1)}$	$\frac{N-4}{2(N-1)}$	0	$\frac{N}{4(N-1)}$
Z'	\square	1	1	1	$\frac{1}{N-1}$	$\frac{N+2}{1-N}$	0	$\frac{N}{2(N-1)}$
P'	1	1	\square	1	$\frac{1}{2}$	$\frac{N}{2}$	0	$\frac{N}{4}$
Q'	$\bar{\square}$	1	1	1	$\frac{N}{2-2N}$	$-\frac{(N-2)(N+2)}{2(N-1)}$	0	$\frac{N^2-8N+8}{4-4N}$
Φ	1	1	\square	\square	0	-1	-1	1

$$(3.19a)$$

and superpotential

$$W = \text{Tr}(A_1 Y \Phi + A_2 Y_1 A'_1 Y' + A_1 A_2 Z + P Q Y + A'_1 A'_2 Z' + P' Q' Y' + A'_2 Y' \Phi). \quad (3.19b)$$

Now that we have this explicit Lagrangian description of phase I the analysis proceeds along the same lines as in the case of odd N . As a first step, by matching $U(1)^4$ charges we

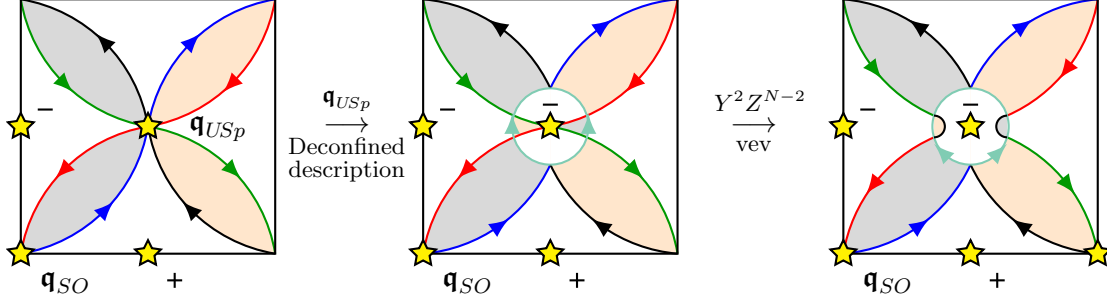

Figure 20: Deconfined description of \mathfrak{q}_{USp} part of phase I. We have kept \mathfrak{q}_{SO} confined in the tiling for clarity; deconfining it leads to an additional $SU(N-1)$ gauge factor that we have written explicitly in (3.19). Turning on a vev for $Y^2 Z^{N-2}$ leads to recombination of the green and red NS5 branes.

determine the phase I operator dual to C_1^N to be $Y^2 Z^{N-2}$. Tracking what happens to (3.19) when we turn on $Y^2 Z^{N-2}$ can be done systematically, but the computation is quite technically involved. It will be helpful to understand first the effect of the vev on the brane tiling, as a guide to the behaviour of the field theory. Let us focus on the effect in the \mathfrak{q}_{USp} sector, which we show partially deconfined in figure 20. In this picture, the Higgsing corresponds to a recombination of branes.

In terms of the field theory, after integrating out the fields that become massive after Higgsing, we obtain (after some relabeling):

	$SU(N-1)$	$USp(N-2)$	$SO(N+1)$	$USp(N-2)$	$U(1)_x$	$U(1)_z$	$U(1)_R$	$U(1)_R$
Φ_1	1	1	1	\square	-1	2	1	1
Y	1	\square	\square	1	0	0	1	0
P	1	1	\square	1	0	0	N	0
Q	1	\square	1	1	0	0	$-N-1$	2
A'_1	$\bar{\square}$	1	1	\square	$\frac{N+2}{2(N-1)}$	$-\frac{1}{N-1}$	$\frac{N-2}{2-2N}$	$\frac{N-2}{2(N-1)}$
A'_2	$\bar{\square}$	1	1	\square	$\frac{N+2}{2(N-1)}$	$-\frac{1}{N-1}$	$1 + \frac{N}{2(N-1)}$	$\frac{N-2}{2(N-1)}$
Y'	\square	1	\square	1	$\frac{N-4}{2(N-1)}$	$\frac{1}{N-1}$	$\frac{N}{2-2N}$	$\frac{2(N-1)}{2(N-1)}$
Y'_1	\square	1	1	1	$\frac{N-4}{2(N-1)}$	$-2 + \frac{1}{N-1}$	$\frac{N}{2-2N}$	$\frac{2(N-1)}{2(N-1)}$
Z'	\square	1	1	1	$-\frac{N+2}{N-1}$	$\frac{2}{N-1}$	$-\frac{N}{N-1}$	$\frac{N}{N-1}$
P'	1	1	\square	1	$\frac{N}{2}$	-1	$-\frac{N}{2}$	$\frac{N}{2}$
P'_1	1	1	1	1	$\frac{N}{2}$	1	$-\frac{N}{2}$	$\frac{N}{2}$
Q'	$\bar{\square}$	1	1	1	$\frac{(N-2)(N+2)}{2(1-N)}$	$1 - \frac{1}{N-1}$	$\frac{N^2}{2(N-1)}$	$-\frac{(N-2)^2}{2(N-1)}$
Φ	1	1	\square	\square	-1	0	-1	1

with the superpotential

$$W = \text{Tr}(PQY + P'Q'Y' + \Phi_1 A'_1 Y'_1 + P'_1 Q' Y'_1 + A'_1 Y' (Y)^2 \Phi + A'_2 Y' \Phi + A'_1 A'_2 Z') \quad (3.20b)$$

which agrees with the results of the brane tiling operation described above.

This is a fairly imposing theory, but looking at the brane tiling gives a clue about what to do next. As can be seen in figure 20, after the branes passing through the $O5^-$ orientifold

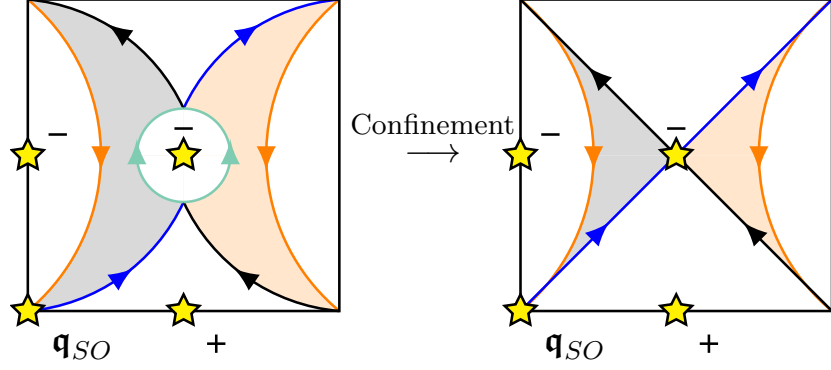

Figure 21: Reconfining the result of Higgsing the deconfined \mathfrak{q}_{USp} sector.

fixed point within the \mathfrak{q}_{USp} sector recombine and move away, we are left with a central “deconfinement bubble” which will tend to reconfine, as in figure 21. This suggests to that the $USp(N-2)$ gauge group factor in the second column of (3.20) should confine, and indeed this factor is s -confining [27], resulting in composite mesons $\mathcal{M}_{Y^2} = Y^2$ and $\mathcal{M}_{YQ} = YQ$ interacting via a superpotential. The latter meson gets a mass with P , setting the confining superpotential to zero.

Finally, we flip the operator dual to ϕ , which is $A_1^{N-2}Q'$ as is straightforward to check. We thereby obtain a Lagrangian in the same universality class as the strongly-coupled S-dual of (3.4), given by

	$SU(N-1)$	$SO(N+1)$	$USp(N-2)$	$U(1)_x$	$U(1)_z$	$U(1)_\mathfrak{R}$	$U(1)_R$
\mathcal{M}	1	\square	1	0	0	-2	$\frac{2}{3}$
A_1	$\bar{\square}$	1	\square	$\frac{N+2}{2(N-1)}$	$\frac{-1}{N-1}$	$\frac{N-2}{2(N-1)}$	$\frac{N-2}{3(N-1)}$
A_2	$\bar{\square}$	1	\square	$\frac{N+2}{2(N-1)}$	$\frac{-1}{N-1}$	$\frac{N}{2-2N} - 1$	$\frac{4-3N}{3-3N}$
Y	\square	\square	1	$\frac{N-4}{2(N-1)}$	$\frac{1}{N-1}$	$\frac{N}{2(N-1)}$	$\frac{N}{3(N-1)}$
Y_1	\square	1	1	$\frac{N-4}{2(N-1)}$	$\frac{1}{N-1} - 2$	$\frac{N}{2(N-1)}$	$\frac{N}{3(N-1)}$
Z	\square	1	1	$\frac{N+2}{1-N}$	$\frac{2}{N-1}$	$\frac{N}{N-1}$	$\frac{2N}{3(N-1)}$
P	1	\square	1	$\frac{N}{2}$	-1	$\frac{N}{2}$	$\frac{N}{3}$
P_1	1	1	1	$\frac{N}{2}$	1	$\frac{N}{2}$	$\frac{N}{3}$
Q	$\bar{\square}$	1	1	$\frac{(N-2)(N+2)}{2(1-N)}$	$\frac{N-2}{N-1}$	$\frac{N^2}{2-2N}$	$\frac{N^2-6N+6}{3-3N}$
Φ	1	\square	\square	-1	0	1	$\frac{2}{3}$
Φ_1	1	1	\square	-1	2	-1	$\frac{4}{3}$
$\bar{\phi}$	1	1	1	0	0	2	$\frac{4}{3}$

with superpotential

$$W = \text{Tr}(A_1 A_2 Z + A_2 Y \Phi + A_1 Y \mathcal{M} \Phi + A_1 Y_1 \Phi_1 + P Q Y + P_1 Q Y_1) + A_1^{N-2} Q \bar{\phi}, \quad (3.21b)$$

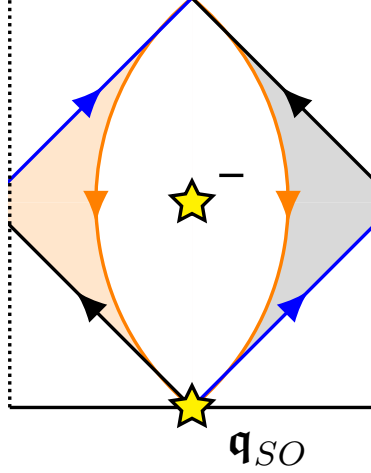

Figure 22: Sending the gauge coupling of the $SO(N+1)$ factor to 0. Note that we shifted figure 21 horizontally by half a period before cutting open the torus into a cylinder, in order to focus on the strongly coupled sector.

where we relabeled $\mathcal{M}_{Y^2} \rightarrow \mathcal{M}$ and suppressed the primes for simplicity.

As discussed above, we expect this theory to flow to $R_{2,N-1} \leftrightarrow SO(N+1)$ per [59]. Therefore, we can isolate $R_{2,N-1}$ by ungauging $SO(N+1)$ (in the $\mathcal{N} = 2$ sense), which also removes the chiral superpartner \mathcal{M} . Equivalently, in terms of the brane tiling we focus in on the strongly coupled sector as in figure 22. After redefining $U(1)_y = -(U(1)_x + \frac{1}{2}U(1)_z)$ for later convenience, we obtain the following $\mathcal{N} = 1$ Lagrangian theory, which is expected to flow to the $R_{2,N-1}$ theory for even N :

	$SU(N-1)$	$USp(N-2)$	$SU(N+1)$	$U(1)_y$	$U(1)_z$	$U(1)_\mathcal{R}$	$U(1)_R$
A_1	\square	\square	1	$\frac{N+1}{2-2N}$	$-\frac{1}{N-1}$	$\frac{N-2}{2(N-1)}$	$\frac{N-2}{3(N-1)}$
A_2	\square	\square	1	$\frac{N+1}{2-2N}$	$-\frac{1}{N-1}$	$\frac{N}{2-2N} - 1$	$\frac{3N-4}{3(N-1)}$
Y	\square	1	\square	$-\frac{N-3}{2(N-1)}$	$\frac{1}{N-1}$	$\frac{N}{2(N-1)}$	$\frac{N}{3(N-1)}$
Y_1	\square	1	1	$\frac{N+1}{2(N-1)}$	$\frac{1}{N-1} - 2$	$\frac{N}{2(N-1)}$	$\frac{N}{3(N-1)}$
Z	\square	1	1	$\frac{N+1}{N-1}$	$\frac{2}{N-1}$	$\frac{N}{N-1}$	$\frac{2N}{3(N-1)}$
P	1	1	\square	$-\frac{N-1}{2}$	-1	$\frac{N}{2}$	$\frac{N}{3}$
P_1	1	1	1	$-\frac{1}{2}(N+1)$	1	$\frac{N}{2}$	$\frac{N}{3}$
Q	\square	1	1	$\frac{-N^2+N+2}{2-2N}$	$\frac{N-2}{N-1}$	$\frac{N^2}{2-2N}$	$\frac{N^2-6N+6}{3-3N}$
Φ	1	\square	\square	1	0	1	$\frac{2}{3}$
Φ_1	1	\square	1	0	2	-1	$\frac{4}{3}$
$\bar{\phi}$	1	1	1	0	0	2	$\frac{4}{3}$

with superpotential

$$W = \text{Tr}(A_1 A_2 Z + A_2 Y \Phi + A_1 Y_1 \Phi_1 + P Q Y + P_1 Q Y_1) + A_1^{N-2} Q \bar{\phi}. \quad (3.22b)$$

Along the lines of [18], one can argue that $SU(N+1) \times U(1)_y$ enhances accidentally to $\text{Spin}(2N+2)$ in the infrared, in agreement with the expected $\text{Spin}(2N+2) \times U(1)$ flavor symmetry of the $R_{2,N-1}$ (even N) CFT. It is hard to imagine that one could have guessed this $\mathcal{N} = 1$ Lagrangian without the aid of the brane construction!²⁰

The end result can be re-expressed more simply as a partial gauging of one of the quad CFTs discussed in §2.4. In particular, consider the “partially flipped” \mathfrak{q}_{SO} CFT shown in figure 14, with flavor symmetry $SU(N-2) \times \text{Spin}(2N+2) \times \text{Spin}(2) \times U(1)^2 \times U(1)_R$ (setting $M = N-2$, $P = 2$). We claim that gauging $SU(N-2) \leftrightarrow USp(N-2)$ (with $\mathcal{N} = 1$ vector multiplets) generates a flow whose endpoint is the $R_{2,N-1}$ (even N) CFT plus a decoupled free chiral multiplet. Indeed, substituting the deconfined description of the \mathfrak{q}_{SO} theory given in §2.4, identifying $\text{Spin}(2) \cong U(1)_z$, choosing an appropriate basis for the remaining $U(1)$ s (after omitting the one with a mixed $USp(N-2)^2 U(1)$ anomaly), and flipping the appropriate free baryon (either \mathcal{A}_{N-2} and \mathcal{A}_0 , depending on which deconfined description we choose, see (2.10)), we recover (3.22).

The abstract quiver for this description of $R_{2,N-1}$ (even N) is shown in figure 23. Note that in principle we could have obtained this description directly by Higgsing the abstract quiver in figure 5(a); we did this calculation using the deconfined Lagrangian description only because Lagrangian methods are far more familiar. Moreover, note that the abstract quiver 23 displays the full flavor symmetry of the $R_{2,N-1}$ CFT, lacking only the nonabelian R -symmetry enhancement to $U(1)_R^{N=2} \rightarrow SU(2)_R$ that is never visible in $\mathcal{N} = 1$ language.

The embedding of the $U(1)$ symmetries within the \mathfrak{q}_{SO} description can likewise be described by the abstract charge table

	$USp(N-2)$	$SO(2N+2)$	$SO(2)_z$	$U(1)_\mathfrak{A}$	$U(1)_R$
\mathfrak{q}_{SO}	*	*	*	$\frac{N}{2}$	$\frac{N-6}{12}$
Ψ	\square	\square	1	1	2/3
$\tilde{\Psi}$	$\bar{\square}$	1	\square	-1	4/3
ϕ	1	1	1	2	4/3

(3.23a)

with superpotential

$$W = \mathcal{A}\phi. \quad (3.23b)$$

²⁰A different class of $\mathcal{N} = 1$ Lagrangians expected to flow to the $R_{2,N-1}$ (N even) CFTs and preserving a different subgroup of the full $R_{2,N-1}$ symmetry group were proposed in [63]. Unlike here, the manifest symmetry group in [63] has a lower rank (by one) than the full $R_{2,N-1}$ symmetry group, $U(1)_\mathfrak{A}$ being absent from the UV theory. If our proposal and that of [63] are both correct then they should lie in the same universality class. However, we have so far been unable to relate them using known Seiberg dualities, a task made more difficult by the mismatch in the manifest symmetries. We leave this as an interesting question for future research.

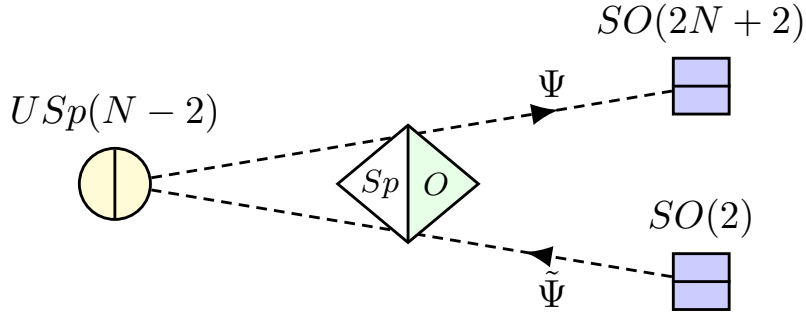

Figure 23: The abstract quiver for a partial gauging of a \mathfrak{q}_{SO} CFT that is expected to generate a flow to the $R_{2,N-1}$ (even N) CFT plus a decoupled chiral multiplet. The oppositely directed arrows on the meson lines $\Psi, \tilde{\Psi}$ indicate that the \mathfrak{q}_{SO} CFT is partially flipped, see figure 14.

Here the second and third lines of the table indicate the charges²¹ of the \mathfrak{q}_{SO} mesons Ψ and $\tilde{\Psi}$ and the first line indicates the admixture of the baryonic symmetry $U(1)_B$ of the quad CFT, following the conventions of [19]. In the notation of (2.10), the baryon \mathcal{A} is either \mathcal{A}_{N-2} or \mathcal{A}_0 depending on which deconfined description we pick, the right one being fixed by the $U(1)$ charges.

Let us provide some evidence that this Lagrangian theory and its partially-gauged- \mathfrak{q}_{SO} cousin are in the same universality class as the $R_{2,N-1}$ theory. The global symmetry of the $R_{2,N-1}$ theory is $\text{Spin}(2N+2) \times U(1)$ times $SU(2)_R \times U(1)_{r^{\mathcal{N}=2}}$. The $\mathcal{N} = 1$ description will break the R -symmetry factor to $U(1)_{\mathfrak{A}} \times U(1)_R$, so ideally we would like to have an $\mathcal{N} = 1$ description with global symmetry group $\text{Spin}(2N+2) \times U(1) \times U(1)_{\mathfrak{A}} \times U(1)_R$. This is precisely the manifest symmetry of the abstract quiver shown in figure 23, although in our explicit Lagrangian description (3.22) only a maximal subgroup $SU(N+1) \times U(1)$ of $\text{Spin}(2N+2)$ (of equal rank) is manifest.

We next compare the central charges. We have, setting $N = k + 1$ as above,

$$\begin{aligned} \text{Tr } U(1)_R^3 &= \frac{1}{27}(11k^2 + 9k - 28) \\ \text{Tr } U(1)_R &= -\frac{1}{3}(k^2 + 3k + 4). \end{aligned} \tag{3.24}$$

When substituted into (3.12) these values lead to the expected a and c central charges given in (3.7). Similarly, we find

$$\text{Tr } \text{Spin}(2k+4)^2 U(1)_R = -\frac{1}{3}(2k) \tag{3.25}$$

in agreement with the expected central charge for the flavour symmetry (up to the same factor of $-\frac{1}{3}$ we found in the even k case). As before, the complete list of non vanishing anomalies

²¹Note that although $\bar{\square} \cong \square$ for $USp(N-2)$ (the \square representation is pseudoreal), we list opposite choices for Ψ and $\tilde{\Psi}$ as a reminder of the partial flipping.

in the $\mathcal{N} = 2$ basis is given by:

$$\begin{array}{l|l}
\text{Spin}(2k+4)^2 U(1)_r & -2k \\
U(1)_z^2 U(1)_r & -8 \\
U(1)_r^3 & -(k^2 + 3k + 4) \\
SU(2)_R^2 U(1)_r & \frac{1}{2}(k^2 + k - 2) \\
U(1)_r & -(k^2 + 3k + 4)
\end{array} \tag{3.26}$$

These anomalies match the ones computed in [63] (for the anomaly computation $\text{Spin}(2k+4) \simeq SO(2k+4)$). Note, however, that the ones involving $\text{Spin}(2k+4)$ differ by a factor of 2 with respect to the conventions in that paper, due to the different normalization of the $\text{Spin}(2k+4)$ generators, see the discussion in footnote 19.

Finally, we can compute the superconformal index and compare with known results. We will do it for $R_{2,3}$, which is a well studied example, as it is the rank one E_6 Minahan-Nemeschansky (also known as T_3). In this case we have the following matter content:

	$SU(3)$	$SU(2)$	$SU(5)$	$U(1)_y$	$U(1)_z$	$U(1)_\mathcal{R}$	$U(1)_R$
A_1	$\bar{\square}$	\square	1	$-\frac{5}{6}$	$-\frac{1}{3}$	$\frac{1}{3}$	$\frac{2}{9}$
A_2	$\bar{\square}$	\square	1	$-\frac{5}{6}$	$-\frac{1}{3}$	$-\frac{5}{3}$	$\frac{8}{9}$
Y	\square	1	$\bar{\square}$	$-\frac{1}{6}$	$\frac{1}{3}$	$\frac{2}{3}$	$\frac{4}{9}$
Y_1	\square	1	1	$\frac{5}{6}$	$-\frac{5}{3}$	$\frac{2}{3}$	$\frac{4}{9}$
Z	$\bar{\square}$	1	1	$\frac{5}{3}$	$\frac{2}{3}$	$\frac{4}{3}$	$\frac{8}{9}$
P	1	1	\square	$-\frac{3}{2}$	-1	2	$\frac{4}{3}$
P_1	1	1	1	$-\frac{5}{2}$	1	2	$\frac{4}{3}$
Q	$\bar{\square}$	1	1	$\frac{5}{3}$	$\frac{2}{3}$	$-\frac{8}{3}$	$\frac{2}{9}$
Φ	1	\square	\square	1	0	1	$\frac{2}{3}$
Φ_1	1	\square	1	0	2	-1	$\frac{4}{3}$
$\bar{\phi}$	1	1	1	0	0	2	$\frac{4}{3}$

(3.27a)

with superpotential

$$W = \text{Tr}(A_1 A_2 Z + A_2 Y \Phi + A_1 Y_1 \Phi_1 + P Q Y + P_1 Q Y_1) + A_1^2 Q \bar{\phi}. \tag{3.27b}$$

With this field content at hand it is easy to compute the superconformal index (using the prescription in [69]) to a fairly high order and compare it with known results [71]. We find for

the first few orders, in the conventions of [18],

$$\begin{aligned}
& 1 + \mathfrak{A}^2 t^{4/3} \left[1 + X_{0,1,0,0,0} + z X_{0,0,0,1,0} + \frac{X_{0,0,0,0,1}}{z} \right] \\
& + t^2 \left[\frac{1}{\mathfrak{A}^6} - \left(2 + X_{0,1,0,0,0} + z X_{0,0,0,1,0} + \frac{X_{0,0,0,0,1}}{z} \right) \right] \\
& - t^{7/3} J_1 \left[\frac{1}{\mathfrak{A}^4} - \mathfrak{A}^2 \left(2 + X_{0,1,0,0,0} + z X_{0,0,0,1,0} + \frac{X_{0,0,0,0,1}}{z} \right) \right] + \dots
\end{aligned} \tag{3.28}$$

where we have grouped the $SU(5) \times U(1)_y$ characters into Spin(10) characters $X_{a,b,c,d,e}$, denoted by z the $U(1)_z$ chemical potential, and by \mathfrak{A} the $U(1)_\mathfrak{A}$ chemical potential. This index agrees perfectly with the index computed in [71],²² if we embed $\text{Spin}(10) \times U(1)_z \rightarrow E_6$. We have verified that the agreement persists to at least the order $t^{11/3}$, but the resulting expressions are a bit too unwieldy to display here.

Finally, let us briefly note that the theory in (3.27) has no 1-form symmetries (i.e., the gauge group is simply connected and the spectrum is complete). This matches the expected answer [73], which can also be deduced from a BPS quiver analysis along the lines of [74] and the general class- \mathcal{S} analysis in [75].

4 Higgs branch deformations

We have constructed candidate Lagrangian descriptions for the $R_{2,k}$ theories, for all k . So far, our evidence for the validity of these descriptions is that the global symmetries, central charges and superconformal indices match between our $\mathcal{N} = 1$ theories and the ones expected for the $R_{2,k}$ theories (whenever those are known).

In the rest of this paper we will provide further evidence for these proposals by rederiving known results about the moduli space and deformations of these theories. We start in this section by studying what happens as we move on the Higgs branch.

4.1 Dimension of the Higgs branch for $R_{2,k}$

The quaternionic dimension of the Higgs branch of $\mathcal{N} = 2$ theories is $\dim_{\mathbb{H}}(\mathcal{H}) = 24(c-a)$ [76]. The values of a and c for the $R_{2,k}$ theories were given in (3.6) and (3.7) above, from which we obtain²³

$$\dim_{\mathbb{H}}(\mathcal{H}) = 1 + \frac{k(k+1)}{2} \tag{4.1}$$

in the even k case and

$$\dim_{\mathbb{H}}(\mathcal{H}) = 1 + \frac{(k+1)(k+2)}{2} \tag{4.2}$$

²²This index was given an alternative $\mathcal{N} = 1$ Lagrangian interpretation in [72].

²³This formula assumes that on a generic point on a Higgs branch the IR theory is a theory of free hypers. This is something that is indeed true for our $\mathcal{N} = 1$ theory, and true for $R_{2,k}$ for rank up to two [77], but we are not aware of a computation showing that it is true for $k > 2$, which would be a prediction of our analysis. We thank the referee for highlighting this assumption.

in the odd k case. We now reproduce these formulae from our $\mathcal{N} = 1$ Lagrangian descriptions.

The computation is simpler for even k , so we discuss this case first. The UV Lagrangian constructed in §3.1 is shown in (3.11). We turn on a vev for the baryonic Higgs branch operator $X^{N-1}Y_1$, which completely Higgses the gauge group. Note that the A_1 F-term forces the X vevs to span an isotropic subspace of $USp(2N-2)$, breaking $USp(2N-2) \rightarrow U(N-1)$. In particular, the field X in the $SU(N) \times USp(2N-2)$ irrep $(\bar{\square}, \square)$ decomposes into two fields X_1 and X_2 in $SU(N) \times U(N-1)$ irreps $(\bar{\square}, \square)$ and $(\bar{\square}, \bar{\square})$, respectively. Choosing the vev to be in the component $X_1^{N-1}Y_1$ for definiteness, the end result is

	$U(N-1)'$	$U(1)'_{\mathcal{R}}$	$U(1)'_R$
A_2	\square	2	$\frac{4}{3}$
X_2	$\bar{\square}$	0	0
$\bar{\phi}$	1	2	$\frac{4}{3}$
v	1	0	0

(4.3)

with vanishing superpotential, where the primes indicate that we have mixed the (center of) the indicated symmetry groups with $U(1)_z$ from (3.11) (under which $X^{N-1}Y_1$ carries unit charge) to isolate the subgroups preserved by the vev.²⁴ Thus, we obtain

$$\dim_{\mathbb{H}}(\mathcal{H}) = \frac{1}{2} \left(1 + 1 + \frac{1}{2}N(N-1) + \frac{1}{2}N(N-1) \right) = 1 + \frac{1}{2}N(N-1) \quad (4.4)$$

free hypermultiplets, in agreement with (4.1) for $N = k + 1$.

Next, we consider the odd k case, for which the UV Lagrangian theory is shown in (3.22). Turning on a vev for the gauge-singlet Higgs branch operator P_1 breaks one linear combination of the $U(1)$ global symmetries and gives a mass to Q and Y_1 .²⁵ Integrating these out, we obtain

	$SU(N-1)$	$USp(N-2)$	$SU(N+1)$	$U(1)'_y$	$U(1)'_{\mathcal{R}}$	$U(1)'_R$
A_1	$\bar{\square}$	\square	1	$\frac{1+N}{1-N}$	1	$\frac{2}{3}$
A_2	$\bar{\square}$	\square	1	$\frac{1+N}{1-N}$	-1	$\frac{4}{3}$
Y	\square	1	$\bar{\square}$	$\frac{2}{-1+N}$	0	0
Z	\square	1	1	$\frac{2(1+N)}{-1+N}$	0	0
P	1	1	\square	$-N$	N	$\frac{2N}{3}$
Φ	1	\square	\square	1	1	$\frac{2}{3}$
Φ_1	1	\square	1	$1+N$	$-1-N$	$-\frac{2}{3}(N-2)$
$\bar{\phi}$	1	1	1	0	2	$\frac{4}{3}$
v	1	1	1	0	0	0

(4.5a)

²⁴While these symmetries are further enhanced in the IR, this is not very important in the present argument.

²⁵Note that since it has nonzero $U(1)_y$ charge, P_1 sits inside a nontrivial (spinor) representation of $\text{Spin}(2N+2)$, and the vev will break $\text{Spin}(2N+2) \rightarrow SU(N+1) \times U(1)_y$. This fact is obscured in the UV Lagrangian, where only the subgroup $SU(N+1) \times U(1)_y$ was manifest to begin with.

with superpotential

$$W = \text{Tr} \left(A_1 A_2 Z + A_2 \Phi Y + \frac{1}{v} A_1 P Y \Phi_1 \right). \quad (4.5b)$$

Here we explicitly include P_1 —now denoted by v as a reminder that it has a vev—in our set of light fields since we are interested in counting flat directions in the IR. To further simplify the result, we deconfine the antisymmetric tensor field Z and Seiberg dualize $SU(N-1)$ to obtain

	$SU(N-2)$	$USp(N-2)$	$USp(N-4)$	$SU(N+1)$	$U(1)'_y$	$U(1)'_{\mathcal{R}}$	$U(1)'_R$
\widetilde{A}_1	\square	\square	1	1	0	-1	$\frac{4}{3}$
\widetilde{A}_2	\square	\square	1	1	0	1	$\frac{2}{3}$
\widetilde{Y}	$\bar{\square}$	1	1	\square	1	0	0
\widetilde{H}_z	$\bar{\square}$	1	\square	1	0	0	0
\widetilde{P}_z	\square	1	1	1	$-(1+N)$	0	2
$\mathcal{M}_{A_1 Y}$	1	\square	1	$\bar{\square}$	-1	1	$\frac{2}{3}$
$\mathcal{M}_{Y P_z}$	1	1	1	$\bar{\square}$	N	0	0
P	1	1	1	\square	$-N$	N	$\frac{2N}{3}$
Φ_1	1	\square	1	1	$1+N$	$-(1+N)$	$\frac{2(2-N)}{3}$
$\bar{\phi}$	1	1	1	1	0	2	$\frac{4}{3}$
v	1	1	1	1	0	0	0

(4.6a)

with superpotential

$$W = \text{Tr} \left(\widetilde{A}_1 \widetilde{A}_2 \widetilde{H}_z^2 + \frac{1}{v} \Phi_1 \mathcal{M}_{A_1 Y} P + \mathcal{M}_{A_1 Y} \widetilde{A}_1 \widetilde{Y} + \widetilde{P}_z \widetilde{Y} \mathcal{M}_{Y P_z} \right). \quad (4.6b)$$

Here the fields with tildes on top are the Seiberg dual quarks and $\mathcal{M}_{A_1 Y}$, $\mathcal{M}_{Y P_z}$ are two of the composite mesons, whereas the remaining mesons acquire masses via the superpotential and have been integrated out.²⁶

Since the $USp(N-4)$ gauge factor now has $N-2$ flavors, it confines with a quantum-deformed moduli space [27], forcing the composite $\mathcal{M}_{\widetilde{H}_z \widetilde{H}_z}$ (in the $\bar{\square}$ irrep of $SU(N-2)$) to get a vev. This Higgses $SU(N-2)$ to $USp(N-2)$ as well as giving a mass to \widetilde{A}_1 and \widetilde{A}_2 , but breaks no global symmetries (since \widetilde{H}_z is already neutral). After Higgsing and integrating out

²⁶Note that \widetilde{H}_z and \widetilde{P}_z are the Seiberg dual quarks of fields H_z and P_z arising from deconfining Z ; likewise $\mathcal{M}_{Y P_z}$ is a composite involving one of these fields.

the massive matter, we are left with

	$USp(N-2)$	$USp(N-2)$	$SU(N+1)$	$U(1)_y$	$U(1)'_{\mathcal{R}}$	$U(1)'_R$
\tilde{Y}	\square	1	\square	1	0	0
\tilde{P}_z	\square	1	1	$-(1+N)$	0	2
$\mathcal{M}_{A_1 Y}$	1	\square	$\bar{\square}$	-1	1	$\frac{2}{3}$
$\mathcal{M}_{Y P_z}$	1	1	$\bar{\square}$	N	0	0
P	1	1	\square	$-N$	N	$\frac{2N}{3}$
Φ_1	1	\square	1	$1+N$	$-(1+N)$	$\frac{2(2-N)}{3}$
$\bar{\phi}$	1	1	1	0	2	$\frac{4}{3}$
v	1	1	1	0	0	0

(4.7a)

with superpotential

$$W = \text{Tr} \left(\tilde{P}_z \mathcal{M}_{Y P_z} \tilde{Y} + \frac{1}{v} \Phi_1 \mathcal{M}_{A_1 Y} P \right). \quad (4.7b)$$

Now both $USp(N-2)$ gauge group factors are s-confining. After confinement, the superpotential (4.7b) gives masses to a number of the fields.

The end result is

	$SU(N+1)$	$U(1)_y$	$U(1)'_{\mathcal{R}}$	$U(1)'_R$
$(\tilde{Y})^2$	\square	2	0	0
$(\mathcal{M}_{A_1 Y})^2$	$\bar{\square}$	-2	2	$\frac{4}{3}$
$\bar{\phi}$	1	0	2	$\frac{4}{3}$
v	1	0	0	0

(4.8)

with vanishing superpotential, where $(\tilde{Y})^2$ and $(\mathcal{M}_{A_1 Y})^2$ denote two of the composite mesons resulting from s-confinement. This is a free theory (note the similarity to (4.3)), so we can now trivially compute the dimension of the Higgs branch by counting the number of free hypermultiplets:

$$\dim_{\mathbb{H}}(\mathcal{H}) = \frac{1}{2} \left(1 + 1 + \frac{1}{2}N(N+1) + \frac{1}{2}N(N+1) \right) = 1 + \frac{1}{2}N(N+1) \quad (4.9)$$

in agreement with (4.2) since $N = k + 1$.

4.2 (A_1, D_4) Argyres-Douglas from partially closing $R_{2,2}$ punctures

As a further check of the Higgs branch for $R_{2,\text{even}}$, we verify the proposal in [78] that there is a Higgsing of the $R_{2,2}$ theory leading to the (A_1, D_4) Argyres-Douglas theory.²⁷

²⁷There are a number of other properties of the $R_{2,2}$ theory that we could compare to the results in §3.2 of [78]. We leave these checks to the interested reader.

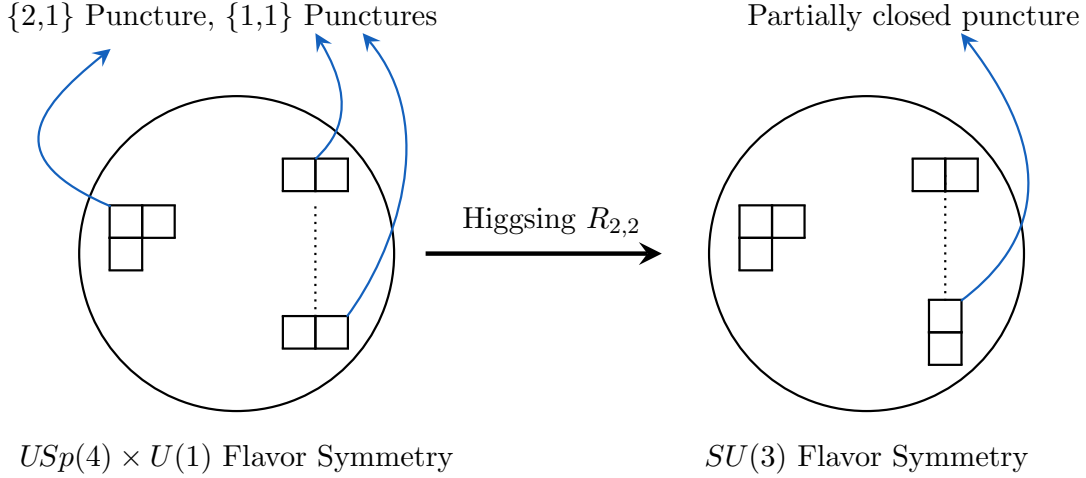

Figure 24: The class \mathcal{S} description of Higgsing $R_{2,2}$ to the (A_1, D_4) Argyres-Douglas theory

In the class- \mathcal{S} description (see the left hand side of figure 24), $R_{2,2}$ comes from an A_2 theory on a sphere with an untwisted puncture and two twisted punctures. An $SU(2) \times SU(2)$ symmetry enhancing to $USp(4)$ is associated with the twisted punctures, and $U(1)$ is associated with the untwisted puncture. It was argued in [78] that partially closing one of the twisted punctures, as in the right hand side of figure 24, we get the (A_1, D_4) Argyres-Douglas theory and one decoupled hypermultiplet.

Specializing (3.11) to the case $N = 3$, the Lagrangian whose infrared fixed is expected to be $R_{2,2}$ has the matter content

	$SU(3)$	$USp(4)$	$U(1)_z$	$U(1)_{\mathcal{R}}$	$U(1)_R$	
Y_1	$\bar{\square}$	1	1	$\frac{1}{3}$	$\frac{8}{9}$	(4.10a)
Y_2	$\bar{\square}$	1	-1	$\frac{1}{3}$	$\frac{8}{9}$	
A_1	$\bar{\square}$	1	0	$-\frac{8}{3}$	$\frac{8}{9}$	
A_2	$\square\square$	1	0	$-\frac{2}{3}$	$\frac{2}{9}$	
X	$\bar{\square}$	\square	0	$\frac{4}{3}$	$\frac{5}{9}$	
$\bar{\phi}$	1	1	0	2	$\frac{4}{3}$	

and superpotential:

$$W = \text{Tr}(A_2 Y_1 Y_2 + A_1 X X) + \bar{\phi} A_2^3 \quad (4.10b)$$

Partially closing a puncture corresponds to turning on a nilpotent vev for the moment map operator of the flavour symmetry associated to the puncture. Moment maps have spin one under the $\mathcal{N} = 2$ $SU(2)_R$ symmetry and are neutral under the $\mathcal{N} = 2$ $U(1)_r^{\mathcal{N}=2}$ symmetry. Thus per (3.1) they have $U(1)_{\mathcal{R}} \times U(1)_R$ charges $(2, 4/3)$. It is straightforward to show that

the only chiral operators of this form in (4.10) are $A_2 X^2$ and $\bar{\phi}$; since these transform in the adjoint representations of $USp(4)$ and $U(1)_z$, respectively, they are the moment maps in question. In particular, in terms of the manifest $SU(2)_1 \times SU(2)_2$ flavor symmetries of the twisted punctures, X decomposes into X_1 and X_2 in the $SU(2)_1 \times SU(2)_2$ irreps $(\square, \mathbf{1})$ and $(\mathbf{1}, \square)$ respectively. Thus, to partially close the second twisted puncture, we give a nilpotent vev to the $SU(2)_2$ moment map $A_2 X^2$.

In the special case of $\mathfrak{su}(2)$, there is a unique non-trivial nilpotent orbit. For instance, upon decomposing the matter content in terms of a maximal torus $U(1)_2 \subset SU(2)_2$

	$SU(3)$	$SU(2)_1$	$U(1)_2$	$U(1)_z$	$U(1)_\mathcal{R}$	$U(1)_R$
Y_1	$\bar{\square}$	1	0	1	$\frac{1}{3}$	$\frac{8}{9}$
Y_2	$\bar{\square}$	1	0	-1	$\frac{1}{3}$	$\frac{8}{9}$
A_1	$\bar{\square}$	1	0	0	$-\frac{8}{3}$	$\frac{8}{9}$
A_2	$\square\square$	1	0	0	$-\frac{2}{3}$	$\frac{2}{9}$
X_1	$\bar{\square}$	\square	0	0	$\frac{4}{3}$	$\frac{5}{9}$
X_{2a}	$\bar{\square}$	1	1	0	$\frac{4}{3}$	$\frac{5}{9}$
X_{2b}	$\bar{\square}$	1	-1	0	$\frac{4}{3}$	$\frac{5}{9}$
$\bar{\phi}$	1	1	0	0	2	$\frac{4}{3}$

(4.11)

the operators $A_2 X_{2a}^2$ and $A_2 X_{2b}^2$ both sit on the nontrivial nilpotent orbit. Giving a vev (denoted by v) to $A_2 X_{2b}^2$ Higgses $SU(3)$ down to $SU(2)$, and the superpotential gives masses to several fields. Integrating out the massive matter results in a Lagrangian field content

	$SU(2)$	$SU(2)_1$	$U(1)_z$	$U(1)_\mathcal{R}$	$U(1)_R$
Y_1	\square	1	1	$\frac{1}{2}$	$\frac{5}{6}$
Y_2	\square	1	-1	$\frac{1}{2}$	$\frac{5}{6}$
A_1	1	1	0	-3	1
A_2	$\square\square$	1	0	-1	$\frac{1}{3}$
X_{11}	\square	\square	0	$\frac{3}{2}$	$\frac{1}{2}$
X_{12}	1	\square	0	1	$\frac{2}{3}$
X_{2a}	1	1	0	2	$\frac{4}{3}$
$\bar{\phi}$	1	1	0	2	$\frac{4}{3}$
v	1	1	0	0	0

(4.12a)

with superpotential:

$$W = \text{Tr}(Y_1 Y_2 A_2 + A_1 X_{11}^2) + v \bar{\phi} A_2^2. \quad (4.12b)$$

Since X_{12} is decoupled, we identify it with the expected free hyper. Likewise, we identify the decoupled chiral field X_{2a} as the $\mathcal{N} = 2$ partner of the flat direction v .

Removing these fields, we end up with the Lagrangian

	$SU(2)$	$SU(2)_1$	$U(1)_z$	$U(1)_\mathfrak{R}$	$U(1)_R$	
Y_1	\square	1	1	$\frac{1}{2}$	$\frac{5}{6}$	(4.13a)
Y_2	\square	1	-1	$\frac{1}{2}$	$\frac{5}{6}$	
A_1	1	1	0	-3	1	
A_2	$\square\square$	1	0	-1	$\frac{1}{3}$	
X_1	\square	\square	0	$\frac{3}{2}$	$\frac{1}{2}$	
$\bar{\phi}$	1	1	0	2	$\frac{4}{3}$	

with superpotential:

$$W = \text{Tr}(Y_1 Y_2 A_2 + A_1 X_1^2) + \bar{\phi} A_2^2. \quad (4.13b)$$

This is in perfect agreement with the matter content of Lagrangian description of the (A_1, D_4) theory proposed in [9] up to a change of basis for the flavor symmetries.²⁸

At this point we can appeal to the convincing arguments of [9] that the theory with matter content (4.13a) flows to the (A_1, D_4) theory. Nevertheless, for the convenience of the reader, we collect here the results of some simple checks that can be performed on (4.13). First, it is straightforward to compute the central charges

$$(a, c) = \left(\frac{7}{12}, \frac{2}{3} \right) \quad (4.14)$$

which agree with the expected values for the (A_1, D_4) theory. Likewise, the superconformal index of the theory is straightforward to compute (as in [9])

$$\begin{aligned} & 1 + \frac{t}{\mathfrak{R}^3} + t^{4/3} \left(\mathfrak{R}^2 X_{1,1} - \frac{J_1}{\mathfrak{R}} \right) + \mathfrak{R} t^{5/3} + t^2 \left(-1 - X_{1,1} + \frac{J_1}{\mathfrak{R}^3} + \frac{1}{\mathfrak{R}^6} \right) \\ & + t^{7/3} \left(\mathfrak{R}^2 J_1 (1 + X_{1,1}) - \frac{1 + J_2}{\mathfrak{R}} - \frac{J_1}{\mathfrak{R}^4} \right) + t^{8/3} \left(\mathfrak{R}^4 X_{2,2} + \mathfrak{R} J_1 + \frac{2}{\mathfrak{R}^2} \right) \\ & + t^3 \left(-J_1 (2 + X_{1,1}) + \frac{-1 + J_2}{\mathfrak{R}^3} + \frac{J_1}{\mathfrak{R}^6} + \frac{1}{\mathfrak{R}^9} \right) + \dots \end{aligned} \quad (4.15)$$

where the result organizes into complete $SU(3) \supset SU(2)_1 \times U(1)_z$ characters $X_{m,n}$, consistent with the expected accidental enhancement $SU(2)_1 \times U(1)_z \rightarrow SU(3)$ in the infrared.

²⁸Note that the decoupled Coulomb branch operator A_2^2 is not explicitly flipped in [9] as is done here, accounting for the absence of $\bar{\phi}$ from their table. Although the superpotential (4.13b) was not given in [9], it can in principle be inferred from the matter content and symmetries.

5 Coulomb branch deformations

We now examine the Coulomb branch of our proposed Lagrangians and compare with what is known about the Coulomb branch of the $R_{2,k}$ theories. As the Coulomb branch is parameterized by operators that are neutral under $SU(2)_R$ and all flavour symmetries, from the $\mathcal{N} = 1$ point of view Coulomb branch operators satisfy $U(1)_{\mathfrak{A}} = -3U(1)_R$ (see (3.1)) and are neutral under the other flavour symmetries. After classifying such operators below in both even and odd k cases, we consider the effect of giving them vevs.

5.1 Even k Coulomb branch

The Lagrangian (3.11) expected to flow to the $R_{2,k}$ theory for even k is reproduced below for convenience:

	$SU(N)$	$USp(2(N-1))$	$U(1)_z$	$U(1)_{\mathfrak{A}}$	$U(1)_R$	
Y_1	$\bar{\square}$	1	1	$\frac{1}{N}$	$1 - \frac{1}{3N}$	(3.11a (bis))
Y_2	$\bar{\square}$	1	-1	$\frac{1}{N}$	$1 - \frac{1}{3N}$	
A_1	\square	1	0	$-\frac{2(N+1)}{N}$	$\frac{2(N+1)}{3N}$	
A_2	\square	1	0	$-\frac{2}{N}$	$\frac{2}{3N}$	
X	$\bar{\square}$	\square	0	$\frac{1}{N} + 1$	$\frac{2}{3} - \frac{1}{3N}$	
$\bar{\phi}$	1	1	0	2	$\frac{4}{3}$	

with superpotential

$$W = \text{Tr}(A_1 X X + A_2 Y_1 Y_2) + \bar{\phi} A_2^N. \quad (3.11b \text{ (bis)})$$

Since all the chiral fields have non-negative charge under $U(1)_R^{\mathcal{N}=2} = U(1)_R + \frac{1}{3}U(1)_{\mathfrak{A}}$, only those with vanishing charge, i.e., A_1 and A_2 , can appear in Coulomb branch operators. Thus, the complete set of Coulomb branch operators is given by the $SU(N)$ baryons $\mathcal{O}_p = A_1^{2p} A_2^{N-2p}$ for $p = 1, \dots, k/2$ (the decoupled baryon $\mathcal{O}_0 = A_2^N$ having been set to zero by the $\bar{\phi}$ F-term). These operators have conformal dimension

$$\Delta \mathcal{O}_p = \frac{3}{2} Q_{U(1)_R}[\mathcal{O}_p] = 2p + 1 \quad (5.1)$$

so we find a set of Coulomb branch operators with dimensions $3, 5, \dots, k+1$, as expected [55].

Giving a vev to a single such operator \mathcal{O}_p will break $SU(N) \rightarrow USp(2p) \times SO(N-2p)$ and initiate a flow. After integrating out massive matter in the IR this leads to two decoupled sectors. The first one is manifestly $\mathcal{N} = 2$ supersymmetric, having matter content

	$SO(N-2p)$	$USp(2N-2)$	$U(1)_R^{\mathcal{N}=2}$	
A_1	\square	1	0	(5.2a)
X	\square	\square	1	

and superpotential

$$W = \text{Tr}(A_1 X^2). \quad (5.2b)$$

This is an $\mathcal{N} = 2$ $SO(N-2p)$ gauge theory with $N-1$ hypermultiplets in the \square representation. (This theory is infrared free for all p).

The second factor has matter content

	$USp(2p)$	$SO(2)$	$U(1)_R^{\mathcal{N}=2}$
Y	\square	\square	1
A_2	$\square\square$	1	0
$\bar{\phi}$	1	1	2
v	1	1	0

(5.3a)

and superpotential

$$W = v\bar{\phi}A_2^{2p} + \text{Tr}(A_2 Y^2), \quad (5.3b)$$

where v is the chiral superfield with a vev.

This theory *would* be manifestly $\mathcal{N} = 2$ supersymmetric, were it not for the $v\bar{\phi}A_2^{2p}$ superpotential term. To understand the effect of this extra term, consider the case $p = 1$. Without the $v\bar{\phi}A_2^{2p}$ superpotential term, we obtain a manifestly $\mathcal{N} = 2$ supersymmetric $SU(2)$ gauge theory with $\mathcal{N}_f = 1$ flavor, together with a free hypermultiplet made out of v and $\bar{\phi}$. The exact Coulomb branch solution to the interacting part of this theory is well known [79, 80]: at low energies the theory flows to an $\mathcal{N} = 2$ Maxwell theory, except at three points on the Coulomb branch where additional magnetic / dyonic hypermultiplets become massless. These three points are symmetrically distributed around the origin. In particular, there is no extra hypermultiplet at the origin of the Coulomb branch. Turning the $v\bar{\phi}A_2^{2p}$ coupling back on gives a mass to the Coulomb branch operator A_2^2 of the $SU(2)$ theory, together with $\bar{\phi}$, so the Coulomb branch of the $SU(2)$ theory is lifted. We end up with a free $\mathcal{N} = 2$ $U(1)$ vector multiplet made of the $\mathcal{N} = 1$ $U(1)$ vector multiplet and v .

Thus, in $\mathcal{N} = 2$ language, upon giving the dimension-three Coulomb branch operator $\mathcal{O}_1 = A_1^2 A_2^{N-2}$ a vev, the $R_{2,k}$ (even k) theory flows to an $SO(N-2)$ gauge theory with $N-1 = k$ hypers in the \square representation together with a pure-gauge $U(1)$ gauge theory. Note that since $\tau = e^{\pi i/3}$ at the origin of the Coulomb branch of the $\mathcal{N}_f = 1$ $SU(2)$ Seiberg-Witten theory [80], the $U(1)$ holomorphic gauge coupling is frozen at this value along this portion of the Coulomb branch.²⁹

We expect that a similar analysis will yield an explicitly $\mathcal{N} = 2$ description of (5.3) for all p , but we not attempt it here.

²⁹In fact, this is required for the discrete symmetries to match between the UV and IR. A careful analysis of (5.3) reveals the presence of an additional \mathbb{Z}_{2p+1} discrete symmetry. For $p = 1$, the only way that this \mathbb{Z}_3 symmetry can act on the low-energy effective theory is as an electromagnetic duality symmetry $\mathbb{Z}_3 \subset SL(2, \mathbb{Z})$, which is broken unless $\tau = e^{\pi i/3}$.

5.2 Odd k Coulomb branch

The odd k case behaves very similarly, but the technical analysis is fairly cumbersome, so we will be very brief, and just describe the results. Recall from (3.22) the matter content for this theory. We can identify a set of Coulomb branch operators of the form

$$\mathcal{O}_p := A_1^{N-2-2p} A_2^{2p} Q \quad (5.4)$$

with $p = 1, \dots, (k-1)/2$ and

$$\Delta \mathcal{O}_p = 2p + 1. \quad (5.5)$$

That is, we have a set of Coulomb branch operators of dimensions $3, 5, \dots, k$, which is again the expected answer [81].

Turning on a vev for \mathcal{O}_p we again flow in the infrared to two decoupled sectors. The first is manifestly $\mathcal{N} = 2$, with matter content

	$USp(N-2-2p)$	$SO(2N+2)$	$U(1)_R^{\mathcal{N}=2}$	
B	$\square\square$	1	0	(5.6a)
Y	\square	\square	1	

and superpotential

$$W = \text{Tr}(BY^2). \quad (5.6b)$$

The second sector is precisely as in the even k case:

	$USp(2p)$	$SO(2)$	$U(1)_R^{\mathcal{N}=2}$	
X	\square	\square	1	(5.7a)
A	$\square\square$	1	0	
$\bar{\phi}$	1	1	2	
v	1	1	0	

with superpotential

$$W = v\bar{\phi}A^{2p} + \text{Tr}(AX^2). \quad (5.7b)$$

As before, this theory flows to an $\mathcal{N} = 2$ pure-gluon $U(1)$ gauge theory with $\tau = e^{\pi i/3}$ when $p = 1$. We leave an analysis of the case $p > 1$ to future work.

As a non-trivial consistency check, consider $R_{2,3}$, for which the only Coulomb branch operator is \mathcal{O}_1 . Putting $N = 4$ and $p = 1$, we find that the sector (5.6) disappears whereas (5.7) becomes the $\mathcal{N} = 2$ pure-gluon $U(1)$ theory with $\tau = e^{\pi i/3}$, as argued above. As $R_{2,3}$ is the E_6 Minahan-Nemeschansky theory [31], this is the expected result.

6 Mass deformation

Finally, let us comment briefly on the effect of turning on mass deformations, and how to see that they reproduce the expected results in a simple but interesting example: the mass deformation of the rank one E_6 Minahan-Nemeschansky theory to $\mathcal{N} = 2$ $SU(2)$ with 5 flavours. This deformation is natural from the point of view of the F-theory realisation of the Minahan-Nemeschansky theories: what we are doing is taking one of the C 7-branes on the A^5BC^2 E_6 stack to infinity, leaving A^5BC , namely an eight dimensional $SO(10)$ theory.³⁰ The worldvolume theory for a D3 probe on this stack is precisely $SU(2)$ with five flavours.

We are therefore interested in identifying a relevant gauge invariant operator leaving a $SO(10)$ subgroup of the flavour symmetry unbroken. A quick look to (3.27) suggests a natural candidate: $\bar{\phi}$. Adding the mass deformation term $m\bar{\phi}$ to the superpotential (3.27b) leads to

$$W_{E_6\text{-deform}} = A_1A_2Z + A_2Y\Phi + A_1Y_1\Phi_1 + PQY + P_1QY_1 + (A_1^2Q + m)\bar{\phi}, \quad (6.1)$$

which will force the $SU(3)$ baryon A_1^2Q to get a vev. This breaks $SU(3) \times SU(2) \rightarrow SU(2)$ (embedded as the diagonal subgroup of $SU(2) \times SU(2) \subset SU(3) \times SU(2)$). After integrating out the resulting massive fields, we obtain the matter content

	$SU(2)$	$SU(5)$	$U(1)_y$	$U(1)_R^{\mathcal{N}=2}$	
S	$\square\square$	1	0	0	
A	\square	$\bar{\square}$	-1	1	
B	\square	\square	1	1	(6.2a)

with superpotential

$$W = \text{Tr}(BSA), \quad (6.2b)$$

which is indeed the $\mathcal{N} = 2$ $SU(2)$ theory with five flavours.³¹

Although this theory is infrared free, we can reach more interesting theories by further mass deformation. First, giving a mass to a single hypermultiplet yields the superconformal $SU(2)$ theory with four flavors. From there, it is possible to reach (A_1, D_4) by a further mass deformation [9], as well as the (A_1, A_3) and (A_1, A_2) theories [8]. As these mass deformations are thoroughly explored in existing literature, we will not discuss them any further here.

7 Conclusions and further directions

In this paper we have introduced a new approach for systematically constructing $\mathcal{N} = 1$ Lagrangians for the $R_{2,k}$ $\mathcal{N} = 2$ SCFTs. These Lagrangians pass a multitude of very nontrivial

³⁰We refer the reader unfamiliar with the relevant F-theory constructions to [82] for background and notation.

³¹Note that the flavor symmetry is actually $SO(10)$. Here we only display the $SU(5) \times U(1)_y$ subgroup that was manifest in the UV Lagrangian we started with.

checks: symmetries, anomalies, central charges and superconformal indices all match with the expected $\mathcal{N} = 2$ fixed points in the IR, and various properties of their moduli spaces and mass deformations all agree with the expected results.

The appearance of the $R_{2,k}$ theories is ultimately due to the fact that our parent $\mathcal{N} = 1$ theory is the complex cone over \mathbb{F}_0 . The methods developed in [19] are nevertheless much more general, so a natural question is which other $\mathcal{N} = 2$ theories can be reached by applying the same methods to other classes of singularities. A natural class of spaces to consider is the Calabi-Yau cones over $Y^{2n,0}$ [83–87], which generalises the $n = 1$ case studied here.

Along similar lines, it would be interesting to drop some of the assumptions in [19], for example by allowing for the presence of flavour branes and non-compact orientifolds. This is again likely to lead to new $\mathcal{N} = 1$ Lagrangians for interesting $\mathcal{N} = 2$ theories.

More generally, we would like to develop a more direct method of deriving our results. Our approach is certainly roundabout: we are using $\mathcal{N} = 1$ dualities to understand $\mathcal{N} = 2$ dualities! This is very surprising, and contrary to the usual expectation that having more supersymmetry makes analysis of duality simpler. While the fundamental new ideas in our analysis of “brane bending” and “deconfinement” — introduced in [18, 19] to understanding interacting $\mathcal{N} = 1$ SCFTs — require us to deviate from purely $\mathcal{N} = 2$ supersymmetric language, there is no obvious reason why they cannot be applied more directly to the class- \mathcal{S} construction. Understanding whether this is possible — and if so how to do so systematically — is a natural challenge raised by our results.

Acknowledgments

We thank F. Albertini, P. Argyres, F. Carta, S. Cremonesi, M. Lemos and S. Razamat for helpful discussions. I.G.E. is partially supported by STFC grant ST/T000708/1 and by the Simons Foundation collaboration grant on Global Categorical Symmetries (award number 888990). The research of B.H. and A.K.S. was supported by National Science Foundation grant PHY-1914934.

A Superconformal index for $R_{2,2k}$

We compute the superconformal index for $R_{2,2k}$ from the matter content given in (3.11a) with $N = 2k + 1$. We are using conventions for the fugacities t and J_n similar to [18]. We display only a small number of terms in the index and computations to different ranks and higher order in t can be done using the computer program of [18].

Index for $R_{2,2}$:

$$\begin{aligned}
& 1 + \mathfrak{R}^2 t^{4/3} (1 + X_{2,0}) + \frac{t^{5/3} X_{1,0}}{\mathfrak{R}^2} + t^2 \left(-2 - X_{2,0} + \frac{1}{\mathfrak{R}^6} + \mathfrak{R}^3 \left(\frac{X_{0,1}}{z} + z X_{0,1} \right) - J_1 X_{1,0} \right) \\
& + t^{7/3} \left(-\frac{J_1 + X_{1,0}}{\mathfrak{R}^4} - \mathfrak{R}^2 (-X_{1,0} - J_1 (2 + X_{2,0})) \right) + t^{8/3} \left(\mathfrak{R} \left(-\frac{X_{0,1}}{z} - z X_{0,1} \right) \right. \\
& + \left. \frac{2 + 2J_1 X_{1,0}}{\mathfrak{R}^2} + \mathfrak{R}^4 (1 + X_{0,2} + X_{2,0} + X_{4,0}) \right) + t^3 \left(\frac{J_1}{\mathfrak{R}^6} + \mathfrak{R}^3 \left(\frac{J_1 X_{0,1}}{z} + z J_1 X_{0,1} \right) \right. \\
& - \left. (2 + J_2) X_{1,0} - J_1 (3 + X_{2,0}) + X_{3,0} \right) + t^{10/3} \left(\frac{-\frac{1}{z} - z}{\mathfrak{R}} + \frac{-1 - J_2 - J_1 X_{1,0} + X_{2,0}}{\mathfrak{R}^4} \right. \\
& + \mathfrak{R}^5 \left(\frac{X_{0,1} + X_{2,1}}{z} + z (X_{0,1} + X_{2,1}) \right) + \mathfrak{R}^2 \left(-1 - X_{0,2} + J_1 X_{1,0} \right. \\
& \left. - 4X_{2,0} + J_2 (2 + X_{2,0}) - X_{2,1} - J_1 X_{3,0} - X_{4,0} \right) + \dots
\end{aligned}$$

Index for $R_{2,4}$:

$$\begin{aligned}
& 1 + t^{4/3} \mathfrak{R}^2 (1 + X_{2,0,0,0}) \\
& + t^2 \left(-2 - X_{2,0,0,0} + \frac{1}{\mathfrak{R}^6} \right) + t^{7/3} \left(-\frac{J_1 - X_{1,0,0,0}}{\mathfrak{R}^4} + \mathfrak{R}^2 J_1 (2 + X_{2,0,0,0}) \right) \\
& + t^{8/3} \left(\frac{2 - J_1 X_{1,0,0,0}}{\mathfrak{R}^2} + \mathfrak{R}^4 (1 + X_{0,2,0,0} + X_{2,0,0,0} + X_{4,0,0,0}) \right) \\
& + t^3 \left(X_{0,0,1,0} + \frac{J_1 - X_{1,0,0,0}}{\mathfrak{R}^6} + X_{1,0,0,0} - J_1 (3 + X_{2,0,0,0}) \right) \\
& + t^{10/3} \left(\frac{1}{\mathfrak{R}^{10}} + \mathfrak{R}^5 \left(\frac{X_{0,0,0,1}}{z} + z X_{0,0,0,1} \right) + \frac{-1 - J_2 + 2J_1 X_{1,0,0,0} + X_{2,0,0,0}}{\mathfrak{R}^4} \right. \\
& + \mathfrak{R}^2 (-1 - J_1 X_{0,0,1,0} - X_{0,2,0,0} - 4X_{2,0,0,0} + J_2 (2 + X_{2,0,0,0})) \\
& \left. - \mathfrak{R}^2 (X_{2,1,0,0} - X_{4,0,0,0}) \right) + \dots
\end{aligned}$$

Index for $R_{2,6}$:

$$\begin{aligned}
& 1 + \mathfrak{R}^2 t^{4/3} (1 + X_{2,0,0,0,0,0}) \\
& + t^2 \left(-2 - X_{2,0,0,0,0,0} + \frac{1}{\mathfrak{R}^6} \right) + t^{7/3} \left(-\frac{J_1}{\mathfrak{R}^4} + \mathfrak{R}^2 J_1 (2 + X_{2,0,0,0,0,0}) \right) \\
& + t^{8/3} \left(\frac{2}{\mathfrak{R}^2} + \mathfrak{R}^4 (1 + X_{0,2,0,0,0,0} + X_{2,0,0,0,0,0} + X_{4,0,0,0,0,0}) \right) \\
& + t^3 \left(\frac{J_1 + X_{1,0,0,0,0,0}}{\mathfrak{R}^6} - J_1 (3 + X_{2,0,0,0,0,0}) \right) + \dots
\end{aligned}$$

References

- [1] D. Gaiotto, $\mathcal{N} = 2$ dualities, *JHEP* **08** (2012) 034, [[0904.2715](#)].
- [2] O. Chacaltana, J. Distler and Y. Tachikawa, Gaiotto duality for the twisted A_{2N-1} series, *JHEP* **05** (2015) 075, [[1212.3952](#)].
- [3] Y. Tachikawa, $N=2$ supersymmetric dynamics for pedestrians, vol. 890 of *Lecture Notes in Physics*. Springer, 12, 2013. 10.1007/978-3-319-08822-8.
- [4] Y. Tachikawa, A review of the T_N theory and its cousins, *PTEP* **2015** (2015) 11B102, [[1504.01481](#)].
- [5] Y. Tachikawa, Six-dimensional $D(N)$ theory and four-dimensional SO - USp quivers, *JHEP* **07** (2009) 067, [[0905.4074](#)].
- [6] Y. Tachikawa, $N=2$ S -duality via Outer-automorphism Twists, *J. Phys. A* **44** (2011) 182001, [[1009.0339](#)].
- [7] K. Maruyoshi and J. Song, Enhancement of Supersymmetry via Renormalization Group Flow and the Superconformal Index, *Phys. Rev. Lett.* **118** (2017) 151602, [[1606.05632](#)].
- [8] K. Maruyoshi and J. Song, $\mathcal{N} = 1$ deformations and RG flows of $\mathcal{N} = 2$ SCFTs, *JHEP* **02** (2017) 075, [[1607.04281](#)].
- [9] P. Agarwal, K. Maruyoshi and J. Song, $\mathcal{N} = 1$ Deformations and RG flows of $\mathcal{N} = 2$ SCFTs, part II: non-principal deformations, *JHEP* **12** (2016) 103, [[1610.05311](#)].
- [10] P. Agarwal, A. Sciarappa and J. Song, $\mathcal{N} = 1$ Lagrangians for generalized Argyres-Douglas theories, *JHEP* **10** (2017) 211, [[1707.04751](#)].
- [11] S. Benvenuti and S. Giacomelli, Lagrangians for generalized Argyres-Douglas theories, *JHEP* **10** (2017) 106, [[1707.05113](#)].
- [12] S. Giacomelli, RG flows with supersymmetry enhancement and geometric engineering, *JHEP* **06** (2018) 156, [[1710.06469](#)].
- [13] F. Carta and A. Mininno, No go for a flow, *JHEP* **05** (2020) 108, [[2002.07816](#)].
- [14] S. S. Razamat and G. Zafrir, $N = 1$ conformal dualities, *JHEP* **09** (2019) 046, [[1906.05088](#)].
- [15] S. S. Razamat and G. Zafrir, $\mathcal{N} = 1$ conformal duals of gauged E_n MN models, *JHEP* **06** (2020) 176, [[2003.01843](#)].
- [16] S. S. Razamat, E. Sabag and G. Zafrir, Weakly coupled conformal manifolds in 4d, *JHEP* **06** (2020) 179, [[2004.07097](#)].
- [17] G. Zafrir, An $\mathcal{N} = 1$ Lagrangian for an $\mathcal{N} = 3$ SCFT, *JHEP* **01** (2021) 062, [[2007.14955](#)].
- [18] I. García Etxebarria and B. Heidenreich, Strongly coupled phases of $\mathcal{N} = 1$ S -duality, *JHEP* **09** (2015) 032, [[1506.03090](#)].
- [19] I. García Etxebarria and B. Heidenreich, S -duality in $\mathcal{N} = 1$ orientifold SCFTs, *Fortsch. Phys.* **65** (2017) 1700013, [[1612.00853](#)].
- [20] I. García Etxebarria, B. Heidenreich and T. Wrase, New $N=1$ dualities from orientifold transitions. Part I. Field Theory, *JHEP* **10** (2013) 007, [[1210.7799](#)].
- [21] I. García Etxebarria, B. Heidenreich and T. Wrase, New $N=1$ dualities from orientifold

transitions - Part II: String Theory, *JHEP* **10** (2013) 006, [[1307.1701](#)].

- [22] M. Bianchi, D. Bufalini, S. Mancani and F. Riccioni, *Mass deformations of unoriented quiver theories*, *JHEP* **07** (2020) 015, [[2003.09620](#)].
- [23] A. Antinucci, S. Mancani and F. Riccioni, *Infrared duality in unoriented Pseudo del Pezzo*, *Phys. Lett. B* **811** (2020) 135902, [[2007.14749](#)].
- [24] A. Antinucci, M. Bianchi, S. Mancani and F. Riccioni, *Suspended Fixed Points*, [2105.06195](#).
- [25] A. Amariti, M. Fazzi, S. Rota and A. Segati, *Conformal S-dualities from O-planes*, [2108.05397](#).
- [26] N. Seiberg, *Electric - magnetic duality in supersymmetric nonAbelian gauge theories*, *Nucl. Phys. B* **435** (1995) 129–146, [[hep-th/9411149](#)].
- [27] K. A. Intriligator and P. Pouliot, *Exact superpotentials, quantum vacua and duality in supersymmetric $SP(N(c))$ gauge theories*, *Phys. Lett. B* **353** (1995) 471–476, [[hep-th/9505006](#)].
- [28] M. Berkooz, *The Dual of supersymmetric $SU(2k)$ with an antisymmetric tensor and composite dualities*, *Nucl.Phys.* **B452** (1995) 513–525, [[hep-th/9505067](#)].
- [29] P. Pouliot, *Duality in SUSY $SU(N)$ with an antisymmetric tensor*, *Phys.Lett.* **B367** (1996) 151–156, [[hep-th/9510148](#)].
- [30] I. García Etxebarria, F. Saad and A. M. Uranga, *Quiver gauge theories at resolved and deformed singularities using dimers*, *JHEP* **06** (2006) 055, [[hep-th/0603108](#)].
- [31] J. A. Minahan and D. Nemeschansky, *An $N=2$ superconformal fixed point with $E(6)$ global symmetry*, *Nucl. Phys. B* **482** (1996) 142–152, [[hep-th/9608047](#)].
- [32] D. A. Cox, J. B. Little and H. K. Schenk, *Toric Varieties*, vol. 124 of *Graduate Studies in Mathematics*. American Mathematical Society, 2011.
- [33] E. Witten, *Baryons and branes in anti-de Sitter space*, *JHEP* **07** (1998) 006, [[hep-th/9805112](#)].
- [34] P. Goddard, J. Nuyts and D. I. Olive, *Gauge Theories and Magnetic Charge*, *Nucl. Phys.* **B125** (1977) 1.
- [35] C. Montonen and D. I. Olive, *Magnetic Monopoles as Gauge Particles?*, *Phys. Lett.* **B72** (1977) 117.
- [36] G. W. Moore and E. Witten, *Selfduality, Ramond-Ramond fields, and K theory*, *JHEP* **05** (2000) 032, [[hep-th/9912279](#)].
- [37] O. Bergman, E. G. Gimon and S. Sugimoto, *Orientifolds, RR torsion, and K theory*, *JHEP* **05** (2001) 047, [[hep-th/0103183](#)].
- [38] H. Garcia-Compean and O. Loaiza-Brito, *Branes and fluxes in orientifolds and K theory*, *Nucl. Phys. B* **694** (2004) 405–442, [[hep-th/0206183](#)].
- [39] O. Loaiza-Brito, *Instantonic branes, Atiyah-Hirzebruch spectral sequence, and $SL(2,Z)$ duality of $N=4$ SYM*, *Nucl. Phys. B* **680** (2004) 271–301, [[hep-th/0311028](#)].
- [40] F. Denef, *Les Houches Lectures on Constructing String Vacua*, *Les Houches* **87** (2008) 483–610, [[0803.1194](#)].
- [41] A. Hatcher, *Algebraic Topology*. Cambridge University Press, 2002.
- [42] O. Aharony and Y. Tachikawa, *S-folds and 4d $N=3$ superconformal field theories*, *JHEP* **06**

- (2016) 044, [1602.08638].
- [43] S. Franco, A. Hanany, K. D. Kennaway, D. Vegh and B. Wecht, *Brane dimers and quiver gauge theories*, *JHEP* **01** (2006) 096, [hep-th/0504110].
- [44] B. Feng, Y.-H. He, K. D. Kennaway and C. Vafa, *Dimer models from mirror symmetry and quivering amoebae*, *Adv. Theor. Math. Phys.* **12** (2008) 489–545, [hep-th/0511287].
- [45] S. Franco, A. Hanany, D. Krefl, J. Park, A. M. Uranga and D. Vegh, *Dimers and orientifolds*, *JHEP* **09** (2007) 075, [0707.0298].
- [46] M. Yamazaki, *Brane Tilings and Their Applications*, *Fortsch. Phys.* **56** (2008) 555–686, [0803.4474].
- [47] R. G. Leigh and M. J. Strassler, *Exactly marginal operators and duality in four-dimensional $N=1$ supersymmetric gauge theory*, *Nucl. Phys. B* **447** (1995) 95–136, [hep-th/9503121].
- [48] D. Green, Z. Komargodski, N. Seiberg, Y. Tachikawa and B. Wecht, *Exactly Marginal Deformations and Global Symmetries*, *JHEP* **06** (2010) 106, [1005.3546].
- [49] P. C. Argyres and N. Seiberg, *S -duality in $N=2$ supersymmetric gauge theories*, *JHEP* **12** (2007) 088, [0711.0054].
- [50] N. Broomhead, *Dimer models and Calabi-Yau algebras*, 0901.4662.
- [51] A. Hanany, C. P. Herzog and D. Vegh, *Brane tilings and exceptional collections*, *JHEP* **0607** (2006) 001, [hep-th/0602041].
- [52] I. R. Klebanov and E. Witten, *Superconformal field theory on three-branes at a Calabi-Yau singularity*, *Nucl. Phys. B* **536** (1998) 199–218, [hep-th/9807080].
- [53] F. Benini, Y. Tachikawa and B. Wecht, *Sicilian gauge theories and $N=1$ dualities*, *JHEP* **01** (2010) 088, [0909.1327].
- [54] D. Gaiotto and S. S. Razamat, *$\mathcal{N} = 1$ theories of class \mathcal{S}_k* , *JHEP* **07** (2015) 073, [1503.05159].
- [55] O. Chacaltana, J. Distler and A. Trimm, *A Family of 4D $\mathcal{N} = 2$ Interacting SCFTs from the Twisted A_{2N} Series*, 1412.8129.
- [56] E. Witten, *An $SU(2)$ Anomaly*, *Phys. Lett. B* **117** (1982) 324–328.
- [57] Y. Tachikawa, Y. Wang and G. Zafrir, *Comments on the twisted punctures of A_{even} class S theory*, *JHEP* **06** (2018) 163, [1804.09143].
- [58] P. C. Argyres and J. R. Wittig, *Infinite coupling duals of $N=2$ gauge theories and new rank 1 superconformal field theories*, *JHEP* **01** (2008) 074, [0712.2028].
- [59] O. Chacaltana, J. Distler and Y. Tachikawa, *Nilpotent orbits and codimension-two defects of 6d $\mathcal{N} = (2, 0)$ theories*, *Int. J. Mod. Phys. A* **28** (2013) 1340006, [1203.2930].
- [60] D. Gaiotto, G. W. Moore and A. Neitzke, *Framed BPS States*, *Adv. Theor. Math. Phys.* **17** (2013) 241–397, [1006.0146].
- [61] O. Aharony, N. Seiberg and Y. Tachikawa, *Reading between the lines of four-dimensional gauge theories*, *JHEP* **08** (2013) 115, [1305.0318].
- [62] D. Gaiotto, A. Kapustin, N. Seiberg and B. Willett, *Generalized Global Symmetries*, *JHEP* **02** (2015) 172, [1412.5148].

- [63] G. Zafrir, *An $N=1$ Lagrangian for the rank 1 E_6 superconformal theory*, [1912.09348](#).
- [64] D. Anselmi, D. Freedman, M. T. Grisaru and A. Johansen, *Nonperturbative formulas for central functions of supersymmetric gauge theories*, *Nucl. Phys. B* **526** (1998) 543–571, [[hep-th/9708042](#)].
- [65] D. Anselmi, J. Erlich, D. Freedman and A. Johansen, *Positivity constraints on anomalies in supersymmetric gauge theories*, *Phys. Rev. D* **57** (1998) 7570–7588, [[hep-th/9711035](#)].
- [66] K. A. Intriligator and B. Wecht, *The Exact superconformal R symmetry maximizes a*, *Nucl. Phys. B* **667** (2003) 183–200, [[hep-th/0304128](#)].
- [67] C. Romelsberger, *Counting chiral primaries in $N = 1$, $d=4$ superconformal field theories*, *Nucl. Phys. B* **747** (2006) 329–353, [[hep-th/0510060](#)].
- [68] J. Kinney, J. M. Maldacena, S. Minwalla and S. Raju, *An Index for 4 dimensional super conformal theories*, *Commun. Math. Phys.* **275** (2007) 209–254, [[hep-th/0510251](#)].
- [69] C. Romelsberger, *Calculating the Superconformal Index and Seiberg Duality*, [0707.3702](#).
- [70] A. Gadde, L. Rastelli, S. S. Razamat and W. Yan, *Gauge Theories and Macdonald Polynomials*, *Commun. Math. Phys.* **319** (2013) 147–193, [[1110.3740](#)].
- [71] A. Gadde, L. Rastelli, S. S. Razamat and W. Yan, *The Superconformal Index of the E_6 SCFT*, *JHEP* **08** (2010) 107, [[1003.4244](#)].
- [72] A. Gadde, S. S. Razamat and B. Willett, *“Lagrangian” for a Non-Lagrangian Field Theory with $\mathcal{N} = 2$ Supersymmetry*, *Phys. Rev. Lett.* **115** (2015) 171604, [[1505.05834](#)].
- [73] Y. Tachikawa, *On the 6d origin of discrete additional data of 4d gauge theories*, *JHEP* **05** (2014) 020, [[1309.0697](#)].
- [74] M. Del Zotto, I. García Etxebarria and S. S. Hosseini, *Higher form symmetries of Argyres-Douglas theories*, *JHEP* **10** (2020) 056, [[2007.15603](#)].
- [75] L. Bhardwaj, M. Hubner and S. Schafer-Nameki, *1-form Symmetries of 4d $N = 2$ Class S Theories*, [2102.01693](#).
- [76] D. Gaiotto, A. Neitzke and Y. Tachikawa, *Argyres-Seiberg duality and the Higgs branch*, *Commun. Math. Phys.* **294** (2010) 389–410, [[0810.4541](#)].
- [77] M. Martone, *Testing our understanding of SCFTs: a catalogue of rank-2 $\mathcal{N}=2$ theories in four dimensions*, [2102.02443](#).
- [78] C. Beem and W. Peelaers, *Argyres-Douglas Theories in Class S Without Irregularity*, [2005.12282](#).
- [79] N. Seiberg and E. Witten, *Electric - magnetic duality, monopole condensation, and confinement in $N=2$ supersymmetric Yang-Mills theory*, *Nucl. Phys. B* **426** (1994) 19–52, [[hep-th/9407087](#)].
- [80] N. Seiberg and E. Witten, *Monopoles, duality and chiral symmetry breaking in $N=2$ supersymmetric QCD*, *Nucl. Phys. B* **431** (1994) 484–550, [[hep-th/9408099](#)].
- [81] O. Chacaltana and J. Distler, *Tinkertoys for Gaiotto Duality*, *JHEP* **11** (2010) 099, [[1008.5203](#)].
- [82] O. DeWolfe and B. Zwiebach, *String junctions for arbitrary Lie algebra representations*, *Nucl. Phys. B* **541** (1999) 509–565, [[hep-th/9804210](#)].

- [83] J. P. Gauntlett, D. Martelli, J. Sparks and D. Waldram, *Supersymmetric AdS(5) solutions of M theory*, *Class. Quant. Grav.* **21** (2004) 4335–4366, [[hep-th/0402153](#)].
- [84] J. P. Gauntlett, D. Martelli, J. Sparks and D. Waldram, *Sasaki-Einstein metrics on $S^{*2} \times S^{*3}$* , *Adv. Theor. Math. Phys.* **8** (2004) 711–734, [[hep-th/0403002](#)].
- [85] J. P. Gauntlett, D. Martelli, J. F. Sparks and D. Waldram, *A New infinite class of Sasaki-Einstein manifolds*, *Adv. Theor. Math. Phys.* **8** (2004) 987–1000, [[hep-th/0403038](#)].
- [86] J. P. Gauntlett, D. Martelli, J. Sparks and D. Waldram, *Supersymmetric AdS backgrounds in string and M-theory*, *IRMA Lect. Math. Theor. Phys.* **8** (2005) 217–252, [[hep-th/0411194](#)].
- [87] D. Martelli and J. Sparks, *Toric geometry, Sasaki-Einstein manifolds and a new infinite class of AdS/CFT duals*, *Commun. Math. Phys.* **262** (2006) 51–89, [[hep-th/0411238](#)].