

Polynomial kernels for edge modification problems towards block and strictly chordal graphs*

Maël Dumas^{1†} Anthony Perez² Mathis Rocton³ Ioan Todinca²

¹ *Institute of Informatics, University of Warsaw, Warsaw, Poland*

² *Université d'Orléans, INSA CVL, LIFO UR 4022, Orléans, France*

³ *Algorithms and Complexity Group, TU Wien, Vienna, Austria*

revisions 5th Feb. 2024, 12th Nov. 2024; accepted 14th Feb. 2025.

We consider edge modification problems towards block and strictly chordal graphs, where one is given an undirected graph $G = (V, E)$ and an integer $k \in \mathbb{N}$ and seeks to *edit* (add or delete) at most k edges from G to obtain a block graph or a strictly chordal graph. The *completion* and *deletion* variants of these problems are defined similarly by only allowing edge additions for the former and only edge deletions for the latter. Block graphs are a well-studied class of graphs and admit several characterizations, e.g. they are diamond-free chordal graphs. Strictly chordal graphs, also referred to as *block duplicate graphs*, are a natural generalization of block graphs where one can add true twins of cut-vertices. Strictly chordal graphs are exactly dart and gem-free chordal graphs. We prove the NP-completeness for most variants of these problems and provide:

- $O(k^2)$ vertex-kernels for BLOCK GRAPH EDITING and BLOCK GRAPH DELETION
- $O(k^3)$ vertex-kernels for STRICTLY CHORDAL COMPLETION and STRICTLY CHORDAL DELETION
- an $O(k^4)$ vertex-kernel for STRICTLY CHORDAL EDITING

Keywords: parameterized complexity, kernelization, graph modification, block graphs, strictly chordal graphs

1 Introduction

Parameterized algorithms are among the most natural approaches to tackle NP-hard optimization problems (14). In particular, they have been very successful in dealing with so-called edge modification problems on graphs: given as input an arbitrary graph $G = (V, E)$ and a parameter $k \in \mathbb{N}$, the goal is to transform G into a graph with some specific properties (i.e., belonging to a specific graph class \mathcal{G}) by adding and/or deleting at most k edges. Parameterized algorithms (also called FPT for *fixed parameter tractable*) aim at a time complexity of type $f(k) \cdot n^{O(1)}$, where f is some computable function, hence the combinatorial explosion is restricted to parameter k .

* A preliminary version of this work appeared in IPEC'21 (21). All results concerning BLOCK GRAPH EDITING are new to this submission.

† A majority of the work for this paper was conducted when M. Dumas was affiliated with Université d'Orléans.

When the target class \mathcal{G} is characterized by a finite family of forbidden induced subgraphs, modification problems are FPT by a result of Cai (9). Indeed, as long as the graph contains one of the forbidden subgraphs, one can try each possibility to correct this obstruction and branch by recursive calls. On each branch, the budget k is strictly diminished, therefore the whole algorithm has a number of calls bounded by some function $f(k)$. The situation is more complicated when the target class \mathcal{G} is characterized by an infinite family of forbidden induced subgraphs. Nonetheless, a large literature is devoted to edge modification problems towards chordal graphs (where we forbid all induced cycles with at least four vertices) as well as sub-classes of chordal graphs, typically obtained by requiring some fixed set of obstructions, besides the long cycles. Observe that, in this case, the situation remains relatively simple if we restrict ourselves to *edge completion* problems, where we are only allowed to *add* edges to the input graphs. Indeed, in this case, if a graph has an induced cycle of length longer than $k + 3$, it cannot be made chordal by adding at most k edges. Therefore we can use again the approach of Cai to deal with cycles of length at most $k + 3$ and other obstructions, and either the algorithm finds a solution in $f(k)$ recursive calls, or we can conclude that we have a no-instance. The cases of *edge deletion* problems (where we are only allowed to remove edges) and *edge editing* problems (where we are allowed to both remove edges or add missing edges) are more complicated, since even long cycles can be eliminated by a single edge removal. Therefore more efforts and more sophisticated techniques were necessary in these situations, but several such problems turned out to be FPT (11, 16, 17). The interested reader can refer to (12) for a broad and comprehensive survey on parameterized algorithms for edge modification problems.

We focus here on a sub-family of parameterized algorithms, namely on *kernelization*. The goal of kernelization is to provide a polynomial algorithm transforming any instance (I, k) of the problem into an equivalent instance (I', k') where k' is upper bounded by some function of k (in our case we will simply have $k' \leq k$), and the size of the new instance I' is upper bounded by some function $g(k)$. Hence the size of the reduced instance does not depend on the size of the original instance. Kernels are obtained through a set of *reduction rules*. While kernelization is possible for all FPT problems (the two notions are actually equivalent), the interesting question is whether a given FPT problem admits *polynomial kernels*, where the size of the reduced instance is bounded by some polynomial in k . Note that, under some complexity assumptions, not all FPT problems admit polynomial kernels (5, 6, 7, 10, 25, 33).

In this paper we focus on BLOCK GRAPH EDITING, BLOCK GRAPH DELETION and all three variants of modification problems towards strictly chordal graphs. *Block* graphs are a well-studied subclass of chordal graphs, that are diamond-free (Figure 2). They are moreover the graphs in which every biconnected component induces a clique. Notice that this observation allows for a simple polynomial-time algorithm for BLOCK GRAPH COMPLETION since one needs to turn every biconnected component of the input graph into a clique. *Strictly chordal* graphs are another subclass of chordal graphs, also known as *block duplicate* graphs (30, 31, 24). They can be obtained from block graphs by repeatedly choosing some cut-vertex u and adding a *true twin* v of u , that is a vertex v adjacent to u and all neighbors of u (24). They can also be characterized as *dart*, *gem-free* chordal graphs (see Figure 2 and next section) and are thus *ptolemaic* (*i.e.* chordal distance-hereditary (8)). Strictly chordal graphs are also known to be a subclass of 4-leaf power graphs (31), and a super-class of 3-leaf power graphs (16).

Related work Kernelization for CHORDAL COMPLETION goes back to the '90s and the seminal paper of Kaplan, Shamir and Tarjan (29). In this work, the authors provide an $O(k^3)$ vertex-kernel for CHORDAL COMPLETION (also known as MINIMUM FILL-IN) that was later improved to $O(k^2)$ by a tighter anal-

ysis (37). Since then, several authors addressed completion, deletion and/or editing problems towards sub-classes of chordal graphs, such as 3-leaf power graphs (3), split and threshold graphs (26), proper interval graphs (4), trivially perfect graphs (2, 19, 22, 26, 20) or ptolemaic graphs (13). We provide a general picture for some of those classes Figure 1.

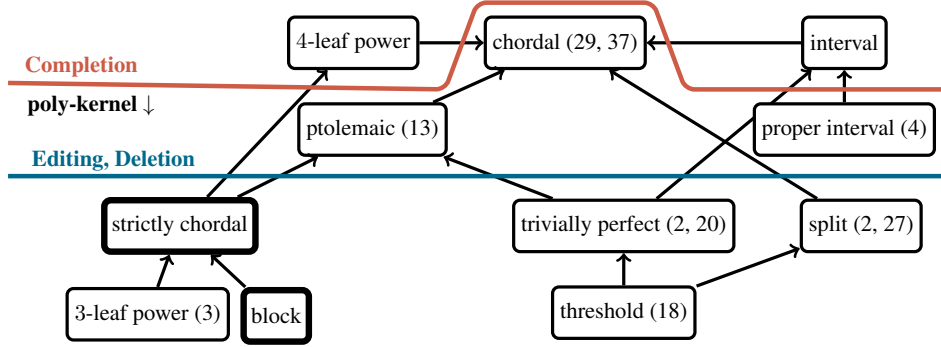

Fig. 1: Kernelization status of subclasses of chordal graphs. A class below the red or blue line indicates that the corresponding completion, deletion or editing problem admits a polynomial kernel. All the edge modification problems for the presented classes are NP-complete at the exception of the ones for 4-leaf power for which the complexity is unknown, SPLIT EDITING which is surprisingly in P (27), and BLOCK GRAPH COMPLETION which is also in P as observed previously.

All these classes have in common that they can be defined as chordal graphs, plus a constant number of obstructions. Moreover, several known results deal with classes that share a very common feature (see e.g. (4, 32, 3, 20)). Very informally, the target class \mathcal{G} admits a tree-like decomposition, in the sense that the vertices of any graph $H \in \mathcal{G}$ can be partitioned into clique modules (having the same neighborhood in H), and these modules can be mapped onto the nodes of a decomposition tree, the structure of the tree describing the adjacencies between modules. Therefore, if an arbitrary graph G can be transformed into graph H by at most k edge additions or deletions, at most $2k$ modules can be affected by the modifications. By removing the affected nodes from the decomposition tree, we are left with several components (*chunks*) that correspond, in the initial graph G as well as in H , to induced subgraphs that may be large but that already belong to the target class. Moreover, these chunks are attached to the rest of graph G in a very regular way, through one or two nodes of the decomposition tree. The kernelization algorithms need to analyze these chunks and provide reduction rules, typically by ensuring a small number of nodes in the decomposition tree, plus the fact that each node corresponds to a module of small size. However, finding a general framework that captures this particular decomposition does not seem to be an easy task as each class exhibits particular structural properties that may need to be dealt with independently.

As mentioned earlier, when restricted to completion problems any input graph cannot have large induced cycles and this property may be exploited to design kernelization algorithms. This observation lead to the following conjecture by Bessy and Perez (4).

Conjecture 1 ((4)) *Let \mathcal{G} be a class of graphs that can be defined as chordal graphs plus a constant number of obstructions Then, the \mathcal{G} -COMPLETION problem admits a polynomial kernel.*

Several other questions remain open, for example it is not known whether CHORDAL DELETION or CHORDAL EDITING admit polynomial kernels (12).

Our contribution We first prove that most variants of the considered problems are NP-Complete, the only exception being the BLOCK GRAPH COMPLETION problem that admits a polynomial-time algorithm. Secondly, we give kernelization algorithms for all these problems, with different bounds. First of all, we begin by illustrating the techniques we will use on the BLOCK GRAPH EDITING problem and obtain the following result.

Theorem 1 BLOCK GRAPH EDITING and BLOCK GRAPH DELETION admit a kernel with $O(k^2)$ vertices.

Next, we present kernelization algorithms for the STRICTLY CHORDAL EDITING problem and obtain better vertex-kernels for both STRICTLY CHORDAL COMPLETION and STRICTLY CHORDAL DELETION.

Theorem 2 STRICTLY CHORDAL EDITING admits a kernel with $O(k^4)$ vertices.

Theorem 3 STRICTLY CHORDAL COMPLETION and STRICTLY CHORDAL DELETION admit kernels with $O(k^3)$ vertices.

Above all, our purpose is to exhibit general techniques that might, we hope, be extended to kernelizations for edge modification problems towards other graph classes. In particular, unlike the general strategy we previously described, both the classes of block graphs and of strictly chordal graphs do not have exactly a tree-like decomposition. Still, they can be decomposed into structures that can be seen as a generalization of a tree. Our algorithms exploit these informal observations and provide the necessary reduction rules together with the combinatorial analysis for the kernel size. Finally, we note that while both kernels use structures and rules that are similar, the ones for BLOCK GRAPH EDITING are significantly simpler, hence the kernel for this problem is a nice warm-up for the one for STRICTLY CHORDAL EDITING. Moreover, even though reduction rules for STRICTLY CHORDAL EDITING may be directly adapted for BLOCK GRAPH EDITING, it would lead to a significantly larger kernel.

Outline The paper is organized as follows. We begin with some preliminary results and definitions, including the NP-completeness proofs of aforementioned problems (Section 2). We then describe a kernel with $O(k^2)$ vertices for BLOCK GRAPH EDITING and BLOCK GRAPH DELETION (Section 3), introducing the techniques that will be adapted to obtain an $O(k^4)$ vertex-kernel for STRICTLY CHORDAL EDITING (Section 4). We then explain how these techniques produce $O(k^3)$ vertex-kernels for both STRICTLY CHORDAL COMPLETION and STRICTLY CHORDAL DELETION (Section 5) and then conclude with some perspective and open problems (Section 6).

2 Preliminaries

We consider simple, undirected graphs $G = (V, E)$ where V denotes the *vertex set* and $E \subseteq (V \times V)$ the *edge set* of G . We will sometimes use $V(G)$ and $E(G)$ to clarify the context. Given a vertex $u \in V$, the *open neighborhood* of u is the set $N_G(u) = \{v \in V : uv \in E\}$. The *closed neighborhood* of u is defined as $N_G[u] = N_G(u) \cup \{u\}$. Two vertices u and v are *true twins* if $N_G[u] = N_G[v]$. Given a subset of vertices $S \subseteq V$, $N_G[S]$ is the set $\cup_{v \in S} N_G[v]$ and $N_G(S)$ is the set $N_G[S] \setminus S$. We will omit the mention to G whenever the context is clear. A subset of vertices $M \subseteq V$ is a *module* if for every vertices

$x, y \in M$, $N(x) \setminus M = N(y) \setminus M$. The subgraph induced by S is defined as $G[S] = (S, E_S)$ where $E_S = \{uv \in E : u \in S, v \in S\}$. For the sake of readability, given a subset $S \subseteq V$ we define $G \setminus S$ as $G[V \setminus S]$. A subgraph C is a *connected component* of G if it is a maximal connected subgraph of G . A graph is *biconnected* if it is still connected after removing any vertex. A subgraph C is a *biconnected component* of G if it is a maximal biconnected subgraph of G . A set $S \subseteq V$ is a *separator* of G if $G \setminus S$ is not connected. Given two vertices u and v of G , the separator S is a *uv-separator* if u and v lie in distinct connected components of $G \setminus S$. Moreover, S is a *minimal uv-separator* if no proper subset of S is a *uv-separator*. Finally, a separator S is *minimal* if there exists a pair $\{u, v\}$ such that S is a minimal *uv-separator*.

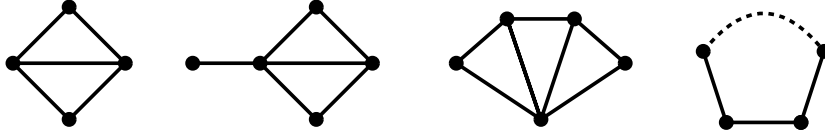

Fig. 2: The *diamond*, *dart*, *gem* and *hole* (cycle of length at least 4)

Definition 1 Given a graph $G = (V, E)$, a *critical clique* of G is a set $K \subseteq V$ such that $G[K]$ is a clique, K is a module and is inclusion-wise maximal under this property.

Notice that K is a maximal set of true twins and that the set $\mathcal{K}(G)$ of critical cliques of any graph G partitions its vertex set $V(G)$. This leads to the following definition.

Definition 2 (Critical clique graph) Let $G = (V, E)$ be a graph. The *critical clique graph* of G is the graph $\mathcal{C}(G) = (\mathcal{K}(G), E_C)$ with $E_C = \{KK' \mid \forall u \in K, \forall v \in K', uv \in E\}$.

Block and strictly chordal graphs Block graphs are graphs in which every biconnected component is a clique. They can also be characterized as chordal graphs that do not contain diamonds as induced subgraph (1) (see Figure 2). A natural generalization of block graphs are strictly chordal graphs, also known as block duplicate graphs, that are obtained from block graphs by adding true twins (30, 31, 24). Note that by definition the critical clique graph $\mathcal{C}(G)$ is a block graph.

Theorem 4 (Theorem 8 (35)) Let $G = (V, E)$ be a graph. The following properties are equivalent:

1. G is a strictly chordal graph,
2. G does not contain any *dart*, *gem* or *hole* as an induced subgraph (see Figure 2),
3. G is chordal and the minimal separators of G are pairwise disjoint.

We consider the following problems:

BLOCK GRAPH EDITING

Input: A graph $G = (V, E)$, an integer $k \in \mathbb{N}$

Question: Does there exist a set of pairs $F \subseteq (V \times V)$ of size at most k such that the graph $H = (V, E \Delta F)$ is a block graph, with $E \Delta F = (E \setminus F) \cup (F \setminus E)$?

The STRICTLY CHORDAL EDITING problem is defined similarly, requiring the graph $H = (V, E \Delta F)$ to be strictly chordal. The BLOCK GRAPH COMPLETION and STRICTLY CHORDAL COMPLETION (resp. BLOCK GRAPH DELETION and STRICTLY CHORDAL DELETION) problems are defined similarly by requiring F to be disjoint from (resp. included in) edge set E . Given a graph $G = (V, E)$, a set $F \subseteq (V \times V)$ such that the graph $H = (V, E \Delta F)$ belongs to the target graph class is called an *edition* of G . When F is disjoint from E (resp. included in E) it is called a *completion* (resp. a *deletion*) of G . For the sake of simplicity we use $G \Delta F$, $G + F$ and $G - F$ to denote the resulting graphs in all versions of the problems. In all cases, F is *optimal* whenever it is minimum-sized. Given an instance $(G = (V, E), k)$ of any of the aforementioned problems, we say that F is a *k-edition* (resp. *k-completion*, *k-deletion*) whenever F is an edition (resp. completion, deletion) of size at most k . A vertex is *affected* by F whenever it is contained in some pair of F . We say that an instance $(G = (V, E), k)$ is a yes-instance whenever it admits a *k-edition* (resp. *k-completion*, *k-deletion*). When applied to an instance (I, k) of the problem, a reduction rule is said to be *safe* if (I, k) is a yes-instance if and only if the reduced instance (I', k') is a yes-instance.

We will use the following result that guarantees that any clique module of a given graph G will remain a clique module in any optimal edition towards some hereditary class of graphs closed under true twin addition, in particular towards strictly chordal graphs.

Lemma 1 ((3)) *Let \mathcal{G} be an hereditary class of graphs closed under true twin addition. For every graph $G = (V, E)$, there exists an optimal edition (resp. completion, deletion) F into a graph of \mathcal{G} such that for any two critical cliques K and K' either $(K \times K') \subseteq F$ or $(K \times K') \cap F = \emptyset$.*

Notice in particular that Lemma 1 implies that whenever the target graph class is hereditary and closed under true twin addition one may reduce the size of critical cliques to $k + 1$. We shall see Section 3 that this result does not apply to block graphs. However, we will still be able to bound the size of critical cliques by $O(k)$.

Join composition \otimes We now turn our attention to the notion of *join composition* (operation \otimes) between two graphs. This operation will play an important part in the proofs of our reduction rules for all considered problems.

Definition 3 *Let $G_1 = (V_1, E_1)$ and $G_2 = (V_2, E_2)$ be two vertex-disjoint graphs and let $S_1 \subseteq V_1, S_2 \subseteq V_2$. The join composition of G_1 and G_2 on S_1 and S_2 , denoted $(G_1, S_1) \otimes (G_2, S_2)$, is the graph:*

$$(G_1, S_1) \otimes (G_2, S_2) = (V_1 \cup V_2, E_1 \cup E_2 \cup (S_1 \times S_2))$$

Lemma 2 *Let $G_1 = (V_1, E_1)$ and $G_2 = (V_2, E_2)$ be two disjoint chordal graphs, $S_1 \subseteq V_1$ and $S_2 \subseteq V_2$ be non-empty cliques of respectively G_1 and G_2 and $G = (G_1, S_1) \otimes (G_2, S_2)$. Then graph G is chordal, and any minimal separator S of G is also a minimal separator of G_1 or G_2 , except if $S = S_i$ for $i \in \{1, 2\}$ and S_i is strictly included in a maximal clique of G_i .*

Proof: The graph G is chordal since any cycle of G is either contained in one of G_1, G_2 or, if it intersects both of them, contains at least three vertices of $S_1 \cup S_2$, which is a clique in G . In both cases, if the cycle has four or more vertices then it contains a chord.

Any minimal separator S of chordal graph G is the intersection of two maximal cliques Ω, Ω' of G , and moreover S is a minimal ab -separator for any $a \in \Omega \setminus S, b \in \Omega' \setminus S$ — in particular, S is strictly included in each of the cliques (see, e.g., Theorem 7 and Lemma 5 in (23)). By construction of G , any of its maximal cliques is either a maximal clique of G_1 or of G_2 , or it is exactly $S_1 \cup S_2$.

If $S = \emptyset$, then graph G is not connected. This only happens if one of the graphs G_i is not connected, since neither S_1 nor S_2 are empty. In this case, S is a minimal separator of G_1 or G_2 .

From now on, we assume that S is not empty. Consider first the case where none of Ω, Ω' equals $S_1 \cup S_2$. Then both Ω, Ω' are contained in the same G_i , for $i \in \{1, 2\}$ (otherwise their intersection S would be empty). Assume w.l.o.g they are both in G_1 , we claim that $S = \Omega \cap \Omega'$ is a minimal separator of G_1 . Take $a \in \Omega \setminus S$ and $b \in \Omega' \setminus S$. Since S separates a and b in G , it also separates them in G_1 , which is a subgraph of G . But S is in the common neighborhood of a and b in G_1 , thus S is minimal among the ab -separators of G_1 , and the conclusion follows.

We are left with the case when $\Omega = S_1 \cup S_2$ and Ω' is contained in one of the two graphs G_i , say in G_1 . Therefore $S \subseteq S_1$. If this inclusion is strict, we claim that S is also a minimal separator of G_1 . Indeed S is a minimal separator in G for any $a \in \Omega \setminus S$ and $b \in \Omega' \setminus S$, therefore we can choose $a \in S_1 \setminus S$. Again S separates a and b in the subgraph G_1 of G , and since S is in the common neighborhood of a and b in G_1 , it is necessarily a minimal separator of G . We deduce that, if S is not a minimal separator of G_1 , we must have $S = S_1$. We conclude that S is strictly contained in the maximal clique Ω' of G_1 , which proves our lemma. \square

We now present sufficient conditions on the sets S_1 and S_2 so that if the graphs G_1 and G_2 are block or strictly chordal, then so is the graph $(G_1, S_1) \otimes (G_2, S_2)$.

Lemma 3 *Let $G_1 = (V_1, E_1)$ and $G_2 = (V_2, E_2)$ be two disjoint block graphs and let $S_1 \subseteq V_1, S_2 \subseteq V_2$. The graph $G = (G_1, S_1) \otimes (G_2, S_2)$ is a block graph if for $i \in \{1, 2\}$, S_i is a single vertex or a maximal clique of G_i .*

Proof: Observe that minimal separators of block graphs are single vertices since the biconnected components of block graphs are cliques. From Lemma 2, G is chordal and its minimal separators are the ones of G_1 and G_2 plus possibly S_1 (resp. S_2) if it is a not maximal clique of G_1 (resp. G_2). Hence minimal separators of G are single vertices and it follows that G is a block graph. \square

Lemma 4 *Let $G_1 = (V_1, E_1)$ and $G_2 = (V_2, E_2)$ be two disjoint strictly chordal graphs and let $S_1 \subseteq V_1, S_2 \subseteq V_2$. The graph $G = (G_1, S_1) \otimes (G_2, S_2)$ is strictly chordal if for $i \in \{1, 2\}$, S_i is a critical clique, a maximal clique or intersects exactly one maximal clique of G_i .*

Proof: From Lemma 2, G is chordal and its minimal separators are the ones of G_1 and G_2 plus possibly S_1 or S_2 if they are not maximal cliques. If S_i intersects exactly one maximal clique, $i \in \{1, 2\}$, it is clear that it does not intersect any minimal separator of G_i . If S_i is a critical clique, we claim that either S_i is a minimal separator of G_i or does not intersect any minimal separator of G_i . Indeed, if there is a minimal (clique) separator S of G_i such that $S_i \subset S$, then since S_i is a critical clique, there exist $u \in S_i, v \in S \setminus S_i$ and $w \in V(G_i) \setminus S$ such that w is adjacent to exactly one of u and v . Suppose w.l.o.g. that w is adjacent to u and not to v , then u is in a minimal vw -separator that intersects S and is not equal to it. This is a contradiction since G_i is strictly chordal and by Theorem 4 its minimal separators are pairwise disjoint. It follows that the minimal separators of G are pairwise disjoint and by Theorem 4 G is strictly chordal. \square

In the proofs of some rules for the kernel for STRICTLY CHORDAL EDITING and its variants, we will have to do a join composition of some graphs G_2, \dots, G_r on a graph G_1 with the same set of vertices $S_1 \subseteq V(G_1)$. The following observation guarantees us that this operation is possible.

Observation 1 *Let $G_1 = (V_1, E_1), \dots, G_r = (V_r, E_r)$ be disjoint strictly chordal graphs and for each $i \in \{1, \dots, r\}$ let $S_i \subseteq V_i$ be a critical clique, a maximal clique or a set that intersects exactly one maximal clique of G_i . If S_1 is a critical clique or intersects exactly one maximal clique of G_1 , then S_1 is a critical clique or intersects exactly one maximal clique of $(G_1, S_1) \otimes (G_2, S_2)$. This implies by Lemma 4 that $(G_1, S_1) \otimes (\bigcup_{2 \leq i \leq r} G_i, \bigcup_{2 \leq i \leq r} S_i)$ is strictly chordal (see Figure 3).*

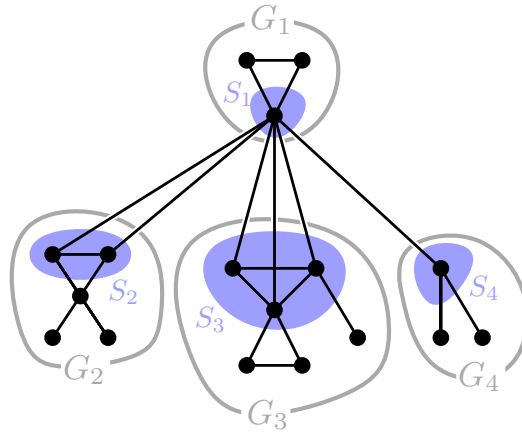

Fig. 3: Example of a graph $G = (G_1, S_1) \otimes (\bigcup_{2 \leq i \leq 4} G_i, \bigcup_{2 \leq i \leq 4} S_i)$ as constructed in Observation 1. There, S_1 intersects exactly one maximal clique of G_1 and is a critical clique of G ; S_2 intersects exactly one maximal clique of G_2 ; S_3 is a maximal clique of G_3 ; S_4 is a critical clique of G_4 .

Spanning block subgraph The following result is crucial to bound the size of the kernels for all variants of the studied modification problems. For a graph G , let $d(G)$ be the set of vertices of degree at least 3 in G .

Lemma 5 *Let $G = (V, E)$ be a connected block graph, A be a subset of $V(G)$ and T_A be a minimal connected induced subgraph of G that spans all vertices of A . Denote by $d(T_A)$ the set of vertices of degree at least 3 in T_A . The following holds:*

- (i) *The subgraph T_A is unique,*
- (ii) $|d(T_A)| \leq 3 \cdot |A|,$
- (iii) *The graph $T_A \setminus (A \cup d(T_A))$ contains at most $2 \cdot |A|$ connected components.*

Proof: We first prove the uniqueness of T_A . Observe that the internal vertices of a shortest path P in G between two vertices u and v are cut-vertices of G , since it is a block graph. Moreover, for any such internal vertex w of P , vertices u and v are in different components of $G - w$. Therefore, P is unique, and any path between u and v must contain every vertex of P . Hence, the vertices of T_A are either in A or separating vertices of A , and the uniqueness of T_A follows, proving Item i.

To prove Item ii we will proceed by induction on the size of A . For $|A| \leq 2$ we have that $|d(T_A)| = 0$. Suppose now that $|A| \geq 3$. Let $a \in A$ be a non-cut-vertex of T_A . Such a vertex exists, e.g., it is sufficient to choose a longest path of T_A , and let a be one of the endpoints. Then a is not a cut vertex of T_A (as the end of a longest path), and $a \in A$ by minimality of T_A . Notice moreover that a is in only one maximal clique of T_A . Let $A' = A \setminus \{a\}$ and let $T_{A'}$ be a minimal connected induced subgraph of G that spans all vertices of A' . Observe that $T_{A'}$ is an induced subgraph of T_A . We show that $|d(T_A)| \leq |d(T_{A'})| + 3$. Since T_A is connected, there exists a path in T_A from a to a vertex $u \in V(T_A) \setminus V(T_{A'})$ adjacent to some vertices of $T_{A'}$ ($a = u$ is possible), moreover u is unique. Any vertex on the path except for u is of degree at most 2 in T_A . Let $N = N_G(u) \cap V(T_{A'})$ and note that since $T_{A'}$ is a connected block graph, N is a clique. By construction, the vertices of $T_{A'}$ have the same degree in T_A and $T_{A'}$, except for the ones in N . Since u might be of degree 3 or more, if $|N| \leq 2$ then $|d(T_A)| \leq |d(T_{A'})| + 3$. If $|N| \geq 4$, then all vertices in N already have degree 3 in $T_{A'}$, hence $|d(T_A)| = |d(T_{A'})| + 1$. If $|N| = 3$ and N contains a vertex of degree 3 in $T_{A'}$, then $|d(T_A)| \leq |d(T_{A'})| + 3$. Otherwise, we claim that $V(T_{A'}) = N$. Indeed, if all vertices in N have degree 2 in $T_{A'}$, the only possibility is that N is exactly the vertex set of $T_{A'}$, because $T_{A'}$ is connected, N induces a clique of size 3 in this graph and no vertex of N has other neighbors than the ones in N . In this case we have $|A| = 4$ and $|d(T_A)| = 4$, which satisfies Item ii. Therefore, except for the latter case, we have $|d(T_A)| \leq |d(T_{A'})| + 3$, and using the induction hypothesis we have $|d(T_A)| \leq |d(T_{A'})| + 3 \leq 3 \cdot |A'| + 3 = 3 \cdot |A|$.

We are left with Item iii, which can be proven in a similar way as the previous one. Using the same notation, the only vertices of $T_{A'}$ whose degree may increase in T_A are in N . Therefore, every connected component of $T_{A'} \setminus (A' \cup d(T_{A'}))$ that does not contain vertices of N is also a connected component of $T_A \setminus (A \cup d(T_A))$. Moreover, a connected component of $T_{A'} \setminus (A' \cup d(T_{A'}))$ may contain vertices of N only if these vertices have degree at most 2 in $T_{A'}$ and are not in A . In particular $|N| \leq 2$ and both vertices lie in the same connected component of $T_{A'} \setminus (A' \cup d(T_{A'}))$ (if any). Therefore, this connected component may be split in two disjoint ones in $T_A \setminus (A \cup d(T_A))$ if the vertices of N are removed. Moreover, an additional connected component corresponding to the path between a and u may exist in T_A . Hence, we can only increase the number of connected components of $T_A \setminus (A \cup d(T_A))$ by compared to $T_{A'} \setminus (A' \cup d(T_{A'}))$. Since the property is verified for $|A| = 1$, it follows by induction that there are $2 \cdot |A|$ connected components in $T_A \setminus (A \cup d(T_A))$. \square

2.1 Hardness results

We first show the NP-completeness of BLOCK GRAPH DELETION and BLOCK GRAPH EDITING by giving a reduction from CLUSTER DELETION and CLUSTER EDITING, known to be NP-complete (34, 39, 36). Notice that BLOCK GRAPH COMPLETION admits a polynomial-time algorithm due to the very nature of block graphs: any biconnected component of the input graph (computable in linear time (28)) must be turned into a clique.

Lemma 6 BLOCK GRAPH DELETION and BLOCK GRAPH EDITING are NP-Complete.

Proof: We first prove that BLOCK GRAPH DELETION is NP-Complete by providing a reduction from CLUSTER DELETION. A graph is a cluster graph if it does not contain any induced path on three vertices (so-called P_3). Given an instance $(G = (V, E), k)$ of CLUSTER DELETION, we construct an instance of BLOCK GRAPH DELETION by adding a universal vertex u adjacent to all vertices of V . Let $(G' = (V', E'), k)$ be the produced instance.

We show that the graph G admits a k -deletion into a cluster graph if and only if G' admits a k -deletion into a block graph. Suppose first that there is a k -deletion F of G into a cluster graph. The graph $G - F$ is a graph without any P_3 as induced subgraph. Now consider the graph $H' = G' - F$. By construction $H'[V]$ contains no P_3 , so H' is chordal and contains no diamond, thus H' is a block graph.

Now suppose that there exists a k -deletion F' of G' into a block graph. We claim that either F' does not affect the universal vertex u or we can construct a k -deletion F^* from F' that does not affect u . To support this claim, assume that F' contains at least one edge incident to u .

First, suppose that $H' = G' - F'$ is not connected. Let C be the connected component that contains u . For any other connected component C' of H' , take a vertex $v \in V(C')$ and construct the deletion set $F'' = F' \setminus \{(u, v)\}$. By Lemma 3, $(C, \{u\}) \otimes (C', \{v\})$ is a block graph, and the other connected components of H' are unchanged. Hence $G' - F''$ is a block graph and since $|F''| < |F'|$, F'' is a k -deletion. We iterate this construction until we get an intermediate solution F_1^* such that $H_1^* = G' - F_1^*$ is connected.

If F_1^* does not affect u we set $F^* = F_1^*$ and we are done. Otherwise there is at least one vertex v not adjacent to u in H_1^* . Since H_1^* is connected we can choose v at distance exactly 2 from u . Since H_1^* is a block graph we have $N(u) \cap N(v) = \{w\}$. Consider the biconnected component C containing v and w , and let $C' = C \setminus \{w\}$. Since H_1^* is a block graph, C (and thus C') is a clique. Let K_u and K_v be the connected components of $H_1^* - (\{w\} \times C')$ that contain the vertices u and v respectively, they are block graphs by heredity. By Lemma 3 the graph $H_2^* = (K_u, \{u\}) \otimes (K_v, \{C'\})$ is a block graph. Observe that $(\{u\} \times C') \subseteq F_1^*$ since u is an universal vertex and let F_2^* be the deletion set such that $H_2^* = G' - F_2^*$. By construction we can observe that $|F_2^*| = |F_1^*|$, hence F_2^* is a k -deletion of G' into a block graph. We iterate this construction until we get a k -deletion F^* of G that does not affect u .

Finally, $H = G - F^*$ does not contains any P_3 or else there would be a diamond in $G' - F^*$ with the universal vertex u , thus H is a cluster graph.

The same reduction can be done for BLOCK GRAPH EDITING, one needs only to observe that there are no added edges incident to u , and we can use the same argument as above on the deleted edges: if there is no deleted edge incident to u we are done, otherwise we construct another set of deleted edges of equal size, but containing fewer edges incident to u . If in the construction we have to delete an edge that was added by the edition, it is clear that removing this edge from the edition set result in a strictly smaller edition set. \square

The NP-completeness of STRICTLY CHORDAL COMPLETION follows directly from the proof of NP-completeness of 3-LEAF POWER COMPLETION from (16, Theorem 3).

Lemma 7 STRICTLY CHORDAL COMPLETION is NP-complete.

We show the NP-completeness of STRICTLY CHORDAL EDITING and STRICTLY CHORDAL DELETION by giving a reduction from CLUSTER EDITING and CLUSTER DELETION, respectively.

Lemma 8 STRICTLY CHORDAL EDITING and STRICTLY CHORDAL DELETION are NP-complete.

Proof: Given an instance $(G = (V, E), k)$ of CLUSTER EDITING, we construct an instance of STRICTLY CHORDAL EDITING by adding a clique $U = \{u_1, \dots, u_{k+1}\}$ of size $k + 1$ adjacent to all vertices of V , and for each vertex x in V , $k + 1$ vertices $\{v_1^x, \dots, v_{k+1}^x\}$ adjacent only to x . Let $(G' = (V', E'), k)$ be the produced instance. We show that the graph G admits a k -edition into a cluster graph if and only if G' admits a k -edition into a strictly chordal graph. Suppose first that there is a k -edition F of G into a cluster graph. The graph $G \Delta F$ is a graph without any P_3 as induced subgraph. Consider the graph $H' = G' \Delta F$. By construction $H'[V]$ contains no P_3 , so H' is chordal and contains neither gems nor darts since these obstructions contain an induced P_3 and a vertex adjacent to every vertex of this P_3 . By Theorem 4, it follows that H' is strictly chordal. Now suppose that there exists a k -edition F' of G' into a strictly chordal graph $H' = G' \Delta F'$. We claim that $H = G \Delta F'$ is a cluster graph. By contradiction, suppose that $H = H'[V]$ contains a $P_3 \{x, y, z\}$ where x, z are the ends of the path. Then, there exist $i, j \in \{1, \dots, k+1\}$ such that $\{x, y, z, u_i, v_j^y\}$ forms a dart in H' , contradicting that H' is strictly chordal, and thus H is a cluster graph.

The same reduction can be done from CLUSTER DELETION to STRICTLY CHORDAL DELETION. This concludes the proof. \square

3 Kernelization algorithm for BLOCK GRAPH EDITING

We begin this section by providing a high-level description of our kernelization algorithm. A similar technique will be applied for modification problems towards strictly chordal graphs but on the critical clique graph rather than the original one. Let us consider a positive instance $(G = (V, E), k)$ of BLOCK GRAPH EDITING, F a suitable solution and $H = G \Delta F$. Since $|F| \leq k$, we know that at most $2k$ vertices of H may be affected vertices. Let A be the set of such vertices, T the minimum induced subgraph of H that spans all vertices of A and A' the set of vertices of degree at least 3 in T . From Lemma 5 we have $|A' \setminus A| \leq 3 \cdot |A|$. We will define the notion of BG-branch, corresponding to subgraphs of G that induce block graphs. We will focus our interest on two types of BG-branches: the ones that are connected to the rest of the graph by only one (cut) vertex, called *1-BG-branches*, and the ones that are connected to the rest of the graph by exactly two non-adjacent vertices, called *2-BG-branches*. We will prove that we can keep only the cut-vertices of 1-BG-branches and reduce the 2-BG-branches containing more than $k + 3$ vertices. We will see that there are two kinds of connected components remaining in the graph $H \setminus (A \cup A')$, the ones adjacent to maximal cliques of vertices of $A \cup A'$, corresponding to critical cliques (which can be bounded to a linear number of vertices) and the ones adjacent to two non-adjacent vertices of $A \cup A'$ (which correspond to 2-BG-branches in H). Since H is a block graph, we know that there is at most $|A \cup A'| = O(k)$ maximal cliques of vertices of $A \cup A'$. From Lemma 5 we have that there are at most $4k$ connected components in $T \setminus (A \cup A')$, and each one corresponds to a 2-BG-branch in the graph H . It remains that $H \setminus (A \cup A')$ contains a linear number of connected components, each one containing $O(k)$ vertices. Altogether, the graph H contains $O(k^2)$ vertices.

3.1 Classical reduction rules

We first give classical reduction rules when dealing with modification problems. Notice that Lemma 1 cannot be directly applied to BLOCK GRAPH EDITING and BLOCK GRAPH DELETION since block graphs are not closed under true twin addition. Hence one cannot directly reduce the size of critical cliques to $k + 1$ as mentioned Section 2. To circumvent this issue, we provide a slightly weaker reduction rule.

Rule 3.1 Let C be a block connected component of G . Remove $V(C)$ from G .

Rule 3.2 Let $K \subseteq V$ be a set of true twins of G such that $|K| > 2k + 2$. Remove $|K| - (2k + 2)$ arbitrary vertices from K in G .

Lemma 9 Rules 3.1 and 3.2 are safe and can be computed in linear time.

Proof: Rule 3.1 is safe since block graphs are hereditary and closed under disjoint union.

We now turn our attention to Rule 3.2. Let G' denote the graph obtained from the removal of $|K| - (2k + 2)$ arbitrary vertices from K in G and $K' = V(G) \setminus V(G')$. Assume first that G admits a k -edition F . Observe that F is a k -edition of G' by heredity. Conversely, assume that G' admits a k -edition F and let $H' = G' \triangle F$. Notice that since F affects at most $2k$ vertices and since $|K \setminus K'| = 2k + 2$, there exist two unaffected vertices u and v in $K \setminus K'$. We claim that $H = G \triangle F'$ is a block graph. Assume for a contradiction that H contains an obstruction W . By construction, W must intersect K' since otherwise W would exist in H' . Moreover, notice that $|W \cap K'| \leq 2$, otherwise W would contain a clique module with 3 or 4 vertices, which is impossible in a cycle or a diamond. Hence assume first that $|W \cap K'| = \{a\}$: in this case, since u is unaffected we have $N_H[a] \setminus K' = N_{H'}[u]$ and thus the set $(W \setminus \{a\}) \cup \{u\}$ induces an obstruction in H' , a contradiction. Similarly, if $|W \cap K'| = \{a, b\}$ the set $(W \setminus \{a, b\}) \cup \{u, v\}$ induces an obstruction in H' , leading once again to a contradiction. Finally, since the biconnected components can be computed in $O(n + m)$ time (28), since block graphs can be recognized in $O(n + m)$ time and since true twins can be detected in $O(n + m)$ time (using modular decomposition (38)), both rules can be computed in linear time. \square

3.2 Reducing Block Graph branches

Let $G = (V, E)$ be a graph, a *BG-branch* is a connected induced subgraph B of G such that B is a block graph. A vertex $v \in V(B)$ is an *attachment point* of B if $N_G(v) \setminus V(B) \neq \emptyset$. A BG-branch is a p -BG-branch if it has exactly p attachment points. We denote B^R the induced subgraph of B in which all attachment points have been removed. We first define a simple rule that allows to remove all the vertices of a 1-BG-branch except for its attachment point.

Rule 3.3 Let B be a 1-BG-branch of G such that B^R is connected and not empty. Remove $V(B^R)$ from G .

Lemma 10 Rule 3.3 is safe.

Proof: Let B be such a 1-BG-branch and $G' = G \setminus V(B^R)$. Let F be a k -edition of G into a block graph. Since the class of block graphs is hereditary, $(G \triangle F) \setminus V(B^R)$ is a block graph. It follows that $G' \triangle F$ is a block graph and F is a k -edition of G' into a block graph.

Conversely, let F' be a k -edition of G' into a block graph. Let u be the attachment point of B in G . Observe that since B^R is connected and not empty, u is not a cut-vertex of the block graph B and its neighborhood in B is either a maximal clique or a single vertex. Since $H' = G' \triangle F'$ and B are block graphs and $N_B(u)$ is a single vertex or a maximal clique of B , Lemma 3 ensures that $H = (H', \{u\}) \otimes (B^R, N_B(u))$ is a block graph. We can observe that $H = G \triangle F'$, hence F' is a k -edition of G into a block graph. This concludes the proof. \square

We now deal with the 2-BG-branches, which require more technical skills. A 2-BG-branch B is *clean* if B^R is connected and if the two attachment points are not adjacent. For a clean 2-BG-branch B , a *min-cut* of B is a set of edges $M \subseteq E(B)$ of minimum size such that the attachment points p_1 and p_2 are not in the same connected component of $B - M$ and $mc(B)$ is the size of a min-cut of B .

Lemma 11 *Let (G, k) be a yes-instance of BLOCK GRAPH EDITING reduced by Rule 3.3, and B a clean 2-BG-branch of G . If $|V(B)| \geq k + 3$ then there exists a k -edition F of G into a block graph such that the set of pairs of F containing a vertex of $V(B^R)$ is either empty or exactly a min-cut of B .*

Proof: Let B be a clean 2-BG-branch in G with attachment points p_1, p_2 such that $|V(B)| \geq k + 3$. We can observe that $N_B(p_1)$ and $N_B(p_2)$ are maximal cliques or single vertices since B^R is connected. Since B is reduced by Rule 3.3, we can observe that the cut-vertices of B are contained in any path π from p_1 to p_2 . Indeed, if there is a cut-vertex x that is not in π , then p_1 and p_2 are in the same connected component of $B \setminus \{x\}$, implying that there is a connected component K of $B \setminus \{x\}$ containing neither p_1 nor p_2 . Since B is a 2-BG-branch, $N_G(K) = \{x\}$, hence $G[V(K) \cup \{x\}]$ induces a 1-BG-branch of G with attachment point x , a contradiction. Notice in particular that there is a unique shortest path π_s between p_1 and p_2 that contain all cut-vertices of B . Moreover, since the only cut-vertices of B are the ones in π_s , a vertex of B that is not in π_s lies in exactly one maximal clique of B containing two consecutive vertices of π_s .

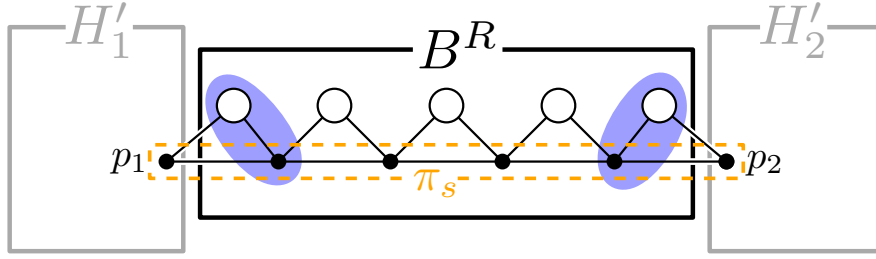

Fig. 4: Illustration of the case where p_1 and p_2 are not in the same connected component of H' in the Lemma 11. The white circles correspond to critical cliques of B . The blue sets correspond to $N_B(p_1)$ and $N_B(p_2)$.

Let F be a k -edition of G into a block graph, $H = G \Delta F$ and $H' = H \setminus V(B^R)$. First consider the case in which p_1 and p_2 are in two different connected components in H' . Let H'_1, H'_2 be the two connected components of H' containing p_1 and p_2 , respectively, and H'_3 the remaining of H' . It follows from Lemma 3 that the graph H^* resulting from the disjoint union of

$$((B^R, N_B(p_1)) \otimes (H'_1, \{p_1\})), N_B(p_2) \otimes (H'_2, \{p_2\})$$

and H'_3 is a block graph (see Figure 4). Let F^* be the edition such that $H^* = G \Delta F^*$. By construction, F^* is a subset of F with no pair containing a vertex of $V(B^R)$.

Assume now that p_1 and p_2 are in the same connected component in H' and let $\pi_{H'}$ denote a shortest path between them. Note that $\pi_{H'}$ may be of length 1 if p_1 and p_2 are adjacent in H' . We first consider the case where there is a path $\pi_B = \{p_1 = u_1, u_2, \dots, u_r = p_2\}$ (not necessarily induced) from p_1 to p_2 in B that still exists in $B \Delta F$. Since B is a clean 2-BG-branch of G reduced by Rule 3.3, we know

by the previous arguments that every cut-vertex of B is in π_B . Note that all vertices in π_B belong to the same biconnected component of H , which is a clique. Hence we can consider w.l.o.g. that π_B is the path containing exactly p_1, p_2 and the cut-vertices of B , which is the shortest path in B between p_1 and p_2 . Since the vertices of π_B induce a path in B (on at least 3 vertices since p_1 and p_2 are not adjacent) and a clique in $B \triangle F$, then for every $i \in \{1, \dots, r-2\}$, we have $(u_i, u_r) \in F$. Any vertex $v \in B \setminus V(\pi_B)$ is adjacent in B to two vertices $w_1, w_2 \in V(\pi_B)$ and if v remains in the same biconnected component as w_1 and w_2 in H , then $(v, p_1) \in F$ or $(v, p_2) \in F$. Otherwise F must contain (v, w_1) or (v, w_2) . In any case, F contains at least one pair for each vertex $v \in B \setminus \{u_{r-1}, u_r\}$. It follows from the previous arguments that $|F| \geq |B| - 2$. However, since $|B| \geq k + 3$ we have $|F| \geq k + 1$, contradicting that F is a solution, therefore there is no such path π_B .

We can assume that if p_1 and p_2 are in the same component of H' , F contains an edge-cut of B or there would be a path π_B from p_1 to p_2 in B that still exists in $B \triangle F$. Let M be a min-cut of B and consider B_1 (resp. B_2) the connected component containing p_1 (resp. p_2) in $B \triangle M$. Both $B_1^R = B_1 \setminus \{p_1\}$ and $B_2^R = B_2 \setminus \{p_2\}$ are induced subgraphs (one of them possibly empty) of B and block graphs by heredity. By Lemma 3, the following graph is a block graph:

$$H^* = ((H', \{p_1\}) \otimes (B_1^R, N_{B_1}(p_1)), \{p_2\}) \otimes (B_2^R, N_{B_2}(p_2))$$

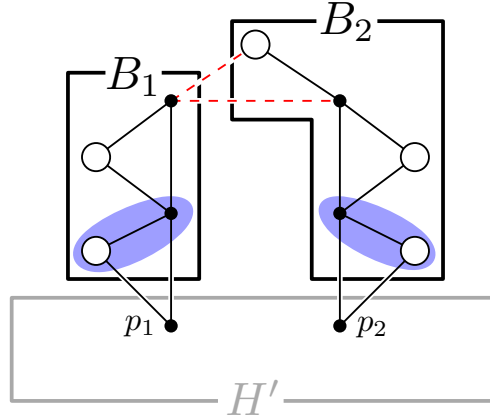

Fig. 5: Illustration of the case where p_1 and p_2 are in the same connected component of H' and F contains a min-cut of B in Lemma 21. The white circles correspond to critical cliques of B . The blue sets correspond to $N_B(p_1)$ and $N_B(p_2)$. The red dotted edges between B_1 and B_2 are edges of an edge-cut of B deleted by the edition.

Let F^* the edition such that $H^* = G \triangle F^*$, we have $F^* = (F \setminus (V(B^R) \times V(G))) \cup M$, since M is a min-cut of B , $|F^*| \leq |F|$ and F^* is a k -edition of G .

In all cases, there exists a k -edition F^* of G into a block graph such that the set pairs of F^* containing a vertex of $V(B^R)$ is either empty or exactly a min-cut of B . This concludes the proof. \square

Rule 3.4 Let $(G = (V, E), k)$ be an instance of BLOCK GRAPH EDITING and B be a clean 2-BG-branch of G containing at least $k + 3$ vertices with attachment points p_1, p_2 . Remove $V(B^R)$ from G and add a vertex x adjacent to p_1 and p_2 , a clique of size $\min\{mc(B) - 1, k\}$ adjacent to p_1 and x and a clique of size k adjacent to p_2 and x .

Lemma 12 *Rule 3.4 is safe.*

Proof: Let G' be the graph obtained from an application of Rule 3.4 on the 2-BG-branch B of graph G with attachment points p_1, p_2 and S the vertices introduced by this rule. Observe that $B' = G'[S \cup \{p_1\} \cup \{p_2\}]$ is a clean 2-BG-branch of G' , $|V(B')| \geq k + 3$ and $mc(B') = \min\{mc(B), k + 1\}$.

Let F be a k -edition of G that satisfies Lemma 11 and $H = G \triangle F$. If F contains a min-cut of B , observe that $mc(B') = mc(B) \leq k$ and consider $B'_i, i \in \{1, 2\}$ the connected component of $B' \triangle F_m$ containing p_i , where F_m is a min-cut of B' . By Lemma 3 the graph

$$H' = ((H \setminus V(B^R), p_1) \otimes (B'_1, N_{B'}(p_1)), p_2) \otimes (B'_2, N_{B'}(p_2))$$

is a block graph. Let F' be the edition such that $H' = G' \triangle F'$. Since $mc(B') = mc(B) \leq k$, by construction $|F'| = |F|$, therefore F' is a k -edition of G' . If F does not contain a min-cut of B , then no vertex of B^R is affected and p_1, p_2 are not in the same connected component of $H \setminus V(B^R)$. Let H_1 and H_2 be the connected components of $H \setminus V(B^R)$ that contain respectively p_1 and p_2 and H_3 the remaining components of $H \setminus V(B^R)$. By Lemma 3 the graph H' corresponding to the disjoint union of

$$(((B'^R, N_{B'}(p_1)) \otimes (H_1, \{p_1\})), N_{B'}(p_2)) \otimes (H_2, \{p_2\})$$

and H_3 is a block graph. We can observe that $H' = G' \triangle F$, hence F is a k -edition of G' into a block graph. The other way is symmetrical. \square

3.3 Bounding the size of the kernel

To conclude our kernelization algorithm we first state that reduction rules involving BG-branches can be applied in polynomial time.

Lemma 13 *Rules 3.3 and 3.4 can be applied in polynomial time.*

Proof: We show that we can enumerate all 1-BG-branches and 2-BG-branches in polynomial time. Recall that recognition of block graphs can be computed in linear time. All 1-BG-branches can be enumerated by removing a vertex $v \in V(G)$ and looking among the remaining connected components those that induce a connected block graph together with v . We proceed similarly to detect clean 2-BG-branches by removing a pair of non-adjacent vertices $u, v \in V(G)$ and looking among the remaining connected components those that induce a connected block graph together with u and v . \square

Theorem 1 BLOCK GRAPH EDITING and BLOCK GRAPH DELETION admit a kernel with $O(k^2)$ vertices.

Proof: Let $(G = (V, E), k)$ be a reduced yes-instance of BLOCK GRAPH EDITING, F a k -edition of G and $H = G \triangle F$. We assume that G is connected, the following arguments can be easily adapted if this is not the case by summing over all connected components of G . Let A be the set of affected vertices of H . Since $|F| \leq k$, we have $|A| \leq 2k$. Let T_A be the connected minimal induced subgraph of H that spans A , and $d(T_A)$ the set of vertices of degree at least 3 in T_A . By Lemma 5, $|d(T_A) \setminus A| \leq 3 \cdot |A| \leq 6k$.

First, we can observe that if there is a cut-vertex $x \in V(H)$ that is not in $V(T_A)$, since T_A is the connected minimal induced subgraph of H that spans all affected vertices, there is a connected component K of $H \setminus \{x\}$ that does not contain any affected vertex. Since $B = H[V(K) \cup \{x\}]$ is a block graph

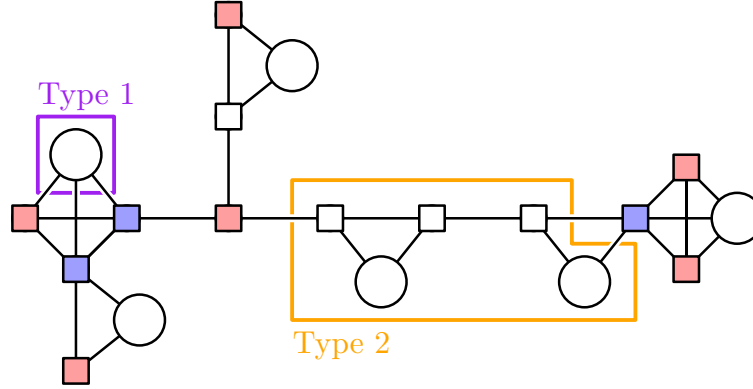

Fig. 6: Illustration of a reduced instance in the proof of Theorem 1. Square nodes correspond to vertices of T_A , the ones filled in red are vertices of A , the ones filled in blue are vertices of $d(T_A) \setminus A$. Circle nodes correspond to critical cliques of G .

by heredity, it follows that B induces a 1-BG-branch with attachment point x and can be reduced by Rule 3.3, a contradiction. It remains that every cut-vertex of H lies in $V(T_A)$ and that every vertex of $V(H) \setminus V(T_A)$ is adjacent to a maximal clique of vertices or a single vertex of $V(T_A)$. Since the graph is reduced under Rule 3.3, the second case can not happen or else there would a 1-BG-branch. Hence, there are two kinds of connected components in $H \setminus (A \cup d(T_A))$, namely the ones that are adjacent to a maximal clique of vertices of $A \cup d(T_A)$ and the ones that are adjacent to two non-adjacent vertices of $A \cup d(T_A)$ (i.e., the ones that contain connected components of $T_A \setminus (A \cup d(T_A))$). We say that these connected components are of type 1 or type 2 respectively (see Figure 6).

The type 1 connected components are cliques since H is a block graph and have the same neighborhood in H , thus they are critical cliques reduced by Rule 3.2 and contains at most $2k + 2$ vertices. Since T_A is a block graph, there is at most $|A \cup d(T_A)| \leq 8k$ maximal cliques of vertices of $A \cup d(T_A)$, hence there are at most $8k \cdot (2k + 2)$ vertices in connected components of type 1.

Now consider the connected components of type 2. We can observe that such a component K together with its adjacent vertices $x, y \in A \cup d(T_A)$ form a clean 2-BG-branch, and thus contains at most $2k + 3$ vertices. By Lemma 5, $T_A \setminus (A \cup d(T_A))$ contains at most $2 \cdot |A| = 4k$ connected components which is exactly the number of type 2 components, hence there are at most $4k \cdot (2k + 1)$ vertices in connected components of type 2.

We conclude that if (G, k) is a reduced yes-instance, then $|V(G)| \leq 24k^2 + 28k$. Therefore, given a reduced instance (G, k) of BLOCK GRAPH EDITING, if $|V(G)| > 24k^2 + 28k$ we can safely conclude that (G, k) is a no-instance and return a trivial no-instance of constant size, thus proving the size of our kernel. Finally we claim that the reduced instance can be computed in polynomial time. Indeed, all reduction rules can be exhaustively applied in polynomial time (Lemmata 9 and 13). For the case of BLOCK GRAPH DELETION, all the lemmata in this section are still true. In particular Lemma 11 holds by simply replacing "k-edition" with "k-deletion", and the proof for the deletion variant is contained in the edition one. Using the same set of rules, we have a kernel with $O(k^2)$ vertices for BLOCK GRAPH DELETION. \square

4 Kernelization algorithm for STRICTLY CHORDAL EDITING

As in the previous section, we begin this section by providing a high-level description of our kernelization algorithm. We use the critical clique graph of strictly chordal graphs, which is a block graph by definition, to bound the number of vertices of a reduced instance. While the technique used to bound the size of the kernels for block graphs and strictly chordal graphs is similar, the structure and rules for the latter are more involved. We thus provide a stand-alone proof of this result for the sake of completeness.

Let us consider a positive instance $(G = (V, E), k)$ of STRICTLY CHORDAL EDITING, F a suitable solution and $H = G \triangle F$. Denote by $\mathcal{C}(H)$ the critical clique graph of H as described in Definition 2. Since $|F| \leq k$, we know that at most $2k$ critical cliques of $\mathcal{C}(H)$ may contain affected vertices. Let A be the set of such critical cliques, T the minimum subgraph of $\mathcal{C}(H)$ that spans all critical cliques of A and A' the set of critical cliques of degree at least 3 in T . Recall that $|A' \setminus A| \leq 3 \cdot |A|$ (Lemma 5). We will define the notion of SC-branch, corresponding to well-structured strictly chordal subgraphs of G . We will focus our interest on two types of SC-branches: the ones that are connected to the rest of the graph by only one critical clique, called *1-SC-branches*, and the ones that are connected to the rest of the graph by exactly two critical cliques, called *2-SC-branches*. This time the 1-SC-branches will only be reduced to two critical cliques. The connected components of the graph $T \setminus (A \cup A')$ are paths, which correspond to subgraphs of 2-SC-branches, and we will bound their length by $k + 3$. We know that there are at most $4k$ such connected components, thus there is $O(k^2)$ critical cliques in T . Finally, the connected components of the graph $\mathcal{C}(H) \setminus V(T)$ correspond to 1-SC-branches or sets of connected 1-SC-branches. The latter case will require a specific reduction rule to be dealt with. This implies that every critical clique or maximal clique of T can have a linear number of 1-SC-branches of $\mathcal{C}(H) \setminus V(T)$ adjacent to it. Altogether, the graph $\mathcal{C}(H)$ contains $O(k^3)$ critical cliques, and each critical clique is of size at most $k + 1$, hence the graph G contains $O(k^4)$ vertices.

From now on, we always assume that the considered optimal editions (resp. completions, deletions) satisfy Lemma 1.

4.1 Classical reduction rules

First, we give classical reduction rules when dealing with modification problems. The first rule is safe for any target graph class hereditary and closed under disjoint union. The second one comes from the fact that strictly chordal graphs are hereditary and closed under true twin addition, combined with Lemma 1.

Rule 4.1 *Let C be a strictly chordal connected component of G . Remove $V(C)$ from G .*

Rule 4.2 *Let $K \subseteq V$ be a set of true twins of G such that $|K| > k + 1$. Remove $|K| - (k + 1)$ arbitrary vertices in K from G .*

Lemma 14 (Folklore, (3)) *Rules 4.1 and 4.2 are safe and can be applied in polynomial time.*

4.2 Reducing Strictly Chordal branches

We now consider the main structure of our kernelization algorithm, namely *SC-branches*.

Definition 4 (SC-branch) *Let $G = (V, E)$ be a graph. We say that a subgraph B of G is a SC-branch if $V(B)$ is a union of critical cliques $K_1, \dots, K_r \in \mathcal{K}(G)$ such that the subgraph of $\mathcal{C}(G)$ induced by K_1, \dots, K_r is a connected block graph.*

We emphasize that our definition of a SC-branch B is stronger than simply requiring B to be an induced strictly chordal graph. For example, if G is the dart graph, the subgraph obtained by removing the pendant vertex is strictly chordal, but it is not a SC-branch because the corresponding critical cliques do not form a block graph in $\mathcal{C}(G)$. Let B be a SC-branch of graph G and let K_1, \dots, K_r be the critical cliques of G contained in $V(B)$. We say that K_i is an *attachment point* of B if $N_G(K_i) \setminus V(B) \neq \emptyset$. A SC-branch B is a p -SC-branch if it has exactly p attachment points. We denote B^R the induced subgraph of B in which all attachment points have been removed.

We first give structural lemmata on SC-branches that will be helpful to prove the safeness of our rules.

Lemma 15 *Let $G = (V, E)$ be a graph and B a SC-branch of G . For any attachment point P of B , let $B' = B \setminus P$, consider the connected components G_1, G_2, \dots, G_r of B' and let $Q_i = N_B(P) \cap V(G_i)$. For every i , $1 \leq i \leq r$, Q_i is a critical clique, a maximal clique or intersects exactly one maximal clique of G_i .*

Proof:

First, we show that all sets Q_i are cliques. Suppose that Q_i is not a clique for some $1 \leq i \leq r$. Let x and y be non-adjacent vertices of Q_i and $z \in P$. Since G_i is connected, take a shortest path π between x and y in G_i . The subgraph induced by the vertices $\{x, y, z\}$ and those of π contains either a cycle of length at least 4 if z is not adjacent to any inner vertex of π , which is a contradiction since B is a block graph, or a diamond with z being one of its vertices of degree 3. In the latter case, since z is not in the same critical clique of $\mathcal{C}(G)$ as its true twin in the diamond, the critical cliques of $\mathcal{C}(G)$ that contain some vertices of this diamond also form a diamond in $\mathcal{C}(G)$. Such a diamond is formed by critical cliques of G contained in B , contradicting the definition of a SC-branch. In all cases we have a contradiction, it remains that Q_i is a clique in G .

Now suppose that Q_i , $1 \leq i \leq r$ is neither a critical clique nor a maximal clique of G_i and intersects at least two maximal cliques of G_i . Suppose first that Q_i is not a module, then there exist $u, v \in Q_i$ and $x \in V(G_i) \setminus Q_i$ adjacent to only u or v . Since Q_i is not a maximal clique of G_i , there exists $y \in V(G_i) \setminus Q_i$ adjacent to u and v . Together with $w \in P$, the vertex set $\{u, v, w, x, y\}$ induces in B a gem if x and y are adjacent and a dart otherwise, leading to a contradiction. If Q_i is a module, since it is not a critical clique (*i.e.* a maximal clique module) there exist $u \in Q_i$ and $v \in V(G_i) \setminus Q_i$ that lie in the same critical clique of G_i . Since Q_i intersects two maximal cliques of G_i , there exist two non-adjacent vertices $x, y \in V(G_i) \setminus Q_i$ that are adjacent to both u and v . Together with $w \in P$, the vertex set $\{u, v, w, x, y\}$ induces a dart in B , leading to a contradiction. It remains that Q_i is a critical clique, a maximal clique or intersects exactly one maximal clique of G_i . \square

Lemma 16 *Let $G = (V, E)$ be a graph and B a SC-branch of G . Let F be an optimal edition of G that respects Lemma 1, and $H = G \triangle F$. For any attachment point P of B , let C be the critical clique of H which contains P and $C' = C \setminus V(B^R)$. If $N_H(C') \cap V(B^R) \neq \emptyset$, then C' is a critical clique or intersects exactly one maximal clique of $H' = H \setminus V(B^R)$.*

Proof: Suppose that C' is not a critical clique of H' and intersects at least two maximal cliques of H' . Since $C' \subseteq C$ is a module but not a critical clique, it is not a maximal clique module and thus there exist $u \in C'$ and $v \notin C'$ that lie in the same critical clique in H' . Notice that there must exist a vertex $w \in N_H(C') \cap V(B^R)$ adjacent to exactly one of u and v in H , since otherwise we would have $N_H(u) \cap V(B) = N_H(v) \cap V(B)$ and $N_{H'}(u) = N_{H'}(v)$, meaning that C is not a critical clique of

H , a contradiction. Since C' intersects two maximal cliques of H' there exist two non-adjacent vertices $x, y \in V(H')$ that are adjacent to both u and v . The vertex set $\{u, v, w, x, y\}$ induces a dart in H if w is not adjacent to neither x nor y , a gem if it is adjacent to one of them, and if w is adjacent to both x and y , $\{w, x, v, y\}$ induces a C_4 in H . It remains that C' is a critical clique of H' or C' is included in exactly one maximal clique of H' if $N_H(C') \cap V(B^R) \neq \emptyset$. \square

In the next result we show that there always exists an optimal edition that affects only the attachment point of a 1-SC-branch and its neighborhood. This will allow us to define our first reduction rule on SC-branches.

Lemma 17 *Let $G = (V, E)$ be a graph and B a 1-SC-branch of G with attachment point P . There exists an optimal edition F of G such that:*

- *The set of vertices of B affected by F is included in $P \cup N_B(P)$.*
- *In $H = G \triangle F$ the vertices of $N_B(P)$ are all adjacent to the same vertices of $V(G) \setminus V(B^R)$.*

Proof: Let F be an optimal edition of G and let $H = G \triangle F$. Recall that we assume that F satisfies Lemma 1. Let G_1, G_2, \dots, G_r be the connected components of B^R and let $Q_i = N_B(P) \cap V(G_i)$. By Lemma 15, for every i , $1 \leq i \leq r$, Q_i is a critical clique, a maximal clique or intersects exactly one maximal clique of G_i . Moreover, the graphs $H' = H \setminus V(B^R)$ and G_1, \dots, G_r are strictly chordal by heredity. Among the vertices of Q_1, \dots, Q_r , choose one that is in the least number of pairs $(x, b) \in F$ with $b \in V(G) \setminus V(B^R)$, say x , and let $N = N_H(x) \setminus V(B^R)$. Observe that since P is a critical clique, $P \cap N = \emptyset$ or $P \subseteq N$. If $P \subseteq N$, let C be the critical clique of H which contains P , take $C' = C \setminus V(B^R)$ and observe that $P \subseteq C' \subseteq N$. By Lemma 16, C' is a critical clique or intersects exactly one maximal clique of H' . By Lemma 4 and Observation 1, the following graph is strictly chordal:

$$H^* = \left(\bigcup_{1 \leq i \leq r} G_i, \bigcup_{1 \leq i \leq r} Q_i \right) \otimes (H', C')$$

If $P \cap N = \emptyset$, let H^* be the strictly chordal graph corresponding to the disjoint union of H' and the graphs G_1, \dots, G_r . Let F^* be such that $H^* = G \triangle F^*$, in both cases by construction $|F^*| \leq |F|$ and the desired properties are verified. \square

Rule 4.3 *Let $(G = (V, E), k)$ be an instance of STRICTLY CHORDAL EDITING. If G contains a 1-SC-branch B with attachment point P , then remove from G the vertices of $V(B^R)$ and add a clique K of size $\min\{|N_B(P)|, k + 1\}$ adjacent to P .*

Lemma 18 *Rule 4.3 is safe.*

Proof: Let G' be the graph obtained from an application of Rule 4.3 on 1-SC-branch B of graph G with attachment point P . We denote by K be the clique that replaced B . Let F be a k -edition of G and $H = G \triangle F$. By Lemma 17 we can assume that F only affects vertices of $P \cup N_B(P)$ and all vertices of $N_B(P)$ are adjacent to the same vertices of $V(G) \setminus V(B^R)$. This implies that if $|N_B(P)| > k$ no k -edition can affect these vertices. Let C be the critical clique of H which contains P and $C' = C \setminus V(B^R)$. By Lemma 16, C' is a critical clique or intersects exactly one maximal clique of $H_a = H \setminus V(B^R)$. If

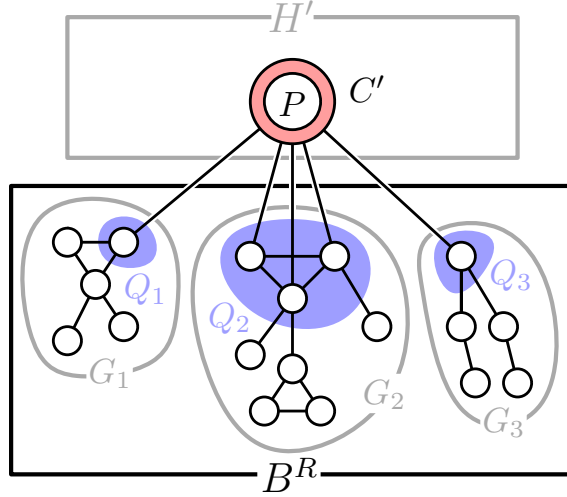

Fig. 7: Illustration of the proof of Lemma 17 for $r = 3$. The graph $H^* = (G_1 \cup G_2 \cup G_3, Q_1 \cup Q_2 \cup Q_3) \otimes (H', C')$ is strictly chordal by Lemma 4.

$N_B(P)$ is adjacent to C' in H , consider the graph $H' = (H_a, C') \otimes (K, K)$. Since K is clique, by Lemma 4, H' is strictly chordal. Else, consider the strictly chordal graph H' corresponding to the disjoint union of H_a and K . Let F' be the edition such that $H' = G' \triangle F'$. Since $|K| = \min\{|N_B(P)|, k + 1\}$, by construction we have $|F| = |F'|$, hence F' is a k -edition of G' .

The other way is almost symmetrical, but we need to be careful that in this case, B^R may contain several connected components. Let F' be a k -edition of G' and $H' = G' \triangle F'$. By Lemma 17 we can assume that F' only affects vertices of $P \cup K$ and all vertices of K are adjacent to the same vertices of $V(G) \setminus K$. This implies that, if $|K| > k$, no k -edition can affect these vertices. Let C be the critical clique of H' which contains P and $C' = C \setminus V(B^R)$. By Lemma 16, C' is a critical clique or intersects exactly one maximal clique of $H'_a = H' \setminus K$. Let G_1, G_2, \dots, G_r be the connected components of B^R and let $Q_i = N_B(P) \cap V(G_i)$. By Lemma 15, for every i , $1 \leq i \leq r$, Q_i is a critical clique, a maximal clique or intersects exactly one maximal clique of G_i .

If the clique K is adjacent to C' in H' , consider the graph $H = (H'_a, C') \otimes (\bigcup_{1 \leq i \leq r} G_i, \bigcup_{1 \leq i \leq r} Q_i)$. By Lemma 4 and Observation 1, H' is strictly chordal. Else, consider the strictly chordal graph H corresponding to the disjoint union of H'_a and G_i for $1 \leq i \leq r$. Let F be the edition such that $H = G \triangle F$, since $|K| = \min\{|N_B(P)|, k + 1\}$, by construction we have $|F| = |F'|$, hence F is a k -edition of G . \square

We now show a result that will allow us to define a rule bounding the number of 1-SC-branches sharing the same neighborhood. In particular, if enough 1-SC-branches share a neighborhood N , they force any edition of size at most k to transform N into a clique.

Lemma 19 *Let $(G = (V, E), k)$ be a yes-instance of STRICTLY CHORDAL EDITING reduced by Rule 4.2. Let B_1, \dots, B_l be disjoint 1-SC-branches of G with attachment points P_1, \dots, P_l which have the same neighborhood N in $G \setminus \bigcup_{i=1}^l V(B_i)$ and form a disjoint union of cliques Q_1, \dots, Q_r in $G[P_1 \cup \dots \cup P_l]$. If $\sum_{i=1}^l |P_i| > 2k + 1$ then for every k -edition F of G :*

- (i) If $r = 1$, N is a clique of $H = G\Delta F$ and N is a critical clique, a maximal clique or intersects exactly one maximal clique of $H' = H \setminus \bigcup_{i=1}^l V(B_i)$,
- (ii) If $r > 1$ and $(\sum_{i=1}^l |P_i|) - \max_{1 \leq j \leq r} \{|Q_j|\} > k$ then N is a critical clique of $H = G\Delta F$ and N is a critical clique or intersects exactly one maximal clique of $H' = H \setminus \bigcup_{i=1}^l V(B_i)$.

Proof: We prove the result by considering each item in separate cases.

Case (i) $r = 1$: We first prove that N has to be clique in H . Suppose that N is not a clique in H , then there exist two vertices $x, y \in N$ such that $xy \notin E(H)$. The attachment points are critical cliques, so by Rule 4.2, $|P_i| \leq k + 1, i \in \{1, \dots, l\}$. We can observe that there is at most one critical clique P_j such that $N_{B_j}(P_j) = \emptyset$. Indeed, since $r = 1$ all attachment points lie in the same clique in $G[P_1 \cup \dots \cup P_l]$, we have that $N_G[P_i] \setminus N_{B_i}(P_i) = N \cup P_1 \cup \dots \cup P_l$, hence there is only one such P_j . It follows that $|Q_1 \setminus P_j| > k$, thus there exists a vertex u in some $P_t, t \neq j$ such that in H , u is adjacent to a vertex $z \in N_{B_t}(P_t)$ and the vertices x and y . Since $|Q_1 \setminus P_t| > k$, there exists a vertex $v \in Q_1 \setminus P_t$ such that there is no pair of F containing both v and a vertex of $\{x, y, z, u\}$. The set $\{x, y, u, v, z\}$ induces a dart if neither x nor y is adjacent to z , a gem if one of them is adjacent to z , or if both of them are adjacent to z , $\{x, y, z, v\}$ induces a C_4 in H , a contradiction. It follows that N has to be a clique.

We now show that N is a critical clique, a maximal clique or intersects exactly one maximal clique of H' . Suppose that N is neither a critical clique nor a maximal clique of H' and intersects at least two maximal cliques of H' . Suppose first that N is not a module, there exist $u, v \in N, x \in V(H') \setminus N$ adjacent to only u or v . Since N is not a maximal clique of H' , there exists $y \in V(H') \setminus N$ adjacent to u and v . Together with a vertex $w \in \bigcup_{i=1}^l P_i$ not affected by F , the vertex set $\{u, v, w, x, y\}$ induces in H a gem if x and y are adjacent and a dart else, leading to a contradiction. If N is a module and is not a critical clique, N is not a maximal clique module, thus there exist $u \in N$, a vertex v in the same module as u in H' and a vertex $w \in \bigcup_{i=1}^l P_i$ not affected by F such that $vw \notin E(H)$. Since N intersects two maximal cliques of H' there exist two non-adjacent vertices $x, y \in V(H')$ that are adjacent to both u and v . The vertex set $\{u, v, w, x, y\}$ induces a dart in H since w is only adjacent to u . It remains that if $r = 1$, N is a critical clique, a maximal clique or is included in exactly one maximal clique of H' .

Case (ii) $r > 1$ and $(\sum_{i=1}^l |P_i|) - \max_{1 \leq j \leq r} \{|Q_j|\} > k$: We claim that N is a clique in H . Suppose again for a contradiction that this is not the case, then there exist two vertices $x, y \in N$ such that $xy \notin E(H)$. For any pair of vertices $u_i \in Q_i, u_j \in Q_j, i \neq j$, the set $\{x, u_i, y, u_j\}$ induces a C_4 in H if neither u_j nor u_i is affected by F . It follows that the vertices of Q_i or Q_j must be affected by F . This implies that at most one Q_i is unaffected by F , and since $(\sum_{i=1}^l |P_i|) - \max_{1 \leq j \leq r} \{|Q_j|\} > k$ we have $|F| > k$, a contradiction. Hence N has to be a clique in H .

Next we show that N is a critical clique of H . Suppose that N is not a module in H , then there exist $x, y \in N$ and $z \in V(G) \setminus N$ adjacent to only one of the vertices x or y , say w.l.o.g. x . For any pair of vertices $u_i \in Q_i, u_j \in Q_j, i \neq j$, if neither u_i nor u_j is affected by F , then at least one of them is not adjacent to z and the set $\{x, y, u_i, u_j, z\}$ induces a dart if neither u_i nor u_j is adjacent to z or a gem if one of them is adjacent to z . This implies that at most one Q_i is unaffected by F , as before we have $|F| > k$, a contradiction. Hence N has to be a module in H . If N is not a critical clique of H , then it is strictly contained in some critical clique N' . A vertex $x \in N' \setminus N$ must have the same closed neighborhood than N in H . If x is not in some P_i or $N_{B_i}(P_i)$, then F must affect all vertices of $P_1 \cup \dots \cup P_l$, implying

$|F| > k$, a contradiction. If x is in some P_i or $N_{B_i}(P_i)$, then F must affect all vertices of every Q_j such that $P_i \not\subseteq Q_j$. Since $(\sum_{i=1}^l |P_i|) - \max_{1 \leq j \leq r} \{|Q_j|\} > k$, this implies $|F| > k$, a contradiction. It remains that N is a critical clique in H .

Finally, since N is a module in H' , if it is not a critical clique, there exist $u \in N$, a vertex v in the same critical clique as u in H' and a vertex $w \in \bigcup_{i=1}^l P_i$ not affected by F such that $vw \notin E(H)$. If N intersects at least two maximal cliques of H' there exist two non-adjacent vertices $x, y \in V(H')$ that are adjacent to both u and v . The vertex set $\{u, v, w, x, y\}$ induces a dart in H since w is only adjacent to u . It remains that N is a critical clique or intersects exactly one maximal clique of H' . \square

Rule 4.4 Let $(G = (V, E), k)$ be an instance of STRICTLY CHORDAL EDITING. Let B_1, \dots, B_l be disjoint 1-SC-branches of G with attachment points P_1, \dots, P_l which have the same neighborhood N in $G \setminus \bigcup_{i=1}^l V(B_i)$ and form a disjoint union of cliques Q_1, \dots, Q_r in $G[P_1 \cup \dots \cup P_l]$. Assume that $\sum_{i=1}^l |P_i| > 2k + 1$, then :

- If $r = 1$, remove the vertices $\bigcup_{i=1}^l V(B_i)$, add two adjacent cliques K and K' of size $k + 1$ with neighborhood N and a vertex u_K adjacent to every vertex of K .
- If $r > 1$ and $(\sum_{i=1}^l |P_i|) - \max_{1 \leq j \leq r} \{|Q_j|\} > k$, remove the vertices $\bigcup_{i=1}^l V(B_i)$ and add two non-adjacent cliques of size $k + 1$ with neighborhood N .

Lemma 20 Rule 4.4 is safe.

Proof: Let G' be the graph obtained after the application of Rule 4.4 on B_1, \dots, B_l , and S the new vertices introduced by this rule. Notice that the subgraph $G'_S = G'[S]$ is strictly chordal and form two 1-SC-branches that satisfy the conditions of Lemma 19. First, let F be a k -edition of G , $H = G \triangle F$ and $H_a = H \setminus \bigcup_{i=1}^l V(B_i)$. By Lemma 19 N is a critical clique, a maximal clique (unless $r > 1$) or intersects exactly one maximal clique of H_a . Therefore, by Lemma 4 and Observation 1 the graph $H' = (H_a, N) \otimes (G'_S, K \cup K')$ is strictly chordal and the edition F' such that $H' = G' \triangle F'$ is of size at most $|F| \leq k$.

Conversely, let F' be a k -edition of G' , $H' = G' \triangle F'$ and $H'_a = H' \setminus S$. Notice that the subgraph $G_b = G[\bigcup_{i=1}^l V(B_i)]$ is strictly chordal. By Lemma 19 N is a critical clique, a maximal clique (unless $r > 1$) or intersects exactly one maximal clique of H'_a . Let Q_1, \dots, Q_r the cliques of G_b adjacent to N , using arguments similar to the ones of Lemma 15, it is easy to see that each Q_i is critical clique, a maximal clique or intersects exactly one maximal clique of G_b . Therefore, by Lemma 4 and Observation 1 the graph $H = (H'_a, N) \otimes (G_b, Q_1 \cup \dots \cup Q_r)$ is strictly chordal and the edition F such that $H = G \triangle F$ is of size at most $|F'| \leq k$. \square

4.3 Reducing the 2-SC-branches

Let B be a 2-SC-branch of a graph G reduced by Rule 4.3, with attachment points P_1 and P_2 . We say that B is *clean* if B^R is connected, and that the *length* of a clean 2-SC-branch is the length of a shortest path between the two attachment points in $\mathcal{C}(B)$. We say that the *min-cut* of B is a set of edges $M \subseteq E(B)$ of minimum size such that P_1 and P_2 are not in the same connected component of $B - M$ and $mc(B)$ is the size of a min-cut of B . We can observe that a min-cut of B contains the edges between

a pair of consecutive critical cliques of a shortest path between P_1 and P_2 and the edges between one of these critical cliques and the critical cliques they have in their common neighborhood. The following observation will be useful to reduce 2-SC-branches.

Observation 2 *Let F be an optimal edition of G and $F_1 \subseteq F$. If F_2 is an optimal edition of the graph $G \Delta F_1$, then $F_1 \cup F_2$ is an optimal edition of G .*

Lemma 21 *Let $(G = (V, E), k)$ be a yes-instance of STRICTLY CHORDAL EDITING and B a clean 2-SC-branch of length at least $k + 3$ with attachment points P_1, P_2 . There exists an optimal edition F of G such that:*

- *If P_1 and P_2 are in the same connected component of $(G \Delta F) \setminus V(B^R)$, then F contains an edge-cut of B . This edge-cut is $(P_1 \times N_B(P_1))$ or $(P_2 \times N_B(P_2))$ or a min-cut of B .*
- *In each case, the other vertices of B affected by F are included in $P_1 \cup N_B(P_1) \cup P_2 \cup N_B(P_2)$.*
- *In $G \Delta F$ the vertices of $N_B(P_1)$ (resp. $N_B(P_2)$) are all adjacent to the same vertices of $V(G) \setminus V(B^R)$.*

Proof: Let F be an optimal edition of G , $H = G \Delta F$. Let C_1 (resp. C_2) be the critical clique of H which contains P_1 (resp. P_2). Let $H' = H \setminus V(B^R)$, $C'_1 = C_1 \setminus V(B^R)$ and $C'_2 = C_2 \setminus V(B^R)$.

We first consider the case where P_1 and P_2 are in different connected component of H' . Let H'_1 and H'_2 be the two connected components of H' containing P_1 and P_2 , respectively, and H'_3 the remaining of H' . For $i \in \{1, 2\}$, Lemma 15 implies that $N_B(P_i)$ is a clique in G since B^R is connected, and $N_B(P_i)$ is a critical clique, a maximal clique or intersects exactly one maximal clique of B^R . By Lemma 16, C'_i is a critical clique or intersects exactly one maximal clique of the connected component H'_i .

By Lemma 4, the graph H^* corresponding to the disjoint union of

$$((B^R, N_B(P_1)) \otimes (H'_1, C'_1), N_B(P_2)) \otimes (H'_2, C'_2)$$

and H'_3 is strictly chordal (see Figure 8) and the edition F^* such that $H^* = G \Delta F^*$ verifies the desired properties. Since $|F^*| \leq |F|$ by construction, we conclude that F^* is optimal.

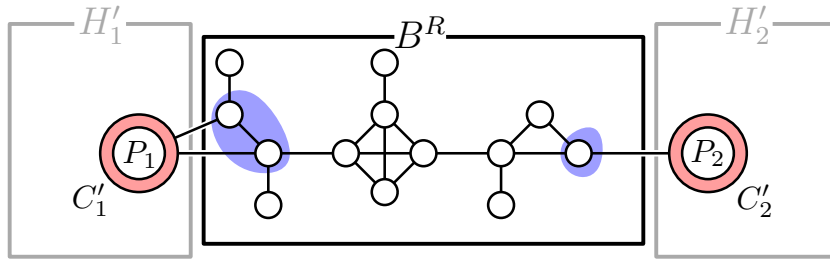

Fig. 8: Illustration of the case where $B \Delta F$ is connected in Lemma 21.

Assume now that P_1 and P_2 are in the same connected component in H' and let $\pi_{H'}$ denote a shortest path between $c_1 \in P_1$ and $c_2 \in P_2$. Note that $\pi_{H'}$ may be of length 1 if c_1 and c_2 are adjacent in H' . We first consider the case where there is a path $\pi_B = \{c_1 = u_1, u_2, \dots, u_r = c_2\}$ (not necessarily induced)

from c_1 to c_2 in B that still exists in $B\Delta F$. Observe that such this path π_B is of length at least $k+3$ since B is of length at least $k+3$. There is no edge between the two paths in G , so $H[V(\pi_B) \cup V(\pi_H)]$ admits at least one induced cycle of length at least 4, which is a contradiction. We conclude that if P_1 and P_2 are in the same connected component of $H \setminus V(B^R)$, then F contains an edge-cut of B . Else there would be a path π_B from c_1 to c_2 in B that still exists in $B\Delta F$.

Hence we can assume that F contains an edge-cut of B . First, if $F_1 = (P_1 \times N_B(P_1)) \subseteq F$, consider the graph $G_1 = G\Delta F_1$. Observe that $B_1 = B \setminus P_1$ is a 1-SC-branch of G_1 with attachment point P_2 . By Lemma 17 there exists an optimal edition F_2 of G_1 where the vertices of B_1 affected by F_2 are in $P_2 \cup N_{B_1}(P_2)$. By Observation 2, $F_1 \cup F_2$ is an optimal edition and it verifies the desired properties. The same arguments can be used if $(P_2 \times N_B(P_2)) \subseteq F$.

Now, if F contains neither $(P_1 \times N_B(P_1))$ nor $(P_2 \times N_B(P_2))$, let $F_1 = F \cap (V(B^R) \times V(B^R))$. There are two components in $B\Delta F_1$, say B_1 the one containing P_1 and B_2 one containing P_2 . These connected components are 1-SC-branches of $G_1 = G\Delta F_1$ with attachment points P_1 and P_2 . As before Lemma 17 applies on the 1-SC-branches B_1 and B_2 , thus there is an optimal edition F_2 of G_1 where the only vertices of B_1 and B_2 affected are included in $P_1 \cup N_B(P_1)$ and $P_2 \cup N_B(P_2)$. If F_1 is a min-cut of B , the edition $F_1 \cup F_2$ is an optimal edition of G that verifies the desired properties, else, replacing F_1 by a min-cut of B results in a smaller edition that verifies the properties. \square

Rule 4.5 Let $(G = (V, E), k)$ be an instance of STRICTLY CHORDAL EDITING and B a clean 2-SC-branch of G of length at least $k+3$ with attachment points P_1, P_2 . Remove the vertices $V(B^R)$, and add the following path of $k+2$ cliques:

$$K_{\min\{|N_B(P_1)|, k+1\}} - K_{k+1} - K_1 - K_{|mc(B)|} - K_{k+1}^1 - \dots - K_{k+1}^{k-3} - K_{\min\{|N_B(P_2)|, k+1\}}$$

where K_n is the clique of size n and $K_{\min\{|N_B(P_1)|, k+1\}}$ (resp. $K_{\min\{|N_B(P_2)|, k+1\}}$) is adjacent to P_1 (resp. P_2).

Lemma 22 Rule 4.5 is safe.

Proof: Let G' the graph obtained from an application of Rule 4.5 on the 2-SC-branch B of graph G with attachment points P_1, P_2 and S the vertices introduced by this rule. Observe that $B' = G'[S \cup P_1 \cup P_2]$ is a clean 2-SC-branch of G' of length $k+3$ and $mc(B') = \min\{k+1, mc(B)\}$.

Let F be a k -edition of G that satisfies Lemma 21 and $H = G\Delta F$. Observe that if $mc(B) \geq k+1$, then F does not affect vertices of $V(B)$ other than $P_1 \cup N_B(P_1) \cup P_2 \cup N_B(P_2)$ and if $|N_B(P_i)| > k, i \in \{1, 2\}$ F does not affect the vertices of $N_B(P_i)$. Let C_i be the critical clique of H which contains P_i and $C'_i = C_i \setminus B^R$. By Lemma 16, C'_i is a critical clique or intersects exactly one maximal clique of $H_a = H \setminus V(B^R)$. Observe moreover that $N_{B'}(P_i)$ is critical clique of B'^R .

We now construct a k -edition F' of G' . We consider first the tree cases where F contains an edge-cut of B . If w.l.o.g. $(P_1 \times N_B(P_1)) \subseteq F$ and $(P_2 \times N_B(P_2)) \cap F = \emptyset$. Observe that $(C'_1 \times N_{B'}(P_1)) \subseteq F$ since C_1 is a critical clique of H . By Lemma 4 the graph $H' = ((H_a, C'_1) \otimes (B'^R, N_{B'}(P_1)))$ is strictly chordal. If $(P_1 \times N_B(P_1)) \subseteq F$ and $(P_2 \times N_B(P_2)) \subseteq F$ then H' the graph resulting of the disjoint union of H_a and B'^R is strictly chordal. If F contains a min-cut of B , then consider $B'_i, i \in \{1, 2\}$ the connected component of $B'\Delta F'_1$ containing P_i , where F'_1 is a min-cut of B' . By Lemma 4 the graph $H' = ((H_a, C'_1) \otimes (B'_1, N_{B'}(P_1)), C'_2) \otimes (B'_2, N_{B'}(P_2))$ is strictly chordal.

Otherwise, P_1 and P_2 are not in the same connected component of H_a by Lemma 21. Let H_1 and H_2 be these components and H_3 be the remaining of H_a . By Lemma 4, the graph H' corresponding to the disjoint union of $((B'^R, N_{B'}(P_1)) \otimes (H_1, C'_1), N_{B'}(P_2)) \otimes (H_2, C'_2)$ and H_3 is strictly chordal.

In any of these four cases, let F' be the edition such that $H' = G' \triangle F'$, by construction $|F'| \leq |F|$, therefore F' is a k -edition of G' .

The other way is symmetrical. □

4.4 Bounding the size of the kernel

We first state that reduction rules involving SC-branches can be applied in polynomial time.

Lemma 23 *Given an instance $(G = (V, E), k)$ of STRICTLY CHORDAL EDITING, Rules 4.3 to 4.5 can be applied in polynomial time.*

Proof: We rely on the linear time computation of the critical clique graph $\mathcal{C}(G)$ of G (38) and the linear time recognition of block graphs. We show that we can enumerate all 1-SC-branches and 2-SC-branches in polynomial time. Since an attachment point is by definition a critical clique of G , one can detect 1-SC-branches by removing a critical clique of $\mathcal{C}(G)$ and looking among the remaining connected components those that induce a connected block graph together with P (in $\mathcal{C}(G)$). Considering a maximal set of such components together with P gives a 1-SC-branch B . We proceed similarly to detect clean 2-SC-branches by removing a pair of critical cliques P_1, P_2 of $\mathcal{C}(G)$, and looking among the remaining connected components those that induce a connected block graph (in $\mathcal{C}(G)$) together with P_1 and P_2 . Such components together with P_1 and P_2 gives a clean 2-SC-branch B . Since there is $O(|V(G)|)$ critical cliques, the result follows. □

Theorem 2 STRICTLY CHORDAL EDITING admits a kernel with $O(k^4)$ vertices.

Proof: Let $(G = (V, E), k)$ be a reduced yes-instance of STRICTLY CHORDAL EDITING, F a k -edition of G and $H = G \triangle F$. We assume that G is connected, the following arguments can be easily adapted if this is not the case by summing over all connected components of G . The graph H is strictly chordal, thus the graph $\mathcal{C}(H)$ is a block graph. We first show that $\mathcal{C}(H)$ has $O(k^3)$ vertices. We say that a critical clique of $\mathcal{C}(H)$ is affected if it contains a vertex affected by F . Let A be the set of affected critical cliques of $\mathcal{C}(H)$. Since $|F| \leq k$, we have $|A| \leq 2k$. Let T_A be the minimal connected induced subgraph of H that spans all critical cliques of A , and $d(T_A)$ the set of vertices of degree at least 3 in T_A (see Figure 9). Recall that such a subgraph is unique by Lemma 5.

We first show that $|V(T_A)|$ contains $O(k^2)$ critical cliques. By Lemma 5, $|d(T_A) \setminus A| \leq 3 \cdot |A| \leq 6k$. The connected components of the graph $T_A \setminus (A \cup d(T_A))$ are paths since every vertex is of degree at most 2 and by Lemma 5 there are at most $4k$ such paths. Let R be one of these paths, it is composed of unaffected critical cliques, thus there exists a clean 2-SC-branch B of G that contains R . Moreover, the endpoints of R are the attachment points of B , hence B have been reduced by Rule 4.5. Thus R is of length at most $k + 3$. It remains that $|V(T_A)| \leq 2k + 6k + (k + 3) \cdot 4k = O(k^2)$.

We will now show that $\mathcal{C}(H) \setminus V(T_A)$ contains $O(k^3)$ critical cliques. First observe that each connected component of $\mathcal{C}(H) \setminus V(T_A)$ is adjacent to some vertices of T_A since the graph is reduced by Rule 4.1. Since $\mathcal{C}(H)$ is a block graph, connected components of $\mathcal{C}(H) \setminus V(T_A)$ are adjacent to either a critical clique of T_A or a maximal clique of T_A (else, there would be a diamond in $\mathcal{C}(H)$). We claim that there

CHORDAL EDITING, if $|V(G)| > g(k)$ for a function $g(k) = O(k^4)$ (defined by this proof) we can safely conclude that (G, k) is a no-instance and return a trivial no-instance of constant size, thus proving the size of our kernel. To finish the proof, we claim that a reduced instance can be computed in polynomial time. Indeed, Lemma 14 states that it is possible to reduce exhaustively a graph under Rules 4.1 and 4.2 in linear time. Once this is done, it remains to apply exhaustively Rules 4.3 to 4.5 which is ensured by Lemma 23. \square

5 Kernels for the completion and deletion variants

In this section we present kernels for STRICTLY CHORDAL COMPLETION and STRICTLY CHORDAL DELETION. It is clear that Rules 4.1 and 4.2 are also safe for these variants of the problem. We can also observe that Rules 4.3 to 4.5 are safe for the completion and deletion variants since they are a special case of the edition. However, we can use more efficient rules to manage the 2-SC-branches and bound their length to a constant number of critical cliques. This is due to only allowing edge addition or edge deletion. In the case of STRICTLY CHORDAL COMPLETION, one can observe that for a graph G , it is sufficient to consider the clean 2-SC-branches B of length 3 which have attachment points that belong to different connected components of $G \setminus V(B^R)$ since a SC-branch remains connected in any completion of G . The next lemma follows from this observation and its proof is contained in the proof of Lemma 21. From this lemma we can devise an improved rule for the completion variant.

Lemma 24 *Let $G = (V, E)$ be graph and B a clean 2-SC-branch of length at least 3 with attachment points P_1, P_2 that are in different connected components of $G \setminus V(B^R)$. There exists an optimal completion F of G such that:*

- *The set of vertices of B affected by F is included in $P_1 \cup N_B(P_1) \cup P_2 \cup N_B(P_2)$,*
- *In $H = G + F$, the vertices of $N_B(P_1)$ (resp. $N_B(P_2)$) are all adjacent to the same vertices of $V(G) \setminus V(B^R)$.*

Rule 5.1 *Let $(G = (V, E), k)$ be an instance of STRICTLY CHORDAL COMPLETION and B a clean 2-SC-branch of G of length at least 3 with attachment points P_1, P_2 that are in different connected components of $G \setminus V(B^R)$. Remove the vertices $V(B^R)$ and add two new cliques K_1 and K_2 of size respectively $\min\{|N_B(P_1)|, k + 1\}$ and $\min\{|N_B(P_2)|, k + 1\}$ with edges $(P_1 \times K_1), (K_1 \times K_2), (K_2 \times P_2)$.*

In the case of STRICTLY CHORDAL DELETION, we can observe that if the two attachment points of B , a 2-SC-branch of length at least 3, are in the same connected component of $G \setminus V(B^R)$, then either B is disconnected or the attachment points are not in the same connected component of $(G - F) \setminus V(B^R)$ for any deletion F of G . Indeed, if this was not the case, we could find an induced cycle of length at least 4 since edge additions are not allowed. The next lemma follows from this observation and its proof is contained in the proof of Lemma 21. As previously we can devise an improved rule from this lemma for the deletion variant.

Lemma 25 *Let $G = (V, E)$ be graph and B a clean 2-SC-branch of length at least 3 with attachment points P_1, P_2 . There exists an optimal deletion F of G such that:*

- *If P_1 and P_2 are in the same connected component of $(G \triangle F) \setminus V(B^R)$, then F contains an edge-cut of B . This edge-cut is $(P_1 \times N_B(P_1))$ or $(P_2 \times N_B(P_2))$ or a min-cut of B .*

- In each case, the other vertices of B affected by F are included in $P_1 \cup N_B(P_1) \cup P_2 \cup N_B(P_2)$,
- In $G - F$ the vertices of $N_B(P_1)$ (resp. $N_B(P_2)$) are all adjacent to the same vertices of $V(G) \setminus V(B^R)$.

Rule 5.2 Let $(G = (V, E), k)$ be an instance of STRICTLY CHORDAL DELETION and B a clean 2-SC-branch of G of length at least 3 with attachment points P_1, P_2 . Remove the vertices $V(B^R)$, and add the following path of 5 cliques:

$$K_{\min\{|N_B(P_1)|, k+1\}} - K_{k+1} - K_1 - K_{mc(B)} - K_{\min\{|N_B(P_2)|, k+1\}}$$

where K_n is the clique of size n and $K_{\min\{|N_B(P_1)|, k+1\}}$ (resp. $K_{\min\{|N_B(P_2)|, k+1\}}$) is adjacent to P_1 (resp. P_2).

Lemma 26 Rules 5.1 and 5.2 are safe and can be applied in polynomial time.

With these new rules, we can observe that in the proof of Theorem 2, the connected minimal induced subgraph T that spans all the affected critical cliques contains $O(k)$ critical cliques. Indeed, the quadratic number of critical cliques in T resulted from the paths in T that contained a linear number of critical cliques. However, with Rules 5.1 and 5.2, these paths contain $O(1)$ critical cliques, implying that T contains $O(k)$ critical cliques. With this observation, it follows that a reduced graph contains $O(k^2)$ critical cliques and thus contains $O(k^3)$ vertices.

Theorem 3 STRICTLY CHORDAL COMPLETION and STRICTLY CHORDAL DELETION admit kernels with $O(k^3)$ vertices.

6 Conclusion

We presented polynomial kernels for the edition and deletion variants of block graph edge modification problems and the three variants of strictly chordal edge modification problems. Our conviction is that the approach based on decompositions of the target class, combined with the ability of reducing the size of the bags of the decomposition and of limiting the number of affected bags to $O(k)$ is a promising starting point for edge modification problems, especially into subclasses of chordal graphs. The technique has been employed especially for classes that admit a tree-like decompositions with disjoint bags (e.g., 3-leaf power (3), trivially perfect graphs (22, 20) and \mathcal{M} -free graphs (32)), also for other types of tree-like decompositions with non-disjoint bags (e.g., ptolemaic graphs (13)). We generalize it here to strictly chordal graphs, that have a decomposition into disjoint bags as nodes of a block graph.

The difficulty is that, at this stage, each class requires ad-hoc arguments and reduction rules, based on its specific decomposition. An ambitious goal would be to obtain a generic algorithm for edge modification problems into any class of chordal graphs, plus a finite set of obstructions, as conjectured by Bessy and Perez (4) for completion problems. As an intermediate step, we ask whether 4-leaf power completion, deletion and editing problems admit a polynomial kernel.

On another level, it would be really interesting to obtain polynomial kernelization lower bounds for edge-modification problems. To the best of our knowledge, such bounds are only known for vertex-deletion problems; more precisely, any such problem where the target class is closed under subgraphs does not admit a kernel with $O(k^{2-\epsilon})$ edges unless $coNP \subseteq NP/poly$, see (15).

References

- [1] Hans-Jürgen Bandelt and Henry Martyn Mulder. Distance-hereditary graphs. *Journal of Combinatorial Theory, Series B*, 41(2):182–208, 1986. doi:10.1016/0095-8956(86)90043-2.
- [2] Gabriel Bathie, Nicolas Bousquet, Yixin Cao, Yuping Ke, and Théo Pierron. (Sub) linear kernels for edge modification problems toward structured graph classes. *Algorithmica*, 84(11):3338–3364, 2022. doi:10.1007/s00453-022-00969-1.
- [3] Stéphane Bessy, Christophe Paul, and Anthony Perez. Polynomial kernels for 3-leaf power graph modification problems. *Discrete Applied Mathematics*, 158(16):1732–1744, 2010. doi:10.1016/j.dam.2010.07.002.
- [4] Stéphane Bessy and Anthony Perez. Polynomial kernels for proper interval completion and related problems. *Information and Computation*, 231:89–108, 2013. doi:10.1016/j.ic.2013.08.006.
- [5] Hans L. Bodlaender, Rodney G. Downey, Michael R. Fellows, and Danny Hermelin. On problems without polynomial kernels. *Journal of Computer and System Sciences*, 75(8):423–434, 2009. doi:10.1016/J.JCSS.2009.04.001.
- [6] Hans L. Bodlaender, Bart M. P. Jansen, and Stefan Kratsch. Kernelization lower bounds by cross-composition. *SIAM Journal on Discrete Mathematics*, 28(1):277–305, 2014. doi:10.1137/120880240.
- [7] Hans L. Bodlaender, Stéphan Thomassé, and Anders Yeo. Kernel bounds for disjoint cycles and disjoint paths. *Theoretical Computer Science*, 412(35):4570–4578, 2011. doi:10.1016/J.TCS.2011.04.039.
- [8] Andreas Brandstädt, Van Bang Le, and Jeremy P. Spinrad. *Graph Classes: A Survey*. SIAM, 1999. doi:10.1137/1.9780898719796.
- [9] Leizhen Cai. Fixed-parameter tractability of graph modification problems for hereditary properties. *Information Processing Letters*, 58(4):171–176, 1996. doi:10.1016/0020-0190(96)00050-6.
- [10] Leizhen Cai and Yufei Cai. Incompressibility of H -free edge modification problems. *Algorithmica*, 71(3):731–757, 2015. doi:10.1007/s00453-014-9937-x.
- [11] Yixin Cao and Dániel Marx. Chordal editing is fixed-parameter tractable. *Algorithmica*, 75(1):118–137, 2016. doi:10.1007/s00453-015-0014-x.
- [12] Christophe Crespelle, Pål Grønås Drange, Fedor V. Fomin, and Petr Golovach. A survey of parameterized algorithms and the complexity of edge modification. *Computer Science Review*, 48:100556, 2023. doi:10.1016/j.cosrev.2023.100556.
- [13] Christophe Crespelle, Benjamin Gras, and Anthony Perez. Completion to chordal distance-hereditary graphs: a quartic vertex-kernel. In *Proceedings of the 47th International Workshop on Graph-Theoretic Concepts in Computer Science, WG*, pages 156–168, 2021. doi:10.1007/978-3-030-86838-3_12.

- [14] Marek Cygan, Fedor V. Fomin, Lukasz Kowalik, Daniel Lokshtanov, Dániel Marx, Marcin Pilipczuk, Michal Pilipczuk, and Saket Saurabh. *Parameterized Algorithms*. Springer, 2015. doi:10.1007/978-3-319-21275-3.
- [15] Holger Dell and Dieter van Melkebeek. Satisfiability allows no nontrivial sparsification unless the polynomial-time hierarchy collapses. *J. ACM*, 61(4):23:1–23:27, 2014. doi:10.1145/2629620.
- [16] Michael Dom, Jiong Guo, Falk Hüffner, and Rolf Niedermeier. Error compensation in leaf power problems. *Algorithmica*, 44(4):363–381, 2006. doi:10.1007/s00453-005-1180-z.
- [17] Michael Dom, Jiong Guo, Falk Hüffner, and Rolf Niedermeier. Closest 4-leaf power is fixed-parameter tractable. *Discrete Applied Mathematics*, 156(18):3345–3361, 2008. doi:10.1016/j.dam.2008.01.007.
- [18] Pål Grønås Drange, Markus Fanebust Dregi, Daniel Lokshtanov, and Blair D. Sullivan. On the threshold of intractability. *Journal of Computer and System Sciences*, 124:1–25, 2022. doi:10.1016/j.jcss.2021.09.003.
- [19] Pål Grønås Drange and Michal Pilipczuk. A polynomial kernel for trivially perfect editing. *Algorithmica*, 80(12):3481–3524, 2018. doi:10.1007/s00453-017-0401-6.
- [20] Maël Dumas and Anthony Perez. An improved kernelization algorithm for trivially perfect editing. In *Proceedings of the 18th International Symposium on Parameterized and Exact Computation, IPEC*, pages 15:1–15:17, 2023. doi:10.4230/LIPICS.IPEC.2023.15.
- [21] Maël Dumas, Anthony Perez, and Ioan Todinca. Polynomial kernels for strictly chordal edge modification problems. In *Proceedings of the 16th International Symposium on Parameterized and Exact Computation, IPEC*, pages 17:1–17:16, 2021. doi:10.4230/LIPICS.IPEC.2021.17.
- [22] Maël Dumas, Anthony Perez, and Ioan Todinca. A cubic vertex-kernel for trivially perfect editing. *Algorithmica*, 85(4):1091–1110, 2023. doi:10.1007/s00453-022-01070-3.
- [23] Philippe Galinier, Michel Habib, and Christophe Paul. Chordal graphs and their clique graphs. In *Proceedings of the 21st International Workshop on Graph-Theoretic Concepts in Computer Science, WG*, pages 358–371, 1995. doi:10.1007/3-540-60618-1_88.
- [24] Martin Charles Golumbic and Uri N. Peled. Block duplicate graphs and a hierarchy of chordal graphs. *Discrete applied mathematics*, 124(1-3):67–71, 2002. doi:10.1016/S0166-218X(01)00330-4.
- [25] Sylvain Guillemot, Frédéric Havet, Christophe Paul, and Anthony Perez. On the (non-)existence of polynomial kernels for P_t -free edge modification problems. *Algorithmica*, 65(4):900–926, 2013. doi:10.1007/s00453-012-9619-5.
- [26] Jiong Guo. Problem kernels for NP-complete edge deletion problems: Split and related graphs. In *Proceedings of the 18th International Symposium on Algorithms and Computation, ISAAC*, pages 915–926, 2007. doi:10.1007/978-3-540-77120-3_79.

- [27] Peter L. Hammer and Bruno Simeone. The splittance of a graph. *Combinatorica*, 1:275–284, 1981.
- [28] John E. Hopcroft and Robert Endre Tarjan. Algorithm 447: efficient algorithms for graph manipulation. *Communications of the ACM*, 16(6):372–378, 1973. doi:10.1145/362248.362272.
- [29] Haim Kaplan, Ron Shamir, and Robert E. Tarjan. Tractability of parameterized completion problems on chordal, strongly chordal, and proper interval graphs. *SIAM Journal on Computing*, 28(5):1906–1922, 1999. doi:10.1137/S0097539796303044.
- [30] William Kennedy. Strictly chordal graphs and phylogenetic roots. Master’s thesis, University of Alberta, 2005. doi:10.7939/r3-gzxq-vn59.
- [31] William Kennedy, Guohui Lin, and Guiying Yan. Strictly chordal graphs are leaf powers. *Journal of Discrete Algorithms*, 4(4):511–525, 2006. doi:10.1016/j.jda.2005.06.005.
- [32] Christian Komusiewicz and Johannes Uhlmann. A cubic-vertex kernel for flip consensus tree. *Algorithmica*, 68(1):81–108, 2014. doi:10.1007/S00453-012-9663-1.
- [33] Stefan Kratsch and Magnus Wahlström. Two edge modification problems without polynomial kernels. *Discrete Optimization*, 10(3):193–199, 2013. doi:10.1016/J.DISOPT.2013.02.001.
- [34] Mirko Krivánek and Jaroslav Morávek. NP-hard problems in hierarchical-tree clustering. *Acta Informatica*, 23(3):311–323, 1986. doi:10.1007/BF00289116.
- [35] Lilian Markenzon and Christina Fraga Esteves Maciel Waga. New results on ptolemaic graphs. *Discrete Applied Mathematics*, 196:135–140, 2015. doi:10.1016/J.DAM.2014.03.024.
- [36] Assaf Natanzon. *Complexity and approximation of some graph modification problems*. University of Tel-Aviv, 1999.
- [37] Assaf Natanzon, Ron Shamir, and Roded Sharan. A polynomial approximation algorithm for the minimum fill-in problem. *SIAM Journal on Computing*, 30(4):1067–1079, 2000. doi:10.1137/S0097539798336073.
- [38] Fábio Protti, Maise Dantas Da Silva, and Jayme Luiz Szwarcfiter. Applying modular decomposition to parameterized cluster editing problems. *Theory of Computing Systems*, 44(1):91–104, 2009. doi:10.1007/S00224-007-9032-7.
- [39] Ron Shamir, Roded Sharan, and Dekel Tsur. Cluster graph modification problems. *Discrete Applied Mathematics*, 144(1-2):173–182, 2004. doi:10.1016/J.DAM.2004.01.007.