EVALUATION OF A SPLIT FLOW MODEL FOR THE EMERGENCY DEPARTMENT

PREPRINT

Juan Camilo David Gómez

Department of Industrial and Systems Engineering
University of Wisconsin-Madison
Madison, WI
davidgomez@wisc.edu

Amy Cochran

Department of Population Health Sciences
and Department of Mathematics
University of Wisconsin-Madison
Madison, WI
cochran4@wisc.edu

Brian Patterson

BerbeeWalsh Department of Emergency Medicine
University of Wisconsin-Madison
Madison, WI
bpatter@medicine.wisc.edu

Gabriel Zayas-Cabán

Department of Industrial and Systems Engineering
University of Wisconsin-Madison
Madison, WI
zayascaban@wisc.edu

February 3, 2022

ABSTRACT

Split flow models, in which a physician rather than a nurse performs triage, are increasingly being used in hospital emergency departments (EDs) to improve patient flow. Before deciding whether such interventions should be adopted, it is important to understand how split flows causally impact patient flow and outcomes. We employ causal inference methodology to estimate average causal effects of a split flow model on time to be roomed, time to disposition after being roomed, admission decisions, and ED revisits at a large tertiary teaching hospital that uses a split flow model during certain hours each day. We propose a regression discontinuity (RD) design to identify average causal effects, which we formalize with causal diagrams. Using electronic health records data ($n = 21,570$), we estimate that split flow increases average time to be roomed by about 4.6 minutes (95% CI: [2.9, 6.2] minutes) but decreases average time to disposition by 14.4 minutes (95% CI: [4.1, 24.7] minutes), leading to an overall reduction in length of stay. Split flow is also found to decrease admission rates by 5.9% (95% CI: [2.3%, 9.4%]) but not at the expense of a significant change in revisit rates. Lastly, we find that the split flow model is especially effective at reducing length of stay during low congestion levels, which mediation analysis partly attributes to early task initiation by the physician assigned to triage.

Keywords Split Flow Model; Causal Inference; Emergency Department; Patient Discharge; Electronic Health Records

1 Introduction

Americans increasingly receive acute, unscheduled care in the Emergency Department (ED) (Pitts et al. 2010). ED crowding is an unfortunate result of rising practice intensity and inpatient boarding (Pitts et al. 2012, Fatovich et al. 2005, Olshaker and Rathlev 2006, Derlet and Richards 2008). Crowding leads to a number of deleterious effects on patient care including treatment delays, increasing patient mortality, and increased admission rates (Sills et al. 2011, Liu et al. 2003, McCarthy et al. 2009, de Araujo et al. 2013, Richardson et al. 2006, Sprivulis et al. 2006, McCusker et al. 2014, Gorski et al. 2017). A large number of interventions have been proposed to improve patient flow and thus alleviate crowding, and otherwise improve operational metrics (De Freitas et al. 2018).

One suite of interventions that has gained popularity is the creation of “split flow” models, in which a Physician or Advanced Practice Provider (APP), rather than a nurse, is stationed at patient intake and briefly sees all walk-in patients. This provider initiates the care of all patients by placing lab, imaging, and medication orders. The provider then stratifies patients, keeping those who do not require a traditional ED bed in a fast track or similar area and moving the rest to a queue for a traditional bed (Wiler et al. 2016). Therefore, a split flow model taps into two operational strategies for speeding up care that have been explored by the operations research (OR) and management science (MS) community: (i) physician-triage, whereby an APP initiates tasks that are normally handled later by providers downstream, and (ii) fast-tracking, whereby an APP identifies patients of low acuity and complexity to treat quickly and with fewer resources (Batt and Terwiesch 2017, Freeman et al. 2017, Russ et al. 2010). Efforts to evaluate split flow models have focused on measuring their association with improvement in operational metrics including flow and length of stay, as well as quality and safety metrics (Konrad et al. 2013, Wiler et al. 2016, Garrett et al. 2018, Pierce and Gormley 2016, Arya et al. 2013, Wallingford Jr et al. 2018, Patterson et al. 2020). Yet, these associations, while suggestive, do not definitely demonstrate that the split flow model had a direct, or *causal*, effect on outcomes. Moreover, these pathways may be less effective in reducing patient flow in less crowded EDs and may have adverse consequences downstream from the ED.

Causal effects of split flow models are difficult to measure, since patients were not randomly assigned to split flow model vs. traditional nurse-led triage. With only observational data, average outcomes may be influenced by confounding variables, i.e. factors that influence intervention groups and outcomes. Confounding can lead to spurious associations between interventions and outcomes that are misattributed to the intervention rather than underlying differences in intervention groups. For example, if younger patients are both quicker to treat and more likely to be assigned a split flow model than their older counterparts, then a split flow model may have faster average time to disposition after being roomed than a traditional patient flow model without directly impacting time to disposition. Causal inference methods address this limitation by using conceptual knowledge of system of interest to adjust for possible differences in intervention groups. Examples include direct standardization, which estimates effects within sub-populations, and inverse probability weighting, which estimates effects after re-weighting observations.

The present study seeks to use causal inference methods to estimate average causal effects of a split flow model on time to be roomed, time to disposition decision after being roomed, admission decisions, and ED revisits. We use electronic health records (EHR) data on patient visits ($n = 21,570$) to the ED at a large tertiary teaching hospital. We hypothesize the following:

1. A split flow model reduces the average time from patient arrival to admission decision.
2. A split flow model has negligible consequences to admission or revisit rates.
3. Faster treatment from a split flow model is mediated by earlier physician orders and by changes in how quickly patients are moved to a bed or vertical patient area.
4. A split flow model is less effective at reducing average time from arrival to admission decision when the ED is busy.

In short, our goal is to evaluate the *causal* impact of the split flow model (as opposed to the more traditional nurse-led triage) on *both* operational outcomes (i.e., time to be roomed, time to disposition decision after being roomed) and

patient outcomes (i.e., admission rates, ED revisits). We contribute a causal inference framework that adjusts for measured and unmeasured confounding to evaluate average treatment effects of split flow model on patient flow and patient outcomes.

At the study hospital, the split flow model only operates during certain time periods (i.e., from noon to 9PM) each day. However, patients that arrive to be triaged during operational hours of the split flow model could be different than patients that arrive at other times with respect to age, gender, or unmeasured patient severity and complexity. To overcome this issue, we implement an identification approach for estimating the causal impact of the split flow models on patient outcomes. This approach relies on a regression discontinuity (RD) design (Imbens and Lemieux 2008, Lee and Lemieux 2010), which we formalize in a causal diagram. Special consideration is needed to account for an intervention (i.e. split flow model) that is implemented over a specific period of time each day of the week, since ED variables tend to exhibit temporal correlation (Whitt and Zhang 2019). We thus propose placing a sharp RD design within a linear mixed effects regression model that includes day of arrival as a random effect. We then estimate causal effects using this approach and then compare results.

The remainder of this paper is organized as follows. First, selected studies from the literature are discussed in Section 2. The contributions of this paper relative to related topical areas within the literature are highlighted. Next, in Section 3, we formally define a causal framework for evaluating a split flow model. In Section 4, we use this causal framework to present strategies based on a RD method for estimating average causal effects. Upon applying these methods to EHR from a large tertiary hospital, results are presented in Section 5. Implications and concluding remarks are given in Section 6.

2 Literature Review

We position our work on split flow models within several areas of the literature. To motivate a split flow model and identify potential reasons why this model may improve patient flow, we consider work in the OR/MS community that investigate strategies involving an APP for improving ED patient flow. We then consider simulation and queueing approaches of split flow models, since the present work should inform what parameters are realistic for these approaches. Next, we consider work in the clinical community that uses observational data to estimate the impact of having an APP on patient outcomes, since we will similarly take an empirical approach. Last, we discuss causal inference methods, with a focus on RD design, to motivate our approach to estimating the direct impact of split flow models on outcomes.

2.1 Operational strategies to improve ED patient flow

Optimizing patient flow in the ED has generated great interest from the OR/MS community, given the difficulty EDs face across the US to address overcrowding and long waiting times (Saghafian et al. 2015). With constraints on resources in the ED, these efforts focus on how one might reorganize these limited resources for diagnosing, monitoring, and treating patients. One such reorganization is *physician-triage*: the nurse at triage is replaced with a provider who would have typically seen the patient downstream (Russ et al. 2010, Partovi et al. 2001, Traub et al. 2016). Physician-triage may improve patient flow by initiating tasks, such as diagnostic labs and images, earlier in an ED visit (Batt and Terwiesch 2017). This may allow providers to wait less for results from these tests they need to decide upon suitable treatment and whether to admit the patient. Another reason physician-triage may improve patient flow is providing a more precise assessment of patient needs or patient complexity (Saghafian et al. 2014, 2018). Physician-triage may be thought of as a form of gatekeeping (Freeman et al. 2017, 2020), where one provider determines who receives additional services, i.e. acts as a “gatekeeper” of additional services.

Another reorganization strategy is *patient streaming*: where patients are streamed into different physical locations in the ED based on their needs (Saghafian et al. 2012). Here, the idea is to more optimally match resources to patient needs, so that patients do not receive unnecessary resources that could have gone to elsewhere. Fast-tracking is one example of patient streaming, which specifically targets low-needs patients who do not require an ED bed to be treated (Considine et al. 2008).

A split flow model leverages both reorganization strategies (i.e. physician-triage and fast-tracking) for reducing waiting times. This work seeks to measure the direct contribution of this combined strategy to patient outcomes and explore the degree to which any direct effect might be mediated by early task initiation or fast-tracking. Furthermore, given that providers can adapt to the working context in the ED even without the reorganization (Batt and Terwiesch 2017, Gorski et al. 2017), it is important to understand how the effectiveness of a split-flow model might change with increasing workload and overall congestion.

2.2 Stylized split flow models

With a growing number of EDs adapting split flow models, the OR and MS community have used simulation and queueing models to explore the impact of split flow models on patient flow and costs (c.f., Konrad et al. (2013), Zayas-Cabán et al. (2016), Zayas-Caban et al. (2019), Kamali et al. (2018) and references therein). For example, Zayas-Cabán et al. (2016) and Zayas-Caban et al. (2019) studied how providers should prioritize their work in a split flow model to balance initial delays for care at triage with the need to discharge patients in a timely fashion. Triage and treatment were modeled as a two-stage tandem queue. Allocation policies were analyzed using continuous-time Markov decision processes (CTMDPs) (Zayas-Cabán et al. 2016) and simulation (Zayas-Caban et al. 2019). Kamali et al. (2018) studied when a physician should lead triage over a nurse in an ED using a fluid approximation of a two-stage queueing model and simulation. Each of these models use data from a partner hospital to recover realistic modeling parameters, but evaluate policies in terms of objectives (e.g., abandonment costs) that might reflect financial considerations, patient flow, and/or patient outcomes. These queueing models may benefit from objectives that account for the actual impact of the split flow model on patient outcomes, which the present paper seeks to estimate.

2.3 Actual split flow models

Several empirical studies have analyzed whether split flow models are associated with decreased length of stay (LOS) (c.f., Subash et al. (2004), Medeiros et al. (2008), Han et al. (2010), Soremekun et al. (2012)) or reduced ED revisits and mortality (c.f., Burström et al. (2012), Burström et al. (2016)). For example, in a retrospective study of three Swedish EDs, Burström et al. (2012) consider three triage models: senior physician-lead team; nurse first, emergency physician second; and nurse first, junior physician second. They show that physician-led triage is associated with reductions in the time to first doctor encounter, LOS, rate at which patients leave without being seen, revisits, and mortality. These associations suggest split flow models improve patient flow and outcomes, but since the intervention was not randomized, other factors that differ between the three EDs could have driven the discrepancy in patient flow and outcomes.

Empirical support has also been provided for certain operational strategies (e.g., physician-triage, fast-tracking) embedded in the split flow model. Russ et al. (2010) found that patients who had an order placed by a physician prior to bed assignment saw a 11-minute decrease in median time until disposition compared to a matched sample of individuals with a similar order placed after bed assignment. Using data from 16 consecutive Mondays, Partovi et al. (2001) found a decrease in LOS on the 8 Mondays with physician-triage compared to 8 days without. Traub et al. (2016) also investigated physician-triage, wherein they used a log-linear regression model to predict log LOS after matching days with a physician triage to days in the next year based on day of the week and calendar date. They found a 6.25% decrease in the geometric mean LOS due to physician-triage compared to rotational patient assignment based on a linear regression model. Considine et al. (2008) found fast-tracked patients saw a 16-minute decrease in median LOS compared to matched controls from a prior time period when the ED did not use fast-tracking. Critically, all these studies use a matching strategy, which is useful for adjusting for measured confounding, e.g., the day of the week that a patient arrives, but not unmeasured confounding (e.g., patient severity). Perhaps as a way to adjust for unmeasured confounding, some of these studies also adjust for variables that could be affected by the intervention itself (e.g., disposition disposition, patients registered in a day). However, these adjustments can make it difficult to interpret the estimate of interest as an average causal effect.

2.4 Causal inference methods

In an effort to go beyond associations, causal inference methods estimate the average causal effects of an intervention, relying on *identification* assumptions to ensure estimates are unbiased or consistent. Among the various causal inference methods available, we focus on a regression discontinuity (RD) design for its potential for adjusting for both measured and unmeasured confounding.

Originally considered by Thistlethwaite and Campbell (Thistlethwaite and Campbell 1960), RD designs were developed to estimate the average impact of interventions in non-experimental settings where the intervention is determined by whether an observed variable, referred to as the “forcing” or “running” variable, exceeds a known cutoff point. A RD design fits our problem: we want to estimate the average impact of the patient-flow model (split flow vs. traditional flow) and can use arrival time as the forcing variable, since the split flow model operates during certain hours of the day. Broadly, the idea of RD design is to build a regression model to explain outcomes as a function of the forcing variable using data only with a forcing variable near the cutoff point. Under certain assumptions, *discontinuity* in mean outcomes at the cutoff point can then be attributed to the intervention (Hahn et al. 2001).

Many studies have relied on RD designs to estimate average causal effects of interventions. We refer the reader to the user guides by Lee and Lemieux (2010) and Imbens and Lemieux (2008) for a discussion of practical and theoretical considerations of RD methods. The study by Almond and Doyle (2011) is closest to ours in terms of application area and using time of day as a forcing variable. They use a RD design to study extending the hospital stay of newborn affects costs and outcomes. Given that newborns with longer hospital stays may have different insurance coverage and treatment needs, Almond and Doyle (2011) compared newborns born right before and right after midnight, since newborns after midnight were reimbursed for an extra day in the hospital compared to newborns before midnight. They find that the additional reimbursed day induces substantial extensions in length of hospital stay for mother and their newborn, but did not have a significant effect on readmissions or mortality. Although similar to the approach of Almond and Doyle (2011), our approach will have an important difference. Specifically, we account for potential non-independence of observations from strong intra-day correlation using a mixed effects regression model.

3 Causal Framework

3.1 The intervention: a split flow model for the ED

Although variations occur depending on the needs of the patients and the specific hospital under consideration, most visits start with patients registering at a check-in desk and recording a chief complaint (e.g. abdominal pain, chest pain, shortness of breath, headache). After registration, a patient can follow a more traditional model of patient flow (Figure 1A) or a split flow model (Figure 1B).

In traditional patient flow, the patient is triaged by a nurse during which information is collected about their vital signs and why they came to the ED. After triage, the nurse assigns patients an acuity (ESI or emergency severity index) score of 1-5. These scores along with patient complaints determine the order in which the patient will be brought into a main assessment/treatment room. If they are not immediately brought back to a room, they remain in the waiting room. When it is their time, the patient is placed in a room where a provider in the ED will assign themselves to the patient, initiating the physician or physician assistant (PA) interaction with the patient. After assigning themselves, physicians will see the patient, enter orders for treatments and tests including labs and imaging. Patients will receive care from nurses and physician, and will often need reassessment to ensure they are responding appropriately prior to disposition. Other providers from services like orthopedics, neurology, etc., may be called by ED staff to see the patient at some point after providers are assigned. After treatment, a determination of where a patient will go (i.e., transfer, discharge, or admission) is made.

By contrast in a split flow model, the role of the nurse responsible for triage is replaced by an attending physician focused on starting care, developing care plans, and sorting the patients in the correct queue for care. At our partner ED, this process started at 1pm to 10pm from November 1, 2016 to June 29th, 2017 and henceforth starts at 12pm and

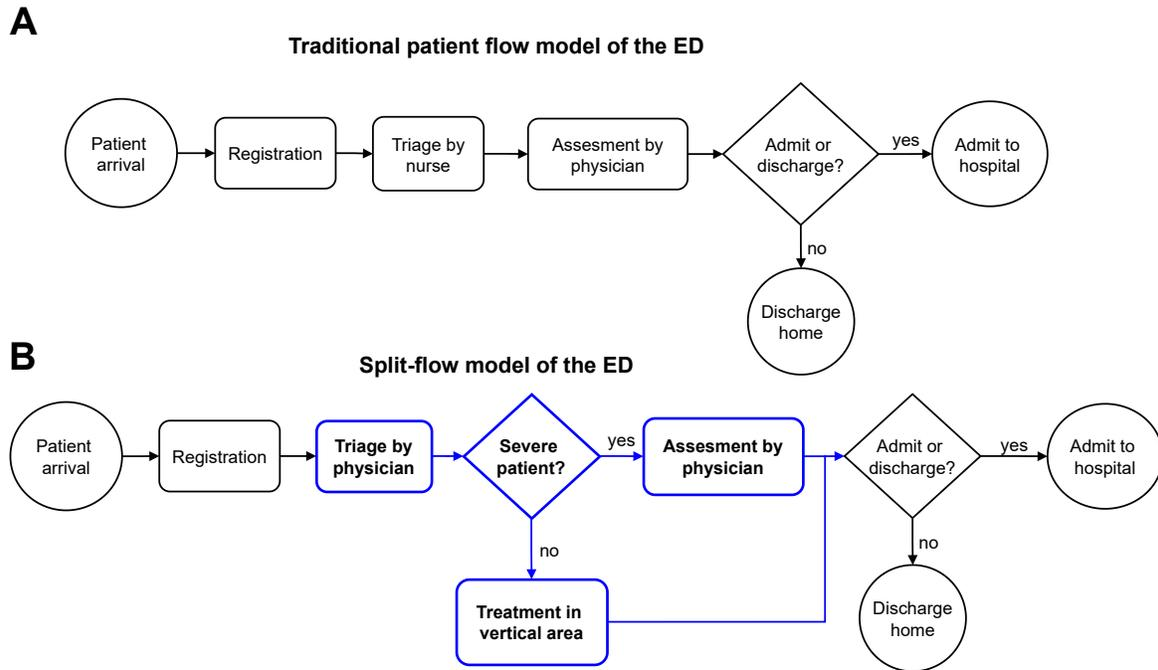

Figure 1: Patient flow models of the ED. **(A)** In a more traditional patient flow model, a nurse triages patients after which a physician assesses and treats the patient. **(B)** In a split flow model, a physician triages a patient which allows them to immediately treat the more severe patients.

lasts until 9pm each day and during those times, and takes place in a dedicated suite of rooms immediately after the patient arrives. After triage, patients who require a bed in the main ED are sent to a bed in the main ED. There, they will wait for any care initiated by the physician at triage or for care from the physicians devoted to the main ED. Lower acuity patients are discharged if they do not need specialized attention or guided through specially designated care area if the triage physician decides that they will require additional medical care. The designated rooms are cleaned and prepared for the next patient. Patients assigned to these rooms will wait for care from the physician responsible for triage or the definitive care provided by the care team, or for medical treatments such as radiology or IV placement. Finally, after the treatment inside this room ends, a decision of discharge or admission is made.

To summarize, a split flow model, like many interventions, consists of several key components, each of which are inherent to the intervention and could contribute to effectiveness over a traditional patient flow. These include

- Initial triage and early task initiation by a physician
- Treatment in a vertical patient (no bed) area of patients who do not require beds

As such, we are investigating the sum of these components. Each was designed to improve patient flow. As a result, we expected:

Hypothesis 1 *A split flow model reduces the average time from patient arrival to admission decision.*

Each component was designed to re-organize patient flow, not patient care. So, we had also expected that:

Hypothesis 2 *A split flow model has negligible consequences to admission or revisit rates.*

Moreover, any speed up may be attributed to either component of a split flow model: early task initiation or streaming of patients to a bed or the vertical patient area. This motivates our next hypothesis:

Hypothesis 3 *Faster treatment from a split flow model is mediated by earlier physician orders and by changes in how quickly patients are moved to a bed or vertical patient area.*

Finally, ED providers speed up care when the ED is busy even without a physician at triage, which could limit the effectiveness of a split flow model when the ED is busy. So, we also expected that:

Hypothesis 4 *A split flow model is less effective at reducing average time from arrival to admission decision when the ED is busy.*

We now define the necessary variables to be able to test these hypotheses.

3.2 Average causal effect of the intervention

We use the potential outcome framework, central to the counterfactual theory of causality proposed by Neyman (Neyman 1923) and extended by Rubin (Rubin 1974) and Robins (Robins 1986), to examine how the intervention, a split flow model, directly impacts four common measures of ED care: time to be roomed, time to disposition decision after being roomed, admission decision, and ED revisits. For example, ED revisits is a common metric for evaluating ED care since it might indicate that follow-up care was not properly organized or that patients were not adequately treated before discharge (Keith et al. 1989, Sabbatini et al. 2016). However, we caution the reader that this metric has come under recent scrutiny as a measure of quality care (Welch 2009, Rising et al. 2015, Cheng et al. 2016, Shy et al. 2018). Letting $Y \in \mathbb{R}$ denote observed outcomes, potential outcomes $Y^a \in \mathbb{R}$ denotes the random potential outcome that could have been observed were a split flow model used ($a = 1$) or were a more traditional patient flow model ($a = 0$). Within this framework, we can examine the direct impact of the split flow model on potential outcomes by examining how potential outcomes differ on average between the two patient flow models: $\mathbb{E}[Y^1 - Y^0]$.

Because we cannot observe both potential outcomes for each visit, we will need additional variables to identify potential outcomes. Patient arrival time is denoted by T with units of hours. Patient flow model $A \in \{0, 1\}$ is a deterministic function of T , with $A = 1$ signifying that a split flow model was used and $A = 0$ signifying a traditional flow model. Patient arrival time may depend on measured characteristics X prior to treatment (e.g., age, sex) as well as unmeasured variables U . For example, patients with less urgent conditions often wait until after work hours to visit the ED or use the ED on the weekend when they cannot reach their primary care provider (Davis et al. 2010). Further, all variables might influence patient outcomes.

3.3 Challenges with identifying causal effects

Identifying average causal effect $\mathbb{E}[Y^1 - Y^0]$ requires three assumptions: consistency, positivity, and exchangeability (Hernan and Robins 2020). Consistency holds if the intervention is well-defined in that the actual outcome Y is Y^A , i.e. the potential outcome under the observed patient flow model A . We assume consistency of the patient flow model. Positivity holds if every patient has a chance of being assigned to either patient flow model: $0 < \mathbb{P}[A = 1] < 1$. Exchangeability holds if potential outcomes are independent from the patient flow model: $Y^0, Y^1 \perp\!\!\!\perp A$. Broadly speaking, this means that actual outcomes are representative of potential outcomes. In practice, positivity and exchangeability may not be reasonable for the entire sample, but can be weakened to hold only within groups of individuals with similar characteristics.

We anticipate that either positivity or exchangeability might not hold based on our conceptual model of the ED, which we depict in the causal diagram in Figure 2A. This diagram captures the fact that arrival time T determines the patient flow model A and the possibility that the patient flow model A influences outcomes, since this relationship is our question of interest. It also includes the possibility that patient characteristics X directly influence the arrival time T and that patient characteristics X and arrival time T also directly influence outcomes Y . For example, younger patients (< 65 years) may be more likely to arrive outside work hours, or hospitals may want to speed up time to disposition during

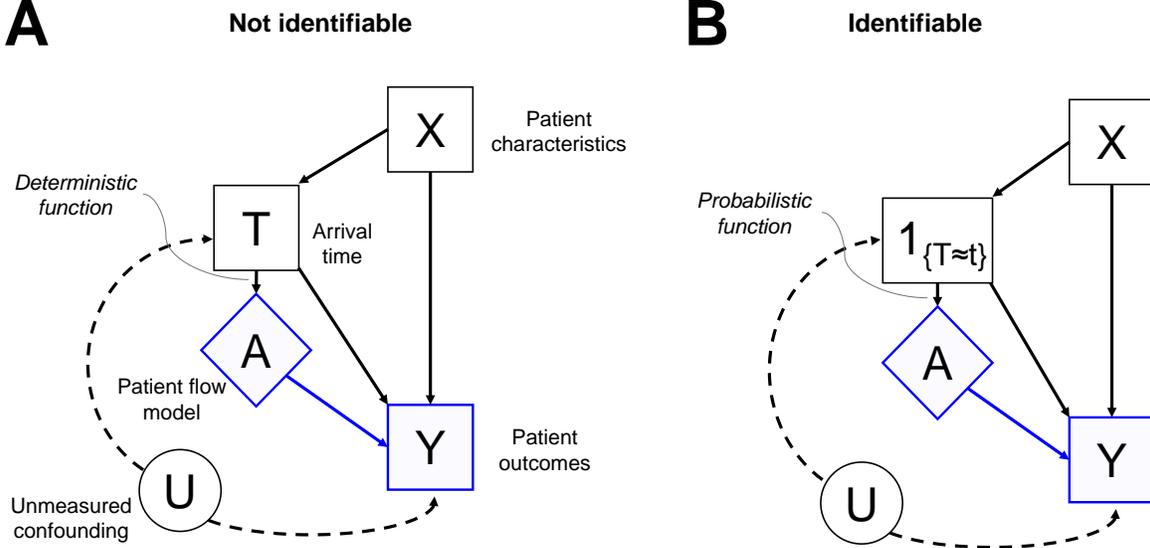

Figure 2: Causal diagrams of patient outcomes. Causal effects of patient flow model A on patient outcomes Y (in blue) are generally not identifiable in the diagram in (A), as either positivity or exchangeability is violated, but could be identified under additional assumptions as specified in the diagram in (B).

peak ED hours or slow down time to disposition for their older patients. Finally, we anticipate possible unmeasured variables U which could directly influence both arrival time T and patient outcomes Y . Unmeasured patient severity, for instance, might lead to worse outcomes and an arrival time T in early hours.

In general, average causal effects are not identifiable when the relationship between the patient flow model A and patient outcomes Y is indeed confounded by unmeasured variables U . Based on Figure 2A, patients with the same arrival time T are exchangeable, i.e. $Y^0, Y^1 \perp\!\!\!\perp A | T = t$. Exchangeability is seen for this diagram as the blocking of any backdoor paths from A to Y by the variable T . Patient with the same arrival time T , however, do not have a positive probability of being assigned to either patient flow model, i.e. $\mathbb{P}[A = 1 | T = t] \in \{0, 1\}$, since the patient flow model is a deterministic function of T . On the other hand, patients with the same patient characteristics X have a positive probability of being assigned to either patient flow model, i.e. $0 < \mathbb{P}[A = 1 | X = x] < 1$, but are generally not exchangeable $Y^0, Y^1 \not\perp\!\!\!\perp A | X = x$, since X does not block backdoor paths from A to Y that go through T .

Causal effects could be identified given the diagram in Figure 2B. This diagram can identify effects provided a coarser variable $1_{\{T \approx t\}}$ of arrival time can guarantee positivity and maintain exchangeability for patients with similar values of $1_{\{T \approx t\}}$. These observations will motivate our approach for estimating $\mathbb{E}[Y^1 - Y^0]$.

3.4 Data available for identification

Visits to the study ED ($n = 112,083$) were available to evaluate the intervention. Visits occurred between November 1st, 2016 to September 27th, 2018. Data was curated from EHR of the study hospital and an associated network of primary and specialty care clinics. Visits were excluded sequentially for the following reasons: patients were transferred from other hospitals or hospices, since these patients were triaged outside of the study ED ($n = 1,979$); chief complaint was misreported as a procedure ($n = 143$); patients were younger than 18 years, since they were never triaged under a split flow model at the study ED ($n = 23,664$); patients arrived by ambulance, helicopter, or other means different than walking through the registration process of the ED ($n = 25,886$); patients had a missing time to disposition decision after being roomed ($n = 26$); and patients had a missing disposition decision ($n = 20$). The remaining sample was used for analysis.

The sample contained baseline patient characteristics X : age, sex, race/ethnicity, chief complaint, and insurance. Observations were also available for arrival time T and the split flow model A (a binary outcome [yes/no] specifying whether patient utilized the split flow model) and for each of four outcomes Y , analyzed separately:

- Time to be roomed: duration of time between arrival time and when patient is placed in a treatment or vertical area room,
- Time to disposition: duration between when a patient is roomed and when the disposition decision is made,
- Admission decision: a binary variable [admit/discharge] specifying the decision to discharge patient home or admit to them to inpatient unit,
- ED Revisit: a binary outcome [yes/no] specifying whether the patient returns to the ED within 30 days of being discharged from either the hospital for admitted patients or the ED for discharged patients.

To simplify analysis, we grouped chief complaint into the five most common ones (i.e., abdominal pain, chest pain, dyspnea, fall, and fever) and marked the remaining complaints as "Other". A missing chief complaint ($n = 151$) was also marked as "Other". Visits with missing health insurance ($n = 9,355$) were placed into the "Unknown" category.

3.5 Confounding, moderation, and mediation

Our main explanatory variable A is whether an ED patient goes through a split flow model or a traditional patient flow model. However, several variables may offer further operational insight into the implementation of a split flow. We organize these variables within our causal framework into confounding, mediating, or moderating variables.

3.5.1 Confounding variables.

Our ability to estimate the average causal effect of the split flow model, i.e. the specific intervention that involves a physician at triage and a vertical area dedicated to treating low acuity patients, will rest on the assumption that the arrival time T will block any variable that confounds the relationship between the intervention A and outcome Y (see Figure 2). This assumption should account for *patient-level* differences between split flow and traditional patient flow patients, provided patients do not manipulate their arrival time. However, this assumption does not account for possible *operation-level* differences between split flow and traditional patient flow patients at our study hospital, which could confound the relationship between the intervention and outcome. To attribute any improvement to solely the split flow model, we must investigate potential operation-level confounders in our particular dataset:

- Shift change. Physicians are assigned to seven different shifts at the study hospital, one of which is a one-person shift devoted to implementing the split-flow model from 12a–9p. Patient care may improve due to the shift change at the start of the split-flow model rather than the split-flow model itself. If a shift change is important, then we may expect to see an effect on patient outcomes from changes to other shifts (i.e., 7a–4p, 11a–8a, 9a–5p, 5p–2a, 10a–4p, 4p–2a).
- Physician assignment. How physicians are scheduled to shifts may introduce bias if certain physicians were both disproportionately assigned to split flow and more likely to produce certain outcomes compared to other physicians. Thus, we consider the particular physician assigned to a patient visit as a possible confounder.

3.5.2 Moderating variables.

The split flow-model may be more or less effective depending on operational context. This information will be useful when trying to predict the degree to which a split flow model will be effective in a particular hospital at various points in time. We consider whether the following operational variables may moderate the relationship between the intervention and patient outcomes:

- Congestion. One of our main hypotheses is that split flow model may improve patient flow more greatly during periods of high congestion. We computed a variable, which we call congestion, for each visit in our

dataset as the ED census at the time of arrival. The ED census included everyone in the adult ED, regardless of who they are or where they are in the ED (e.g., waiting room) or in their treatment pathway (e.g., post-disposition decision).

- Day of the week. Given our hypothesis about congestion and how congestion varies over the 7-day week, we also expect that day of the week will be another moderator.
- Physician workload. Like congestion, physician workload might also be a possible moderator, with higher physician workloads associated with greater improvements from the split-flow model. One benefit of physician workload over congestion is that it accounts for the number of physicians in the ED. We can compute workload for each physician at each point in time following prior literature (Batt and Terwiesch 2017, Kc 2014, Song et al. 2015) as the ratio of patients to providers. To recover a variable, which we will call physician workload, for each visit, we take the ED census at the time of arrival averaged over physicians currently in the ED. We point out that this variable uses only information available prior to being assigned a patient flow model (as opposed to the workload of any physician assigned to the visit), which allows us to treat this variable as a moderator.
- Start time of split flow model. When the split flow model is initiated during the day may be another moderator. Since the start time for the split flow model changed from 1p to noon in our dataset, we are able to investigate start-time as a possible moderator.

3.5.3 Mediating variables.

When describing the split flow, we pointed out two components of the split flow model: initial triage and early task initiation by physician and treatment in a vertical area of low-needs patients. Ideally, we want to learn the degree to which each of these components contributes to intervention effectiveness, so that hospitals could optimize the implementation of split flow. However, we cannot directly separate their contribution, since they are both inherent to the intervention and operate at the same time. We might indirectly get at this information by investigating whether certain markers of these components might mediate the relationship between the intervention and patient outcomes. Hence, we consider the following:

- Time to first order. We consider the time to first order of either imaging, labs, or medication. This variable is used as a mediator to capture the hypothesized benefits of early task initiation. In particular, if early task initiation is important to the split-flow model’s effectiveness, then we expect to find that a split flow model leads to shorter time to first order of lab tests and that shorter times to first order, regardless of the patient flow model, leads to shorter time to disposition.
- Time to be roomed. While this variable is considered a primary outcome, it might also act as a possible mediator of the relationship between a split flow model and time to disposition after being roomed. On the one hand, treatment can be initiated early for low-needs patients by the physician at triage before they are officially placed in the vertical area. As a result, we might expect that split flow might increase time to be roomed and that longer times to be roomed, specifically under a split flow model, lead to shorter time to disposition after being roomed. On the other hand, the physician is able to quickly stream low-needs patients to the vertical area. As a result, we might expect that split flow might decrease time to be roomed, but at the expense of longer times to disposition.

A potential outcomes framework can again be used to define different mediation effects (Nguyen et al. 2020, Imai et al. 2010). To define these effects, let M be a random variable representing one of the possible mediators, either time to be roomed or time to first order (of either imaging, labs, or medication). Let $M^a \in \mathbb{R}$ denote the random potential mediator that could have been observed were a split flow model used ($a = 1$) or a traditional patient flow model ($a = 0$). In addition, let $Y^{a,b} \in \mathbb{R}$ to denote the random potential outcome that could have been observed were both a split flow model used ($a = 1$) or a traditional patient flow model ($a = 0$) and the mediator variable was set to b . Similar to potential outcomes, we assume consistency (i.e., $M = M^A$ and $Y = Y^{A,M}$).

In terms of the variables above, the average causal effect can be decomposed in one of two ways:

$$\begin{aligned}\mathbb{E}[Y^1 - Y^0] &= \mathbb{E}[Y^1 - Y^{1,M^0}] + \mathbb{E}[Y^{1,M^0} - Y^0], \\ \mathbb{E}[Y^1 - Y^0] &= \mathbb{E}[Y^1 - Y^{0,M^1}] + \mathbb{E}[Y^{0,M^1} - Y^0].\end{aligned}$$

This decomposition informs us about mediation. There are average *natural indirect* effects (NIE):

$$\bar{\delta}(a) := \mathbb{E}[Y^{a,M^1} - Y^{a,M^0}]$$

for $a = 0, 1$, capturing the degree to which the effect of an intervention is attributed to changes in the mediator. There are also *natural direct* effects (NDE):

$$\bar{\zeta}(a) := \mathbb{E}[Y^{1,M^a} - Y^{0,M^a}],$$

for $a = 0, 1$, capturing the degree to which the intervention has an effect were the mediator fixed. In the context of the present study, the NIEs reflect the gap in average outcomes if we were to change the time to be roomed or time to first order under a split-flow vs. patient flow model but keep the rest of the patient flow model fixed. The NDEs reflects the gap in average outcomes between those who undergo a split flow model vs. a traditional flow model while keeping the time to be roomed or time to first order fixed. A possible mediator is important to a split flow model if we observe large NIEs but small NDEs.

Identifying NIEs and NDEs imposes additional challenges beyond what is faced when trying to identify the average causal effect. Even though arrival time T may block backdoor paths through A , we do not expect arrival time T to block backdoor paths through the mediator M (Figure 3). Rather, both measured variables X and unmeasured variables U , notably patient severity, are expected to influence both the mediator M (i.e., whether an individual is treated in the vertical area or receives an early image order) and patient outcomes Y . This means that exchangeability is violated, and the NIEs and NDEs are not identifiable in general. In such a case, specific assumptions about the relationship between variables are needed for identification.

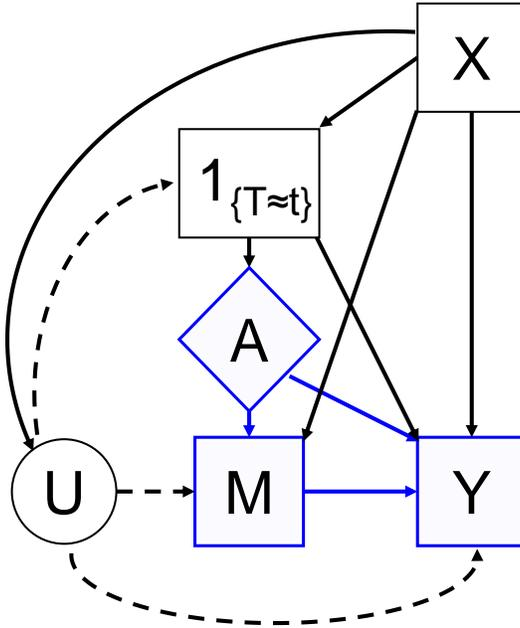

Figure 3: Causal diagrams of patient outcomes including a mediator M . Causal effects of patient flow model A on patient outcomes Y which involve a mediator M (in blue) are generally not identifiable in the diagram, as exchangeability is violated.

4 Identification of average causal effects

4.1 Sharp regression discontinuity

To identify average causal effects, we consider a sharp regression discontinuity (RD) by restricting attention to patients with arrival times T around the time each day that the split flow model is started. Intuitively, we want patients with similar arrival times ($T \approx t$) to be exchangeable (as in the identifiable causal diagram in Figure 2B). Consequently, any difference in potential outcomes around the start times of a split flow model can be attributed to the patient-flow model. Formally, a sharp RD design requires that there exists some time point t_0 at which the probability of patient-flow model is discontinuous in arrival time T (Assumption 1) but potential outcomes are continuous in T (Assumption 2):

Assumption 1 (*Discontinuity of treatment assignment*) Limits $\lim_{t \rightarrow t_0^+} \mathbb{P}[A = 1|T = t]$ and $\lim_{t \rightarrow t_0^-} \mathbb{P}[A = 1|T = t]$ exist but are unequal.

Assumption 2 (*Continuity of potential outcomes*) $\mathbb{E}[Y^a|T = t]$ is continuous at $t = t_0$ for $a = 0, 1$.

Under these two assumptions, average causal effects can be identified at $t = t_0$ (Hahn et al. 2001), since

$$\mathbb{E}[Y^1 - Y^0|T = t_0] = \lim_{t \rightarrow t_0^+} \mathbb{E}[Y|T = t] - \lim_{t \rightarrow t_0^-} \mathbb{E}[Y|T = t].$$

For our problem, Assumption 1 is trivially satisfied at every start time of the split flow model by definition of the patient flow model A . Assumption 2 will hold if individuals are exchangeable around start times of the split flow model, but is generally not verifiable. There are, however, techniques to evaluate this assumption as we discuss in the next subsection.

Remark 1 *Note there is no theoretical reason why we could not also consider times t_0 each day when the split flow model ends. Practically, however, there are fewer arrivals around the split flow model's daily end time that are available for estimation. An average of 11 patients arrive between 11a and 1p (12a and 2p before November 1, 2017) compared to only 8 between 8p and 10p (9p and 11p before November 1, 2017) each day. For simplicity, we thus focus on using a RD approach for start times of the split flow model in the main text, leaving an analysis of end times in the Appendix.*

While average causal effects can be identified with these assumptions for any start time t_0 of the split flow model on a given day, there are few visits around each start time t_0 available for estimation. Fortunately, whether or not a patient is assigned to a split flow model depends only on the time of day that they arrive (e.g., 1:05p) and not the exact date and time that they arrive (e.g., 12/01/20 at 1:05p). Thus, we suspect that patients are exchangeable immediately before or after the start time of the split flow model. That is, letting S denote the difference between the arrival time T and the start time on the given day modulo 24 hours, we believe patients are exchangeable if $S \approx 0$. In light of these observations, we replace Assumptions 1–2 with

Assumption 3 Limits $\lim_{s \rightarrow 0^+} \mathbb{P}[A = 1|S = s]$ and $\lim_{s \rightarrow 0^-} \mathbb{P}[A = 1|S = s]$ exist but are unequal.

Assumption 4 $\mathbb{E}[Y^a|S = s]$ is continuous at $s = 0$ for $a = 0, 1$.

Under these two assumptions, we can then identify the average causal effect of the patient flow model at $s = 0$ aggregating data from every day that the split flow model is implemented.

4.2 Estimation of average causal effects

We estimate $\mathbb{E}[Y^1 - Y^0|S = 0]$ by assuming certain structural dependencies between time from arrival to split flow start S and outcome Y . Specifically for continuous outcomes, we assume outcomes satisfy:

$$\mathbb{E}[Y|S] = \alpha + \begin{cases} f_0(S) & \text{when } S < 0 \\ f_1(S) + \gamma & \text{when } S \geq 0 \end{cases}$$

for some polynomial functions $f_0(\cdot)$ and $f_1(\cdot)$ with $f_0(0) = f_1(0) = 0$. It is common to use low degree polynomials for f_0 and f_1 , such as linear or quadratic functions, since a high degree polynomial can lead to misleading estimates (Gelman and Imbens 2019). These functions can also be constrained to share coefficients such as slopes. Provided the model is correctly specified and under Assumptions 1–2, then taking left and right limits towards $s = 0$ reveals that the coefficient γ is exactly the desired average causal effect $\mathbb{E}[Y^1 - Y^0|S = 0]$.

Although average causal effects are identified with only a structural model of Y in T , regression models can usually increase efficiency in estimation by adding covariates to explain additional variation in Y . We thus added baseline covariates X to the regression model:

$$\mathbb{E}[Y|S, X] = \alpha + \beta X + \begin{cases} f_0(S) & \text{when } S < 0 \\ f_1(S) + \gamma & \text{when } S \geq 0 \end{cases}. \quad (1)$$

Specifically, we adjusted for age, sex, race (White vs. Non-White), and chief complaint (abdominal pain vs. other). To estimate these parameters, we note that observations collected on any given day may be strongly correlated, given that ED variables tend to exhibit significant correlation patterns, e.g., daily, weekly, and monthly (Whitt and Zhang 2019). We thus adjusted for this non-independence by estimating parameters with a linear mixed effects regression model in which a random intercept is included for each day of arrival. Although both a random intercept and a fixed intercept can account for non-independence, we opted for a random intercept to dramatically reduce the number of parameters estimated: 2 for the mean and standard deviation of the random intercept vs. 696 for the fixed intercepts associated with each day in the sample. An alternative is to estimate parameters for each day in the dataset and then aggregate these estimates.

For the two binary outcomes (admission and ED revisit), we use the same model at 1 to estimate γ . In this case, the model is referred to as a *linear probability model*, and γ reflects that the difference in admission/revisit rate resulting from the split flow model. An alternative approach would be to apply a logistic (or probit) transformation to $\mathbb{E}[Y|T, X]$, where then γ would have been the limiting odds ratio between treatment and control groups. Unfortunately, even when covariates X and intervention A are all mutually independent, logistic or probit regression models are not *collapsible*, as defined in Greenland et al. (1999), whereas linear or log-linear regression models are collapsible. Noncollapsibility means that the intervention effect γ as a measure of association between A and Y changes with the choice of covariates X and can occur even when the intervention effect is equal in every level of a covariate. Since we consider regression models with different covariates, we wanted to avoid the difficulty of comparing and interpreting an intervention effect that is particularly sensitive to our choice in covariates. One caveat of using linear probability models for probabilities is that they are not constrained to lie in the interval $[0, 1]$, leading to biased estimates that depend on the number of observations for which the fitted model yields predicted outcomes outside the interval $(0, 1)$ (Horrace and Oaxaca 2006).

4.3 Graphical analysis

Before a formal analysis is performed, it is common and useful to informally inspect certain graphical plots for glaring issues with RD assumptions (Imbens and Lemieux 2008, Lee and Lemieux 2010). This inspection is briefly described here, with details and accompanying figures left to Appendix A. First, RD design evaluates the effect of split flow by measuring the value of the discontinuity in the expected value of the outcome at the start of split flow. Plots of average outcomes are inspected to check that average outcomes are discontinuous at the start time of the split flow model (Imbens and Lemieux 2008, Lee and Lemieux 2010). Second, the continuity assumption can be incorrect if there is discontinuity in who arrives at $T = t_0$. Consequently, any discontinuity in observed outcomes could be attributed as much to this discontinuity in arrivals as to the patient flow model. Discontinuity in arrivals could arise if patients *knew* when a split-flow model occurs and decide to manipulate their arrival time T in order to be assigned a particular patient-flow model A (Lee and Lemieux 2010). To examine this possibility, histograms of arrival times are inspected to look for discontinuity in number of arrivals before or after the start time of the split flow model. Further, if patients are unable to manipulate their arrival time, patient covariates (i.e., age, sex, and race) should, on average, be “locally balanced” on either side of start of split flow. Thus, plots of average covariates are inspected to look for discontinuities

around the start time of the split flow model. To emphasize, the main concern is a *discontinuity* in who arrives at $T = t_0$, not a continuous change over time such as when chest pain patients arrive earlier in the day than other types of patients.

4.4 Bandwidth and polynomial order selection

RD design involves a judgement for selecting the bandwidth h and polynomial form of f_0 and f_1 (Lee and Lemieux 2010). On one hand, a large bandwidth could reduce variance of estimated γ by increasing sample size. Polynomials of a small order might also reduce variance in estimated γ as fewer coefficients are estimated. On the other, a small bandwidth and higher-order polynomials can improve the accuracy of the outcome model at Eq. (1). Moreover, a smaller bandwidth should yield ED visits that are more exchangeable and hence reduce estimation bias in average treatment effects. Thus, there is a clear trade-off between bias and variance when choosing the bandwidth. For reference, variation in ED visits has been studied on a scale of hours (Choudhury and Urena 2020), suggesting that the outcome model could be reasonably accurate with a bandwidth of about 1 hour, but may hide important ED trends with larger bandwidths.

Following Lee and Lemieux (2010), we used leave-one-out cross-validation in an effort to find the smallest bandwidth and suitable polynomial form that can yield stable predictions. For each outcome, this entailed fitting the model at Eq. 1 with given polynomial form of f_0 and f_1 to all ED visits within a given bandwidth h of t_0 except for one visit within 1/2 hour of the split flow start time. Based on the fitted model, square error between the actual and predicted outcome was measured for the visit left out. This procedure was repeated leaving out each visit within 1/2 hour of the split flow start time. Square error was averaged over all observations within one-half hour of the split flow start time and over all start times t_0 that are aggregated.

Table 1 reports mean square error for bandwidth h varied from 0.5 hours to 3 hours and polynomial form of f_0 and f_1 varied to be either linear with equal slopes, linear with different slopes, or quadratic. Reasonable mean square errors (when compared to other errors) could be achieved for all outcomes regardless of the polynomial choice f_0 and f_1 or the bandwidth. We thus focus on the smallest bandwidths of 1/2 hour and 1 hour with linear, equal-sloped polynomials. Other bandwidths will also be reported to check for sensitivity of findings to bandwidth selection.

4.5 Addressing confounding, moderation, and mediation

4.5.1 Confounding variables.

Two approaches are used to account for the possibility that a shift and physician assignment confound the relationship between split flow and patient outcomes. We can attempt to indirectly determine the degree to which a shift change might impact patients outcomes by applying our RD analysis at start times of other shifts. For each of these times, we conducted the same RD analysis, but focused on patients within a bandwidth of these times and examined the effect of the shift change on patient outcomes. Meanwhile, to account for the possibility that a certain physician is a confounder, we repeated our RD analysis including a random intercept for each physician in our dataset and examined whether the effect of intervention significantly changed. The addition of a random intercept allows average outcomes to shift up or down according to which physician is assigned to patient, so that we can account for one physician who, e.g., yields faster treatment times than another. As before, we opted for a random intercept as opposed to a fixed intercept to reduce the number of parameters.

4.5.2 Moderating variables.

We investigated, in three steps, the possibility of effect modification for each of the variables identified as a possible moderator in our causal framework (Section 3). We first transformed congestion and physician workload into a categorical variable representing tertiles, with the lowest (highest) tertile corresponding to those days with the lowest (highest) levels of congestion or workload. The three tertiles for congestion correspond to ranges of [2, 30], (30, 41] and (41, 81], whereas the three tertiles for physician workload correspond to ranges of [0.2, 2.4], (2.4, 3.1] and (3.1, 17.7].

Polynomial form	Bandwidth (hours)					
	0.5	1	1.5	2	2.5	3
	Time to disposition					
Linear - same slopes	4.23 (0.152)	4.22 (0.153)	4.22 (0.153)	4.22 (0.154)	4.21 (0.153)	4.21 (0.153)
Linear - different slopes	4.23 (0.154)	4.22 (0.153)	4.22 (0.153)	4.22 (0.159)	4.22 (0.153)	4.22 (0.153)
Quadratic	4.23 (0.153)	4.22 (0.153)	4.22 (0.154)	4.22 (0.155)	4.22 (0.154)	4.22 (0.154)
	Triage time					
Linear - same slopes	0.19 (0.011)	0.19 (0.012)	0.19 (0.012)	0.20 (0.012)	0.20 (0.012)	0.21 (0.013)
Linear - different slopes	0.19 (0.011)	0.19 (0.012)	0.19 (0.012)	0.19 (0.012)	0.19 (0.012)	0.19 (0.012)
Quadratic	0.19 (0.011)	0.19 (0.011)	0.19 (0.011)	0.19 (0.011)	0.19 (0.011)	0.19 (0.012)
	Admission					
Linear - same slopes	0.17 (0.003)	0.17 (0.003)	0.18 (0.003)	0.18 (0.003)	0.18 (0.003)	0.18 (0.003)
Linear - different slopes	0.17 (0.003)	0.18 (0.003)	0.18 (0.003)	0.18 (0.003)	0.18 (0.003)	0.18 (0.003)
Quadratic	0.17 (0.004)	0.17 (0.004)	0.17 (0.004)	0.17 (0.004)	0.17 (0.004)	0.17 (0.004)
	ED Revisit					
Linear - same slopes	0.11 (0.004)	0.10 (0.004)	0.10 (0.004)	0.10 (0.004)	0.10 (0.004)	0.10 (0.004)
Linear - different slopes	0.11 (0.004)	0.10 (0.004)	0.10 (0.004)	0.10 (0.004)	0.10 (0.004)	0.10 (0.004)
Quadratic	0.12 (0.004)	0.10 (0.004)	0.11 (0.004)	0.10 (0.004)	0.10 (0.004)	0.10 (0.004)

Table 1: Mean square error (standard error) for four outcomes using leave-one-out cross-validation.

For each moderator and each outcome, we next added indicators for each level of the moderator (e.g., low, middle, and high congestion tertile) and their interactions with the split flow indicator to the model described in Equation 1. In each case, we used the fitted model to estimate average effects by level of a moderator and to perform a Wald hypothesis test of the null hypothesis that all interaction terms are zero. The resulting P -value was used to indicate whether or not a variable was a significant moderator. Last, in an effort to recover the specific contributions of each moderator, we added all the indicators for every level of every moderator and their interactions with the split flow model to our RD analysis model. The final fitted model was used to estimate interaction terms by level of a moderator and to perform a Wald hypothesis test of the null hypothesis that all interaction terms for a given moderator are zero.

4.5.3 Mediating variables.

For each mediator identified in Section 3, we need to impose strong assumptions to identify average NIEs $\bar{\delta}(a)$ and NDEs $\bar{\zeta}(a)$. Following Imai et al. (2010), we assume $\bar{\delta}(0) = \bar{\delta}(1)$ and $\bar{\zeta}(0) = \bar{\zeta}(1)$. We also assume the causal model in Figure 3 except there are no unmeasured variables confounding the relationship between the mediator M and the

outcome Y . That way, we can assume sequential ignorability (Imai et al. 2010): potential outcomes $Y^{a,b}$ and $M^{a'}$ are independent from A conditioning on X and potential outcomes $Y^{a',b}$ are independent from $M^{a'}$ conditioning on X and A . Finally, our final assumption is a linear regression model for outcomes Y and mediator M :

$$\begin{aligned}\mathbb{E}[Y|S, A, M, X] &= \alpha + \beta X + \psi S + \gamma A + \mu M \\ \mathbb{E}[M|S, A, X] &= \alpha' + \beta' X + \psi' S + \gamma' A.\end{aligned}\tag{2}$$

This model for Y is identical to original RD model at Equation 1 except with the addition of the mediator term and assuming a linear form with equal slope for S . A similar model is then used for the mediator M . Based on our assumptions, indirect effects are given by $\bar{\delta}(a) = \gamma' \mu$ and direct effects are given by $\bar{\zeta}(a) = \gamma$ (Imai et al. 2010). As before, we treat arrival day as a random effect. Additionally, we excluded encounters with an undefined mediator (i.e., 787 visits without a test order associated), the ignored encounters are primarily psychiatric visits, visits associated with suicidal behavior, and patients with eye problems. Last, we can also calculate mediating effects for different levels of a moderator by including the moderator and its interactions with the indicator of split flow into the models at Equation 2 for M and Y as well as the interaction between the moderator and mediator for Y .

5 Results

5.1 Sample characteristics

The analyzed sample ($n = 21,570$ visits) is summarized in Table 2 divided by whether the patient arrived to the ED in the 3 hours before ($n = 9,965$) or 3 hours after ($n = 11,605$) the start time of the split flow model. Briefly, patients were an average of 49.2 (SD = 19.2) years of age and were predominately white (79.3%). Women visited the ED slightly more than men (54.7%), and a majority of patients had either commercial insurance (44.1%) or Medicare (30.1%). The four outcomes of interest exhibited reasonable variability for analysis: time to be roomed has an average of 13.4 minutes (SD = 19.3); time to disposition has an average of 3.9 hours (SD = 2.0 hours); 24.5% of visits were admitted to an inpatient hospital unit; and 11.9% of visits led to an ED revisit within 30 days after being discharged from the ED or hospital.

5.2 Does split flow shorten length of stay

Our primary RD analysis, which uses a 1 hour bandwidth, estimates that a split flow model significantly increases the average time to be roomed by 4.6 minutes (95% CI: [2.9, 6.2]) but significantly decreases average time to disposition decision after being roomed by an even larger margin of 14.4 (95% CI:[4.1, 24.7]) minutes (Table 3; these estimates are depicted in Appendix C). Thus, the overall reduction in length of stay is 9.8 minutes. We reach similar conclusions when changing the bandwidth to 1/2 hour, though the magnitude of estimates are larger: a split flow model significantly increases the average time to be roomed by 9.1 minutes (95% CI: [6.7, 11.4]) but significantly decreases average time to disposition by 20.4 (95% CI:[6.1, 34.7]) minutes. The overall reduction in length of stay, however, is similar at 11.3 minutes. Estimates for other bandwidths are reported in Appendix B. Taken together, these findings suggest that a split flow model does indeed shorten length of stay, as was hypothesized.

We performed additional analyses to investigate the the possibility of confounding. As we noted earlier, one possible confounder was the physician assigned to split flow, since certain physicians may be faster than others. To account for variation in physicians, we added assigned physician as a random effect to model 1 (Table 3). Compared to our primary estimates, accounting for physician variation leads to an estimated average time to be roomed that increases by a slightly smaller amount of 4.5 minutes (95% CI: [2.8, 6.1]) and an estimated average time to disposition decreased by a slightly bigger amount of 14.7 minutes (95% CI: [4.3, 25.0]). These results suggest that reduction in length of stay under a split flow model is not due to the physician assigned to split flow.

Another possible confounder is a change in shift of physician providers in the ED, since split flow coincides with a shift change. However, when we estimate the same model by replacing t_0 with the start/end hour of other shift changes, we do not find a significant effect of a shift change on time to be roomed and time to disposition (Table 4). That is,

Variable	3 hours before split flow n = 9,965		3 hours after split flow n = 11,605	
	Value	Missing	Value	Missing
Age in years, mean (SD)	49.5 (19.2)	0	48.9 (19.3)	0
Time to be roomed in minutes, mean (SD)	12.7 (20.1)	0	14.1 (18.7)	0
Time to disposition decision in hours, mean (SD)	3.9 (2.0)	0	3.8 (2.1)	0
Female, n (%)	5,407 (54.2)	0	6,404 (55.2)	0
Race and ethnicity, n (%)		0		0
White	7,904 (79.3)		9,221 (79.4)	
Black	1,044 (10.5)		1,263 (10.9)	
Hispanic/Latino	550 (5.5)		573 (4.9)	
Asian	279 (2.8)		331 (2.8)	
Other	80 (0.8)		82 (0.7)	
American Indian/Alaska Native	46 (0.5)		60 (0.5)	
Unknown	62 (0.6)		75 (0.7)	
Health insurance, N (%)		0		0
Commercial	4,460 (44.7)		5,050 (43.5)	
Medicare	2,980 (29.9)		3,506 (30.2)	
Medicaid/BadgerCare	1,344 (13.5)		1,713 (14.8)	
Self paid	425 (4.26)		426 (3.67)	
Unknown	756 (7.6)		910 (7.8)	
Chief complaint, n (%)		0		0
Abdominal pain	1,183 (11.9)		1,388 (11.9)	
Chest pain	837 (8.4)		823 (7.1)	
Dyspnea	525 (5.3)		647 (5.6)	
Fall	290 (2.9)		320 (2.7)	
Fever	171 (1.7)		205 (1.8)	
Other	6,959 (69.8)		8,222 (70.8)	
Admitted to hospital, n (%)	2,385 (23.9)	0	2,895 (24.9)	0
ED Revisit less than 30 days, n (%)	1,200 (12.0)	404 (4.0)	1,372 (11.8)	460 (3.9)

Table 2: Sample characteristics of ED visits that met inclusion criteria in the 3 hours before and after the start time of the split flow model.

Analysis	Time to be roomed	Time to disposition
RD with 1 hour bandwidth (primary)	4.6 (2.9, 6.2)	-14.4 (-24.7, -4.1)
Sensitivity analyses		
Changing bandwidth to 1/2 hour	9.1 (6.7, 11.4)	-20.4 (-34.7, -6.1)
Controlling for physician	4.5 (2.8, 6.1)	-14.7 (-25.0, -4.3)

Table 3: Estimates (95% confidence intervals) for average effects of the split flow model on time to be roomed and time to disposition decision after being roomed, in minutes.

confidence intervals contain zero for each start/end hour of each shift. These findings suggest that the reduction in LOS under a split flow model is not due to a shift change.

Outcome	Shift 1		Shift 2		Shift 3	
	7am	4pm	3pm	12pm	11pm	8am
Time to be roomed	-0.03 (-0.8, 0.8)	-0.7 (-1.6, 0.1)	0.7 (-0.1, 1.5)	0.0 (-2.9, 2.8)	-1.7 (-4.6, 1.1)	-0.3 (-0.1, 0.3)
Time to disposition	-4.0 (-23.3, 15.2)	9.7 (-1.4, 20.8)	-5.3 (-16.1, 5.5)	3.3 (-11.8, 18.5)	-2.9 (-17.0, 11.2)	9.6 (-7.1, 26.4)

Table 4: Estimates (95% confidence intervals) for average effects of the split flow model on outcomes when the forcing variable is centered at the start/end of shift changes, in minutes.

5.3 When does split flow shorten length of stay (moderation analyses)

We next investigated whether the split flow was more or less effective depending on the operational context of the ED (i.e., congestion, day of the week, physician workload, and start time of the split flow model). When adding, one at a time, each possible moderator and their interaction with the split flow indicator to the model, we found that the start time of the split flow model did not yield significant interaction terms in the model of time to be roomed ($P = 0.08$) or in the model of time to disposition ($P = 0.48$). Therefore, the split flow start time is not a significant moderator for either time to be roomed or time to disposition decision after being roomed. Similarly, day of week ($P = 0.06$) nor physician workload ($P = 0.07$) yielded significant interaction terms in the model of time to disposition. Therefore, day of week nor physician workload appear to moderate the effect of split flow on time to disposition.

By contrast, congestion ($P < 0.001$), day of week ($P = 0.001$) and physician workload ($P < 0.001$) did yield significant interactions for time to be roomed. The only significant moderator for time to disposition was congestion ($P = 0.01$). Thus, the effectiveness of the split flow model does appear to be moderated by congestion, day of week, and physician workload. Upon closer examination, we find that the split flow model increases average time to be roomed during the low congestion level, and to a lesser degree, during the middle congestion level (Figure 4). However, the split flow model actually decreases average time to be roomed during the high congestion level. This alone might suggest that split flow is more effective during high congestion levels, but time to disposition tells a different story. In this case, we find that the split flow model decreases average time to disposition during the low congestion and middle congestion levels. Yet when we take both time to be roomed and time to disposition after being roomed into consideration, these findings suggest that split flow is especially effective at low and medium congestion levels.

We find that physician workload moderates the relationship between split flow and time to be roomed/disposition in a similar way as congestion (Figure 4). We find that split flow increases the time to be roomed but to a greater degree decreases the time to disposition during low physician workload levels. These findings suggest that split flow decreases LOS during low congestion levels. On the other hand, we find that split flow increases time to be roomed while not impacting time to disposition when physician workload is at medium levels. These results taken together suggest that split flow increases ED LOS during medium physician workload levels. We find no significant evidence of split flow either increasing or decreasing time to be roomed or time to disposition for the highest tertile of physician workload.

As for day of the week, the average effects of split flow on time to be roomed and on time to disposition are similar across days of the week (note the overlapping confidence intervals in Figure 4), with a few exceptions. Under a split flow model, average time to be roomed increases more on Tuesday and less on Thursday than other days, whereas average time to disposition decreases less on Monday. Overall, split flow appears to be most effective on Thursday and least effective on Monday. We suspect that this variation is largely due to differences in how busy the ED is on different days, which we explore next.

Since these moderators may relate to each other, we wanted to see which might be driving the moderation of average effects. We therefore simultaneously added congestion, day of the week, physician workload, and split flow start hours and their pairwise interactions with the split flow indicator to the model. From this final model, we again find that split flow start hours is not a significant moderator ($P = 0.08$ for time to be roomed and $P = 0.40$ for time

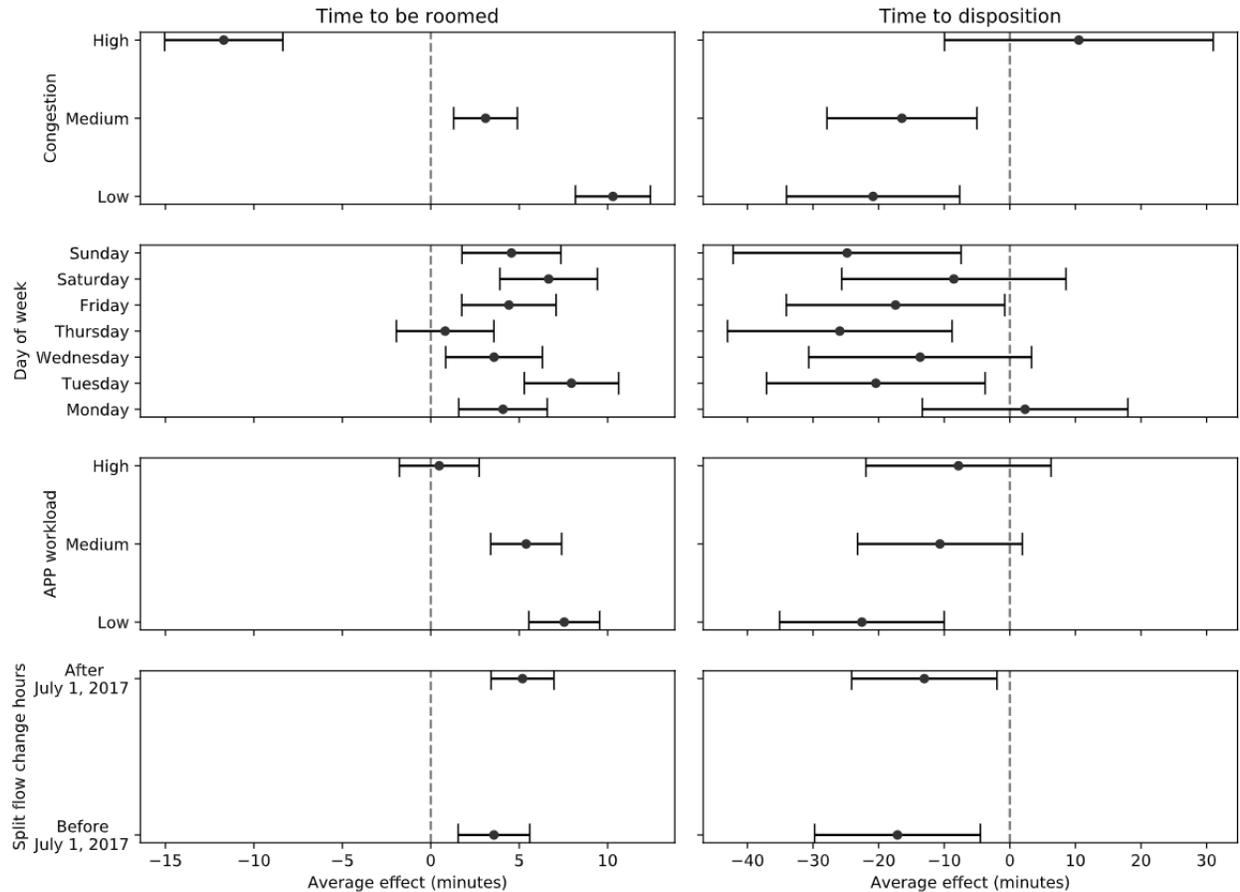

Figure 4: Moderation analyses for continuous outcomes. Average effect (in minutes) of split flow on time to be roomed (left) and time to disposition after being roomed (right) during each level of moderator variables: congestion, day of week, physician workload and split flow change of start hours.

to disposition). Physician workload, which was a significant moderator when considered in isolation, did not yield significant interaction terms with either time to be roomed ($P = 0.17$, Table 5) or time to disposition ($P = 0.85$). Unlike physician workload, congestion ($P < 0.001$) and the day of week ($P = 0.007$) remain an important moderator of time to be roomed yielding highly significant interaction terms. However, neither congestion ($P = 0.06$) nor day of week ($P = 0.14$) yielded significant interactions with time to disposition. These findings suggests that regardless of multiple moderator variables being significant individually, the most important moderator of LOS is congestion followed by day of week. Specifically, the time to be roomed is moderated by congestion and day of week. Split flow, for example, increases the time to be roomed on Tuesdays (the confidence intervals for all days contain zero except Tuesday). Most notably, split flow is most effective during low and medium congestion levels, which is contrary to our original hypothesis that split flow would be most effective during high congestion levels.

5.4 Does split flow have downstream consequences

The previous section estimated an overall decrease in average length of stay. This section explores whether this improvement in operational outcomes is at the cost of downstream consequences. In particular, we evaluate the impact of split flow on admission and revisit rates. The results in Table 6 suggest that a split flow model significantly reduces the probability of admission by 5.8% (95% CI: [2.3%, 9.4%]) but does not have a significant effect on 30-day revisit rates. Changing the bandwidth to 1/2 hour yields similar conclusions, i.e. split flow leads to a significant decrease in admission rates but no significant change in 30-day revisit rates (Table 6). Like we did for time to be roomed and time

Moderator	Level	Time to be roomed		Time to disposition	
		Interaction (95% CI)	<i>P</i>	Interaction (95% CI)	<i>P</i>
Congestion	Medium	-8.3 (-10.8, -5.9)	< 0.001	1.7 (-13.5, 16.8)	0.06
	High	-23.9 (-28.0, -19.8)		27.1 (1.4, 52.7)	
Day of week	Monday	2.0 (-1.2, 5.1)	0.007	18.9 (-1.5, 39.3)	0.14
	Tuesday	4.1 (0.8, 7.4)		-1.2 (-22.2, 19.7)	
	Wednesday	-0.2 (-3.5, 3.0)		7.8 (-13.2, 28.8)	
	Thursday	-2.2 (-5.5, 1.1)		-5.4 (-26.7, 16.0)	
	Friday	0.3 (-2.9, 3.5)		2.0 (-18.7, 22.7)	
	Saturday	0.8 (-2.4, 4.1)		16.0 (-4.7, 36.6)	
Physician workload	Medium	-6.1 [-8.3, -4.0]	0.17	4.0 (-10.3, 18.3)	0.85
	High	-5.8 (-9.8, -1.9)		1.8 (-17.1, 20.7)	
Split flow start hour	After July 1, 2017	-1.7 (-3.5, 0.2)	0.08	5.0 (-6.7, 16.7)	0.40

Table 5: Estimates for the coefficients of the interaction terms between split flow and moderator variables for the regression model including all moderators, and *P* values for the null hypothesis testing whether the interactions of a given moderator are zero simultaneously.

to disposition, we also explored whether the estimates are confounded by assigned physician or shift changes. For the former, we obtained similar results after adding the physician as a random effect (Table 6). For example, a split flow model reduces the admission rate by 5.6% (95% CI: [2.0%, 9.2%]), whereas the effect on the probability of revisit remains not significant. Similarly, the confidence intervals for each RD estimate when the forcing variable is centered at the start/end of shifts changes are not significant (i.e., contain zero) (Table 7), which suggests that a shift change is not sufficient to explain that impact that split flow has on admission rates. As before, estimates for other bandwidths are reported in Appendix B, discontinuities in estimates are depicted in Appendix C, and the moderation analyses for downstream outcomes are reported in Appendix D.

Analysis	Admission decision	30-day revisit
RD with 1 hour bandwidth (primary)	-5.8 (-9.4, -2.3)	-0.8 (-3.6, 1.9)
	Sensitivity analyses	
Changing bandwidth to 1/2 hour	-7.9 (-12.8, -3.0)	-1.6 (-5.4, 2.2)
Controlling for physician	-5.6 (-9.2, -2.0)	-0.7 (-3.5, 2.0)

Table 6: Estimates (95% confidence intervals) for average effects of the split flow model on admission decision and 30-day revisits, in %.

Outcome	Shift 1		Shift 2		Shift 3	
	7am	4pm	3pm	12pm	11pm	8am
Admission decision	-1.7 (-7.8, 4.4)	0.9 (-4.8, 2.9)	-1.7 (-5.5, 2.1)	3.4 (-1.5, 8.4)	-2.0 (-6.3, 2.4)	3.4 (-2.0, 8.7)
30 day revisit	-1.0 (-6.6, 4.6)	-0.6 (-3.8, 2.6)	-0.4 (-3.5, 2.7)	5.3 (0.6, 10.1)	-3.5 (-7.6, 0.6)	-0.7 (-5.4, 3.9)

Table 7: Estimates (95% confidence intervals) for average effects of the split flow model on admissions and 30 day revisits when the forcing variable is centered at the start/end of shift changes, in %.

5.5 Why does split flow shorten length of stay (mediation analysis)

Given that split flow may be reducing time to disposition, we now explore why that might be, especially as it relates to treating low-needs patients in a vertical area vs. triage and early task initiation by a physician. We analyzed two variables, time to first order of a test (e.g., electrocardiogram, radiology) or medication and time to be roomed, that might mediate the relationship between split flow and time to disposition. We find that a decrease of 2.0 minutes (95% CI: [0.3, 4.1]) in time to disposition from split flow can be attributed to quicker test and medication orders under split flow compared with the traditional model (Table 8). When broken down by congestion level, this indirect effect of split flow via time to first order is stronger at higher congestion levels, e.g. 2.8 minutes for the high congestion tertile. In other words, providers are able to initiate medication and test orders earlier under split flow which decreases time to disposition, especially in periods of high congestion. So, early task initiation by a physician appears to partly explain why split flow is effective.

The other mediator, time to be roomed, brings less clarity about why split flow is effective. Our estimates suggest that a slight decrease of 0.5 minutes (95% CI: [0.002, 0.8] minutes) in time to disposition can be attributed to slower time to be roomed under split flow compared to traditional flow (Table 8). One possible explanation for why a slower time to be roomed under split flow might contribute to faster time to disposition is that the physician spends time under split flow to initiate treatment (including medication and test orders) before patients are officially roomed. While perhaps plausible at medium congestion levels, this explanation seems to fall apart at low and high congestion levels. At low congestion levels, slower time to be roomed under split flow causes a slower — not faster — time to disposition, resulting in a non-significant increase of 1.5 minutes (95% CI: [-2.6, 7.3] minutes) in time to disposition attributed to slower time to be roomed under split flow. Meanwhile at high congestion levels, split flow causes a faster — not slower — time to be roomed, suggesting the physician assigned to triage is not spending extra time to initiate care.

An alternative explanation is that the physician assigned to triage adjusts how they stream patients according to congestion level, which in turn changes how patients are handled by physicians downstream in the ED. At high congestion, such an explanation would mean that patients are more quickly streamed to rooms (or the vertical area) by the physician at triage under a split flow model but are not treated at a faster rate, causing a slower time to disposition and a significant increase of 3.2 minutes (95% CI: [0.7, 7.3] minutes) in time to disposition from the faster time to be roomed under split flow. At low congestion, this explanation would mean that patients are streamed more slowly to a room by the physician at triage than a nurse at triage and that patients who are moved to a room more slowly are also slower to receive a disposition decision. Thus, these findings suggest that the physician at triage engages in patient streaming to modulate the rate at which patients are roomed and treated, but it remains unclear if patient streaming, unlike early test or medication orders, helps to speed up patient flow in the ED.

Mediator	Group	Direct effect	Indirect effect
Time to first order	All	-11.9 (-23.9, -2.0)	-2.0 (-4.1, -0.3)
	Low congestion	-19.0 (-32.1, -7.3)	-1.6 (-5.5, 0.4)
	Medium congestion	-13.4 (-24.4, -13.5)	-2.4 (-4.1, -0.6)
	High congestion	15.8 (-1.12, 39.24)	-2.8 (-7.0, 1.6)
Time to be roomed	All	-13.3 (-14.8, -3.6)	-0.5 (-0.8, -0.002)
	Low congestion	-19.0 (-33.1, -8.0)	1.5 (-2.6, 7.3)
	Medium congestion	-15.4 (-29.1, -3.4)	-0.5 (-1.2, -0.02)
	High congestion	8.4 (-9.1, 27.5)	3.2 (0.7, 7.3)

Table 8: Estimates (95% confidence intervals) for the average direct effect and average indirect effect of the split flow model on time to disposition mediated the time to first order and time to be roomed per congestion level, in minutes.

6 Discussion

In this paper, we evaluated a split flow model at an ED in a large tertiary academic hospital using electronic health records ($n = 21,570$). Split flow models, in which a provider rather than a nurse handles triage, have been proliferating in recent years as a possible strategy for improving ED patient flow and other operational metrics without sacrificing patient safety. The present work is based on the premise that to determine whether or not such interventions should be continued, adapted, or more widely adopted by hospitals, we should understand their impact on operational metrics and patient outcomes from places where split flow models have been implemented. We hypothesized that a split flow model would lead to an improvement on patient flow, but no impact on downstream patients outcomes.

We estimated average treatment effects of a split flow vs. traditional nurse-led triage flow model of the ED on time to be roomed, time to disposition decision after being roomed, the admission decision, and revisit to the ED within 30 days of discharge. These outcomes measure patient flow, decision-making, and subsequent patients outcomes. Estimates were recovered from a regression discontinuity (RD) design. We find a small increase in time to be roomed but a greater reduction in time to disposition. Taken together, they suggest a moderate reduction in average length of stays per patient. RD design, for example, found a split flow model leads to an estimated increase in average time to be roomed of 4.6 minutes (95% CI: [2.9, 6.2] minutes) and a reduction in average time to disposition of 14.4 minutes (95% CI: [4.1, 24.7] minutes). Although our findings support our hypothesis that a split flow model improves patient flow, we had also hypothesized that a split flow model would have not have downstream consequences to admission rates or ED revisits. As hypothesized, we find no evidence of a significant impact of split flow on revisit rates. However, our findings suggest a split flow model may decrease ED admissions by 5.9% (95% CI: [2.3%, 9.5%]). Since admitting a patient is one of the most costly decisions made in healthcare, then fewer admission rates may be viewed as an unexpected benefit of split flow. In short, split flow model appears to reduce average lengths of stay and admission rates, without causing an increase in ED revisits.

For hospital managers who might consider implementing a split flow model, it is important to determine when a split flow model might be especially effective. Congestion appears to be the most important factor modifying effectiveness. We conjectured that split flow would be less effective during periods of high congestion, considering that physicians already speed up care during periods of high congestion. Indeed, we found that split flow is most effective at reducing length of stay during periods of low congestion and relatively ineffective during periods of high congestion.

When congestion is low, patients spend more time waiting for a room under split flow vs. traditional flow, which provides the physician assigned to triage an opportunity to initiate treatment for patients. Once roomed, physicians could reach a disposition decision more quickly under split flow, perhaps because of the early initiation of care. The speed-up in time to disposition was greater than the delay in being roomed, leading to an overall reduction in length of stay. When congestion is high, however, patients spend less time waiting for a room under split flow vs. traditional flow. Here, we suspect the physician in triage is able to quickly stream low-needs patients to the vertical area, freeing up rooms for other patients. However once roomed, the time to disposition is slower under a split flow model, perhaps because patients are still competing for resources even in the vertical area. In the end, the gain in time to be roomed is almost equal to the loss in time to disposition when congestion is high, leading to a negligible net gain. Regardless, these results point to the use of split flow to improve patient flow during periods of low and medium congestion.

We acquired further empirical support for these insights using mediation analysis. This analysis suggested that the impact of split flow on time to disposition is partly mediated by the ability of physicians to order tests and medication more quickly when compared with the traditional nurse-led triage. Put simply, split flow led to early task initiation, which allowed a disposition decision to be reached sooner. Mediation analysis also suggested that, at high congestion levels, the impact of split flow time on time to disposition is partly mediated by time to be roomed. In this case, split flow led to faster time to be roomed, which led to slower time to disposition. So while the physician at triage appears to move patients more rapidly to the vertical area at high congestion levels, it is not clear if treating patients in this area yields net gain in length of stay.

Considering that estimates are sensitive to modeling assumptions, it is important to search for evidence of violations of our assumptions in an effort to strengthen the validity of these estimates. One concern is that split flow coincides with other operational changes, notably a change in the physician shift and the assignment of a physician, which might confound the relationship between split flow itself and patient outcomes. However, accounting for physician assignment had a minimal impact on our estimates. Further, shift changes for all physicians, other than split flow, did not seem to affect patient outcomes significantly. Thus, we believe that the effects can be largely attributed to the split flow model itself. Another concern is our key assumption about continuous potential outcomes. To that end, we investigated bandwidth selection, which we found did change the magnitude of our estimates but not our conclusions. We also performed graphical analysis, but did not observe a considerable amount of patients accumulating on one side of the cutoff. This fact favors the assumption of continuous potential outcomes. The graphical analysis on the covariates included in the regression model, namely, age, race, sex and chief complaint suggest that they are all continuous at the start of the split flow model except for a possible discontinuity in the average age of patients arriving before and after the cutoff. So, we would caution the reader when interpreting estimates as one does all attempted causal inferences made from observational data rather than from a randomized control trial, before making recommendations for continuing, adapting, and/or adopting split flow models.

For example, even if a split flow model leads to an overall improvement in patient flow, a hospital administrator may wish to consider other factors when deciding whether to implement a split flow model. One consideration is patient preference. More specifically, managers might want to implement split flow when congestion is high, even if split flow does not lead to an overall reduction in length of stay, since patients may strongly prefer waiting in an ED treatment room over waiting in the ED waiting room. Another consideration is whether a decrease in average length of stay of about 8-10 minutes is sufficient in size to justify a change to how triage is implemented. We note that 8-10 minutes per patient may seem like a small reduction, but when accumulated over how many patients are seen over several hours, it may provide meaningful time savings to providers and hospital managers. For example, our partner hospital roughly sees 163 patients per day on average. A benefit of the present study is that the provided estimates could be used as input for a cost-benefit analysis of if and when to adapt, continue, or adopt a split flow model. In particular, hospital managers and care providers need to weigh the benefit of reducing average ED length of stay by some time unit against the potential additional cost of hiring an additional provider.

To our knowledge, we are the first apply causal inference methods, notably an RD analysis, to evaluate average treatment effects of split flow model on patient flow and patient outcomes. Prior empirical support for split flow models have focused on using more traditional regression methods to analyze the impact of split flow models on decreased length of stays ([Subash et al. 2004](#), [Medeiros et al. 2008](#), [Han et al. 2010](#), [Soremekun et al. 2012](#), [Burström et al. 2012](#), [Burström et al. 2016](#)). Meanwhile, empirical support for sub-components of split flow models, i.e., physician-triage and treating low-needs patients in a vertical area, have focused on matching strategies to adjust for measured confounding ([Russ et al. 2010](#), [Partovi et al. 2001](#), [Traub et al. 2016](#), [Considine et al. 2008](#)). Because patients are not randomized to the patient flow model, traditional regression and matching methods can be biased by unmeasured differences between intervention groups (split flow vs. traditional flow). RD analysis benefits from its potential to adjust for both measured and unmeasured confounding. We thus believe findings from a RD analysis should serve to strengthen the support for implementing a split flow model.

In addition, the intervention of interest (i.e. split flow model) had the interesting feature of being implemented over a specific period of time each day of the week. This feature does not fit within a sharp RD design, which has one threshold for determining whether or intervention condition (as opposed to a threshold for each day). To place our intervention into a RD framework, we centered each arrival at the start of split flow and aggregated all the visits in our dataset across days.

There are several limitations to consider. First, we cannot test the continuity of potential outcomes purely from observational data. To alleviate this, we performed graphical analysis to search for evidence of a discontinuous distribution of arrivals near the cutoff that could invalidate our results. Second, we cannot generalize our findings to hours outside the 1 hour bandwidth around the start of split flow. The split flow may be effective in reducing average length of stay just at the start but in fact increase time to disposition several hours after its implementation. Indeed, we report an RD

analysis in the Appendix applied to the end time of split flow and find that split flow is less effective in reducing length of stay at the end hour.

In addition, the aggregation of observations across days helps increase the RD sample size but at cost of, possibly, hiding seasonal factors that influence patient arrival processes. Another limitation is that outside environmental factors may have influenced the effectiveness of the split flow. These include a time-lag until split flow protocols were standardized after its initial implementation. Further, certain choices made in data analysis may be considered limitations. Confidence intervals may have understated uncertainty in estimates. We defined ED revisits based on time of discharge from hospital for admitted patients and time of ED discharge for discharged patients, but alternatively the latter time could be used for both. Last, our sample is relatively homogeneous, limiting the generalizability of our findings to more diverse populations.

In summary, our work extends our understanding of the benefits from ED split flow models. Finding overall reductions in ED length of stay without negatively impacting admission decisions and revisits may support the adoption (or adaption) of split flow models. Our results do not support a change in current clinical practice, especially in light of the considerations mentioned above; rather they add to a growing body of literature suggesting that split flow models may yield benefits, and point to the necessity of further assessment to identify specific criteria to guide the adoption of such models. Lastly, our analysis is made possible with an approach which can be used to assess other interventions that are administered at specific times each day.

References

- Stephen R Pitts, Emily R Carrier, Eugene C Rich, and Arthur L Kellermann. Where americans get acute care: increasingly, it's not at their doctor's office. *Health Affairs*, 29(9):1620–1629, 2010. [2](#)
- Stephen R Pitts, Jesse M Pines, Michael T Handrigan, and Arthur L Kellermann. National trends in emergency department occupancy, 2001 to 2008: effect of inpatient admissions versus emergency department practice intensity. *Annals of Emergency Medicine*, 60(6):679–686, 2012. [2](#)
- Daniel M Fatovich, Yusuf Nagree, and Peter Sprivulis. Access block causes emergency department overcrowding and ambulance diversion in perth, western australia. *Emergency Medicine Journal*, 22(5):351–354, 2005. [2](#)
- Jonathan S Olshaker and Niels K Rathlev. Emergency department overcrowding and ambulance diversion: the impact and potential solutions of extended boarding of admitted patients in the emergency department. *The Journal of Emergency Medicine*, 30(3):351–356, 2006. [2](#)
- Robert W Derlet and John R Richards. Ten solutions for emergency department crowding. *Western Journal of Emergency Medicine*, 9(1):24, 2008. [2](#)
- Marion R Sills, Diane Fairclough, Daksha Ranade, and Michael G Kahn. Emergency department crowding is associated with decreased quality of care for children. *Pediatric Emergency Care*, 27(9):837–845, 2011. [2](#)
- Stephen Liu, Cherri Hobgood, and Jane H Brice. Impact of critical bed status on emergency department patient flow and overcrowding. *Academic Emergency Medicine*, 10(4):382–385, 2003. [2](#)
- Melissa L McCarthy, Scott L Zeger, Ru Ding, Scott R Levin, Jeffrey S Desmond, Jennifer Lee, and Dominik Aronsky. Crowding delays treatment and lengthens emergency department length of stay, even among high-acuity patients. *Annals of Emergency Medicine*, 54(4):492–503, 2009. [2](#)
- Pedro de Araujo, Maroula Khraiche, and Andrea Tukan. Does overcrowding and health insurance type impact patient outcomes in emergency departments? *Health Economics Review*, 3(1):25, 2013. [2](#)
- Drew B Richardson et al. Increase in patient mortality at 10 days associated with emergency department overcrowding. *Medical Journal of Australia*, 184(5):213–216, 2006. [2](#)
- Peter C Sprivulis, Julie-Ann Da Silva, Ian G Jacobs, George A Jelinek, and Amanda RL Frazer. The association between hospital overcrowding and mortality among patients admitted via western australian emergency departments. *Medical Journal of Australia*, 184(5):208–212, 2006. [2](#)
- Jane McCusker, Alain Vadeboncoeur, Jean-Frédéric Lévesque, Antonio Ciampi, and Eric Belzile. Increases in emergency department occupancy are associated with adverse 30-day outcomes. *Academic Emergency Medicine*, 21(10):1092–1100, 2014. [2](#)

- Jillian K Gorski, Robert J Batt, Erkin Otles, Manish N Shah, Azita G Hamedani, and Brian W Patterson. The impact of emergency department census on the decision to admit. *Academic Emergency Medicine*, 24(1):13–21, 2017. [2](#), [4](#)
- Loren De Freitas, Steve Goodacre, Rachel O’Hara, Praveen Thokala, and Seetharaman Hariharan. Interventions to improve patient flow in emergency departments: an umbrella review. *Emergency Medicine Journal*, 35(10):626–637, 2018. [2](#)
- Jennifer L Wiler, Mustafa Ozkaynak, Kelly Bookman, April Koehler, Robert Leeret, Jenny Chua-Tuan, Adit A Ginde, and Richard Zane. Implementation of a front-end split-flow model to promote performance in an urban academic emergency department. *The Joint Commission Journal on Quality and Patient Safety*, 42(6):271–AP4, 2016. [2](#)
- Robert J Batt and Christian Terwiesch. Early task initiation and other load-adaptive mechanisms in the emergency department. *Management Science*, 63(11):3531–3551, 2017. [2](#), [3](#), [4](#), [10](#)
- Michael Freeman, Nicos Savva, and Stefan Scholtes. Gatekeepers at work: An empirical analysis of a maternity unit. *Management Science*, 63(10):3147–3167, 2017. [2](#), [3](#)
- Stephan Russ, Ian Jones, Dominik Aronsky, Robert S Dittus, and Corey M Slovis. Placing physician orders at triage: the effect on length of stay. *Annals of emergency medicine*, 56(1):27–33, 2010. [2](#), [3](#), [4](#), [23](#)
- Renata Konrad, Kristine DeSotto, Allison Grocela, Patrick McAuley, Justin Wang, Jill Lyons, and Michael Bruin. Modeling the impact of changing patient flow processes in an emergency department: Insights from a computer simulation study. *Operations Research for Health Care*, 2(4):66–74, 2013. [2](#), [4](#)
- John S Garrett, Colyn Berry, Hao Wong, Huanying Qin, and Jeffery A Kline. The effect of vertical split-flow patient management on emergency department throughput and efficiency. *The American Journal of Emergency Medicine*, 2018. [2](#)
- Beth A Pierce and Denise Gormley. Are split flow and provider in triage models in the emergency department effective in reducing discharge length of stay? *Journal of Emergency Nursing*, 42(6):487–491, 2016. [2](#)
- Rajiv Arya, Grant Wei, Jonathan V McCoy, Jody Crane, Pamela Ohman-Strickland, and Robert M Eisenstein. Decreasing length of stay in the emergency department with a split emergency severity index 3 patient flow model. *Academic Emergency Medicine*, 20(11):1171–1179, 2013. [2](#)
- Gregory Wallingford Jr, Nikita Joshi, Patrice Callagy, Jamie Stone, Ian Brown, and Sam Shen. Introduction of a horizontal and vertical split flow model of emergency department patients as a response to overcrowding. *Journal of Emergency Nursing*, 44(4):345–352, 2018. [2](#)
- Brian W Patterson, JR Johnson, Michael Ward, Azita G Hamedani, and BR Sharp. Effect of a split-flow physician in triage model on abdominal ct ordering rate and yield. *American Journal of Emergency Medicine*, (just-accepted), 2020. [2](#)
- Guido W Imbens and Thomas Lemieux. Regression discontinuity designs: A guide to practice. *Journal of Econometrics*, 142(2):615–635, 2008. [3](#), [5](#), [13](#), [27](#)
- David S Lee and Thomas Lemieux. Regression discontinuity designs in economics. *Journal of Economic Literature*, 48(2):281–355, 2010. [3](#), [5](#), [13](#), [14](#), [27](#), [28](#)
- Ward Whitt and Xiaopei Zhang. Forecasting arrivals and occupancy levels in an emergency department. *Operations Research for Health Care*, 2019. [3](#), [13](#)
- Soroush Saghafian, Garrett Austin, and Stephen J Traub. Operations research/management contributions to emergency department patient flow optimization: Review and research prospects. *IIE Transactions on Healthcare Systems Engineering*, 5(2):101–123, 2015. [3](#)
- Sirous N Partovi, Brian K Nelson, Earl D Bryan, and Matthew J Walsh. Faculty triage shortens emergency department length of stay. *Academic Emergency Medicine*, 8(10):990–995, 2001. [3](#), [4](#), [23](#)
- Stephen J Traub, Adam C Bartley, Vernon D Smith, Roshanak Didehban, Christopher A Lipinski, and Soroush Saghafian. Physician in triage versus rotational patient assignment. *The Journal of emergency medicine*, 50(5):784–790, 2016. [3](#), [4](#), [23](#)
- Soroush Saghafian, Wallace J Hopp, Mark P Van Oyen, Jeffrey S Desmond, and Steven L Kronick. Complexity-augmented triage: A tool for improving patient safety and operational efficiency. *Manufacturing & Service Operations Management*, 16(3):329–345, 2014. [3](#)
- Soroush Saghafian, Wallace J Hopp, Seyed MR Iravani, Yao Cheng, and Daniel Diermeier. Workload management in telemedical physician triage and other knowledge-based service systems. *Management Science*, 64(11):5180–5197, 2018. [3](#)
- Michael Freeman, Susan Robinson, and Stefan Scholtes. Gatekeeping, fast and slow: An empirical study of referral errors in the emergency department. *Management Science*, 2020. [3](#)
- Soroush Saghafian, Wallace J Hopp, Mark P Van Oyen, Jeffrey S Desmond, and Steven L Kronick. Patient streaming as a mechanism for improving responsiveness in emergency departments. *Operations Research*, 60(5):1080–1097, 2012. [3](#)

- Julie Considine, Matthew Kropman, Erin Kelly, and Craig Winter. Effect of emergency department fast track on emergency department length of stay: a case-control study. *Emergency Medicine Journal*, 25(12):815–819, 2008. [3](#), [4](#), [23](#)
- Gabriel Zayas-Cabán, Jingui Xie, Linda V Green, and Mark E Lewis. Dynamic control of a tandem system with abandonments. *Queueing Systems*, 84(3-4):279–293, 2016. [4](#)
- Gabriel Zayas-Caban, Jingui Xie, Linda V Green, and Mark E Lewis. Policies for physician allocation to triage and treatment in emergency departments. *IIESE Transactions on Healthcare Systems Engineering*, 9(4):342–356, 2019. [4](#)
- Michael F Kamali, Tolga Tezcan, and Ozlem Yildiz. When to use provider triage in emergency departments. *Management Science*, 65(3):1003–1019, 2018. [4](#)
- F Subash, F Dunn, B McNicholl, and J Marlow. Team triage improves emergency department efficiency. *Emergency Medicine Journal*, 21(5):542–544, 2004. [4](#), [23](#)
- Deborah J Medeiros, Eric Swenson, and Christopher DeFlitch. Improving patient flow in a hospital emergency department. In *Proceedings of the 40th Conference on Winter Simulation*, pages 1526–1531. Winter Simulation Conference, 2008. [4](#), [23](#)
- Jin H Han, Daniel J France, Scott R Levin, Ian D Jones, Alan B Storrow, and Dominik Aronsky. The effect of physician triage on emergency department length of stay. *The Journal of Emergency Medicine*, 39(2):227–233, 2010. [4](#), [23](#)
- O. A. Soremekun, R. Capp, P. D. Biddinger, B. A. White, Y. Chang, S. B. Carignan, and Brown David F.M. Impact of physician screening in the emergency department on patient flow. *The Journal of Emergency Medicine*, 43(3):509 – 515, September 2012. [4](#), [23](#)
- L. Burström, M. Nordberg, G. Örnung, M. Castrón, T. Wiklund, M.-L. Engström, and M. Enlund. Physician-led team triage based on lean principles may be superior for efficiency and quality? a comparison of three emergency departments with different triage models. *Scandinavian Journal of Trauma, Resuscitation and Emergency Medicine*, 20(1):1–10, 2012. [4](#), [23](#)
- Lena Burström, Marie-Louise Engström, Maaret Castrén, Tony Wiklund, and Mats Enlund. Improved quality and efficiency after the introduction of physician-led team triage in an emergency department. *Uppsala Journal of Medical Sciences*, 121(1):38–44, 2016. [4](#), [23](#)
- Donald L Thistlethwaite and Donald T Campbell. Regression-discontinuity analysis: An alternative to the ex post facto experiment. *Journal of Educational Psychology*, 51(6):309, 1960. [5](#)
- Jinyong Hahn, Petra Todd, and Wilbert Van der Klaauw. Identification and estimation of treatment effects with a regression-discontinuity design. *Econometrica*, 69(1):201–209, 2001. [5](#), [12](#)
- Douglas Almond and Joseph J Doyle. After midnight: A regression discontinuity design in length of postpartum hospital stays. *American Economic Journal: Economic Policy*, 3(3):1–34, 2011. [5](#)
- Jerzy S Neyman. On the application of probability theory to agricultural experiments. essay on principles. section 9. *Annals of Agricultural Sciences*, 10:1–51, 1923. [7](#)
- Donald B Rubin. Estimating causal effects of treatments in randomized and nonrandomized studies. *Journal of Educational Psychology*, 66(5):688, 1974. [7](#)
- James Robins. A new approach to causal inference in mortality studies with a sustained exposure period—application to control of the healthy worker survivor effect. *Mathematical Modelling*, 7(9-12):1393–1512, 1986. [7](#)
- Kimberly D Keith, Joseph J Bocka, Michael S Kobernick, Ronald L Krome, and Michael A Ross. Emergency department revisits. *Annals of Emergency Medicine*, 18(9):964–968, 1989. [7](#)
- Amber K Sabbatini, Keith E Kocher, Anirban Basu, and Renee Y Hsia. In-hospital outcomes and costs among patients hospitalized during a return visit to the emergency department. *Journal of the American Medical Association*, 315(7):663–671, 2016. [7](#)
- Shari J Welch. *Quality matters: solutions for a safe and efficient emergency department*. Joint Commission Resources, 2009. [7](#)
- Kristin L Rising, Kevin A Padrez, Meghan O’Brien, Judd E Hollander, Brendan G Carr, and Judy A Shea. Return visits to the emergency department: the patient perspective. *Annals of Emergency Medicine*, 65(4):377–386, 2015. [7](#)
- John Cheng, Amita Shroff, Nagma Khan, and Shabnam Jain. Emergency department return visits resulting in admission: do they reflect quality of care? *American Journal of Medical Quality*, 31(6):541–551, 2016. [7](#)
- Bradley D Shy, George T Loo, Tina Lowry, Eugene Y Kim, Ula Hwang, Lynne D Richardson, and Jason S Shapiro. Bouncing back elsewhere: multilevel analysis of return visits to the same or a different hospital after initial emergency department presentation. *Annals of Emergency Medicine*, 71(5):555–563, 2018. [7](#)
- James W Davis, Ronald Y Fujimoto, Henry Chan, and Deborah T Juarez. Identifying characteristics of patients with low urgency emergency department visits in a managed care setting. *Managed Care*, 19(10):38–44, 2010. [7](#)

- Miguel A Hernan and James M Robins. *Causal inference: what if*. Boca Raton: Chapman & Hall/CRC, 2020. 7
- Diwas Singh Kc. Does multitasking improve performance? evidence from the emergency department. *Manufacturing & Service Operations Management*, 16(2):168–183, 2014. 10
- Hummy Song, Anita L Tucker, and Karen L Murrell. The diseconomies of queue pooling: An empirical investigation of emergency department length of stay. *Management Science*, 61(12):3032–3053, 2015. 10
- Trang Quynh Nguyen, Ian Schmid, and Elizabeth A Stuart. Clarifying causal mediation analysis for the applied researcher: Defining effects based on what we want to learn. *Psychological Methods*, 2020. 10
- Kosuke Imai, Luke Keele, and Dustin Tingley. A general approach to causal mediation analysis. *Psychological methods*, 15(4):309, 2010. 10, 15, 16
- Andrew Gelman and Guido Imbens. Why high-order polynomials should not be used in regression discontinuity designs. *Journal of Business & Economic Statistics*, 37(3):447–456, 2019. 13
- Sander Greenland, James M Robins, Judea Pearl, et al. Confounding and collapsibility in causal inference. *Statistical Science*, 14(1):29–46, 1999. 13
- William C Horrace and Ronald L Oaxaca. Results on the bias and inconsistency of ordinary least squares for the linear probability model. *Economics Letters*, 90(3):321–327, 2006. 13
- Avishek Choudhury and Estefania Urena. Forecasting hourly emergency department arrival using time series analysis. *British Journal of Healthcare Management*, 26(1):34–43, 2020. 14

Appendix A Graphical Analysis

Following [Imbens and Lemieux \(2008\)](#) and [Lee and Lemieux \(2010\)](#) for RD designs, we present several plots to look for glaring violations of the Continuity Assumption 2 and to confirm the possibility of a non-zero average effect of the split flow model on outcomes. Figure 5 is a histogram of arrival times for the entire sample (Panel A) and the 1 hour bandwidth (Panel B) used in the RD analysis. For the figure in Panel A, non-overlapping bins around the cutoff of sizes of 1 (blue), 2 (orange) and 3 (green) hours were used. For the figure in Panel B, non-overlapping bins of 15 minutes were used. These histograms show jumps near the start of split flow that are not substantially larger than any other time of day. We also do not see any notable accumulation of patients before and after the start of split flow. For example, the number of patients one hours before and one after the split flow model start time was 3590 and 4215 respectively across the RD sample. These findings do not suggest that patients are manipulating their arrival times to receive a certain patient flow model. If indeed patients are not manipulating arrival time, then it is also reasonable to assume potential outcomes are continuous at the start time of the split flow model, as assumed in Assumption 2.

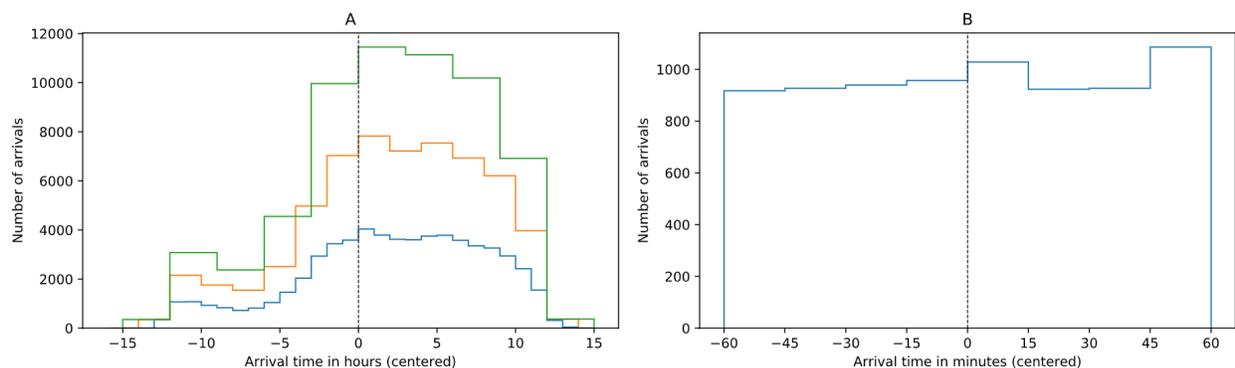

Figure 5: Histograms of the number of arrivals for all the sample (Panel A) and the 1 hour bandwidth used in the RD analysis (Panel B). Non-overlapping bins of 1 (blue), 2 (orange) and 3 (green) hours were used in Panel A and 15 minutes bins were used for Panel B. The dashed vertical line marks the start of the split flow model.

As an additional check for treatment manipulation, Figure 6 plots mean values of age, race, chief complaint and female indicator (Panels A, B, C and D respectively) for the RD sample. Each figure consists of non-overlapping bins of size

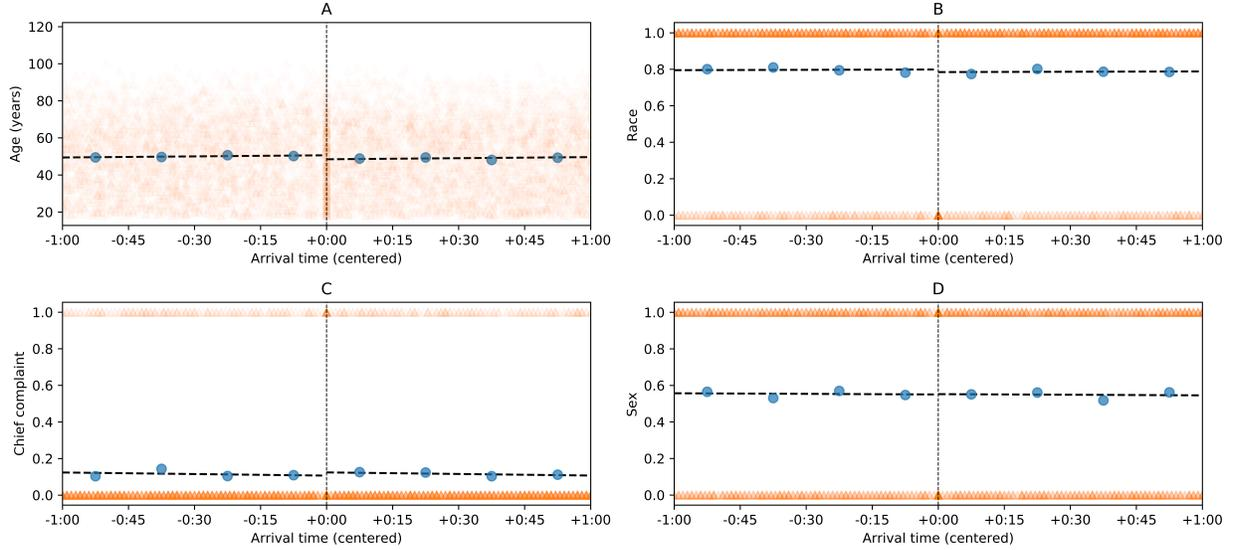

Figure 6: Covariate balancing. Panels A, B, C and D represent the average age, race, chief complaint and sex (blue dots) for different visits (orange triangles) in the 1 hour bandwidth sample. Pre-treatment variables were averaged in bins of 15 minutes. The dashed vertical line marks the start of the split flow model.

15 minutes centered at the start of split flow (dashed vertical line). Importantly, the start of the split flow model is used as one of the boundaries between two consecutive bins in order to prevent overlap of split flow patients with traditional flow patients. The presence of a jump at the cutoff could invalidate the RD design since they affect the estimated discontinuity for the outcome. These plots shows jumps in average covariates near the start of split flow that are not substantially larger than any other time of day except for age, where we find that average age decreases by 1.9 years (95% CI:[0.3, 3.5], $P = 0.017$) between control and treatment groups (see Table 9). This alone suggests that age might be discontinuous at the start of split flow. However, when we account for multiple comparisons, as recommended by Lee and Lemieux (2010), age is not significant with a Bonferroni-corrected P value of $0.017 \times 4 = 0.068$. Thus, it does not appear that patients with certain characteristics are manipulating their arrival times, which is consistent with Assumption 2. As further support, we note that adding and removing covariates barely changed the estimations (see Table 10).

Covariate	RD estimate	95% Confidence interval	P
Age (years)	-1.9	[-3.5, -0.3]	0.017
Race	-0.5%	[-3.9%, 2.9%]	0.78
Chief complaint	1.5%	[-1.2%, 4.2%]	0.94
Sex	0.2%	[-4.4%, 4.1%]	0.28

Table 9: Estimates (95% confidence intervals) of a discontinuity when replacing the outcome for each covariate of the base model. Here, P values are provided before applying a Bonferroni correction to account for multiple comparisons.

Outcome	Bandwidth (hours)					
	0.5	1	1.5	2	2.5	3
	Including covariates					
Time to be roomed (min.)	9.1 (6.7, 11.4)	4.6 (2.9, 6.2)	2.2 (0.8, 3.5)	0.7 (-0.4, 1.8)	-0.01 (-1.0, 1.0)	-0.5 (-1.3, 0.4)
Time to disposition (min.)	-20.4 (-34.7, -6.2)	-14.4 (-24.7, -4.1)	-14.8 (-23.4, -6.3)	-13.8 (-21.2, -6.4)	-13.6 (-20.3, -6.8)	-13.6 (-19.8, -7.5)
Admission decision (%)	-7.9 (-12.8, -3.0)	-5.8 (-9.4, -2.3)	-3.6 (-6.6, -0.6)	-2.8 (-5.4, -0.2)	-1.9 (-4.3, 0.3)	-1.9 (4.1, 0.1)
30 days revisit (%)	-1.6 (-5.4, 2.2)	-0.7 (-3.5, 2.0)	-1.3 (-3.6, 0.9)	-1.2 (-3.3, 0.7)	-0.6 (-2.5, 1.2)	-1.0 (-2.7, 0.6)
log(Time to be roomed (min.)) (%)	46.4 (32.5, 61.7)	18.7 (10.0, 28.1)	7.2 (0.5, 14.3)	-0.2 (-5.7, 5.6)	-0.9 (-5.8, 4.3)	-2.2 (-6.7, 2.4)
log(Time to disposition (min.))	-12.1 (-17.8, -6.0)	-9.0 (-13.3, -4.4)	-9.0 (-12.5, -5.2)	-8.9 (-12.0, -5.6)	-8.8 (-11.6, -5.9)	-8.7 (-11.3, -6.0)
	No covariates					
Time to be roomed (min.)	9.2 (6.9, 11.6)	4.7 (3.0, 6.3)	2.2 (0.9, 3.6)	0.7 (-0.4, 1.8)	0.0 (-1.0, 1.0)	-0.4 (-1.3, 0.4)
Time to disposition (min.)	-21.9 (-36.4, -7.3)	-15.0 (-25.6, -4.4)	-16.5 (-25.2, -7.7)	-14.6 (-22.2, -7.0)	-13.9 (-20.7, -7.0)	-14.2 (-20.5, -7.9)
Admission decision (%)	-9.4 (-14.4, -4.4)	-6.8 (-10.5, -3.1)	-4.5 (-7.6, -1.4)	-3.4 (-6.1, -0.7)	-2.4 (-4.8, 0.0)	-2.6 (-4.8, -0.3)
30 days revisit (%)	-1.5 (-5.3, 2.2)	-0.6 (-3.4, 2.0)	-1.3 (-3.6, 0.9)	-1.2 (-3.3, 0.8)	-0.6 (-2.5, 1.2)	-1.0 (-2.7, 0.7)
log(Time to be roomed (min.)) (%)	47.5 (33.5, 62.9)	19.2 (10.5, 28.6)	7.4 (0.7, 14.5)	-0.1 (-5.6, 5.7)	-0.8 (-5.8, 4.3)	-2.2 (-6.7, 2.5)
log(Time to disposition (min.))	-12.9 (-18.7, -6.6)	-9.4 (-13.8, -4.7)	-9.8 (-13.4, -6.0)	-9.3 (-12.5, -6.0)	-8.9 (-11.8, -6.0)	-9.0 (-11.7, -6.2)

Table 10: Sensitivity to bandwidth size and covariates. RD average treatment effect for multiple outcomes and bandwidths varied from 0.5 hours to 3 hours.

Appendix B Sensitivity to bandwidth and covariates

Bandwidth selection is critical to RD designs. The bandwidth size is intimately related to the trade-off between bias and variance associated with the RD estimates. A narrow bandwidth increases variance, but allows the control and treatment population to be more exchangeable. A wider bandwidth reduces variance but reduces the chance of the estimated effect to be interpreted as the causal effect. Our leave-one-out cross validation procedure suggests that the 1 hour bandwidth (two hours in total) offers a good fit to data. We also consider that the chosen bandwidth is a good option by inspecting the figures for average outcomes at the cutoff and given the limited number of ED encounters around the cutoff.

In this section, we explore the sensitivity of RD estimates to changes in the bandwidth size. Table 10 contains the RD estimates for bandwidth h varied from 0.5 hours to 3 hours. Notoriously, the average time to be roomed is only significant for bandwidth less than 2 hours. On the other hand, ED time to disposition estimates are stable across all bandwidths. Our results support the hypothesis that split flow model reduces ED time to dispositions. The estimates vary from 20.4 minutes (95% CI: [-34.7, -6.2]) for the smallest bandwidth (0.5 hours) to 13.6 minutes (95% CI: [-19.8, -7.5]). In all scenarios, split flow improves the average ED length of stay of patients.

Appendix C RD Figures

In this section, we illustrate the RD estimates found in Section 5.2 and Section 5.4. Each figure depicts the average value of outcomes (in blue) for multiple ED encounters (orange triangles) inside the 1 hour bandwidth used for the RD analysis. Fitted regression lines (dashed lines) are also shown on the left and the right of start hour of the split flow (vertical dashed line). Causal effects are measured as the discontinuity formed by left and right regressions at the cutoff. Figure 7 illustrate the results for continuous outcomes, namely, time to be roomed (Panel A) and time to disposition (Panel B). We observe a negative impact of the split flow model on average time to be roomed and a positive effect on average time to disposition at the cutoff. Figure 8 depicts the analogue for binary outcomes, i.e. admission decision (Panel A) and 30 day revisits (Panel B). We note a significant discontinuity for the number of admissions and a no significant jump for revisits.

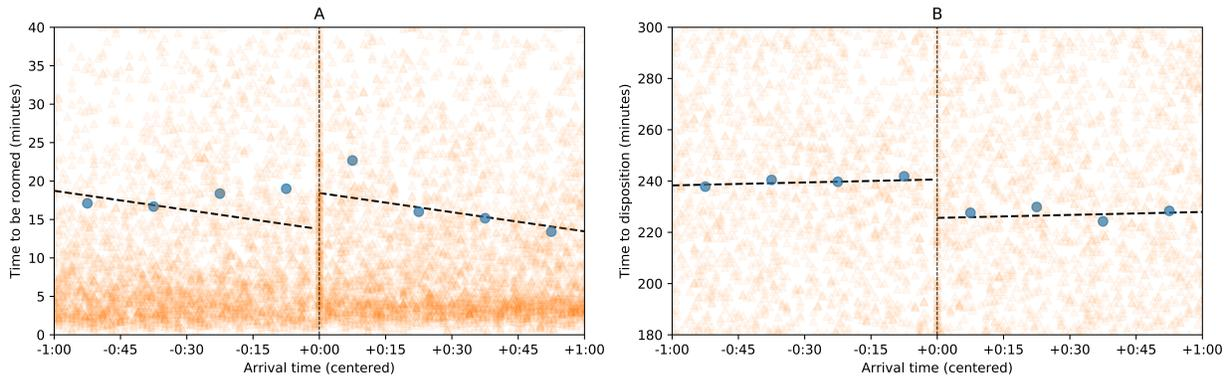

Figure 7: RD for continuous outcomes. Average time to be roomed (blue dots, Panel A) and average time to disposition (Panel B) for different visits (orange triangles) grouped in 15 minutes bins and fitted regression lines (dashed line). Arrival hour is centered at the start of split flow. Causal effects are measured as the discontinuity between estimated left and right regression models at the split flow start time.

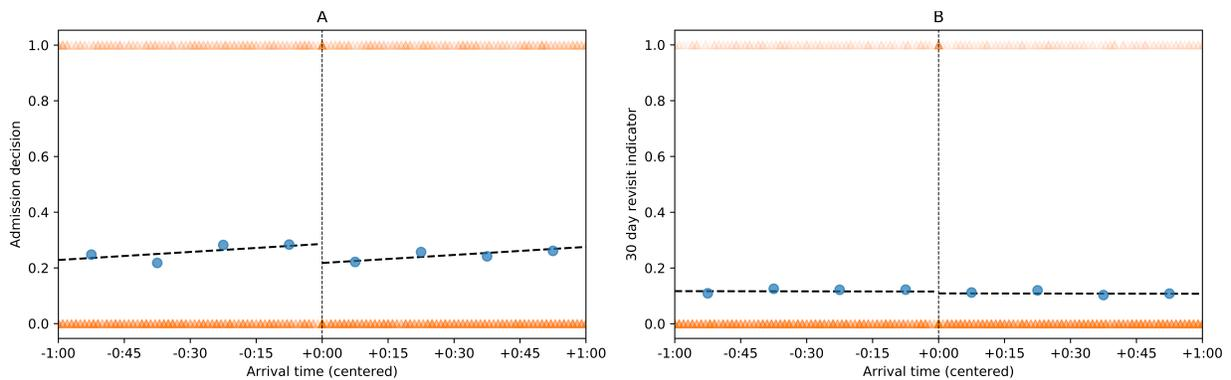

Figure 8: RD for binary outcomes. Average number of admissions (blue dots, Panel A) and average number of revisits (Panel B) for different ED encounters (orange triangles) grouped in 15 minutes bins and fitted regression lines (dashed line). Arrival hour is centered at the start of split flow. Causal effects are measured as the discontinuity between estimated left and right regression models at the split flow start time.

Appendix D Moderation analysis for binary outcomes

We next investigated the influence of moderator variables (i.e., congestion, day of the week, physician workload, and start time of the split flow model) on the effect of split flow on admission decision rates and revisits within 30 days of discharge rates. When adding, one at a time, each possible moderator and their interaction with the split flow indicator to the baseline regression model and testing whether simultaneously the interactions terms are significant, we found that day of the week, physician workload and split flow start hours did not yield a significant results in the model for either admission decision or 30 days revisit rates (Table 11). Therefore, day of the week, physician workload and split flow start hours do not appear to moderate the effect of split flow on downstream outcomes. Similarly, congestion was not significant in the model for 30 days revisits ($P = 0.91$) indicating that congestion is not a variable moderating the effect of split flow on 30 days revisit rates.

In contrast, the only moderator that yield significant results was congestion in the model for admission decision ($P = 0.05$). Thus, the effectiveness of the split flow model does appear to be moderated by congestion. Upon closer examination, we find that the split flow model decreases average admission rates during the highest congestion level, and to a lesser degree, during the medium and low congestion levels (Figure 9). All this might suggest that fewer patients are being admitted under the split flow, especially under high congestion, without impacting revisit rates.

As we did with continuous outcomes, we also estimate a model including all moderators and their pairwise interactions with the split flow indicators. In this scenario, we still find that day of week, physician workload, and split flow start hours did not yield significant interaction terms ($P < 0.05$ for all outcome, see Table 12) for either admission decision and 30 days revisit rates. Surprisingly, congestion was not significant in the full model for either admission decision and 30 days revisits. These findings reinforce the observation that, except for possibly congestion, downstream consequences might be not affected by the operational context of the ED.

Moderator	Admission decision	30-days revisit
Congestion	0.05	0.91
Day of week	0.72	0.81
Physician workload	0.66	0.61
Split flow change hours	0.74	0.73

Table 11: P values for the joint test of interaction terms of moderator variables with split flow equal to zero for the regression model where each moderator is added one by one.

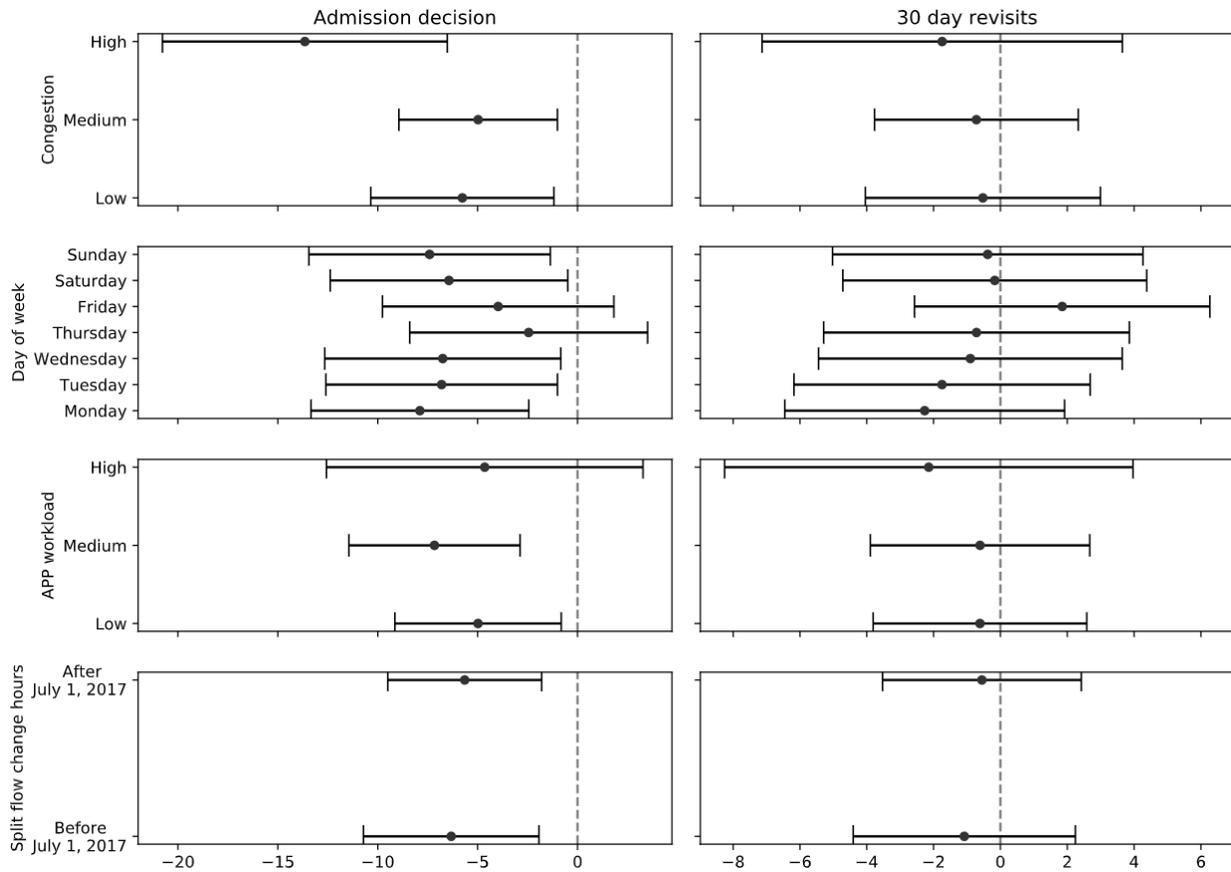

Figure 9: Average effect (%) of split flow on admission decision (left) and 30 days revisits (right) during each level of moderator variables: congestion, day of week, physician workload and split flow start hours.

Moderator	Level	Admission decision		30 days revisit	
		Interaction (95% CI)	<i>P</i>	Interaction (95% CI)	<i>P</i>
Congestion	Medium	-0.1 (-5.4, 5.2)	0.07	0.6 (-3.5, 4.6)	0.90
	High	-8.9 (-17.8, -0.1)		-0.6 (-5.6, 4.5)	
Day of week	Monday	0.0 (-7.1, 7.1)	0.67	-1.7 (-7.2, 3.7)	0.84
	Tuesday	0.9 (-6.4, 8.2)		-1.6 (-7.2, 4.0)	
	Wednesday	1.1 (-6.3, 8.4)		-0.6 (-6.2, 5.0)	
	Thursday	5.6 (-1.8, 13.1)		-0.5 (-6.2, 5.2)	
	Friday	3.8 (-3.4, 11.0)		2.1 (-3.4, 7.6)	
	Saturday	0.7 (-6.5, 7.9)		0.1 (-3.4, 7.6)	
Physician workload	Medium	1.6 (-3.4, 6.6)	0.81	-1.1 (-4.9, 2.8)	0.86
	High	1.5 (-3.4, 6.6)		-0.6 (-5.6, 4.5)	
Split flow start hour	After July 1, 2017	0.1 (-4.0, 4.2)	0.96	0.2 (-2.9, 3.3)	0.90

Table 12: Estimates (in %) for the coefficients of the interaction terms between split flow and moderator variables for the regression model including all moderators, and *P* values for the null hypothesis testing whether the interactions of a given moderator are zero simultaneously.

Appendix E Moderation analysis for congestion in relative scale

In this section we examine the moderation effects of congestion on log transformed time to be roomed and time to disposition. As is standard practice, we take natural logarithm in order to account for the heavy tail of the distribution of length of stay. We find that split flow reduces the average time to be roomed by 31.8% (95% CI:[20.6%, 41.4%]) during the highest congestion level compared with the traditional nurse-led triage (Table 13). Split flow, however, increases by a greater percent of 42.8% (95% CI:[42.8, 73.3]) the average time to be roomed for low congestion levels compared with the traditional flow. As for time to disposition, we find that split flow reduces average time to disposition for low and middle tertiles by a percent of 11.5% (95% CI:[5.7%, 16.7%]) and 9.7% (95% CI:[4.7%, 14.5%]) respectively. These results suggest that the impact of split flow is most notable on time to be roomed compared with time to disposition, in particular, during low congestion levels. This might suggest that split flow actually increases ED length of stay during low congestion levels but this is not the case when we observe the impact in absolute terms (Figure 4). Similarly, when taken together, we observe percentage reductions of ED length of stay during medium and high levels of congestion. These estimates are depicted in Figure 10.

Congestion level	Time to be roomed	Time to disposition
High	-31.8 (-41.4, -20.6)	1.4 (-7.9, 11.7)
Medium	5.8 (-2.5, 14.9)	-9.7 (-14.5, -4.7)
Low	57.3 (42.8, 73.3)	-11.5 (-16.7, -5.7)

Table 13: Estimates (95% confidence intervals) for the percent of change on the original scale due to the split flow model on time to be roomed and time to disposition decision after being roomed.

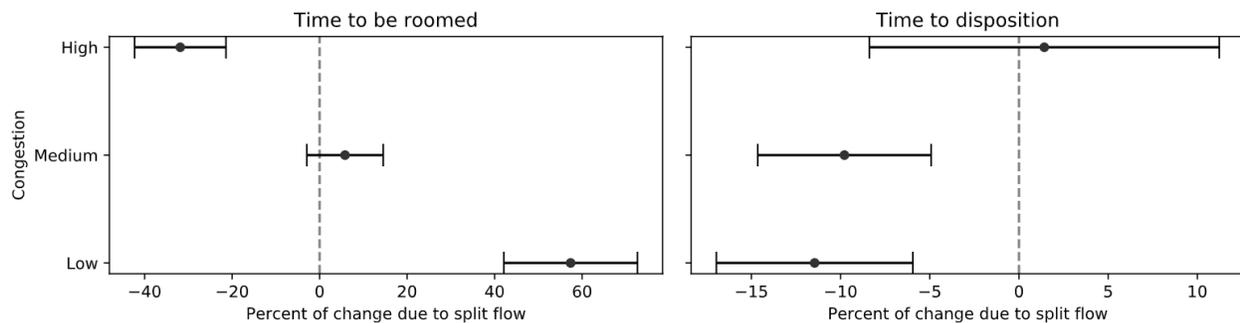

Figure 10: Average percent of change due to split flow on time to be roomed) and time to disposition during each congestion level.

Appendix F RD for split flow end hours

We have analyzed the effect of the split flow model on outcomes by performing an RD design at the start of the intervention (i.e., at 12p). We can also estimate causal effects of split flow on outcomes when split flow ends, i.e., at 9pm. Three features make the latter analysis different from the one presented in the main text. First, the operational context (E.g., congestion, staffing) of the ED at night is substantially different from the context around noon. Second, we expect that patients arriving around the start of split flow are different from those arriving at night, right before and right after the end of the intervention. Third, before July 1, 2017, the end of split flow was 10p, which overlaps with the start of a new shift for physicians. Thus, we expect that the effect of split flow at the start will be significantly different from its effect at the end. In particular, we hypothesize that the effect of split flow will be lower at the end of split flow. Here, we test this hypothesis by evaluating impact of split flow on outcomes using an RD design when the forcing variables is centered at the end of the intervention.

As hypothesized, we find that split flow has no significant impact on time to disposition, admission decisions and 30 days revisits (all confidence intervals contain zero) (Table 14). By contrast, the average time to be roomed decreases by 3.7 minutes (95% CI:[1.1, 6.4]).

Outcome	Estimate	95% confidence interval
Time to be roomed (mins.)	-3.7	(-6.4, -1.1)
Time to disposition (mins.)	2.2	(-8.7, 13.1)
Admission decision (%)	-0.6	(-4.4, 3.1)
30 days revisits (%)	-0.1	(-3.5, 3.3)
Log(Time to be roomed) (%) ¹	-23.3	(-30.4, -15.0)
Log(Time to disposition) (%) ¹	0.4	(-5.2, 6.5)

¹ Note: Percent of change on the original outcome due to split flow.

Table 14: RD estimates (95% confidence intervals) the impact of split flow on outcomes when the arrival time is centered at the end of the intervention. A bandwidth size of 1 hour was used (two hours in total).