

CONTINUUM MANY PLANAR EMBEDDINGS OF THE KNASTER ACCORDION

JOSEPH S. OZBOLT

ABSTRACT. Añusić, Bruin, and Činč have asked in [2] which hereditarily decomposable chainable continua (HDCC) have uncountably many mutually inequivalent planar embeddings. It was noted, as per the embedding technique of John C. Mayer with the $\sin(1/x)$ -curve [12], that any HDCC which is the compactification of a ray with an arc likely has this property. Here, we show two methods for constructing \mathfrak{c} -many mutually inequivalent planar embeddings of the classic Knaster $V\Lambda$ -continuum, K , also referred to as the Knaster accordion. The first of these two methods produces \mathfrak{c} -many planar embeddings of K , all of whose images have a different set of accessible points from the image of the standard embedding of K , while the second method produces \mathfrak{c} -many embeddings of K , each of which preserve the accessibility of all points in the standard embedding.

1. INTRODUCTION AND PRELIMINARIES

When referring to a collection as having *continuum many* elements, we mean that its cardinality is the same as that of the set of real numbers, which will be denoted by \mathfrak{c} . By *a continuum*, we mean a compact connected metric space.

Let X be a metric space with metric d , and let $A \subset X$. The *diameter* of A , denoted $\text{diam}(A)$, is given by $\text{diam}(A) = \sup\{d(x, y) \mid x, y \in A\}$. A finite collection $\mathcal{C} = \{C_1, C_2, \dots, C_n\}$ of subsets of X having the property that $C_i \cap C_j \neq \emptyset$ if and only if $|i - j| \leq 1$ is called a *chain* in X . By the *mesh* of \mathcal{C} , we mean the maximum of the set of diameters of each member C . If \mathcal{C} covers X , that is, if $X = \bigcup \mathcal{C}$, we say that \mathcal{C} is a *chain covering* of X .

A continuum is *chainable* if it can be covered by a chain covering of open subsets having arbitrarily small mesh. If a continuum can be expressed as the union of two of its proper subcontinua, then it is said to be *decomposable*; otherwise, we say it is *indecomposable*. If a continuum has the property

2020 *Mathematics Subject Classification*. Primary 54F50; Secondary 54C25.

Key words and phrases. Continuum, Knaster, Planar Embedding.

This paper comprises the results of the author's dissertation, written under the direction of Piotr Minc and presented to the faculty of Auburn University in partial fulfillment of the requirements for the degree of Doctor of Philosophy, August 2020.

that each of its nondegenerate subcontinua is decomposable, it is said to be *hereditarily decomposable*. We will mainly concern ourselves with hereditarily decomposable chainable continua (HDCC for both singular and plural).

By *the plane*, we mean here the xy -plane, which will sometimes be denoted by \mathbb{R}^2 , endowed with the usual Euclidean metric, which will be denoted as d . Given a planar continuum X and two planar embeddings φ and ψ of X , we say that φ and ψ are *equivalent planar embeddings of X* if there exists a homeomorphism of the plane onto itself mapping $\varphi(X)$ onto $\psi(X)$. If no such homeomorphism exists, we say that φ and ψ are *inequivalent planar embeddings of X* , or simply, are inequivalent for short. If Φ is a collection of embeddings of X having the property that for each φ and ψ in Φ where $\varphi \neq \psi$, φ and ψ are inequivalent, then we say that Φ is a *collection of mutually inequivalent embeddings of X* .

Let X be a continuum in the plane and let $x \in X$. If there exists an arc A in the plane such that $A \cap X = \{x\}$, we say x is *accessible from the complement of X* . For short, we may say that x is an accessible point of X , or simply, that x is accessible if the continuum X is understood.

If x is an accessible point of $\varphi(X)$ and A an arc contained in the plane having x as an endpoint with $A \cap \varphi(X) = \{x\}$, then A is called an *endcut* of $\varphi(X)$. If C is an arc contained in the plane whose interior is contained in the complement of $\varphi(X)$ and whose endpoints are contained in $\varphi(X)$, then C is called a *crosscut* of $\varphi(X)$.

Planar embeddings of continua have been a subject of inquiry in topology since at least the early twentieth century. According to R.H. Bing in [5], Theorem 4, every chainable continuum can be embedded in the plane. It is well-known, as one can verify is a consequence of the Jordan-Schoenflies Theorem [6], that an arc has only one planar embedding up to equivalence. The question of how many mutually inequivalent planar embeddings can be produced for one specific chainable continuum or a particular class of chainable continua has also been of interest. For example, Michel Smith [21] and Wayne Lewis [10] have both independently shown that there are uncountably many mutually inequivalent planar embeddings of the pseudo-arc. More recent results include those of Anušić, Činč, and Bruin in [1], [2], and [4].

The accessibility of points in the images of planar embeddings of continua is of particular interest, of which a well-known problem is that of Nadler and Quinn in [17]. It is asked, given a chainable continuum X and a point $x \in X$, if there is a planar embedding φ of X such that $\varphi(x)$ is

accessible. This question was answered as positive for all HDCC by Minc and Transue in Theorem 6.1 of [13]. However, the question remains open for indecomposable continua. A survey of this problem can be found in [3]. How accessibility of points in the images of planar embeddings relates to inequivalent embeddings can be manifested by the following proposition, which says that if the images of two planar embeddings of a continuum have a different set of accessible points, then the embeddings are inequivalent.

Proposition 1.1. *Let φ and ψ be planar embeddings of a continuum X . If there is an $x \in X$ such that $\varphi(x)$ is accessible while $\psi(x)$ is not, then φ and ψ are inequivalent.*

Thus, given a planar continuum X , one can provide a pair of mutually inequivalent planar embeddings φ and ψ of X by constructing φ and ψ so that at least one point of X is accessible in the image φ and inaccessible in the image of ψ . In [12], John C. Mayer constructed a procedure for embedding the $\sin(1/x)$ -continuum (shown in Figure 1) in uncountably many mutually inequivalent ways so that their images all have the same set of accessible points. This procedure is executed by first developing a *schema* (plural: *schemata*) consisting of *subschemata* (singular: *subschemata*) for each sequence of nonnegative integers, followed by manipulating the ray in the $\sin(1/x)$ -continuum on each side of its limiting arc according to the rules of the schema. A somewhat similar procedure can apply to forming uncountably many mutually inequivalent embeddings of other HDCC. One example in which we demonstrate using such a similar embedding procedure will be with the Knaster $V\Lambda$ -Continuum, otherwise known as the *Knaster accordion*, which we will denote as K , shown in Figure 2. This paper will be devoted to K , in which we construct two different collections of mutually inequivalent embeddings of K each having cardinality \mathfrak{c} . This exhibits a way to produce uncountably many, and in fact \mathfrak{c} -many, mutually inequivalent planar embeddings of an HDCC which contains no subcontinuum having a dense ray and which is not path connected and is nowhere locally connected.

Recently, Añusić, Bruin, and Činč showed in [2] that every chainable continuum containing a nondegenerate indecomposable subcontinuum admits uncountably many mutually *strongly* inequivalent planar embeddings.¹ They asked (Question 6 of [2]) which HDCC (other than an arc) have uncountably many mutually inequivalent planar embeddings. It was noted that Mayer's embedding approach for the $\sin(1/x)$ -continuum, as mentioned in

¹Planar embeddings φ and ψ of a planar continuum X are strongly equivalent if $\psi \circ \varphi^{-1} : \varphi(X) \rightarrow \psi(X)$ can be extended to a homeomorphism of the plane onto itself.

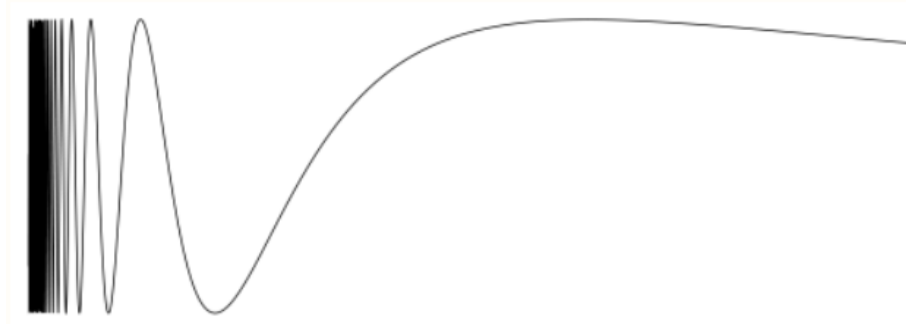

FIGURE 1. The $\sin(1/x)$ -continuum, also known as the topologist's sine curve, is an HDCC which is the compactification of a ray with an arc. This continuum is not path connected, nor is it locally connected.

the previous paragraph, likely works to show that any continuum which is the compactification of a ray with an arc has uncountably many mutually inequivalent planar embeddings. They further added that Mayer's approach would not generalize to the remaining HDCC since not all have subcontinua with dense rays.

As previously noted, and as made apparent in Figure 2, K is an HDCC containing no subcontinuum which is the compactification of a ray with an arc. In fact, K contains no subcontinuum containing a dense ray. Furthermore, K is not path connected and is also nowhere locally connected. Note that the $\sin(1/x)$ -continuum contains a dense ray, and although it is not path connected, it is not nowhere locally connected. Regardless, we will still be able to give a "Mayer-like" approach to producing uncountably many, and in fact, \mathfrak{c} -many, mutually inequivalent planar embeddings of K . Furthermore, we will provide two methods of producing these embeddings—one which produces \mathfrak{c} -many mutually inequivalent planar embeddings of K , all of whose images have a different set of accessible points from the image of the standard embedding of K , and the other producing \mathfrak{c} -many mutually inequivalent planar embeddings of K which preserve the accessibility of points accessible in the standard embedding. The collection of embeddings of the former will be constructed in Section 2 and the latter will be constructed in Section 3.

Before we give a geometric construction defining K , we must first provide some basic theory and terminology regarding the general structure of all HDCC, most of which is extracted from Kuratowski's theory on the structure of irreducible continua in Chapter V, §48 of [9]. For a given HDCC X , there exists a continuous function g mapping X onto $[0, 1]$ so that for

each $t \in [0, 1]$, $g^{-1}(t)$ is a maximal nowhere dense subcontinuum of X . Such a function g will be called a *Kuratowski map* of X , and the subcontinua $g^{-1}(t)$ will be called the *layers* of X . The layers given by $g^{-1}(0)$ and $g^{-1}(1)$ will be called the *left end layer* and *right end layer* of X , respectively. All other layers are called *interior layers* of X .

In particular, each HDCC admits an upper semicontinuous decomposition into layers. That is, if X is an HDCC and g a Kuratowski map of X , then g^{-1} is an upper semicontinuous set-valued map. The curious reader may refer to section III, §2 of [16] for more information on upper semicontinuous decompositions of continua. Each nondegenerate layer L of an HDCC X is also an HDCC and can itself be decomposed into layers. As can be found in [13], [15], and [22], we refer to *generalized layers* of X as those which may be layers of X , layers of layers of X , etc. More specifically, let $\mathcal{L}_0(X) = \{X\}$. If $\alpha = \beta + 1$, let $\mathcal{L}_\alpha(X)$ consist of the degenerate members as well as the layers of the nondegenerate members of $\mathcal{L}_\beta(X)$. If α is a limit ordinal, let $\mathcal{L}_\alpha(X) = \{\bigcap_{\beta < \alpha} L_\beta \mid L_\beta \in \mathcal{L}_\beta(X)\}$. It was also shown by Thomas in [22] that there exists a least countable ordinal σ_X such that every member of $\mathcal{L}_{\sigma_X}(X)$ is degenerate. Thus, the generalized layers of X are any members of the set $\mathcal{L}(X) = \bigcup_{\alpha \leq \sigma_X} \mathcal{L}_\alpha(X)$. Mohler showed in [15] that for every countable ordinal α , there exists an HDCC X_α so that every member of $\mathcal{L}_\alpha(X_\alpha)$ is degenerate. Thus, for a given HDCC X and a point $x \in X$, there exists a countable ordinal σ_x such that $\sigma_x = \min\{\alpha \mid \{x\} \in \mathcal{L}_\alpha(X)\}$. Note that if L is a nondegenerate generalized layer of X , then there exists a unique countable ordinal $\sigma_L > 0$ such that $L \in \mathcal{L}_{\sigma_L}(X)$. In either case, we say that σ_X is the *layer level of X* , that σ_x is the *layer level of x in X* for $x \in X$, and that for a nondegenerate generalized layer L of X , σ_L is the *layer level of L in X* . It becomes self-evident at this point that when referring to a layer of an HDCC, we mean a generalized layer having a layer level of 1. We shall also refer to such layers as *top layers* to avoid any possible ambiguity in a given context. It is worth noting that generalized layers of K having a layer level more than 1 will not be used in this paper. However, we have defined generalized layers of HDCC since they are relevant in one of the questions of section 4.

A nondegenerate continuum Y is *irreducible between two points* $x, y \in Y$ if there is no proper subcontinuum of Y containing both x and y . Likewise, Y is *irreducible between two subcontinua* $A_1, A_2 \subset Y$ if there is no proper subcontinuum Z such that $A_1, A_2 \subset Z$. It is well-known (again, see Chapter V, §48 of [9]) that all HDCC are irreducible between two points. In fact, if

Y is an HDCC and $x, y \in Y$ are any two distinct points (subcontinua) of Y , then there is a subcontinuum of Y irreducible between x and y .

If X is an HDCC and x and y are distinct points in X , then the subcontinuum of X irreducible between x and y will be denoted by $[x, y]$. Likewise, given subcontinua C_1 and C_2 of X , we denote the subcontinuum of X irreducible between C_1 and C_2 as $[C_1, C_2]$. Also, we have $(C_1, C_2] := [C_1, C_2] \setminus C_1$, $[C_1, C_2) := [C_1, C_2] \setminus C_2$, and $(C_1, C_2) := [C_1, C_2] \setminus (C_1 \cup C_2)$. Note that if C_1 and C_2 are top layers of X with $x \in C_1$ and $y \in C_2$, then $[x, y] = [C_1, C_2]$, $(x, y] = (C_1, C_2]$, $[x, y) = [C_1, C_2)$, and $(x, y) = (C_1, C_2)$.

One may note that the interval-like notation provided in the previous paragraph for such irreducible subcontinua implies there is some assigned ordering. In some cases, one can naturally infer the ordering based on a Kuratowski map $g : X \rightarrow [0, 1]$, in that if x and y are distinct points of X such that $g(x) < g(y)$, then the subcontinuum of X irreducible between x and y is $[x, y]$. Likewise, if C_1 and C_2 are distinct subcontinua of X such that

$$\min\{g(x) \mid x \in C_1\} < \min\{g(x) \mid x \in C_2\},$$

then the subcontinuum of X irreducible between C_1 and C_2 is $[C_1, C_2]$. For the purposes of this paper, this will always be the case. However, in cases where points x and y or subcontinua C_1 and C_2 are contained within the same generalized layer, one must more carefully define a consistent ordering on X . The reader is referred to §3 of [14] for a detailed description of such an ordering.

Given an interior layer L of X , we define the *left part of L* and the *right part of L* as

$$\ell(L) = \text{cl}\left(g^{-1}([0, g(L)))\right) \cap L \quad \text{and} \quad r(L) = L \cap \text{cl}\left(g^{-1}((g(L), 1])\right),$$

respectively.

Definition 1.2. Let X be an HDCC, let g be a Kuratowski map of X , and let L be a layer of X . We say that L is a **layer of cohesion** if L is an end layer or if $\ell(L) = L = r(L)$.

Definition 1.3. Let X be an HDCC and let g be a Kuratowski map of X . We say that a layer L of X is a **layer of continuity** if the set-valued map g^{-1} is continuous at the point $g(L)$.

As noted by Kuratowski on page 201 of [9], layers of cohesion need not be layers of continuity, as is the case for the limiting arc of the $\sin(1/x)$ -continuum.

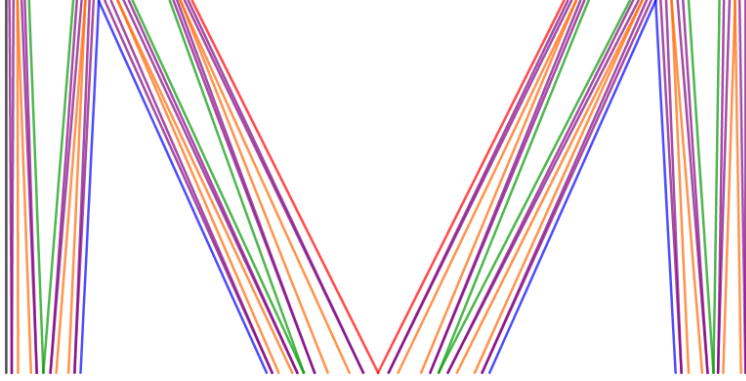

FIGURE 2. The (horizontally elongated) image of the standard embedding of the Knaster $V\Lambda$ -continuum, K , also known as the Knaster accordion, approximated by the first five steps along with the end layers. Note that K contains no subcontinuum containing a dense ray and that it is also not path connected and is nowhere locally connected.

Proposition 1.4. *Let X be a hereditarily decomposable chainable continuum, let h be a homeomorphism of X onto itself, and let $g : X \rightarrow [0, 1]$ be a Kuratowski map. Then for every $s, t \in [0, 1]$ such that $s \leq t$, we have either $g(h(g^{-1}(s))) \leq g(h(g^{-1}(t)))$ or $g(h(g^{-1}(s))) \geq g(h(g^{-1}(t)))$.*

That is, Proposition 1.4 says that any homeomorphism of an HDCC onto itself will preserve the order of the top layers in the sense that if one top layer is between two other top layers, the same will hold in its image under any homeomorphism.

We may now begin to construct the Knaster $V\Lambda$ -Continuum, otherwise called the Kuratowski accordion, which will be denoted by K and shown in Figure 2. By a "V" and a " Λ ," we mean an arc consisting only of two maximally straight line segments shaped like the letters V and Λ , respectively.² We construct K in such a way that also constructs what is referred here as *the standard planar embedding of K* , or *standard embedding of K* for short, whose (horizontally elongated) image is shown in Figure 2, as given by the following sequence of steps.

- (1.) Draw the V whose vertex is the point $(1/2, 0)$ and whose endpoints are $(1/3, 1)$ and $(2/3, 1)$.
- ⋮
- (n .) Consider the set Δ_n consisting of all 2^{n-1} quadrilaterals contained in $[0, 1] \times [0, 1]$ whose left and right sides contain either $\{0\} \times [0, 1]$, $\{1\} \times [0, 1]$, or maximal straight segments of two different V's or Λ 's

²More precisely, we mean arcs shaped like \vee and \wedge , respectively.

from the preceding steps, and whose interiors contain no points from any V 's or Λ 's in the preceding steps. If n is even (odd), we draw the 2^{n-1} -many Λ 's (V 's) each sitting in individual members of Δ_n . The vertex of each Λ (V) is on the top (bottom) side of its given quadrilateral, sitting halfway between the two top (bottom) vertices of the quadrilateral. Finally, the two endpoints of each Λ (V) sit evenly spaced on the bottom (top) side of its given quadrilateral.

⋮

(ω .) Let K be the closure of the union of all V 's and Λ 's from each of the preceding steps.

Again, a rough image of this standard embedding of K can be seen in Figure 2 as approximated by the first five steps listed above, together with the arcs $\{0\} \times [0, 1]$ and $\{1\} \times [0, 1]$. Generally, when referring to K without specifying any particular embedding, it can be assumed we mean the image of the standard embedding of K . One may observe geometrically that K is chainable. Upon taking the closure of the union of all V 's and Λ 's to form K as described in step ω , we have immediately inserted \mathfrak{c} -many straight arcs, two of which are the left end $\{0\} \times [0, 1]$ and the right end $\{1\} \times [0, 1]$, the rest of which lie between V 's and Λ 's. It can also be observed that these \mathfrak{c} -many straight arcs are the layers of continuity as well as the layers of cohesion of K , with $\{0\} \times [0, 1]$ the left end layer and $\{1\} \times [0, 1]$ the right end layer. Each V and Λ of K is layer of K which is neither a layer of continuity nor a layer of cohesion. Thus, K is an HDCC with each of its layers being arcs and thus nondegenerate. Furthermore, the layer level of K is 2. Finally, one may observe geometrically from Figure 2 that the set of accessible points of the standard embedding of K consist of all points of end layers and non-cohesion layers of K and the endpoints of interior layers of continuity of K . That is, if L is either an end layer, a V -layer, or a Λ -layer, then every point of L is accessible, whereas if L is an interior straight-arc layer, then only the endpoints of L are accessible.

Kazimierz Kuratowski attributed K to Bronisław Knaster in [9], hence its namesake herein. It has also be referred to as the "Cajun accordion" by James Rogers in [18] and [19] and by David Lipham in [11]. In [19], James Rogers gives mention to both the Knaster accordion and its circularly chainable counterpart which he refers to as the "Zydeco accordion." The Zydeco accordion can be constructed by identifying the end layers of K . In particular, he points out that although many continuum theorists would

consider the Zydeco accordion as being "rich" in rotations, it happens to be meager with respect to extendable intrinsic rotations about the origin.

Although vertices of layers of K can be understood to be the geometric vertices of V or Λ layers of K , we also provide the following topological definition of vertices of layers of K .

Definition 1.5. Let L be a V -layer or a Λ -layer of K . We say that a point $v \in L$ is a **vertex** of L if $v \in \text{int}_L(L)$ and for every open subset U of K containing v , U contains infinitely many endpoints of layers of K .

If v is a vertex of a layer L , it is understood that L is not a layer of continuity of K , i.e., L is either a V or a Λ . Furthermore, we may also say that v is a vertex of K , understanding that it is a vertex of a layer of K which is not a layer of continuity of K . Note that in the following lemma, we will let $E = \{0\} \times [0, 1]$ and $E' = \{1\} \times [0, 1]$ denote the end layers of K , we will let $p = (0, 0)$ and $p' = (1, 0)$ denote the bottom endpoints of E and E' , respectively, and we will let $q = (0, 1)$ and $q' = (1, 1)$ denote the top endpoints of E and E' , respectively. Furthermore, we will denote the collection of bottom endpoints and vertices of layers of K by P while the top such points will be denoted by Q . That is, P consists of all points in K whose y -coordinates are 0 under the standard embedding of K while Q consists of all points in K whose y -coordinates are 1 under the standard embedding of K .

Proposition 1.6. *Let h be a homeomorphism of K onto itself. Then endpoints of layers of K are mapped by h to endpoints of layers of K and vertices of K are mapped by h to vertices of K .*

Proof. Since every layer of K is an arc, the endpoints of layers of K must be mapped to endpoints of layers of K . If v is a vertex of K , then it is in the interior of some non-continuity layer of K . Thus, $h(v)$ must be contained the interior of some layer of K . Furthermore, if U is an open subset of K containing $h(v)$, then $h^{-1}(U)$ is an open subset of K containing v and thus must contain an infinite number of endpoints of layers of K , whence U must contain an infinite number of endpoints of layers of K . Therefore, $h(v)$ is also a vertex of K . \square

Corollary 1.7. *If h is a homeomorphism of K onto itself, then every Λ -layer or V -layer of K is mapped to a Λ -layer or V -layer of K and every layer of continuity of K is mapped to a layer of continuity of K .*

Lemma 1.8. *Let h be a homeomorphism of K onto itself. Then $h(\{E, E'\}) = \{E, E'\}$. Furthermore, if $h(p) \in \{p, p'\}$, then $h(P) = P$ and $h(Q) = Q$, and if $h(p) \in \{q, q'\}$, then $h(P) = Q$ and $h(Q) = P$.*

Proof. Let $g : K \rightarrow [0, 1]$ be a Kuratowski map. Then $g \circ h$ is also a Kuratowski map. Thus, $h(\{E, E'\}) = h((g \circ h)^{-1}(\{0, 1\})) = h(h^{-1}(g^{-1}(\{0, 1\}))) = g^{-1}(\{0, 1\}) = \{E, E'\}$.

Suppose now that $h(p) \in \{p, p'\}$, but that there exists a nonempty subset C of P such that $h(c) \notin P$ for every $c \in C$. By Proposition 1.6, it follows that $h(c) \in Q$ for every $c \in C$. Since h is a homeomorphism, it follows that for every $c \in C$, there exists an open subset U_c of K containing c such that $h(P \cap U_c) \subset Q$. Let $D = P \setminus C$ —the set of all members of P mapped into P by h . Again, since h is a homeomorphism, it follows that for every $d \in D$, there is an open subset U_d of K containing d such that $h(P \cap U_d) \subset P$. Note that $C = \bigcup_{c \in C} (P \cap U_c)$ is open in P and that $D = \bigcup_{d \in D} (P \cap U_d)$ is also open in P . Also, since $C = P \setminus D$, it follows that both C and D are also closed in P .

Let g be a Kuratowski map of K onto $[0, 1]$ as before. Since g is continuous, $g(C)$ and $g(D)$ are both closed in $[0, 1]$. Since $[0, 1] = g(C) \cup g(D)$ and $g(C) = [0, 1] \setminus g(D)$ with $g(C)$ and $g(D)$ both nonempty, it follows that $g(C)$ and $g(D)$ are also open in $[0, 1]$, making them both nonempty, open and closed subsets of $[0, 1]$ whose union is $[0, 1]$. This contradicts that $[0, 1]$ is connected. Therefore, $h(P) = P$ and $h(Q) = Q$.

It follows similarly that if $h(p) \in \{q, q'\}$, then $h(P) = Q$ and $h(Q) = P$. \square

The following is a lemma which will be referenced in many of the proofs of Section 3. We will denote by π the projection of the xy -plane onto the y -axis so that $\pi(x, y) = (0, y)$ for every $(x, y) \in \mathbb{R}^2$. It should also be noted in the following lemma that by *maximal subarc*, we allow the possibility of the empty set or a singleton.

Lemma 1.9. *Let (A_1, A_2, A_3, \dots) be a sequence of arcs in \mathbb{R}^2 converging to $\{0\} \times [0, 1]$ as $i \rightarrow \infty$ so that for each $i \in \mathbb{N}$, $\pi \upharpoonright A_i$ is a homeomorphism of A_i onto $\pi(A_i)$. Let h be a homeomorphism of the xy -plane onto itself so that $h(\{0\} \times [0, 1]) = \{0\} \times [0, 1]$. For every $t \in [0, 1]$ and for each $i \in \mathbb{N}$, let $C_{t,i}$ denote the maximal subarc of $h(A_i)$ having the property that each of its endpoints lie on the horizontal line given by the equation $y = t$. Then for every $t \in [0, 1]$, $\text{diam}(C_{t,i}) \rightarrow 0$ as $i \rightarrow \infty$.*

Proof. Let $t \in [0, 1]$, and let T denote the line given by the equation $y = t$. For each $i \in \mathbb{N}$, let $C_i := C_{t,i}$, and let T_i be the line segment contained in T whose endpoints are the endpoints of C_i . Note that since $T_i \rightarrow \{(0, t)\}$ as $i \rightarrow \infty$, we have $h^{-1}(T_i) \rightarrow \{h^{-1}((0, t))\}$ as $i \rightarrow \infty$. Thus, the endpoints of $h^{-1}(T_i)$ converge to $\{h^{-1}((0, t))\}$ as $i \rightarrow \infty$. Since for each $i \in \mathbb{N}$, $\pi \upharpoonright A_i$ is a homeomorphism of A_i onto $\pi(A_i)$, and because the endpoints of $h^{-1}(C_i)$ are also the endpoints of $h^{-1}(T_i)$, it follows that $h^{-1}(C_i) \rightarrow \{h^{-1}((0, t))\}$ as $i \rightarrow \infty$. Therefore $h(C_i) \rightarrow \{(0, t)\}$ as $i \rightarrow \infty$, whence $\text{diam}(C_i) \rightarrow 0$ as $i \rightarrow \infty$. \square

2. EMBEDDINGS OF K : \aleph_0 -MANY ENDPOINTS OF LAYERS INACCESSIBLE

Here, we construct a collection of \mathfrak{c} -many mutually inequivalent planar embeddings of K . Each embedding from this collection has the property that all but a countably infinite set of layers of continuity (straight-arc layers) have at least one point not being accessible from the complement of the image of the embedding. More precisely, we fix a sequence $\mathcal{Q} = (Q_1, Q_2, Q_3, \dots)$ of interior layers of continuity of K converging to the left end layer E of K , arranged in order from right to left. After this, we choose an arbitrary sequence (L_1, L_2, L_3, \dots) of V or Λ layers of K such that for each $i \in \mathbb{N}$, L_i lies between Q_i and Q_{i+1} , with L_0 designated as the right end layer E' of K . Then, we choose a sequence $A = (a_1, a_2, a_3, \dots)$ of 0's and 1's so that for each $i \in \mathbb{N}$, we produce a certain planar re-embedding of $[r(L_i), \ell(L_{i-1})]$ which keeps Q_i straight and perturbs $[r(L_i), Q_i) \cup (Q_i, \ell(L_{i-1})]$ about Q_i in a certain manner depending on when $a_i = 0$ or when $a_i = 1$. In doing so, every point in the image of Q_i under such a re-embedding is inaccessible from the complement when $a_i = 0$, and all but one endpoint of Q_i is inaccessible from the complement if $a_i = 1$. Each such re-embedding is made in such a way that the union of their images together with $E = \{0\} \times [0, 1]$ is a re-embedding of K . We will see that two embeddings constructed according to different sequences of 0's and 1's will produce inequivalent embeddings, thus providing us with a collection of \mathfrak{c} -many mutually inequivalent planar embeddings of K .

To understand how \mathcal{Q} is used to provide a collection of mutually inequivalent embeddings, we must motivate how to construct what we call *Type-0* and *Type-1* planar embeddings of K about one of its interior layers of continuity. Suppose Q is an interior layer of continuity of K , with its bottom endpoint labeled b and its top endpoint labeled t . Two ways in which we can embed K in the plane is so that the image of Q has none of its points

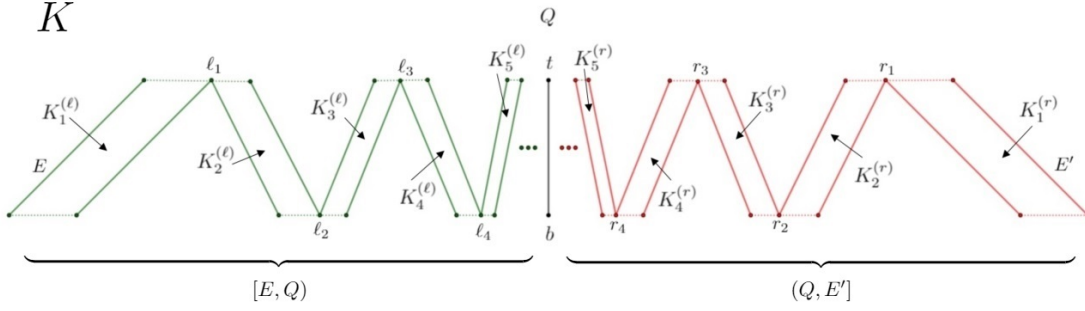

FIGURE 3. The decomposition of $[E, Q)$ and $(Q, E']$, where E and E' are the left and right end-layers of K , respectively, and the interior layer of continuity Q is the straight arc in the middle. The thick red and green line segments other than E and E' are either Λ -layers or V -layers of K defining the aforementioned decompositions, where as the dotted horizontal red and green line segments represent the endpoints and vertices of interior layers of each $K_i^{(\ell)}$ and each $K_i^{(r)}$, respectively.

accessible or so that only the image of b is accessible. Again, let E and E' denote the left and right end layers of K respectively.

We will now describe a decomposition of $[E, Q)$ and $(Q, E']$ as shown in Figure 3. Let $K_1^{(\ell)}, K_2^{(\ell)}, K_3^{(\ell)}, \dots$ be a decomposition of $[E, Q)$ with $K_i^{(\ell)} \rightarrow Q$ as $i \rightarrow \infty$ and so that for each $i \in \mathbb{N}$,

- (1 $_{\ell, i}$.) $K_i^{(\ell)}$ is a homeomorphic copy of K ,
- (2 $_{\ell, i}$.) $K_i^{(\ell)} \cap K_j^{(\ell)} \neq \emptyset$ if and only if $|i - j| \leq 1$, and
- (3 $_{\ell, i}$.) $K_i^{(\ell)} \cap K_{i+1}^{(\ell)} = \{\ell_i\}$, where ℓ_i is the vertex of a Λ -layer of K if i is odd and is the vertex of a V -layer of K if i is even.

Similarly, let $K_1^{(r)}, K_2^{(r)}, K_3^{(r)}, \dots$ be a decomposition of $(Q, E']$ with $K_i^{(r)} \rightarrow Q$ as $i \rightarrow \infty$ and so that for each $i \in \mathbb{N}$,

- (1 $_{r, i}$.) $K_i^{(r)}$ is a homeomorphic copy of K ,
- (2 $_{r, i}$.) $K_i^{(r)} \cap K_j^{(r)} \neq \emptyset$ if and only if $|i - j| \leq 1$, and
- (3 $_{r, i}$.) $K_i^{(r)} \cap K_{i+1}^{(r)} = \{r_i\}$, where r_i is the vertex of a Λ -layer of K if i is odd and is the vertex of a V -layer of K if i is even.

A depiction of the aforementioned decomposition of $[E, Q)$ and $(Q, E']$ is shown in Figure 3.

2.1. Type-0 and Type-1 Planar Embeddings of K about Q .

Given the decompositions in the previous paragraph, we shall describe how to construct a planar embedding ζ of K so that zero points of $\zeta(Q)$

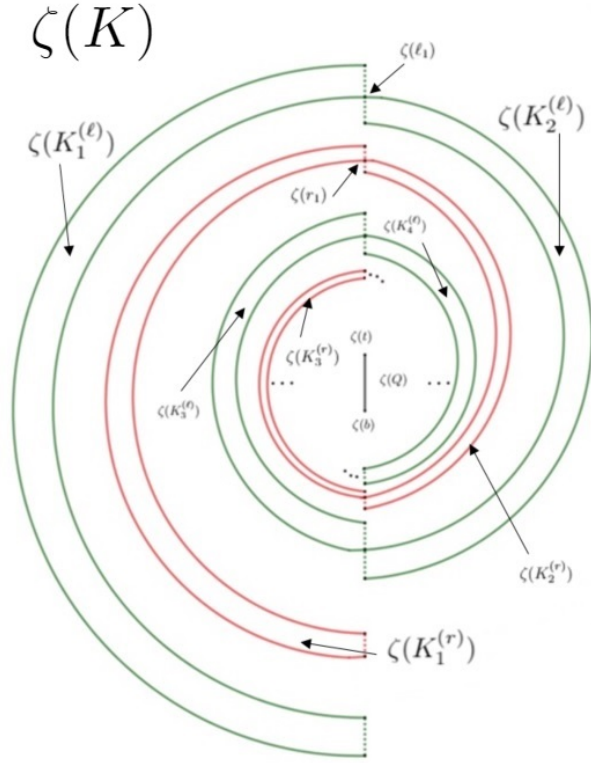

FIGURE 4. A type-0 planar embedding of K about the interior layer of continuity Q . Note that $\zeta(Q)$ is completely "buried" by $\zeta([E, Q])$ and $\zeta((Q, E'])$ in the sense that no point of $\zeta(Q)$ is accessible from the complement of $\zeta(K)$.

are accessible from the complement of the $\zeta(K)$. The most efficient way to describe such an embedding is through comparing Figure 3 with Figure 4. Again, Figure 3 depicts K with the decompositions of $[E, Q)$ and $(Q, E']$ as mentioned above. Figure 4 depicts $\zeta(K)$ by exhibiting how Q and the elements of the aforementioned decompositions are mapped under ζ . As shown there, $\zeta(Q)$ is mapped to a vertical line segment so that $\zeta(b)$ is its bottom endpoint and $\zeta(t)$ is its top endpoint. The rest of $[E, Q)$ and $(Q, E']$ is mapped by ζ in such a way that the image of the top endpoints and vertices of layers of $K \setminus Q$ converge to $\zeta(t)$ and $\zeta(b)$, respectively, while bending, stretching, and shrinking members of the decompositions in such a way so that $\zeta : K \rightarrow \zeta(K)$ is a homeomorphism. In doing so, no point of $\zeta(Q)$ is accessible from the complement of $\zeta(K)$. Such an embedding is similar in nature to an embedding of a double $\sin(1/x)$ -curve with two rays approaching one limiting arc in the middle, as shown in Figure 5. We call the planar embedding ζ a **type-0 planar embedding of K about Q** , or just a **type-0 embedding** for short.

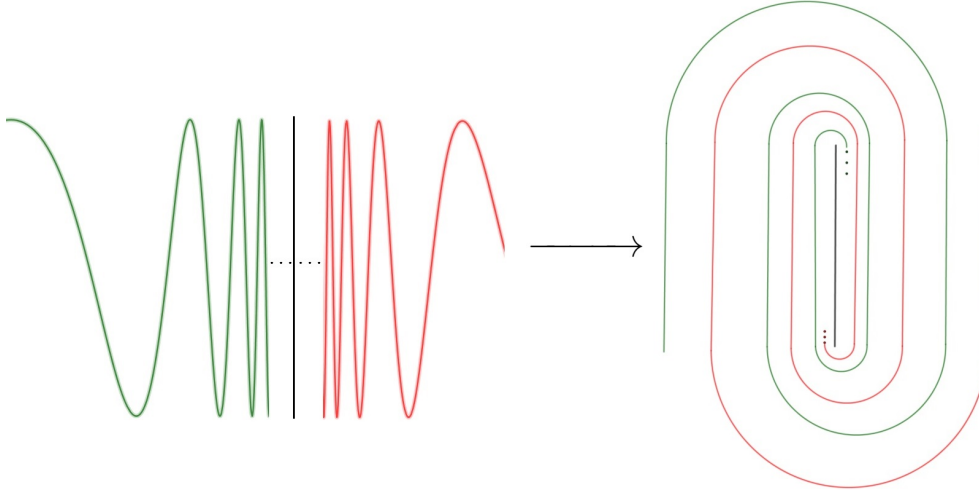

FIGURE 5. Here, we have a double $\sin(1/x)$ -curve with two rays on opposite sides of a single limiting arc being re-embedded in the plane so that both approaching rays completely "bury" the limiting arc, making no point of it accessible from the complement. This embedding stands as a model for the type-0 planar embedding ζ of K shown in Figure 4.

Also given the previous decompositions of $[E, Q)$ and $(Q, E']$, we shall next describe how to construct a planar embedding ξ of K so that only one of the points of $\xi(Q)$ is accessible from the complement of $\xi(K)$. In fact, since the interiors of interior layers of continuity of K are inaccessible under any planar embedding of K , the single accessible point under this type of embedding will be an endpoint of $\xi(Q)$. Just as in the description of the type-0 embedding, the most efficient way to describe the embedding ξ is through comparing Figure 3 with Figure 6. Figure 6 depicts $\xi(K)$ by showing how Q and the elements of the aforementioned decompositions are mapped under ξ . As shown there, $\xi(Q)$ is mapped to a vertical line segment so that $\xi(b)$ is its bottom endpoint and $\xi(t)$ is its top endpoint. The rest of $[E, Q)$ and $(Q, E']$ is mapped by ξ in such a way that the image of the top endpoints and vertices of layers of $K \setminus Q$ converge to $\xi(t)$ and $\xi(b)$, respectively, while bending, stretching, and shrinking members of the decompositions in such a way so that $\xi : K \rightarrow \xi(K)$ is a homeomorphism. In doing so, $\xi(b)$ is accessible from the complement of $\xi(K)$ while every other point of $\xi(Q)$ is not. Such an embedding is similar in nature to an embedding of a double $\sin(1/x)$ -curve with two rays approaching one limiting arc in the middle, as shown in Figure 7. We call the planar embedding ξ a **type-1 planar embedding of K about Q** , or just a **type-1 embedding** for short.

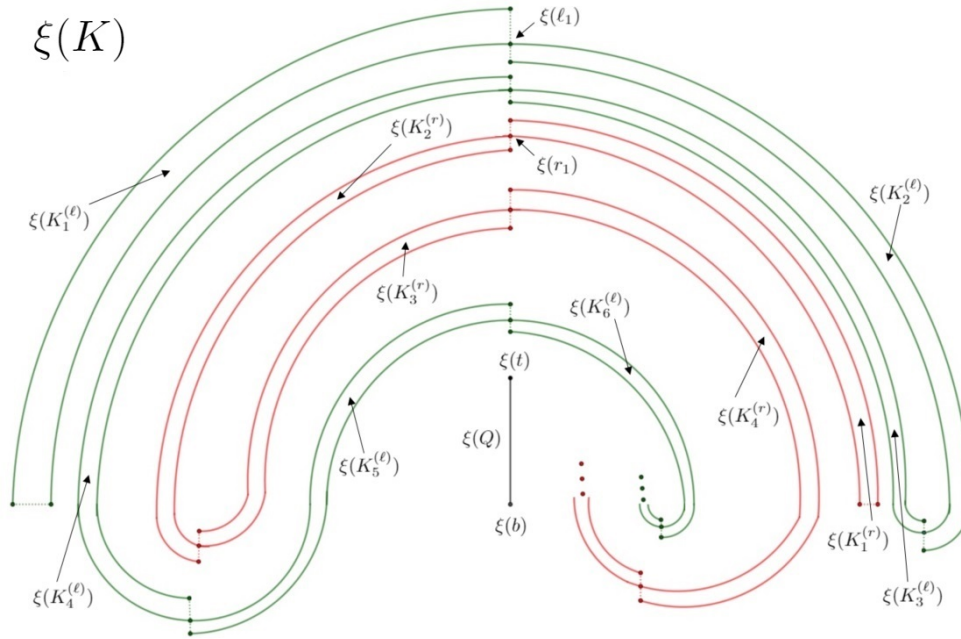

FIGURE 6. A type-1 planar embedding of K about the interior layer of continuity Q . Note that $\xi(b)$ will remain accessible from the complement of $\xi(K)$, but $\xi(t)$ will not.

Proposition 2.1. *Let ζ and ξ be a type-0 and type-1 planar embedding of K about an interior layer of continuity, Q , of K . Then ζ and ξ are inequivalent planar embeddings of K .*

Proof. Since $\zeta(K)$ and $\xi(K)$ have a different set of accessible points, in particular, since no endpoints of $\zeta(Q)$ is accessible from the complement of $\zeta(K)$ while one endpoint of $\xi(Q)$ is accessible from the complement of $\xi(K)$, it follows by Proposition 1.1 that ζ and ξ are inequivalent planar embeddings of K . \square

2.2. A Collection of \mathfrak{c} -many Mutually Inequivalent Planar Embeddings of K .

We will now construct the \mathfrak{c} -many mutually inequivalent planar embeddings of K , all of which do not preserve the accessibility of points in K which are accessible from the complement of the standard embedding of K . For each such embedding, we will make use of a fixed sequence $\mathcal{Q} = (Q_1, Q_2, Q_3, \dots)$ of interior layers of continuity of K converging to the left end layer E of K as mentioned in the first paragraph of this section. For convenience, we may assume that the Q_i 's are in order from right to left. That is, if g is a Kuratowski map of K such that $g(E) = \{0\}$, then $g(Q_{i+1}) < g(Q_i)$ for each $i \in \mathbb{N}$.

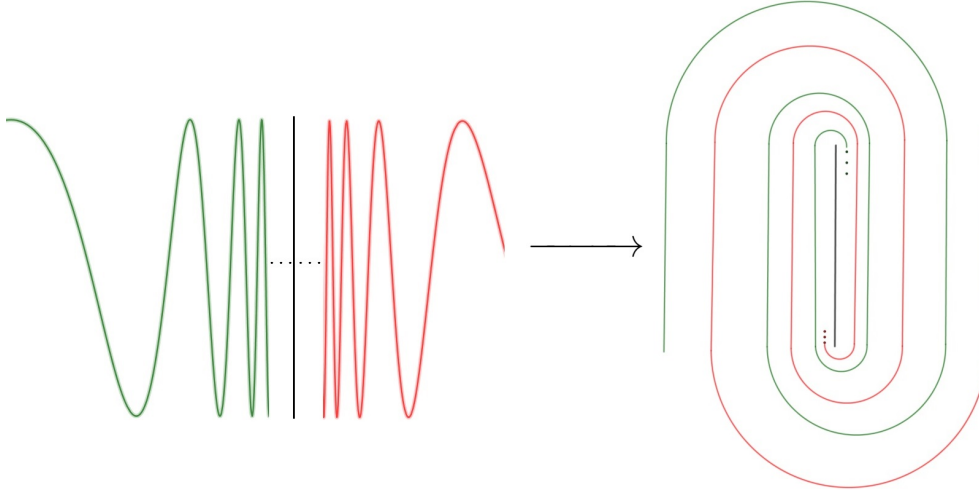

FIGURE 7. As in Figure 5, we have a double $\sin(1/x)$ -curve with two rays on opposite sides of a single limiting arc being re-embedded in the plane, this time so that both limiting arcs "bury" the top endpoint of the limiting arc, leaving only one point—the bottom endpoint—accessible from the complement. This embedding stands as a model for the type-1 planar embedding ξ of K shown in Figure 6.

For each $i \in \mathbb{N}$, let L_i be either a V -layer or Λ -Layer of K in between Q_i and Q_{i+1} , and designate L_0 to be the right end-layer, E' , of K . Also for each $i \in \mathbb{N}$, decompose $[r(L_i), Q_i]$ and $(Q_i, \ell(L_{i-1}))$ in the same way as the decomposition of $[E, Q]$ and (Q, E') as given at the beginning of this section.

Let $A = (a_1, a_2, a_3, \dots)$ be a sequence so that for each $i \in \mathbb{N}$, $a_i = 0$ or $a_i = 1$. That is, A is a sequence of 0's and 1's. For each $i \in \mathbb{N}$, let a_i be assigned to the layer Q_i . If $a_i = 0$, replace $[r(L_i), \ell(L_{i-1})]$ (which is homeomorphic to K) with a type-0 embedding of $[r(L_i), \ell(L_{i-1})]$ about Q_i by using the aforementioned decompositions of $[r(L_i), Q_i]$ and $(Q_i, \ell(L_{i-1}))$. If $a_i = 1$, replace $[r(L_i), \ell(L_{i-1})]$ with a type-1 embedding of $[r(L_i), \ell(L_{i-1})]$ about Q_i , again by using the aforementioned decompositions of $[r(L_i), Q_i]$ and $(Q_i, \ell(L_{i-1}))$. Furthermore, make all such replacements be so that their images converge to E as $i \rightarrow \infty$, resulting in the image of a planar embedding of K . We will call such an embedding a **type- A planar embedding of K about \mathcal{Q}** , or just a **type- A embedding** for short.

Let \mathcal{Z} be the collection of all sequences of 0's and 1's.

Lemma 2.2. *Let $A = (a_1, a_2, a_3, \dots)$ and $B = (b_1, b_2, b_3, \dots)$ be nonidentical sequences in \mathcal{Z} and let α and β denote type- A and type- B embeddings of K*

about \mathcal{Q} , respectively. Then α and β are inequivalent planar embeddings of K .

Proof. Suppose h is a homeomorphism of the plane onto itself so that $h(\alpha(K)) = \beta(K)$. By Corollary 1.7, it follows that $h(\alpha(Q_i))$ is a layer of continuity of $\beta(K)$ for each $i \in \mathbb{N}$. Since for each $i \in \mathbb{N}$, $\alpha(Q_i)$ has all but at least one endpoint inaccessible from the complement of $\alpha(K)$, it follows that $h(\alpha(Q_i))$ must be a $\beta(Q_{j(i)})$ for some $j(i) \in \mathbb{N}$. Furthermore, by Proposition 1.4, we have $j(i) = i$ for each $i \in \mathbb{N}$. Since A and B are nonidentical, there is a $k \in \mathbb{N}$ such that $a_k \neq b_k$, in which case $h(\alpha(Q_k)) = \beta(Q_k)$ and thus, $h(\alpha([r(L_k), \ell(L_{k-1})])) = \beta([r(L_k), \ell(L_{k-1})])$. However, this contradicts Proposition 2.1 since $\alpha \upharpoonright [r(L_k), \ell(L_{k-1})]$ is a type-0 embedding about Q_k and $\beta \upharpoonright [r(L_k), \ell(L_{k-1})]$ is a type-1 embedding about Q_k . \square

Theorem 2.3. *There exist \mathfrak{c} -many mutually inequivalent planar embeddings of K .*

Proof. Let \mathcal{E} be the collection of A -type embeddings of K about \mathcal{Q} for each $A \in \mathcal{Z}$. By Lemma 2.2, members of \mathcal{E} are pairwise inequivalent. Therefore, $|\mathcal{E}| = |\mathcal{Z}|$. Since it is well known that $|\mathcal{Z}| = \mathfrak{c}$, it follows that $|\mathcal{E}| = \mathfrak{c}$. \square

Theorem 2.3 gives greater insight to Question 6 in [2], providing an example of an HDCC having uncountably many, and, in fact, \mathfrak{c} -many mutually inequivalent planar embeddings which is not an HDCC containing a dense ray. Furthermore, K is an HDCC satisfying this property while having no subcontinuum containing a dense ray. However, these embeddings fail to preserve the accessibility of all points which are accessible in the image of the standard planar embedding of K .

3. EMBEDDINGS OF K : ENDPOINTS OF ALL LAYERS ACCESSIBLE

In this section, we construct a collection of \mathfrak{c} -many mutually inequivalent planar embeddings of K , each of whose image has the same set of accessible points as the image of the standard embedding of K . That is, under each such embedding, the image of every point of each end layer, V -layer, and Λ -layer will be accessible, and the image of both endpoints of each interior layer of continuity will also be accessible. Before proceeding, we must first provide the following definition and lemma.

Definition 3.1. Let \mathbf{N} and \mathbf{M} be sequences of positive integers. We say that \mathbf{N} and \mathbf{M} are inequivalent if and only if, after removing any finite initial

subsequence of \mathbf{N} and any finite initial subsequence of \mathbf{M} , the remaining sequences \mathbf{N}' and \mathbf{M}' are not identical.

Lemma 3.2. *There exist \mathfrak{c} -many mutually inequivalent sequences of positive integers.*

Proof. Let \mathcal{N} denote the set of all sequences of positive integers, and let $A = (a_1, a_2, a_3, \dots) \in \mathcal{N}$. We shall inductively define the sets A_n so that $A_1 = \{A\}$, and for every integer $n > 1$,

$$A_n = \{(s_1, s_2, s_3, \dots) \in \mathcal{N} \mid (s_n, s_{n+1}, s_{n+2}, \dots) = (a_n, a_{n+1}, a_{n+2}, \dots)\}.$$

Note that A_n is countable for every $n = 1, 2, \dots$. Let $\mathcal{A} = \bigcup_{n=1}^{\infty} A_n$, which forms an equivalence class of all sequences of positive integers equivalent to A . Then \mathcal{A} is also countable as it is the countable union of countable sets. Denote by \mathcal{I} the set of all such equivalence classes, \mathcal{A} .

Since each equivalence class in \mathcal{I} is countable and $\bigcup \mathcal{I} = \mathcal{N}$ which has cardinality \mathfrak{c} , it follows that the cardinality of \mathcal{I} is a cardinal κ satisfying $\mathfrak{c} = \kappa \otimes \aleph_0$, where \otimes here denotes cardinal multiplication. By Corollary 10.13 of [8], as well as Section IX.6 of [20], it follows that $\kappa = \mathfrak{c}$. \square

3.1. Constructing Schema Embeddings of K .

Let $\mathbf{N} = (n_1, n_2, n_3, \dots)$ be a sequence of positive even integers greater than or equal to 4. We will construct a planar embedding $\psi_{\mathbf{N}}$ of K based on a subsequently defined set of instructions for geometrically altering parts of the standard embedding of K . To do so, we must first define a decomposition of each K_i , an example of which is shown in Figure 8. For each $i \in \mathbb{N}$, let $K_i \subset K$ be a homeomorphic copy of K so that the right end layer of K_1 is the right end layer of K , so that $K_i \cap K_j \neq \emptyset$ if and only if $|i - j| \leq 1$, and so that $K_i \cap K_{i+1} = \{p_i\}$ is a vertex of a V -layer of K . Also for each $i \in \mathbb{N}$, let $K_i^{(1)}, \dots, K_i^{(2n_i)}$ be a decomposition of K_i so that

- (1 $_{K_i}$.) $K_i^{(l)}$ is a homeomorphic copy of K ,
- (2 $_{K_i}$.) the right end layer of $K_i^{(1)}$ is the right end layer of K_i and the left end layer of $K_i^{(2n_i)}$ is the left end layer of K_i ,
- (3 $_{K_i}$.) $K_i^{(l)} \cap K_i^{(m)} \neq \emptyset$ if and only if $|l - m| \leq 1$,
- (4 $_{K_i}$.) $K_i^{(l)} \cap K_i^{(l+1)} = \{s_i^{(l)}\}$ is the vertex of a Λ -layer of K when l is odd and is the vertex of a V -layer when l is even.

Again, the above decomposition of K_i is depicted in Figure 8. Recall that in section 1, we let P denote the set of all points in the standard embedding of K whose y -coordinates are 0, and we let Q denote the set of all points in the standard embedding of K whose y -coordinates are 1. That is, P is the

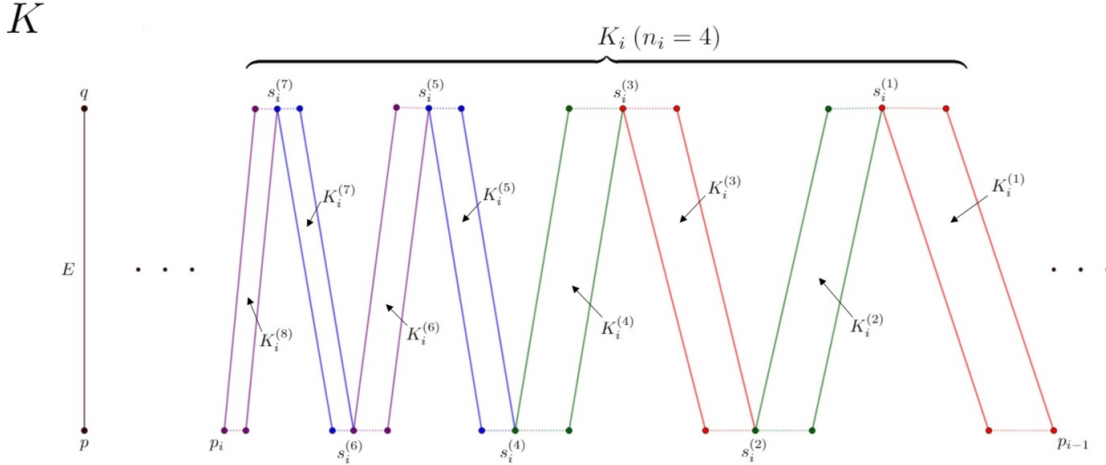

FIGURE 8. K_i , where $n_i = 4$, decomposed into $2n_i = 8$ pieces each homeomorphic to K .

set of all bottom endpoints and vertices of layers of K while Q is the set of all top endpoints and vertices of layers of K . Each of the next constructed embeddings will have the property that P is mapped below the line $y = 1/2$ and that Q is mapped above the line $y = 1/2$. We shall thus refer to the line $y = 1/2$ as *the critical line* of each of the following embeddings.

We will inductively define, for each $i \in \mathbb{N}$, a list of planar embeddings of K_i , whose images are resembled in Figure 9, as follows. First, embed K_1 in the xy -plane where $x > 0$ so that the endpoints and vertices of layers K_1 are contained outside of the critical line, with the top endpoints and vertices of K_1 in the part above the critical line, and the bottom endpoints and vertices in the part below the critical line, with every arc that is straight in K_1 kept straight under this embedding. We then change this embedding as follows. Reflect, through ambient three-dimensional space, $K_1^{(n_1)} \cup \dots \cup K_1^{(2n_1)}$, about the point $s_1^{(n_1-1)}$ where $K_1^{(n_1-1)}$ and $K_1^{(n_1)}$ intersect, in such a way that the point where $s_1^{(n_1+k)}$ is vertically collinear with $s_1^{(n_1-k)}$ for every $k = 1, 2, \dots, n_1 - 1$.³ Moreover, this is done while keeping top and bottom endpoints and vertices of layers of K_1 respectively above and below the critical line and keeping straight under this re-embedding of K_1 every arc that is straight in the standard embedding of K_1 , smoothly stretching and squeezing where needed. We shall let this re-embedding of K_1 be named $\psi_{\mathbb{N},1}$.

³By *vertically collinear*, we mean that these points lie on the same vertical line in the xy -plane.

Assume now that for some $i \in \mathbb{N}$, we have constructed $\psi_{\mathbf{N},j}$ for every $j = 1, \dots, i$. We construct $\psi_{\mathbf{N},i+1}$ somewhat similar to the way $\psi_{\mathbf{N},1}$ was constructed, this time so that $\psi_{\mathbf{N},i+1}(K_{i+1})$ meets with $\psi_{\mathbf{N},i}(K_i)$ at only $\psi_{\mathbf{N},i}(p_i)$ with $K_{i+1}^{(1)}$ being smoothly stretched by $\psi_{\mathbf{N},i+1}$ below and to the left of $\psi_{\mathbf{N},i}(K_i)$, with the rest of $\psi_{\mathbf{N},i+1}(K_{i+1})$ placed between the y -axis and $\psi_{\mathbf{N},i+1}(K_{i+1}^{(1)}) \cup \bigcup_{j=1}^i \psi_{\mathbf{N},j}(K_j)$. In doing so, the only arcs that are straight in the standard embedding of K_{i+1} being kept straight under $\psi_{\mathbf{N},i+1}$ are those contained in $K_{i+1}^{(2)}, \dots, K_{i+1}^{(2n_{i+1})}$. Furthermore, we make sure that $\psi_{\mathbf{N},i}(K_i)$ converges to the line segment $\{0\} \times [0, 1]$ as $i \rightarrow \infty$, doing so in a way that the resulting function $\psi_{\mathbf{N}} : K \rightarrow \psi_{\mathbf{N}}(K)$, as given in the following definition, is a homeomorphism, and thus, a planar embedding of K .

Definition 3.3. Given the elements in the construction above, the **schema embedding of K according to \mathbf{N}** , denoted as $\psi_{\mathbf{N}}$, is the planar embedding of K whose image is given by

$$\psi_{\mathbf{N}}(K) = \text{cl}\left(\bigcup_{i=1}^{\infty} \psi_{\mathbf{N},i}(K_i)\right) = (\{0\} \times [0, 1]) \cup \bigcup_{i=1}^{\infty} \psi_{\mathbf{N},i}(K_i),$$

where the left end layer E of K is mapped onto the line segment $\{0\} \times [0, 1]$ so that the bottom endpoint p of E is mapped to $(0, 0)$ and the top endpoint q of E is mapped to $(0, 1)$. That is, $\psi_{\mathbf{N}}$ is defined by

$$\psi_{\mathbf{N}}(x) = \begin{cases} \psi_{\mathbf{N},i}(x) & \text{if } x \in K_i \\ x & \text{if } x \in E \end{cases}$$

A depiction showing $\psi_{\mathbf{N}}(K)$ with $\psi_{\mathbf{N},i}(K_i)$, where $n_i = 4$, is given in Figure 9. Such embeddings somewhat mimic the type of embeddings of the $\sin(1/x)$ -curve portrayed in Figure 10. It is worth noting that although $\psi_{\mathbf{N}}(K_i^{(1)})$ is bent for each $i \in \mathbb{N}$, these bends become less profound as i increases. More precisely, for every $\epsilon > 0$ there exists an $N_\epsilon \in \mathbb{N}$ such that for all $i \geq N_\epsilon$ and for every maximally straight arc A contained in the standard embedding of $K_i^{(1)}$, there exists a homeomorphism h_A mapping $\psi_{\mathbf{N}}(A)$ onto $\pi(\psi_{\mathbf{N}}(A))$ such that $\|(\pi \upharpoonright \psi_{\mathbf{N}}(A)) - h_A\| < \epsilon$, where $\|\cdot\|$ is the supremum norm. Furthermore, recall again that we denoted by P and Q the set of all bottom and top endpoints and vertices of layers of K , respectively. Likewise, for each $i \in \mathbb{N}$, denote by P_i and Q_i the set of all bottom and top endpoints and vertices of layers of K_i , respectively. We also note that in order to make $\psi_{\mathbf{N}}$ a homeomorphism onto its image, we ensure that $\psi_{\mathbf{N}}(P_i) \rightarrow \{\psi_{\mathbf{N}}(p)\} = \{(0, 0)\}$ and $\psi_{\mathbf{N}}(Q_i) \rightarrow \{\psi_{\mathbf{N}}(q)\} = \{(0, 1)\}$ as $i \rightarrow \infty$.

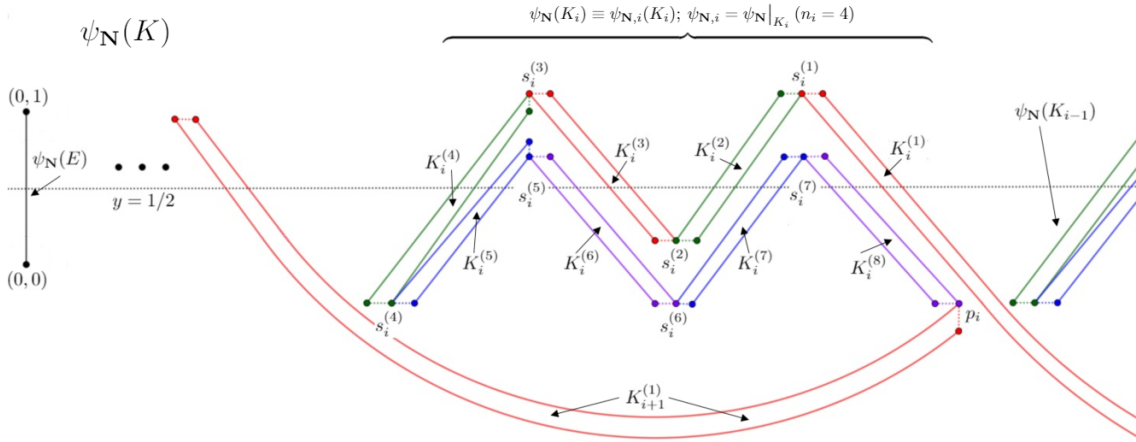

FIGURE 9. A subschema embedding, $\psi_{\mathbf{N},i}(K_i)$, with $n_i = 4$. Each labeled $K_i^{(l)}$ is really $\psi_{\mathbf{N}}(K_i^{(l)})$ for each $l = 1, 2, \dots, 8$. Note that we have $\psi_{\mathbf{N},i+1}(K_{i+1})$ meeting $\psi_{\mathbf{N},i}(K_i)$ at the point $\psi_{\mathbf{N},i}(p_i) = \psi_{\mathbf{N},i+1}(p_i)$, simply labeled p_i on the figure.

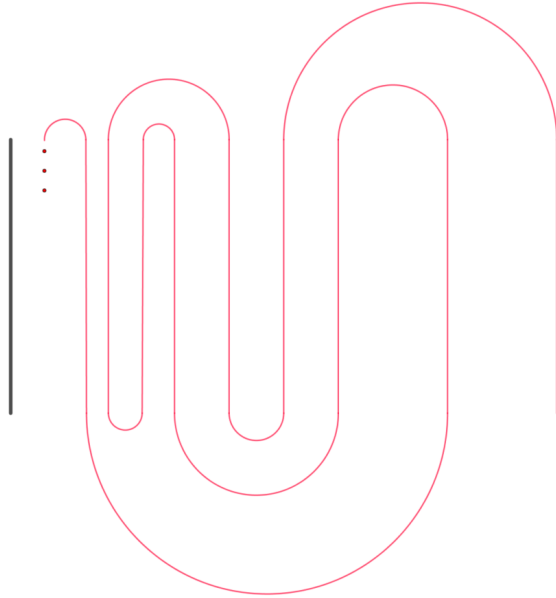

FIGURE 10. The image of an embedding of the $\sin(1/x)$ -curve which stands as a crude model for the image of K under a schema embedding $\psi_{\mathbf{N}}$ according to a sequence \mathbf{N} of positive even integers greater than or equal to 4, with $n_1 = 4$.

Proposition 3.4. *For every sequence \mathbf{N} of positive even integers greater than or equal to 4, $\psi_{\mathbf{N}}$ is a homeomorphism of K onto its image. That is, $\psi_{\mathbf{N}}$ is indeed a planar embedding of K .*

Remark 3.5. If $\mathbf{N} = (n, n, n, \dots)$ is a sequence of which every term is the same even positive integer, n , greater than or equal to 4, then we may denote the schema embedding $\psi_{\mathbf{N}}$ as ψ_n . Thus, it should be understood what is meant by, say, the embeddings ψ_4, ψ_6, ψ_8 , etc.

We allow intuition based on the geometric description of the constructions of each $\psi_{\mathbf{N}}(K)$ to substitute as sketches of proofs for the next two propositions.

Proposition 3.6. *Given a sequence \mathbf{N} of positive even integers greater than or equal to 4, all endpoints of layers of K and all points of V and Λ layers of K are accessible under $\psi_{\mathbf{N}}$.*

That is, Proposition 3.6 states that all points which are accessible from the complement of the standard embedding of K are mapped by $\psi_{\mathbf{N}}$ so that they are accessible from the complement of $\psi_{\mathbf{N}}(K)$ for any given sequence \mathbf{N} of positive even integers greater than or equal to 4.

Proposition 3.7. *If \mathbf{N} and \mathbf{M} are equivalent sequences of positive even integers greater than or equal to 4, then $\psi_{\mathbf{N}}$ and $\psi_{\mathbf{M}}$ are equivalent planar embeddings of K .*

3.2. Schema Pockets and Escape Arcs.

In the remainder of this subsection, unless otherwise specified, it should be understood that \mathbf{N} (likewise, \mathbf{M}) is any sequence of positive integers greater than or equal to 4. For every $i \in \mathbb{N}$, there is a horizontal crosscut $C_{\mathbf{N},i}$ of $\psi_{\mathbf{N},i}(K_i)$ below the critical line with one endpoint being $\psi_{\mathbf{N}}(p_i)$ and other endpoint on the left end layer of $\psi_{\mathbf{N}}(K_i^{(1)})$. This means $\psi_{\mathbf{N}}(K) \cup C_{\mathbf{N},i}$ separates the plane into two open connected components, the bounded component being a topological open disk which we will call the i^{th} **schema pocket** of the complement of $\psi_{\mathbf{N}}(K)$ which we denote by $D_{\mathbf{N},i}$. (See Figure 11.)

For each $i \in \mathbb{N}$, let q_i be the top endpoint of $r(K_i)$. Then there is also a straight crosscut $C'_{\mathbf{N},i}$ having one endpoint being $\psi_{\mathbf{N}}(q_{i+1})$ and the other being the top endpoint of the left end layer of $\psi_{\mathbf{N}}(K_i^{(n_i)})$, with $C'_{\mathbf{N},i} \rightarrow (0, 1)$ as $i \rightarrow \infty$. This means $\psi_{\mathbf{N}}(K) \cup C'_{\mathbf{N},i}$ separates the plane into two open connected components, the bounded component also being a topological open disk which we will call the i^{th} **alternate schema pocket** of $\psi_{\mathbf{N}}(K)$ which will be denoted by $D'_{\mathbf{N},i}$. (Again, see Figure 11.)

Let L be a V -layer or Λ -layer of K . Then there exists a straight crosscut C whose endpoints are the endpoints of $\psi_{\mathbf{N}}(L)$. Thus, $\psi_{\mathbf{N}}(L) \cup C$ separates the

plane into two open connected components, the bounded component being a topological open disk which we will call the $\psi_{\mathbf{N}}(L)$ -**pocket**, or simply the L -**pocket** when the embedding $\psi_{\mathbf{N}}$ is understood. Such a pocket may be denoted as $D_{\mathbf{N},L}$.

Remark 3.8. We may designate the standard embedding of K as $\psi_{\mathbf{1}}$, where $\mathbf{1} = (1, 1, 1, \dots)$. Therefore, the i^{th} schema pocket, $D_{\mathbf{1},i}$, is not unique, but can be chosen to be a V -pocket or Λ -pocket of the standard embedding of K . Furthermore, suppose L_i is the the V -layer or Λ -layer of $\psi_{\mathbf{1}}(K)$ contained in the boundary of the pocket $D_{\mathbf{1},i}$. Then if g is a Kuratowski map of K , L_i can be chosen so that $L_i \rightarrow E$ as $i \rightarrow \infty$, with $g(L_{i+1}) < g(L_i)$ for each $i \in \mathbb{N}$.

Definition 3.9. Let $x \in \mathbb{R}^2 \setminus \psi_{\mathbf{N}}(K)$. Let J be an arc contained in $\mathbb{R}^2 \setminus \psi_{\mathbf{N}}(K)$ having x as an endpoint such that its other endpoint x' is contained in neither a schema pocket nor a subschema pocket of the complement of $\psi_{\mathbf{N}}(K)$.⁴ If also there exists a straight vertical ray A in the complement of $\psi_{\mathbf{N}}(K)$ having x' as its endpoint, then we say J is an **escape arc of x with respect to \mathbf{N}** . We may say that J is an escape arc of x , or simply, that J is an escape arc when the initial endpoint x of J and the embedding $\psi_{\mathbf{N}}$ are understood.

That is, J is an escape arc of x with respect to \mathbf{N} if J is a path which x may follow so that it may become "free to escape" arbitrarily far away below $\psi_{\mathbf{N}}(K)$ or arbitrarily far away above $\psi_{\mathbf{N}}(K)$ via a strait vertical ray A appended to J at its other endpoint x' .

Definition 3.10. Let J be as in Definition 3.9. Suppose further that J can be decomposed into J_1, \dots, J_n such that for each $i = 1, \dots, n$, J_i is a maximal subarc of J having the property that $\pi \upharpoonright J_i$ is a homeomorphism onto its image. If n is the least possible integer satisfying such a condition, then we say that J is a **minimal escape arc of x with respect to \mathbf{N}** . We may say that J is a minimal escape arc of x , or simply, that J is a minimal escape arc when the initial endpoint x of J and the embedding $\psi_{\mathbf{N}}$ are understood.

The meaning of Definition 3.10 is that a minimal escape arc is an escape arc that does not take random and unnecessary turns to escape below or above $\psi_{\mathbf{N}}(K)$. See Figure 11 for examples of minimal escape arcs.

⁴The purpose for the condition on the positioning of the other endpoint of J will become evident when understanding the notion of the depth given in Definition 3.13.

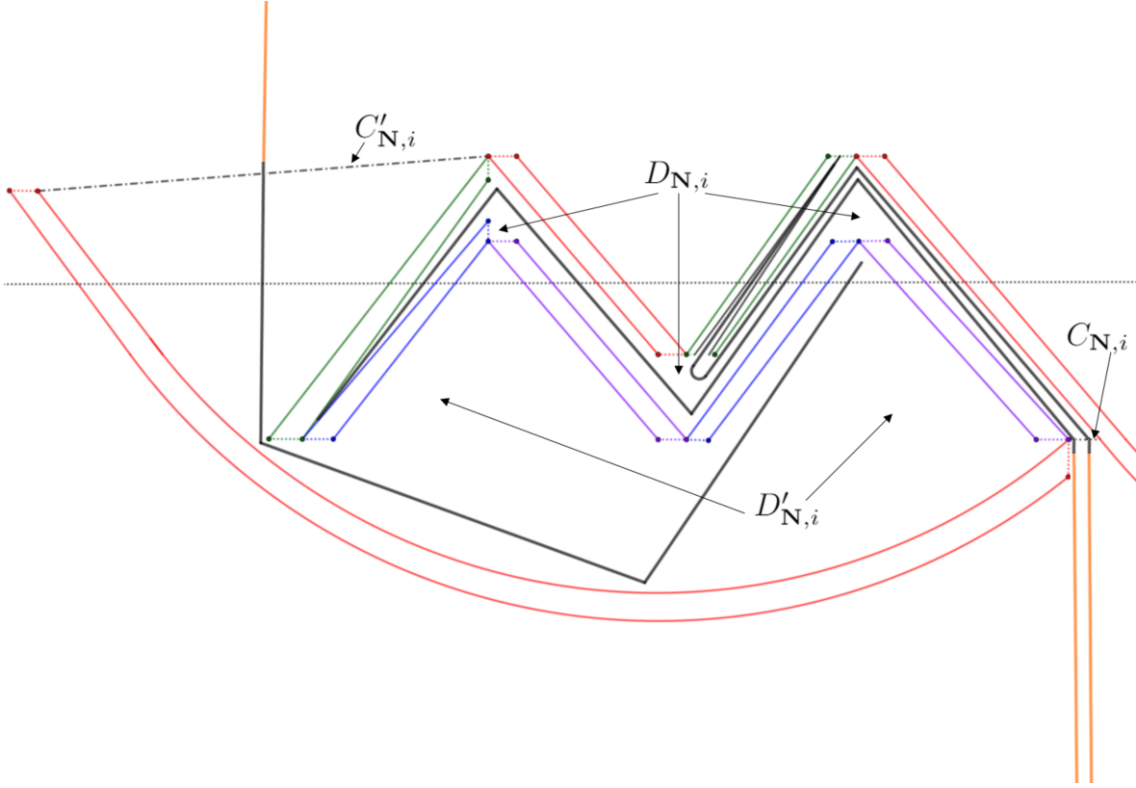

FIGURE 11. Depicted here is $\psi_{\mathbf{N}}(K_i) \cup \psi_{\mathbf{N}}(K_{i+1}^{(1)})$ with cross-cuts $C_{\mathbf{N},i}$ and $C'_{\mathbf{N},i}$ and their corresponding pockets $D_{\mathbf{N},i}$ and $D'_{\mathbf{N},i}$, respectively. What is also shown is an escape arc out of $D_{\mathbf{N},i}$ having depth 4, and escape arc out of $D_{\mathbf{N},i}$ from a Λ -pocket having a depth of 3, and an escape arc out of $D'_{\mathbf{N},i}$ having a depth of 2. The orange segments depict vertical rays moving away from the escape arcs.

Remark 3.11. Given a schema embedding $\psi_{\mathbf{N}}$ and a point x in the complement of $\psi_{\mathbf{N}}(K)$, we may wish to specify the type of pocket x may escape from through an escape arc J . That is, suppose R is a region which is either a schema pocket, an alternate schema pocket, a V -pocket, or a Λ -pocket of the complement of $\psi_{\mathbf{N}}(K)$. If $x \in R$ and J an escape arc of x , then we may say that J is an escape arc of x from R .

Definition 3.12. Let J be a minimal escape arc from a point of a schema pocket of the complement of a schema embedding of K , and let $z \in J$. We say that z is a **top (resp., bottom) turning point of J** if there exists an $\epsilon > 0$ so that for each horizontal line segment H contained in the open ball $B_{\epsilon}(z)$ of radius ϵ centered on z with the boundary of H contained in the boundary of $B_{\epsilon}(z)$, $H \cap J = \{z\}$ if and only if H contains z , $H \cap J$

contains two points if H is below (resp., above) z , and $H \cap J = \emptyset$ if H is above (resp., below) z .

That is, z is a turning point of an escape arc J if $\{z\} = J_i \cap J_{i+1}$ for some $i = 1, \dots, n-1$, where J_1, \dots, J_n is the decomposition of J into the least number of subarcs having the property that $\pi \upharpoonright J_i : J_i \rightarrow \pi(J_i)$ is a homeomorphism.

We now introduce the notion of depth of points (and subsets) in the complement of a given schema embedding.

Definition 3.13. Let x be as in Definitions 3.9 and 3.10. The **depth of x with respect to \mathbf{N}** , or simply, the **depth of x** when \mathbf{N} is understood, is the number of points of $J \setminus \{x\}$ contained in the critical line for any minimal escape arc J of x with respect to \mathbf{N} . If S is a subset of the complement of $\psi_{\mathbf{N}}(K)$, then we say that the **depth of S with respect to \mathbf{N}** is the maximum of the depths of all points contained in S if such maximum exists.⁵

Remark 3.14. Adding to Remark 3.11, we may wish to specify the depth a point x has within such a region R . If x is contained in R , we may say that the depth of x in R is the minimum number of times any minimal escape arc of x from R crosses the critical line in R . If x is not contained in R , we may take the convention to be that the depth of x in R is 0. However, this does not mean that the depth of x with respect to \mathbf{N} is 0. This is because x may be in another pocket R' of the complement of $\psi_{\mathbf{N}}(K)$ in which the depth of x in R' is not 0.

The depth of a point in the complement of $\psi_{\mathbf{N}}(K)$ provides a means to measure how "trapped" or "confined" it is in the pockets of $\mathbb{R}^2 \setminus \psi_{\mathbf{N}}(K)$. Note that a point x may be contained in a pocket of the complement of $\psi_{\mathbf{N}}(K)$ but still have depth 0. This is because a minimal escape arc of x would not have to cross the critical line $y = 1/2$ to be adjoined to a straight vertical ray. We should also note that a point x in the complement of \mathbb{R}^2 not contained in schema or alternate schema pockets will also have a depth of 0 as there will always be a strait vertical ray having x as an endpoint.

Again, we advise the reader to allow geometric intuition as a sketch of proof for the next two propositions, making use of Figures 9 and 11 as needed.

⁵If for every $n \in \mathbb{N}$ there is a point x in S such that the depth of x is greater than n , we say that the depth of S is ∞ . Such is the case for the complement of $\psi_{\mathbf{N}}(K)$ whenever \mathbf{N} contains an increasing subsequence. However, we need not concern ourselves with infinite depth in the remainder of this paper.

Proposition 3.15. *Let $\psi_{\mathbf{N}}$ be a schema embedding of K and let (x_1, x_2, x_3, \dots) be a sequence of points so that for each $i \in \mathbb{N}$, $x_i \in D_{\mathbf{N},i}$ with the depth of x_i in $D_{\mathbf{N},i}$ being at least 4. If for each $i \in \mathbb{N}$, J_i is a minimal escape arc from x_i out of $D_{\mathbf{N},i}$, then the top turning points of J_i converge to the top endpoint, $(0, 1)$, of $\psi_{\mathbf{N}}(E)$ as $i \rightarrow \infty$ and the bottom turning points of J_i converge to the bottom endpoint, $(0, 0)$, of $\psi_{\mathbf{N}}(E)$ as $i \rightarrow \infty$.*

Proposition 3.16. *Let $\psi_{\mathbf{N}}$ be the schema embedding of K . Then for each $i \in \mathbb{N}$, the depth of $D_{\mathbf{N},i}$ with respect to \mathbf{N} is n_i , and the depth of $D'_{\mathbf{N},i}$ with respect to \mathbf{N} is 2. Furthermore, if L is a V -layer of Λ layer of K , then the depth of $D_{\mathbf{N},L}$ with respect to \mathbf{N} is at least 1.*

Lemma 3.17. *Let $\psi_{\mathbf{N}}$ and $\psi_{\mathbf{M}}$ be schema embeddings of K . Let (V_1, V_2, V_3, \dots) be a sequence of V -layers of K and let (x_1, x_2, x_3, \dots) be a sequence of points in the plane converging to $\psi_{\mathbf{N}}(p) = (0, 0)$ so that for each $i \in \mathbb{N}$, $x_i \in D_{\mathbf{N},V_i}$. Let h be a homeomorphism of the plane onto itself mapping $\psi_{\mathbf{N}}(K)$ onto $\psi_{\mathbf{M}}(K)$ such that $h(\psi_{\mathbf{N}}(p)) = \psi_{\mathbf{M}}(p)$. Then there exists an $N \in \mathbb{N}$ such that for every $i \geq N$, $h(x_i)$ is contained in the V -pocket $D_{\mathbf{M},\Gamma_i}$, where $\Gamma_i := \psi_{\mathbf{M}}^{-1}(h(\psi_{\mathbf{N}}(V_i)))$.*

Proof. Suppose there exists a subsequence $(x_{i_1}, x_{i_2}, x_{i_3}, \dots)$ such that for every $j \in \mathbb{N}$, $h(x_{i_j}) \notin D_{\mathbf{M},\Gamma_{i_j}}$. By Corollary 1.7 and Lemma 1.8, $h(\psi_{\mathbf{N}}(V_{i_j}))$ is a V -layer of $\psi_{\mathbf{M}}(K)$, and thus, Γ_{i_j} a V -layer of K , for every $j \in \mathbb{N}$. We must consider two cases.

The first case we consider is that for each $j \in \mathbb{N}$, the depth of $h(x_{i_j})$ with respect to \mathbf{M} is 0. Since $x_{i_j} \rightarrow \psi_{\mathbf{N}}(p)$ as $j \rightarrow \infty$, it follows that $h(x_{i_j}) \rightarrow \psi_{\mathbf{M}}(p)$ as $j \rightarrow \infty$. Thus, for some $M \in \mathbb{N}$ and for every $j \geq M$, there exists a straight vertical arc A_j whose top endpoint is $h(x_{i_j})$ so that $A_j \rightarrow A = \{0\} \times [-1, 0]$ as $j \rightarrow \infty$. Since $A \cap \psi_{\mathbf{M}}(E) = \{\psi_{\mathbf{M}}(p)\}$, it follows that $h^{-1}(A) \cap \psi_{\mathbf{N}}(E) = \{\psi_{\mathbf{N}}(p)\}$. However, since $x_{i_j} \in D_{\mathbf{N},V_{i_j}}$ for every $j \geq N$, it follows that $h^{-1}(A_j) \not\rightarrow h^{-1}(A)$ as $j \rightarrow \infty$, a contradiction to h being a homeomorphism.

The second case considered is that for each $j \in \mathbb{N}$, the depth of $h(x_{i_j})$ with respect to \mathbf{M} is positive. For each $j \in \mathbb{N}$, let C_j be an endcut of $\psi_{\mathbf{N}}(K)$ contained in $\text{cl}(D_{\mathbf{N},V_{i_j}})$ whose endpoints are x_{i_j} and the vertex of V_{i_j} , and so that $C_j \rightarrow \{\psi_{\mathbf{N}}(p)\}$ as $j \rightarrow \infty$. Since $h(x_{i_j}) \notin D_{\mathbf{M},\Gamma_{i_j}}$ for each $j \in \mathbb{N}$, it follows that $h(C_j) \not\rightarrow \{\psi_{\mathbf{M}}(p)\}$ as $j \rightarrow \infty$, also contradicting that h is a homeomorphism. \square

We are now in position to provide a special case in which we prove that the standard embedding of K is not equivalent to the schema embedding

of K according to the sequence of all 4's. Recall by Remark 3.5 that this embedding can be denoted by $\psi_{\mathbf{4}}$. It follows as a consequence that the standard embedding of K is inequivalent to any schema embedding of K .

Lemma 3.18. *The standard embedding of the Knaster $V\Lambda$ -continuum K is inequivalent to the embedding $\psi_{\mathbf{4}}$. Moreover, the standard embedding of K is inequivalent to $\psi_{\mathbf{N}}$ for any sequence \mathbf{N} of positive even integers greater than or equal to 4.*

Proof. For simplicity, we will denote the image of the standard embedding of K as X , and the image of the embedding of K under $\psi_{\mathbf{4}}$ will be denoted as Y . Denote the left end layer of X as E_X , the left end layer of Y as E_Y , and denote the bottom and top endpoints of E_X as p_X and q_X and the bottom and top endpoints of E_Y as p_Y and q_Y .⁶ Recall from Remark 3.8 that $X = \psi_{\mathbf{1}}(K)$, where $\mathbf{1}$ here denotes the sequence of all 1's.

Suppose h is a homeomorphism of the plane onto itself so that $h(X) = Y$. By Lemma 1.8 and due to the symmetry of X , we may assume that $h(E_X) = E_Y$ with $h(p_X) = p_Y$ and $h(q_X) = q_Y$. Let (V_1, V_2, V_3, \dots) be the sequence of V -layers of Y whose vertices are $\psi_{\mathbf{4}}(s_i^{(4)})$ for each $i \in \mathbb{N}$. Let (y_1, y_2, y_3, \dots) be a sequence of points such that for each $i \in \mathbb{N}$, y_i is contained in the V_i -pocket of the complement of Y , with $y_i \rightarrow p_Y$ as $i \rightarrow \infty$ and so that $y_i \in D_{\mathbf{4},i}$, with the depth of y_i being 4. Also as a consequence of Lemma 1.8, $h^{-1}(V_i)$ is a V -layer of X for every $i \in \mathbb{N}$.

Again, by Remark 3.8, we can let, for each $i \in \mathbb{N}$, the horizontal crosscuts $C_{\mathbf{1},i}$ be connecting the endpoints of $h^{-1}(V_i)$ so that $D_{\mathbf{1},i}$ is the i^{th} schema pocket for X having $h^{-1}(V_i)$ on its boundary. That is, for each $i \in \mathbb{N}$, $D_{\mathbf{1},i}$ is the V -pocket, $D_{\mathbf{1},h^{-1}(V_i)}$, of X . For each $i \in \mathbb{N}$, let $x_i = h^{-1}(y_i)$. Since $y_i \rightarrow p_Y$ as $i \rightarrow \infty$, it follows that $x_i \rightarrow p_X$ as $i \rightarrow \infty$. By Lemma 3.17, we may assume for each $i \in \mathbb{N}$ that x_i has a depth of 1 inside $D_{\mathbf{1},i}$.

Let J_i be the straight vertical arc so that x_i is the bottom endpoint of J_i , and so that the top endpoint, x'_i , of J_i has 1 as its y -coordinate. Note that in this case, $J_i \rightarrow E_X$ as $i \rightarrow \infty$. Furthermore, J_i is a minimal escape arc from x_i out of $D_{\mathbf{1},i}$ for each $i \in \mathbb{N}$. For each $i \in \mathbb{N}$, let A_i be the straight arc of length 1 with x'_i as its bottom endpoint. Then $A_i \rightarrow A$ where $A = \{0\} \times [1, 2]$ as $i \rightarrow \infty$.

Since $h(x_i) = y_i \in D_{\mathbf{4},i}$ for each $i \in \mathbb{N}$, it follows that $h(J_i) \cap D_{\mathbf{4},i} \neq \emptyset$ for each $i \in \mathbb{N}$. Since $h(J_i) \rightarrow E_Y$ with the endpoint y_i of $h(J_i)$ having a depth of 4 in $D_{\mathbf{4},i}$ for each $i \in \mathbb{N}$, and since by Lemma 1.9, each $h(J_i)$ has

⁶Even though $E_X = \{0\} \times [0, 1] = E_Y$, $p_X = (0, 0) = p_Y$, and $q_X = (0, 1) = q_Y$, we still wish to make distinctions in reference to their corresponding embeddings.

no points of depth less than 3 for all large enough i , it follows that there is $M \in \mathbb{N}$ such that for every $i \geq M$, the depth of $h(A_i)$ in $D_{4,i}$ is at least 3. Note that since $A \cap E_X = \{q_X\}$ and $\text{diam}(A) = 1$, it follows there exists an $\eta > 0$ such that $\text{diam}(h(A)) = \eta$ and $h(A) \cap E_Y = \{q_Y\}$. However, since $D_{4,i} \rightarrow E_Y$ as $i \rightarrow \infty$, and because the depth of $h(A_i)$ in $D_{4,i}$ is at least 3 for every $i \geq M$, it follows that $h(A_i) \not\rightarrow h(A)$. This contradicts that h is a homeomorphism.

Since for each sequence \mathbf{N} of positive even integers greater than or equal to 4, the depth the schema pocket $D_{\mathbf{N},i}$ is greater than or equal to 4 for every $i \in \mathbb{N}$, it follows that the standard planar embedding of K is inequivalent to $\psi_{\mathbf{N}}$. \square

Corollary 3.19. *If \mathbf{N} and \mathbf{M} are sequences of positive even integers greater than or equal to 4 and h a homeomorphism of the plane onto itself mapping $\psi_{\mathbf{N}}(K)$ onto $\psi_{\mathbf{M}}(K)$, then $h(\psi_{\mathbf{N}}(E)) = \psi_{\mathbf{M}}(E)$.*

Proof. Suppose instead that $h(\psi_{\mathbf{N}}(E)) = \psi_{\mathbf{M}}(E')$. Then there exists an $N \in \mathbb{N}$ for which

$$h\left(\psi_{\mathbf{N}}\left(\text{cl}\left(\bigcup_{i=N}^{\infty} K_i\right)\right)\right) \subset \psi_{\mathbf{M}}(K_1^{(1)}).$$

Let \mathbf{N}' denote the subsequence of \mathbf{N} having all but the first $N - 1$ terms of \mathbf{N} . Then \mathbf{N}' and \mathbf{N} are equivalent sequences, and thus, $\psi_{\mathbf{N}}$ and $\psi_{\mathbf{N}'}$ are equivalent planar embeddings of K by Proposition 3.7. Since $\psi_{\mathbf{N}'}$ is equivalent to $\psi_{\mathbf{N}} \upharpoonright \text{cl}\left(\bigcup_{i=N}^{\infty} K_i\right)$, so is $\psi_{\mathbf{N}}$. However, $\psi_{\mathbf{M}} \upharpoonright K_1^{(1)}$ is equivalent to the standard embedding of K , with $\psi_{\mathbf{N}}\left(\text{cl}\left(\bigcup_{i=N}^{\infty} K_i\right)\right)$ being mapped by h into $\psi_{\mathbf{M}}(K_1^{(1)})$, contradicting Lemma 3.18. \square

Lemma 3.20. *If \mathbf{N} and \mathbf{M} are sequences of positive even integers greater than or equal to 4 and h a homeomorphism of the plane onto itself mapping $\psi_{\mathbf{N}}(K)$ onto $\psi_{\mathbf{M}}(K)$, then $h(\psi_{\mathbf{N}}(p)) = \psi_{\mathbf{M}}(p)$.*

Proof. For simplicity, let us denote $\psi_{\mathbf{N}}(p)$, $\psi_{\mathbf{N}}(q)$, $\psi_{\mathbf{M}}(p)$, and $\psi_{\mathbf{M}}(q)$ by $p_{\mathbf{N}}$, $q_{\mathbf{N}}$, $p_{\mathbf{M}}$, and $q_{\mathbf{M}}$, respectively. By Corollary 3.19, $h(p_{\mathbf{N}}) \in \{p_{\mathbf{M}}, q_{\mathbf{M}}\}$. Suppose $h(p_{\mathbf{N}}) = q_{\mathbf{M}}$. Let (x_1, x_2, x_3, \dots) be a sequence of points converging to $p_{\mathbf{N}}$ with x_i having a depth of 4 in $D_{\mathbf{N},i}$, and for each $i \in \mathbb{N}$, let H_i be a sequence of minimal escape arcs from x_i out of $D_{\mathbf{N},i}$. We shall also assume that x_i has the least y -coordinate among all other points of depth 4 along H_i for each $i \in \mathbb{N}$. Also for each $i \in \mathbb{N}$, let $x_i^{(l)}$ for $l = 0, 1, 2, 3, 4$ be the points along H_i so that

- (1) $x_i^{(0)} = x_i$, and $x_i^{(4)}$ is the other endpoint of H_i intersecting the cross-cut $C_{\mathbf{N},i}$,
- (2) $x_i^{(l)}$ has depth $4 - l$ in $D_{\mathbf{N},i}$ for each $l = 0, 1, 2, 3, 4$, and
- (3) $x_i^{(l)}$ is a top turning point of H_i for $l = 1, 3$ and $x_i^{(2)}$ is a bottom turning point.

Note that since $h(p_{\mathbf{N}}) = q_{\mathbf{M}}$, and thus, $h(q_{\mathbf{N}}) = p_{\mathbf{M}}$, condition (3) gives us $h(x_i^{(2)}) \rightarrow q_{\mathbf{M}}$ and $h(x_i^{(l)}) \rightarrow p_{\mathbf{M}}$ for $l = 1, 3$ as $i \rightarrow \infty$ by Proposition 3.15. Also, by default, we have $x_i^{(l)} \rightarrow p_{\mathbf{N}}$ as $i \rightarrow \infty$ for $l = 0, 4$, whence $h(x_i^{(l)}) \rightarrow q_{\mathbf{M}}$ as $i \rightarrow \infty$ for $l = 0, 2, 4$. If for each $i \in \mathbb{N}$ we let $H_i^{(l)}$ be the subarc of H_i having as its endpoints $x_i^{(l-1)}$ and $x_i^{(l)}$ for each $l = 1, 2, 3, 4$, then for each such l , $(H_1^{(l)}, H_2^{(l)}, H_3^{(l)}, \dots)$ forms a sequence of arcs converging to $\psi_{\mathbf{N}}(E)$ so that for each $i \in \mathbb{N}$, $\pi \upharpoonright H_i^{(l)}$ is a homeomorphism mapping $H_i^{(l)}$ onto $\pi(H_i^{(l)})$. It follows that, if U and W are the open subsets of the xy -plane sitting respectively above and below the critical line $y = 1/2$, then there exists an $N \in \mathbb{N}$ such that for every $i \geq N$,

$$\mathcal{H}_i = \{h(x_i^{(0)}), h(x_i^{(1)}), h(x_i^{(2)}), h(x_i^{(3)}), h(x_i^{(4)})\} \subset U \cup W,$$

with members of the above set alternating between belonging to U and belonging to W . That is, for each $i \geq N$, $h(x_i^{(l)}) \in U$ for $l = 0, 2, 4$ and $h(x_i^{(l)}) \in W$ for $l = 1, 3$.

Claim. Only finitely many H_i are mapped by h into schema pockets of the complement of $\psi_{\mathbf{N}}(K)$ so that for each such i , there is a pair of distinct integers l_i and l'_i such that the depth of $h(x_i^{(l_i)})$ is the same as the depth of $h(x_i^{(l'_i)})$

Proof of Claim. Suppose there is a subsequence i_1, i_2, i_3, \dots of positive integers so that for each $j \in \mathbb{N}$, there exists two distinct integers l_j and l'_j between 0 and 4 such that the depth of $h(x_{i_j}^{(l_j)})$ is the same as that of $h(x_{i_j}^{(l'_j)})$. Since members of the set \mathcal{H}_{i_j} alternate between being in U and being in W for every $i_j \geq N$, it follows that l_j and l'_j can be chosen so that $|l_j - l'_j| = 2$ for every $i_j \geq N$. As a consequence of Lemma 1.9, we may consider two cases.

The first case is that for each j such that $i_j \geq N$, there exists an arc T_j contained in $(\mathbb{R}^2 \setminus \psi_{\mathbf{M}}(K)) \cap U$ or contained in $(\mathbb{R}^2 \setminus \psi_{\mathbf{M}}(K)) \cap W$ whose endpoints are $h(x_{i_j}^{(l_j)})$ and $h(x_{i_j}^{(l'_j)})$, and with $\text{diam}(T_j) \rightarrow 0$ as $j \rightarrow \infty$. However, since for each $j \in \mathbb{N}$, $x_{i_j}^{(l_j)}$ and $x_{i_j}^{(l'_j)}$ have depths differing by 2, it follows that $\text{diam}(h^{-1}(T_j)) \not\rightarrow 0$ as $j \rightarrow \infty$ —a contradiction to h being a homeomorphism.

The second to be considered is that for some $M \geq N$ and every $j \geq M$, there is a straight vertical arc $A_j \subset (\mathbb{R}^2 \setminus \psi_{\mathbf{M}}(K)) \cap W$ whose top endpoint is $h(x_{i_j}^{(l_j)})$, with $l_j \in \{1, 3\}$, such that $A_j \rightarrow A = \{0\} \times [-1, 0]$ as $j \rightarrow \infty$. Note that $A \cap E_Y = \{p_Y\}$ implies that $h^{-1}(A) \cap E_X = \{p_X\}$. However, since for each $j \geq M$, the depth of $x_{i_j}^{(l_j)}$ is at least 1, it follows that $h^{-1}(A_j) \not\rightarrow h^{-1}(A)$. This also contradicts that h is a homeomorphism.

By our previous claim, it follows that for some $N' \geq N$ and every $i \geq N'$, no two different $h(x_i^{(l)})$ have the same depth within a schema pocket of the complement of $\psi_{\mathbf{M}}(K)$. By the previous claim combined with Proposition 1.9, it follows that for each $i \geq N'$, $h(H_i)$ is mapped into a schema pocket of the complement of $\psi_{\mathbf{M}}(K)$ such that the depths of each $h(x_i^{(l)})$ alternate in value, with the depths of $h(x_i^{(l)})$ and $h(x_i^{(l')})$ differing by 1 if and only if $|l - l'| = 1$. Furthermore, the depth of each such $h(x_i^{(l)})$ is no less than $5 - l$. Thus, in particular, for each $i \geq N'$, the depth of $h(x_i^{(4)})$ will be at least 1.

For each $i \in \mathbb{N}$, let A_i be the straight vertical arc whose top endpoint is $x_i^{(4)}$, with $A_i \rightarrow A$, where again, $A = \{0\} \times [-1, 0]$, as $i \rightarrow \infty$. Since $A \cap E_X = \{p_X\}$, it follows that $h(A) \cap E_Y = \{p_Y\}$. However, since the depth of $h(x_i^{(4)})$ is at least 1 for each $i \geq N'$, it follows that $h(A_i) \not\rightarrow h(A)$ as $i \rightarrow \infty$ —a contradiction to h being a homeomorphism. Therefore, $h(p_{\mathbf{N}}) = p_{\mathbf{M}}$. \square

3.3. Schema Embeddings of K According to Inequivalent Sequences are Inequivalent.

We now state and prove the lemmas needed to show that the collection of all schema embeddings of K according to sequences of even positive integers greater than or equal to 4 has cardinality \mathfrak{c} . In what follows, let $\mathbf{N} = (n_1, n_2, n_3, \dots)$ and $\mathbf{M} = (m_1, m_2, m_3, \dots)$ be sequences of even positive integers greater than or equal to 4. We will let $X = \psi_{\mathbf{N}}(K)$ and $Y = \psi_{\mathbf{M}}(K)$ for simplicity. Though both are equal to $\{0\} \times [0, 1]$, we will let the left end layers of X and Y be denoted by E_X and E_Y , respectively. Denote the bottom and top endpoints of E_X as p_X and q_X , respectively, and the bottom and top points of E_Y as p_Y and q_Y , respectively. We remind the reader that π denotes the natural projection of \mathbb{R}^2 onto the y -axis so that $\pi(x, y) = (0, y)$ for every $(x, y) \in \mathbb{R}^2$.

Let x_i be a point in $D_{\mathbf{N}, i}$ so that the depth of x_i is n_i for each $i \in \mathbb{N}$, and with $x_i \rightarrow p_X$ as $i \rightarrow \infty$. We will also assume that for each $i \in \mathbb{N}$, x_i has the smallest y -coordinate for any minimal escape arc from x_i out of $D_{\mathbf{N}, i}$. For each $i \in \mathbb{N}$, let J_i be a minimal escape arc from x_i out of $D_{\mathbf{N}, i}$, and let $x_i^{(1)}, \dots, x_i^{(n_i-1)} \in D_{\mathbf{N}, i}$ and $x_i^{(n_i)} \in C_{\mathbf{N}, i}$ be such that the depth of $x_i^{(l)}$ in $D_{\mathbf{N}, i}$ is $n_i - l$ for each $l = 1, \dots, n_i$. Furthermore, let $x_i^{(1)}, \dots, x_i^{(n_i-1)}$

be the turning points of J_i . We will designate $x_i^{(0)} := x_i$ for each $i \in \mathbb{N}$. Let $J_i^{(1)}, \dots, J_i^{(n_i)}$ be such that $J_i^{(l)}$ is the subarc of J_i whose endpoints are $x_i^{(l-1)}$ and $x_i^{(l)}$ for every $l = 1, \dots, n_i$.

Similarly, let y_i be a point in $D_{\mathbf{M},i}$ so that the depth of y_i is m_i for each $i \in \mathbb{N}$, and with $y_i \rightarrow p_Y$ as $i \rightarrow \infty$. We will also assume that for each $i \in \mathbb{N}$, y_i has the smallest y -coordinate for any minimal escape arc from y_i out of $D_{\mathbf{M},i}$. For each $i \in \mathbb{N}$, let I_i be a minimal escape arc from y_i out of $D_{\mathbf{M},i}$, and let $y_i^{(1)}, \dots, y_i^{(m_i-1)} \in D_{\mathbf{M},i}$ and $y_i^{(m_i)} \in C_{\mathbf{M},i}$ be such that the depth of $y_i^{(l)}$ in $D_{\mathbf{M},i}$ is $m_i - l$ for each $l = 1, \dots, m_i$. Furthermore, let $y_i^{(1)}, \dots, y_i^{(m_i-1)}$ be the turning points of I_i . We will designate $y_i^{(0)} := y_i$ for each $i \in \mathbb{N}$. Let $I_i^{(1)}, \dots, I_i^{(m_i)}$ be such that $I_i^{(l)}$ is the subarc of I_i whose endpoints are $y_i^{(l-1)}$ and $y_i^{(l)}$ for every $l = 1, \dots, m_i$.

We shall also denote by U and W the open subsets of \mathbb{R}^2 sitting above and below, respectively, the critical line $y = 1/2$. Lastly, we will assume h is a homeomorphism onto itself such that $h(X) = Y$. By Corollary 3.19 and Lemma 3.20, $h(E_X) = E_Y$ with $h(p_X) = p_Y$.

Lemma 3.21. *All but finitely many $h(x_i)$ are contained in schema pockets of the complement of Y in which the depth of $h(x_i)$ is at least n_i .*

Proof. Suppose there is a subsequence $(x_{i_1}, x_{i_2}, x_{i_3}, \dots)$ having the property that for each $j \in \mathbb{N}$, $h(x_{i_j})$ has depth within any schema pocket of the complement of Y being less than n_i . Since $x_i \rightarrow p_X$ as $i \rightarrow \infty$, it follows that $h(x_{i_j}) \rightarrow p_Y$ as $j \rightarrow \infty$, and thus, there exists an $N \in \mathbb{N}$ such that for every $j \geq N$, the depth of $h(x_{i_j})$ in a schema pocket of the complement of Y is even. N can be taken large enough so that $h(x_{i_j}^{(l)}) \in U$ when l is odd and $h(x_{i_j}^{(l)}) \in W$ when l is even. We must now consider two cases.

The first case we consider is that there is an $M \geq N$ such that for each $j \geq M$, there exists an arc T_j contained in $(\mathbb{R}^2 \setminus \psi_{\mathbf{M}}(K)) \cap U$ or $(\mathbb{R}^2 \setminus \psi_{\mathbf{M}}(K)) \cap W$ having as its endpoints $h(x_{i_j}^{(l_j)})$ and $h(x_{i_j}^{(l'_j)})$, with $\text{diam}(T_j) \rightarrow 0$ as $j \rightarrow \infty$, where $l_j, l'_j \in \{0, 1, 2, \dots, n_{i_j}\}$ and $|l_j - l'_j| = 2$. However, since the difference in the depths of $x_{i_j}^{(l_j)}$ and $x_{i_j}^{(l'_j)}$ is 2, this implies that $\text{diam}(h^{-1}(T_j)) \not\rightarrow 0$ as $j \rightarrow \infty$. This contradicts that h is a homeomorphism.

The second case we consider is that for some $M \geq N$ and every $j \geq M$, there is a straight vertical arc A_j whose top endpoint is $h(x_{i_j}^{(l_j)})$, with $A_j \rightarrow A = \{0\} \times [-1, 0]$ as $j \rightarrow \infty$ for an even $l_j \in \{0, 2, \dots, n_{i_j} - 2\}$. Recall from previous proofs that since $A \cap E_Y = \{p_Y\}$, it follows that $h^{-1}(A) \cap E_X = \{p_X\}$. However, since for each $j \geq M$, the depth of $x_{i_j}^{(l_j)}$

is at least 2, it follows that $h^{-1}(A_j) \not\rightarrow h^{-1}(A)$ as $j \rightarrow \infty$. This is also a contradiction to h being a homeomorphism. \square

By using similar arguments in the proof of Lemma 3.21, one may obtain the following corollary.

Corollary 3.22. *All but finitely many $h(x_i^{(l)})$ are contained in schema pockets of the complement of Y in which the depth of $h(x_i^{(l)})$ is at least $n_i - l$, where $l \in \{0, 1, \dots, n_i\}$.*

Lemma 3.23. *All but finitely many $h(x_i)$ are not contained in schema pockets of the complement of Y whose depth is more than n_i .*

Proof. Suppose there is a subsequence $(x_{i_1}, x_{i_2}, x_{i_3}, \dots)$ such that $h(x_{i_j})$ is in a schema pocket, $D_{\mathbf{M},k(j)}$, of the complement of Y whose depth is greater than n_{i_j} . By Lemma 3.21, this leaves two possibilities:

- (1.) The depth of $h(x_{i_j})$ in $D_{\mathbf{M},k(j)}$ is n_{i_j} .
- (2.) The depth of $h(x_{i_j})$ in $D_{\mathbf{M},k(j)}$ is greater than n_{i_j} .

Assume case (1.) occurs for all but finitely many $j \in \mathbb{N}$ and, without loss of generality, for every $j \in \mathbb{N}$. As in the proof of Lemma 3.21, there exists an $N \in \mathbb{N}$ such that for every $j \geq N$, $\{h(x_{i_j}), h(x_{i_j}^{(1)}), \dots, h(x_{i_j}^{(n_{i_j})})\} \subset U \cup W$, the members of this set alternating between U and W . By Lemma 1.9, we may assume N is large enough so that for each $j \geq N$, the difference between the depths of $h(x_{i_j}^{(l)})$ and $h(x_{i_j}^{(l')})$ in $D_{\mathbf{M},k(j)}$ is 1 if and only if $|l - l'| = 1$. Furthermore, by Corollary 3.22, the depth of every $h(x_{i_j}^{(l)})$ is that of $h(x_{i_j}^{(l-1)})$, which is $n_{i_j} - l + 1$, for each $j \geq N$ and each $l \in \{1, \dots, n_{i_j}\}$.

For each $j \geq N$, let z_j be a point in $D_{\mathbf{M},k(j)}$ whose depth is $n_{i_j} + 1$ and so that $z_j \rightarrow q_Y$ as $j \rightarrow \infty$. Note that $h^{-1}(z_j) \rightarrow q_X$ as $j \rightarrow \infty$. Also for each $j \geq N$, let Z_j be an arc in $D_{\mathbf{M},k(j)}$ whose endpoints are $h(x_{i_j})$ and z_j and so that the depth of Z_j in $D_{\mathbf{M},k(j)}$ is also $n_{i_j} + 1$.

It follows, as a consequence of Lemma 1.9 on the collection of all Z_j , that there exists a positive integer $M \geq N$ such that for every $j \geq M$, there exists an arc T_j in $D_{\mathbf{N},i_j}$ whose endpoints are $h^{-1}(z_j)$ and $x_{i_j}^{(1)}$, with $\text{diam}(T_j) \rightarrow 0$ as $j \rightarrow \infty$. However, since the depth of z_j in $D_{\mathbf{M},k(j)}$ differs by 2 from the depth of $h(x_{i_j}^{(1)})$ in $D_{\mathbf{M},k(j)}$ for every $j \geq M$, it follows that $\text{diam}(h(T_j)) \not\rightarrow 0$ as $j \rightarrow \infty$, a contradiction to h being a homeomorphism.

Assume now that case (2.) occurs for all but finitely many $j \in \mathbb{N}$ and, without loss of generality, for every $j \in \mathbb{N}$. Let N be similarly defined as in the proof negating case (1.) above. Since the depth of $h(x_{i_j})$ in $D_{\mathbf{M},k(j)}$

is greater than n_{i_j} for every $j \in \mathbb{N}$, this implies that for every $j \geq N$, the depth of $h(x_{i_j}^{(n_{i_j})})$ in $D_{\mathbf{M},k(j)}$ is greater than or equal to 1.

For each $j \geq N$, let A_j be the straight vertical arc having $x_{i_j}^{(n_{i_j})}$ as its top endpoint with $A_j \rightarrow A = \{0\} \times [-1, 0]$ as $j \rightarrow \infty$. Again, since $A \cap E_X = \{p_X\}$, it follows that $h(A) \cap E_Y = \{p_Y\}$. However, for each $j \geq N$, since the depth of $h(x_{i_j}^{(n_{i_j})})$ in $D_{\mathbf{M},k(j)}$ is greater than or equal to 1, this implies $h(A_j) \not\rightarrow h(A)$ as $j \rightarrow \infty$. This also contradicts that h is a homeomorphism. \square

Lemma 3.24. *All but finitely many pairs $h(x_i)$ and $h(x_j)$, where $i \neq j$, are contained in different schema pockets of the complement of Y .*

Proof. Suppose there exists a subsequence $(x_{i_1}, x_{i_2}, x_{i_3}, \dots)$ and a subsequence $(x_{j_1}, x_{j_2}, x_{j_3}, \dots)$ such that $i_m \neq j_m$ for every $m \in \mathbb{N}$ and so that $h(x_{i_m})$ and $h(x_{j_m})$ are contained in the same schema pocket of the complement of Y . Again, as in the previous proofs, there exists an $M(i) \in \mathbb{N}$ such that for every $m \geq M(i)$, $\{h(x_{i_m}), h(x_{i_m}^{(1)}), \dots, h(x_{i_m}^{(n_{i_m})})\} \subset U \cup W$, the members of this set alternating between U and W . Similarly, there exists an $M(j) \in \mathbb{N}$ such that for every $m \geq M(j)$, $\{h(x_{j_m}), h(x_{j_m}^{(1)}), \dots, h(x_{j_m}^{(n_{j_m})})\} \subset U \cup W$, the members of this set alternating between U and W . Furthermore, for each $m \geq M(i)$, the difference between the depths of $h(x_{i_m}^{(l)})$ and $h(x_{i_m}^{(l')})$ is 1 if and only if $|l - l'| = 1$, with the depth of every $h(J_{i_m}^{(l)})$ being that of $h(x_{i_m}^{(l-1)})$, and for each $m \geq M(j)$, the difference between the depths of $h(x_{j_m}^{(l)})$ and $h(x_{j_m}^{(l')})$ is 1 if and only if $|l - l'| = 1$, with the depth of every $h(J_{j_m}^{(l)})$ is being that of $h(x_{j_m}^{(l-1)})$.

Let $M = \max\{M(i), M(j)\}$. By Lemma 3.21 and Lemma 3.23, the depth of $h(x_{i_m})$ and $h(x_{j_m})$ are the same as the depths of x_{i_m} and x_{j_m} in $D_{\mathbf{N},i_m}$ and $D_{\mathbf{N},j_m}$, respectively, for every $m \geq M$. That is, $n_{i_m} = n_{j_m}$ for every $m \geq M$. In particular, for each $m \geq M$ and each $l = 1, \dots, n_{i_m}$, the depth of $h(x_{i_m}^{(l)})$ is $n_{i_m} - l$, and the depth of $h(J_{i_m}^{(l)})$ is $n_{i_m} - l + 1$. These are also the depths of the corresponding $h(x_{j_m}^{(l)})$ and $h(J_{j_m}^{(l)})$.

For every $m \geq M$ and for every $l \in \{1, \dots, n_{i_m}\}$, let $T_m^{(l)}$ be the shortest arc contained in the complement of Y so that the endpoints of $T_m^{(l)}$ are $h(x_{i_m}^{(l)})$ and $h(x_{j_m}^{(l)})$. Then for every such m and every such l , $\text{diam}(T_m^{(l)}) \rightarrow 0$ as $m \rightarrow \infty$. However, because $i_m \neq j_m$ for every $m \geq M$, it follows that for every $m \geq M$ and every $l \in \{1, \dots, n_{i_m}\}$, $\text{diam}(h^{-1}(T_m^{(l)})) \not\rightarrow 0$ as $m \rightarrow \infty$. This contradicts that h is a homeomorphism. \square

Lemma 3.25. *\mathbf{N} and \mathbf{M} are equivalent sequences of positive integers.*

Proof. By Lemmas 3.21 and 3.23, there exists a positive integer N such that for every $i \geq N$, $h(x_i)$ is contained in a schema pocket $D_{\mathbf{M},j_i}$ of the complement of Y with depth n_i in which the depth of $h(x_i^{(l)}) = n_i - l$ for every $l \in \{0, 1, \dots, n_i\}$ and so that the depth of $h(J_i^{(l)})$ is that of $h(x_i^{(l-1)})$. Furthermore, such a sufficiently large N can also satisfy $j_i \neq j_k$ whenever $i \neq k$ by Lemma 3.24, with $j_i < j_{i+1}$ for every $i \geq N$ by Proposition 1.4. Similarly, there exists a positive integer M such that for every $i \geq M$, $h^{-1}(y_i)$ is contained in a schema pocket $D_{\mathbf{N},s_i}$ of the complement of X with depth m_i in which the depth of $h^{-1}(y_i^{(l)}) = m_i - l$ for every $l = 0, 1, \dots, m_i$ and so that the depth of $h^{-1}(I_i^{(l)})$ is that of $h^{-1}(y_i^{(l-1)})$. Furthermore, such a sufficiently large M can also satisfy $s_i \neq s_k$ whenever $i \neq k$ by Lemma 3.24, with $s_i < s_{i+1}$ for every $i \geq M$ by Proposition 1.4.

Let us assume that $N = \max\{N, M\}$. By the lemmas listed in the previous paragraph, it follows that for every $i \geq N$, $j_{i+1} - j_i = 1$. Indeed, suppose that there is a sequence i_1, i_2, i_3, \dots such that $j_{i_{k+1}} - j_{i_k} > 1$ for every $k \in \mathbb{N}$. Then there exists a sequence of integers (u_1, u_2, u_3, \dots) such that $j_{i_k} < u_k < j_{i_{k+1}}$ for each $k \in \mathbb{N}$. By Proposition 1.4, it follows that for every $k \in \mathbb{N}$, $h^{-1}(y_{u_k})$ must be mapped to a pocket of the complement of X between $D_{\mathbf{N},i_k}$ and $D_{\mathbf{N},i_{k+1}}$. However, as a consequence of Lemma 3.24 as well as Lemma 3.17, the only option would be for $h^{-1}(y_{u_k})$ to be mapped to a V -pocket of X not contained in any schema disk of the complement of X . Such a pocket would have a depth of at most 2, and since the depth of y_{u_k} is at least 4 for each k , this would contradict Lemma 3.21 and thus proves our claim.

It follows that for every $i \geq N$, pockets $D_{\mathbf{N},i}$ are mapped so that their depth in $D_{\mathbf{M},j_i}$ is n_i , with the depth of $D_{\mathbf{M},j_i}$ being n_i as well. Thus, for each $i \geq N$ and each $k \geq j_N$, we have that $n_i = m_k$. Therefore, \mathbf{N} and \mathbf{M} are equivalent sequences of positive even integers greater than or equal to 4. \square

Theorem 3.26. *If \mathbf{N} and \mathbf{M} are inequivalent sequences of positive even integers greater than or equal to 4, then $\psi_{\mathbf{N}}$ and $\psi_{\mathbf{M}}$ are inequivalent planar embeddings of K .*

Proof. This follows directly as a consequence of Lemma 3.25, where we preemptively assumed that $\psi_{\mathbf{N}}$ and $\psi_{\mathbf{M}}$ were equivalent planar embeddings of K by assuming there was a homeomorphism h of the plane onto itself mapping $\psi_{\mathbf{N}}(K)$ onto $\psi_{\mathbf{M}}(K)$, leading us to conclude that \mathbf{N} and \mathbf{M} are equivalent sequences. Therefore, by contraposition, we conclude that if \mathbf{N}

and \mathbf{M} are inequivalent sequences, $\psi_{\mathbf{N}}$ and $\psi_{\mathbf{M}}$ must be inequivalent planar embeddings of K . \square

Corollary 3.27. *There are \mathfrak{c} -many mutually inequivalent planar embeddings of K , each whose image has the same accessible points as in the standard embedding of K .*

Proof. Let \mathcal{I} be as in the proof of Lemma 3.2, and let $\mathcal{G} \subset \mathcal{I}$ be the set of all such equivalence classes of sequences of positive integers greater than or equal to 4. By a proof similar to that of Lemma 3.2, the cardinality of \mathcal{G} is \mathfrak{c} . Let \mathfrak{G} be a set formed upon choosing one sequence from each equivalence class in \mathcal{G} . Since by Theorem 3.26 the embeddings $\psi_{\mathbf{N}}$ and $\psi_{\mathbf{M}}$ are inequivalent planar embeddings of K whenever \mathbf{N} and \mathbf{M} are inequivalent sequences in \mathfrak{G} , it follows that $\Psi = \{\psi_{\mathbf{N}} \mid \mathbf{N} \in \mathfrak{G}\}$ is a collection of planar embeddings of K whose cardinality is \mathfrak{c} . Furthermore, the image of each member of Ψ has the same set of accessible points as the standard embedding of K by Proposition 3.6. \square

4. CLOSING COMMENTS AND OPEN QUESTIONS

The question of which HDCC admit uncountably many mutually inequivalent planar embeddings is still an open problem. The previously described techniques for constructing \mathfrak{c} -many mutually inequivalent planar embeddings for K may provide insight into how this more general problem can be solved. However, since any given HDCC, X , may possess a highly complex underlying structure on its generalized layers, producing planar embeddings of X using similar such techniques can prove difficult in controlling the details of their constructions.

Question 1. Can the techniques of producing \mathfrak{c} -many mutually inequivalent planar embeddings of K as in Section 2 and Section 3 be generalized to all non-arc HDCC? If not for all non-arc HDCC, can they be generalized to those whose layer level is finite?

We may also be able to provide a partial answer to the more general question above by exploring HDCC which yield a decomposition similar to that of $K = K_1 \cup K_2 \cup \dots \cup E$ as in Section 3. In particular, suppose X is an HDCC with left end layer E_X . Furthermore, suppose X can be decomposed as $X = X_1 \cup X_2 \cup \dots \cup E_X$, where $X_i \cap E_X = \emptyset$ for each $i \in \mathbb{N}$, and so that $X_i \cap X_j$ is a subcontinuum C_i of X if and only if $|i - j| \leq 1$, with $\text{diam}(C_i) \rightarrow 0$ as $i \rightarrow \infty$. We thus pose the following question.

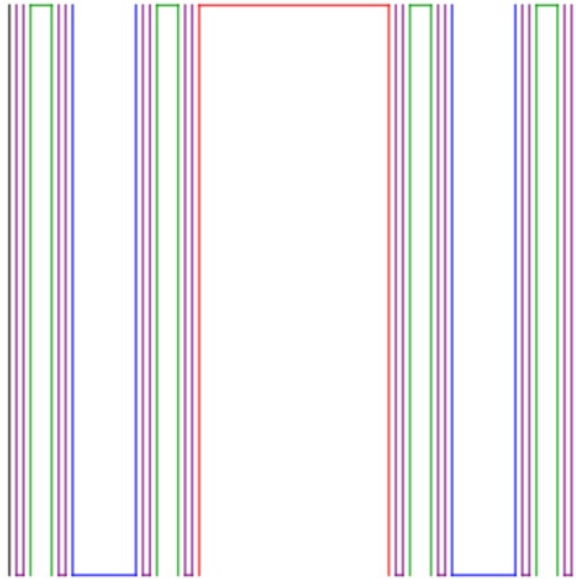

FIGURE 12. The Cantor organ, C , represented by the first four iterations of its construction including its end layers. The layer level of C is the same as that of K . In fact, C can be constructed from K by "blowing up" each individual vertex of V and Λ layers of K into a horizontal arc. Likewise, K can be constructed from C by collapsing each individual horizontal arc in C to a point.

Question 2. Can any non-arc HDCC possessing a decomposition as described in the previous paragraph be embedded in the plane in \mathfrak{c} -many mutually inequivalent ways? If so, can such embeddings be constructed according to sequences of positive even integers greater than or equal to 4 as was done for K in section 3?

There are many simple examples of HDCC which match the decomposition criteria mentioned in the paragraph before the previous question. The simplest such non-arc candidates are those possessing a subcontinuum which is the compactification of a ray with an arc. However, as we stated in section 1, and as was mentioned in [2], it is likely that such HDCC can be embedded in the plane in uncountably many mutually inequivalent ways. Another example of a non-arc HDCC other than K matching the aforementioned decomposition criteria above is the continuum C depicted in Figure 12 known as the *Cantor organ*. C was given as an example of an irreducible space by Kuratowski in Chapter V, §48 of [9]. Though the Cantor set is

invoked in its construction, Kuratowski did not refer to C as the Cantor organ. However, one can find that Janusz J. Charatonik, Pawel Krupski, and Pavel Pyrih have given C this name in [7]. Regardless of the nomenclature, one may naturally propose a way to construct \mathfrak{c} -many mutually inequivalent planar embeddings of C similar to the schema embeddings of K in Section 3.

Recall the statements of Corollary 1.7 and Lemma 1.8. To summarize, layers of K of a given type are mapped to layers of the same type under a homeomorphism of K onto itself, but it is not necessary that any layer is mapped onto itself.

Question 3. Is there a planar embedding φ of K such that, for every layer L of K and every homeomorphism h of the plane onto itself mapping $\varphi(K)$ onto itself, $h(\varphi(L)) = \varphi(L)$? If so, what other HDCC have this property?

It is possible that the question above can be answered for K by inserting schema embeddings of subcontinuum copies of K "all over K ." However, the details of providing such an embedding of K are yet to be developed. It may also be possible that if such an embedding can be constructed, there exist \mathfrak{c} -many mutually inequivalent such embeddings.

REFERENCES

- [1] Ana Anušić, Jernej Činč, *Accessible points of planar embeddings of tent inverse limit spaces*, *Dissertationes Mathematicae* **541** (2019), 1-57.
- [2] Ana Anušić, Henk Bruin, and Jernej Činč, *Planar Embeddings of Chainable Continua*, *Topology Proceedings* **56** (2020), pp. 263-296.
- [3] Ana Anušić, Henk Bruin, and Jernej Činč, *Problems on Planar Embeddings of Chainable Continua and Accessibility*, *Topology Proceedings* **52** (2018), pp. 281-308.
- [4] Ana Anušić, Henk Bruin, Jernej Činč, *Uncountably many planar embeddings of unimodal inverse limit spaces*, *Discrete and Continuous Dynamical Systems - Series A* **37** (2017), 2285–2300.
- [5] R. H. Bing, *Snake-like continua*, *Duke Math J.* **18** (1951), 653-663.
- [6] Stewart S. Cairns, *Proceedings of the American Mathematical Society*, *Proceedings of the American Mathematical Society* **2** No. 6 (Dec. 1951), pp. 860-867.
- [7] Janusz J. Charatonik, Pawel Krupski, and Pavel Pyrih, *Cantor organ and accordion*, <http://www.karlin.mff.cuni.cz/~pyrih/e/e2001v2/c/ect/node49.html>
- [8] Kenneth Kunen, "Set Theory, An Introduction to Independence Proofs," *Studies in Logic and Foundations of Mathematics*, Elsevier Science Publishers B.V., 1980.
- [9] K. Kuratowski, "Topology," Vol. II, Academic Press, New York, and Polish Scientific Publishers, Warsaw, 1968.
- [10] W. Lewis *Embeddings of the pseudo-arc in E^2* , *Pacific Journal of Mathematics* **93** No. 1 (1981), 115-120.
- [11] David Sumner Lipham, *Singularities of meager composants and filament composants*, arXiv:1806.10828v12 [math.GN] 25 Dec 2018.

- [12] J.C. Mayer, *Inequivalent Embeddings and Prime Ends*, Topology Proc. **8** (1983), pp. 99-159.
- [13] Piotr Minc and W.R.R. Transue, *Accessible Points of Hereditarily Decomposable Chainable Continua*, Transactions of the American Mathematical Society **332** No. 2 (1992), 711-727.
- [14] Piotr Minc and W.R.R. Transue, *Sarkovskii's Theorem for Hereditarily Decomposable Chainable Continua*, Transactions of the American Mathematical Society **315** No. 1 (1989), pp. 173-188.
- [15] L. Mohler, *The depth of tranches in λ -dendroids*, Proc. Amer. Math. Soc. **96** (1986), 715-720.
- [16] Sam B. Nadler Jr., "Continuum Theory: An Introduction," Monographs and Textbooks in Pure and Applied Mathematics, 158. Marcel Dekker, Inc., New York, 1992.
- [17] Sam B. Nadler, Jr., *Some results and problems about embedding certain compactifications*, Proceedings of the University of Oklahoma Topology Conference (1972), 222-233.
- [18] James T. Rogers, Jr., *Classifying homogeneous continua*, Topology and its Applications **44** (1992), 341-352.
- [19] James T. Rogers, Jr., *Rotations of simply connected regions and circle-like continua*, Contemporary Mathematics **117** (1991), 139-148.
- [20] Waclaw Sierpiński, "Cardinal and Ordinal Numbers," Polska Akademia Nauk Monografie Matematyczne. **34**, 1958.
- [21] M. Smith, *Plane indecomposable continua no composant of which is accessible at more than one point*, Fund. Math. **111** (1981), 61-69.
- [22] E. S. Thomas, Jr., *Monotone decompositions of irreducible continua*, Rozprawy Mat. **50** (1960).

JOSEPH S. OZBOLT, COLSA CORPORATION, 6728 ODYSSEY DR NW, HUNTSVILLE,
ALABAMA 35806

Email address: joesozbolt@gmail.com