

Smooth points of the space of plane foliations with a center

LUBOMIR GAVRILOV¹ HOSSEIN MOVASATI²

Abstract

We prove that a logarithmic foliation corresponding to a generic line arrangement of $d+1 \geq 3$ lines in the complex plane, with pairwise natural and co-prime residues, is a smooth point of the center set of plane foliations (vector fields) of degree d .

1 Introduction

The present paper is a contribution to the classical center-focus problem (the problem of distinguishing between a center and a focus of a plane vector field). We consider the set of complex polynomial plane vector fields of degree at most d , or equivalently, affine polynomial degree d foliations in \mathbb{C}^2 :

$$\mathcal{F}(d) = \{\mathcal{F}(P(x, y)dy - Q(x, y)dx) \mid P, Q \in \mathbb{C}[x, y], \deg(P), \deg(Q) \leq d\}.$$

We identify $\mathcal{F}(d)$ to the set of coefficients of the polynomials P, Q (that is to say to $\mathbb{C}^{(d+1)(d+2)}$). We say that a given foliation (a point in $\mathcal{F}(d)$) has a Morse center at $p \in \mathbb{C}^2$, or simply a center, if it allows a local analytic first integral which has a Morse critical point at p . It is well-known that the Zariski closure of the set of foliations with a Morse center, the so called *center set*, is an algebraic set, see [Lin14, Mov04a]. We denote this center set by $\mathcal{M}(d) \subset \mathcal{F}(d)$. It has a canonical decomposition (up to a permutation)

$$\mathcal{M}(d) = \cup_i \bar{\mathcal{L}}_i, \quad \bar{\mathcal{L}}_i \not\subseteq \bar{\mathcal{L}}_j, i \neq j \quad (1)$$

into closed irreducible algebraic varieties $\bar{\mathcal{L}}_i$. *The center-focus problem in this setting is to describe the irreducible components $\bar{\mathcal{L}}_i$ of the center set $\mathcal{M}(d)$.* The problem is largely open, except in the quadratic case ($d = 2$). It follows from the Dulac's computation of quadratic systems with a center [Dul23], that $\mathcal{M}(2)$ has four irreducible components, parameterised via their explicit first integrals. In the case $d > 2$ only some irreducible components of $\mathcal{M}(d)$

¹Institut de Mathématiques de Toulouse, UMR 5219, Université de Toulouse, 31062 Toulouse, France. lubomir.gavrilov@math.univ-toulouse.fr

²Instituto de Matemática Pura e Aplicada, IMPA, Estrada Dona Castorina, 110, 22460-320, Rio de Janeiro, RJ, Brazil, hossein@impa.br

are known. For a conjecturally complete list of cubic systems with a center we refer the reader to [Zol94b, Zol94a, BK10, Bot07].

Suppose that $\mathcal{L} \subset \mathcal{M}(d)$ is an irreducible algebraic set (algebraic variety) formed by foliations with a center. To show that its Zariski closure $\bar{\mathcal{L}}$ is also an irreducible component of $\mathcal{M}(d)$, like in (1), is a local problem. Therefore we may choose a suitable point $\mathcal{F}_0 \in \mathcal{L} \subset \mathcal{M}(d)$ and compare the tangent space of \mathcal{L} at \mathcal{F}_0 and the tangent space of $\mathcal{M}(d)$ at \mathcal{F}_0 . If the dimension of these spaces are the same, then the condition $\mathcal{L} \not\subset \mathcal{L}_j$ (1) is certainly satisfied and therefore \mathcal{L} is an irreducible component of the center set $\mathcal{M}(d)$.

The computation of the tangent cone of $\mathcal{M}(d)$ (even if $\mathcal{M}(d)$ is not known!) turns out to be possible by making use of the machinery of Melnikov functions, as shown by Ilyashenko [Ily69] (in the Hamiltonian case), Movasati [Mov04a, Mov04b] (the case of logarithmic foliations), Zare [Zar19] (pull back foliations), Gavrilov [FGX20] (centers of Abel equations). In all these cases it has been shown, that the corresponding irreducible algebraic set of systems with a center is indeed an irreducible component of $\mathcal{M}(d)$.

In the present paper we focus our attention to logarithmic foliations of the form

$$\mathcal{F}_0 : l_1 l_2 \dots l_{d+1} \left(\sum_{i=1}^{d+1} \lambda_i \frac{dl_i}{l_i} \right) = 0, \quad d \geq 2, \quad (2)$$

where $\lambda_i \in \mathbb{C}^*$ and $l_i = l_i(x, y)$ are complex bivariate polynomials of degree one. Obviously the foliation \mathcal{F}_0 has a first integral of the form

$$l_1^{\lambda_1} l_2^{\lambda_2} \dots l_{d+1}^{\lambda_{d+1}}. \quad (3)$$

In what follows we suppose that the polynomials l_i define a line arrangement without triple intersection points (a general line arrangement), and that $\lambda_i \neq 0$. The set of such foliations is denoted by $\mathcal{L}(1^{d+1}) = \mathcal{L}(1, 1, \dots, 1)$. The Zariski closure $\bar{\mathcal{L}}(1^{d+1}) \subset \mathcal{F}(d)$ is an irreducible component of the corresponding center set $\mathcal{M}(d)$ [Mov04b]. If another irreducible component of $\mathcal{M}(d)$ is of dimension at least equal to the co-dimension of $\mathcal{L}(1^{d+1})$, then it certainly intersects $\bar{\mathcal{L}}(1^{d+1})$. Therefore, the study of the structure of the center set in a small neighbourhood of $\bar{\mathcal{L}}(1^{d+1})$ implies also a global information on $\mathcal{M}(d)$. Note that if the foliation \mathcal{F}_0 belongs to the intersection of $\mathcal{L}(1^{d+1})$ with another irreducible component of the center set, then \mathcal{F}_0 is a non smooth point of $\mathcal{M}(d)$. This motivates the following problem, which is partially solved in the paper : *Classify the smooth points of $\mathcal{M}(d)$ along the irreducible component $\mathcal{L}(1^{d+1})$.* We prove the following

Theorem 1. *Let λ_i , $i = 1, \dots, d + 1$, be mutually prime distinct natural numbers. Let $l_i = l_i(x, y)$, $i = 1, \dots, d + 1$, be linear bivariate polynomials*

defining a generic line arrangement (generic means that there are no triple points). Then the logarithmic foliation \mathcal{F}_0 defined by (2) is a smooth point of the center set $\mathcal{M}(d)$.

If \mathcal{F}_0 is a general logarithmic foliation of the form (2) such that \mathcal{F}_0 is a smooth point of the center set $\mathcal{M}(d)$, then obviously every small degree d deformation with a persistent center is also a deformation by logarithmic foliations. Therefore the above theorem is close to another classical result which we recall now. Consider the set $\mathcal{L}(d+1) \subset \mathcal{M}(d)$ formed by Hamiltonian foliations $\mathcal{F} : dH = 0$ where H is an arbitrary degree $d+1$ bivariate polynomial. Suppose in addition that H is a "Morse plus" polynomial (has only Morse critical points with distinct critical values). It is proved by Ilyashenko [Ily69], that if in a deformation of the Morse plus Hamiltonian foliation dH the center persists, then this deformation is Hamiltonian too. The proof implies also that $\mathcal{F} : dH = 0$ is a smooth point of $\mathcal{M}(d)$.

It is clear that when two irreducible components of $\mathcal{M}(d)$ intersect at \mathcal{F}_0 , then \mathcal{F}_0 is a non-smooth point of $\mathcal{M}(d)$. It is less known that even when \mathcal{F}_0 does not belong to different irreducible components of $\mathcal{M}(d)$, it can still be a non-smooth point of $\mathcal{M}(d)$. This happens even in the quadratic case ($d=2$), for an example see the last section of the paper.

Our final remark is that it follows from the computation of the tangent cone (which turns out to be a tangent space) that $\mathcal{L}(1^{d+1})$ is an irreducible component of the center set $\mathcal{M}(d)$. This proof is quite different compared to the original proof [Mov04b], as the tangent cone to $\mathcal{M}(d)$ is computed at a smooth point \mathcal{F}_0 (like in [Ily69]).

The article is organised in the following way. In Section 2 we develop the Picard-Lefschetz theory of the fibration of the polynomial $x^n y^m$ where n, m are natural numbers (not necessarily coprime). In Section 3 we study the topology of the fibers of f

$$f = l_1^{n_1} l_2^{n_2} \dots l_{d+1}^{n_{d+1}}.$$

where l_i are lines in a general position, and n_i are positive integers without common divisors. (we do not suppose that n_i, n_j are relatively prime). As a by-product we get a genus formula for the fibers of f . In Section 4 we generalise a theorem due to A'Campo and Gusein-Zade [A'C75, GZ74] in the context of a logarithmic foliation defined by the polynomial f . In Section 5 we compute the orbit of a vanishing cycle under the action of the monodromy in the homology bundle of f . As a by product, this implies that the orbit of this vanishing cycle contains the homology of the compactified fiber. This is the only place where we use the fact that n_i 's are pairwise coprime. Summing

up all these results leads to the proof of Theorem 1, given in the last Section 6.

The article was written while the first author was visiting the University of Toulouse III. He would like to thank for the stimulating research atmosphere, as well for the financial support of CIMI and CNRS.

2 The Picard-Lefschetz formula of a plane non-isolated singularity

The first attempt to describe Picard-Lefschetz theory of fibrations with non-reduced fibers is done in [Cle69], however, the main result of this paper Theorem 4.4 is not applicable in our context, and so, we elaborate Theorem 2 which explicitly describe a kind of Picard-Lefschetz formula.

In this section we consider the local fibration $f : (\mathbb{C}^2, 0) \rightarrow (\mathbb{C}, 0)$ given by $f = x^m y^n$, where m, n are two positive integers. We will use the notation:

$$e := (m, n), \quad p := \frac{m}{e}, \quad q := \frac{n}{e}$$

where $(m, n) = \gcd(m, n)$ means the greatest common divisor of m and n . It might be easier to follow the content of the present section for the case $e = 1$. For $t \in \mathbb{R}^+$ let

$$\Gamma := \left\{ (r, s) \in \mathbb{R}^+ \times \mathbb{R}^+, \left| r^m s^n = t \right. \right\}.$$

We consider it as an oriented path in $f^{-1}(t)$ for increasing s for which we use the letter γ . We consider the following parameterization of the fiber $f^{-1}(t)$ for $t \in \mathbb{R}^+$

$$\begin{aligned} \mathbb{R} \times \Gamma &\rightarrow f^{-1}(t), \quad h = 0, 1, 2, \dots, e-1 & (4) \\ (\theta, r, s) &\mapsto (x, y) = \left(r e^{2\pi i(\theta q + \frac{h}{m})}, s e^{-2\pi i \theta p} \right). \end{aligned}$$

The fiber $f^{-1}(t)$ consists of e cylinders indexed by h and the above parametrization is periodic in θ with period 1.

Definition 1. By a straight path in $f^{-1}(t)$ we mean a path which is the image of a path α in $\mathbb{R} \times \Gamma$ under the parameterization (4) and with the following property: α maps bijectively to its image under the projection $\mathbb{R} \times \Gamma \rightarrow \mathbb{R}$.

For simplicity, we consider the parameters with $|t| < 1$ and define $L_t := f^{-1}(t) \cap B$, where B is the complex square $\{(x, y) \in \mathbb{C}^2 \mid |x| \leq 1, |y| \leq 1\}$.

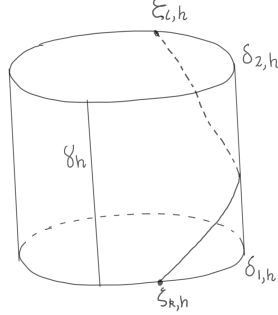

Figure 1: A cylinder and straight path

In this way, L_t is a union of e compact cylinders, let us say $L_t = \cup_{h=0}^{e-1} L_{t,h}$. A circle in each cylinder $L_{t,h}$ is parameterized with fixed (r, s) and for $(r, s) = (1, |t|^{\frac{1}{n}})$ and $(|t|^{\frac{1}{m}}, 1)$ we get two circles of its boundary and denote them by $\delta_{1,h}$ and $\delta_{2,h}$, respectively, and give them a natural orientation coming from $\theta \in [0, 1]$ running from 0 to 1. We denote by $\delta_h : [0, 1] \rightarrow L_{t,h}$ the closed path given by the parameterization (4) and fixed (r, s) . This is homotopic to $\delta_{1,h}$ and $\delta_{2,h}$. We also denote by γ_h the non closed path in $L_{t,h}$ given by the parameterization (4) and $\theta = 0$. Note that $\gamma := \gamma_0$ is the only path from $(1, t^{\frac{1}{n}})$ to $(t^{\frac{1}{m}}, 1)$ in the real plane \mathbb{R}^2 .

We consider in B two transversal sections $\Sigma_1 := \{x = 1\}$, $\Sigma_2 := \{y = 1\}$ to the x and y -axis, respectively, and define $\Sigma := \Sigma_1 \cup \Sigma_2$. The intersections $\{|x| = 1\} \cap L_t$ and $\{|y| = 1\} \cap L_t$ are the union of circles $\cup_{h=0}^{e-1} \delta_{i,h}$ for $i = 1, 2$ respectively, and they have the following finite subsets

$$\begin{aligned} \Sigma_1 \cap L_t &= \{\zeta_{k,h}, k = 0, 1, \dots, q-1, h = 0, 1, \dots, e-1\}, \\ \Sigma_2 \cap L_t &= \{\xi_{l,h}, l = 0, 1, \dots, p-1, h = 0, 1, \dots, e-1\}, \end{aligned}$$

where

$$\zeta_{k,h} := (1, t^{\frac{1}{n}} e^{-2\pi i(\frac{km-h}{n})}), \quad \xi_{l,h} := (t^{\frac{1}{m}} e^{2\pi i(\frac{ln+h}{m})}, 1). \quad (5)$$

For $\Sigma_1 \cap L_t$ we have set $\theta = \frac{mk-h}{[m,n]}$ and for $\Sigma_2 \cap L_t$ we have set $\theta = \frac{nl}{[m,n]}$. We have a natural action of the multiplicative group of n -th (resp. m -th) roots of unity on the set $\Sigma_1 \cap L_t$ (resp. $\Sigma_2 \cap L_t$) which is given by multiplication in the second coordinate.

Proposition 1. *The relative homology group $H_1(L_t, L_t \cap \Sigma; \mathbb{Z})$ is freely generated \mathbb{Z} -module of rank $n + m$.*

Proof. This follows from the long exact sequence in homology of the pair $L_t, L_t \cap \Sigma$:

$$\begin{array}{ccccccc} 0 & \rightarrow & H_1(L_t) & \rightarrow & H_1(L_t, \Sigma \cap L_t) & \rightarrow & H_0(\Sigma \cap L_t) \rightarrow H_0(L_t) \rightarrow 0 \\ & & \parallel & & \parallel & & \parallel \\ & & \mathbb{Z}^e & & \mathbb{Z}^{m+n} & & \mathbb{Z}^{m+n} \\ & & & & & & \parallel \\ & & & & & & \mathbb{Z}^e \end{array}$$

□

Since p and q are coprime positive integers, we can find $a, b \in \mathbb{Z}$ such that

$$ap - bq = 1, \quad 0 \leq a \leq q - 1, \quad 0 \leq b \leq p - 1,$$

for $p, q \geq 2$. Equivalently, $am - bn = e$. We also consider the cases:

$$\begin{cases} a = 1, b = 0 & \text{if } p = 1 \\ a = 1, b = p - 1 & \text{if } q = 1 \end{cases}.$$

If we change the order of p and q we only need to replace a and b with $q - a$ and $p - b$, respectively.

Theorem 2. *Let γ be a straight path which connects $\zeta_{k,h} \in L_t \cap \Sigma_1$ to $\zeta_{l,h} \in L_t \cap \Sigma_2$. The anticlockwise monodromy $h(\gamma)$ of γ around $t = 0$ is a straight path which connects*

$$\begin{cases} \zeta_{k,h+1} \text{ to } \xi_{l,h+1} & \text{if } h + 1 < e, \\ \zeta_{k-a,0} \text{ to } \xi_{l-b,0} & \text{if } h + 1 = e. \end{cases}$$

In particular, we have the classical Picard-Lefschetz formula

$$h^{[m,n]}(\gamma) = \gamma + \delta, \quad (6)$$

where $[m, n]$ is the lowest common multiple of m and n .

Proof. We consider the differential form $\omega := m \frac{dx}{x} = -n \frac{dy}{y}$ in L_t , where the last equality is written restricted to L_t . We observe that

$$\begin{aligned} \int_{\gamma_h} \omega &= \ln(t), \\ \int_{\delta(\theta)}^{\delta(\theta+\alpha)} \omega &= 2\pi i [m, n] \alpha, \quad \text{and hence } \int_{\delta} \omega = 2\pi i [m, n]. \end{aligned}$$

Actually, in the first formula γ can be any path with parametrization in (4) with fixed θ . We have

$$\zeta_{k,h} e^{2\pi i \frac{1}{n}} = (1, e^{-2\pi i (\frac{km-(h+1)}{n})}) = \begin{cases} \zeta_{k,h+1} & \text{if } h + 1 < e \\ (1, e^{-2\pi i (\frac{k-a}{n})}) = \zeta_{k-a,0} & \text{if } h + 1 = e \end{cases} \quad (7)$$

and

$$\xi_{l,h} e^{2\pi i \frac{1}{m}} = (e^{-2\pi i (\frac{ln+(h+1)}{m})}, 1) = \begin{cases} \xi_{l,h+1} & \text{if } h+1 < e \\ (1, e^{-2\pi i \frac{(l-b)n}{m}}) = \xi_{l-b,0} & \text{if } h+1 = e \end{cases} \quad (8)$$

For the equalities in the case $h+1 = e$ we have used $e = am - bn$. The above equalities imply that $h(\gamma)$ has the right starting and end points as announced in the theorem. By Cauchy's theorem we have

$$\int_{\gamma} \omega = \int_{\gamma_h} \omega + 2\pi i [m, n] \frac{nl}{[m, n]} - 2\pi i [m, n] \frac{mk - h}{[m, n]} = \int_{\gamma_h} \omega + 2\pi i (nl - mk + h).$$

Now, we consider a straight path $\tilde{\gamma}$ in $L_{t,h+1}$ which connects (7) to (8). A similar formula for $\tilde{\gamma}$ as above, and knowing that $\int_{\gamma_h} \omega = \int_{\gamma_{h+1}} \omega = \ln(t)$ give us

$$\int_{\tilde{\gamma}} \omega = \int_{\gamma} \omega + 2\pi i$$

which implies $h(\gamma) = \tilde{\gamma}$ for $h+1 < e$. For $h+1 = e$ this follows from

$$\int_{\tilde{\gamma}} \omega = \int_{\gamma_0} \omega + 2\pi i [m, n] \frac{n(l-b)}{[m, n]} - 2\pi i [m, n] \frac{m(k-a)}{[m, n]} = \int_{\gamma_0} \omega + 2\pi i (nl - mk + e).$$

As a corollary we can get the classical formula for the monodromy $h^{[m,n]}(\gamma)$ in (6). We know that $h^e(\gamma)$ is the straight path connecting $\zeta_{k-a,0}$ to $\xi_{l-b,0}$, and so its pq times iteration is the straight path connecting $\zeta_{k-pqa,0}$ to $\xi_{l-pqb,0}$. Since $ap - bq = 1$ we get (6). \square

In order to make the content of this section more accessible for applications we have made Figure 3, and an example of it in Figure 2, which shows the deformation retract of L_t for which one can describe the action of monodromy. The points in $\Sigma_i \cap L_t$, $i = 1, 2$ are ordered according to the usual order of roots of unity and we identify them with $\Sigma_1 := \{0, 1, 2, \dots, n-1\}$ and $\Sigma_2 := \{0, 1, 2, \dots, m-1\}$, respectively. In this way

$$\begin{aligned} \Sigma_1 \cap L_{t,h} &= \{h, e+h, 2e+h, \dots, (q-1)e+h\}, \\ \Sigma_2 \cap L_{t,h} &= \{h, e+h, 2e+h, \dots, (p-1)e+h\}. \end{aligned}$$

In $\Sigma_1 \cap L_{t,h}$ and $\Sigma_2 \cap L_{t,h}$ we take minus h and divide by e and connect them to $\Sigma_{1,h} := \{0, 1, 2, \dots, q-1\}$ and $\Sigma_{2,h} := \{0, 1, \dots, p-1\}$, respectively. We consider another copy $\Sigma'_{1,h}$ of $\Sigma_{1,h}$ and connect $x \in \Sigma_{1,h}$ to $x(-p)^{-1} \in \Sigma'_{1,h}$ modulo q and another copy $\Sigma'_{2,h}$ of $\Sigma_{2,h}$ connecting $x \in \Sigma_{2,h}$ to $xq^{-1} \in \Sigma'_{2,h}$ modulo p . Now, all the points of $\Sigma'_{i,h}$, $i = 1, 2$ are connected to a single

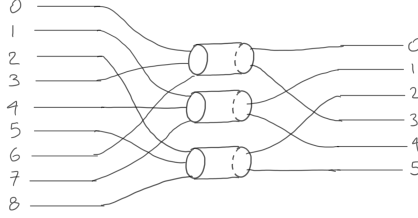

Figure 2: A passage from one transversal section to another: $n = 9, m = 6$

point p_h for which we also consider a loop δ_h at p_h with orientation. We now describe the monodromy. Consider a path γ from $ie + h \in \Sigma_1$ to $je + h$ which turns in δ_h , $s_\gamma \in \mathbb{Z}$ times. If $h < e - 1$ the monodromy $h(\gamma)$ of γ is a similar path starting from $ie + h + 1$ and $je + h + 1$ and turning in the loop δ_{h+1} , s_γ times. If $h = e - 1$ then $h(\gamma)$ starts from ie and ends in jb . If γ passes through $k \in \Sigma'_{1,e-1}$ and $l \in \Sigma'_{2,e-1}$ then $h(\gamma)$ passes through $k - a \in \Sigma'_{1,0}$ and $l - b \in \Sigma'_{2,0}$. The number of turns in δ_0 of $h(\gamma)$ is $s_\gamma + \left\lfloor \frac{k-a}{q} \right\rfloor + \left\lfloor \frac{l-b}{p} \right\rfloor$.

3 Product of $d + 1$ lines in general position

We consider the polynomial

$$f = l_1^{n_1} l_2^{n_2} \dots l_{d+1}^{n_{d+1}}. \quad (9)$$

where l_i are lines in a general position, and n_i are positive integers without common divisors. We do not suppose that n_i, n_j are relatively prime. Let

$$L_t = \{(x, y) \in \mathbb{C} : f(x, y) = t\}.$$

Theorem 3. *If t is a regular value of f , then*

$$H_1(L_t, \mathbb{Z}) \cong \mathbb{Z}^{(d-1)(n_1+n_2+\dots+n_{d+1})+1}. \quad (10)$$

Proof. We fix a fiber $X := L_t$ with t near to zero, consider the projection in x coordinate $\pi : X \rightarrow \mathbb{C}$, $(x, y) \rightarrow x$ and assume that the parallel lines $x = \text{constant}$ are transversal to lines l_i and any two intersection points of l_i 's

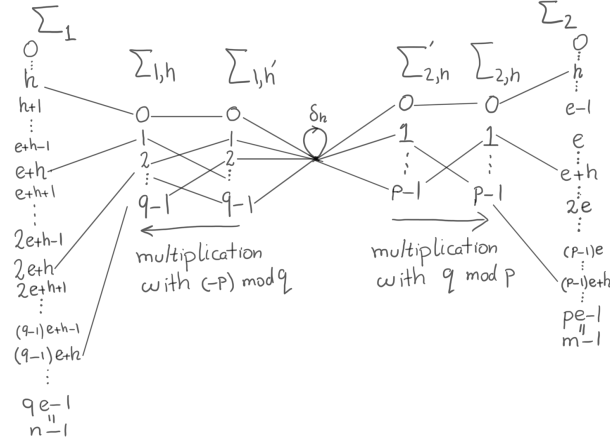

Figure 3: The passage from Σ_1 to Σ_2 .

have not the same x -coordinate. It turns out that the set of critical points of π is a union of $\frac{d(d+1)}{2}$ sets P_{ij} which is near to $l_i \cap l_j$. Let $C_{ij} = \pi(P_{ij})$ and consider a regular point $b \in \mathbb{C}$ for π and $\Sigma := \pi^{-1}(b)$. This is a union of $\sum_{i=1}^{d+1} n_i$ distinct points. Let also D_{ij} be a small disc around C_{ij} and b_{ij} be a point in its boundary. A classical argument in the topology of algebraic varieties involving deformation retracts and excision theorem, see for instance [Lam81, 5.4.1],[Mov21, Section 6.7], gives us:

$$H_1(X, \Sigma, \mathbb{Z}) = \bigoplus_{ij} H_1(\pi^{-1}(D_{ij}), \pi^{-1}(b_{ij}), \mathbb{Z}). \quad (11)$$

Now $\pi^{-1}(D_{ij})$ is a union of (n_i, n_j) cylinders with $n_i + n_j$ points from $\pi^{-1}(b_{ij})$ in its boundary (as in Section 2) and $(\sum_{k=1}^{d+1} n_k) - n_i - n_j$ discs, each one with one point from $\pi^{-1}(b_{ij})$ in its boundary. Using Proposition 1 we conclude that

$$H_1(X, \Sigma) \cong \mathbb{Z}^{d(n_1+n_2+\dots+n_{d+1})}.$$

The long exact sequence of the pair X, Σ finishes the proof.

$$0 \rightarrow H_1(L_t) \rightarrow H_1(L_t, \Sigma) \rightarrow H_0(\Sigma) \rightarrow H_0(L_t) \rightarrow 0$$

$$\quad \quad \quad \parallel \quad \quad \quad \parallel \quad \quad \quad \parallel$$

$$\quad \quad \quad \mathbb{Z}^{d(n_1+n_2+\dots+n_{d+1})} \quad \quad \quad \mathbb{Z}^{n_1+n_2+\dots+n_{d+1}} \quad \quad \quad \mathbb{Z}$$

□

Corollary 1. *The genus of the curve L_t equals*

$$\frac{1}{2} \left((d-1)n + 2 - \sum_{i=1}^{d+1} (n_i, n) \right), \quad n := \sum_{j=1}^{d+1} n_j,$$

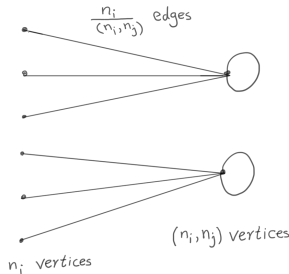

Figure 4: Deformation retract of L_t

where $f := l_1^{n_1} l_2^{n_2} \dots l_{d+1}^{n_{d+1}}$ and t is a regular value of f .

Proof. By genus of L_t we mean the genus of the compactified and desingularized curve. The hypothesis $\gcd(n_1, n_2, \dots, n_{d+1}) = 1$ and t is not a critical value of f , together imply that the curve $f = t$ is an irreducible polynomial. The curve $f = t$ intersects the line at infinity \mathbb{P}^1 at the intersection p_i of the lines $l_i = 0$ with \mathbb{P}^1 . Near p_i our curve has (n_i, n) local irreducible components because

$$f - t = \frac{(a_i x + b y_i + c_i z)^{n_i}}{z^n} g_i$$

where $l_i = a_i x + b y_i + c_i$ and g_i is a holomorphic function near p_i with $g(p_i) \neq 0$. \square

The genus of the degree three curve $\{xy(x + y - 1) = 1\}$ is one. The genus of the degree six curve $\{xy^2(x + y - 1)^3 = 1\}$ is also one.

We are going to define a graph with $\sum_{i \neq j} (n_i, n_j) + \sum_{i=1}^{d+1} n_i$ vertices. The (n_i, n_j) vertices corresponds to the intersection points $l_i \cap l_j$. The n_i vertices corresponds to the intersection of the line Σ in the proof of Theorem 3 with the fiber L_t , t near to zero. Each group of (n_i, n_j) vertices are connected with n_i edges, each one with $\frac{n_i}{(n_i, n_j)}$ edges, to n_i vertices in the second group corresponding the intersection of Σ with L_t near $l_i = 0$. This description is trivially unique for $(n_i, n_j) = 1$. If $(n_i, n_j) \neq 1$ we have to determine the decomposition of n_i vertices into $\frac{n_i}{(n_i, n_j)}$ sets of cardinality (n_i, n_j) . This might be done using the description of the deformation retract at the end of Section 2. Moreover, we consider a loop for each (n_i, n_j) vertices. This will

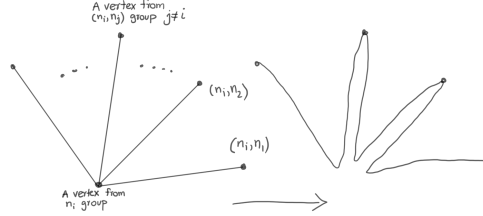

Figure 5: Getting the graph \check{G} from G

correspond to the saddle vanishing cycles. From the proof of Theorem 3 it follows that

Proposition 2. *The graph G is a deformation retract of L_t .*

For f and lines l_i defined over real numbers, there is another way to describe a simpler graph \check{G} which shows the homotopy type of L_t . Each vertex in the n_i group is connected with d edges to d vertices corresponding to the intersection of l_i with other lines. We order them as they meet l_i . We replace this with the one in Figure 5 and we get a graph \check{G} with $\sum_{i \neq j} (n_i, n_j)$ vertices which can be described easily using the real geometry of lines as follows. We cut out infinite segments of the union of lines $\cup_{i=1}^{d+1} l_i \subset \mathbb{R}^2$, replace each intersection point $l_i \cap l_j$ with (n_i, n_j) vertices and replace each finite segment which connects $l_i \cap l_j$ to $l_i \cap l_k$ (and does not intersect other lines in its interior) with n_i edges connecting (n_i, n_j) vertices with (n_i, n_k) vertices, provided that each vertex in the first and second group has only $\frac{n_i}{(n_i, n_j)}$ and $\frac{n_i}{(n_i, n_k)}$ edges respectively. Moreover, we consider a loop in each (n_i, n_j) vertices. We obtain the new graph \check{G} .

Remark 1. The the deformation retracts above appeared first in the study of the topology and the monodromy of the logarithmic foliation with first integral $f = x^p y^p (1 + x + y)$ in [BG11] in relation with the classical paper [vGH86].

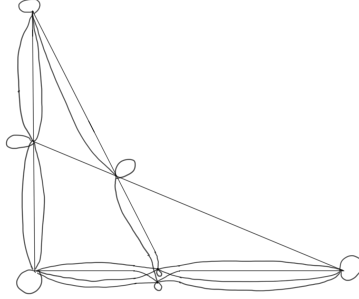

Figure 6: Deformation retract of L_t for four lines with multiplicities 1,2,3,4

4 Computation of intersection indices

The computation of intersection indices between vanishing cycles is an important ingredient in the study of deformations of singularities. By analogy we define intersection index for paths in the leaves of a holomorphic foliation. Our main result Theorem 4 in this section is a generalization of a theorem by S. Gusein-Zade and N. A'Campo, see [Mov04b, Section 2].

Let us consider a holomorphic foliation $\mathcal{F}(\omega)$ in \mathbb{R}^2 given by a polynomial 1-form ω with real coefficients. We consider an open subset $U \subset \mathbb{R}^2$ with exactly two saddle singularities O_1 and O_2 of \mathcal{F} and assume that O_1 and O_2 have a common separatrix. We assume that the 1-forms ω near O_i , $i = 1, 2$ in local coordinates (x_i, y_i) is given by the linear equation $x_i dy_i + \alpha_i y_i dx_i$, $\alpha_i > 0$, and so, it has the meromorphic local first integral $y_i x_i^{\alpha_i}$. In a neighborhood of O_i the foliation has two separatrices $x_i = 0$ and $y_i = 0$. The common separatrix is given by $y_i = 0$. We consider transversal sections to \mathcal{F} at the points b_0, b_1, b_2 respectively in the common separatrix, $x_1 = 0$ and $x_2 = 0$. Let γ_0 be the real trajectory of \mathcal{F} which connects a point $p_1 \in \Sigma_1$ to $p_2 \in \Sigma_2$ crossing the point $p_0 \in \Sigma_0$, see Figure 7.

We consider now the complex foliation \mathcal{F} in \mathbb{C}^2 and use the same notation for complexified objects. We consider a path $\lambda : \mathbb{R} \rightarrow \Sigma_0$ which has period one and restricted to $[0, 1]$ turns once around b_0 anticlockwise. The path γ_0 from p_1 to p_2 can be lifted to a unique path γ_t in a leaf of \mathcal{F} which crosses $\lambda(t) \in \Sigma_0$ and connects $q_1(t) \in \Sigma_1$ to $q_2(t) \in \Sigma_2$. This lifting in general is not possible, however, in our situation this follows from the fact that O_1 and O_2 are linearizable and $\alpha_i \in \mathbb{R}$. Since $\alpha_i > 0$, the trace of $q_i(t)$ in Σ_i will give us paths λ_i in Σ_i turning around b_i anticlockwise. If we assume that $\lambda(\frac{1}{2})$ is

again in the real domain \mathbb{R}^2 and it lies in a real leaf γ of \mathcal{F} in the other side of the common separatrix, then we have the main result of this section.

Theorem 4. *With the notations as above*

$$\langle \gamma_{\frac{1}{2}}, \gamma \rangle = +1, \quad (12)$$

where we have oriented γ from O_1 to O_2 .

Proof. We look at the projection $\pi(\gamma_t)$ of the path γ_t in the common separatrix and we see Figure 8. The projection can be constructed in a C^∞ context by gluing the local transversal foliations $dx_i = 0$, $i = 1, 2$. The intersection number is not changed under this projection and (12) follows. \square

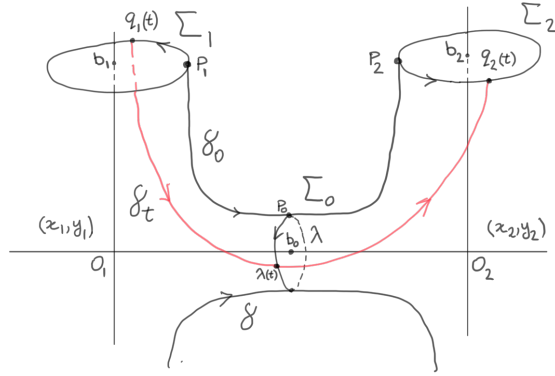

Figure 7: Two saddles

Remark 2. The above proof uses arguments close to the one used by Gusein-Zade [GZ74] for germs of isolated singularities. A second proof can be produced by making use of more elaborated arguments of A'Campo [A'C75, p.23-24] as follows. Consider the complex-conjugate path $\overline{\gamma_{\frac{1}{2}}} = \gamma_{-\frac{1}{2}}$. As the complex conjugation inverts the orientation then $\langle \gamma_{-\frac{1}{2}}, \gamma \rangle = -\langle \gamma_{\frac{1}{2}}, \gamma \rangle$. On the other hand the class $\gamma_{\frac{1}{2}} - \gamma_{-\frac{1}{2}}$ can be represented by two disjoint paths α_1, α_2 connecting Σ_1 to Σ_1 and Σ_2 to Σ_2 respectively. These paths define geometrically the holonomy of the two vertical separatrices. It remains to

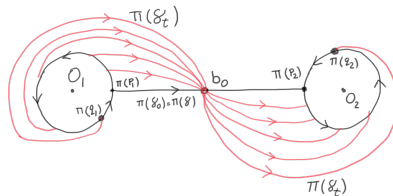

Figure 8: Projection into the common separatrix

compute the intersection index of α_1 (representing holonomy) and the class of $\gamma_{\frac{1}{2}}$ (representing the Dulac map near O_1). This is of course a local computation in a neighborhood of O_1 and it follows from the local description of a complex saddle that their intersection index equals one. Similar computation holds for α_2 from which the result follows.

A third proof can be obtained by deformation. Namely, it suffices to note that the intersection index depends continuously on parameters, hence it is a constant. Such a deformation is possible in any compact interval for the parameter, provided that the initial and end points of the path on the cross-section Σ_1 and Σ_2 are sufficiently close to the vertical separatrix. Therefore, it is enough to check the claim of the theorem for some toy example, like $df = 0$ with $f = (x^2 - 1)y$, in which an explicit computation of different paths and their deformations is possible.

Remark 3. Theorem 4 holds true without the assumption that the saddle are linearizable (with similar proof). We only need to know the asymptotic behavior of the Dulac map.

5 The orbit of a vanishing cycle of center type

Let us consider the polynomial f in \mathbb{C}^2 given by (9). The map $f : \mathbb{C}^2 \rightarrow \mathbb{C}$ defines a locally trivial fibration over the $\mathbb{C} \setminus C$, where C consists of $\frac{d(d-1)}{2} + 1$ critical values of f . It is the union of the values of critical points of center type (which we assume that such critical values are distinct) and the critical value 0 over the $\frac{d(d+1)}{2}$ saddles points which are intersection of lines. We

choose a point $b \in \mathbb{C}$ with $\text{Im}(b) > 0$ and fix straight paths γ_c , $c \in C$ joining b to the critical values of f (a distinguished set of paths). Let also $h_c : H_1(L_b, \mathbb{Z}) \rightarrow H_1(L_b, \mathbb{Z})$ be the monodromy along γ_c until getting near to c , turning around c anticlockwise and returning to b along γ_c^{-1} . Let $\delta_c \in H_1(L_b, \mathbb{Z})$ be the center vanishing cycle along λ_c , $c \neq 0$. Along γ_0 we get $\sum_{i \neq j} (n_i, n_j)$ saddle vanishing cycles in $H_1(L_b, \mathbb{Z})$. We denote by \overline{L}_b the curve obtained by a smooth compactification of L_b .

Theorem 5. *Assume that n_i 's are pairwise coprime. The \mathbb{Q} -vector space $O_\delta \subset H_1(L_b, \mathbb{Q})$ generated by the action of monodromy on a fixed center vanishing cycle δ has codimension d in $H_1(L_b, \mathbb{Q})$. Moreover,*

$$O_\delta = \left\{ \gamma \in H_1(L_b, \mathbb{Q}) \mid \int_\gamma \frac{dl_i}{l_i} = 0, i = 1, \dots, d+1 \right\} \quad (13)$$

and the restriction of the map $H_1(L_b, \mathbb{Q}) \rightarrow H_1(\overline{L}_b, \mathbb{Q})$ induced by inclusion, to O_δ is surjective.

Proof. Let $S \subset H_1(L_b, \mathbb{Q})$ be the \mathbb{Q} -vector space generated by saddle vanishing cycles. We first compute the action of monodromy in $H_1(L_b, \mathbb{Q})/S$. For this we prove that all center vanishing cycles are in O_δ . Consider center vanishing cycles $\delta = \delta_{c_1}, \delta_{c_2}$, the critical points p_1, p_2 with $f(p_i) = c_i$ which are inside two adjacent polygons P_1 and P_2 formed by the lines $l_i = 0$. Let l_1 be the line of the common edge which has multiplicity n_1 . We are in the situation of Theorem 4. The restriction of the map f to Σ_0 in a local coordinate z in Σ_0 is given by $z \mapsto z^{n_1}$. Let p_0, \tilde{p}_0 be two points in the real transversal section Σ_0 in \mathbb{R}^2 , p_0 above and \tilde{p}_0 under the line l_1 , and λ as in before Theorem 4. The image of λ under $f|_{\Sigma_0}$ is a path which starts at $f(p_0)$ and turns $\frac{n_1}{2}$ times around $0 \in \mathbb{C}$. The conclusion is that $h_0^{\lfloor \frac{n_1}{2} \rfloor + \epsilon}(\delta_{c_1})$ has a non-zero intersection with δ_{c_2} , where $\epsilon = 0$ if $f(p_0) > 0$ and $\epsilon = 1$ if $f(p_0) < 0$. Using the classical Picard-Lefschetz formula, see Theorem 2, we conclude that $\delta_{c_2} \in O_\delta$. Further applications of Picard-Lefschetz formula will imply that all center vanishing cycles are in O_δ .

Our hypothesis on n_i 's implies that over the point $l_i \cap l_j$ we have exactly one saddle vanishing cycle. For a finite polygon in the complement of $\cup_{i=1}^{d+1} l_i$ in \mathbb{R}^2 , let a_1, a_2, \dots, a_s be the multiplicity of its edges formed by the lines l_1, l_2, \dots, l_s . Let also δ be the center vanishing cycle inside this polygon. We look δ in the deformation retract G of L_b in Proposition 2. The monodromy $h^{a_1 a_2 \dots \hat{a}_i \dots a_s}(\delta)$, where \hat{a}_i means a_i is removed, fixes all the edges of δ_i except for the i -th edge, and its iteration will replace its i -th edge with any other a_i paths in the deformation retract of L_b . Moreover, any path in $H_1(G, \mathbb{Z})/S$ is a linear combination of center vanishing cycles. The conclusion is that

the action of monodromy on $H_1(L_b, \mathbb{Q})/S$ generates the whole space. By the classical Picard-Lefschetz formula we have

$$h^a(\delta) = \delta + \sum_{i=1}^s \frac{a}{a_i a_{i+1}} \delta_{i,i+1}, \quad a := a_1 a_2 \cdots a_s, \quad s+1 := 1, \quad (14)$$

where $\delta_{i,i+1}$ is the saddle vanishing cycle over $l_i \cap l_{i+1}$. It follows that by the action of monodromy we can generate a sum of saddle vanishing cycles as above. It is easy to see that these elements are linearly independent in $H_1(L_b, \mathbb{Q})$. The codimension in S of the \mathbb{Q} -vector space generated by these elements is exactly d .

Let $\delta_{i,h}$, $i = 1, 2, \dots, d+1$, $h = 1, 2, \dots, (n, n_i)$ be the closed cycles around the points at infinity $p_{i,h}$ of L_b corresponding to the intersection of l_i with the line at infinity. An easy residue calculation shows that

$$\int_{\delta_{j,h}} \frac{dl_i}{l_i} = \begin{cases} \frac{n-n_j}{(n, n_j)} & i = j \\ -\frac{n_j}{(n, n_j)} & i \neq j \end{cases}. \quad (15)$$

This shows that cohomology classes of the $d+1$ logarithmic one-forms $\frac{dl_i}{l_i}$ in $H_{dR}^1(L_b)$ generate a vector space of dimension d (there is one linear relation between these forms restricted on L_b). The equality (13) follows, as both sides of the equality are of codimension d and \subseteq is trivially true. Moreover, by (15) we have $\delta_{i,h} - \delta_{i,0} \in O_\delta$, $i = 1, 2, \dots, (n, n_i) - 1$ and $H_1(L_b, \mathbb{Q})$ is a direct sum of O_δ with the \mathbb{Q} -vector space generated by $\delta_{i,0}$, $i = 1, 2, \dots, d$. \square

Remark 4. A purely topological argument for the last part of the proof of Theorem 5 can be formulated following [Mov04b, Section 2] and it is as follows. Let us orient the center vanishing cycles using the anticlockwise orientation of \mathbb{R}^2 . We can orient the saddle vanishing cycle δ attached to $l_i \cap l_j$ in such a way that it intersects positively the center vanishing cycles in the finite polygons with $l_i \cap l_j$ vertex. For any line l_i , let δ^i be the alternative sum of saddle vanishing cycles in the order which l_i intersects others. It turns out that the intersection of δ^i 's with center vanishing cycles is zero. Since it is invariant under monodromy h_0 around 0, its intersection with all $h^k(\delta)$, δ center vanishing cycle, is also zero. The conclusion is that the intersection of δ^i with all the elements in $H_1(L_b, \mathbb{Z})$ is zero and hence it is in the kernel of $H_1(L_b, \mathbb{Q}) \rightarrow H_1(\overline{L_b}, \mathbb{Q})$. After taking a proper sign for δ^i , we know that $\sum_{i=1}^{d+1} \delta^i = 0$. Now, it is an elementary problem to check that δ^i , $i = 1, 2, \dots, d$ and $\frac{d(d-1)}{2}$ elements (14) attached to each polygon are linearly independent and form a basis for the vector space generated by saddle vanishing cycles.

6 Proof of Theorem 1

Let $\mathbb{C}[x, y]_{\leq 1}$ be the complex vector space of bi-variate complex polynomials of degree at most one. The set $\mathcal{L}(1^{d+1})$ of logarithmic foliations (2), is parameterized by the map

$$\tau : \mathbb{C}^{d+1} \times \mathbb{C}[x, y]_{\leq 1}^{d+1} \rightarrow \mathcal{F}(d) \quad (16)$$

$$\tau(\lambda_1, \dots, \lambda_{d+1}, l_1, \dots, l_{d+1}) = l_1 \cdots l_{d+1} \sum_{i=1}^{d+1} \lambda_i \frac{dl_i}{l_i} \quad (17)$$

and hence it is an irreducible algebraic set. The differential

$$D\tau(n_1, \dots, n_{d+1}, l_1, \dots, l_{d+1}) \quad (18)$$

of τ at the point

$$\omega_0 = l_1 l_2 \cdots l_{d+1} \left(\sum_{i=1}^{d+1} n_i \frac{dl_i}{l_i} \right) \in \mathcal{L}(1^{d+1}) \quad (19)$$

applied to the vector $(\lambda_1, \dots, \lambda_{d+1}, p_1, \dots, p_{d+1})$ is

$$l_1 l_2 \cdots l_{d+1} \left\{ \sum_{i=1}^{d+1} \lambda_i \frac{dl_i}{l_i} + \left(\sum_{i=1}^{d+1} \frac{p_i}{l_i} \right) \left(\sum_{i=1}^{d+1} n_i \frac{dl_i}{l_i} \right) + d \left(\sum_{i=1}^{d+1} n_i \frac{p_i}{l_i} \right) \right\}. \quad (20)$$

It is easy to check that if a vector $(\lambda_1, \dots, \lambda_{d+1}, p_1, \dots, p_{d+1})$ is in the kernel of $D\tau$ then for every i the polynomial p_i is colinear to l_i . It follows from this that the dimension of the kernel is $d + 1$, respectively the dimension of the image (20) is $3(d + 1)$.

Let ω_0 be the polynomial one-form defined by (19) which we assume to be with real coefficients. We denote by $\delta_t \subset \{f = t\}$ a continuous family of real vanishing cycles around a real center of ω_0 , where the parameter t is the restriction of the first integral $f = \prod_{i=1}^{d+1} l_i^{n_i}$ to a cross-section to $\{f = t\}$. Let

$$\mathcal{F}_\epsilon : \omega_\epsilon := \omega_0 + \epsilon \omega_1 + \cdots \quad (21)$$

be an arbitrary degree d deformation of \mathcal{F}_0 . The return map associated to the family δ_t and the deformation \mathcal{F}_ϵ takes the form

$$t + \epsilon \int_{\delta_t} \tilde{\omega}_1 + O(\epsilon), \quad \tilde{\omega}_1 = \frac{\omega_1}{l_1 \cdots l_{d+1}}$$

Proposition 3. *The Melnikov integral $M_1(t) := \int_{\delta_t} \frac{\omega_1}{l_1 \cdots l_{d+1}}$ vanishes identically if and only if ω_1 is of the form (20).*

Proof. It is trivially seen that if ω_1 belongs to the image of $D\tau$ (20), then $\int_{\delta_t} \tilde{\omega}_1$ vanishes identically. We shall prove now the converse. If $\int_{\delta_t} \tilde{\omega}_1$ vanishes then it vanishes on every other family of cycles which are in the orbit of δ_t , and hence on the vector space O_{δ_t} spanned by the orbit. By Theorem 5 the dual of O_δ in $H_{dR}^1(L_t)$ has a basis given by $\frac{dl_i}{l_i}$, $i = 1, 2, \dots, d$. Therefore, there are unique constants $\lambda_i, i = 1, 2, \dots, d$ (depending on t) such that the cohomology class of

$$\tilde{\omega}_1 - \sum_{i=1}^d \lambda_i \frac{dl_i}{l_i} \quad (22)$$

in $H_{DR}^1(L_t)$ is zero. Using (15), we can see that λ_i is a linear combination of integrals $\frac{1}{2\pi i} \int_{\delta_{i,0}} \tilde{\omega}_1$, $i = 1, 2, \dots, d$ with rational, and hence constant, coefficients. We assume that $n_1, n_2, \dots, n_d > 1$. Multiplying $\int_{\delta_{i,0}} \tilde{\omega}_1$ with $t^{\frac{1}{n_i}}$ and $t^{-\frac{1}{n_i}}$ we can see that it grows like $t^{-\frac{1}{n_i}}$ as $t \rightarrow 0$ and like $t^{\frac{1}{n_i}}$ as $t^{-1} \rightarrow 0$. Since λ_i 's are uni-valued, it follows that they are meromorphic function in t with pole order < 1 at $t = 0, \infty$ and hence they are constant.

With the same arguments as in [Mov04a, Theorem 4.1] we deduce that if a one-form on L_t is co-homologically zero, then it is relatively exact, that is to say

$$\tilde{\omega}_1 - \sum_{i=1}^{d+1} \lambda_i \frac{dl_i}{l_i} = d\tilde{P} + \tilde{Q}\tilde{\omega}_0, \quad (23)$$

where \tilde{P} and \tilde{Q} have only poles of order ≤ 1 along the lines $l_i = 0$ and the line at infinity and $\tilde{\omega}_0 = \frac{\omega_0}{l_1 l_2 \cdots l_{d+1}}$. The crucial observation is that the one-form (23) is logarithmic along the line at infinity (after compactifying \mathbb{C}^2 to \mathbb{P}^2). Namely, ω_1 is of (affine) degree $\leq d$ which implies $\tilde{\omega}_1$ and $d\tilde{\omega}_1$ have a pole of order at most one along the infinite line of \mathbb{P}^2 . This implies that $d\tilde{Q} \wedge \tilde{\omega}_0$ has pole order ≤ 1 at infinity, and hence \tilde{Q} is holomorphic at infinity, and by the equality (23), \tilde{P} is also holomorphic at infinity. The conclusion is that we can write

$$\tilde{P} = \frac{P}{l_1 l_2 \cdots l_{d+1}}, \quad \tilde{Q} := \frac{Q}{l_1 l_2 \cdots l_{f+1}},$$

where $P, Q \in \mathbb{C}[x, y]$ are polynomials of degree $\leq d + 1$. Multiplying the equality (23) with $l_1 l_2 \cdots l_{d+1}$ and considering it modulo $l_i = 0$, we get $l_i | P - Q n_i$. If $n_i \neq n_j$ this implies that P and Q vanishes in the intersection points $l_i \cap l_j$. Knowing the degree of P and Q , we conclude that both P and Q are of the form $l_1 l_2 \cdots l_{d+1} (\sum_{i=1}^{d+1} a_i \frac{p_i}{l_i})$, where $\deg(p_i) \leq 1$ and $a_i \in \mathbb{C}$ depend on P, Q . Substituting this ansatz for P and Q in (23) we get the desired form of ω_1 in (20). \square

The geometric meaning of the above Proposition is that the tangent space of $\mathcal{L}(1^{d+1})$ and $\mathcal{M}(d)$ at the point \mathcal{F}_0 are the same, and that they are given by (20). By dimension count the dimension of this tangent space equals the dimension of $\mathcal{L}(1^{d+1})$. Therefore \mathcal{F}_0 is a smooth point on $\mathcal{M}(d)$ and moreover $\mathcal{L}(1^{d+1})$ is an irreducible component of the center set $\mathcal{M}(d)$. Note that there are no other components of $\mathcal{M}(d)$ containing \mathcal{F}_0 and tangent to $\mathcal{L}(1^{d+1})$, otherwise the Zariski tangent space would be bigger.

Remark 5. Assuming Corollary 3 we may complete the proof of Theorem 1 by general arguments which we sketch in what follows, see [FGX20]. Let $\mathcal{B} = (b_1, b_2, \dots, b_N)$ be generators of the Bautin ideal near the point $\mathcal{F}_0 \in \mathcal{F}(d)$ defined in Theorem 1. Here \mathcal{B} is seen as an ideal of the local ring of convergent power series. Following [FGX20, section 3.2] we divide the return map $P(t)$ associated to the family of vanishing cycles δ_t of \mathcal{F}_0 under a general (multi-parameter) perturbation in $\mathcal{F}(d)$ of the form $\omega_0 + \omega_1$ to obtain

$$P(t) - t = \sum b_i(\Phi_i(t) + \dots).$$

Here the dots replace some convergent power series in the parameters and t , which vanish at \mathcal{F}_0 . Every Melnikov function (of arbitrary order) is an appropriate linear combination of $\Phi_i(t)$, although the converse is not necessarily true. In particular we may suppose that the vector space of first order (or linear) Melnikov function has a basis formed by $\Phi_i(t), i = 1, \dots, k$. The linear independence of the first order Melnikov function is equivalent then to the linear independence of the differentials $Db_i, i = 1, \dots, k$ computed at \mathcal{F}_0 , see [FGX20, Corollary 2]. Thus, performing a local bi-analytic change of variables in the parameter space, we may assume that b_1, b_2, \dots, b_k are new parameters defining a plane which contains $\mathcal{L}(1^{d+1})$ near \mathcal{F}_0 . By comparison of dimensions we conclude that $\mathcal{L}(1^{d+1})$ coincides to the plane $\{b_1 = \dots = b_k = 0\}$ near \mathcal{F}_0 . As for the other generators $b_i, i > k$ they already belong to the ideal (b_1, \dots, b_k) , because they vanish identically along $\mathcal{L}(1^{d+1})$. Thus $\mathcal{M}(d)$ coincides near \mathcal{F}_0 with $\mathcal{L}(1^{d+1})$.

Remark 6. Our hypothesis in Theorem 1 suggests to study the subset of $(\mathbb{Q}^+)^d$ given by points $(\frac{n_1}{n_{d+1}}, \frac{n_2}{n_{d+1}}, \dots, \frac{n_d}{n_{d+1}})$, where n_i 's are pairwise relatively prime positive integers. For instance, it is not clear whether this set is dense in $(\mathbb{Q}^+)^d$ or not. Note that its projection in each coordinate is dense and the fibers of this projection are finite sets.

7 Quadratic foliations

For quadratic foliations, that is the case $d = 2$, the classification of components of $\mathcal{M}(2)$ follows from the computations of H. Dulac in [Dul23], see [FGX20, Appendix A], [Lin14, Theorem 1.1] and [IY08, Section 13.9]. The algebraic set $\mathcal{M}(2)$ has four components

1. $\mathcal{L}(1^3)$,
2. the set $\mathcal{L}(1, 2)$ of logarithmic foliations of the form

$$f_1 f_2 \left(\lambda_1 \frac{df_1}{f_1} + \lambda_2 \frac{df_2}{f_2} \right), \quad \deg(f_1) = 1, \deg(f_2) = 2, \lambda_1, \lambda_2 \in \mathbb{C} - \{0\}$$

3. the set $\mathcal{L}(3)$ of Hamiltonian foliations $\mathcal{F}(df)$, $\deg(f) = 3$
4. an exceptional component obtained by the action of the affine group $\text{Aff}(\mathbb{C}^2)$ on the foliation with the first integral $\frac{(x^2+2y+\alpha)^3}{(x^3+3xy+1)^3}$, $\alpha \in \mathbb{P}^1$

see [Gav20, Proposition 4.7]. Using this, one may prove the following: the only singular points of $\mathcal{M}(2)$ in $\mathcal{L}(1^3)$ are $\mathcal{L}(1^3) \cap \mathcal{L}(1, 2)$ and $\mathcal{L}(1^3) \cap \mathcal{L}(3)$, that is,

$$\text{Sing } \mathcal{M}(2) \cap \mathcal{L}(1^3) = (\mathcal{L}(1, 2) \cap \mathcal{L}(1^3)) \cup (\mathcal{L}(3) \cap \mathcal{L}(1^3)). \quad (24)$$

A finer result is the classification of the components of the Bautin scheme which is done by many authors and for many subspaces of $\mathcal{F}(2)$, see [Zol94] and references therein for an overview of this. Following [IY08] we consider the following normal form of quadratic systems with a Morse center at the origin

$$\begin{cases} \dot{x} &= -ix + Ax^2 + Bxy + Cy^2, \\ \dot{y} &= iy + C'y^2 + B'xy + A'x^2, \end{cases} \quad A, B, C, A', B', C' \in \mathbb{C}. \quad (25)$$

The Bautin ideal of the above system has been extensively studied in the literature, see [Zol94, IY08]. The Bautin ideal associated is generated by g_2, g_3, g_4 , where

$$\begin{aligned} g_2 &:= AB - A'B', \\ g_3 &:= (2A + B')(A - 2B')CB' - (2A' + B)(A' - 2B)C'B, \\ g_4 &:= (BB' - CC')((2A + B')B'^2C - (2A' + B)B^2C'). \end{aligned}$$

The computation of the primary decomposition of this ideal implies four reduced components which are explicitly written in [Zol94, Theorem 1]:

1. Lotdka-Volterra component $\mathcal{L}(1^3)$: $B = B' = 0$,
2. Hamiltonian $\mathcal{L}(3)$: $2A + B' = 2A' + B = 0$,
3. Reversible $\mathcal{L}(1, 2)$: $AB - A'B' = B'^3C - B^3C' = AB'^2C - A'B^2C' = A^2B'C - A'^2BC' = A^3C - A'^3C'$,
4. Exceptional: $A - 2B' = A' - 2B = CC' - BB' = 0$.

Note that the ideal of the reversible component is radical and is written in a Groebner basis (in contrast to [IY08, section 13] where the corresponding "symmetric" component turns out to be reducible). We can also compute the ideal of its singular set. It is clear that the Hamiltonian and Lotka-Volterra components are smooth and the exceptional component has an isolated singularity at $A = \dots = C' = 0$. The reversible component has more interesting singularities:

$$\text{Sing}(\mathcal{L}(1, 2)) = \{B = B' = A = A' = 0\} = \mathcal{L}(3) \cap \mathcal{L}(1^3).$$

The foliation \mathcal{F} with $A = B = A' = B' = 0, C = C' = 1$ has the first integral $f := (\frac{1}{2} - x)(y^2 - \frac{1}{3}(x+1)^2)$, see [Ili98, page 159]. For the computer codes used in this computation see the latex file of the present article in arxiv. It must be noted that $\mathcal{L}(1^3)$ itself is not smooth, for instance, it has a nodal singularity at the foliation with the first integral $\frac{x^2+y^2}{2y-1}$ which has been studied in [FG20].

Proposition 4. *The singular set of $\mathcal{L}(1^3)$ is the orbit of the affine group $\text{Aff}(\mathbb{C}^2)$ on the foliation with the first integral $\frac{(x+1)(y-1)}{xy}$.*

For an illustration of the above phenomenon see [FG20, Figure 2].

Proof. We know that the kernel of the derivation of the parametrization τ in (16) has constant dimension. This implies that all singularities of $\mathcal{L}(1^3)$ are due to the noninjectivity of τ . For a foliation $\mathcal{F} = \mathcal{F}(\omega) \in \text{Sing}(\mathcal{L}(1^3))$ we get $f = l_1l_2l_3$ and $g = \tilde{l}_1\tilde{l}_2\tilde{l}_3$, where $\{l_i = 0\}$'s (resp. $\{\tilde{l}_i = 0\}$'s) are distinct lines, such that $d(\frac{\omega}{f}) = d(\frac{\omega}{g}) = 0$, and hence, $F := \frac{f}{g}$ is a first integral of \mathcal{F} . It turns out that one of the lines $\{l_i = 0\}$'s must be equal to one of $\{\tilde{l}_i = 0\}$'s, and since \mathcal{F} is of degree 2, F is the quotient of two lines by another two lines. Further, $F - 1$ is the quotient of a line with another two lines. We conclude that up to the action of $\text{Aff}(\mathbb{C}^2)$, the foliation \mathcal{F} has the first integral $F := \frac{(x+1)(y-1)}{xy}$. Note that two branches of $\mathcal{L}(1^3)$ near $\mathcal{F}(\omega)$ correspond to $F - 1 = \frac{-x+y-1}{xy}$ and $\frac{F-1}{F} = \frac{-x+y-1}{(x+1)(y-1)}$. \square

References

- [A’C75] Norbert A’Campo. Le groupe de monodromie du déploiement des singularités isolées de courbes planes. I. *Math. Ann.*, 213:1–32, 1975.
- [BG11] Marcin Bobieński and Lubomir Gavrilov. On the reduction of the degree of linear differential operators. *Nonlinearity*, 24(2):373–388, 2011.
- [Bot07] Hans-Christian Graf von Bothmer. Experimental results for the Poincaré center problem. *NoDEA, Nonlinear Differ. Equ. Appl.*, 14(5-6):671–698, 2007.
- [BK10] Hans-Christian Graf von Bothmer and Jakob Kröker. Focal values of plane cubic centers. *Qual. Theory Dyn. Syst.*, 9(1-2):319–324, 2010.
- [Cle69] C. H. Clemens. Picard-Lefschetz theorem for families of nonsingular algebraic varieties acquiring ordinary singularities. *Trans. Am. Math. Soc.*, 136:93–108, 1969.
- [Dul23] H. Dulac. Sur les cycles limites. *Bull. Soc. Math. France*, 51:45–188, 1923.
- [FG20] Jean-Pierre Françoise and Lubomir Gavrilov. Perturbation theory of the quadratic Lotka-Volterra double center. *arXiv e-prints*, page arXiv:2011.08316, November 2020.
- [FGX20] Jean-Pierre Françoise, Lubomir Gavrilov, and Dongmei Xiao. Hilbert’s 16th problem on a period annulus and Nash space of arcs. *Math. Proc. Cambridge Philos. Soc.*, 169(2):377–409, 2020.
- [Gav20] Lubomir Gavrilov. On the center-focus problem for the equation $\frac{dy}{dx} + \sum_{i=1}^n a_i(x)y^i = 0$, $0 \leq x \leq 1$ where a_i are polynomials. *Ann. Henri Lebesgue*, 3:615–648, 2020.
- [GZ74] S. M. Guseĭn-Zade. Intersection matrices for certain singularities of functions of two variables. *Funkcional. Anal. i Priložen.*, 8(1):11–15, 1974.
- [Ili98] Iliya D. Iliev. Perturbations of quadratic centers. *Bull. Sci. Math.*, 122(2):107–161, 1998.
- [Ily69] Yu. Ilyashenko. The appearance of limit cycles under a perturbation of the equation $dw/dz = -R_z/R_w$, where $R(z, w)$ is a polynomial. *Mat. Sb. (N.S.)*, 78 (120):360–373, 1969.

- [IY08] Y. Ilyashenko and S. Yakovenko. *Lectures on analytic differential equations*, volume 86 of *Graduate Studies in Mathematics*. American Mathematical Society, Providence, RI, 2008.
- [Lam81] Klaus Lamotke. The topology of complex projective varieties after S. Lefschetz. *Topology*, 20(1):15–51, 1981.
- [Lin14] A. Lins Neto. Foliations with a Morse center. *J. Singul.*, 9:82–100, 2014.
- [Mov04a] H. Movasati. Abelian integrals in holomorphic foliations. *Rev. Mat. Iberoamericana*, 20(1):183–204, 2004.
- [Mov04b] H. Movasati. Center conditions: rigidity of logarithmic differential equations. *J. Differential Equations*, 197(1):197–217, 2004.
- [Mov21] H. Movasati. *A course in Hodge theory. With emphasis on multiple integrals*. Somerville, MA: International Press, 2021.
- [vGH86] Stephan A. van Gils and Emil Horozov. Uniqueness of limit cycles in planar vector fields which leave the axes invariant. In *Multiparameter bifurcation theory (Arcata, Calif., 1985)*, volume 56 of *Contemp. Math.*, pages 117–129. Amer. Math. Soc., Providence, RI, 1986.
- [Zar19] Yadollah Zare. Center conditions: pull-back of differential equations. *Trans. Am. Math. Soc.*, 372(5):3167–3189, 2019.
- [Zol94] Henryk Zoladek. Quadratic systems with center and their perturbations. *J. Differ. Equations*, 109(2):223–273, 1994.
- [Zol94b] Henryk Żoładek. The classification of reversible cubic systems with center. *Topol. Methods Nonlinear Anal.*, 4(1):79–136, 1994.
- [Zol94a] Henryk Żoładek. Remarks on: “The classification of reversible cubic systems with center” [Topol. Methods Nonlinear Anal. 4 (1994), no. 1, 79–136; MR1321810 (96m:34057)]. *Topol. Methods Nonlinear Anal.*, 8(2):335–342 (1997), 1996.