

*Dedicated to J. B. Goodenough
in honour of his 100th birthday*

Orbital physics: glorious past, bright future

D. I. Khomskii

II. Physikalisches Institut, Universität zu Köln,
Zülpicher Str. 77,
50937 Köln, Germany

Abstract

Transition metal (TM) compounds present a very big class of materials with quite diverse properties. There are among them insulators, metals, systems with insulator–metal transitions; most magnetic systems are TM compounds; there are among them also (high- T_c) superconductors. Their very rich properties are largely determined by the strong interplay of different degrees of freedom: charge; spin; orbital; lattice. Orbital effects play a very important role in these systems — and not only in them! The study of this field, initiated by Goodenough almost 70 years ago, turned out to be very fruitful and produced a lot of important results. In this short review I first discuss the basics of orbital physics, summarize the main achievements in this big field, in which Goodenough played a pivotal role and which are nowadays widely used to explain many properties of TM compounds. In the main part of the text I discuss novel developments and perspectives in orbital physics, which is still a very active field of research, constantly producing new surprises.

1 Introduction

Magnetism is one of the first physical phenomena known to mankind, from ancient Greece which gave us the very word “magnetism” — although it was known (and used) even earlier in ancient China. But it was only in the XX century, after the emergence of quantum mechanics, that the real microscopic nature of magnetism was understood.

The present understanding of magnetism in most cases is that it is due to, predominantly, spins of electrons, and to have strong magnetic response one needs electrons localised at respective ions. This is now the subject of a very rich field of correlated electrons, initiated at the end of the 30s by Peierls [1] (see the detailed description of this history in Appendix A.1 in [2]), and developed later by Landau, Mott, Anderson and Hubbard [3, 4, 5, 6]. There exist two types of states of electrons in solids: itinerant electrons, well described by the band theory, and localised electrons — localised due to sufficiently strong electron–electron interactions. In the simplest form the situation can be described by the Hubbard model — which looks deceptively simple but which hides a lot of complications and surprises. In the standard form it treats electrons in a lattice made from ions with nondegenerate levels, with, usually, the nearest-neighbour hoppings of electrons and with, in the simplest form, the on-site Coulomb repulsion

$$H = -t \sum_{\langle ij \rangle, \sigma} c_{i\sigma}^\dagger c_{j\sigma}^\dagger + U \sum_i n_{i\uparrow} n_{i\downarrow}, \quad n_{i\sigma} = c_{i\sigma}^\dagger c_{i\sigma}. \quad (1)$$

For one electron per site without the Coulomb (Hubbard) interaction, $U = 0$ or very small, the material in the band theory would contain a half-filled band and would be a metal (we ignore here the possibility of a Peierls distortion which can still make such system insulating). However for strong enough interaction $U > W = 2zt$ (where W is the bandwidths and z is the number of nearest neighbours) the electrons would be localised one per site, and the system would be insulating [1] — what we now call Mott insulators. Such localised electrons would also have localized spins, which would have a certain exchange interaction, and at low enough temperatures there would appear a long-range magnetic ordering. In simplest cases the exchange (or superexchange) interaction of such localised electrons is obtained in perturbation theory in $t/U \ll 1$, and it leads to the antiferromagnetic Heisenberg exchange

$$H = J \sum_{\langle ij \rangle} \mathbf{S}_i \cdot \mathbf{S}_j, \quad J = 2t^2/U. \quad (2)$$

Why this exchange is antiferromagnetic is illustrated in Fig. 1: in the second order in perturbation theory (in t/U) one always gains energy, but for electrons with parallel spins this process of virtual hoppings is forbidden by the Pauli principle and we gain no such energy. But for antiparallel spins this process is allowed, and the corresponding energy gain stabilises such antiferromagnetic spin ordering.

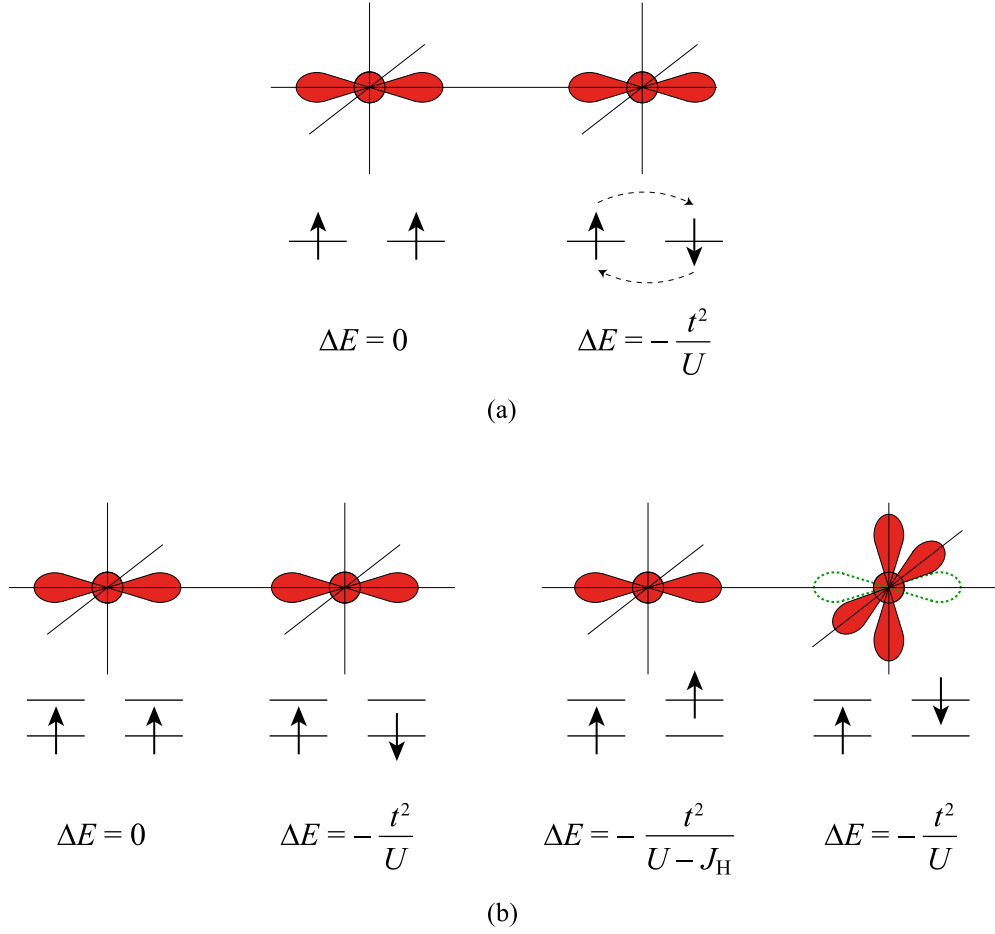

Figure 1: Orbital-dependent exchange interaction. (a) Nondegenerate orbitals. Virtual intersite hopping is allowed for antiparallel spins, right, giving the energy gain $\Delta E = -2t^2/U$ (in the second order in t/U), but is forbidden by the Pauli principle for parallel spins, left. As a result we get the antiferromagnetic exchange. (b) Exchange for two orbitals per site, with only diagonal hopping t_{11} , t_{22} , with hopping between different orbital absent, $t_{12} = 0$. The energy gain due to virtual electron hopping is shown for each case. Due to Hund's rule interatomic interaction J_H the third configuration — different orbitals and same spins — is favoured due to virtual hopping of the electron from the left to the empty orbital on the right (shown by dashed line), giving ferromagnetic exchange $\sim (t^2/U)(J_H/U)$ (for $J_H < U$).

This simple treatment describes the basic physics of magnetism of system with localised electrons. But in real materials several very important extra factors have to be taken into account. And it is here that John Goodenough came to the forefront, and in effect he played a crucial role in making this simple model realistic, and laid the groundwork for the real explanation of multitude of very different magnetic phenomena. His contribution is “formalised” in the famous Goodenough–Kanamori, or, sometimes, Goodenough–Kanamori–Anderson (GKA) rules. But John’s contribution is not only restricted to formulating these rules; he demonstrated the power of this approach on numerous examples of a multitude of real materials with very rich and often very puzzling properties.

Such extra factors which one needs to take into account are of course the specific crystal structure of a given material, but also its orbital structure: transition metal compounds with their d -electrons (but also rare earth and actinide systems), to which most of magnetic materials belong, have not electrons on nondegenerate levels but d -electrons with orbital moment $l = 2$. Orbital degrees of freedom can drastically alter the properties of a material, and their study presents a very interesting and rich field of orbital physics, the foundations of which were laid by Goodenough. This will be the topic of the present paper. In this text I will first give a very short summary of the basics and present well-established results, which is really the glorious page of the very successful period of the development of this field; but I will mostly discuss novel development and the perspectives of this field, which is still very much alive and which produces more and more surprises. Necessarily my discussion of this very big field will be rather qualitative; one can find more detailed presentation of these topics in the rather old, but still not obsolete review [7], and in more recent reviews [8, 9, 10, 11, 12]. And of course one should mention the famous book by Goodenough, *Magnetism and the chemical bond* [13] — a wonderful book more than 50 (almost 60!) years old, which still remains the bible in this field. For me personally it is still one of the main sources of information: although I myself already wrote a big book on transition metals [2], for me always the first thing to do when encountering a new problem is to look at what John wrote about it.

2 Orbital structure of transition metals and its role in exchange interaction

The first thing to consider when dealing with real transition metal (TM) compounds is to take into account more carefully the orbital structure of the respective TM ions. The 5-fold degenerate d -states are split in a crystal by the cubic crystal field (CF) into the lower three-fold degenerate t_{2g} and the higher-lying two-fold degenerate e_g levels (for simplicity we will mostly speak about the most typical local coordination, a TM ion in a ligand (e.g. oxygen) octahedra). This splitting, often denoted $10 Dq$, is typically ~ 1.5 – 2 eV for $3d$ ions, and ~ 2 – 3 eV for $4d$ and $5d$ ones. Further reduction of symmetry, for example by tetragonal or trigonal distortions, can lead to further splitting of these levels.

Crucial for the magnetic properties is first of all the type of this crystal field splitting, and the occupation of particular states by electrons. Here there are in general two situations possible: the electrons can occupy the respective levels, starting from those with the lower energy, following the (first) Hund’s rule, i.e. first forming the states with the maximum possible total spin — the so-called high-spin states. Alternatively one can occupy as much as possible the lowest CF states, e.g. the t_{2g} levels, at the expense of “sacrificing” the Hund’s rule, which gives the low-spin states. Thus for example ions with 5 d -electrons may fill all CF levels by electrons with parallel spins, giving the total spin $S = \frac{5}{2}$ (the high-spin state), or they can fill three lowest t_{2g} levels, giving the total spin $S = \frac{1}{2}$ (the low-spin state). The first situation is most common for $3d$ compounds — although here there are some exceptions as well. The second one, the predominant existence of the low-spin states, is very typical for $4d$ and $5d$ compounds.

Particular orbital occupation, together with the specific geometry, plays a crucial role in determining the sign and the strength of the exchange interaction. Corresponding rules were first formulated by Goodenough in the 50s [14, 15], and, together with the treatment by Kanamori [16, 17, 18], they provide the basis of the modern understanding of magnetic ordering in different TM compounds. Each time, when considering new material, the first thing to do is to try to understand possible types of exchange interactions using the Goodenough–Kanamori rules.

In the simplest form these rules are the following: if the effective electron hopping occurs between the half-filled orbitals, with one electron on each

(very often one speaks in this case simply about filled orbitals, as compared with the empty ones; we will also do it in what follows), then the situation is similar to that considered in the Introduction in Eqs. (1) and (2) and illustrated in Fig. 1(a): the virtual hopping is allowed only for antiparallel spins at the respective centres, and the resulting exchange would be antiferromagnetic and rather strong, $\sim t^2/U$. If however the orbital occupation is such that the occupied orbital at one centre has nonzero overlap and hopping only with the empty orbital at the neighbouring site, Fig. 1(b), then at first glance it seems that the hopping is allowed irrespective of the spin orientations. Indeed, as is shown in Fig. 1(b), for “diagonal” hopping, t_{11} and t_{22} nonzero but the nondiagonal hopping t_{12} zero, one can always move the electron from site i to site j and back, gaining some energy. But here the other factor not included in the simple nondegenerate model (1) comes into play: the Hund’s rule exchange interaction, which can be written as

$$H_{\text{Hund}} = -J_{\text{H}} \left(\frac{3}{4} + S_{i,\alpha} S_{i,\beta} \right), \quad (3)$$

where i is the site index, and α, β are the indices of orbitals ($\alpha \neq \beta$). In this case the energy of the intermediate state, when we put two electrons e.g. on site i with parallel spins, $S_{i,\alpha} S_{i,\beta} = \frac{1}{4}$, is $U - J_{\text{H}}$, and that for antiparallel spins with $S_{i,\alpha} S_{i,\beta} = -\frac{3}{4}$ is just U .¹ Then the energy gain due to virtual hoppings from a site to an empty orbital of a neighbouring site is $-t^2/U$ for antiparallel spins, but it is larger, $-t^2/(U - J_{\text{H}})$, for parallel spins, see Fig. 1(b). We see that in this case (the hopping between occupied and empty orbitals at neighbouring centres) the ferromagnetic spin ordering would be favoured. The difference of these energies determines the strengths of the resulting ferromagnetic coupling $J \mathbf{S}_i \cdot \mathbf{S}_j$: for the usual situation with $J_{\text{H}} < U$ (typically for 3d elements $U \sim 4\text{--}5\text{ eV}$ and $J_{\text{H}} \sim 0.8\text{--}0.9\text{ eV}$) we will get, keeping the dominant terms, the resulting ferromagnetic exchange $J \sim -t^2 J_{\text{H}}/U^2$. That is, in this case we get ferromagnetic exchange, but it is weaker, reduced by the small factor J_{H}/U which for 3d ions is $\sim \frac{1}{5}$ (but which might be larger for several unpaired electrons in a shell).

These are, in a nutshell, the two main GK rules: for overlap and hopping between (half-)filled orbitals we get strong AF exchange, and for hopping

¹In a more detailed description one also has to take into account that the Hubbard interaction U is different for two electrons on the same orbital, $U_{11} = U$, and on different orbitals, $U_{12} = U' < U$. In the spherically-symmetric case $U_{12} = U' = U - 2J_{\text{H}}$ — the so-called Kanamori parametrization. For simplicity we ignore this factor in what follows; taking it into account usually leads just to some numerical corrections.

from occupied to empty orbital we get a weaker ferromagnetic exchange. We stress that these rules apply to insulators: in metallic systems there are other mechanisms in play which very often give a ferromagnetic exchange (e.g. due to the Stoner mechanism [19] or due to double exchange [20, 21]).

There are several extra complications in these rules. First of all most often in the real TM compounds such as oxides the effective hopping between the d -orbitals occurs not directly but via p -orbitals of the intermediate ligands, e.g. oxygens. Then, the situation strongly depends on the local geometry. In the simplest form presented above these rules work for the direct dd -hopping or, more often, for the neighbouring MO_6 octahedra with the common corner, one common oxygen, with the hopping via oxygens, in the case of 180° metal–oxygen–metal bonds, as e.g. in perovskites, Fig. 2(a). In this case one often describes the resulting situation as the rule “same orbitals — opposite spins; different orbitals — same spins”, or, expressed differently, “ferro orbitals — antiferro spins; antiferro orbitals — ferro spins”. But one has to be very careful in using this “rule of thumb”: it is indeed valid for the geometry with the 180° M –O– M bonds, but it is not valid at all for example for another rather common situation, with the octahedra with a common edge and with $\sim 90^\circ$ M –O– M bonds, Fig. 2(b). All these rules are described in details e.g. in [13, 2, 22].

Strangely enough, the third typical situation — with the neighbouring MO_6 octahedra with a common face, with three common ligands (oxygens), Fig. 2(c) — is very rarely considered in the literature; see for example the recent treatment of all three situations, with the emphasis on the common face geometry, in [23]. Interestingly enough, the situation with the common face usually resembles more that with the common corner than the one with the common edge.

All in all, using these general rules, largely formulated by Goodenough, extended to include the details of the crystal structure and local geometry, and including when necessary the p -orbitals of ligands in an apparent way (see Sec. 6 below), turns out to be extremely successful in explaining the main features of magnetic exchange, and consequently many other properties, of an enormous amount of magnetic materials. Indeed the development which followed the classical works of Goodenough, Kanamori and Anderson, not only laid the groundwork for the huge field of magnetic insulators, but for many years were very successfully applied, and will be certainly applied in future, to explain properties of many magnetic systems, both known and those yet to be discovered. Thus one can really say that this development is

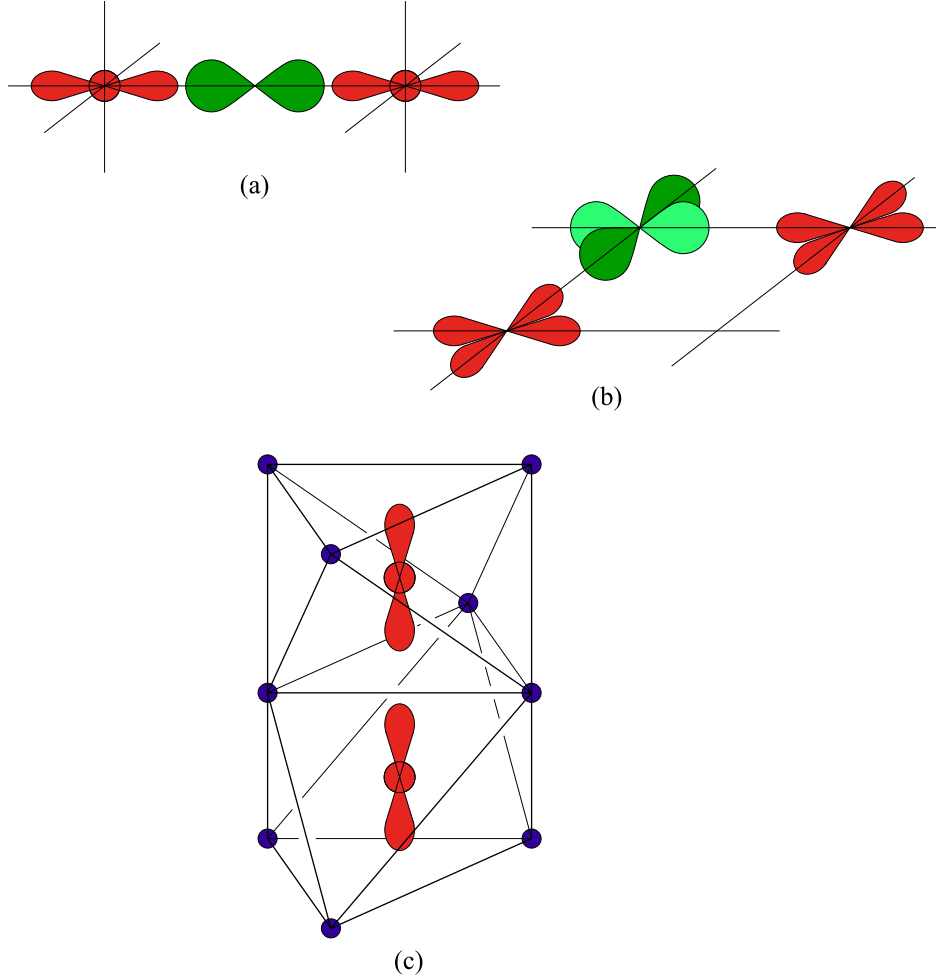

Figure 2: Superexchange interaction via p -orbitals of ligands (e.g. oxygen). Red are transition metal ions and orbitals, green are oxygens and their p -orbitals. (a) 180° metal–oxygen–metal (M – O – M) bonds, as e.g. in perovskites with corner-sharing MO_6 octahedra. In this case we get rather strong antiferromagnetic exchange. (b) 90° M – O – M bonds, as e.g. for edge-sharing MO_6 octahedra. In this case the d -orbitals of transition metals overlap with different p -orbitals of oxygen, and the Hund’s rule interaction on oxygen gives relatively weak ferromagnetic exchange. In this case, as well as in case (c), the direct dd -overlap and hopping is also possible for some orbitals, which can give antiferromagnetic exchange. (c) Face-sharing octahedra, with three common oxygens. In this case there exists superexchange via oxygen p -orbitals, but also often rather strong direct dd -overlap and hopping of a_{1g} -orbitals, shown in this figure. This direct dd -hopping can give antiferromagnetic exchange, or can lead to metal–metal bonding, see Sec. 4.

a glorious chapter in the history of magnetism.

3 Jahn–Teller effect and orbital ordering

A very special situation which is often encountered in the physics of TM compounds is that with orbital degeneracy. When taking the orbital structure into account and filling the respective energy levels by the required number of electrons, we can end up in a situation in which an electron occupies one of several degenerate orbitals, e.g. when we have one electron (or one hole) in doubly-degenerate levels. The first situation (one electron) is met e.g. for Mn^{3+} in a regular octahedron, with the configuration $t_{2g}^3 e_g^1$; the second one, with one hole, for Cu^{2+} ($t_{2g}^6 e_g^3$). It was shown by Jahn and Teller [24] that this situation is absolutely unstable: in this case the system spontaneously develops distortions reducing the symmetry and leading to a splitting of the degenerate levels. This is the famous Jahn–Teller (JT) effect.² (I formulate here the essence of the JT effect in a very simplified and not very rigorous form, but it is sufficient for our purposes; see a more detailed discussion in the very big literature on JT effect, e.g. in [25].) This distortion and the resulting splitting of degenerate orbitals occurs in concentrated systems as a real structural phase transition, which we can call the cooperative JT effect (for local JT centres the situation is much more complicated [25]). It leads to the occupation by electrons of particular orbitals, e.g. one of two possible e_g orbitals, i.e. one can say that in this case there occurs in a system an orbital ordering. Nowadays in the physical literature we indeed more often speak about orbital ordering (O.O.) than about the cooperative JT effect, although one should stress that these are just two different sides of the same phenomenon, the one (orbital ordering) cannot exist without the other (JT distortions).

The idea of the JT effect can be illustrated by the simple treatment, Fig. 3: The energy of two states, degenerate for the undistorted system, as a function of distortion δ has the form

$$E = -g\delta + \frac{1}{2}B\delta^2. \quad (4)$$

Here the first term is the splitting of degenerate electronic levels by the distortion (reminiscent of the Zeeman splitting in a magnetic field), and the

²Interestingly enough, as is described by Teller himself, the idea of this effect was suggested to him by Landau, see e.g. Appendix A.2 in [2].

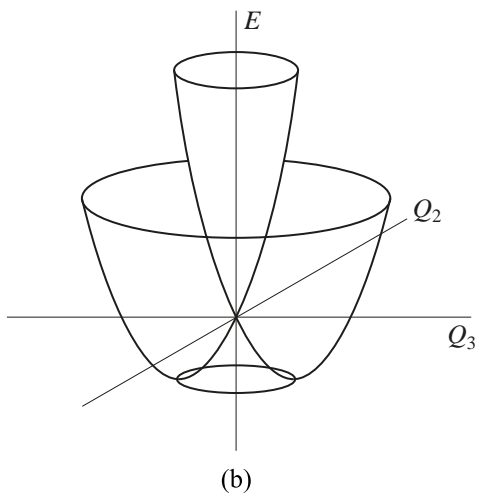
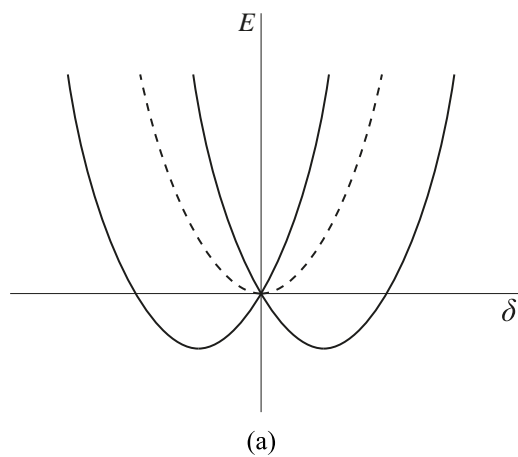

Figure 3: Jahn-Teller effect for double orbital degeneracy, e.g. for e_g -electrons. (a) Schematic explanation of the Jahn-Teller effect. (b) The form of the energy surface (“Mexican hat”) for double-degenerate e_g -electrons interacting with E_g distortions (tetragonal Q_3 mode, orthorhombic Q_2 mode). Note the continuous degeneracy of the lowest energy states (the trough of the Mexican hat) and the presence of the conical intersection, both leading to important quantum effects.

second term is the elastic energy of the lattice. One immediately sees that the symmetric, undistorted situation with degenerate levels is always unstable, it is never the minimum of the energy. Minimization of this expression gives for the equilibrium distortion the value $\delta_0 = -g^2/B$, and the energy at the minimum is $E_{\text{JT}} = -g^2/2B$. In concentrated systems the distortions at different centres interact with each other (e.g. by elastic forces), which leads to the cooperative effect: distortions of different centres occurs simultaneously, leading to a real phase transition — which is simultaneously a structural transition and an orbital ordering. The mechanism of this phenomenon described above is the JT electron–lattice interaction.

In real situations usually the degenerate electron states can be split not by one but by several types of distortions. Thus the doubly-degenerate e_g levels can be split by tetragonal distortions Q_3 , but also by orthorhombic distortions Q_2 (distortions of the E_g symmetry). In effect the energy surface will be the one shown in Fig. 3(b) (it can be visualised as the surface obtained by the rotation of the energy of Fig. 3(a) about the vertical axis). This is the famous “Mexican hat” appearing in many field of physics, including the Higgs phenomenon. This situation leads to many nontrivial quantum effects connected with orbitals, see e.g. [12, 25] and Sec. 9 below.

Interestingly enough, there exists also another, purely electronic mechanism of such transition, closely related to the physics described in the previous section. Indeed, suppose we have two neighbouring centers with doubly-degenerate orbitals but with one electron per site. Suppose that the situation with orbital overlap and intersite electron hopping is like the one shown in Fig. 1(b): the electrons can hop from one orbital only to the same orbital at neighbouring sites, $t_{11} = t_{22} = t$, $t_{12} = 0$. In this case, instead of two possible situations shown in Fig. 1(a), leading to the antiferromagnetic superexchange, we have four possibilities: same orbital–same spin; same orbital–different spins; different orbitals–same spin; different orbitals–different spins, see Fig. 1(b). The arguments of the previous section show that the biggest energy gain due to virtual hopping of electrons between sites is reached in this case for the third case shown in Fig. 1(b), i.e. different orbitals–same spins. That is, the same superexchange process which for the nondegenerate case gave the effective antiferromagnetic exchange (2) and the corresponding spin ordering, in this case would give simultaneously both spin and orbital orderings, in this particular situation ferro spin and antiferro orbitals. This is just the “rule of thumb” mentioned in the previous section. (We stress once again that it is valid for this particular model, for certain particular

geometries, etc.) Mathematically one would then describe the coupled spin and orbital exchange by an effective Hamiltonian of the type

$$H = J_1 \sum_{ij} \mathbf{S}_i \cdot \mathbf{S}_j + J_2 \sum_{ij} \tau_i \tau_j + J_3 \sum_{ij} (\mathbf{S}_i \cdot \mathbf{S}_j) (\tau_i \tau_j), \quad (5)$$

where the τ operators (operators of the pseudospin $\frac{1}{2}$) describe doubly-degenerate orbitals (here spins enter as a scalar product $\mathbf{S}_i \cdot \mathbf{S}_j$, but the structure of orbital terms may be more complicated [7]).

This purely electronic, or exchange mechanism of coupled spin and orbital ordering was first proposed in [26, 27, 7], and it is sometimes called the Kugel–Khomskii model. It seems that it can indeed give purely orbital ordering without the lattice involved. But we stress that as soon as we include coupling with the lattice — which of course is always present in real situations — the lattice would immediately follow, so that the structural transitions of this type and orbital ordering always occurs simultaneously. The difference is just in the dominant mechanism of this transition: it may be predominantly of electron–lattice type or of the exchange type. In real systems both these mechanisms of course act simultaneously, so that it is difficult to tell which one is more important. One can get this information from *ab initio* calculations in which one can artificially “switch off” the JT interaction. The corresponding calculations show that typically these two mechanisms, electron–lattice (JT) and superexchange (Kugel–Khomskii) ones, are of comparable magnitude, the JT mechanism usually being somewhat stronger (with the ratio of about 60:40 or 70:30) [28, 29].

Orbital ordering has many manifestations, and it can lead to many quite nontrivial effects which are widely studied experimentally and theoretically, see e.g. [8, 12].

4 “Molecules in solids”: orbital Peierls transitions

A very special class of systems and effects, in which orbital degrees of freedom play an important role, is provided by materials with particular tightly-bound metal clusters. Such clusters may be dimers, trimers, or larger clusters. They may exist just because of a specific crystal structure of a material, or may be formed spontaneously below some phase transition. The study of

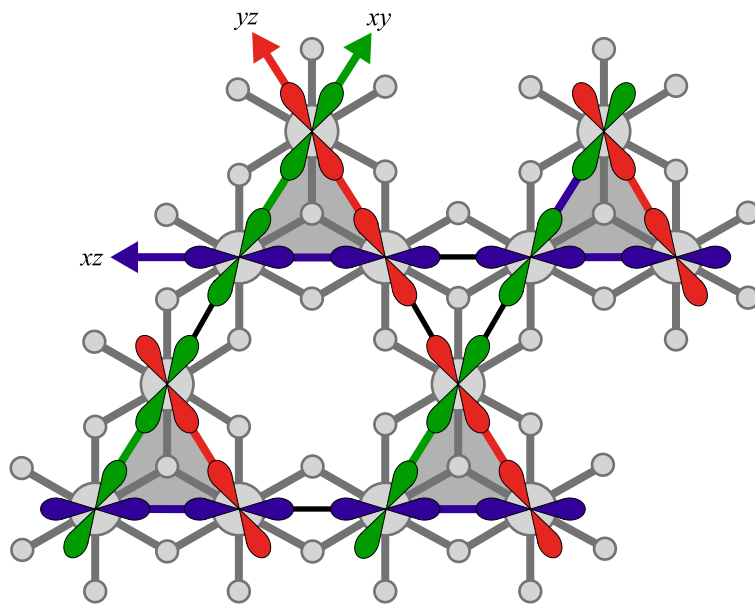

(a)

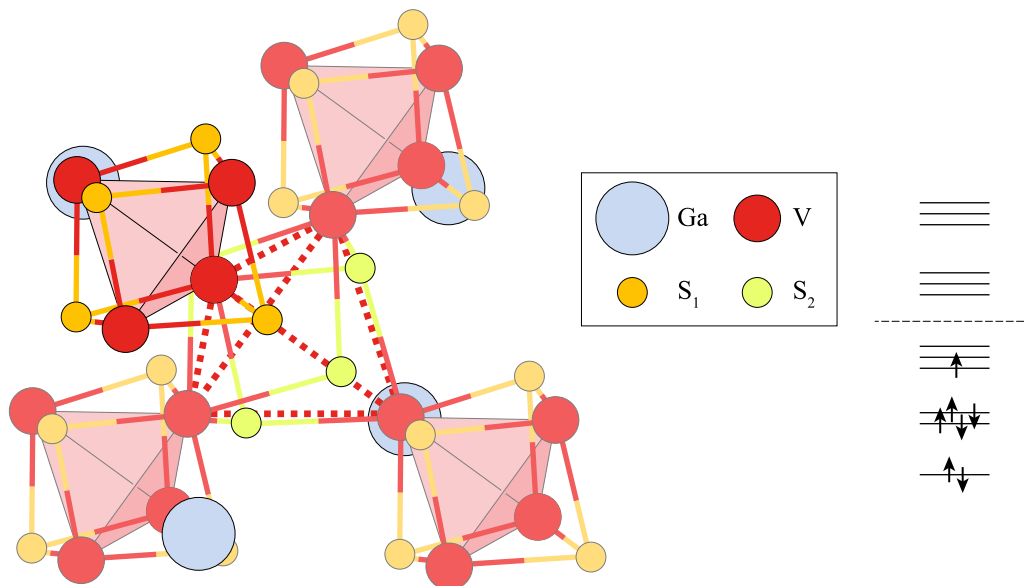

(b)

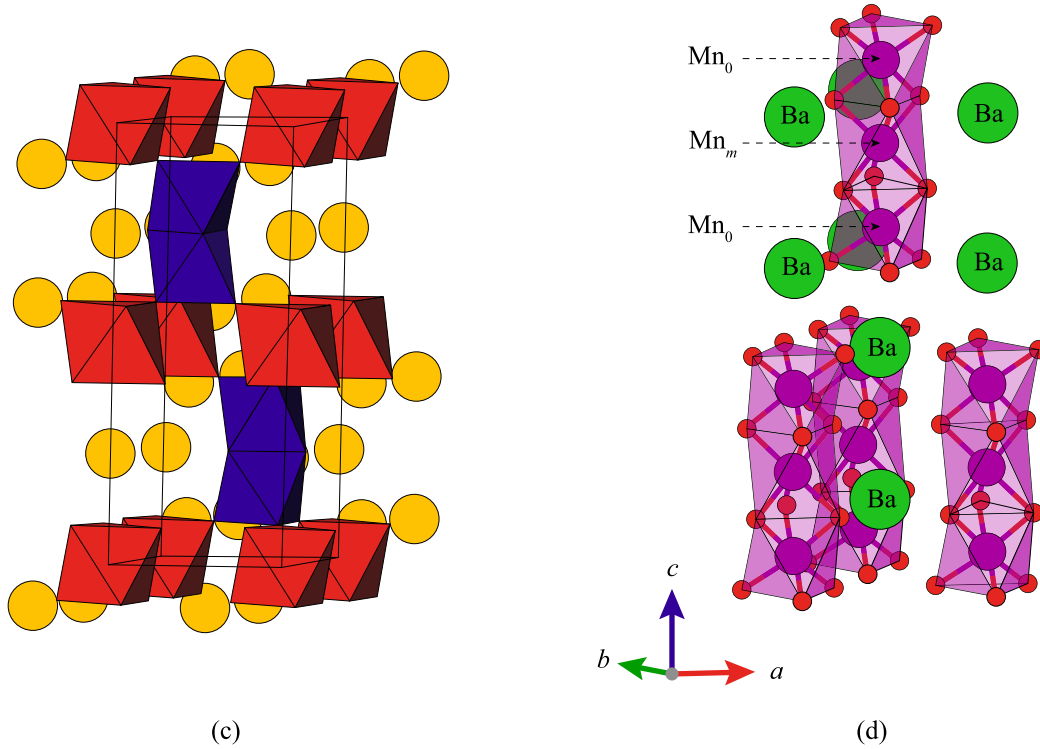

Figure 4: Several typical cases of systems with different types of crystal lattices and with molecular-type clusters of transition metals. (a) Breathing kagome lattice as e.g. in $\text{Zn}_2\text{Mo}_3\text{O}_8$ [30, 31, 32, 33] or $\text{Na}_2\text{Ti}_3\text{Cl}_8$ [34], with alternating small (shaded) and large triangles. (b) Breathing pyrochlore lattice, as in a lacunar spinel CaV_4S_8 . Pink are small tetrahedra. On the right is the energy diagram of this system. For 7 electrons per small V_4S_4 cluster there exists an orbital degeneracy (one electron in the higher-occupied triplet), and the resulting Jahn–Teller distortion makes GaV_4S_8 ferroelectric and multiferroic [35, 36]. (c) Materials of the class $\text{Ba}_3\text{MM}'_2\text{O}_9$, with $M = \text{Na}, \text{Ca}, \text{Ti}$, occupying single MO_6 octahedra (red) and with transition metal M' ($= \text{Ru}, \text{Ir}, \dots$) forming dimers (blue) with common edge of the $M'\text{O}_6$ octahedra, see e.g. [37, 38]. (d) Materials of the class $\text{Ba}_4\text{NbM}_3\text{O}_{12}$ ($M = \text{Mn}, \text{Ru}, \text{Rh}, \text{Ir}$), containing trimers made of face-sharing MO_6 octahedra [39, 40].

these materials became quite active very recently. There are many examples of such systems nowadays. These are for example the so-called “breathing” lattices — breathing kagome-like $(\text{Zn,Fe,Ni})_2\text{Mo}_3\text{O}_8$ [30, 31, 32, 33] or $\text{Na}_2\text{Ti}_3\text{Cl}_8$ [34], with alternating small and large triangles, Fig. 4(a); breathing pyrochlores such as GaV_4S_8 [35, 36] with ordered large and small tetrahedra, Fig. 4(b). There exist systems with well-separated dimers — $\text{Ba}_3M\text{Ru}_2\text{O}_9$ or $\text{Ba}_3M\text{Ir}_2\text{O}_9$ ($M = \text{Na, Ca, In, Ti, \dots}$) [37, 38], Fig. 4(c); trimers — $\text{Ba}_4\text{Nb}M_3\text{O}_{12}$ ($M = \text{Mn, Rh, Ir}$) [39, 40], Fig. 4(d); etc. In some cases tightly bound dimers are formed below phase transitions, as e.g. in VO_2 [41, 42], MgTi_2O_4 [43], CuIr_2S_4 [44], or trimers formed below T_c , e.g. in LiVO_2 [45, 46], LiVS_2 [47].

Detailed examination of most of such examples shows that the orbital structure of TM ions forming such clusters, “molecules in solids”, plays here a very important role. Typically such clusters are formed by metal–metal bonds, created by direct dd -overlap in materials with ML_6 octahedra with a common edge or common face, in which the TM ions are relatively close to each other. Often in such cases the metal–metal distance in clusters is indeed quite small — comparable or even shorter than in a respective metal. Thus the short Ru–Ru distance in Ru dimers in Li_2RuO_3 is 2.568 \AA [48], whereas such distance in Ru metal is 2.65 \AA ; and orbital ordering plays a very important role in this system [49]. The V–V distance in V trimers (triangles) in LiVO_2 is 2.56 \AA [45], and that in V metal it is 2.62 \AA (note that this short distance in LiVO_2 is also much smaller than the critical value separating localised and itinerant states, which, according to Goodenough [13], is 2.94 \AA). And in these situations the d -orbitals pointing to the neighbouring TM ions, cf. Fig. 2(a), can indeed form strong bonding (and antibonding) states, i.e. form molecular orbitals as in real molecules, and it is this bonding that stabilises the very cluster — Ru dimers in Li_2RuO_3 , Ir dimers in CuIr_2S_4 , V dimers in VO_2 and MgV_2O_4 , trimers in LiVO_2 or $\text{Zn}_2\text{Mo}_3\text{O}_8$, etc. Such “chemical” description is usually very illuminating and helps to understand the origin of such clusters and explain their electronic structure and properties. Thus for example the electronic structure of tightly-bound V tetrahedra in the lacunar spinel GaV_4S_8 (which can be written as $\text{Ga}_{1/2}(\text{Vacancy})_{1/2}\text{V}_2\text{S}_4$ — a spinel with ordered Ga ions and vacancies at A -sites) can be well explained by the picture of molecular orbitals, shown in Fig. 4(b): 7 electrons in this cluster fill these levels as shown in this figure, and this level filling explains why the net spin of such cluster is $S = \frac{1}{2}$. Moreover, we also see that the last, seventh electron here occupies one of the triply-degenerate levels,

which, by the physics explained in the previous section, can lead to the JT effect. And indeed there exists a structural transition in GaV_4S_8 , which lifts this degeneracy, and below this transition this material becomes ferroelectric, i.e. actually multiferroic [35, 36].

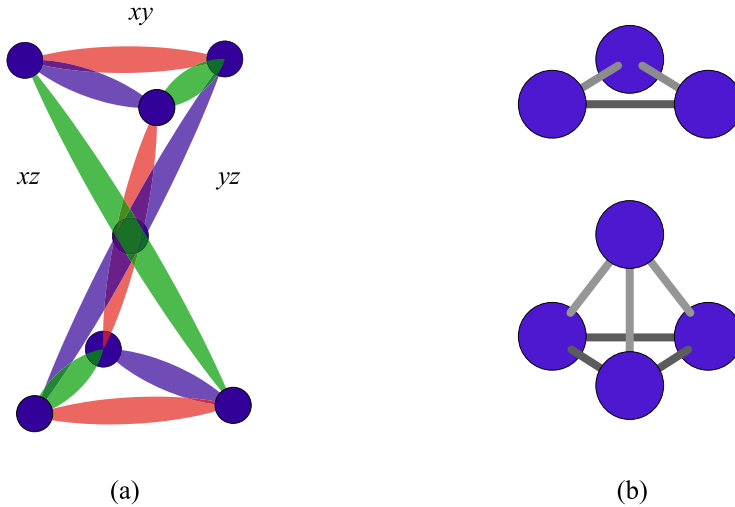

Figure 5: Superstructure in AlV_2O_4 below the structural transition. Initial interpretation was in terms of heptamers — clusters of 7 Vanadium ions, (a) [50]. Recent local measurements demonstrated that the middle V ion shifts towards one of the base triangles, forming V tetrahedra and triangles, (b) [51]. In both pictures the particular orbital occupation plays a crucial role.

The “molecular” picture can also explain the formation of a very exotic structure of the spinel AlV_2O_4 , with mixed valence of V. Initially it was claimed [50] that below the phase transition there are V heptamers formed — clusters made of 7 V ions, Fig. 5(a). But more detailed local measurements (using pair distribution function analysis) have shown that in fact there are not heptamers but rather trimers — V triangles and V_4 tetrahedra, Fig. 5(b) [51]. And this can be naturally explained in the picture in which V^{3+} ions with two d -electrons form triangles, with two valence bonds per each V, formed by using the corresponding V orbitals; and V_4 tetrahedra are made of $\text{V}^{2+}(d^3)$ ions, with each electron of V^{2+} forming its own chemical bond, three bonds per each V in a tetrahedra (V ions in AlV_2O_3 have mixed valence $\text{V}^{2.5+}$).

Interestingly enough, often one can also describe the origin of such clusters in a different picture — the picture of the orbital Peierls state [52, 53, 54].

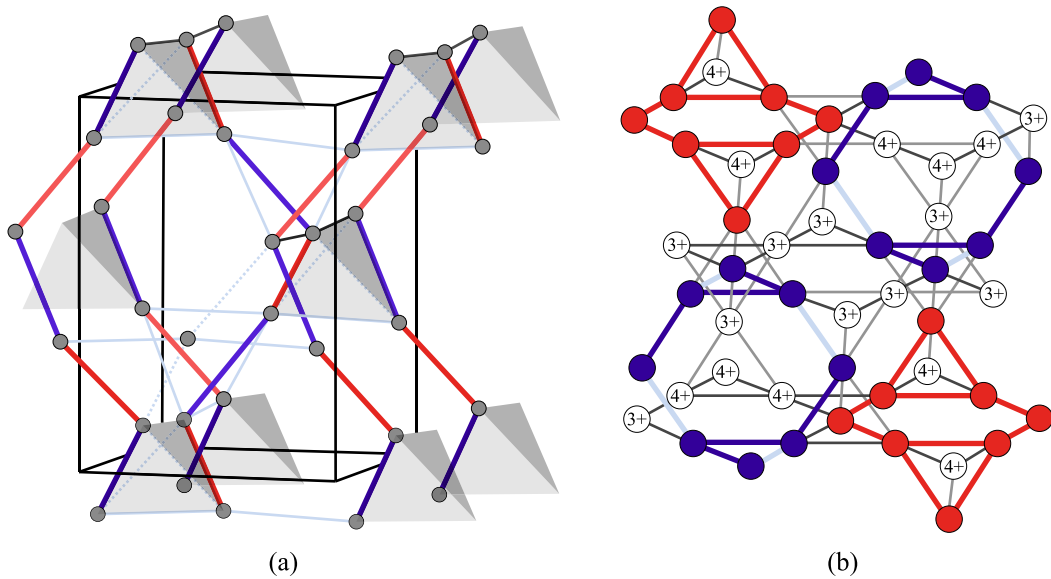

Figure 6: Crystal structure of MgTi₂O₄ (a) [43] and CuIr₂S₄ (b) [44] below phase transitions. Short Ti-Ti and Ir-Ir dimers are formed in the low-temperature phase, with the use of orbitals directed from one TM to the next.

Peierls instability exists in the original form in one-dimensional systems and leads to a distortion of a regular chain such that it opens a gap at the corresponding Fermi-surface. Thus e.g. for one electron per site the tight-binding band is half-filled, and dimerization of such chain would open a gap at the Fermi-surface (for 1d case — the Fermi-points). One can visualise this process as a first step to the formation of a molecular solid: e.g. if this chain with one electron per site is a chain of hydrogen atoms, the H₂ dimers formed at such Peierls dimerization are the first step in the formation of H₂ molecules. But similar distortion can also exist for other electron concentrations and other band fillings: for $\frac{1}{3}$ - or $\frac{2}{3}$ -filled bands one would get trimerization, and for $\frac{1}{4}$ -filled 1d bands one would get tetramerization. Apparently one can use this picture to rationalise the formation of many superstructures and molecular clusters in many systems. Thus, for example, due to specific geometry different *d*-orbitals form quasi-one-dimensional bands in spinels such as MgTi₂O₄, and $\frac{1}{4}$ -filling of these bands leads to tetramerization in the corresponding directions, which naturally explains [52] beautiful superstructures observed in MgTi₂O₄ [43] and in CuIr₂S₄ [44], Fig. 6. Similarly, one can explain the formation of trimers in breathing kagome systems

(Zn,Fe,Ni)₂Mo₃O₈ and Na₂Ti₃Cl₈ by dimerization in half-filled bands in 1d chains in kagome lattice, Fig. 4(a) (blue, red and green bands there) and the formation of trimers in LiVO₂ and LiVS₂ with triangular lattices — as a consequence of trimerization of $\frac{1}{3}$ -filled 1d bands [53, 54], Fig. 7. We see that the orbital degrees of freedom can be responsible for the formation of very exotic superstructures — “molecules in solids”, observed in quite a few TM compounds, which have many nontrivial and potentially useful properties (such as e.g. multiferroicity and the formation of skyrmions in lacunar spinels [35, 36]). This direction of research, which is rapidly developing right now, is thus one more example of the rich physics related to orbitals on TM compounds.

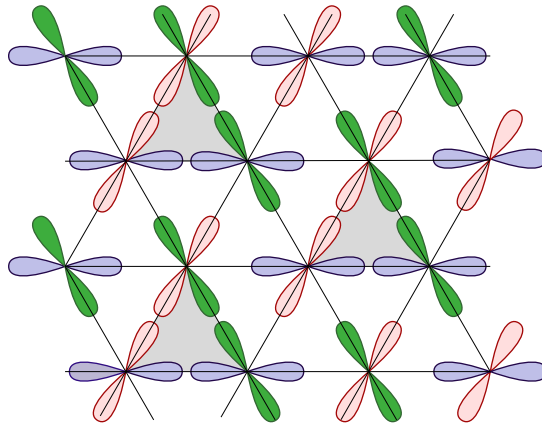

Figure 7: Trimerization in LiVO₂ [45]. It can be explained either in a “chemical” picture, as the formation of strong valence bonds in small V₃ triangles (shaded) [46], or as a result of Peierls trimerization in $\frac{1}{3}$ -filled one-dimensional bands [53, 54].

5 Orbital-selective effects

The directional character of orbitals, which was very important for the GKA rules considered in Sec. 2 and which gave directional “chemical bonds” in clusters described in Sec. 4, can also lead to other nontrivial effects. Thus, it may happen that the effective overlap and the corresponding hopping of electrons on different orbitals can be of very different magnitude: some orbitals can overlap very strongly, whereas other electrons on other orbitals can have very weak hopping to neighbouring sites. As explained in the In-

roduction, the very existence of localised vs itinerant states of electrons in solids crucially depends on the value of this hopping and of the respective bandwidth: for hopping $t > U$ we have itinerant electrons, i.e. the metallic state, whereas for $t < U$ we have localised electrons, Mott insulators. And in the situation in which electrons in different orbitals have very different hoppings t , it may so happen that for one of these orbitals we have $t > U$, but for the others $t < U$. In this case we can expect different states for these different electrons, i.e. the itinerant and localised electrons (all of these are d -electrons!) could coexist in one system. This was the idea of orbital-selective Mott transition, first put forth in [55] and later extensively discussed in the literature, see e.g. [56].

The same effect may also exist and may even have stronger manifestations in finite clusters. This was studied in [57], where it was shown that the same physics can lead to a strong suppression of magnetic moment of TM ions and can result in strong violation of the Hund’s rule. Indeed, if we consider a pair of sites, a dimer, such that one orbital at each site has strong overlap with the neighbour but the other(s) have much smaller overlap, or no overlap at all, then for example for two orbitals and two electrons per site we can have two possible situations, Fig. 8. If the on-site Hund’s interaction is large enough, these two electrons at each site would each form a spin-1 state, and intersite hybridization would not destroy such $S = 1$ states; there would be a Heitler–London-like state formed by these $S = 1$ states, Fig. 8(a). However if the intersite hopping t of one orbital, e.g. with the lobes directed towards the neighbouring site, is large enough, we can form a different state: the electrons on the “active” orbital would form a bonding state with energy $-t$, and two electrons would occupy this bonding state forming a singlet on it, Fig. 8(b). And the remaining one electron per site would remain localised, but the moment of the site would now be not $S = 1$ but strongly reduced, $S = \frac{1}{2}$. This could happen if the bonding energy $\sim t$ exceeds the Hund’s rule intraatomic exchange J_H : the strong bonding of one orbital leads to a violation of the first Hund’s rule. This is hardly possible for $3d$ systems but can easily happen in $4d$ and $5d$ materials, for which the electron hopping t increases but the Hund’s coupling J_H decreases. Such orbital-selective formation of bonding states (or molecular orbitals), with strong suppression of the moment per site, was observed in many materials containing dimers. Thus for example in $\text{Y}_5\text{Re}_2\text{O}_{12}$ [58], with three electron per site, the moment per site is not $\frac{3}{2}$ but only $\frac{1}{2}$: apparently two orbitals form a bonding singlet states, and only one “free” localised spin remains at

each site.

This effect may be even more pronounced for partial occupation of sites, in the situation which usually leads to double exchange (DE) and to net ferromagnetism. The simplest model of DE is the model of two sites with three electrons; actually it was on this model that Zener first proposed the idea of DE [20]. In this case, as is shown in Fig. 8(c), (d), there are also two options: for strong Hund's coupling (this is the assumption always made in the treatment of DE!) we indeed gain more energy if all spins are parallel; i.e. in this case we have a ferromagnetic state. But if for one orbital the intersite hopping is large enough, bigger than J_H , then we can also first form from these orbitals the bonding state and put on this state two electrons with opposite spins. In this case a dimer would have only a free spin $S = \frac{1}{2}$, Fig. 8(d), instead of $S = \frac{3}{2}$ as in the DE state of Fig. 8(c). That is, strong hopping on one orbital can effectively suppress the DE mechanism of ferromagnetism. Thus the orbital selectivity can have a profound influence on the magnetic state of a system, effectively suppressing the values of on-site magnetic moments and even long-range ferromagnetism.

One can also think of other possible effects connected with very different behaviour of electrons on different orbitals and with the directional character of orbitals. It is this directional dependence which gives rise in particular to orbital-dependent exchange as in the compass and Kitaev models, see Sec. 7 below; it is yet another manifestation of specific effects of orbitals in TM compounds.

6 Charge-transfer gap systems

As mentioned in Sec. 2, in most interesting magnetic insulators the TM ions are surrounded by a ligand cage, and the effective hopping of d -electrons, responsible, in particular, for the exchange interaction, occurs via the intermediate ligands, usually via their p -orbitals, e.g. the $2p$ -orbitals of oxygens, which we will mainly have in mind. In this case in principle one should include these p -electrons in the theoretical description, and not confine oneself to d -electrons, as was done in the Hubbard model (1). Instead one should, generally speaking, use the d - p model, which schematically looks like

$$H = \sum_{ij,\sigma} \epsilon_d d_{i\sigma}^\dagger d_{j\sigma} + \sum_{ij,\sigma} \epsilon_p p_{i\sigma}^\dagger p_{j\sigma} + \sum_{ij,\sigma} t_{pd} (p_{i\sigma}^\dagger d_{j\sigma} + \text{h.c.}) + U \sum_i n_{di\uparrow} n_{di\downarrow}. \quad (6)$$

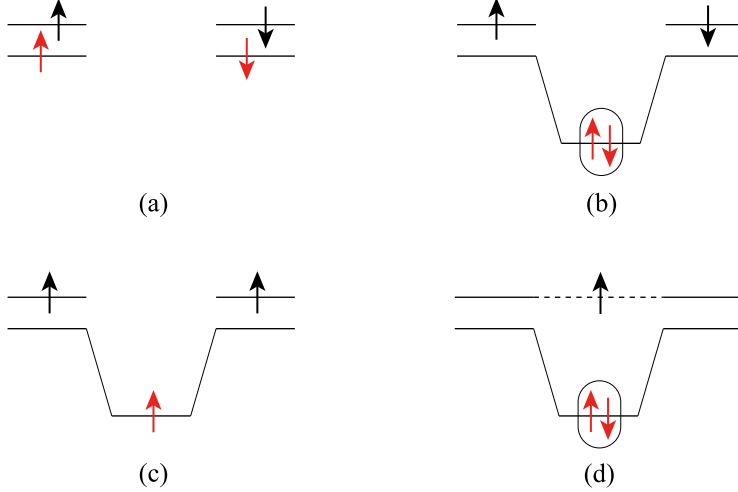

Figure 8: Orbital-selective metal–metal bonding, by [57]. (a), (b) The situation with two electrons per site on two orbitals, one of which has a strong overlap and intersite hopping t , whereas the other has small or zero hopping. In (a) the situation with the strong Hund’s rule coupling is shown, $J_H > t$, which leads to the formation of $S = 1$ states at each centre, with some antiferromagnetic interaction between those. (b) The situation with strong hopping $t > J_H$, leading to the formation of a singlet bond made of strongly overlapping orbitals, with the remaining localized electrons with $S = \frac{1}{2}$ per site. (c), (d) Similar situation in case of three electrons per dimer. (c) The situation with strong Hund’s exchange, $J_H > t$, leading to parallel orientation of all three spins: two localized one per site, and one “itinerant”, hopping from site to site. This is the double exchange mechanism of ferromagnetism e.g. in metallic oxides such as colossal magnetoresistance manganites. (d) The situation with very strong intersite hopping on “itinerant” orbitals, $t > J_H$. In this case two electrons form a singlet bonding state made of these orbitals, and there remains one localized electron per dimer, with $S = \frac{1}{2}$ (in contrast to the total spin of a dimer $S = \frac{3}{2}$ in the case (c)). Thus in this situation the formation of orbital-selective molecular orbital on a dimer leads to the suppression of double exchange.

In principle one has to include here the orbital indices of the respective d - and p -orbitals, and, when necessary, also other interactions — e.g. the Hund’s exchange, Hubbard-like repulsion of p -electrons U_{pp} , etc.

In this situation, which was also considered in great detail by Goodenough in many papers and in the book [13], an important parameter, besides the electron hopping and the Hubbard U (and Hund’s coupling J_H), is the energy difference between d - and p -levels, i.e. the difference between the “original” configuration $d^n p^6$ (with certain valence of TM and with oxygen O^{2-}) and the excited state in which we transfer an electron from oxygen to TM — the charge transfer excitation energy

$$\Delta_{CT} = E(d^{n+1}p^5) - E(d^n p^6). \quad (7)$$

In the description with the Hamiltonian (6) it may look as though $\Delta_{CT} = \epsilon_d - \epsilon_p$, but in fact one has to include in the definition of charge transfer energy also the effects of the change of interactions, such as on-site Coulomb interactions on d - and p -levels, implicitly taken into account in (7). But it is often possible to use the schematic one-electron picture with single-particle d - and p -levels, as in Fig. 9 — remembering that in fact these are the levels of particular many-electron configurations.

In this more general and more realistic description one would have in the exchange processes not only virtual transitions between d -levels, of the type $d^n d^n \leftrightarrow d^{n-1} d^{n+1}$, which cost energy U (this is the U in the denominator of the exchange integral J in (2)); but there would be also processes of virtual transitions to and from intermediate oxygens, $d^n p^6 \leftrightarrow d^{n+1} p^5$, with the excitation energy Δ_{CT} (7). All this is now a well-developed field, and, again, orbital occupation plays a very important role in determining the exchange processes and in determining the resulting exchange constants.

Very special situations may appear if the energies of these configurations, $d^n p^6$ and $d^{n+1} p^5$, becomes comparable, so that the charge transfer energy Δ_{CT} is very small or even becomes negative, Fig. 9(b). In this case, first of all, it is just this charge transfer transition which would dominate in exchange processes. As a result the exchange integrals as in (2) would contain in the denominators not the Hubbard’s U but the charge transfer energy Δ_{CT} [13, 2]. But for negative CT energy there may also occur stronger modifications: there may exist “self-doping” [59] — some electrons may spontaneously go from oxygens to transition metals, so that there would be oxygen holes created even without external doping. In this case the material may

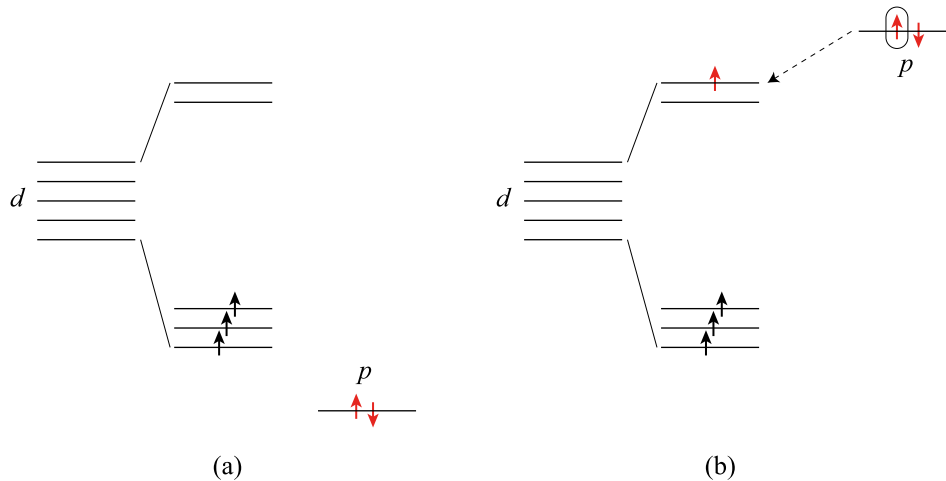

Figure 9: Schematic energy structure of transition metal systems with the apparent inclusion of ligand (e.g. oxygen) p -holes (a) The usual situation with deep p -levels and large charge-transfer gap. (b) The situation with small or negative charge-transfer gap, in which case there may occur “self-doping” — spontaneous transfer of one of p -electrons of oxygen to the d -shell of transition metal, leading to the formation of oxygen holes. Note that this is a simplified picture; in fact the energies of respective p - and d -levels should include the contribution of electron–electron interactions, notably the Hubbard’s U , see text.

even become metallic. It is a very interesting and rich, though often obscure field, which develops now rather rapidly, see e.g. [60, 61].

In such situation with small or negative CT gap the typical orbital effects such as the JT effect and orbital ordering, may also change. Thus e.g. the detailed form of orbital ordering for the case of e_g degeneracy may change [62]. And in some cases the presence of ligand holes can even suppress the otherwise very strong JT effect, even in such famous JT ions as Cu^{2+} , which happens e.g. in $\text{Ba}_3\text{CuSb}_2\text{O}_9$ [63]. Thus the orbital effects turn out to be rather sensitive to the details of the electronic structure, especially in the case of small or negative CT energy.

7 Orbitals, frustrations, spin and orbital liquids

The directional character of orbitals, already stressed above, can also cause very special effects in magnetic behaviour of some systems, leading in particular to novel mechanisms of frustration and to stabilisation of spin-liquid,

and maybe orbital liquid states. Spin and orbital exchange in this situation may become strongly bond-dependent. For orbital ordering a straightforward mechanism of this effect may be understood from Fig. 1: we see that the electron hopping and the respective exchange for the e_g orbital $|x^2\rangle = |2x^2 - y^2 - z^2\rangle$ extended in the x -direction is strong for the ij -bond parallel to x , whereas the orbital $|y^2\rangle = |2y^2 - x^2 - z^2\rangle$ would have strong overlap with similar orbital in the y -bond. If we describe these doubly-degenerate orbitals by a pseudospin τ , we would expect an interaction of the type

$$H = \sum_{\langle ij \rangle_x} \tau_i^x \tau_j^x + \sum_{\langle ij \rangle_y} \tau_i^y \tau_j^y + \sum_{\langle ij \rangle_z} \tau_i^z \tau_j^z. \quad (8)$$

This model — the “compass” model — was introduced in [7], Ch. 10, where it was written: “Although the interaction within each pair is a sort of Ising interaction, the overall symmetry is considerably more complicated. The ‘cubic’ model in (34) [here (8)] has much in common with the real dipole-dipole interaction, and its properties, even its ground-state structure, are not yet clear. Pairs arranged along the z axis, for example, would like to align their spins along z , while pairs arranged along the x axis would like to orient their spins along this axis. This situation can be described by the classical model of a lattice of magnetic needles (‘compasses’). In contrast with a one-dimensional system, the properties of two-dimensional and three-dimensional systems are not understood even qualitatively.” There was since then a significant theoretical development in this model, summarised in [64].

A very important version of this model was proposed independently by Kitaev for the 2d honeycomb lattice, where xx , yy and zz interactions exist on three types of bonds in this lattice [65]. In this situation such model can be solved exactly, and the solution in a symmetric case is a spin liquid state with very unusual excitations — Majorana fermions, which potentially can be even used for quantum computing, etc. In a very important paper G. Jackeli and G. Khaliullin [66] have shown that this model can be realised in real TM compounds with honeycomb lattice and with strong spin-orbit interaction, which exist for example in $4d$ and $5d$ compounds. These suggestions gave rise to enormous activity in studying such effects, both experimentally and theoretically, see e.g. [67, 68]. Experimentally there exist now several materials which, if not exactly described by the Kitaev model, are still rather close to it: Li_2IrO_3 , Na_2IrO_3 , RuCl_3 . To the best of my knowledge, a good experimental realization of the original compass model of [7] in 3d systems has not been found until now.

Besides using orbital freedom to make bond-dependent exchange and consequently to enhance frustrations and to stabilise eventual spin liquid states, one can also think of forming an orbital analogue of spin liquids — an orbital, or spin-orbital liquid. Formally this seems relatively straightforward: we usually describe orbital ordering using the effective pseudospin description of orbitals, e.g. such that one of two degenerate e_g orbital corresponds to the pseudospin $\tau^z = +\frac{1}{2}$, and the other to $\tau^z = -\frac{1}{2}$. And intersite interaction leading to orbital ordering is described in this formalism by the effective “exchange” interaction of the type $J\tau_i\tau_j$, cf. the expressions (5) and (8). And one can think that, as in some spin systems, at certain conditions we can have for orbitals, as for spins, not only some type of ordered states but also orbital liquid states, analogous to spin liquids. Such ideas were many times discussed in the literature, and there were even experimental results interpreted in this way, e.g. this mechanism was suggested to explain the properties of LiNiO_2 [69] — see however [70]. In principle this is indeed a possibility. However there is one very important factor which makes the situation for orbitals different from that for spins, and which makes the formation of such orbital liquid states much more difficult, if not impossible. The point is that, in contrast to spins which “live” more or less independently, a particular orbital occupation implies a corresponding distribution of electron charge density, and as such it is intrinsically strongly coupled with the lattice. And on the lattice the ions are heavy and behave more or less classically — or at least the timescale of corresponding fluctuations is much bigger: the lattice is “slow”. Consequently one cannot expect to have strong quantum fluctuations in the orbital sector; in this sense orbitals usually behave much more classically as compared to spins. As a result the orbital liquid states are much less probable than spin liquids — although one cannot exclude that at certain very specific situations one can still have orbital or mixed spin-orbital liquids.

8 Spin-orbit coupling

Yet another very important factor connected with orbitals, which strongly influences the properties of most magnetic materials (and not only those), is the spin–orbit coupling. In contrast with the spin-orbital effects discussed above, real relativistic spin–orbit interaction acts everywhere, and it can determine the behaviour of many materials.

The spin-orbit coupling (SOC)

$$H_{\text{SO}} = -\lambda \mathbf{L} \cdot \mathbf{S} \quad (9)$$

couples spins with the charge degrees of freedom, which the orbitals represent, and because of that it couples spins to the lattice, leading to such phenomena as magnetic anisotropy (and in most cases strong magnetoelastic coupling and magnetostriction). Only due to SOC do we have all these very important characteristics of a particular magnetic material. Without SOC the spin orientation would be completely decoupled from the lattice, and the directions in the spin space would have nothing to do with the real directions in a particular crystal, i.e. there would not be any magnetic anisotropy, etc.; the spin space would remain spherically symmetric.

All this is very well known and was understood from the very beginning of the development of the theory of magnetism. More specifically, in the typical situation mainly discussed in this paper, that of TM ions in a cubic crystal field, the orbital moment is quenched for e_g electrons, and SOC acts on e_g electrons only in a higher order. However it is not quenched for the t_{2g} triplet; the SOC acts for those states already in the lowest order, and that is why TM ions with partially-filled t_{2g} levels typically experience a much stronger influence of SOC and have much stronger magnetic anisotropy, magnetostriction etc. Moreover, in many cases the SOC “interferes” with the JT effect, sometimes reversing the sign of lattice distortions. Thus the JT effect would lead for Co^{2+} (d^7) to a tetragonal elongation, $c/a > 1$, but if SOC dominates, one would have not elongation but compression, $c/a < 1$, see Fig. 10(a), (b) And experimentally indeed most Co^{2+} systems (CoO , KCoF_3) show such compression, in the case of CoO so strong that it even makes the magnetic transition at T_N a weak first-order transition. In other cases, e.g. in insulating materials with Ir^{4+} , strong SOC leads to a complete suppression of JT distortion, Fig. 10(c).

These effects become especially interesting and strong for $4d$ and $5d$ systems, in which, first, we typically have low-spin states with predominant occupation of SOC-active t_{2g} states; and, second, because SOC becomes much stronger for heavier elements.

Here I want to make one side remark: In most textbooks and other publications one usually gives the dependence of the SOC on the atomic number (the charge of the nucleus) Z as $\lambda \sim Z^4$. However the more accurate treatment presented e.g. in another physicists’ “bible”, the course of theoretical

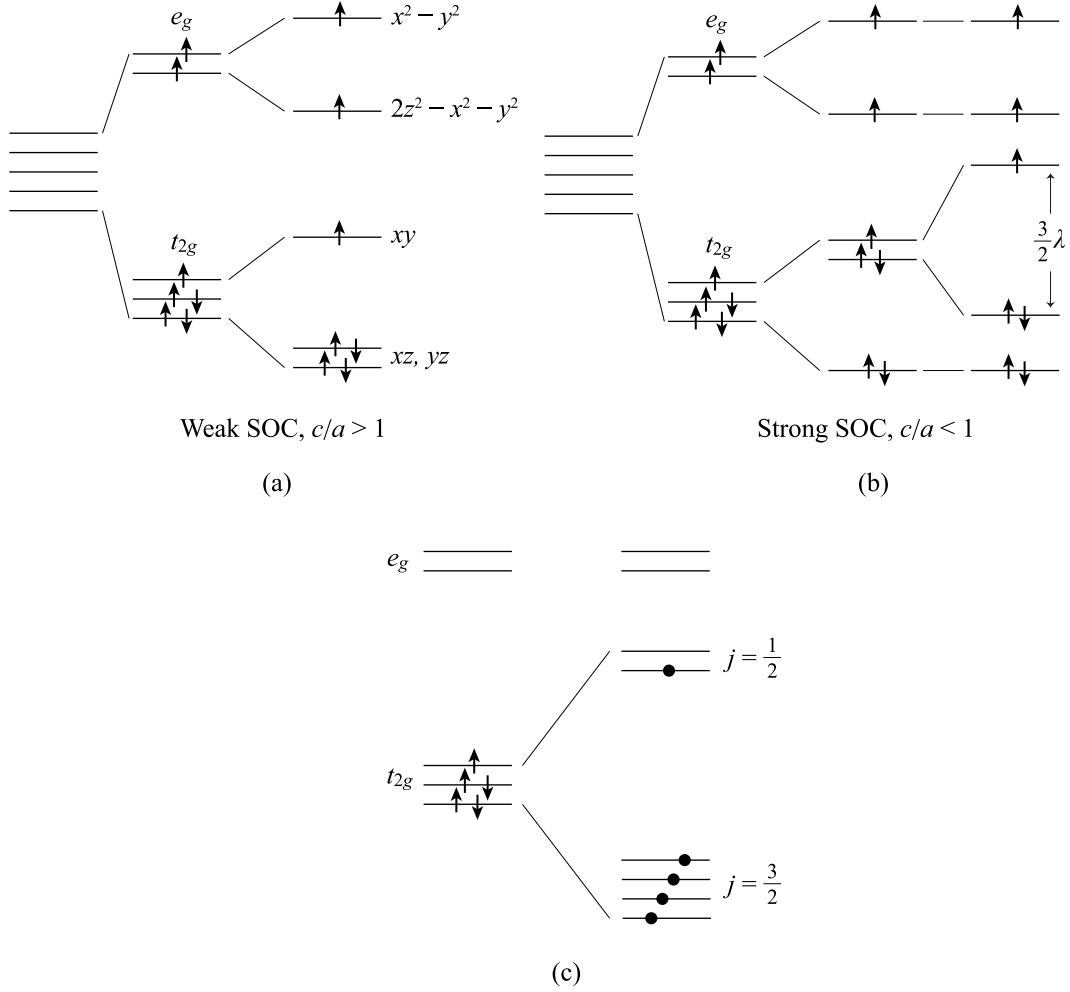

Figure 10: Simplified scheme of the modification of energy levels due to spin-orbit interaction $\lambda \cdot \mathbf{S}$. (a) Energy levels and their filling of transition metals ion with the d^7 configuration, as in Co^{2+} , in case of weak spin-orbit coupling, smaller than the Jahn-Teller splitting, which would lead to Jahn-Teller distortion — an elongation of MO_6 octahedra, $c/a > 1$. (b) The same for strong spin-orbit coupling, stronger than the eventual Jahn-Teller splitting. It would lead to the opposite distortion with compressed octahedra, $c/a < 1$. The situation in real Co^{2+} ions corresponds to the case (b). Both cases (a) and (b) are obtained in the mean-field picture, valid for bulk systems with strong intersite interaction. In a more detailed treatment the isolated Co^{2+} ions have effective spin $\frac{1}{2}$ (total spin $S = \frac{3}{2}$ and effective orbital moment $l_{\text{eff}} = 1$ give $J_{\text{eff}} = \frac{1}{2}$) [71]. (c) Energy levels of d -electrons for very strong spin-orbit coupling (one-electron picture, strictly speaking applicable for the jj coupling). The electron filling is shown for the d^5 configuration, as in Ru^{3+} or Ir^{4+} . One sees that the fifth electron (or one hole) occupies the higher-lying $j = \frac{1}{2}$ state which is a Kramers doublet without any orbital degeneracy and without the Jahn-Teller effect.

physics by Landau and Lifshits, shows that actually this dependence should rather be $\lambda \sim Z^2$ [72]. And indeed, a comparison with the real situation shows that this law fits the experimental data much better. The conventional dependence $\sim Z^4$ is just copied from one publication to the next, in what one calls being “adopted by repetition” — which does not make it true!

In any case, it is for $4d$ and $5d$ elements that we should expect strong, and in some case crucial influence of SOC, see e.g. [73]. As to the above-mentioned interplay between SOC and JT effect, the detailed treatment [74] shows that it is indeed very strong but not universal, as it strongly depends on the electron configuration of the respective ions. In most cases strong SOC suppresses the JT effect. This is not difficult to understand: the JT effect leads to structural distortions and to occupation by an electron of a particular orbital with a particular electron density distribution, actually a particular electric quadrupole moment. Such state is described by a real wavefunction, e.g. for t_{2g} electrons it may be $|xy\rangle$ or $|xz\rangle$. However SOC stabilizes the state with a particular orbital moment which breaks the time-reversal invariance and is described by a complex wavefunction, e.g. $\frac{1}{\sqrt{2}}(|xz\rangle + i|yz\rangle)$. That is, SOC and the JT effect typically oppose each other. And this is indeed the case for low-spin ions with d^1 , d^2 , d^4 and d^5 configurations: here the JT effect and SOC counteract each other. However the situation is opposite for the configuration d^3 [74]: in this case SOC does not suppress but rather activates, promotes the JT effect. Indeed, without SOC three d -electrons completely fill three t_{2g} levels (with parallel spins) and there is no orbital degeneracy left. But for very strong SOC (when we are close to the jj coupling scheme) the t_{2g} levels, which can be described by an effective orbital moment $l = 1$, are split into a lower-lying quartet $j = \frac{3}{2}$ and a higher-lying Kramers doublet $j = \frac{1}{2}$, Fig. 10(c). And we now have to put three electrons on this $j = \frac{3}{2}$ quartet, which leaves orbital degeneracy. In effect, for the d^3 configuration with strong SOC we have the JT effect, and this degeneracy can be lifted by JT distortions, e.g. tetragonal or orthorhombic. Similarly, one can consider coupling of t_{2g} levels with strong SOC to trigonal distortions [75]; the results are qualitatively similar to those of [74].

These considerations also demonstrate one very interesting situation: for the d^5 configuration, such as is met e.g. in Ru^{3+} or Ir^{4+} , the strong SOC would lift orbital degeneracy, and the system would find itself in a nondegenerate Kramers doublet $j = \frac{1}{2}$, Fig. 10(c). Thus the situation seems to be similar to that of the nondegenerate Hubbard model, Eq. (1). But the spin-orbit entanglement in this case strongly modifies all the properties of the respective

materials; it is precisely because of this that honeycomb systems such as RuCl_3 or Na_2IrO_3 behave as Kitaev systems, as discussed in Sec. 7. Thus the strong SOC in $4d$ and $5d$ materials leads to a profound modification of their state and largely determines their properties.

Another, potentially much more important consequence of SOC, is that it can provide a mechanism of formation of nontrivial topological states — topological insulators, Weyl semimetals, etc. These phenomena, very actively studied nowadays, are usually investigated in systems without strong electron correlations — in systems such as Bi_2Se_3 , or TaAs, etc. This is a very intensively developing field right now, see e.g. the reviews [76, 77, 78]. But these topological properties may exist also in systems with interacting electrons, in magnetic and other strongly correlated systems. The study of this topic still is at an initial stage, but it already has produced many very interesting results and will definitely produce much more.

9 Quantum effects

In most situation one considers orbitals in TM compounds as classical objects. This is how we treat the cooperative Jahn–Teller ordering and the corresponding structural transitions. Basically, this is justified by the arguments presented in Sec. 7: the orbitals are intrinsically strongly coupled to the lattice, but the lattice is “slow” and “heavy”, and thus one does not expect strong quantum effects in it. Nevertheless there are some situations in which one should take quantum effects in orbital physics very seriously.

The first factor, which is crucial in the treatment of the Jahn–Teller effect in small systems — molecules, isolated JT impurities in solids — is what is known in the JT field as *vibronic effects*. The essence of the JT effect is that, in contrast to the usual adiabatic approximation, normally used to treat coupled electron–lattice systems, to each electronic configurations there corresponds a respective distortion,

$$|\Psi_i\rangle = |\psi_i\rangle|\phi_i\rangle, \quad (10)$$

where $|\Psi\rangle$ is the total wavefunction — a vibronic state, and $|\psi_i\rangle$ and $|\phi_i\rangle$ are, correspondingly, wavefunctions of the respective electronic and lattice (nuclear) configurations. Thus, for example, to each of the two electronic configurations (orbitals) of two minima of Fig. 3(a), there corresponds its own distortion. For small systems there will always be quantum tunnelling

between these two states (the two minima of Fig. 3(a)). These tunnelling processes will lead to significant quantum effects (quantum fluctuations) even in the ground state of a small JT system. Here both electronic and lattice degrees of freedom are equally important, and both have to be treated quantum-mechanically. This constitutes a big field of *vibronic physics*, a very important part of the treatment of molecules with the JT effect. If the JT coupling of degenerate electronic states, e.g. degenerate orbitals, is not with only one, but say with two distortion modes, as is the case of e_g electrons (which couple to doubly-degenerate E -type distortions, tetragonal Q_3 and orthorhombic Q_2), then the manifold of the degenerate ground states consists not only of two degenerate minima, as in Fig. 3(a), but is a whole continuum of degenerate states, the “trough” in the energy surface $E(Q_2, Q_3)$ (the “Mexican hat” of Fig. 3(b)), and the system can freely rotate along this trough; this has to be treated fully quantum-mechanically.

One interesting consequence of this full quantum-mechanical treatment of the combined electron–lattice system is that the nondiagonal matrix elements of any electron operator are suppressed by the overlap of nonorthogonal distortion in the vibronic functions (10):

$$\langle \Psi_2 | \hat{A} | \Psi_1 \rangle = \langle \psi_2 | \hat{A} | \psi_1 \rangle \langle \phi_2 | \phi_1 \rangle, \quad (11)$$

with the extra factor $\langle \phi_2 | \phi_1 \rangle < 1$ (often $\ll 1$). This reduction is known in the JT field as the *Ham’s reduction factor* [79, 80]; for the physical community exactly the same effect is known as *polaronic band narrowing*.

Thus, such vibronic, essentially quantum effects, are very important, and really crucial in the treatment of degenerate situations such as orbital degeneracy in small systems, molecules and JT impurities in crystals. However in considering concentrated systems, such as solids with orbital ordering, we practically always treat the lattice (quasi)classically. To which extent the “molecular” or vibronic quantum effects might be important for concentrated systems, is an open question.

But if we ignore the coupling to the lattice, indeed we could expect quantum effects in orbital sector also in concentrated systems. There were such suggestions in the literature [81, 82, 83], especially in connection with the systems with t_{2g} electrons, for which the JT coupling to the lattice is weaker. There were claims that some properties of e.g. LaTiO_3 and LaVO_3 are explained by such quantum fluctuations [83]. However this interpretation is rather questionable, there are alternative explanations of the observed effects [84, 85].

Theoretically there is one very interesting situation, first considered already in [86, 7], in which for the doubly-degenerate orbitals with a particular pattern of electronic hoppings, with $t_{11} = t_{22} = t$, $t_{12} = 0$, the resulting “Kugel–Khomskii” model contains both spin and orbital variables \mathbf{S} , $\boldsymbol{\tau}$, in the Heisenberg form: the effective Hamiltonian (5) takes the form

$$H = J \sum_{ij} \left(\mathbf{S}_i \cdot \mathbf{S}_j + \boldsymbol{\tau}_i \cdot \boldsymbol{\tau}_j + 4(\mathbf{S}_i \cdot \mathbf{S}_j)(\boldsymbol{\tau}_i \cdot \boldsymbol{\tau}_j) \right). \quad (12)$$

This model has a very high symmetry, $SU(4)$, and it leads to three gapless excitations (Goldstone modes). It is an extremely quantum model, which for the 1d case can be solved exactly. This model naturally appears in TM system with (MO_6) octahedra with common face [23, 87], and the same model was derived for honeycomb systems with strong SOC coupling in [88]. There it was proposed that $ZrCl_3$ with honeycomb lattice may be an example of the system with such interaction, although this suggestion was questioned in [89].

Altogether, the question of possible quantum effects in the orbital sector of TM compounds is very interesting and largely still unexplored. As mentioned above, in comparison to spins there is here one important factor: the coupling of orbitals with the “heavy” lattice, which can suppress quantum effects. But still, there may be situations in which such quantum effects might be important, up to the possibility of orbital or spin–orbital liquids.

10 Orbital effects in metallic systems

Orbital effects can also be important in metallic systems, although formally for example the JT effect should work for insulators. Goodenough in many of his works and in the book [13] strongly advocated the idea that there exist two different thermodynamic states of electrons in solids — localised and itinerant. This in itself completely agrees with the present point of view from which we started this paper. But as an indicator or the fingerprint allowing us to tell whether a particular situation corresponds to the one regime or the other, he suggested to take just the presence or absence of JT distortions: if in a situation in which formally for a given electron configuration one would expect orbital degeneracy and JT distortion but experimentally such distortion is absent, this might be an indication that we are dealing with itinerant electrons, and vice versa for localised ones.

Nevertheless there are nowadays many examples which demonstrate that, despite the absence of a standard JT distortion, in some metallic systems the orbital effects are still very important. One of the situations leading to that can be the situation with orbital-selective localization, discussed in Sec. 5 above. For example some electrons may be delocalised and may give metallic conductivity, whereas the other group of electrons behaves as more localised, and these can display characteristics typical for localised electrons, including the JT effect.

Another very important situation is when some insulating materials, with orbital degeneracy and with rather strong JT distortion, become metallic due to relatively small doping. Here the lattice may still remain JT-distorted, with the same orbitals playing the main role in the doped case as well. The most important such example is High- T_c cuprates. For example, the prototype material La_2CuO_4 is a Mott insulator with a strong JT effect and with holes occupying one particular orbital of the e_g doublet, the famous $|x^2 - y^2\rangle$ orbital. And the same orbitals also remain active in doped systems such as $\text{La}_{2-x}\text{Sr}_x\text{CuO}_4$, which are not only metallic but are High- T_c superconductors. Actually for the discoverer of High- T_c cuprates, Alex Mueller, the fact that Cu is a well-known JT ion was a guiding principle that led him to search for superconductivity in these systems — although in their pure form these factors don't seem to explain the phenomenon of High- T_c superconductivity in cuprates. Still, the very fact that for most of the effects we can work in this case with a single $(x^2 - y^2)$ band, which follows from the JT nature of Cu^{2+} , demonstrates the general importance of orbital effects in these systems, as well. There are many arguments that in another class of High- T_c superconductors, Fe-based superconductors, orbital effects also play an important role, see e.g. [90, 91, 92].

Yet one more recent development, strongly relying on orbital effects, is the realization that there exists a special class of materials in which not so much the Hubbard's U but the Hund's rule exchange interaction J_H (operating only in many-orbital situations) plays a crucial role. These are the so-called Hund's metals [93, 56]. All this demonstrates that in many metallic systems the orbital effects might also be very important and must be taken into account.

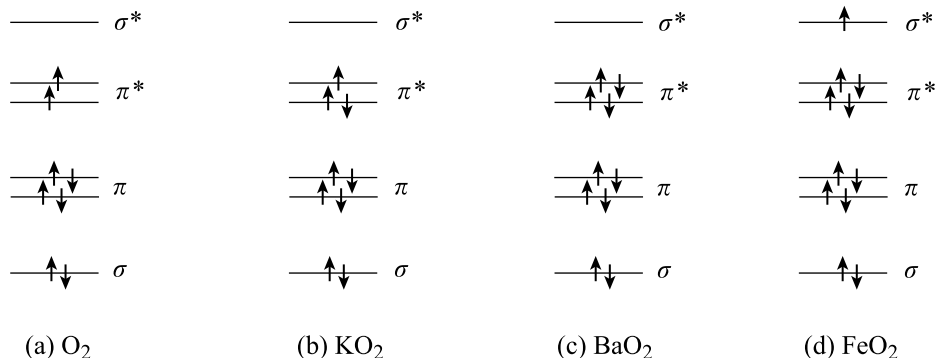

Figure 11: Energy levels of O_2 dimers and their filling by electrons for compounds containing oxygen dimers. (a) O_2 molecule. (b) Superoxide such as NaO_2 , KO_2 . (c) Peroxide such as BaO_2 , MgO_2 . (d) Recently synthesized FeO_2 [96].

11 Orbitals in other systems

Until now in treating the orbital effects we always had in mind magnetic systems (transition metal compounds). But in fact the physics disclosed in studying the orbital effects in TM compounds can be relevant in many other situations as well. The most straightforward is the extension of these notions from d -electrons to p -electrons of, say, oxygen. It is well known that the oxygen molecules themselves are magnetic, due to a specific filling of molecular orbitals of those, Fig. 11(a). Even more interesting effects are observed in superoxides (or hyperoxides) such as KO_2 and peroxides such as BaO_2 , Fig. 11(b,c). In these systems the situation may be indeed very similar to that of d -electron systems, with both magnetic and orbital degrees of freedom strongly coupled [94, 95].

But also in completely different systems, such as graphene, including the twisted bilayer graphene, one meets the situation strongly resembling that of TM systems with orbital degeneracy. Indeed, due to a particular lattice geometry leading to a specific band structure, in graphene we have the situation with extra degeneracy, resulting in 4-fold degenerate states — two spins and two types of band minima. And the effective description sometimes used to treat this situation strongly resembles that of the spin-orbital (Kugel–Khomskii) model (5), in some cases leading also to the effective $\text{SU}(4)$ model, as in (12), see e.g. [97]. One even speaks nowadays, in analogy with spintronics, about “orbitronics” (usually having in mind effects caused by spin–orbit coupling) — see e.g. [98]. The experience and the know-how we

got in studying orbital physics in transition metal compounds may be useful in a broader context of situations in many solids with extra degeneracy. Thus this section could have a title “Orbitals everywhere”.

12 Instead of Conclusions

Orbital physics, the field initiated by Goodenough in the 1950–1960s and largely determined by his contributions for many years, has developed very successfully since then, and it has served as a basis of realistic description of magnetic materials — and not only those. In this short review I have tried to summarise these very successful developments, and concentrated on several new directions in orbital physics, which already produced and will definitely produce many new interesting results. Of course I could not cover all the aspects of this big field. Thus e.g. orbital effects in thin films or at interfaces may also be crucial, see e.g. [99, 100]. And they may be very important in other phenomena as well. In any case, the role played by Goodenough in this development is indispensable; this entire field carries an imprint of his great personality.

At the end some personal notes. I came to solid state physics from a completely different field: my diploma work (master thesis) in the university was in high-energy physics and in elementary particle theory. And when after several rather turbulent years I moved to condensed matter physics, the first thing was to learn the new language. Rather quickly I came across the book by Goodenough [13], and I immediately felt that it is a treasure trove of wisdom. But because of the different background it was initially rather difficult for me to appreciate and use it. My experience was more or less the following: when I started to look at a problem, I would read what Goodenough wrote about it, but very often I could not understand it. Then I tried to do it my way, and if I managed to solve the problem, I looked again at what John wrote about it, and — “Aha, that’s what he had in mind!” In fact in all cases he was right, one only had to be able to understand it. And that is the message, or rather two messages to the readers: first, learn a “foreign” language; and second, the most important one: Goodenough is almost always right! And even if you don’t agree with him on some points (for me this happened only once), it is still extremely useful and stimulating to know what he did think and write about the problem.

And the last, just one short picture. I visited John around 2000, my only

trip to Austin. I stayed there for 2–3 days. Friday evening we were leaving the institute, it was my last day there. When we went from John’s office to his car, he carried under both arms two heavy loads of thick volumes of Phys. Rev. — older people still remember how they in the libraries used to make thick bound volumes of three or four issues of Phys. Rev. And John explained to me: “This is my homework for the weekend”. This was about 20 years ago, and he was already about 80! It is really incredible how he continues to keep pace for all these years. It is definitely an example for all of us — the example which probably not many could follow, but at least we have to try. We have a great role model before us!

Acknowledgements

This work was funded by the Deutsche Forschungsgemeinschaft (DFG, German Research Foundation) – Project number 277146847 – CRC 1238.

References

- [1] N. F. Mott and R. Peierls, *Discussion after the talk of de Boer and Verwey*, Proc. Phys. Soc. **A49**, 72 (1937)
- [2] D. I. Khomskii, *Transition Metal Compounds*, Cambridge University Press, Cambridge (2014)
- [3] L. D. Landau and Y. Zeldovich, *On the Relation between the Liquid and the Gaseous States of Metals*, Acta Phys.-Chim. USSR **18**, 194 (1944); also ZhETF **14**, 32 (1944)
- [4] N. F. Mott, *The basis of the electron theory of metals, with special reference to the transition metals*, Proc. Phys. Soc. **A62**, 416 (1949)
- [5] P. W. Anderson, *New Approach to the Theory of Superexchange Interactions*, Phys. Rev. **115**, 2 (1959)
- [6] J. Hubbard, *Electron correlations in narrow energy bands*, Proc. Roy. Soc. **A276**, 238 (1963)
- [7] K. I. Kugel and D.I.Khomskii, *Jahn–Teller effect and magnetism: transition metal compounds*, Sov. Phys.—Uspekhi **25**, 231 (1982)

- [8] Y. Tokura and N. Nagaosa, *Orbital Physics in Transition-Metal Oxides*, Science **288**, 462 (2000)
- [9] D. I. Khomskii, *Role of orbitals in the physics of correlated electron systems*, Physica Scripta **72**, CC8 (2005)
- [10] G. Khaliullin, *Orbital Order and Fluctuations in Mott Insulators*, Prog. Theor. Phys. Suppl. **160**, 155 (2005)
- [11] S. V. Streltsov and D. I. Khomskii, *Orbital physics in transition metal compounds: new trends*, Physics—Uspekhi **60**, 1121 (2017)
- [12] D. I. Khomskii and S. V. Streltsov, *Orbital Effects in Solids: Basics, Recent Progress, and Opportunities*, Chem. Rev. **121**, 2992–3030 (2021)
- [13] J. B. Goodenough, *Magnetism and the Chemical Bond*, New York: Interscience (1963)
- [14] J. B. Goodenough, *Theory of the Role of Covalence in the Perovskite-Type Manganites* [La, M(II)]MnO₃, Phys. Rev. **100**, 564 (1955)
- [15] J. B. Goodenough, *An interpretation of the magnetic properties of the perovskite-type mixed crystals* La_{1-x}Sr_xCoO_{3-λ}, Journal of Physics and Chemistry of Solids **6**, 287 (1958)
- [16] J. Kanamori, *Theory of the Magnetic Properties of Ferrous and Cobaltous Oxides*, Prog. Theor. Phys. **17**, 177–196, 197–222 (1957)
- [17] J. Kanamori, *Superexchange interaction and symmetry properties of electron orbitals*, Journal of Physics and Chemistry of Solids **10**, 87 (1959)
- [18] J. Kanamori, J. Appl. Phys. Suppl. **31**, 14S (1960)
- [19] E. F. Stoner, *Collective electron ferromagnetism*, Proc. R. Soc. Lond. A. **165** (922): 372–414 (1938)
- [20] C. Zener, *Interaction between the d-Shells in the Transition Metals. II. Ferromagnetic Compounds of Manganese with Perovskite Structure*, Phys. Rev. **82** (3): 403 (1951)

- [21] P.-G. de Gennes, *Effects of Double Exchange in Magnetic Crystals*, Phys. Rev. **118** (1): 141 (1960)
- [22] S. V. Streltsov and D. I. Khomskii, *Electronic structure and magnetic properties of pyroxenes (Li,Na)TM(Si,Ge)₂O₆: novel low-dimensional magnets with 90° bonds*, Phys. Rev. B **77**, 064405 (2008)
- [23] K. I. Kugel, D. I. Khomskii, A. O. Sboychakov and S. V. Streltsov, *Spin-orbital interaction for face-sharing octahedra: realization of highly symmetric SU(4) model*, Phys. Rev. B **91**, 155125 (2015)
- [24] H. A. Jahn and E. Teller, *Stability of polyatomic molecules in degenerate electronic states — I-Orbital degeneracy*, Proc. R. Soc. A. **161** (A905): 220 (1937)
- [25] I. B. Bersuker, *The Jahn–Teller Effect*, Cambridge University Press, Cambridge (2006)
- [26] K. I. Kugel and D. I. Khomskii, *Superexchange ordering of degenerate orbitals and magnetic structure of dielectrics with Jahn–Teller ions*, JETP Letters–USSR **15**, 446 (1972)
- [27] K. I. Kugel and D. I. Khomskii, *Crystal structure and magnetic properties of the substances with orbital degeneracy*, Sov. Phys.—JETP **37**, 725 (1973)
- [28] E. Pavarini, E. Koch and A. I. Lichtenstein, *Mechanism for Orbital Ordering in KCuF₃*, Phys. Rev. Lett. **101**, 266405 (2008)
- [29] E. Pavarini and E. Koch, *Origin of Jahn–Teller Distortion and Orbital Order in LaMnO₃*, Phys. Rev. Lett. **104**, 086402 (2010)
- [30] Y. Wang, G. L. Pascut, B. Gao, T. A. Tyson, K. Haule, V. Kiryukhin and S.-W. Cheong, *Unveiling hidden ferrimagnetism and giant magnetoelectricity in polar magnet Fe₂Mo₃O₈*, Sci. Rep. **5**, 12268 (2015)
- [31] T. Kurumaji, S. Ishiwata and Y. Tokura, *Diagonal Magnetoelectric Susceptibility and Effect of Fe Doping in the Polar Ferrimagnet Mn₂Mo₃O₈*, Phys. Rev. B **95**, 045142 (2017)

- [32] S. Streltsov, D.-J. Huang, I. V. Solovyev and D. I. Khomskii, *Ordering of Fe and Zn Ions and the Magnetic Properties*, JETP Lett. **109**, 786–789 (2019)
- [33] I. V. Solovyev and S. V. Streltsov, *Microscopic Toy model for Magnetoelectric Effect in Polar $\text{Fe}_2\text{Mo}_3\text{O}_8$* , Phys. Rev. Mater **3**, 114402 (2019)
- [34] Z. A. Kelly, T. T. Tran and T. M. McQueen, *Nonpolar-to-Polar Trimerization Transitions in the $S = 1$ Kagome Magnet $\text{Na}_2\text{Ti}_3\text{Cl}_8$* , Inorg. Chem. **58**, 11941 (2019)
- [35] E. Ruff, S. Widmann, P. Lunkenheimer, V. Tsurkan, S. Bordács, I. Kézsmárki and A. Loidl, *Multiferroicity and skyrmions carrying electric polarization in GaV_4S_8* , Science Adv. **1** e1500916 (2015)
- [36] Z. Wang, E. Ruff, M. Schmidt, V. Tsurkan, I. Kézsmárki, P. Lunkenheimer and A. Loidl, *Polar Dynamics at the Jahn–Teller Transition in Ferroelectric GaV_4S_8* , Phys. Rev. Lett. **115**, 206601 (2015)
- [37] S. A. J. Kimber, M. S. Senn, S. Fratini, Hua Wu, A. H. Hill, P. Manuel, J. P. Attfield, D. N. Argyriou and P. F. Henry, *Charge Order at the Frontier between the Molecular and Solid States in $\text{Ba}_3\text{NaRu}_2\text{O}_9$* , Phys. Rev. Lett. **108**, 217205 (2012)
- [38] A. Revelli, C. C. Loo, D. Kiese, P. Becker, T. Fröhlich, T. Lorenz, M. Moretti Sala, G. Monaco, F. L. Buessen, J. Attig, M. Hermanns, S. V. Streltsov, D. I. Khomskii, J. van den Brink, M. Braden, P. H. M. van Loosdrecht, S. Trebst, A. Paramekanti and M. Grüninger, *Spin–orbit entangled $j = 1/2$ moments in $\text{Ba}_2\text{CeIrO}_6$ — a frustrated fcc quantum magnet*, Phys. Rev. B **100**, 085139 (2019)
- [39] L. T. Nguyen and R. J. Cava, *Hexagonal Perovskites as Quantum Materials*, Chem. Rev. 2021, 121, 5, 2935–2965
- [40] E. V. Komleva, D. I. Khomskii and S. V. Streltsov, *Three-site transition-metal clusters: going from localized electrons to molecular orbitals*, Phys. Rev. B **102**, 174448 (2020)

- [41] F. J. Morin, *Oxides which show a metal-to-insulator transition at the Néel temperature*, Phys. Rev. Lett. **3**, 34 (1959)
- [42] J. B. Goodenough, *The two components of the crystallographic transition in VO₂*, J. Solid State Chem. **3**, 490 (1971)
- [43] M. Schmidt, W. Ratclif, P. G. Radaelli, K. Refson, N. M. Harrison and S. W. Cheong, *Spin Singlet Formation in MgTi₂O₄: Evidence of a Helical Dimerization Pattern*, Phys. Rev. Lett. **92**, 056402 (2004)
- [44] P. G. Radaelli, Y. Horibe, M. J. Gutmann, H. Ishibashi, C. H. Chen, R. M. Ibberson, Y. Koyama, Y.-S. Hor, V. Kiryukhin and S.-W. Cheong, *Formation of isomorphous Ir³⁺ and Ir⁴⁺ octamers and spin dimerization in the spinel CuIr₂S₄*, Nature **416**, 155 (2002)
- [45] K. Kobayashi, K. Kosuge and S. Kachi, *Electric and magnetic properties of Li_xV_{2-x}O₂*, Mater. Res. Bull. **4**, 95 (1969)
- [46] H. Pen, J. van den Brink, D. I. Khomskii and G. Sawatzky, *Orbital ordering in two-dimensional triangular lattice*, Phys. Rev. Lett. **78**, 1323 (1997)
- [47] N. Katayama, M. Uchida, D. Hashizume, S. Niitaka, J. Matsuno, D. Matsumura, Y. Nishihata, J. Mizuki, N. Takeshita and A. Gauzzi, *Anomalous Metallic State in the Vicinity of Metal to Valence-Bond Solid Insulator Transition in LiVS₂*, Phys. Rev. Lett. **103**, 146405 (2009)
- [48] Y. Miura, Y. Yasui, M. Sato, N. Igawa and K. Kakurai, *New-Type Phase Transition of Li₂RuO₃ with Honeycomb Structure*, J. Phys. Soc. Jpn. **76**, 033705 (2007)
- [49] G. Jackeli and D. I. Khomskii, *Classical Dimers and Dimerized Superstructure in an Orbitally Degenerate Honeycomb Antiferromagnet*, Phys. Rev. Lett. **100**, 147203 (2008)
- [50] Y. Horibe, M. Shingu, K. Kurushima, H. Ishibashi, N. Ikeda, K. Kato, Y. Motome, N. Furukawa, S. Mori and T. Katsufuji, *Spontaneous formation of vanadium “molecules” in a geometrically frustrated crystal: AlV₂O₄*, Phys. Rev. Lett. **96**, 086406 (2006)

- [51] A. J. Browne, S. A. J. Kimber and J. P. Attfield, *Persistent three- and four-atom orbital molecules in the spinel AlV_2O_4* , Phys. Rev. Materials **1**, 052003(R) (2017)
- [52] D. I. Khomskii and T. Mizokawa, *Orbitally induced Peierls state in spinels*, Phys. Rev. Lett. **94**, 156402 (2005)
- [53] D. I. Khomskii, T. Mizokawa and S. V. Streltsov, *Comment on “Spin–Lattice Coupling and the Emergence of the Trimerized Phase in the $S = 1$ Kagome Antiferromagnet $\text{Na}_2\text{Ti}_3\text{Cl}_8$ ”*, Phys. Rev. Lett. **127**, 049701 (2021)
- [54] D. I. Khomskii, T. Mizokawa, and S. V. Streltsov, *Orbital Peierls mechanism of the formation of molecular clusters in $\text{Na}_2\text{Ti}_3\text{Cl}_8$ and in similar systems*, arXiv:2108.01844 (2021)
- [55] V. Anisimov, I. A. Nekrasov, D. E. Kondakov, T. M. Rice and M. Sigrist, *Orbital-selective Mott-insulator transition in $\text{Ca}_{2-x}\text{Sr}_x\text{RuO}_4$* , Eur. Phys. J. **B 25**, 191 (2002).
- [56] A. Georges, L. de’ Medici and J. Mravlje, *Strong Correlations from Hund’s Coupling*, Annu. Rev. Cond. Mat. Phys. **4**, 137 (2013)
- [57] S. V. Streltsov and D. I. Khomskii, *Covalent bonds against magnetism in transition metal compounds*, PNAS **113**, 10491 (2016)
- [58] Lisheng Chi, J. F. Britten and J. E. Greedan, *Synthesis, structure and magnetic properties of the $S = 1/2$ one-dimensional antiferromagnet $\text{Y}_5\text{Re}_2\text{O}_{12}$* , Journal of Solid State Chemistry **172**, 451 (2003)
- [59] M. A. Korotin, V. I. Anisimov, D. I. Khomskii and G. A. Sawatzky, *CrO_2 : Self-doped double-exchange ferromagnetic oxides*, Phys. Rev. Lett. **80**, 4305 (1997)
- [60] D. I. Khomskii, *Unusual valence, negative charge-transfer gaps and self-doping in transition metal compounds*, Lithuanian Journal of Physics **37**, 65 (1997); cond-mat/0101164 (2001)
- [61] G. A. Sawatzky and R. Green, in “Quantum Materials: Experiment and Theory”, Lecture Notes of the Jülich Autumn School, v. 6, Eds. E. Pavarini, E. Koch, J. van den Brink and G. A. Sawatzky; article Nr.1. 1, Jülich, Germany (2016)

- [62] M. V. Mostovoy and D. I. Khomskii, *Orbital ordering in charge transfer insulators*, Phys. Rev. Lett. **92**, 167201 (2004)
- [63] K. Takubo, H. Man, S. Nakatsuji, K. Yamamoto, Y. Zhang, Y. Hirata, H. Wadati, A. Yasui, T. Mizokawa and D. I. Khomskii, *Spin-orbital liquid in $\text{Ba}_3\text{CuSb}_2\text{O}_9$ stabilized by oxygen holes*, Phys. Rev. Mat. **5**, 075002 (2021)
- [64] Z. Nussinov and J. van den Brink, *Compass models: Theory and physical motivations*, Rev. Mod. Phys. **87**, 1 (2015)
- [65] A. Kitaev, *Anyons in an Exactly Solved Model and Beyond*, Ann. Phys. (Amsterdam, Neth.) **321**, 2–111 (2006)
- [66] G. Jackeli and G. Khaliullin, *Mott Insulators in the Strong Spin–Orbit Coupling Limit: From Heisenberg to a Quantum Compass and Kitaev Models*, Phys. Rev. Lett. **102**, 017205 (2009)
- [67] S. Trebst, *Kitaev materials*, in “Topological Matter: Topological Insulators, Skyrmions, Majoranas”; Eds. S. Blügel, Y. Mokrousov, T. Schäpers and Y. Ando; Lecture Notes of the 48th IFF Spring School; Forschungszentrum Jülich: Jülich, Germany (2017)
- [68] H. Takagi, T. Takayama, G. Jackeli, G. Khaliullin and S. E. Nagler, *Kitaev quantum spin liquid — concept and materialization*, Nature Reviews Physics 1 (4), 264–280 (2019)
- [69] F. Reynaud, D. Mertz, F. Celestini, J.-M. Debierre, A. M. Ghorayeb, P. Simon, A. Stepanov, J. Voiron and C. Delmas *Orbital Frustration at the Origin of the Magnetic Behavior in LiNiO_2* , Phys. Rev. Lett. **86**, 3638 (2001)
- [70] M. V. Mostovoy and D. I. Khomskii, *Orbital ordering in frustrated Jahn–Teller systems*, Phys. Rev. Lett. **89**, 227203 (2002)
- [71] A. Abragam and B. Bleaney, *Electronic paramagnetic resonance of transition ions*, Clarendon Press, Oxford (1970)
- [72] L. D. Landau and E. M. Lifshitz, *Quantum Mechanics. Non-Relativistic Theory*, Pergamon Press, Oxford (1965)

- [73] T. Takayama, J. Chaloupka, A. Smerald, G. Khaliullin and H. Takagi, *Spin-Orbit-Entangled Electronic Phases in 4d and 5d Transition-Metal Compounds*, J. Phys. Soc. Jpn. **90**, 062001 (2021)
- [74] S. V. Streltsov and D. I. Khomskii, *Jahn–Teller effect and spin–orbit coupling: friends or foes?*, Phys. Rev. X **10**, 031043 (2020)
- [75] S. V. Streltsov, F. V. Temnikov, K. I. Kugel and D. I. Khomskii, to be published (2021)
- [76] M. Z. Hasan and C. L. Kane, *Colloquium: Topological insulators*, Rev. Mod. Phys. **82**, 3045 (2010)
- [77] Xiao-Liang Qi and Shou-Cheng Zhang, *Topological insulators and superconductors*, Rev. Mod. Phys. **83**, 1057 (2011)
- [78] Y. Ando, *Topological Insulator Materials*, J. Phys. Soc. Jpn. **82**, 102001 (2013)
- [79] F. S. Ham, *Dynamical Jahn–Teller Effect in Paramagnetic Resonance Spectra: Orbital Reduction Factors and Partial Quenching of Spin-Orbit Interaction*, Phys. Rev. **138** A1727 (1965)
- [80] F. S. Ham, *Effect of Linear Jahn–Teller Coupling on Paramagnetic Resonance in a 2E State*, Phys. Rev. **166**, 307 (1968).
- [81] G. Khaliullin and S. Maekawa, *Orbital Liquid in Three-Dimensional Mott Insulator: LaTiO₃*, Phys. Rev. Lett. **85**, 3950 (2000)
- [82] G. Khaliullin, *Order from disorder: Quantum spin gap in magnon spectra of LaTiO₃*, Phys. Rev. B **64**, 212405 (2001)
- [83] C. Ulrich, G. Khaliullin, J. Sirker, M. Reehuis, M. Ohl, S. Miyasaka, Y. Tokura and B. Keimer, *Magnetic Neutron Scattering Study of YVO₃: Evidence for an Orbital Peierls State*, Phys. Rev. Lett. **91**, 257202 (2003).
- [84] Z. Fang and N. Nagaosa, *Quantum Versus Jahn–Teller Orbital Physics in YVO₃ and LaVO₃*, Phys. Rev. Lett. **93**, 176404 (2004)

- [85] M. Skoulatos, S. Toth, B. Roessli, M. Enderle, K. Habicht, D. Sheptyakov, A. Cervellino, P.G. Freeman, M. Reehuis, A. Stunault, G. J. McIntyre, L. D. Tung, C. Marjerrison, E. Pomjakushina, P. J. Brown, D. I. Khomskii, Ch. Rueegg, A. Kreyssig, A. I. Goldman and J. P. Goff, *Jahn–Teller versus quantum effects in the spin-orbital material* LaVO₃, Phys. Rev. B **91**, 161104(R) (2015)
- [86] K. I. Kugel and D. I. Khomskii, *Crystal structure and magnetic properties of the substances with orbital degeneracy*, Sov. Phys.—JETP **37**, 725 (1973)
- [87] D. I. Khomskii, K. I. Kugel, A. O. Sboychakov and S. V. Streltsov, *Role of Local Geometry in the Spin and Orbital Structure of Transition Metal Compounds*, J. Exp. Theor. Phys. **122**, 484 (2016)
- [88] M. G. Yamada, M. Oshikawa and G. Jackeli, *Emergent SU(4) Symmetry in α -ZrCl₃ and Crystalline Spin-Orbital Liquids*, Phys. Rev. Lett. **121**, 097201 (2018)
- [89] A. V. Ushakov, I. Solovyev and S. V. Streltsov, *Can the highly symmetric SU(4) spin-orbital model be realized in α -ZrCl₃?*, JETP Letters **112**, 642 (2020)
- [90] F. Krüger, S. Kumar, J. Zaanen and J. van den Brink, *Spin-orbital frustrations and anomalous metallic state in iron-pnictide superconductors*, Phys. Rev. B **79**, 054504 (2009)
- [91] R. M. Fernandes, A. V. Chubukov, J. Knolle, I. Eremin and J. Schmalian, *Preemptive nematic order, pseudogap, and orbital order in the iron pnictides*, Phys. Rev. B **85**, 024534 (2012)
- [92] R. Yu and Q. Si, *Orbital-Selective Mott Phase in Multiorbital Models for Alkaline Iron Selenides K_{1-x}Fe_{2-y}Se₂*, Phys. Rev. Lett. **110**, 146402 (2013)
- [93] K. Haule and G. Kotliar, *Coherence–incoherence crossover in the normal state of iron oxypnictides and importance of Hund’s rule coupling*, New Journal of Physics **11**, 025021 (2009)
- [94] I. V. Solovyev, *Spin-orbital superexchange physics emerging from interacting oxygen molecules in KO₂*, New J. Phys. **10**, 013035 (2008)

- [95] K. Wohlfeld, M. Daghofer and A. M. Oles, *Spin-orbital physics for p-orbitals in alkali RO₂ hyperoxides — generalization of the Goodenough–Kanamori rules*, EPL (Europhysics Letters) **96**, 27001 (2011)
- [96] S. V. Streltsov, A. O. Shorikov, S. L. Skornyakov, A. I. Poteryaev and D. I. Khomskii, *Unexpected 3+ valence or iron in FeO₂, a geologically important material lying “in between” oxides and peroxides*, Sci. Rep. **7**, 13005 (2017)
- [97] Kun Yang, S. Das Sarma and A. H. MacDonald, *Collective modes and skyrmion excitations in graphene SU(4) quantum Hall ferromagnets*, Phys. Rev. B **74**, 075423 (2006)
- [98] D. Castro Vaz, A. Barthélémy and M. Bibes, *Oxide spin-orbitronics: New routes towards low-power electrical control of magnetization in oxide heterostructures*, Jpn. J. Appl. Phys. **57**, 0902A4 (2018)
- [99] Y. Konishi, Zh. Fang, M. Izumi, T. Manako, M. Kasai, H. Kuwahara, M. Kawasaki, K. Terakura and Y. Tokura, *Orbital-State-Mediated Phase-Control of Manganites*, Journal of the Physical Society of Japan **68**, 3790 (1999)
- [100] J. Chakhalian, J. W. Freeland, H.-U. Habermeier, G. Cristiani, G. Khaliullin, M. van Veenendaal and B. Keimer, *Orbital Reconstruction and Covalent Bonding at an Oxide Interface*, Science **318**, 1114 (2007)