

Quantum Supermaps are Characterized by Locality

Matt Wilson^{1,2,3,4}, Giulio Chiribella^{1,2,5,6}, and Aleks Kissinger¹

¹Quantum Group, Department of Computer Science, University of Oxford

²HKU-Oxford Joint Laboratory for Quantum Information and Computation

³Programming Principles Logic and Verification Group, University College London London, UK

⁴Université Paris-Saclay, CNRS, ENS Paris-Saclay, Inria, CentraleSupélec, Laboratoire Méthodes Formelles

⁵QICI Quantum Information and Computation Initiative, School of Computing and Data Science, The University of Hong Kong

⁶Perimeter Institute for Theoretical Physics, Waterloo, Ontario N2L 2Y5, Canada

We provide a new characterisation of quantum supermaps in terms of an axiom that refers only to sequential and parallel composition. Consequently, we generalize quantum supermaps to arbitrary monoidal categories and operational probabilistic theories. We do so by providing a simple definition of *locally-applicable transformation* on a monoidal category. The definition can be rephrased in the language of category theory using the principle of naturality, and can be given an intuitive diagrammatic representation in terms of which all proofs are presented. In our main technical contribution, we use this diagrammatic representation to show that locally-applicable transformations on quantum channels are in one-to-one correspondence with deterministic quantum supermaps. This alternative characterization of quantum supermaps is proven to work for more general multiple-input supermaps such as the quantum switch and on arbitrary normal convex spaces of quantum channels such as those defined by satisfaction of signaling constraints.

1 Introduction

Beyond the framework of standard quantum theory, in which states representing physical degrees of freedom incur changes over time, there is the framework of higher order quantum theory [1–9], in which dynamics themselves are transformed by higher order operations termed supermaps [1]. Quantum supermaps were originally defined to formalise the notion of a higher order map S which may be applied to part of any two-input/two-output process ϕ , as in the following intuitive picture:

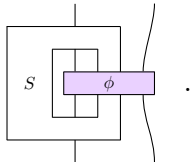

Matt Wilson: matthew.wilson@centralesupelec.fr

Giulio Chiribella: giulio.chiribella@cs.ox.ac.uk

Aleks Kissinger: aleks.kissinger@cs.ox.ac.uk

Such higher order operations were later generalised to act on constrained spaces, and were applied in the study of quantum information to analyze protocols in which quantum processes are treated as information-theoretic resources [10–25]. On top of providing a framework for formalising such protocols, supermaps are broad enough to incorporate higher order processes beyond those which can be interpreted as circuits with open holes [2, 26–33], the canonical example of such a supermap being the quantum switch [34]. Acting on the space of non-signaling channels, the quantum switch uses a qubit to control the order in which wires are joined and as depicted in the following intuitive picture

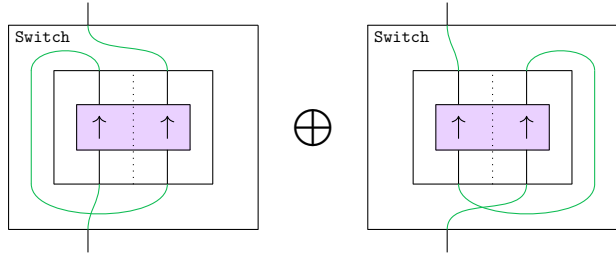

is often interpreted as a superposition of causal structures [34]. By being broad enough to incorporate examples such as the quantum switch, the supermap framework provides a way to study quantum causal structure as a resource in quantum information processing protocols [13–18, 22–24, 35–37], and furthermore may find application in the study of quantum gravity [38]. Indeed, the dependence of causal structure on mass distribution in general relativity and the possibility to superpose mass distributions in quantum theory, suggests the possibility of naturally occurring non-classical, or indefinite, causal structures [34, 39–49] such as those present in the quantum switch. To formalise this intuition supermaps can be interpreted as modelling global spacetime structures as maps from interventions chosen in local quantum laboratories to probabilities [40]. In this context, supermaps are typically expressed in the Choi representation, and are referred to as process matrices [40]. This abstract approach to modeling global spacetime structures allows to study causal structures beyond those which are even switch-like. These supermaps can sometimes break causal inequalities [40, 50–54], which are an analogue of Bell inequalities for causal order.

The motivating picture of a supermap appears to only reference the possibility to draw processes in quantum theory as boxes with multiple inputs and outputs, and yet, current constructions and definitions of quantum supermaps [1, 7, 40] rely on additional mathematical structures. These structures are typically those of categories into which deterministic quantum theories embed, such as compact closure/Choi-Jamiolkowski isomorphism [1, 7, 55] and convexity/coarse graining [40]. This suggests that supermaps are in need of a more principled axiomatisation, so that the conceptual grounds on which supermaps are understood match the formal grounds on which they are defined, and so that the entire framework of higher order quantum theory may be more easily lifted to arbitrary physical theories.

In this paper we provide such an axiomatisation, by building on the process-theoretic/categorical approach to quantum theory [56–61] we discover that supermaps can indeed be axiomatised purely at the process-theoretic level, that is, with respect to symmetric monoidal structure [62]. From this result it follows that all of the operational physical principles such as compatibility with coarse-graining, convex combinations, linearity, and tensor extensions used in usual definitions of quantum supermaps can be viewed as consequences a simple principle:

A supermap is the kind of function that can be applied locally.

The formalization of local applicability of supermaps that we use as our axiom can be understood in three consecutive steps. First, supermaps are functions on processes:

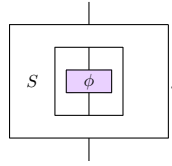

Second, supermaps are equipped with extensions to functions on all two-input/two-output processes:

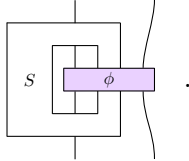

Third, localization is enforced by requiring that such functions commute with actions on their extensions:

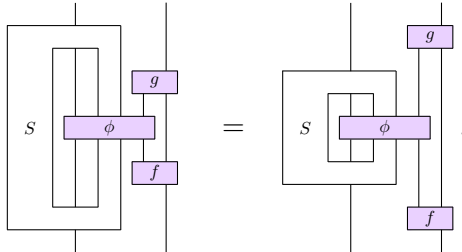

In other words, supermaps are maps that can be applied locally to parts of processes. In diagrams such as those above, the wires connected to S are those which S is interpreted as having acted on, the remaining wires represent the potential environments that might be present when the supermaps is implemented. We model these three principles for supermaps using a formal definition of *locally-applicable transformation*. The definition can be stated in entirely diagrammatic terms, and this diagrammatic phrasing is used throughout as a toolbox for proving our main theorem.

Theorem. *Quantum supermaps are in one-to-one correspondence with locally-applicable transformations.*

Although we do not do so in the main text, many of the definitions and results can be neatly phrased in the language of category theory [62]. First, the presented correspondence between locally-applicable transformations and standard-definition quantum supermaps is compositional, meaning that it can be phrased as an equivalence of categories [62]. Second, in the case of locally-well pointed theories such as quantum and classical information theory, the definition of locally-applicable transformation is simply that of a natural transformation between functors. As a consequence of this observation our main theorem can be summarised concisely as a categorical characterisation of supermaps on quantum theory:

Quantum supermaps are equivalent to natural transformations.

Specialised instances of such natural transformations can in fact already be observed as playing a similar role to supermaps in the field of monoidal category theory, for instance in the definition of a traced monoidal category [63,64] or similarly in the formalisation of closed time-like curves [65] where such curves are even termed super-operators.

The results presented in this paper show that the 2^{nd} -order of higher order quantum theory can be understood as a purely categorical/circuit-theoretic construction over 1^{st} -order quantum theory. A first key open question is whether similar methods can be used to reconstruct all of higher order quantum theory [1, 6, 7, 40] from purely compositional axioms. A second key open question, is whether this new axiomatization allows for easier generalisation of higher order quantum transformations to infinite dimensions and to non-monoidal physical frameworks. For instance supermaps have yet to be formalized within decompositional approaches to physics [66, 67] or algebraic quantum field theories [68] where localizability of standard quantum transformations is of primary importance [69–72] and infinite dimensionality is common. Ultimately, such further developments would bring the recently developed higher-order approach to the study of quantum causal structure closer to being applicable to theories of quantum gravity, where such structures have been predicted to play a key role [39].

2 Preliminary Material

To find a purely circuit-theoretic construction for supermaps we will need a notion of circuit-theory on which such a construction can be phrased. Here we present the model of circuit-theories as symmetric monoidal categories. We then review quantum supermaps, presenting them in terms of the graphical language for compact closed categories which captures the essence of the Choi-Jamiołkowski isomorphism [55]. Throughout this paper we use purple-shaded boxes to represent standard quantum processes, and white boxes to indicate parts of a diagram which should be interpreted as higher-order maps to be applied to standard processes.

Symmetric Monoidal Categories To ease the following presentation we present symmetric monoidal categories which are “strict”, meaning that equalities between objects are written in place of natural isomorphisms. For a formal treatment of non-strict symmetric monoidal categories the reader is referred to [62], where it is noted that every symmetric monoidal category is suitably equivalent to a strict one. We from now on omit use of the word strict, leaving it as implicit for the remainder of the paper. Our working examples of symmetric monoidal categories will be the categories \mathbf{QC} , \mathbf{CP} of quantum channels and completely positive maps respectively. We use the term quantum channel to mean completely positive trace-preserving map.

The first formal ingredient in the definition of a symmetric monoidal category \mathbf{C} is the specification of objects of \mathbf{C} , which in quantum theory may be thought of as systems. In symmetric monoidal categories objects can be drawn as wires, for instance we draw an object A as:

$$\begin{array}{c} | \\ \hline A \end{array}$$

Objects of each of \mathbf{QC} and \mathbf{CP} are given by finite dimensional Hilbert spaces, which are used to represent quantum degrees of freedom. The second formal ingredient of a symmetric monoidal category is the assignment of a set $\mathbf{C}(A, B)$ to each pair A, B of objects. The set $\mathbf{C}(A, B)$ will be referred to as the set of morphisms, and the elements $f \in \mathbf{C}(A, B)$ of this set are often denoted using the notation $f : A \rightarrow B$. Morphisms in symmetric monoidal categories can be drawn as boxes with input and output wires, used

to represent their input and output objects:



In **QC** the morphisms $f : H_A \rightarrow H_B$ are completely positive trace preserving maps from $\mathcal{L}(H_A)$ to $\mathcal{L}(H_B)$. Similarly, in **CP** the morphisms are taken to be completely positive maps. Symmetric monoidal categories are next equipped with two compatible notions, sequential composition and parallel composition. Sequential composition of $f : A \rightarrow B$ and $g : B \rightarrow C$ can be denoted graphically by:

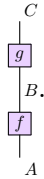

In quantum theory the sequential composition $g \circ f$ is typically interpreted as representing a process g occurring some time after a process f . In **QC** and **CP** the composition rule is inherited directly from the standard notion of sequential composition for linear maps.

Parallel composition addresses both objects and morphisms, for each pair of objects A, B a new object can be assigned called $A \otimes B$, typically interpreted as placing A next to B . For each pair of morphisms $f : A \rightarrow A'$ and $g : B \rightarrow B'$ one can assign a new morphism $f \otimes g : A \otimes B \rightarrow A' \otimes B'$ typically interpreted as the concurrent action of f and g . Diagrammatically $A \otimes B$ can be represented by placing wire A next to wire B :



The expression $f \otimes g$ can then be represented by the following diagram:

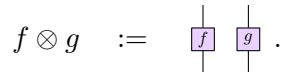

In our working examples the parallel composition of objects H_A, H_B is given by the standard tensor product $H_A \otimes H_B$ of finite dimensional Hilbert spaces. A key feature of symmetric monoidal categories which allows them a diagrammatic calculus is the interchange law

$$(f \circ f') \otimes (g \circ g') = (f \otimes g) \circ (f' \otimes g'),$$

which implies unambiguous interpretation of the following diagram:

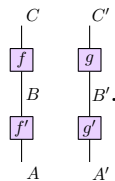

In a monoidal category the parallel composition is required to be associative so that $(A \otimes B) \otimes C = A \otimes (B \otimes C)$, this is indeed true for the tensor product of Hilbert spaces up to natural isomorphism $H_A \otimes (H_B \otimes H_C) \cong (H_A \otimes H_B) \otimes H_C$ as addressed in the introductory remarks. A monoidal category furthermore comes equipped with a notion of empty space given by an object I satisfying $A \otimes I = A = I \otimes A$, this object in our

motivating examples is given by the Hilbert space \mathbb{C} satisfying $H_A \otimes \mathbb{C} \cong H_A \cong \mathbb{C} \otimes H_A$ for every Hilbert space H_A . Making use of the notion of empty space I , the morphisms of type $\rho : I \rightarrow A$ are often interpreted states A . This is well motivated when I -wires are omitted from diagrams so that morphisms of type $I \rightarrow A$ are drawn as having only output wires:



Finally, a symmetric monoidal category comes equipped with a swap-morphism $\beta : A \otimes B \Rightarrow B \otimes A$ depicted by:



satisfying a variety of natural properties [62]. In the course of this paper, we will need to address two refined structures which supermaps are typically defined with respect to, those monoidal structures which are additionally causal and those which are additionally compact closed.

Causality: The Trace Channel A symmetric monoidal category is causal [56, 73] if its unit object is terminal, meaning in concrete terms that for each A the set $\mathbf{C}(A, I)$ is a singleton. In a causal symmetric monoidal category we typically represent the unique effect of type $A \rightarrow I$ using the discard symbol:



Our working example **QC** is a causal category, with the unique morphism of type $H_A \rightarrow \mathbb{C}$ given by the trace quantum channel. When a category is causal a direction of time is essentially fixed as propagating up the page. Indeed, with no way to vary between effects of type $\mathbf{C}(A, I)$ then there is no way to send information in the opposite direction, from the top of the page to the bottom.

Compact Closure: Channel-State Duality A symmetric monoidal category is compact closed if it is equipped for each A with an object A^* and morphisms $\cup_A : I \rightarrow A^* \otimes A$ and $\cap_A : A \otimes A^* \rightarrow I$ which amongst other natural conditions [56] satisfy $(\cap \otimes id) \circ (id \otimes \cup) = id$, graphically this reads as:

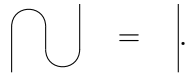

When compact closure is present it offers significant flexibility by giving an internalised way to connect input and output ports of circuit diagrams together. Our working example **CP** is a compact closed category with H_A^* given by the dual Hilbert space to H_A and the cup $\cup_{H_A} : \mathbb{C} \rightarrow H_A^* \otimes H_A$ given by the maximally entangled Bell-state. Similarly the cap is given by the maximally entangled Bell-effect. The Choi-isomorphism [55], which provides an identification between completely positive maps and positive operators, is given by applying completely positive maps to Bell-states and so can be expressed graphically as:

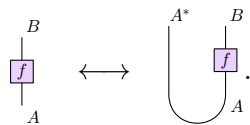

Additive Structure The symmetric monoidal category \mathbf{CP} is equipped with a notion of closure under positive linear combination, for any pair $\phi_0, \phi_1 \in \mathbf{CP}(A, A')$ of completely positive maps and pair $a_0, a_1 \in \mathbb{R}_+$ of positive real numbers a new combined completely positive linear map $a_0\phi_0 + a_1\phi_1 \in \mathbf{CP}(A, A')$ can be constructed. The symmetric monoidal category \mathbf{QC} inherits a more restricted form of closure from \mathbf{CP} termed closure under convex combinations, meaning that for any pair $\phi_0, \phi_1 \in \mathbf{QC}(A, A')$ of quantum channels and any probability $p \in [0, 1]$ then the linear combination $p\phi_0 + (1-p)\phi_1 \in \mathbf{QC}(A, A')$ is itself a quantum channel.

Constrained Spaces In this paper, beyond supermaps on entire channels, we will aim to reconstruct supermaps which can be applied to channels satisfying signalling constraints [74, 75]. These quantum supermaps are the part of the higher-order toolbox typically used to study quantum causal structure. Let us begin with a simple example of a signalling constraint given by the specification of the set of one-way signaling channels, we denote the statement that ϕ be a one-way signaling channel by:

$$\begin{array}{c} | \\ \hline \phi \\ \hline | \end{array} \in \mathcal{E}_{sig}\left(\begin{array}{c} \uparrow \nearrow \uparrow \\ | \end{array}\right).$$

The depicted graph indicates that ϕ may not transmit information from the bottom right wire to the top left wire, this constraint is expressed concretely by the existence of a channel ϕ' satisfying the following equation:

$$\begin{array}{c} \ddagger \\ | \\ \hline \phi \\ \hline | \end{array} = \begin{array}{c} | \\ \hline \phi' \\ \hline | \end{array} \begin{array}{c} \ddagger \\ | \\ \hline \cdot \\ \hline | \end{array}.$$

In general more complex signalling constraints can be encoded by relations [76, 77]. For instance the statement

$$\begin{array}{c} | \\ | \\ | \\ \hline \phi \\ \hline | \\ | \\ | \end{array} \in \mathcal{E}_{sig}\left(\begin{array}{c} \nearrow \nearrow \nearrow \nearrow \nearrow \\ \searrow \searrow \searrow \searrow \searrow \\ | \end{array}\right),$$

can be used to encode the statements

$$\begin{array}{c} \ddagger \\ \ddagger \\ | \\ | \\ | \\ \hline \phi \\ \hline | \\ | \\ | \end{array} = \begin{array}{c} | \\ | \\ | \\ \hline 1 \\ \hline | \\ | \\ | \end{array}, \quad \text{and} \quad \begin{array}{c} | \\ | \\ | \\ \hline \phi \\ \hline | \\ | \\ | \end{array} = \begin{array}{c} | \\ | \\ | \\ \hline 2 \\ \hline | \\ | \\ | \end{array} \begin{array}{c} \ddagger \\ | \\ \hline \cdot \\ \hline | \end{array}.$$

A formal definition for arbitrary relations is given in [77]. Useful for our reconstruction will be the observation that for any relation τ the set $\mathcal{E}_{sig}(\tau)$ of processes satisfying constraint τ has the convenient property of being closed under convex combinations. Another convenient property of signaling constraints in quantum theory for our reconstruction is their equivalence to localizability constraints, which we refer to here as pathing constraints so as to not confuse with our main definition of local applicability. As an example of a pathing constraint, the one-way signalling condition in quantum theory is equivalent to requiring the following decomposition:

$$\begin{array}{c} | \\ | \\ \hline \phi \\ \hline | \end{array} = \begin{array}{c} | \\ | \\ \hline 2 \\ \hline | \\ | \\ \hline 1 \\ \hline | \end{array}.$$

This decomposition abstracts the impossibility of signalling from the bottom right wire to the top left wire by forbidding the existence of a vertically directed path between them. Since in quantum theory pathing constraints are equivalent to signaling constraints [74], pathing constraints in quantum theory are also closed under convex combinations. Pathing constraints come with the advantage however that they can be phrased in arbitrary symmetric monoidal categories without reference to a prioritised effect or time-direction. In intuitive terms pathing constraints abstract from causality to compositionality, as an example of a more complex pathing constraint consider the statement:

$$\begin{array}{c} | \\ | \\ | \\ \hline \phi \\ \hline | \\ | \\ | \end{array} \in \mathcal{E}_{path}(\uparrow\downarrow\uparrow\downarrow\uparrow\downarrow\uparrow\downarrow),$$

this is a concise encoding of the statement that ϕ can be decomposed in such a way as to not provide a vertically directed path from the left-most input to the right-most output, or vice-versa, I.E

$$\begin{array}{c} | \\ | \\ | \\ \hline \phi \\ \hline | \\ | \\ | \end{array} = \begin{array}{c} | \\ | \\ | \\ \hline 1 \\ \hline | \\ | \\ | \end{array} \begin{array}{c} | \\ | \\ | \\ \hline 2 \\ \hline | \\ | \\ | \end{array} \quad \text{and} \quad \begin{array}{c} | \\ | \\ | \\ \hline \phi \\ \hline | \\ | \\ | \end{array} = \begin{array}{c} | \\ | \\ | \\ \hline 4 \\ \hline | \\ | \\ | \end{array} \begin{array}{c} | \\ | \\ | \\ \hline 3 \\ \hline | \\ | \\ | \end{array} .$$

The equality $\mathcal{E}_{path}(\tau) = \mathcal{E}_{sig}(\tau)$ will allow us to reconstruct quantum supermaps on signaling constraints as locally-applicable transformations applied to their corresponding pathing constraints. Phrased in this way the quantum supermaps used to study quantum causal structure, are recovered from entirely compositional definitions with no reference to causality or chosen direction of the flow of time.

Extended Process Sets In this paper we will be often concerned with extending sets of processes to auxiliary systems. For a channel to be treated as an extension of channels from some set, one ought to expect that no internal local dynamics on the auxiliary extended systems should be able to change that fact. Consequently we introduce the following minimum requirement for extensions of a set K .

Definition 1. A family of sets $K_{X,X'} \subseteq \mathbf{C}(A \otimes X, A' \otimes X')$ is an extension set for $K \subseteq \mathbf{C}(A, A')$ if $K_{I,I'} = K$ and for every $\phi \in K_{X,X'}$, $f : Y \rightarrow X \otimes E$, and $g : X' \otimes E \rightarrow Y'$ then

$$\begin{array}{c} | \\ | \\ | \\ \hline \phi \\ \hline | \\ | \\ | \end{array} \begin{array}{c} | \\ | \\ | \\ \hline g \\ \hline | \\ | \\ | \end{array} \begin{array}{c} | \\ | \\ | \\ \hline f \\ \hline | \\ | \\ | \end{array} \in K_{Y,Y'}.$$

The examples we will make use of in the following text are those given by *dilation extension*. The principle is to define, for any set $K \subseteq \mathbf{C}(A, A')$ and pair X, X' , the extension by X, X' of K to be the set of all processes $\phi \in \mathbf{C}(A \otimes X, A' \otimes X')$ which are stinespring dilations of processes of K .

Definition 2. For each $K \subseteq \mathbf{C}(A, A')$ and pair (X, X') the dilation extension by X, X' denoted $\mathbf{dExt}_{X,X'}(K)$ is the subset of $\mathbf{C}(A \otimes X, A' \otimes X')$ given by:

$$\phi \in \mathbf{dExt}_{X,X'}[K] \iff \forall \rho, \sigma : \begin{array}{c} | \\ | \\ | \\ \hline \phi \\ \hline | \\ | \\ | \end{array} \begin{array}{c} | \\ | \\ | \\ \hline \sigma \\ \hline | \\ | \\ | \end{array} \begin{array}{c} | \\ | \\ | \\ \hline \rho \\ \hline | \\ | \\ | \end{array} \in K.$$

Note that for the example $K = \mathbf{C}(A, A')$ then the extension $\mathbf{dExt}_{X, X'}(K)$ returns the entire set of two-input/two-output morphisms $\mathbf{C}(A \otimes X, A' \otimes X')$ ¹. For a causal symmetric monoidal category the extended set can be rephrased in the following way:

$$\phi \in \mathbf{dExt}_{X, X'}[K] \iff \forall \rho : \begin{array}{c} | \\ \text{---} \phi \text{---} \\ | \end{array} \begin{array}{c} \oplus \\ | \\ \rho \end{array} \in K,$$

which is the form used in [34] to define extensions to subsets of quantum channels. In the appendix we note that such extended channel sets can be viewed in categorical language as functors into the category of sets. Whenever a subset $K \subseteq \mathbf{QC}(A, A')$ is closed under convex combinations then it follows that $\mathbf{dExt}_{X, X'}(K)$ is closed under convex combinations, we will from now on rephrase the statement that a set K be closed under convex combinations as simply the statement that K be convex.

Before moving on a quick comment regarding dilation extensions is that they are better suited to OPT-like categories than categories of pure reversible evolutions such as the category of unitaries. This is because in a category with no states and effects, the dilation extension of any set will be given by $\mathbf{C}(A \otimes X, A' \otimes X')$ ².

Quantum Supermaps: Standard Definition In this paper we use the category \mathbf{CP} of completely positive maps to express the definition of supermap, this is sufficient for our purposes since the sets we choose to work with are internal [3, 34]. We follow the presentation of [7] in which a completely positive linear map

$$\begin{array}{c} B^* \ B' \\ | \ | \\ \boxed{S} \\ | \ | \\ A^* \ A' \end{array},$$

is informally interpreted as a diagram with a hole, a function which accepts a channels of type $A \rightarrow A'$ and returns a channel of type $B \rightarrow B'$ by using compact closure or Choi-Jamiolkowski isomorphism [55]

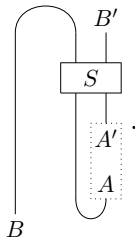

This notation puts us in a position to concisely phrase the standard definition method for quantum supermaps.

Definition 3. Let $\mathbf{C} \subseteq \mathbf{P}$ be an inclusion³ of a symmetric monoidal category \mathbf{C} into a compact closed category \mathbf{P} and let $K_{-,=}$ and $M_{-,=}$ be extension sets for $K \subseteq \mathbf{C}(A, A')$

¹It is natural to wonder whether this holds in the case in which a symmetric monoidal category has no states or effects, in-fact it does so vacuously (since the requirement is that a conditions be satisfied for-all such states and effects.).

²This follows for the same reasons given in the previous footnote.

³To relax inclusion to existence of a faithful symmetric strong monoidal functor; pictorially, just requires wrapping ϕ in a monoidal functor box.

and $M \subseteq \mathbf{C}(B, B')$ respectively. A \mathbf{P} -supermap on \mathbf{C} of type $S : K_{-,=} \rightarrow M_{-,=}$ is a morphism in \mathbf{P} of type $S : A^* \otimes A' \rightarrow B^* \otimes B'$ such that for every $\phi \in K_{X, X'}$ then

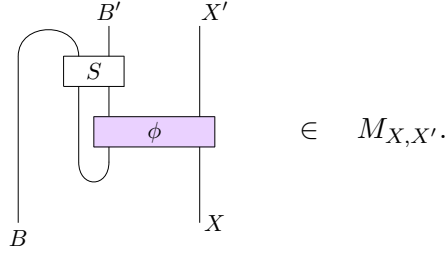

In short \mathbf{P} -supermaps are processes from \mathbf{P} which can act on processes from \mathbf{C} . Furthermore, in the spirit of the axiomatic definition of completely positive trace preserving maps, it is required that the \mathbf{P} -supermap sends processes from \mathbf{C} to processes from \mathbf{C} even when acting only on part of the process.

\mathbf{P} -supermaps can be composed in sequence, with this sequential composition inherited directly from \mathbf{P} , in categorical terms this means that the \mathbf{P} -supermaps define a category $\mathbf{Psup}[\mathbf{C}]$. For brevity we will use the term “quantum supermap” for \mathbf{CP} -supermap on \mathbf{QC} and denote $\mathbf{CPsup}[\mathbf{QC}]$ by \mathbf{QS} . Note that we are working with quantum supermaps applied to arbitrary subsets here, including those which satisfy signalling constraints. For the study of indefinite causal structure the most prevalent example is that of supermaps on non-signalling channels and their dilation extensions:

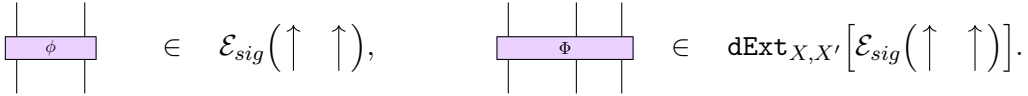

The lack of communication between wires in such channels allows them to be combined in a variety of ways without producing time-loops, so that the output may still be guaranteed to be a deterministic channel. Quantum supermaps of type⁴

$$\mathbf{dExt}_{-,=}[\mathcal{E}_{sig}(\uparrow \uparrow)] \rightarrow \mathbf{C}(A \otimes -, Q \otimes A \otimes =)$$

which have been the subject of considerable study are switches, which take channels and by reference to a control state, plug them together in a combination of orders:

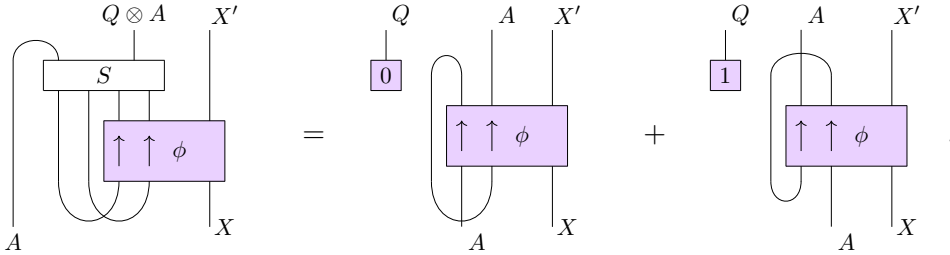

Note that when the above diagrams are drawn in the category \mathbf{CP} they really represent classical mixtures of causal orders. Instead, if one interprets the above diagram in \mathbf{fHilb} and then embeds into \mathbf{CP} via the usual doubling functor with $\mathcal{F}(f)(\rho) := f(\rho)f^\dagger$ then interference is included and indeed what is recovered is the *quantum* switch.

Finally, in the literature it is common to think of switches (and in general the supermaps on the non-signalling channels) as being multi-party. That is, rather than thinking of them as having one constrained input (the constraint being that of no-signalling),

⁴We use the symbols - and = to denote free-variables

they are thought of (and usually pictorially depicted) as having many unconstrained inputs. Correspondingly, the informal intuitive picture that one should keep in mind for such maps is the following

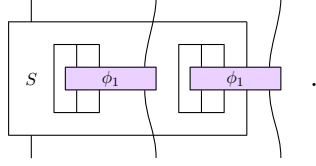

Again, when a theory comes equipped with an inclusion $\mathbf{C} \subseteq \mathbf{P}$ into a compact closed category one can find a more direction axiomatisation of such supermaps. We refer to a supermap as multi-party when we think of it's input type as a list, as in the following definition.

Definition 4. Let $\mathbf{C} \subseteq \mathbf{P}$ be an inclusion of a symmetric monoidal category \mathbf{C} into a compact closed category \mathbf{P} , and let $K_{X,X'}^i \subseteq \mathbf{C}(A \otimes X, A' \otimes X')$, a morphism

$$\begin{array}{c} B^* B' \\ \hline S \\ \hline A_1^* \dots A_n^* \quad A_1' \dots A_n' \end{array},$$

in \mathbf{P} is a \mathbf{P} -supermap on \mathbf{C} of type $S : K_{-,=}^1 \dots K_{-,=}^n \rightarrow M_{-,=}$ if and only if for every family $\phi_i \in K_{X_i, X_i'}$ then

$$\in M_{X_1 \otimes \dots \otimes X_n, X_1' \otimes \dots \otimes X_n'}.$$

Note that we can (as we have above) allow each of the independent inputs in the list to actually be constrained sets of processes, from now on we will keep in mind the case in which each input is unconstrained so that supermaps are required to be processes in \mathbf{P} which are well-behaved on the space of all product channels. The supermaps on the non-signalling channels are indeed the same as supermaps on the product channels, this can be seen for instance in the definition of the non-signalling channels as the double closure of the set of products of channels [7]), meaning that in the case of quantum theory (and classical theory too), then the multi-party supermaps are equivalent to the supermaps on the space of non-signalling channels.

Summary In quantum information theory, supermaps on quantum channels are defined by using channel state duality (compact closure) of the theory of completely positive maps into which they embed. In this paper we ask the following: *What can we say when background compact closure cannot be assumed?* In other words: *Can supermaps be characterized in terms of sequential and parallel composition alone?* We answer positively, showing that quantum supermaps could have been defined all along by an abstract principle of local applicability (in category-theoretic language termed naturality). After motivating and defining locally-applicable transformations on arbitrary symmetric monoidal categories we show a one-to-one correspondence between them and quantum supermaps when applied to the symmetric monoidal category of quantum channels.

3 Formalisation of Local Applicability

Our goal is to find an axiom for quantum supermaps which can be applied to *any* symmetric monoidal category. In this section we show how to do so, by defining higher order functions and requiring the existence of extensions for all auxiliary systems which further commute with actions on those auxiliary systems. We begin by warming up to the definition by observing a notion of local applicability present in monoidal categories, such as standard quantum theory, which we plan to abstract to higher order functions.

Local Applicability in Standard Quantum Theory The category **QC** of quantum channels is a symmetric monoidal category, one consequence of the parallel composition rule $f \otimes g$ is that it gives a way to view any $f : A \rightarrow A'$ as locally applicable in an intuitive sense. We discuss this locality principle in the monoidal setting and then comment on how it can be abstracted to a statement about locality of functions built from such an f on state sets. To begin, consider a channel $f : A \rightarrow A'$ from A to A' :

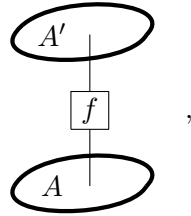

whenever A can be viewed as part of a larger system $N = A \otimes X$ then f can be locally applied to N by using $f \otimes id_X : N \rightarrow A' \otimes X$

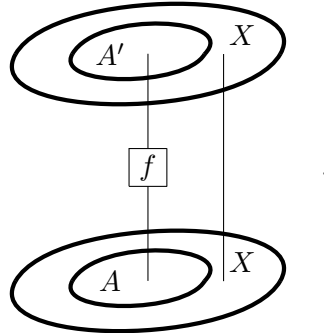

Crucial to the interpretation of locality in $f \otimes id_X$ is that $f \otimes id_X$ commutes with all actions on X , this follows in this case by the interchange law for monoidal categories $(f \otimes id_{X'}) \circ (id_A \otimes g) = (id_{A'} \otimes g) \circ (f \otimes id_X)$:

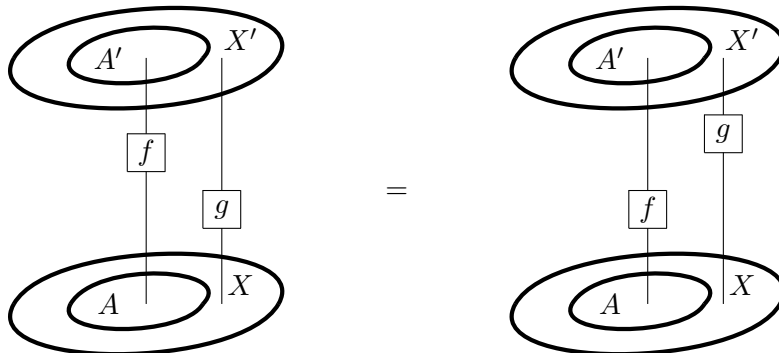

In other words, a general monoidal category gives a collection of morphisms, all of which can be viewed as being locally applicable, in an informal sense.

A consequence of this local applicability is the possibility to construct from f a family of functions on states $l(f)_X : \mathbf{C}(I, A \otimes X) \rightarrow \mathbf{C}(I, A' \otimes X)$ which exhibit the local applicability of f . Explicitly, by using tensor extensions with the identity the function $l(f)_X(\rho_{AX}) := (f \otimes id_X)(\rho_{AX})$ can be defined for each X . The abstract functions $l(f)_X$ which represent the action of f on states indeed inherit a notion of local applicability from f . The functions $l(f)_X$ can be seen to leave the environment system X untouched in the sense that the action of any g on X commutes with the application of the function $l(f)_X$. The above sentence is captured in formal terms by the equation $l(f)_{X'}(id_A \otimes g(\rho_{AX})) = (id_{A'} \otimes g)(l_X(\rho_{AX}))$ which is guaranteed to hold for any $g : X \rightarrow X'$ since

$$\begin{aligned} l(f)_{X'}(id_A \otimes g(\rho_{AX})) &= (f \otimes id_{X'}) \circ (id_A \otimes g)(\rho_{AX}) \\ &= (id_{A'} \otimes g) \circ (f \otimes id_X)(\rho_{AX}) \\ &= (id_{A'} \otimes g)(l_X(\rho_{AX})) \end{aligned}$$

We now give an axiom which re-characterises quantum supermaps by generalizing this concept of local applicability of functions on states to local applicability of functions on processes. The only instances of locally-applicable transformations on quantum channels will turn out to be those which are simulated by the standard-definition quantum supermaps of [1]. We split the motivations for the definition of locally-applicable transformation into three consecutive principles.

Principle 1: Supermaps are Functions on Processes The kind of picture usually drawn with the aim of capturing diagrammatically the concept of a supermap from the space of processes $\mathbf{C}(A, A')$ to the space of processes $\mathbf{C}(B, B')$ is some variation of the following

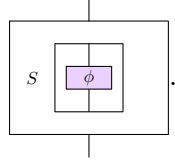

As such our first step to characterising supermaps of type $\mathbf{C}(A, A') \rightarrow \mathbf{C}(B, B')$ is to consider functions of the same type $\mathbf{C}(A, A') \rightarrow \mathbf{C}(B, B')$. More generally for $K \subseteq \mathbf{C}(A, A')$ and $M \subseteq \mathbf{C}(B, B')$ the first step is to consider functions $S : K \rightarrow M$ from the set K to the set M .

Principle 2: Supermaps Can be Extended to Functions on all two-input/two-output Processes When we say that we wish for the map $S : \mathbf{C}(A, A') \rightarrow \mathbf{C}(B, B')$ to be locally applicable, we mean that we wish to formalise the following picture:

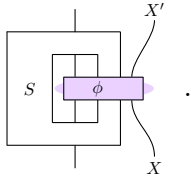

The next step toward such a formalisation is to specify for each X, X' the action of S when applied to the A, A' part of any morphism $\phi \in \mathbf{C}(A \otimes X, A' \otimes X')$. Consequently we say that a locally-applicable transformation must be equipped with a family of extended

functions $S_{X,X'} : \mathbf{C}(A \otimes X, A' \otimes X') \rightarrow \mathbf{C}(B \otimes X, B' \otimes X')$ for every X, X' . For the generalised case of supermaps of type $S : K \rightarrow M$ we instead require the specification of a function $S_{X,X'} : K_{X,X'} \rightarrow M_{X,X'}$ for every X, X' with $K_{X,X'}$ some extension set for K and similarly for M . For readability we will from now on notate the action of such a family of functions in the following way

$$S_{X,X'}(\phi) := \begin{array}{c} \begin{array}{|c|} \hline X' \\ \hline \begin{array}{|c|} \hline S_{X,X'} \\ \hline \begin{array}{|c|} \hline \phi \\ \hline X \\ \hline \end{array} \\ \hline \end{array} \\ \hline X \\ \hline \end{array}, \end{array}$$

where the dotted lines express the idea that the wires they connect are to be interpreted as auxiliary systems. Formally, the dotted lines simply allow us to denote diagrammatically which systems are the X and X' of $S_{X,X'}$. Conceptually, the dotted wires for X, X' are intended to indicate that $S_{X,X'}$ ought not act on them. At this moment of the formalization however, we have not constrained the kind of function that each $S_{X,X'}$ can be, and so we now need to find a mathematical condition on these formal diagrams which encodes this concept.

Principle 3: Supermaps Commute With Actions on Their Extensions A key feature of a local operation is commutation with operations applied to auxiliary spaces, we generalise this notion of locality to input-output operations, informally we aim to capture the equivalence of the following two pictures:

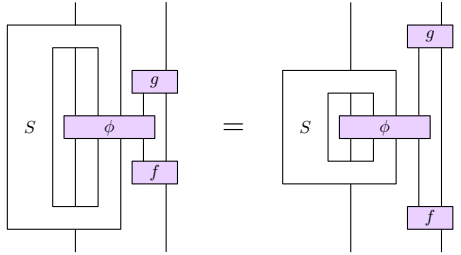

which can be formalised for functions on simple types $\mathbf{C}(A, A') \rightarrow \mathbf{C}(B, B')$ or on generalised types $K \rightarrow M$.

Definition 5 (locally-applicable transformations). *Let $K_{-,=}$ and $M_{-,=}$ be extension sets, a locally-applicable transformation of type $S : K_{-,=} \rightarrow M_{-,=}$ on a symmetric monoidal category \mathbf{C} is a family of functions $S_{X,X'} : K_{X,X'} \rightarrow M_{X,X'}$ such that for every $g : X' \otimes Z \rightarrow Y'$, $f : Y \rightarrow X \otimes Z$, and $\phi : A \otimes X \rightarrow A' \otimes X'$ then*

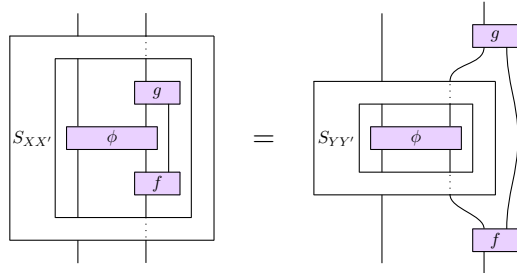

The above definition is equivalent to the requirement of the following distinct rules of *naturality*

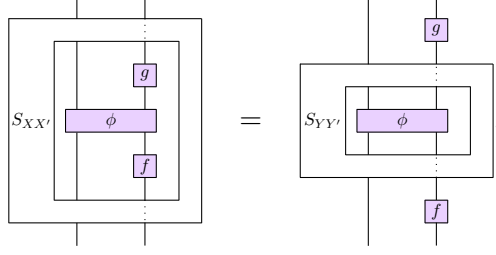

and *dragging*

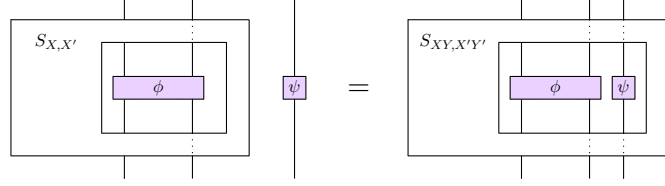

where in the specific case of interest of the category \mathbf{QC} of quantum channels, only the first condition need actually be given, since for all causal ρ we have the following equation by naturality:

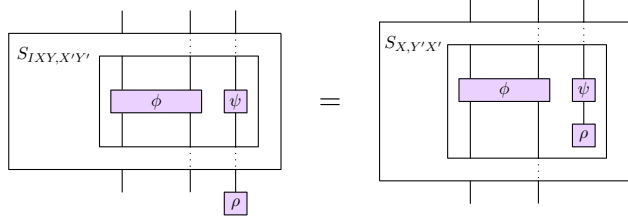

and following further equations, again by naturality:

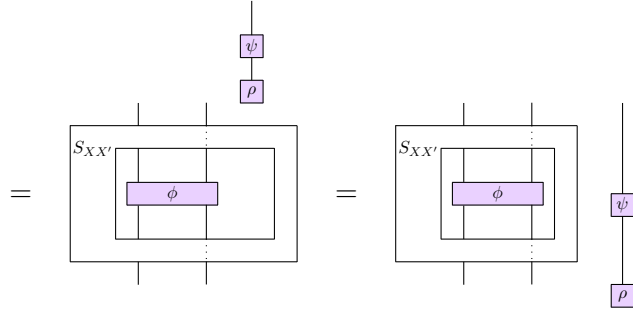

Together these entail box-dragging since quantum theory has *enough causal states* [7]. In the appendix we note that consequently locally-applicable transformations on \mathbf{QC} can be phrased in the language of category theory as natural transformations, motivating our use of the word “naturality”. We further note that locally-applicable transformations can be composed, given locally-applicable transformations $S : K_{-,=} \rightarrow M_{-,=}$ and $T : M_{-,=} \rightarrow N_{-,=}$ one can construct the locally-applicable transformation $(T \circ S) : K_{-,=} \rightarrow N_{-,=}$ by defining for each X, X' the functions $(S \circ T)_{XX'}(\phi) = S_{XX'}(T_{XX'}(\phi))$. This compositionality of locally-applicable transformations can be phrased in the language of category theory by stating that they form a category, which we denote by $\mathbf{lot}[\mathbf{C}]$.

4 Examples

We now consider a series of constructive examples of supermaps beginning with those which can be guaranteed to exist on *any* symmetric monoidal category \mathbf{C} . We begin with

combs in arbitrary symmetric monoidal categories as defined in [78].

Example 1 (Combs). For every symmetric monoidal category \mathbf{C} and pair of morphisms $a : A \rightarrow E \otimes B$ and $b : E \otimes A' \rightarrow B'$ one can define a locally-applicable transformation of type $\mathbf{C}(A-, A' =) \rightarrow \mathbf{C}(B-, B' =)$ by

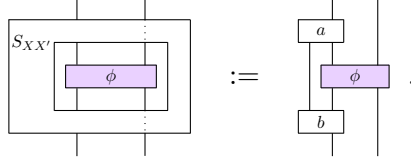

Indeed, note that:

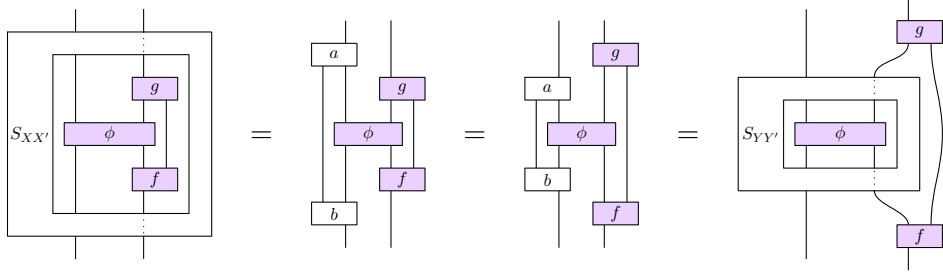

We from now on refer to such a locally-applicable transformation by $\text{comb}[a, b]$ and its components by $\text{comb}[a, b]_{X, X'}$, such combs form a subcategory of $\mathbf{lot}[\mathbf{C}]$ which is isomorphic as a category to $\mathbf{comb}[\mathbf{C}]$ as defined in [33]. This example can be generalised to combs of type $\text{comb}[a, b] : K_{-,=} \rightarrow M_{-,=}$ which are those which furthermore satisfy $\phi \in K_{X, X'} \implies \text{comb}(a, b)(\phi) \in M_{X, X'}$. These examples can be further generalised to combs from categories into-which \mathbf{C} embeds, as opposed to combs from \mathbf{C} itself.

Example 2. For every pair \mathbf{C}, \mathbf{D} of symmetric monoidal categories with $\mathbf{C} \subseteq \mathbf{D}$ one can define the \mathbf{D} -combs on \mathbf{C} of type $K \rightarrow M$ to be the combs of \mathbf{D} which preserve morphisms of \mathbf{C} . Formally, that is, the transformations of type $\text{comb}[a, b]$ on \mathbf{D} such that for all $\phi \in K_{X, X'}$ then $\text{comb}[a, b]_{X, X'}(\phi) \in M_{X, X'}$.

For a compact closed category \mathbf{P} with $\mathbf{C} \subseteq \mathbf{P}$ the notions of \mathbf{P} -supermap and \mathbf{P} -comb on \mathbf{C} are equivalent. Through this equivalence, \mathbf{P} -supermaps always give examples of locally-applicable transformations.

Lemma 1. Let \mathbf{P} be a compact closed category and \mathbf{C} be a symmetric monoidal category, there is a one-to-one correspondence between the \mathbf{P} -combs on \mathbf{C} and the \mathbf{P} -supermaps on \mathbf{C} .

Proof. Let S be a \mathbf{P} -comb on \mathbf{C} of type $K_{-,=} \rightarrow M_{-,=}$ then one can construct

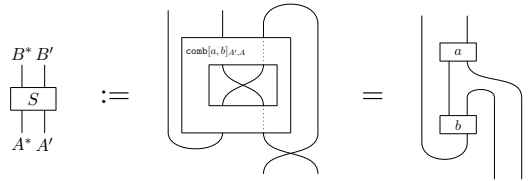

which indeed is a \mathbf{P} -supermap since

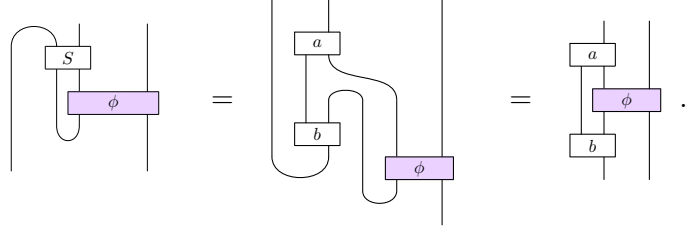

Instead let S be a \mathbf{P} -supermap then one can construct the locally-applicable transformation

$$\mathcal{F}(S)_{X,X'} := \text{diagram with } S \text{ and } \phi \text{ boxes and wires } .$$

These two constructions are furthermore inverse to each-other. The assignment is furthermore a functor $\mathcal{F}_{\mathbf{P},\mathbf{C}} : \mathbf{P}\text{sup}[\mathbf{C}] \rightarrow \mathbf{lot}[\mathbf{C}]$ meaning in concrete terms that \mathcal{F} preserves composition and identities. \square

The above story and equivalence between supermaps made with combs or morphisms with compact closure can be generalised to embeddings which are weak in the sense of 2-category theory, a discussion of this point is given in the appendix, where it is noted that this generalisation allows to use the compact-closed category $\ast\mathbf{Hilb}$ [79] to define a variety of locally-applicable transformations on \mathbf{sepU} , the category of unitaries between separable Hilbert spaces.

Locally-applicable transformations in short state a bare-minimum requirement expected of quantum supermaps, satisfied by a variety of more familiar examples. A clear difficulty in the definition of supermaps, is the variety of potential definition methods. By using the unifying principle of a locally-applicable transformation, as a minimum requirement for supermaps, we will in fact find that all possible definitions of supermaps on finite dimensional quantum theory are equivalent by characterizing all locally-applicable transformations on \mathbf{QC} as quantum supermaps, by which we mean \mathbf{CP} -supermaps on \mathbf{QC} .

5 Characterisation of Standard Quantum Supermaps

We now prove that locally-applicable transformations on finite dimensional quantum channels are equivalent to standard-definition quantum supermaps. We have already proven that all quantum supermaps define locally-applicable transformations, so what remains is to prove that this assignment can be inverted, that every locally-applicable transformation defines quantum supermap. We begin by identifying a key feature of quantum theory, the existence of control for convex sets. We then give our proof in three steps, proving inheritance of convex linearity for locally-applicable transformations on convex sets, proving their unique extension to action on completely positive maps, and finally proving their realisation in terms of standard quantum supermaps. We begin by addressing the property of control.

Definition 6 (Control). *A set K has control if for every pair $\phi_0, \phi_1 \in \mathbf{dExt}_{X, X'}(K)$ there exists $\phi \in \mathbf{dExt}_{X \otimes Y, X' \otimes Y'}(S)$ and a pair of states ρ_0, ρ_1 such that:*

$$\begin{array}{c} | \\ | \\ \hline \phi \\ \hline | \\ \rho_1 \end{array} = \begin{array}{c} | \\ | \\ \hline \phi_1 \\ \hline | \end{array}.$$

Conveniently convex sets in \mathbf{QC} are always controlled, in fact the existence of control is equivalent to asking for closure under convex combinations.

Lemma 2. *A set $K \subseteq \mathbf{QC}(A, A')$ has control if and only if it is convex.*

Proof. We begin by showing that whenever K is convex it has control. Note that whenever K is convex then $\mathbf{dExt}_{X, X'}(K)$ is convex for every choice of X and X' . Now choose a pair of states $\rho_0, \rho_1 \in \mathbf{QC}(I, Y)$ on an object Y which are distinguishable in the sense that there exist effects $e_0, e_1 \in \mathbf{CP}(Y, I)$ satisfying $e_i \circ \rho_j = \delta_{ij}$ and then construct the following process ϕ

$$\begin{array}{c} | \\ | \\ \hline \phi \\ \hline | \\ | \end{array} := \begin{array}{c} | \\ | \\ \hline \phi_0 \\ \hline | \\ e_0 \end{array} + \begin{array}{c} | \\ | \\ \hline \phi_1 \\ \hline | \\ e_1 \end{array},$$

certainly by inserting ρ_0, ρ_1 into the rightmost wire the channels ϕ_0, ϕ_1 are recovered, what remains is to show that ϕ is in $\mathbf{dExt}_{X, X'}(K)$. Indeed consider checking the reduction of ϕ given by applying an arbitrary state and effect of \mathbf{QC} to its auxiliary wires, given that \mathbf{QC} is causal this is given by:

$$\begin{array}{c} | \\ | \\ \hline \phi_0 \\ \hline | \\ \tau \end{array} \overset{\text{tr}}{\circlearrowleft} e_0 + \begin{array}{c} | \\ | \\ \hline \phi_1 \\ \hline | \\ \tau \end{array} \overset{\text{tr}}{\circlearrowleft} e_1$$

for some ρ . Now note that each of the post selected states is a normalised state equipped with a probability, for instance:

$$\begin{array}{c} | \\ | \\ \hline e_0 \\ \hline | \\ \tau \end{array} = \begin{array}{c} | \\ | \\ \hline \tau \\ \hline | \\ e_0 \end{array} \times \frac{1}{\begin{array}{c} | \\ | \\ \hline e_0 \\ \hline | \\ \tau \end{array}} \times \begin{array}{c} | \\ | \\ \hline e_0 \\ \hline | \\ \tau \end{array} = p(e_0|\tau) \times \tau_{|0}$$

and similarly for e_1 . Since ϕ_0, ϕ_1 are elements of $\mathbf{dExt}_{X, X'}(K)$ it then follows from the above that the reduction of ϕ is a convex combination of elements of K , explicitly the application of arbitrary state and effect to ϕ returns:

$$p(e_0|\tau) \begin{array}{c} | \\ | \\ \hline \phi_0 \\ \hline | \\ \tau_{|0} \end{array} + p(e_1|\tau) \begin{array}{c} | \\ | \\ \hline \phi_1 \\ \hline | \\ \tau_{|1} \end{array}$$

where $p(e_0|\tau) + p(e_1|\tau) = 1$. We now check the converse, that when K has control it is convex. Indeed, for any $\phi_0, \phi_1 \in K$ choose their control operation $\phi \in \mathbf{dExt}_{Y, I}(K)$. Consider an arbitrary convex combination $p\phi_0 + (1-p)\phi_1$, this combination is given by inserting $\sigma := p\rho_0 + (1-p)\rho_1$ into the wire Y of ϕ . Since ϕ is in $\mathbf{dExt}_{Y, I}$ then insertion of σ into ϕ must return an element of K and so it follows that the convex combination $p\phi_0 + (1-p)\phi_1$ is an element of K . \square

This equivalence is noted to furthermore hold for classical information theory in the appendix, by an identical proof method. We finish by stating a definition we will find convenient to reference later.

and so an arbitrary convex combination $p\phi_o + (1-p)\phi_1$ can be written as

$$p\phi_o + (1-p)\phi_1 = \begin{array}{c} \text{---} \\ | \\ \boxed{\phi} \\ | \\ \rho_p \end{array},$$

with $\rho_p := p\rho_o + (1-p)\rho_1$. Writing $p_1 = (1-p)$, then $S_{X,X'}(p_0\phi_0 + p_1\phi_1)$ is given using naturality by:

$$\begin{array}{c} \text{---} \\ | \\ \boxed{S_{XX'}} \\ | \\ \boxed{p\phi_o + (1-p)\phi_1} \\ | \\ \text{---} \end{array} = \begin{array}{c} \text{---} \\ | \\ \boxed{S_{XX'}} \\ | \\ \boxed{\phi} \\ | \\ \rho_p \\ | \\ \text{---} \end{array} = \begin{array}{c} \text{---} \\ | \\ \boxed{S_{XY,X'}} \\ | \\ \boxed{\phi} \\ | \\ \rho_p \\ | \\ \text{---} \end{array}.$$

Rewriting ρ_p in terms of ρ_0, ρ_1 gives

$$= p_0 \begin{array}{c} \text{---} \\ | \\ \boxed{S_{XY,X'}} \\ | \\ \boxed{\phi} \\ | \\ \rho_0 \\ | \\ \text{---} \end{array} + p_1 \begin{array}{c} \text{---} \\ | \\ \boxed{S_{XY,X'}} \\ | \\ \boxed{\phi} \\ | \\ \rho_1 \\ | \\ \text{---} \end{array},$$

then using naturality again

$$= p_0 \begin{array}{c} \text{---} \\ | \\ \boxed{S_{XX'}} \\ | \\ \boxed{\phi} \\ | \\ \rho_0 \\ | \\ \text{---} \end{array} + p_1 \begin{array}{c} \text{---} \\ | \\ \boxed{S_{XX'}} \\ | \\ \boxed{\phi} \\ | \\ \rho_1 \\ | \\ \text{---} \end{array},$$

and finally using the definition of control recovers the result

$$= p_0 \begin{array}{c} \text{---} \\ | \\ \boxed{S_{XX'}} \\ | \\ \boxed{\phi_o} \\ | \\ \text{---} \end{array} + p_1 \begin{array}{c} \text{---} \\ | \\ \boxed{S_{XX'}} \\ | \\ \boxed{\phi_1} \\ | \\ \text{---} \end{array} = p_0 S_{X,X'}(\phi_0) + p_1 S_{X,X'}(\phi_1).$$

□

We note that S consequently has a unique extension to the real-linear span of K . We now show using this result that locally-applicable transformations on $\mathbf{QC}(A, A')$ can be uniquely extended to $\mathbf{CP}(A, A')$, more generally for any set K the map S can be extended to the operational closure $K_{\mathbf{CP}}$ of K .

Lemma 5 (Extension to operational closure). *Let K, M be convex, then every locally-applicable transformation of type $S : K \rightarrow M$ on \mathbf{QC} has a unique extension to a function $S_{\mathbf{CP}} : K_{\mathbf{CP}} \rightarrow M_{\mathbf{CP}}$.*

Proof. We give a candidate definition and then show that it is well-posed, consider some $\phi \in K_{\mathbf{CP}}$, for this ϕ there exists $\phi \in \mathbf{dExt}_{X,X'}(K)$ and ρ, σ such that:

$$\begin{array}{c} | \\ \square \phi \\ | \end{array} = \begin{array}{c} | \\ \square \phi \\ | \begin{array}{c} \square \sigma \\ \square \rho \end{array} \end{array} .$$

With respect to this choice we can define

$$\begin{array}{c} | \\ \square_{\mathbf{CP}} \\ | \end{array} \begin{array}{c} | \\ \square \phi \\ | \begin{array}{c} \square \sigma \\ \square \rho \end{array} \end{array} := \begin{array}{c} | \\ \square_{XX'} \\ | \begin{array}{c} \square \phi \\ \square \rho \end{array} \end{array} .$$

We now show that this definition is well-posed by showing that for any other choice of ϕ, ρ, σ the resulting outcome $S_{\mathbf{CP}}(\phi)$ would be the same. Indeed, let

$$\begin{array}{c} | \\ \square \phi \\ | \begin{array}{c} \square \sigma \\ \square \rho \end{array} \end{array} = \begin{array}{c} | \\ \square \phi' \\ | \begin{array}{c} \square \sigma' \\ \square \rho' \end{array} \end{array}$$

then consider the process Σ defined by

$$\begin{array}{c} | \\ \square \Sigma \\ | \end{array} = \begin{array}{c} | \\ \square 0 \\ | \end{array} + \begin{array}{c} | \\ \square 1 \\ | \end{array} - \begin{array}{c} | \\ \square \sigma \\ | \end{array}$$

where the output is taken to be at least 2-dimensional. A process Σ' can be defined similarly, note that both Σ, Σ' are trace preserving and so are members of \mathbf{QC} , meaning that they can be slid along dotted wires. We now consider the result of applying them to ϕ, ϕ' :

$$\begin{array}{c} | \\ \square \Sigma \\ | \end{array} \begin{array}{c} | \\ \square \phi \\ | \begin{array}{c} \square \sigma \\ \square \rho \end{array} \end{array} = \begin{array}{c} | \\ \square 0 \\ | \end{array} \begin{array}{c} | \\ \square \phi \\ | \begin{array}{c} \square \sigma \\ \square \rho \end{array} \end{array} + \begin{array}{c} | \\ \square 1 \\ | \end{array} \begin{array}{c} | \\ \square \phi \\ | \begin{array}{c} \square \sigma \\ \square \rho \end{array} \end{array} - \begin{array}{c} | \\ \square \sigma \\ | \end{array} \begin{array}{c} | \\ \square \phi \\ | \begin{array}{c} \square \sigma \\ \square \rho \end{array} \end{array} ,$$

this in turn implies that

$$\begin{array}{c} | \\ \square \Sigma \\ | \end{array} \begin{array}{c} | \\ \square \phi \\ | \begin{array}{c} \square \sigma \\ \square \rho \end{array} \end{array} - \begin{array}{c} | \\ \square \Sigma' \\ | \end{array} \begin{array}{c} | \\ \square \phi' \\ | \begin{array}{c} \square \sigma' \\ \square \rho' \end{array} \end{array} = \begin{array}{c} | \\ \square 1 \\ | \end{array} \begin{array}{c} | \\ \square \phi \\ | \begin{array}{c} \square \sigma \\ \square \rho \end{array} \end{array} - \begin{array}{c} | \\ \square 1' \\ | \end{array} \begin{array}{c} | \\ \square \phi' \\ | \begin{array}{c} \square \sigma' \\ \square \rho' \end{array} \end{array} ,$$

and so then by linearity

$$\begin{array}{c} | \\ \square_{IX'} \\ | \end{array} \begin{array}{c} | \\ \square \Sigma \\ | \end{array} \begin{array}{c} | \\ \square \phi \\ | \begin{array}{c} \square \sigma \\ \square \rho \end{array} \end{array} - \begin{array}{c} | \\ \square_{IX'} \\ | \end{array} \begin{array}{c} | \\ \square \Sigma' \\ | \end{array} \begin{array}{c} | \\ \square \phi' \\ | \begin{array}{c} \square \sigma' \\ \square \rho' \end{array} \end{array} = \begin{array}{c} | \\ \square_{IX'} \\ | \end{array} \begin{array}{c} | \\ \square 1 \\ | \end{array} \begin{array}{c} | \\ \square \phi \\ | \begin{array}{c} \square \sigma \\ \square \rho \end{array} \end{array} - \begin{array}{c} | \\ \square_{IX'} \\ | \end{array} \begin{array}{c} | \\ \square 1' \\ | \end{array} \begin{array}{c} | \\ \square \phi' \\ | \begin{array}{c} \square \sigma' \\ \square \rho' \end{array} \end{array} \quad (1)$$

We begin by showing that σ, σ' can be safely pulled across dotted wires maintaining equality even though they are not quantum channels, Indeed consider the difference, and express in terms of Σ, Σ' :

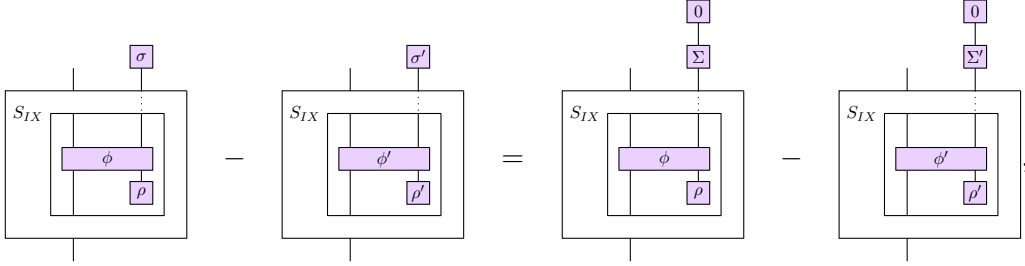

Now, since Σ, Σ' are quantum channels they can be pulled through dotted lines, after which we use equation (1):

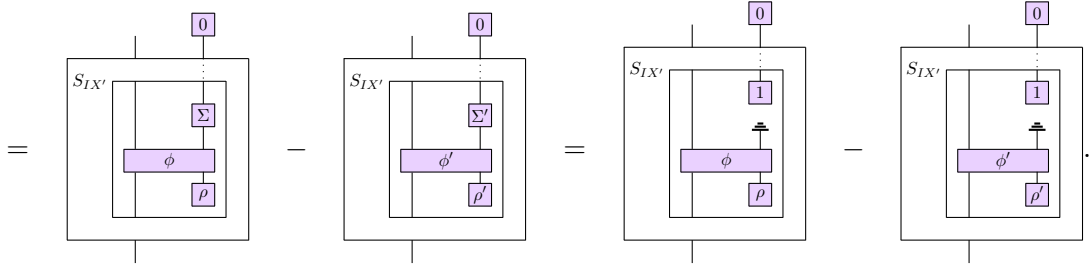

The preparation $1 : I \rightarrow X'$ is a quantum channel it can be pulled back through dotted wires, after which orthogonality implies that the difference has to be 0:

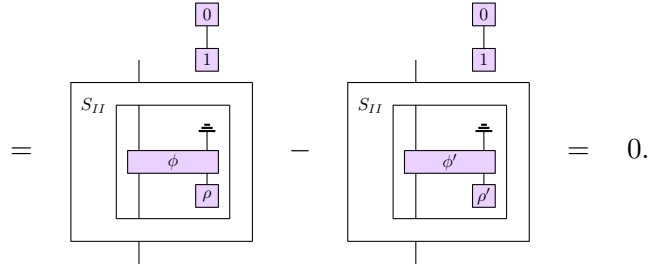

Since the difference is 0 then it follows that

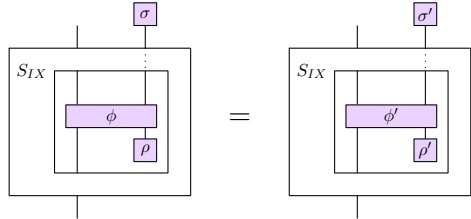

We can now consider the bottom side, which is easier to reason with since every $\rho \in \mathbf{CP}(I, X)$ is given by $a\eta$ with η a state in $\mathbf{QC}(I, X)$ and a a scalar. Indeed, using the extension of S to \mathbb{R} -linearity (and so to multiplication by scalar α) gives

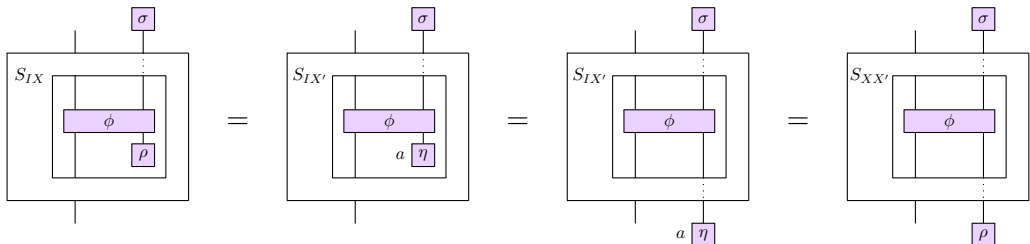

and similarly for the ϕ', ρ', σ' we find

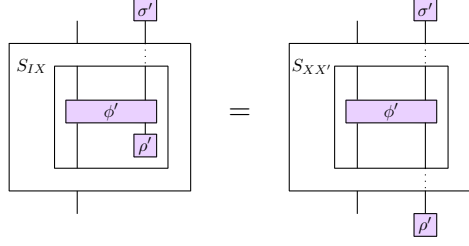

All together then, using the separate deductions made for ρ and σ gives

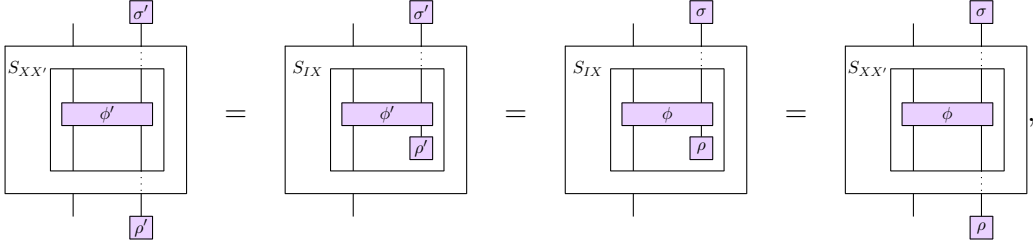

and so $S_{\mathbf{CP}}$ is indeed well defined. \square

The above is the key to our result, we now are ready to construct a candidate quantum supermap for simulating the action of our locally-applicable transformation $S_{X, X'}$ by tensor extension with identities on X, X' . To do so we apply our locally-applicable transformation S to the swap-morphism, the intuition being that the swap gives a way to noiselessly extract information about the input behaviour of a higher order map, by converting its input into a pair of lower-order objects.

Theorem 1 (Re-characterisation of supermaps). *Let K, M be normal convex subsets of channels of \mathbf{QC} , there is a one-to-one correspondence between quantum supermaps of type $K \rightarrow M$ and locally-applicable transformations of the same type.*

Proof. Given a locally-applicable transformation S of type $K \rightarrow M$ on \mathbf{QC} with $K \subseteq \mathbf{QC}(A, A')$ and $M \subseteq \mathbf{QC}(B, B')$ we define $S_Q : A^* \otimes A' \rightarrow B^* \otimes B'$ by:

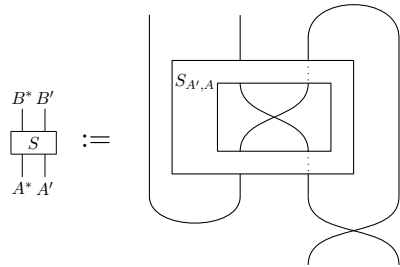

In other words we apply S to the swap in \mathbf{QC} and then embed into \mathbf{CP} so that we may apply caps and cups, note that normality of K, M is required here to ensure that the swap lives within their dilation extensions. We now consider the application of arbitrary states

and effects ρ, σ in \mathbf{CP} to the auxiliary wires, and use the tensor separation property:

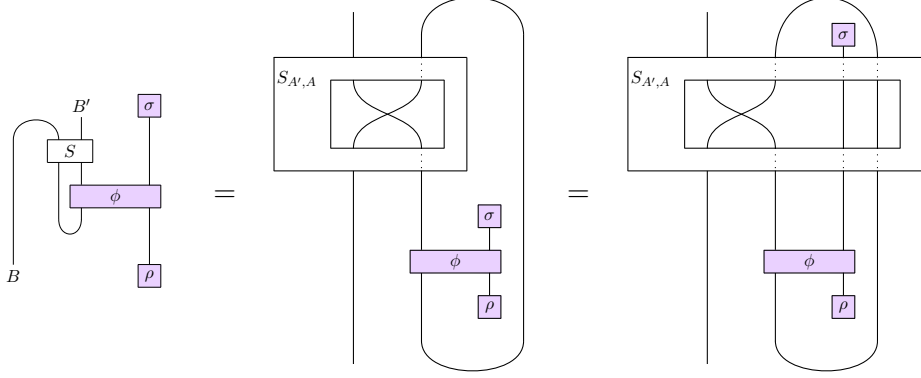

Using the well-posed definition of $S_{\mathbf{CP}}$ and then using compact closure to replace the cup and cap with the identity gives:

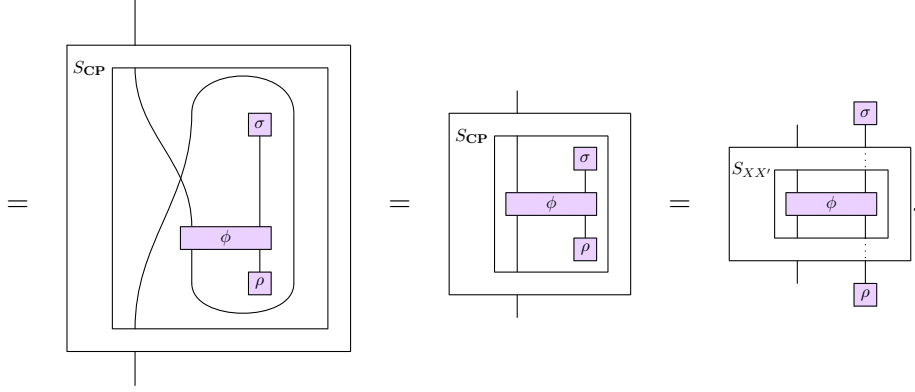

Since this is true for all ρ, σ in \mathbf{CP} it follows that:

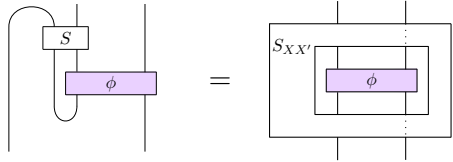

and so there indeed exists a quantum supermap of type $S_Q : K \rightarrow M$, such that $\mathcal{F}_{\mathbf{CP}}(S_Q) = S$ where $\mathcal{F}_{\mathbf{CP}}$ is the previously defined embedding of \mathbf{CP} -supermaps on \mathbf{QC} into locally-applicable transformations on \mathbf{QC} . \square

Note that in \mathbf{QC} the set $\mathcal{E}_{sig}(\tau)$ is convex and that furthermore $\mathcal{E}_{sig}(\tau) = \mathcal{E}_{path}(\tau)$. It follows then that for arbitrary relations τ the locally-applicable transformations of type $\mathcal{E}_{path}(\tau) \rightarrow \mathcal{E}_{path}(\lambda)$ characterize the quantum supermaps of type $\mathcal{E}_{sig}(\tau) \rightarrow \mathcal{E}_{sig}(\lambda)$. As a stricter corollary the quantum supermaps on non-signalling channels, also referred to in the literature as process matrices have been characterised from principles of compositionality, without reference to causality or preferred time direction. To phrase this concisely we refer to the morphisms in:

$$\mathcal{E}_{path}\left(\uparrow \uparrow\right),$$

as non-pathing morphisms and refer to supermaps and locally-applicable transformations of type $K \rightarrow \mathbf{C}(B, B')$ for some B, B' as being *on* the set K .

Corollary 1. *There is a one-to-one correspondence between quantum supermaps on the set of non-signalling channels and locally-applicable transformations on the set of non-pathing channels.*

Other example of convex sets of interest for which supermaps are now consequently characterised in terms of locality are those convex sets which are specified by sectorial constraints [48,77,80,81] which find use in the phrasing of more complex instances of pathing constraints [76] and in the analysis of fine-grained causal structures [47,48]. Finally, we comment that by denoting the restriction of the category $\mathbf{CPsup}[\mathbf{QC}]$ to convex sets by $\mathbf{CPsup}[\mathbf{QC}]_{con} := \mathbf{QS}_{con}$ and similarly denoting restriction of the category $\mathbf{lot}[\mathbf{C}]$ to convex sets by $\mathbf{lot}[\mathbf{C}]_{con}$ we can state the one-to-one correspondence in concise categorical language.

Corollary 2. *There is an equivalence of categories $\mathbf{QS}_{con} \cong \mathbf{lot}[\mathbf{QC}]_{con}$*

This equivalence is confirmed by noting that the assignment $\mathcal{F}_{\mathbf{CP}}$ is functorial, surjective on objects, and full and faithful by the one-to-one correspondence observed in this section. In summary, quantum supermaps and equivalently process matrices, originally defined in terms of Choi-isomorphisms and probabilistic structure respectively, are instances of a purely compositional definition of higher order mapping of quantum channels.

6 Multiparty Approach

In this section we generalise the definition of locally-applicable transformation to multi-input transformations. Whilst we have technically already recovered the standard definition supermaps on multiple parties using locally-applicable transformations on non-signalling processes, the following approach has the advantage that it comes closer to constructing for free (without characterization in the quantum setting) some key compositional features of quantum supermaps.

Definition 9. *A locally-applicable transformation of type $K_{-,=}^1 \dots K_{-,=}^n \longrightarrow M_{-,=}$ is a family of functions*

$$S_{X_1 \dots X_n}^{X'_1 \dots X'_n} : K_{X_1, X'_1}^1 \dots K_{X_n, X'_n}^n \longrightarrow M_{X_1 \dots X_n, X'_1 \dots X'_n}$$

satisfying:

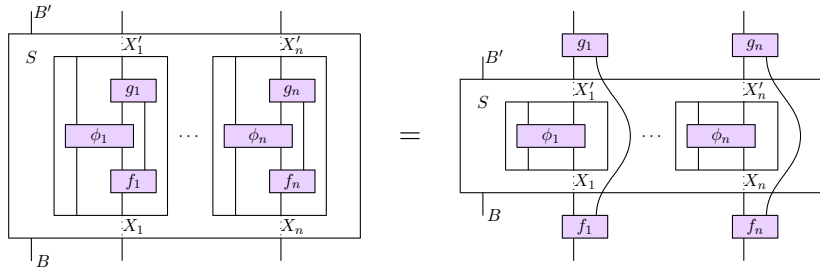

This definition for supermaps with multiple inputs allows to more easily include important examples of supermaps on arbitrary symmetric monoidal categories, such as combs [82] on general monoidal categories [78].

Example 3. Let \mathbf{C} be a symmetric monoidal category, the locally-applicable transformation $\text{comb}[c_1 \dots c_{n+1}]$ of type $\text{comb}[c_1 \dots c_{n+1}] : \mathbf{C}(A_1 -, A'_1 =) \dots \mathbf{C}(A_n -, A'_n =) \rightarrow \mathbf{C}(B -, B =)$ is the family of functions of type $\text{comb}[c_1 \dots c_{n+1}]_{X_1 \dots X_n, X'_1 \dots X'_n} : \mathbf{C}(A_1 X_1, A'_1 X'_1) \dots \mathbf{C}(A_n X_n, A'_n X'_n) \rightarrow \mathbf{C}(B X_1 \dots X_n, B X'_1 \dots X'_n)$ given by

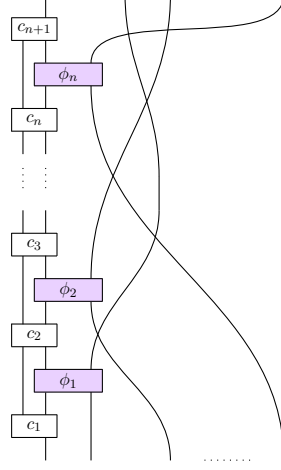

Again, this definition can be extended to those combs of type $\text{comb}(c_1 \dots c_{n+1}) : K_{-,=}^1 \dots K_{-,=}^n \rightarrow M_{-,=}$ which are those combs such that for all $\phi_i \in K_{X_i, X'_i}^i$ then $\text{comb}[c_1 \dots c_{n+1}]_{X_1 \dots X_n, X'_1 \dots X'_n}(\phi_1 \dots \phi_n) \in M_{X_1 \dots X_n, X'_1 \dots X'_n}$. This definition can further be generalised to combs in \mathbf{D} for any symmetric monoidal category \mathbf{D} into which \mathbf{C} is included.

Example 4. Let $\mathbf{C} \subseteq \mathbf{D}$ be an inclusion of symmetric monoidal categories and $K_{-,=}^i, M_{-,=}$ be extendable sets of \mathbf{C} , then the \mathbf{D} -combs of type $K_{-,=}^1 \dots K_{-,=}^n \rightarrow M_{-,=}$ on \mathbf{C} are those $\text{comb}[d_1 \dots d_{n+1}]$ in \mathbf{D} such that for any $\phi_i \in K_{X_i, X'_i}^i$ then $\text{comb}[d_1 \dots d_{n+1}]_{X_1 \dots X_n, X'_1 \dots X'_n}(\phi_1 \dots \phi_n) \in M_{X_1 \dots X_n, X'_1 \dots X'_n}$

By a proof method identical to that which is given in the singly-party case, for any compact closed category \mathbf{P} a one-to-one correspondence can be given between the multiparty \mathbf{P} -combs and the multiparty \mathbf{P} -supermaps on any symmetric monoidal category $\mathbf{C} \subseteq \mathbf{P}$.

The advantage of the multi-input approach is that it freely recovers two key aspects of the compositional semantics of supermaps, the first being that they may be composed via nesting. Diagrammatically this nesting composition is given by taking $S \circ (T^1 \dots T^m)(\phi_i^j)$ to be

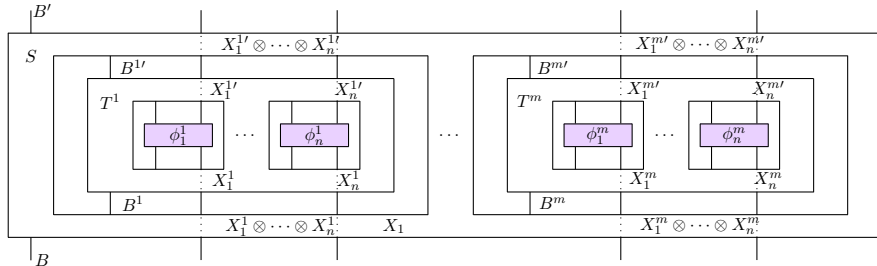

In category theoretic terms this nesting composition means that locally-applicable transformations always define a multicategory, with objects given by extendable sets $K_{-,=}$ and multi-morphisms of type $K_{-,=}^1 \dots K_{-,=}^n \rightarrow M_{-,=}$ given by locally-applicable transformations of the same type. This generalises the multi-categorical structures inherited by monoidal structure of $\mathbf{Caus}[\mathbf{C}]$ [7]. The second key compositional feature of

such supermaps is their enriched structure [8], there always exists locally-applicable transformations with multiple inputs which simply compose their input processes in sequence, or in parallel. The former appears as a locally-applicable transformation of type $\circ : \mathbf{C}(A, B)\mathbf{C}(B, C) \rightarrow \mathbf{C}(A, C)$:

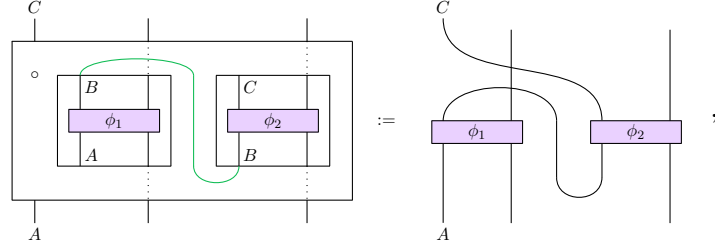

the latter appears as a locally-applicable transformation of type $\otimes : \mathbf{C}(A, A')\mathbf{C}(B, B') \rightarrow \mathbf{C}(A \otimes B, A' \otimes B')$:

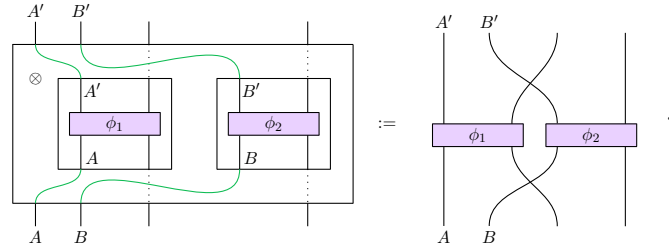

We note here that at this level enrichment is in a multicategory rather than the more standard setting of enrichment in a monoidal category [8].

Consequently, the multi-input approach has some structural advantages. Conveniently, the results on single-input locally-applicable transformations generalise to multi-input locally applicable transformations by noting that when all but one input is filled, what remains is a standard locally applicable transformation.

Corollary 3. *let K_1, \dots, K_n, M be convex sets of morphisms of \mathbf{QC} , there is a one-to-one correspondence between \mathbf{CP} -supermaps of type $K_1 \dots K_n \rightarrow M$ and locally-applicable transformations of the same type.*

Proof. That \mathbf{CP} -supermaps still give locally-applicable transformations follows from multiple uses of the interchange law for symmetric monoidal categories. What remains is to prove that every locally-applicable transformation is implemented by a \mathbf{CP} -supermap. Up to braiding the family of functions given by $S((-)\psi_2 \dots \psi_n)_{X_1, X'_1}(\psi_1) := S(\psi_1 \dots \psi_n)_{X_1 \dots X_n, X'_1 \dots X'_n}$ is a locally-applicable transformation with one-input, consequently we can use our main theorem to show that

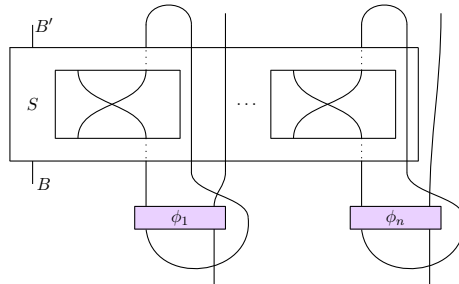

is equal to

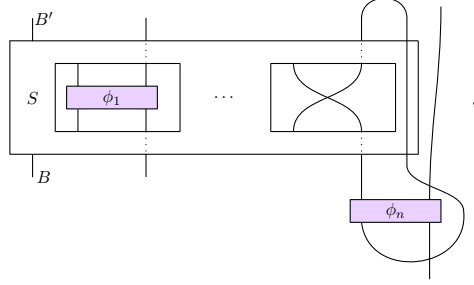

Repeating this step for each consecutive input from 2 to n returns

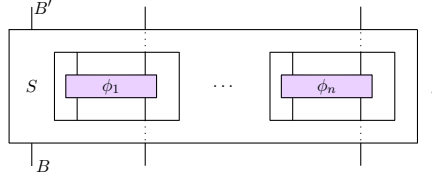

which completes the proof. \square

The **CP**-supermaps of type $\mathbf{C}(A_1, A'_1)\mathbf{C}(A_2, A'_2) \rightarrow \mathbf{C}(B, B')$ are in one to one correspondence with **CP**-supermaps of type

$$\mathcal{E}_{path}\left(\uparrow \uparrow\right) \rightarrow \mathbf{C}(B, B')$$

which can be viewed as a consequence of linear distributivity of the **Caus**[**C**] construction along with the fact that non-signalling channels are given by the double closure as defined in [7] of the set of product channels. This statement can be generalized, for the same reasons the **CP**-supermaps of type $\mathbf{C}(A_1, A'_1) \dots \mathbf{C}(A_n, A'_n) \rightarrow \mathbf{C}(B, B')$ are in one-to-one correspondence with the **CP**-supermaps of type

$$\mathcal{E}_{path}\left(\uparrow \dots \uparrow\right) \rightarrow \mathbf{C}(B, B').$$

Consequently, the locally-applicable transformations with multiple inputs give another way to characterize the supermaps on non-signalling channels used to study indefinite causal structure. This time, the construction provides for free some key compositional features of such supermaps.

When the characterization theorem holds, then the definition of supermaps on OPTs become quite clear. On the one hand locally-applicable transformations outline a bare-minimum requirement, whereas supermaps expressed with cups and caps are already equipped with some interpretation in terms of the non-deterministic processes of the theory. When these two definitions coincide, it appears that supermaps come with a stable definition. Beyond this situation, when they do not coincide, one might have to make more careful (and potentially domain-specific) analysis.

7 Summary and Outlook

A definition of locally-applicable transformation is introduced which refers only to the circuit-theoretic structure of deterministic quantum information theory. By being purely compositional in nature it may be applied to arbitrary symmetric monoidal categories and stated concisely in the language of category theory using the notion of a natural

transformation. When applied to quantum channels, including those equipped with signaling constraints, locally-applicable transformations are in one to one correspondence with quantum supermaps, so provide a re-axiomatisation for supermaps in terms of the principles of sequential composition, parallel composition, and locality.

A clear application of the redefinition of supermaps as locally applicable transformations is that it provides a candidate definition for supermaps on arbitrary operational probabilistic theories. Indeed, the problem of defining indefinite causal orders over generalized physical theories has recently gained interest [83, 84]. The characterization theorems in this article (along with the outline of their analogues for classical information theory in the appendix) demonstrate that this definition is a particularly strong candidate for supermaps on OPTs, as it recovers the established definitions of supermaps in cases where they are well understood. It is natural, then, to conclude that a stable starting point for the study of supermaps (and, consequently, indefinite causal order) over any OPT is the study of its locally applicable transformations. Efficient application of this categorical approach would further benefit from the characterization of locally applicable transformations in broader classes of OPTs, as well as from addressing the problem of extracting probabilistic correlations from locally-applicable transformations (I.E those used to device-independently verify properties of causal structures [40]).

Beyond this point, the construction presented in this article could in principle be a seed for a variety of new projects, including comparison of its infinite iteration with the construction of higher order causal categories, the free construction of various compositional features of quantum supermaps [6–8], and characterisation of locally-applicable transformations on infinite dimensional quantum theory. Less concretely and more broadly it is the authors hope that this definition of supermap is closer to allowing for a suitable generalisation to more elaborate notions of space and parallel composition [66, 67, 85] including but not limited to algebraic quantum field theories [68], so that higher order quantum theories can be brought into closer contact with theories of quantum gravity where supermaps are hoped to provide insight by modelling of quantum causal structure [39].

Acknowledgements

MW is grateful to J Hefford, C Comfort, A Vanreitelde, N Ormrod, N Pinzani, and H Kristjánsson for useful conversations, and again to N Ormrod for reviewing an earlier draft of this manuscript. AK and GC are supported by the John Templeton Foundation through grant 62312, The Quantum Information Structure of Spacetime (qiss.fr). The opinions expressed in this publication are those of the authors and do not necessarily reflect the views of the John Templeton Foundation. GC was supported by the Croucher Foundation and by the Hong Kong Research Grant Council (RGC) through the Senior Research Fellowship Scheme SRFS2021-7S02. MW was supported by University College London and the EPSRC Doctoral Training Centre for Delivering Quantum Technologies [grant number EP/L015242/1].

References

- [1] G. Chiribella, G. M. D’Ariano, and P. Perinotti, “Transforming quantum operations: Quantum supermaps,” *EPL (Europhysics Letters)* **83** no. 3, (7, 2008) 30004, [arXiv:0804.0180](https://arxiv.org/abs/0804.0180) [quant-ph].

- [2] G. Chiribella, G. M. D’Ariano, and P. Perinotti, “Quantum circuit architecture,” *Physical Review Letters* **101** no. 6, (8, 2008) 060401, [arXiv:0712.1325 \[quant-ph\]](#).
- [3] G. Chiribella, G. M. D’Ariano, P. Perinotti, and B. Valiron, “Quantum computations without definite causal structure,” *Physical Review A - Atomic, Molecular, and Optical Physics* **88** no. 2, (8, 2013) 022318, [arXiv:0912.0195 \[quant-ph\]](#).
- [4] G. Chiribella, G. M. D’Ariano, and P. Perinotti, “Theoretical framework for quantum networks,” *Physical Review A - Atomic, Molecular, and Optical Physics* **80** no. 2, (4, 2009) , [arXiv:0904.4483 \[quant-ph\]](#).
- [5] G. Chiribella, A. Toigo, and V. Umanità, “Normal completely positive maps on the space of quantum operations,” *Open Systems and Information Dynamics* **20** no. 1, (12, 2010) , [arXiv:1012.3197 \[quant-ph\]](#).
- [6] A. Bisio and P. Perinotti, “Theoretical framework for higher-order quantum theory,” *Proceedings of the Royal Society A: Mathematical, Physical and Engineering Sciences* **475** no. 2225, (5, 2019) 20180706, [arXiv:1806.09554 \[quant-ph\]](#).
- [7] A. Kissinger and S. Uijlen, “A categorical semantics for causal structure,” *Logical Methods in Computer Science* **15** no. 3, (2019) , [arXiv:1701.04732 \[quant-ph\]](#).
- [8] M. Wilson and G. Chiribella, “A Mathematical Framework for Transformations of Physical Processes,” [arXiv:2204.04319 \[quant-ph\]](#).
- [9] P. Perinotti, “Causal structures and the classification of higher order quantum computations,” [arXiv:1612.05099 \[quant-ph\]](#).
- [10] H. Kristjánsson, G. Chiribella, S. Salek, D. Ebler, and M. Wilson, “Resource theories of communication,” *New Journal of Physics* **22** no. 7, (7, 2020) 073014, [arXiv:1910.08197 \[quant-ph\]](#). <https://doi.org/10.1088/1367-2630/ab8ef7>.
- [11] G. Gour and C. M. Scandolo, “Dynamical Resources,” [arXiv:2101.01552v1 \[quant-ph\]](#).
- [12] G. Gour and C. M. Scandolo, “Entanglement of a bipartite channel,” *Physical Review A* **103** no. 6, (6, 2021) 062422, [arXiv:2101.01552v1 \[quant-ph\]](#).
- [13] D. Ebler, S. Salek, and G. Chiribella, “Enhanced Communication with the Assistance of Indefinite Causal Order,” *Physical Review Letters* **120** no. 12, (3, 2018) 120502.
- [14] L. M. Procopio, F. Delgado, M. Enríquez, N. Belabas, and J. A. Levenson, “Communication Enhancement through Quantum Coherent Control of N Channels in an Indefinite Causal-Order Scenario,” *Entropy* **21** no. 10, (10, 2019) 1012. <https://www.mdpi.com/1099-4300/21/10/1012>.
- [15] L. M. Procopio, F. Delgado, M. Enríquez, N. Belabas, and J. A. Levenson, “Sending classical information via three noisy channels in superposition of causal orders,” *Physical Review A* **101** no. 1, (1, 2020) 012346, [arXiv:1910.11137 \[quant-ph\]](#).
- [16] G. Chiribella, M. Banik, S. S. Bhattacharya, T. Guha, M. Alimuddin, A. Roy, S. Saha, S. Agrawal, and G. Kar, “Indefinite causal order enables perfect quantum communication with zero capacity channels,” *New Journal of Physics* (2, 2021) . <https://iopscience.iop.org/article/10.1088/1367-2630/abe7a0>. [arxiv:1810.10457v2](https://arxiv.org/abs/1810.10457v2).

- [17] G. Chiribella, M. Wilson, and H. F. Chau, “Quantum and Classical Data Transmission Through Completely Depolarising Channels in a Superposition of Cyclic Orders,” *arXiv* (5, 2020) , [arXiv:2005.00618 \[quant-ph\]](#).
- [18] M. Wilson and G. Chiribella, “A Diagrammatic Approach to Information Transmission in Generalised Switches,” [arXiv:2003.08224 \[quant-ph\]](#).
- [19] M. T. Quintino, Q. Dong, A. Shimbo, A. Soeda, and M. Murao, “Probabilistic exact universal quantum circuits for transforming unitary operations,” *Physical Review A* **100** no. 6, (12, 2019) 062339, [arXiv:1909.01366 \[quant-ph\]](#).
- [20] M. T. Quintino, Q. Dong, A. Shimbo, A. Soeda, and M. Murao, “Reversing Unknown Quantum Transformations: Universal Quantum Circuit for Inverting General Unitary Operations,” *Physical Review Letters* **123** no. 21, (11, 2019) 210502.
- [21] Q. Dong, M. T. Quintino, A. Soeda, and M. Murao, “Success-or-Draw: A Strategy Allowing Repeat-Until-Success in Quantum Computation,” *Physical Review Letters* **126** no. 15, (4, 2021) 150504.
- [22] P. A. Guérin, A. Feix, M. Araújo, and Ć. Brukner, “Exponential Communication Complexity Advantage from Quantum Superposition of the Direction of Communication,” *Physical Review Letters* **117** no. 10, (9, 2016) 100502, [arXiv:1605.07372 \[quant-ph\]](#).
- [23] G. Chiribella, “Perfect discrimination of no-signalling channels via quantum superposition of causal structures,” *Physical Review A - Atomic, Molecular, and Optical Physics* **86** no. 4, (10, 2012) 040301, [arXiv:1109.5154 \[quant-ph\]](#).
- [24] M. Araújo, F. Costa, and Ć. Brukner, “Computational advantage from quantum-controlled ordering of gates,” *Physical Review Letters* **113** no. 25, (12, 2014) 250402, [arXiv:1401.8127 \[quant-ph\]](#).
- [25] A. Feix, M. Araújo, and Ć. Brukner, “Quantum superposition of the order of parties as a communication resource,” *Physical Review A - Atomic, Molecular, and Optical Physics* **92** no. 5, (11, 2015) 052326.
- [26] M. Román, “Open Diagrams via Coend Calculus,” [arXiv:2004.04526 \[quant-ph\]](#).
- [27] M. Román, “Comb Diagrams for Discrete-Time Feedback,” tech. rep., 2020. [arXiv:2003.06214v1 \[quant-ph\]](#).
- [28] G. Boisseau, C. Nester, and M. Roman, “Cornering Optics,” [arXiv:2205.00842 \[quant-ph\]](#).
- [29] J. Hedges, “Coherence for lenses and open games,” [arXiv:1704.02230 \[quant-ph\]](#).
- [30] M. Riley, “Categories of Optics,” [arXiv:1809.00738 \[quant-ph\]](#).
- [31] N. Ghani, J. Hedges, V. Winschel, and P. Zahn, “Compositional game theory,” *Proceedings - Symposium on Logic in Computer Science* (3, 2016) 472–481, [arXiv:1603.04641 \[quant-ph\]](#).
- [32] F. A. Pollock, C. Rodríguez-Rosario, T. Frauenheim, M. Paternostro, and K. Modi, “Non-Markovian quantum processes: complete framework and efficient characterisation,” *Physical Review A* **97** no. 1, (12, 2015) , [arXiv:1512.00589v3 \[quant-ph\]](#).

- [33] J. Hefford and C. Comfort, “Coend Optics for Quantum Combs,” [arXiv:2205.09027 \[quant-ph\]](#).
- [34] G. Chiribella, G. M. D’Ariano, P. Perinotti, and B. Valiron, “Quantum computations without definite causal structure,” *Physical Review A - Atomic, Molecular, and Optical Physics* **88** no. 2, (12, 2009) , [arXiv:0912.0195 \[quant-ph\]](#).
- [35] M. Araújo, P. A. Guérin, and Ä. Baumeler, “Quantum computation with indefinite causal structures,” *Physical Review A* **96** no. 5, (6, 2017) , [arXiv:1706.09854v3 \[quant-ph\]](#).
- [36] M. J. Renner and Ĉ. Brukner, “Reassessing the computational advantage of quantum-controlled ordering of gates,” *Physical Review Research* **3** no. 4, (2, 2021) , [arXiv:2102.11293v1 \[quant-ph\]](#).
- [37] D. Felce and V. Vedral, “Quantum Refrigeration with Indefinite Causal Order,” *Physical Review Letters* **125** no. 7, (8, 2020) 070603, [arXiv:2003.00794 \[quant-ph\]](#).
- [38] L. Hardy, “Quantum mechanics, local realistic theories, and Lorentz-invariant realistic theories,” *Physical Review Letters* **68** no. 20, (1992) 2981–2984.
- [39] L. Hardy, “Towards Quantum Gravity: A Framework for Probabilistic Theories with Non-Fixed Causal Structure,” *Journal of Physics A: Mathematical and Theoretical* **40** no. 12, (8, 2006) 3081–3099, [arXiv:gr-qc/0608043v1 \[quant-ph\]](#).
- [40] O. Oreshkov, F. Costa, and Ĉ. Brukner, “Quantum correlations with no causal order,” *Nature Communications* **3** (2012) , [arXiv:1105.4464 \[quant-ph\]](#).
- [41] Ä. Baumeler and S. Wolf, “Perfect signaling among three parties violating predefined causal order,” *IEEE International Symposium on Information Theory - Proceedings* (12, 2013) 526–530, [arXiv:1312.5916v2 \[quant-ph\]](#).
- [42] Ä. Baumeler and S. Wolf, “The space of logically consistent classical processes without causal order,” *New Journal of Physics* **18** no. 1, (7, 2015) , [arXiv:1507.01714v2 \[quant-ph\]](#).
- [43] E. Castro-Ruiz, F. Giacomini, and Ĉ. Brukner, “Dynamics of Quantum Causal Structures,” *Physical Review X* **8** no. 1, (3, 2018) 011047, [arXiv:arxiv:1710.03139v2 \[quant-ph\]](#).
- [44] V. Baumann, M. Krumm, P. A. Guérin, and Ĉ. Brukner, “Noncausal Page-Wootters circuits,” *Physical Review Research* **4** no. 1, (5, 2021) , [arXiv:2105.02304v2 \[quant-ph\]](#).
- [45] F. Costa, “A no-go theorem for superpositions of causal orders,” *Quantum* **6** (3, 2022) 663, [arXiv:2008.06205v3 \[quant-ph\]](#).
- [46] R. Silva, Y. Guryanova, A. J. Short, P. Skrzypczyk, N. Brunner, and S. Popescu, “Connecting processes with indefinite causal order and multi-time quantum states,” *New Journal of Physics* **19** no. 10, (1, 2017) , [arXiv:1701.08638v2 \[quant-ph\]](#).
- [47] V. Vilasini and R. Renner, “Embedding cyclic causal structures in acyclic spacetimes: no-go results for process matrices,” [arXiv:2203.11245 \[quant-ph\]](#). <https://arxiv.org/abs/2203.11245v1>. 10.48550/arxiv.2203.11245.
- [48] N. Ormrod, A. Vanrietvelde, and J. Barrett, “Causal structure in the presence of sectorial constraints, with application to the quantum switch,” [arXiv:arxiv:2204.10273 \[quant-ph\]](#).

- [49] D. Felce, N. T. Vidal, V. Vedral, and E. O. Dias, “Indefinite Causal Orders from Superpositions in Time,” [arXiv:2107.08076 \[quant-ph\]](#).
- [50] O. Oreshkov and C. Giarmatzi, “Causal and causally separable processes,” *New Journal of Physics* **18** no. 9, (9, 2016) 093020, [arXiv:1506.05449 \[quant-ph\]](#).
- [51] J. Wechs, H. Dourdent, A. A. Abbott, and C. Branciard, “Quantum circuits with classical versus quantum control of causal order,” *PRX Quantum* **2** no. 3, (1, 2021) , [arXiv:2101.08796v2 \[quant-ph\]](#).
- [52] T. Purves and A. J. Short, “Quantum theory cannot violate a causal inequality,” *Physical Review Letters* **127** no. 11, (1, 2021) , [arXiv:2101.09107v2 \[quant-ph\]](#).
- [53] T. van der Lugt, J. Barrett, and G. Chiribella, “Device-independent certification of indefinite causal order in the quantum switch,” 2022.
<https://arxiv.org/abs/2208.00719>.
- [54] S. Gogioso and N. Pinzani, “The topology and geometry of causality,” 2022.
<https://arxiv.org/abs/2206.08911>.
- [55] M. D. Choi, “Completely positive linear maps on complex matrices,” *Linear Algebra and Its Applications* **10** no. 3, (1975) 285–290.
- [56] B. Coecke and A. Kissinger, *Picturing quantum processes: A first course in quantum theory and diagrammatic reasoning*. Cambridge University Press, 3, 2017.
- [57] C. Heunen and J. Vicary, “Categories for Quantum Theory,” *Categories for Quantum Theory* (11, 2019) .
- [58] S. Abramsky and B. Coecke, “A categorical semantics of quantum protocols,” [arXiv:2001.07774 \[quant-ph\]](#).
- [59] B. Coecke, “Kindergarten quantum mechanics: Lecture notes,”.
- [60] B. Coecke, “Quantum picturalism,” *Contemporary Physics* **51** no. 1, (1, 2010) 59–83, [arXiv:0908.1787 \[quant-ph\]](#).
- [61] J. H. Selby, C. M. Scandolo, and B. Coecke, “Reconstructing quantum theory from diagrammatic postulates,” [arXiv:1802.00367 \[quant-ph\]](#).
- [62] S. M. Lane, *Categories for the Working Mathematician*, vol. 5 of *Graduate Texts in Mathematics*. Springer New York, 1971. 10.1007/978-1-4612-9839-7.
- [63] A. Joyal and D. Verity, “Traced monoidal categories,” *Math. Proc. Camb. Phil. Soc* **119** (2021) 447–451.
- [64] M. Hasegawa, “Recursion from Cyclic Sharing: Traced Monoidal Categories and Models of Cyclic Lambda Calculi,” *Springer Verlag* (1997) 196213.
- [65] N. Pinzani, S. Gogioso, and B. Coecke, “Categorical Semantics for Time Travel,” *Proceedings - Symposium on Logic in Computer Science 2019-June* (1, 2019) , [arXiv:1902.00032 \[quant-ph\]](#).
- [66] S. Gogioso, “A Process-Theoretic Church of the Larger Hilbert Space,” [arXiv:1905.13117 \[quant-ph\]](#).
- [67] P. Arrighi, A. Durbec, and M. Wilson, “Quantum networks theory,” [arXiv:2110.10587 \[quant-ph\]](#). <https://arxiv.org/abs/2110.10587v1>.
- [68] R. Haag and D. Kastler, “An Algebraic approach to quantum field theory,” *J.Math.Phys.* **5** no. 7, (1964) 848–861.

- [69] J. E. Roberts, “Localization in algebraic field theory,” *Communications in Mathematical Physics* **85** no. 1, (Aug., 1982) 87–98.
- [70] S. Doplicher, “The principle of locality: Effectiveness, fate, and challenges,” *Journal of Mathematical Physics* **51** no. 1, (1, 2010) 015218.
- [71] R. Brunetti, K. Fredenhagen, and R. Verch, “The generally covariant locality principle – A new paradigm for local quantum physics,” *Communications in Mathematical Physics* **237** no. 1-2, (12, 2001) 31–68.
- [72] F. Strocchi, “Relativistic Quantum Mechanics and Field Theory,” *Foundations of Physics* **34** no. 3, (1, 2004) 501–527.
- [73] B. Coecke and R. Lal, “Causal Categories: Relativistically Interacting Processes,” *Foundations of Physics* **43** no. 4, (4, 2013) 458–501.
- [74] T. Eggeling, D. Schlingemann, and R. F. Werner, “Semicausal operations are semilocalizable,” *Europhysics Letters* **57** no. 6, (2002) 782–788.
- [75] P. Perinotti, “Causal influence in operational probabilistic theories,” *Quantum* **5** (Aug, 2021) 515, [arXiv:2012.15213](https://arxiv.org/abs/2012.15213) [quant-ph].
- [76] R. Lorenz and J. Barrett, “Causal and compositional structure of unitary transformations,” *arXiv* (1, 2020) , [arXiv:2001.07774](https://arxiv.org/abs/2001.07774) [quant-ph].
- [77] M. Wilson and A. Vanrietvelde, “Composable constraints,” [arXiv:2112.06818](https://arxiv.org/abs/2112.06818) [quant-ph].
- [78] B. Coecke, T. Fritz, and R. W. Spekkens, “A mathematical theory of resources,” [arXiv:1409.5531](https://arxiv.org/abs/1409.5531) [quant-ph]. <http://arxiv.org/abs/1409.5531http://dx.doi.org/10.1016/j.ic.2016.02.008>.
- [79] S. Gogioso and F. Genovese, “Infinite-dimensional categorical quantum mechanics,” *Electronic Proceedings in Theoretical Computer Science, EPTCS* **236** (1, 2017) 51–69.
- [80] A. Vanrietvelde, H. Kristjánsson, and J. Barrett, “Routed quantum circuits,” tech. rep. [arXiv:2001.07774](https://arxiv.org/abs/2001.07774) [quant-ph].
- [81] A. Vanrietvelde and G. Chiribella, “Universal control of quantum processes using sector-preserving channels,” *Quantum Information and Computation* **21** no. 15-16, (Dec, 2021) 1320–1352, [arXiv:2106.12463](https://arxiv.org/abs/2106.12463) [quant-ph].
- [82] G. Chiribella, G. M. D’Ariano, and P. Perinotti, “Quantum circuit architecture,” *Physical Review Letters* **101** no. 6, (8, 2008) 060401, [arXiv:0712.1325](https://arxiv.org/abs/0712.1325) [quant-ph]. <https://journals.aps.org/prl/abstract/10.1103/PhysRevLett.101.060401>.
- [83] J. Bavaresco, Ámin Baumeler, Y. Guryanova, and C. Budroni, “Indefinite causal order in boxworld theories,” tech. rep., 2024. [arXiv:2411.00951](https://arxiv.org/abs/2411.00951) [quant-ph].
- [84] K. Sengupta, “Achieving maximal causal indefiniteness in a maximally nonlocal theory,” tech. rep., 2024. [arXiv:2411.04201](https://arxiv.org/abs/2411.04201) [quant-ph].
- [85] P. E. Moliner, C. Heunen, and S. Tull, “Space in Monoidal Categories,” *Electronic Proceedings in Theoretical Computer Science, EPTCS* **266** (4, 2017) 399–410, [arXiv:1704.08086v3](https://arxiv.org/abs/1704.08086v3) [quant-ph].

A Category Theory

Here we introduce three key concepts in abstract algebra, categories, functors, and natural transformations. Avoiding issues of size, a category is a set of objects A, B, \dots with for each pair A, B a set $\mathbf{C}(A, B)$ of morphisms often denoted as $f : A \rightarrow B$. A category is furthermore equipped with, for each triple (A, B, C) of objects a composition function $\circ : \mathbf{C}(A, B) \times \mathbf{C}(B, C) \rightarrow \mathbf{C}(A, C)$ which is associative so that $f \circ (g \circ h) = (f \circ g) \circ h$, and for each object A a unit id_A so that for all $f : A \rightarrow B$ then $f \circ id_A = f = id_B \circ f$. In graphical terms a morphism $f : A \rightarrow A'$ may be written as a box labelled f with input wire A and output wire A' , sequential (\circ) composition represented by:

$$g \circ f := \begin{array}{c} \boxed{g} \\ | \\ \boxed{f} \end{array} \quad \text{and} \quad id = \begin{array}{c} | \end{array}$$

The identity box, can be diagrammatically represented as a wire. This notation has the convenient property that it absorbs the structural equations of a category. There is no graphical difference for instance between the diagram representing $(f \circ g) \circ h$ and the diagram representing $f \circ (g \circ h)$. A functor $\mathcal{F} : \mathbf{C} \rightarrow \mathbf{D}$ is a structure preserving map between categories, formally it is an assignment of an object $\mathcal{F}A$ to each object A along with for each pair A, B a function $\mathcal{F}_{AB} : \mathbf{C}(A, B) \rightarrow \mathbf{D}(\mathcal{F}A, \mathcal{F}B)$ which preserves composition in the sense that $\mathcal{F}(f \circ g) = \mathcal{F}(f) \circ \mathcal{F}(g)$ and $\mathcal{F}(i) = i$. Graphically a functor can be represented by a surrounding box, which satisfies box-merging and identity removal:

$$\begin{array}{c} \boxed{\mathcal{F}} \\ | \\ \boxed{f} \\ | \\ \boxed{\mathcal{F}} \\ | \\ \boxed{g} \end{array} = \begin{array}{c} \boxed{\mathcal{F}} \\ | \\ \boxed{f} \\ | \\ \boxed{g} \end{array} \quad \begin{array}{c} \boxed{\mathcal{F}} \\ | \\ | \end{array} = \begin{array}{c} | \end{array}$$

A natural transformation $\eta : F \Rightarrow G$ is for every object A a morphism $\eta_A : \mathcal{F}A \rightarrow \mathcal{G}A$ such that for every $f : A \rightarrow B$ then $\eta_B \circ \mathcal{F}(f) = \mathcal{G}(f) \circ \eta_A$. Graphically this reads as:

$$\begin{array}{c} \boxed{\eta_B} \\ | \\ \boxed{\mathcal{F}} \\ | \\ \boxed{f} \end{array} = \begin{array}{c} \boxed{\mathcal{G}} \\ | \\ \boxed{f} \\ | \\ \boxed{\eta_A} \end{array}$$

For any category \mathbf{C} the (*reverse*) opposite category \mathbf{C}^{op} can be defined in which $\mathbf{C}^{op}(A, B) := \mathbf{C}(B, A)$ with composition and identity inherited from \mathbf{C} so that $f \circ_{op} g := g \circ f$. Finally for any categories \mathbf{C}, \mathbf{D} the product category $\mathbf{C} \times \mathbf{D}$ can be defined in which objects are given by pairs (A, B) and morphisms given by pairs of morphisms (f, g) and composition rule inherited from \mathbf{C} and \mathbf{D} as $(f, g) \circ (f', g') := (f' \circ f, g' \circ g)$.

An example of a natural transformation of interest in this paper is given intuitively by the following: a family of functions $\eta_{A,B} : \mathbf{C}(A, B) \rightarrow \mathbf{C}(A, B)$ which commute with pre and post-composition by arbitrary processes, meaning that for all $f : A' \rightarrow A$ and $g : B \rightarrow B'$:

$$\eta_{A',B'}(g \circ \phi \circ f) = g \circ \eta_{A,B}(\phi) \circ f$$

In this paper we choose to represent such families graphically by introducing a function-box notation. We represent $\eta_{A,B}$ by

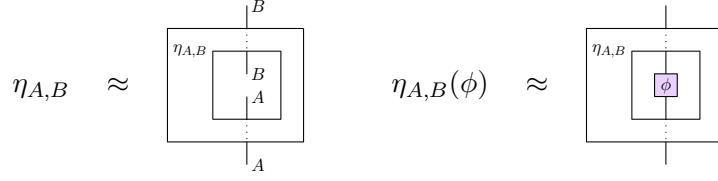

The dotted wires are used to suggest the commutation condition satisfied by the family $\eta_{A,B}$:

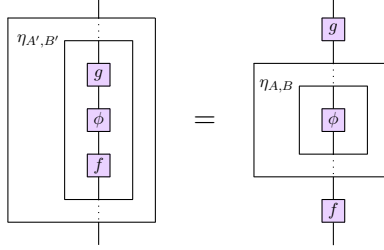

Such a family of functions can be phrased as a natural transformation in the following way, we begin with definition of the ‘‘hom functor’’ $\mathbf{C}(-, =) : \mathbf{C}^{op} \times \mathbf{C} \rightarrow \mathbf{Set}$. The category $\mathbf{C}^{op} \times \mathbf{C}$ has as objects pairs (A, B) of objects of \mathbf{C} , for morphisms $(A, B) \rightarrow (A', B')$ it has pairs $(f : A' \rightarrow A, g : B \rightarrow B')$. A functor of type $\mathbf{C}^{op} \times \mathbf{C} \rightarrow \mathbf{Set}$ must send each pair (A, B) to a set, indeed the functor $\mathbf{C}(-, =)$ is defined as sending the object (A, B) to the set $\mathbf{C}(A, B)$. A functor of type $\mathbf{C}^{op} \times \mathbf{C} \rightarrow \mathbf{Set}$ must send each pair $(f : A' \rightarrow A, g : B \rightarrow B')$ to a function $\mathbf{C}(A, B) \rightarrow \mathbf{C}(A', B')$. Indeed the functor $\mathbf{C}(-, =)$ is defined by sending each pair (f, g) to the function

$$\begin{aligned} \mathbf{C}(f, g) &: \mathbf{C}(A, B) \rightarrow \mathbf{C}(A', B') \\ \mathbf{C}(f, g)(\phi) &= g \circ \phi \circ f \end{aligned}$$

Indeed this is a functor since $\mathbf{C}(i, i)(\phi) = \phi$ and $\mathbf{C}(f \circ f', g' \circ g)(\phi) = g' \circ g \circ \phi \circ f \circ f' = \mathbf{C}(f', g')(\mathbf{C}(f, g)(\phi)) = (\mathbf{C}(f', g') \circ \mathbf{C}(f, g))(\phi)$. A natural transformation of type $\eta : \mathbf{C}(-, =) \Rightarrow \mathbf{C}(-, =)$ is a family of functions $\eta_{A,B} : \mathbf{C}(A, B) \rightarrow \mathbf{C}(A, B)$ such that $\eta_{A,B} \circ \mathbf{C}(f, g) = \mathbf{C}(f, g) \circ \eta_{A,B}$, which when applied as functions reads $\forall \phi : \eta_{A',B'}(g \circ \phi \circ f) = g \circ \eta_{A,B}(\phi) \circ f$, our original commutativity condition.

B Phrasing of localizability as naturality

The previously introduced hom-functor $\mathbf{C}(-, =)$ can be generalised in monoidal categories to a functor of type

$$\mathbf{C}(A \otimes -, A' \otimes =) : \mathbf{C}^{op} \times \mathbf{C} \longrightarrow \mathbf{SET}$$

which assigns to each (X, X') the object $\mathbf{C}(A \otimes X, A' \otimes X')$ and to each morphism $f : Y \rightarrow X$ and each morphism $g : X' \rightarrow Y'$ the function

$$\begin{aligned} \mathbf{C}(A \otimes f, A' \otimes g) &: \mathbf{C}(A \otimes X, A' \otimes X') \rightarrow \mathbf{C}(A \otimes Y, A' \otimes Y') \\ \mathbf{C}(A \otimes f, A' \otimes g) &:: \phi \mapsto (i \otimes g) \circ \phi \circ (i \otimes f) \end{aligned}$$

This functor can be further generalised to a functor $\mathbf{dExt}(K)(-, =)$, which we now define.

Definition 10 (Extension functor). *For every $K \subseteq \mathbf{C}(A, A')$ in a symmetric monoidal category \mathbf{C} one can define a functor $\mathbf{dExt}(K)(-, =) : \mathbf{C}^{op} \times \mathbf{C} \rightarrow \mathbf{Set}$ given by*

- $\mathbf{dExt}(K)(X, X') := \mathbf{dExt}_{X, X'}(K)$
- $\mathbf{dExt}(K)(f, g) : \mathbf{dExt}_{X, X'}(K) \rightarrow \mathbf{dExt}_{Y, Y'}(K)$ defined by

$$\mathbf{dExt}(K)(f, g)(\phi) := \begin{array}{c} | \\ | \\ \boxed{\phi} \\ | \\ \boxed{f} \\ | \end{array} \begin{array}{c} \boxed{g} \\ | \\ \boxed{f} \\ | \end{array}$$

The functor $\mathbf{C}(A \otimes -, A' \otimes =)$ can be defined as the special case given by $\mathbf{dExt}(\mathbf{C}(A, A'))$. \mathbf{dExt} is well defined, whenever $\phi \in \mathbf{dExt}_{X, X'}(S)$ then $\mathbf{dExt}(S)(f, g)(\phi) \in \mathbf{dExt}_{Y, Y'}(S)$ since for each f, g and ρ, σ then

$$\begin{array}{c} | \\ | \\ \boxed{\phi} \\ | \\ \boxed{f} \\ | \\ \boxed{\rho} \end{array} \begin{array}{c} \boxed{\sigma} \\ | \\ \boxed{g} \\ | \\ \boxed{f} \\ | \\ \boxed{\rho} \end{array} = \begin{array}{c} | \\ | \\ \boxed{\phi} \\ | \\ \boxed{\rho'} \end{array} \begin{array}{c} \boxed{\sigma'} \\ | \\ \boxed{f} \\ | \\ \boxed{\rho'} \end{array} \in K$$

since $\phi \in \mathbf{dExt}_{X, X'}(K)$. Furthermore the assignment $\mathbf{dExt}(S)(f, g)$ is functorial since

$$\mathbf{dExt}(S)(f', g')(\mathbf{dExt}(S)(f, g)(\phi)) = \begin{array}{c} | \\ | \\ \boxed{\phi} \\ | \\ \boxed{f} \\ | \\ \boxed{f'} \end{array} \begin{array}{c} \boxed{g'} \\ | \\ \boxed{g} \\ | \\ \boxed{f} \\ | \\ \boxed{f'} \end{array} = \mathbf{dExt}(S)(f \circ f', g' \circ g)(\phi)$$

The definition of a locally-applicable transformation can be rephrased as the definition of a natural transformation respect to this functor. A natural transformation $S : \mathbf{C}(A \otimes -, A' \otimes =) \rightarrow \mathbf{C}(B \otimes -, B' \otimes =)$ will be any family of functions $S_{X, X'}$ making the following diagram commute for all f, g :

$$\begin{array}{ccc} \mathbf{C}(A \otimes X, A' \otimes X') & \xrightarrow{S_{X, X'}} & \mathbf{C}(B \otimes X, B' \otimes X') \\ \mathbf{C}(A \otimes f, A' \otimes g) \downarrow & & \downarrow \mathbf{C}(B \otimes f, B' \otimes g) \\ \mathbf{C}(A \otimes Y, A' \otimes Y') & \xrightarrow{S_{Y, Y'}} & \mathbf{C}(B \otimes Y, B' \otimes Y') \end{array}$$

In other words such that $S_{Y, Y'} \circ \mathbf{C}(B \otimes f, B' \otimes g) = \mathbf{C}(B \otimes f, B' \otimes g) \circ S_{X, X'}$. Evaluated on processes ϕ , this condition reads $S_{Y, Y'}(\mathbf{C}(B \otimes f, B' \otimes g)(\phi)) = \mathbf{C}(B \otimes f, B' \otimes g)(S_{X, X'}(\phi))$, which unpacking the definition of $\mathbf{C}(B \otimes f, B' \otimes g)$ is precisely the *sliding* rule which in the case of quantum theory entails the stricter notion of locally-applicable transformation. This observation extends to general subsets, so that a locally-applicable transformation of type $S : K \rightarrow M$ in \mathbf{QC} is exactly a natural transformation of type $S_{X, X'} : \mathbf{dExt}_{X, X'}(K) \rightarrow \mathbf{dExt}_{X, X'}(M)$. Locally applicable transformations of type $K_{-,=}^1 \dots K_{-,=}^n \rightarrow M_{-,=}$ on \mathbf{QC} can similarly be phrased as natural transformations of type

$$K_{-,=}^1 \times \dots \times K_{-,=}^n \rightarrow M_{-,=}$$

where for any $\mathcal{F} : \mathbf{C}_1 \rightarrow \mathbf{C}_2$ and $\mathcal{G} : \mathbf{D}_1 \rightarrow \mathbf{D}_2$ the product functor $\mathcal{F} \times \mathcal{G} : \mathbf{C}_1 \times \mathbf{D}_1 \rightarrow \mathbf{C}_2 \times \mathbf{D}_2$ is defined by $\mathcal{F} \times \mathcal{G}(c, d) = (\mathcal{F}(c), \mathcal{G}(d))$ and similarly on morphisms. Noting that functors of type $\mathbf{C}^{op} \times \mathbf{C} \rightarrow \mathbf{SET}$ are those which are termed endo-profunctors on \mathbf{C} , we can conclude that the study of quantum supermaps is the study of natural transformations between certain endo-profunctors on the category of quantum channels. This connection is of particular interest since such profunctors are currently used in the field of applied category theory to build profunctor-optics, which are closely related to combs in arbitrary monoidal categories [2, 26–33].

C *Hilb Supermaps

We introduce functor box notation for weak symmetric monoidal functors. Whilst $\mathcal{F}(f)$ will be notated as before, for a weak monoidal functor, functorality is only-up-to isomorphism so that we may write:

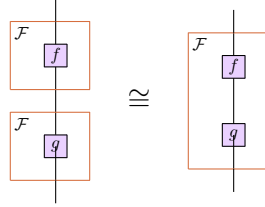

However, we will say that a functor is 2-faithful if

$$\mathcal{F}(f) \cong \mathcal{F}(g) \implies \boxed{f} = \boxed{g}$$

The above allows us to generalise \mathbf{D} -representable supermaps to a setting which allows us to use compact closure when defining supermaps on infinite dimensional quantum systems.

Lemma 6. *Let \mathbf{C} be a symmetric monoidal 2-category with trivial 2-morphisms and \mathbf{D} be a symmetric monoidal 2-category with a weak 2-faithful symmetric monoidal 2-functor $\mathcal{G} : \mathbf{C} \rightarrow \mathbf{D}$. Any $\text{comb}[a, b]$ with $a, b \in \mathbf{D}$ such that for all $\phi \in \mathbf{dExt}_{X, X'}(K)$ there exists $\psi \in \mathbf{dExt}_{X, X'}(M)$ such that $\mathcal{G}(\psi) = \text{comb}[a, b]_{\mathcal{G}X\mathcal{G}X'}(\phi)$ defines a locally-applicable transformation by taking $S_{X, X'}(\phi)$ to be the unique ψ s.t $\mathcal{G}(\psi) = \text{comb}[a, b](\phi)$. Such a locally-applicable transformation is termed a \mathcal{G} representable supermap on \mathbf{C} of type $K \rightarrow M$.*

Proof. Note that

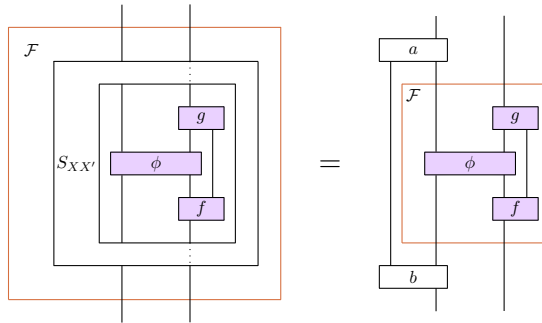

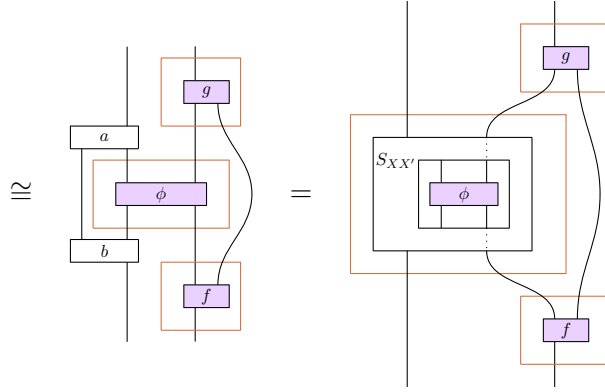

and so

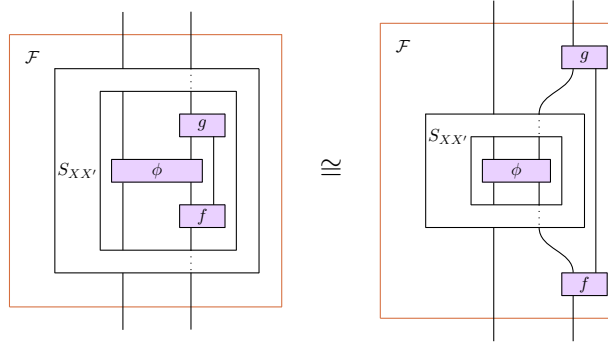

which by 2-faithful-ness of \mathcal{F} gives

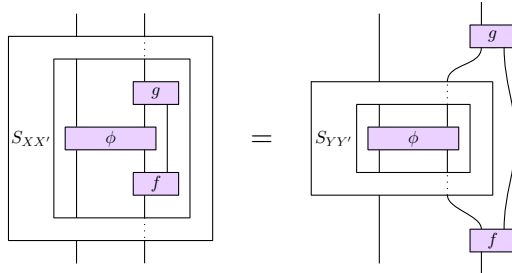

□

This gives a way to construct and represent examples of supermaps on the category of unitaries $\mathbf{sepU} \subseteq \mathbf{sephilb}$ by using the embedding of $\mathbf{sephilb}$ into ${}^*\mathbf{Hilb}$ [79].

Example 5. *There is a 2-faithful weak symmetric monoidal 2-functor $\mathcal{G} : \mathbf{sepU} \rightarrow {}^*\mathbf{Hilb}$ given by composition of the embedding $\mathbf{sepU} \subseteq \mathbf{sephilb}$ and the truncation functor $\mathbf{trunc}[-]_w : \mathbf{sephilb} \rightarrow {}^*\mathbf{Hilb}$ [79]. The induced supermaps are then termed $\mathbf{trunc}[-]$ representable supermaps on \mathbf{C} .*

One can straight-forwardly generalise the above construction to define \mathcal{G} -representable supermaps with multiple inputs, and so in particular define $\mathbf{trunc}[-]$ representable supermaps on \mathbf{sepU} with multiple inputs to realise the structural maps of monoidal enrichment, and furthermore infinite dimensional switches.

D Characterisation of Classical Supermaps

The proof methods presented in the main text can also be used to characterise supermaps on finite dimensional classical information theory. We outline the story here, noting the

key features common to quantum classical information theory that were used in our proof. First we must declare what would be aimed to be proven, and what we mean by classical information theory. We define deterministic classical maps to be stochastic matrices, just as with quantum channels it is easier to first state a compact closed category from which they are constructed.

Definition 11 (Positive real matrices). *The category $\mathbf{Mat}[\mathbb{R}_+]$ of positive real matrices is given by taking as objects the positive integers \mathbb{Z}_+ and as morphisms of type $f : n \rightarrow m$ the matrices of dimension $n \times m$. Sequential composition is given by matrix multiplication and identity morphism is given by the diagonal matrix of ones.*

The category $\mathbf{Mat}[\mathbb{R}_+]$ is symmetric monoidal and furthermore compact closed.

Definition 12 (Stochastic maps). *The category \mathbf{Stoch} of stochastic maps is given by the subcategory of $\mathbf{Mat}[\mathbb{R}_+]$ which contains only those matrices with column vectors which sum to 1.*

The category \mathbf{Stoch} is symmetric monoidal and furthermore causal, the unique effect of type $n \rightarrow 1$ is given by the row vector $(1, \dots, 1)$. Using the inclusion $\mathbf{Stoch} \subseteq \mathbf{Mat}[\mathbb{R}_+]$ one can immediately define the $\mathbf{Mat}[\mathbb{R}_+]$ -supermaps on \mathbf{Stoch} . We will now observe that these are precisely the locally-applicable transformations on \mathbf{Stoch} . First, we address the equivalence between convexity and control.

Lemma 7. *A subset $K \in \mathbf{Stoch}(A, A')$ is convex if and only if it has control*

Proof. All that was required to construct the proof was the existence of an object Y with a pair of distinguishable states in the sense that $e_i \circ \rho_j = \delta_{ij}$ and the possibility to take positive sums. Sums are taken care of by $\mathbf{Mat}[\mathbb{R}_+]$ and Y may be taken to be 2. Indeed one can define $\rho_i : 1 \rightarrow 2$ by taking the k^{th} component of the column vector ρ_i to be δ_{ik} and similarly for the effects $e_j : 2 \rightarrow 1$. \square

Lemma 8. *Let $K \in \mathbf{Stoch}(A, A')$ and $M \in \mathbf{Stoch}(B, B')$ be convex subsets, then every locally-applicable transformation $S : K \rightarrow M$ is convex linear.*

Proof. Follows directly from equivalence between convexity and control. \square

We take the operational closure $K_{\mathbf{Mat}[\mathbb{R}_+]}$ of a set $K \subseteq \mathbf{Mat}[\mathbb{R}_+]$ to be defined in the equivalence way as for subsets M of \mathbf{QC} , replacing the applying of effects from \mathbf{CP} with the applying of effects from $\mathbf{Mat}[\mathbb{R}_+]$

Lemma 9. *Every locally-applicable transformation $S : K \rightarrow M$ between convex sets in \mathbf{Stoch} extends to a function $S_{\mathbf{Mat}[\mathbb{R}_+]} : K_{\mathbf{Mat}[\mathbb{R}_+]} \rightarrow \mathbf{M}_{\mathbf{Mat}[\mathbb{R}_+]}$.*

Proof. The required elements of the proof are that $\mathbf{Mat}[\mathbb{R}_+]$ embeds into $\mathbf{Mat}[\mathbb{R}]$ so that subtractions can be defined, and that for every effect $\sigma \in \mathbf{Mat}[\mathbb{R}_+](A, I)$ there exists $\lambda \in \mathbb{R}_+$ and $\sigma' \in \mathbf{Mat}[\mathbb{R}_+](A, I)$ such that $\lambda\sigma + \sigma' = (1, \dots, 1)$ (The discard). \square

Lemma 10 (Tensor separation). *Every locally-applicable transformation of type $S : K \rightarrow M$ on \mathbf{Stoch} tensor separates.*

Proof. Follows since $\mathbf{Mat}[\mathbb{R}_+]$ has enough causal states. \square

Theorem 2. *For K, M convex in \mathbf{Stoch} there is a one-to-one correspondence between the $\mathbf{Mat}[\mathbb{R}_+]$ -supermaps of type $K \rightarrow M$ on \mathbf{Stoch} and the locally-applicable transformations of type $K \rightarrow M$ on \mathbf{Stoch} .*

Proof. Here all that is required is compact closure of $\mathbf{Mat}[\mathbb{R}_+]$, and again that $\mathbf{Mat}[\mathbb{R}_+]$ has enough causal states. \square

Again as a corollary of this theorem, the classical supermaps on non-signalling channels are characterised as locally-applicable transformations on non-pathing channels in **Stoch**.