

INVARIANT SEIFERT SURFACES FOR STRONGLY INVERTIBLE KNOTS

MIKAMI HIRASAWA, RYOTA HIURA, AND MAKOTO SAKUMA

ABSTRACT. Abstract: We study invariant Seifert surfaces for strongly invertible knots, and prove that the gap between the equivariant genus (the minimum of the genera of invariant Seifert surfaces) of a strongly invertible knot and the (usual) genus of the underlying knot can be arbitrarily large. This forms a sharp contrast with Edmonds' theorem that every periodic knot admits an invariant minimal genus Seifert surface. We also prove variants of Edmonds' theorem, which are useful in studying invariant Seifert surfaces for strongly invertible knots.

Dedicated to Professor Norbert A'Campo on his 80th birthday

1. INTRODUCTION

A smooth knot K in S^3 is said to be (*cyclically*) *periodic with period n* if there is a periodic diffeomorphism f of S^3 of period n which leaves K invariant and fixes a simple loop in the knot complement $S^3 \setminus K$. Since the seminal work by Trotter [58] and Murasugi [48], periodic knots have been studied extensively. In particular, Edmonds and Livingston [25] proved that every periodic knot admits an invariant incompressible Seifert surface, and this was enhanced by Edmonds [24] to the existence of an invariant minimal genus Seifert surface. (He applied this result to prove Fox's conjecture that a given nontrivial knot has only finitely many periods.)

It is natural to ask if the same result holds for strongly invertible knots. Recall that a smooth knot K in S^3 is said to be *strongly invertible* if there is a smooth involution h of S^3 which leaves K invariant and fixes a simple loop intersecting K in two points. The involution h is called a *strong inversion* of K . As in [54], we use the term *strongly invertible knot* to mean a pair (K, h) of a knot K and a strong inversion h of K , and regard two strongly invertible knots (K, h) and (K', h') to be *equivalent* if there is an orientation-preserving diffeomorphism φ of S^3 mapping K to K' such that $h' = \varphi h \varphi^{-1}$.

Note that if S is an h -invariant Seifert surface for a strongly invertible knot (K, h) then $\text{Fix}(h) \cap S$ is equal to one of the two subarcs of $\text{Fix}(h) \cong S^1$ bounded

2020 *Mathematics Subject Classification.* Primary 57K10; secondary 57M60.

Key words and phrases. strongly invertible knot, invariant Seifert surface, equivariant genus, Kakimizu complex

This article is to appear in the book, *Essays in geometry, dedicated to Norbert A'Campo* (ed. A. Papadopoulos), European Mathematical Society Press, Berlin, 2023.

by $\text{Fix}(h) \cap K \cong S^0$. So the problem of whether K admits an invariant minimal genus Seifert surface depends on the choice of the subarc of $\text{Fix}(h)$, in addition to the choice of the strong inversion h . By a *marked strongly invertible knot*, we mean a triple (K, h, δ) where (K, h) is a strongly invertible knot and δ is a subarc of $\text{Fix}(h)$ bounded by $\text{Fix}(h) \cap K$. Two marked strongly invertible knots (K, h, δ) and (K', h', δ') are regarded to be *equivalent* if there is an orientation-preserving diffeomorphism φ of S^3 mapping K to K' such that $h' = \varphi h \varphi^{-1}$ and $\delta' = \varphi(\delta)$.

Definition 1.1. By an *invariant Seifert surface* (or a *Seifert surface* in brief) for a marked strongly invertible knot (K, h, δ) , we mean a Seifert surface S for K such that $h(S) = S$ and $\text{Fix}(h) \cap S = \delta$. The *equivariant genus* (or the *genus* in brief) $g(K, h, \delta)$ of (K, h, δ) is defined to be the minimum of the genera of Seifert surfaces for (K, h, δ) . A Seifert surface for (K, h, δ) is said to be of *minimal genus* if its genus is equal to $g(K, h, \delta)$.

Every marked strongly invertible knot admits an invariant Seifert surface (Proposition 3.1), and so its equivariant genus is well-defined. However, in general, the equivariant genus is bigger than the (usual) genus. In fact, the following theorem is proved in the second author's master thesis [31] supervised by the third author with support by the first author.

Theorem 1.2. *For any integer $n \geq 0$, there exists a marked strongly invertible knot (K, h, δ) such that $g(K, h, \delta) - g(K) = n$.*

This theorem follows from a formula of the equivariant genera for certain marked strongly invertible knots that arise from 2-bridge knots. See Examples 3.4 and 4.3 for special simple cases. However, there remained various marked strongly invertible 2-bridge knots whose equivariant genera were undetermined.

This paper and its sequel [29] are motivated by the desire to determine the equivariant genera of all marked strongly invertible 2-bridge knots.

In this paper, we prove the following two variants of Edmonds' theorem on periodic knots, which are useful in studying invariant Seifert surfaces for general strongly invertible knots: Theorem 1.4 is used in [29] to give a unified determination of the equivariant genera of all marked strongly invertible 2-bridge knots.

Theorem 1.3. *Let (K, h) be a strongly invertible knot. Then there is a minimal genus Seifert surface F for K such that F and $h(F)$ have disjoint interiors.*

Theorem 1.4. *Let (K, h, δ) be a marked strongly invertible knot, and let F be a minimal genus Seifert surface for K such that F and $h(F)$ have disjoint interiors. Then there is a minimal genus Seifert surface S for (K, h, δ) whose interior is disjoint from the interiors of F and $h(F)$.*

Note that a Seifert surface for a fibered knot is a fiber surface if and only if it is of minimal genus. For fibered knots, we have a stronger conclusion as in Proposition 1.5 below.

Proposition 1.5. *Let K be a strongly invertible fibered knot. Then for any marked strongly invertible knot (K, h, δ) , there is an h -invariant fiber surface for K containing δ , and hence $g(K, h, \delta) = g(K)$.*

Theorem 1.3 is also motivated by our interest in the *Kakimizu complex* $MS(K)$ of the knot K and in the natural action of the symmetry group $\text{Sym}(S^3, K) = \pi_0 \text{Diff}(S^3, K)$ on $MS(K)$. The complex was introduced by Kakimizu [34] as the flag simplicial complex whose vertices correspond to the (isotopy classes of) minimal genus Seifert surfaces for K and edges to pairs of such surfaces with disjoint interiors. The following corollary of Theorem 1.3 may be regarded as a refinement of a special case of a theorem proved by Przytycki and Schultens [52, Theorem 1.2].

Corollary 1.6. *Let (K, h) be a strongly invertible knot, and let h_* be the automorphism of $MS(K)$ induced from the strong inversion h . Then one of the following holds.*

- (1) *There exists a vertex of $MS(K)$ that is fixed by h_* .*
- (2) *There exists a pair of adjacent vertices of $MS(K)$ that are exchanged by h_* . (Thus the mid point of the edge spanned by the vertices is fixed by h_* .)*

For a 2-bridge knot K , the structure of $MS(K)$ is described by [56, Theorem 3.3]; in particular, the underlying space $|MS(K)|$ is identified with a linear quotient of a cube. The actions of strong inversions on $MS(K)$ will be described in [29].

This paper is organized as follows. In Section 2, we recall basic facts about strongly invertible knots. In Section 3, we give two constructions of invariant Seifert surfaces and prove a basic proposition (Proposition 3.2) concerning the quotient of an invariant Seifert surface by the strong inversion. In Section 4, we give an argument for determining the equivariant genera (Proposition 4.1 and Corollary 4.2), and prove Theorem 1.2 by using that argument (Example 4.3). In Section 5, we prove our main theorems, Theorems 1.3 and 1.4. In the final section, Section 6, we briefly review old and new studies of equivariant 4-genera of symmetric knots.

Finally, we explain relation of this paper and A'Campo's work. Motivated by isolated singularities of complex hypersurfaces, A'Campo [1] formulated a way to construct fibered links in the 3-sphere from *divides*, i.e., immersions of copies of 1-manifolds in a disk. He proved that the link obtained from a connected divide is strongly invertible and fibered. In [1, Section 3], we can find a beautiful description of a pair of invariant fiber surfaces for the link. This nicely illustrates Proposition 1.5. (See [28] for visualization of these links and their fiber surfaces.) Furthermore, Couture [19] introduced the more general notion of ordered Morse signed divides, and proved that every strongly invertible link is isotopic to the link of an ordered Morse signed divide. As A'Campo suggested to the authors, it would be interesting to study invariant Seifert surfaces from this view point.

2. BASIC FACTS CONCERNING STRONGLY INVERTIBLE KNOTS

Recall that a knot K in S^3 is said to be *invertible* if there is an orientation-preserving diffeomorphism h that maps K to itself reversing orientation. The existence of non-invertible knots was proved by Trotter [59] using 2-dimensional hyperbolic geometry. (His proof is based on the fact that the pretzel knots admit the structure of Seifert fibered orbifolds, where the base orbifolds are generically hyperbolic.) If h can be chosen to be an involution then K is said to be *strongly invertible*, and h is called a *strong inversion*. Though strong invertibility of course implies invertibility, the converse does not hold, as shown by Whitten [62]. However, for hyperbolic knots, the converse also holds by the Mostow-Prasad rigidity theorem. Moreover, a sufficient condition for invertible knots to be strongly invertible was given by Boileau [7]. The finiteness theorem of symmetries of 3-manifolds proved by Kojima [40] by using the orbifold theorem [8, 9, 18, 23] implies that any knot admits only finitely many strong inversions up to equivalence. Here two strong inversions h and h' of K are regarded to be *equivalent* if there is an orientation-preserving diffeomorphism φ of S^3 such that $h' = \varphi h \varphi^{-1}$. However, the number of strong inversions up to equivalence for a satellite knot can be arbitrary large [55, Lemma 5.4]. For torus knots and hyperbolic knots, the number is at most 2, as described in Proposition 2.1 below. Recall that a knot K in S^3 is said to have *cyclic period 2* or *free period 2*, respectively, if there is an orientation-preserving smooth involution f of S^3 that maps K to itself preserving orientation, such that $\text{Fix}(f)$ is S^1 or \emptyset .

Proposition 2.1. (1) *The trivial knot admits a unique strong inversion up to equivalence.*

(2) *A nontrivial torus knot admits a unique strong inversion up to equivalence.*

(3) *An invertible hyperbolic knot admits exactly two or one strong inversions up to equivalence according to whether it has (cyclic or free) period 2 or not.*

The first assertion is due to Marumoto [42, Proposition 2], and the remaining assertions are proved in [54, Proposition 3.1] (cf. [3, Section 4]) by using the result of Meeks-Scott [44] on finite group actions on Seifert fibered spaces and the orbifold theorem. Another key ingredient of the proof of the third assertion is the following consequence of Riley's observation [53, p.124] based on the positive solution of the Smith conjecture [46]. For a hyperbolic invertible knot K , the orientation-preserving isometry group of the hyperbolic manifold $S^3 \setminus K$ is the dihedral group D_{2n} of order $2n$ for some $n \geq 1$, i.e.,

$$\text{Isom}^+(S^3 \setminus K) \cong \langle f, h \mid f^n = 1, h^2 = 1, h f h^{-1} = f^{-1} \rangle.$$

Here h extends to a strong inversion of K and f extends to a periodic map of S^3 of period n which maps K to itself preserving orientation. If n is odd, then K does not have cyclic nor free period 2, and any strong inversion of K is equivalent to that

obtained from h . If $n = 2m$ is even, then f^m extends to an involution of S^3 which gives cyclic or free period 2 of K , and any strong inversion of K is equivalent to that obtained from exactly one of h and fh .

By [39, Proposition 1.2], the above Proposition 2.1(3) is refined to the following proposition concerning marked strongly invertible knots.

Proposition 2.2. *Let K be an invertible hyperbolic knot.*

(1) *Suppose K does not have cyclic nor free period 2. Then K admits a unique strong inversion up to equivalence, and the two marked strongly invertible knots associated with K are inequivalent. Thus there are precisely two marked strongly invertible knots associated with K .*

(2) *Suppose K has cyclic period 2. Then K admits precisely two strong inversions up to equivalence, and for each strong inversion, the associated two marked strongly invertible knots are inequivalent. Thus there are precisely four marked strongly invertible knots associated with K .*

(3) *Suppose K has free period 2. Then K admits precisely two strong inversions up to equivalence, and for each strong inversion, the associated two marked strongly invertible knots are equivalent. Thus there are precisely two marked strongly invertible knots associated with K .*

Since every 2-bridge knot admits cyclic period 2, we obtain the following corollary.

Corollary 2.3. *Every hyperbolic 2-bridge knot has precisely four associated marked strongly invertible knots up to equivalence.*

The four marked strongly invertible knots associated with a hyperbolic 2-bridge knot are (implicitly) presented in [54, Proposition 3.6] and [3, Section 4].

Remark 2.4. By Proposition 2.1(1) and (2), we can easily see that the trivial knot has a unique associated marked strongly invertible knot and that every torus knot has precisely two associated marked strongly invertible knots.

We note that Barbensi, Buck, Harrington and Lackenby [5] shed new light on the strongly invertible knots in relation with the knotoids introduced by Turaev [60]. They prove that there is a 1 – 1 correspondence between unoriented knotoids, up to “rotation”, and strongly invertible knots, up to “inversion” [5, Theorem 1.1]. Proposition 2.2 is a variant of their result [5, Theorem 1.3] concerning knotoids.

3. INVERTIBLE DIAGRAMS AND INVARIANT SEIFERT SURFACES

In this section, we describe two proofs of the following basic proposition which shows the existence of an invariant Seifert surface for every marked strongly invertible knot. One is due to Boyle and Issa [12], and the other is due to Hiura [31].

Proposition 3.1. *Every marked strongly invertible knot admits an invariant Seifert surface. Namely, for every marked strongly invertible knot (K, h, δ) , there is an h -invariant Seifert surface S for K such that $\text{Fix}(h) \cap S = \delta$.*

Following [12, Definition 3.3] we say that a symmetric diagram representing a strongly invertible knot (K, h) is

- (1) *intravergent* if h acts as half-rotation around an axis perpendicular to the plane of the diagram (see Figure 3.1(a)), and
- (2) *transvergent* if h acts as half-rotation around an axis contained within the plane of the diagram (see Figure 3.5(a)).

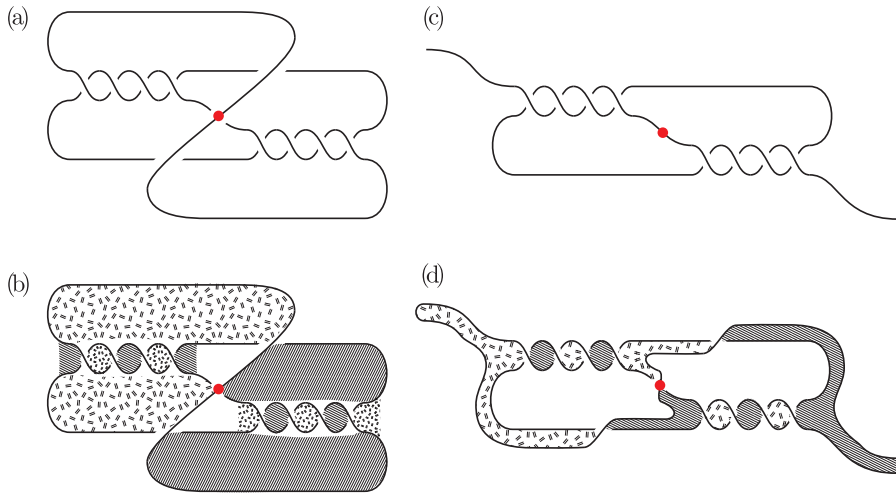

FIGURE 3.1. A transvergent diagram and a symmetric knotoid

3.1. Construction from an intravergent diagram and knotoid

As Boyle and Issa note in [12, Proposition 1], Seifert's algorithm applied to an intravergent diagram produces an invariant Seifert surface. To be precise, for a marked strongly invertible knot (K, h, δ) , let Γ be an intravergent diagram of the strongly invertible knot (K, h) , such that δ is the crossing arc at the crossing through which the axis passes. Then, by applying Seifert's algorithm to Γ , we obtain an invariant Seifert surface for (K, h, δ) (Figure 3.1(b)).

By cutting the over- or under-path which contains a fixed point, we have a rotationally symmetric knotoid diagram Γ' (Figure 3.1(c)). By applying Seifert's smoothing to Γ' , one obtains Seifert circles and an arc. Then replacing the arc

by a thin disk, we have an invariant Seifert surface for (K, h, δ) (see Figure 3.1(d)). Note that these surfaces in general have different genera.

3.2. Construction from a transvergent diagram

In order to construct an invariant Seifert surface from a transvergent diagram of a strongly invertible knot (K, h) , we consider the quotient θ -curve $\theta(K, h)$ defined as follows. Let $\pi : S^3 \rightarrow S^3/h \cong S^3$ be the projection. Then $O := \pi(\text{Fix}(h))$ is a trivial knot and $k := \pi(K)$ is an arc such that $O \cap k = \partial k$. Thus the union $\theta(K, h) := O \cup k$ forms a θ -curve embedded in S^3 : we call it the *quotient θ -curve* of the strongly invertible knot (K, h) . For a marked strongly invertible knot (K, h, δ) , set $\check{\delta} := \pi(\delta)$ and $\check{K} := k \cup \check{\delta}$ (Figure 3.2).

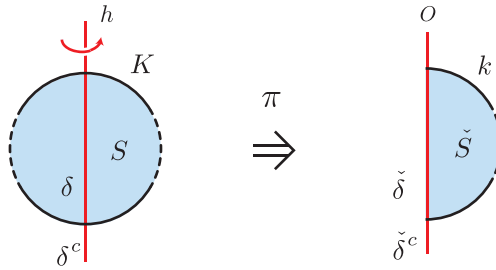

FIGURE 3.2. The quotient θ -curve $\theta(K, h) = O \cup k$ and the constituent knot $\check{K} = k \cup \check{\delta} = \pi(K \cup \delta)$. Note that $\theta(K, h)$ consists of three edges $k = \pi(K)$, $\check{\delta} = \pi(\delta)$ and $\check{\delta}^c = \pi(\text{cl}(\text{Fix}(h) \setminus \delta)) = \text{cl}(O \setminus \check{\delta})$.

Observe that if S is an h -invariant Seifert surface for (K, h, δ) , then its image $\check{S} := \pi(S)$ in S^3/h is a *spanning surface* for the knot \check{K} , i.e., a compact surface in S^3/h with boundary \check{K} , which is disjoint from the interior of the arc $\check{\delta}^c := \text{cl}(O \setminus \check{\delta})$. Conversely, if \check{S} is a spanning surface for \check{K} which is disjoint from the interior of the arc $\check{\delta}^c$, then its inverse image $\pi^{-1}(\check{S})$ is an h -invariant spanning surface for (K, h, δ) , namely an h -invariant spanning surface for K whose intersection with $\text{Fix}(h)$ is equal to δ . However, $\pi^{-1}(\check{S})$ is not necessarily orientable. The following proposition gives a necessary and sufficient condition for $\pi^{-1}(\check{S})$ to be orientable and so an invariant Seifert surface for (K, h, δ) .

Proposition 3.2. *Under the above notation, the following hold for every marked strongly invertible knot (K, h, δ) .*

(1) *If S is an invariant Seifert surface for (K, h, δ) , then its image $\check{S} = \pi(S)$ in S^3/h is a spanning surface for $\check{K} = k \cup \check{\delta}$ disjoint from the interior of $\check{\delta}^c$, and satisfies the following condition.*

(C) For any loop γ in $\text{int } \check{S}$, γ is orientation-preserving or -reversing in \check{S} according to whether the linking number $\text{lk}(\gamma, O)$ is even or odd.

(2) Conversely, if \check{S} is a spanning surface for the knot \check{K} in S^3/h which is disjoint from the interior of $\check{\delta}^c$ and satisfies Condition (C), then its inverse image $\pi^{-1}(\check{S})$ in S^3 is an invariant Seifert surface for (K, h, δ)

Proof. (1) Note that $\check{S} \cong S/h$ is regarded as an orbifold which has $\check{\delta}$ as a reflector line. We consider an ‘‘orbifold handle decomposition’’ $\check{S} = D \cup (\cup_i B_i)$, where (a) D is an ‘‘orbifold 0-handle’’, namely D is a disk such that $\partial \check{S} \cap D = \check{\delta}$, and (b) $\{B_i\}$ are 1-handles attached to D , namely each B_i is a disk such that $B_i \cap D = \partial B_i \cap \partial D$ consists of two mutually disjoint arcs which are disjoint from the reflector line $\check{\delta}$. This handle decomposition of the orbifold \check{S} lifts to the handle decomposition $S = \pi^{-1}(D) \cup (\cup_i \pi^{-1}(B_i))$ of the surface S , where $\pi^{-1}(D)$ is an h -invariant 0-handle and each $\pi^{-1}(B_i)$ consists of a pair of 1-handles attached to the disk $\pi^{-1}(D)$. For each i , $D \cup B_i$ is an annulus or a Möbius band which is obtained as the quotient of the orientable surface $\pi^{-1}(D \cup B_i) \subset S$ by the (restriction of) the involution h . Let γ_i be a core loop of $D \cup B_i$. Then we can see that the projection $\pi : \pi^{-1}(D \cup B_i) \rightarrow D \cup B_i$ is as shown in Figure 3.3(a), (b) according to whether $\text{lk}(\gamma_i, O)$ is even or odd. Hence $D \cup B_i$ is an annulus or a Möbius band accordingly. Since the homology classes of $\{\gamma_i\}$ generate $H_1(\check{S})$, this observation implies that \check{S} satisfies Condition (C).

(2) This can be proved by reversing the above argument. □

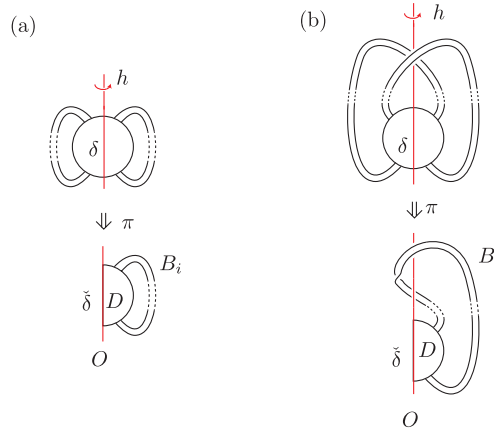

FIGURE 3.3. The band $D \cup B_i$ (bottom) and its inverse image $\pi^{-1}(D \cup B_i)$ (top). The linking number $\text{lk}(\gamma_i, O)$ is even in (a) and odd in (b).

Remark 3.3. (1) Condition (C) is equivalent to the condition that the homomorphism $\iota : H_1(\check{S}; \mathbb{Z}/2\mathbb{Z}) \rightarrow \mathbb{Z}/2\mathbb{Z}$ defined by $\iota(\gamma) := \text{lk}(O, \gamma) \pmod{2}$ is identical with the orientation homomorphism.

(2) We have $\beta_1(S) = 2\beta_1(\check{S})$, where β_1 denotes the first Betti number, because if b is the number of 1-handles $\{B_i\}$ in the proof, then $\beta_1(\check{S}) = b$ and $\beta_1(S) = 2b$.

From a given transversent diagram of a strongly invertible knot (K, h) , we can easily draw a diagram of the quotient θ -curve $\theta(K, h)$ (see Figure 3.5(b)). There are various ways of modifying the diagram into a “good” diagram from which we can construct a surface \check{S} for $\theta(K, h)$ that satisfies the conditions in Proposition 3.2.

Hiura [31] gave an algorithm for obtaining such a diagram of $\theta(K, h) = O \cup k$ as follows (see Figure 3.4).

- (a) Let k hook $O \setminus \check{\delta}$ in even times in the uniform way.
- (b) Travel along k and enumerate the hooks from 1 to $2n$. Then slide the hooks so that they are paired and arranged from the top to the bottom along O . Note that one travels between $(2i - 1)^{\text{st}}$ and $(2i)^{\text{th}}$ hooks in one of the four routine ways according to the orientation of the hooks.
- (c) Surger k along the bands $\{B_i\}_{i=1}^n$ arising in the pairs of hooks to obtain a set of arcs k' . Arrangement in (b) allows us to reset the orientation of k' as depicted.

Apply Seifert algorithm to $k' \cup \check{\delta}$ to obtain a Seifert surface S' . Then attaching the bands $\{B_i\}_{i=1}^n$ to S' yields a spanning surface \check{S} for $k \cup \check{\delta}$ which satisfies the conditions in Proposition 3.2(2). Therefore, the inverse image $S := \pi^{-1}(\check{S})$ is an invariant Seifert surface for (K, h, δ) .

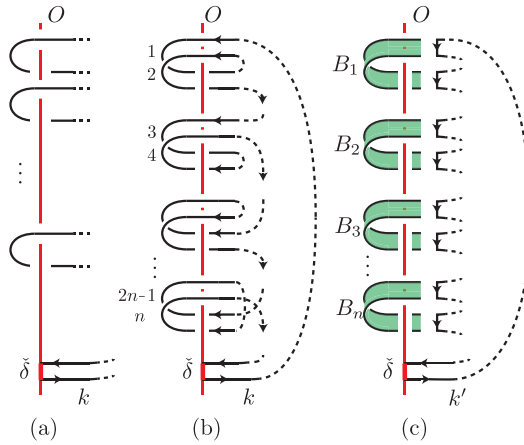

FIGURE 3.4. Hiura’s algorithm to obtain an invariant Seifert surface from an intravergent diagram

Example 3.4. Let (K, h, δ) be the marked strongly invertible knot with $K = 8_3$ as illustrated by the transvergent diagram in Figure 3.5(a). Then by applying the algorithm to the diagram, we obtain a genus 2 invariant Seifert surface S for (K, h, δ) as shown in Figure 3.5(c). This is a minimal genus Seifert surface for (K, h, δ) and so $g(K, h, \delta) = 2$, as shown below. By Hatcher-Thurston [27, Theorem 1] or by Kakimizu [35] succeeding the work of Kobayashi [38], 8_3 has precisely two genus 1 Seifert surfaces up to equivalence. (They are obtained by applying Seifert's algorithm to the alternating diagram, where there are two different ways of attaching a disk to the unique big Seifert circle.) Obviously they are interchanged by h , and hence not h -invariant.

Kakimizu [35] in fact showed that the two genus 1 Seifert surfaces are the only incompressible Seifert surfaces for 8_3 . Thus 8_3 does not even admit an h -invariant incompressible Seifert surface. So the result of Edmonds and Livingston [25, Corollary 2.2] that every periodic knot admits an invariant incompressible Seifert surface does not hold for strongly invertible knots.

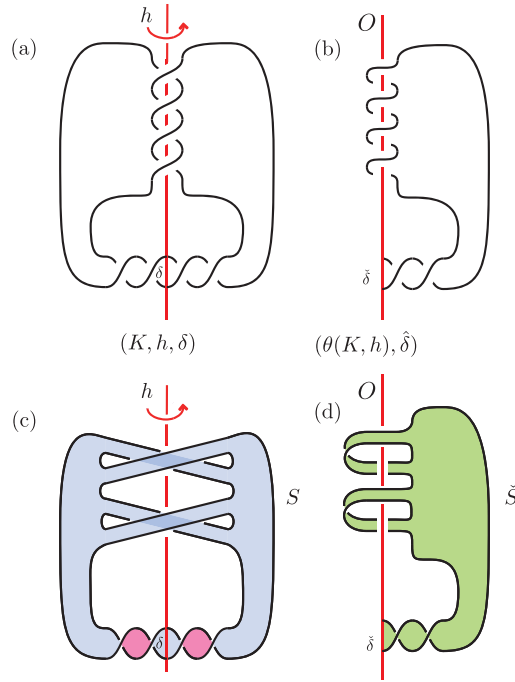

FIGURE 3.5. A transvergent diagram for 8_3 and an invariant Seifert surface

4. PROOF OF THEOREM 1.2

By Proposition 3.2 and Remark 3.3, we can characterize the equivariant genus $g(K, h, \delta)$ in terms of the quotient θ -curve $\theta(K, h) = k \cup \check{\delta} \cup \check{\delta}^c$ and the constituent knot $\check{K} = k \cup \check{\delta}$ as follows.

Proposition 4.1. *Let (K, h, δ) be a marked strongly invertible knot. Then $g(K, h, \delta)$ is equal to the minimum of $\beta_1(\check{S})$ where \check{S} runs over the spanning surfaces for the constituent knot $\check{K} = k \cup \check{\delta}$ of the quotient θ -curve $\theta(K, h)$ that is disjoint from the interior of the remaining edge $\check{\delta}^c$ and satisfies Condition (C).*

By relaxing the definition of the crosscap number $\gamma(K)$, of a knot K introduced by Clark [17], we define the *band number* $b(K)$, to be the minimum of $\beta_1(G)$ of all spanning surfaces G for K (see Murakami-Yasuhara [47]). In other words, $b(K) = \min(2g(K), \gamma(K))$. Then we have the following corollary.

Corollary 4.2. $g(K, h, \delta) \geq b(\check{K})$.

For any marked strongly invertible knot (K, h, δ) with K a 2-bridge knot, the constituent knot \check{K} is either the trivial knot or a 2-bridge knot (see [54, Proposition 3.6]). In his master thesis [6] supervised by the last author, Bessho described a method for determining the cross cap numbers of 2-bridge knots by using the result of Hatcher and Thurston [27, Theorem 1(b)] that classifies the incompressible and boundary incompressible surfaces in the 2-bridge knot exteriors. Hirasawa and Teragaito [30] promoted the method into a very effective algorithm. For some classes of marked strongly invertible 2-bridge knots, we can apply Corollary 4.2 by using Hirasawa-Teragaito method, as shown in the following example.

Example 4.3. For a positive integer n , let K_n be the the plat closure of a 4-string braid $(\sigma_2^2 \sigma_1^4)^n$. Then K_n is the 2-bridge knot whose slope q/p has the continued fraction expansion $[2, 4, 2, 4, \dots, 2, 4]$ of length $2n$. Here we employ the following convention of continued fraction expansion, which is used in [30].

$$[a_1, a_2, \dots, a_m] := \frac{1}{a_1 - \frac{1}{a_2 - \frac{1}{\ddots - \frac{1}{a_m}}}}$$

Thus K_n is the boundary of a linear plumbing of unknotted annuli where the i^{th} band has 2 or 4 right-handed half-twists according to whether i is odd or even (see [27, Fig. 2]). In particular, $g(K_n) = n$. Note that K_n is isotopic to the knot admitting the strong inversion h in Figure 4.1(a). Let (K_n, h, δ) be the marked strongly invertible knot, where δ is the long arc in $\text{Fix}(h)$ bounded by $\text{Fix}(h) \cap K_n$ illustrated in Figure 4.1(a). Then we have $g(K_n, h, \delta) = 2n = g(K_n) + n$, as explained below.

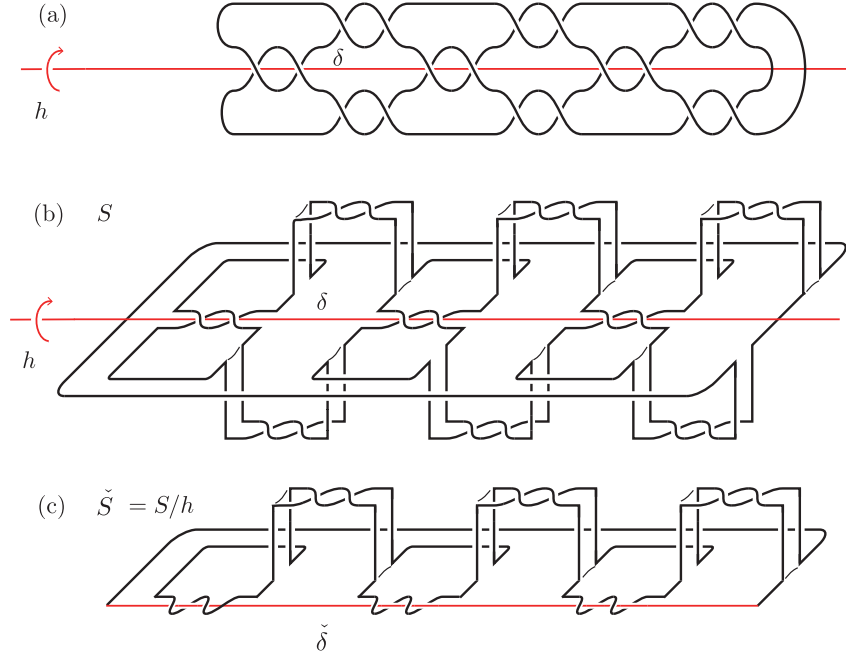

FIGURE 4.1. A Seifert surface realizing the equivariant genus

Observe that (K_n, h, δ) is equivalent to the marked strongly invertible knot bounding the h -invariant Seifert surface S of genus $2n$ in Figure 4.1(b). Consider the quotient surface $\check{S} = S/h$, which is a spanning surface for the knot $\check{K} := k \cup \check{\delta}$. We show that the band number $b(\check{K})$ is equal to $\beta_1(\check{S})$. Then it follows from Corollary 4.2 that S is a minimal genus Seifert surface for (K_n, h, δ) . To this end, observe that \check{K} is the 2-bridge knot whose slope has the continued fraction expansion $\mathcal{C} := [4, 2, 4, 2, \dots, 4, 2]$ of length $2n$ (Figure 4.1(c)). Since \mathcal{C} does not contain an entry $0, -1, 1$ and since \mathcal{C} does not contain a sub-sequence $\pm[\dots, 2, 3, \dots, 3, 2, \dots]$ nor $\pm[\dots, 2, 2, \dots]$, it follows from [30, Theorems 2 and 3], that the length $2n$ of \mathcal{C} is minimal among all continued fraction expansions of all fractions representing \check{K} . Then it follows from [27, Theorem 1(b)] that $b(\check{K}) = \beta_1(\check{S}) = 2n$ as desired.

Theorem 1.2 follows from the above example and Proposition 1.5, which is proved at the end of Section 5. Though the above method is also applicable to a certain family of marked strongly invertible 2-bridge knots, there are various cases where the above simple method does not work. In fact, there is a case where the knot $\check{K} = k \cup \check{\delta}$ is trivial (see Figure 3.5). The second author [31] treated such a family by applying the method in [27] to such spanning surfaces as in Proposition 4.1. However, there

still remained cases where none of the methods described above work. In the sequel of this paper [28], we give a unified determination of the equivariant genera of all marked strongly invertible 2-bridge knots using sutured manifolds. Theorem 1.4 enabled us to do that without invoking [27] or [30].

5. PROOF OF THEOREMS 1.3 AND 1.4

For a knot K in S^3 , let $E(K) := S^3 \setminus \text{int } N(K)$ be the *exterior* of K , where $N(K)$ is a regular neighborhood of K . If F is a Seifert surface for K , then after an isotopy, F intersects $N(K)$ in a collar neighborhood of ∂F , and $F \cap E(K)$ is a surface properly embedded in $E(K)$ whose boundary is a *preferred longitude*, i.e., a longitude of the solid torus $N(K)$ whose linking number with K is 0. Conversely, any such surface in $E(K)$ determines a Seifert surface for K . Thus we also call such a surface in $E(K)$ a *Seifert surface* for K .

Proof of Theorem 1.3. We give a proof imitating the arguments by Edmonds [24]. Let (K, h) be a strongly invertible knot, and let $E := E(K)$ be an h -invariant exterior of K . We continue to denote by h the restriction of h to E . Then Theorem 1.3 is equivalent to the existence of a minimal genus Seifert surface $F \subset E$ for K such that $F \cap h(F) = \emptyset$.

Fix an h -invariant Riemannian metric on E such that ∂E is convex. Choose a preferred longitude $\ell_0 \subset \partial E$ of K such that ℓ_0 and $\ell_1 := h(\ell_0)$ are disjoint. Let F^* be a smooth, compact, connected, orientable surface of genus $g(K)$ with one boundary component, $\psi_0 : \partial F^* \rightarrow \partial E$ an embedding such that $\psi_0(\partial F^*) = \ell_0$, and set $\psi_1 := h\psi_0$. For $i = 0, 1$, let \mathcal{F}_i be the space of all piecewise smooth maps $f : (F^*, \partial F^*) \rightarrow (E, \ell_i)$ properly homotopic to an embedding, such that $f|_{\partial F^*} = \psi_i$. Then we have the following [24, Proposition 1].

Lemma 5.1. *Each \mathcal{F}_i contains an area minimizer, namely, there exists an element $f_i \in \mathcal{F}_i$ whose area is minimum among the areas of all elements of \mathcal{F}_i . Moreover, any area minimizer in \mathcal{F}_i is an embedding.*

Since h is an isometric involution, it follows that f_i is an area minimizer in \mathcal{F}_i if and only if hf_i is an area minimizer in \mathcal{F}_j , where $\{i, j\} = \{0, 1\}$. Thus Theorem 1.3 follows from the following analogue of [24, Theorem 2]. \square

Theorem 5.2. *For $i = 0, 1$, let f_i be an area minimizer in \mathcal{F}_i , and $F_i \subset E$ the minimal genus Seifert surface for K obtained as the image of f_i . Then F_0 and F_1 are disjoint.*

Proof. The proof is the same as [24, Proof of Theorem 2], as explained below. Suppose to the contrary that $F_0 \cap F_1 \neq \emptyset$. We first assume that F_0 and F_1 intersect transversely. Then, by the arguments in [24, the 3rd to the 6th paragraphs of the proof of Theorem 2] using the area minimality and the incompressibility of F_i

($i = 0, 1$) and the asphericity of E , it follows that every component of $F_0 \cap F_1$ is essential in both F_0 and F_1 .

By the arguments in [24, the 7th to the final paragraphs of the proof of Theorem 2], we see that there is a submanifold W in E satisfying the following conditions.

- (a) $\partial W = A \cup B$ where $A = W \cap F_0$ and $B = W \cap F_1$.
- (b) Both $(F_0 \setminus A) \cup B$ and $(F_1 \setminus B) \cup A$ are minimal genus Seifert surfaces.

Since $(F_0 \setminus A) \cup B$ and $(F_1 \setminus B) \cup A$ have corners, smoothing them reduces area and yields two minimal genus Seifert surfaces, at least one of which has less area than F_0 or F_1 , a contradiction.

Finally, we explain the generic case where F_0 and F_1 are not necessarily transversal. As is noted in [24, the 2nd paragraph of the proof of Theorem 2], by virtue of the Meeks-Yau trick introduced in [45] and discussed in [26], we can reduce to the case where F_0 and F_1 intersect transversely as follows. By [26, Lemma 1.4], we have a precise picture of the situation where F_0 and F_1 are non-transversal (see [26, Figure 1.2]). By using this fact, F_0 is perturbed slightly to a surface F'_0 , so that (a) F'_0 and F_1 intersect transversely and nontrivially, and (b) the difference $\text{Area}(F'_0) - \text{Area}(F_0)$ is less than a lower bound estimate for the area reduction to be achieved as in the preceding paragraphs. Thus the assumption $F_0 \cap F_1 \neq \emptyset$ again leads to a contradiction. \square

Proof of Theorem 1.4. Throughout the proof we use the following terminology: for a topological space X and its subspace Y , a *closed-up component* of $X \setminus Y$ means the closure in X of a component of $X \setminus Y$. Let (K, h, δ) be a marked strongly invertible knot and let E and h be as in the proof of Theorem 1.3. Then $\text{Fix}(h) \subset E$ is the disjoint union of two arcs $\delta \sqcup \delta^c$, where δ denotes the intersection of the original δ with E and $\delta^c = \text{Fix}(h) \setminus \delta$. Then, by the assumption of Theorem 1.4, there is a minimal genus Seifert surface $F \subset E$ such that $F \cap h(F) = \emptyset$. Let E_δ and E_{δ^c} be the closed-up components of $E(K) \setminus (F \cup h(F))$ containing δ and δ^c , respectively. Then there is a minimal genus Seifert surface $S \subset E$ for (K, h, δ) such that ∂S is contained in the interior of the annulus $\partial E \cap \partial E_\delta$. We will construct from S a minimal genus Seifert surface for (K, h, δ) which is properly embedded in $E_\delta \setminus (F \cup h(F))$.

Claim 1. We can choose S so that S intersects $F \cup h(F)$ transversely and so that every component of $S \cap (F \cup h(F))$ is essential in both S and $F \cup h(F)$.

Proof. Since $F \cap h(F) = \emptyset$, we can h -equivariantly isotope S so that it intersects $F \cup h(F)$ transversely. Then $S \cap (F \cup h(F))$ consists of simple loops, because the boundaries of S and $F \cup h(F)$ are disjoint.

Suppose first that $S \cap (F \cup h(F))$ contains a component that is inessential in $F \cup h(F)$. Let α be one such component which is innermost in $F \cup h(F)$, and let Δ be the disk in $F \cup h(F)$ bounded by α . Then $\Delta \cap S = \partial \Delta$, $h(\Delta) \cap S = \partial(h(\Delta))$, and $\Delta \cap h(\Delta) = \emptyset$. Let S' be the h -invariant surface obtained from S by surgery along $\Delta \cup h(\Delta)$, i.e., S' is obtained from S by removing an h -invariant open regular

neighborhood of $\partial(\Delta \cup h(\Delta))$ in S and capping off the resulting four boundary circles with nearby parallel h -equivariant copies of Δ and $h(\Delta)$. Let S'_b be the component of S' containing ∂S . Then S'_b is a Seifert surface for (K, h, δ) such that $g(S'_b) \leq g(S) = g(K, h, \delta)$. Hence S'_b is also a minimal genus Seifert surface for (K, h, δ) . Moreover $|S'_b \cap (F \cup h(F))| \leq |S \cap (F \cup h(F))| - 2$, where $|\cdot|$ denotes the number of the connected components.

Suppose next that $S \cap (F \cup h(F))$ contains a component that is inessential in S . Let α be one such component which is innermost in S . Then α is also inessential in $F \cup h(F)$ by the incompressibility of $F \cup h(F)$. So, by the argument in the preceding paragraph, we obtain a minimal genus Seifert surface S'_b for (K, h, δ) such that $|S'_b \cap (F \cup h(F))| \leq |S \cap (F \cup h(F))| - 2$.

By repeating the above arguments, we can find a desired minimal genus Seifert surface for (K, h, δ) . \square

Let $p : \tilde{E} \rightarrow E$ be the infinite cyclic covering, and let E_j ($j \in \mathbb{Z}$) be the closed-up components of $\tilde{E} \setminus p^{-1}(F \cup h(F))$ satisfying the following conditions.

- (1) $\tilde{E} = \cup_{j \in \mathbb{Z}} E_j$.
- (2) E_j projects homeomorphically onto E_δ or E_{δ^c} according to whether j is even or odd.
- (3) $F_j := E_{j-1} \cap E_j$ projects homeomorphically onto F or $h(F)$ according to whether j is even or odd.

For each $j \in \mathbb{Z}$, let h_j be the involution on \tilde{E} which is a lift of h such that $h_j(E_j) = E_j$. Note that $h_j(E_i) = E_{2j-i}$ and that $\text{Fix}(h_j)$ is a properly embedded arc in E_j which projects to δ or δ^c according to whether j is even or odd. The composition $\tau := h_{j+1}h_j$ is independent of j , and gives a generator of the covering transformation group of \tilde{E} , such that $\tau(E_i) = E_{i+2}$ and $\tau(F_i) = F_{i+2}$ for every i .

Note that $p^{-1}(S) = \sqcup_{i \in \mathbb{Z}} S_{2i}$, where S_{2i} is the lift of S preserved by h_{2i} . Let $r := \max\{j \in \mathbb{Z} \mid S_0 \cap E_j \neq \emptyset\}$, and assume that the number r is minimized among all minimal genus Seifert surfaces S for (K, h, δ) that satisfy the conclusion of Claim 1. Then Theorem 1.3 is equivalent to the assertion that $r = 0$.

Suppose to the contrary that $r > 0$. Let S_0^- be the closed-up component of $\tilde{E} \setminus S_0$ containing $S_{-2} = \tau^{-1}(S_0)$. Set $\tilde{W} := S_0^- \cap E_r$ and $W := p(\tilde{W})$. Since $\tilde{W} \subset E_r$, $p|_{\tilde{W}} : \tilde{W} \rightarrow W$ is a homeomorphism. (See Figure 5.1.)

Claim 2. W is a (possibly disconnected) compact 3-manifold contained in $\text{int } E$ such that $\partial W = A \cup B$, where $A = S \cap W$, $B = p(F_r) \cap W$, and $A \cap B = p(S_0 \cap F_r) \subset S \cap p(F_r)$. Here $p(F_r) = F$ or $h(F)$ according to whether r is even or odd.

Proof. Note that $S_0^- \cap \partial \tilde{E}$ is the half-infinite annulus in $\partial \tilde{E}$ which forms the closed-up component of $\partial \tilde{E} \setminus \partial S_0$ disjoint from ∂F_1 . On the other hand, $E_r \cap \partial \tilde{E}$ is the annulus in $\partial \tilde{E}$ bounded by ∂F_r and ∂F_{r+1} . Since $r > 0$ by the assumption, these imply that $S_0^- \cap \partial \tilde{E}$ and $E_r \cap \partial \tilde{E}$ are disjoint. Hence \tilde{W} is disjoint from $\partial \tilde{E}$ and so

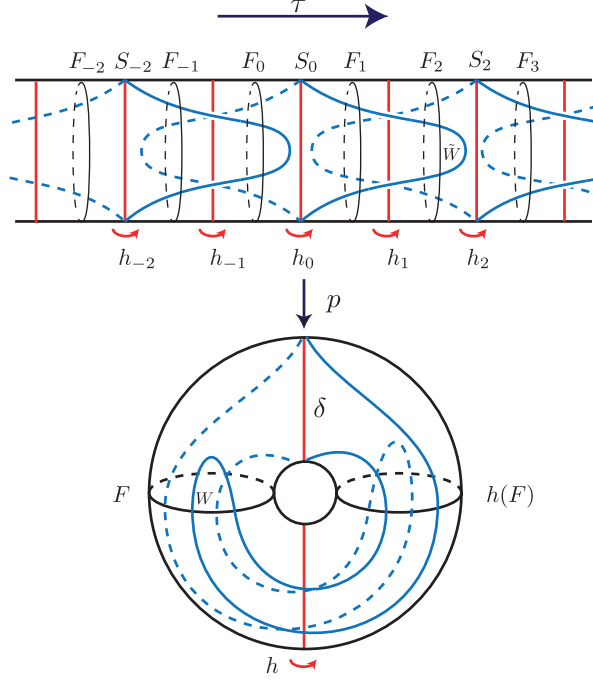

FIGURE 5.1. Schematic picture of $p : \tilde{E} \rightarrow E$, where $r = 2$. The picture does not reflect the assumption that the boundaries of F , $h(F)$ and S are disjoint.

$\tilde{W} \subset \text{int } \tilde{E}$. Note that $\text{fr } S_0^- = S_0$ and $\text{fr } E_r = F_r \sqcup F_{r+1}$ intersect transversely (Claim 1), where $S_0^- \cap F_{r+1} = \emptyset$. (Here $\text{fr } Y$ with $Y = S_0^-, E_r$ denotes the frontier of Y in \tilde{E} , namely the closure of Y in \tilde{E} minus the interior of Y in \tilde{E} .) Hence \tilde{W} is a compact 3-manifold contained in $\text{int } \tilde{E}$, such that $\partial \tilde{W} = \tilde{A} \cup \tilde{B}$, where $\tilde{A} = (\text{fr } S_0^-) \cap \tilde{W} = S_0 \cap \tilde{W}$, $\tilde{B} = (\text{fr } E_r) \cap \tilde{W} = F_r \cap \tilde{W}$, and $\tilde{A} \cap \tilde{B} = (S_0 \cap \tilde{W}) \cap (F_r \cap \tilde{W}) = S_0 \cap F_r$. Since $p|_{\tilde{W}} : \tilde{W} \rightarrow W$ is a homeomorphism, these imply the claim. \square

Claim 3. $W \cap h(W) = \emptyset$.

Proof. Since the restriction $p|_{E_r}$ is a homeomorphism onto its image $p(E_r)$ (which is equal to E_δ or E_{δ^c} according to whether r is even or odd) and since the involution $h|_{p(E_r)}$ is pulled back to the involution $h_r|_{E_r}$ by $p|_{E_r}$, it follows that $p|_{E_r}$ restricts to a homeomorphism from $\tilde{W} \cap h_r(\tilde{W})$ onto $W \cap h(W)$. On the other hand, we have

$$\tilde{W} \cap h_r(\tilde{W}) = (S_0^- \cap E_r) \cap h_r(S_0^- \cap E_r) = (S_0^- \cap h_r(S_0^-)) \cap E_r = \emptyset \cap E_r = \emptyset,$$

where the third identity is verified as follows. Recall that S_0^- is the closed-up component of $\tilde{E} \setminus S_0$ containing S_{-2} . Thus $h_r(S_0^-)$ is the closed-up component of $\tilde{E} \setminus h_r(S_0) = \tilde{E} \setminus S_{2r}$ containing $h_r(S_{-2}) = S_{2r+2}$. Since $r > 0$, this implies $S_0^- \cap h_r(S_0^-) = \emptyset$. Hence $W \cap h(W) = p(\tilde{W} \cap h_r(\tilde{W})) = \emptyset$ as desired. \square

We perform an h -equivariant cut and paste operation on $S \cup F \cup h(F)$ along $W \cup h(W)$, and produce surfaces $S' = S'_b \sqcup S'_c$, $F' = F'_b \sqcup F'_c$ and $h(F') = h(F'_b) \sqcup h(F'_c)$ as follows.

- (1) $S' := (S \setminus (A \cup h(A))) \cup (B \cup h(B))$, S'_b is the component of S' containing ∂S , and $S'_c := S' \setminus S'_b$.
- (2) $F' := (F \setminus B) \cup A$, F'_b is the component of F' containing ∂F , and $F'_c := F' \setminus F'_b$.

Then S'_b is a Seifert surface for (K, h, δ) , and both F'_b and $h(F'_b)$ are Seifert surfaces for K . Let Σ be the disjoint union of copies of S'_c , F'_c and $h(F'_c)$. Then Σ is a possibly empty, closed, orientable surface, such that $\chi(\Sigma) = \chi(S'_c \cup F'_c \cup h(F'_c))$. (Note that the intersection among S'_c , F'_c and $h(F'_c)$ consists of disjoint loops.) Since S and $F \cup h(F)$ intersects in essential loops by Claim 1, none of the components of Σ is a 2-sphere and therefore $\chi(\Sigma) \leq 0$. Hence

$$\begin{aligned} \chi(S'_b) + \chi(F'_b) + \chi(h(F'_b)) &\geq \chi(S'_b) + \chi(F'_b) + \chi(h(F'_b)) + \chi(\Sigma) \\ &= \chi(S) + \chi(F) + \chi(h(F)). \end{aligned}$$

Since $g(F) = g(K) \leq g(F'_b)$, this implies

$$\chi(S'_b) \geq \chi(S) + (\chi(F) - \chi(F'_b)) + (\chi(h(F)) - \chi(h(F'_b))) \geq \chi(S).$$

Hence $g(S'_b) \leq g(S) = g(K, h, \delta)$, and therefore S'_b is also a minimal genus Seifert surface for (K, h, δ) .

Note that the h_0 -invariant lift of S'_b is obtained from $S_0 \subset \tilde{E}$ by cut and paste operation along $\tilde{W} \cup h_0(\tilde{W})$ and so it is contained in the region of \tilde{E} bounded by F_{1-r} and F_r . After a small h -equivariant isotopy of S'_b , the lift is contained in the interior of that region, and hence the number r for S'_b is strictly smaller than the original r . This contradicts the minimality of r . Hence we have $r = 0$ as desired. \square

The following example illustrates Theorems 1.3, 1.4. and Corollary 1.6.

Example 5.3. Let S be the invariant Seifert surface for $K = 8_3$ constructed in Example 3.4. Then the loop α in Figure 5.2 is a compressing loop of S on the positive side, and $h(\alpha)$ is a compressing loop of S on the negative side. Note that α and $h(\alpha)$ intersect nontrivially, and therefore $\{\alpha, h(\alpha)\}$ does not yield an h -equivariant compression of S . Consider a parallel copy S_+ of S on the positive side, and let F_+ be the minimal genus Seifert surface obtained by compressing S_+ along a parallel copy of α on S_+ . Then $F_- := h(F_+)$ is obtained from the parallel copy $h(S_+)$ of S on the negative side through compression along a parallel copy of

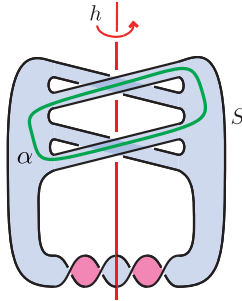

FIGURE 5.2. The invariant Seifert surface S and its compressing loop α on the positive side

$h(\alpha) \subset h(S_+)$. The minimal genus Seifert surfaces F_+ and $F_- = h(F_+)$ are disjoint, and S lies in a region between them.

As noted in Example 3.4, $K = 8_3$ has precisely two minimal genus Seifert surfaces up to equivalence, and the Kakimizu complex $MS(K)$ consists of a single edge and two vertices. The automorphism h_* of $MS(K)$ induced by h is the reflection in the center of the 1-simplex.

Finally, we prove Proposition 1.5 for fibered knots.

Proof of Proposition 1.5. Let $p : E(K) \rightarrow S^1$ be the fibering whose fibers are minimal genus Seifert surfaces for K . By the result of Tollefson [57, Theorem 2], we may assume that the involution h on $E(K)$ preserves the fibering and that the involution \check{h} on S^1 induced from h is given by $\check{h}(z) = \bar{z}$, where we identify S^1 with the unit circle on the complex plane. Then the inverse image $p^{-1}(\pm 1)$ gives a pair of h -invariant Seifert surfaces for K with genus $g(K)$. Since these give Seifert surfaces for the two marked strongly invertible knots associated with (K, h) , we have $g(K, h, \delta) = g(K)$ as desired. \square

6. EQUIVARIANT 4-GENUS

In this section, we review old and new studies of equivariant 4-genera of symmetric knots. For a periodic knot or a strongly invertible knot K , one can define the *equivariant 4-genus* $\tilde{g}_4(K)$ to be the minimum of the genera of smooth surfaces in B^4 bounded by K that are invariant by a periodic diffeomorphism of B^4 extending the periodic diffeomorphism realizing the symmetry of K . (Here, the symbol expressing the symmetry is suppressed in the symbol $\tilde{g}_4(K)$.) Of course, $\tilde{g}_4(K)$ is bounded below by the 4-genus $g_4(K)$, and it is invariant by equivariant cobordism.

The equivariant cobordism of periodic knots was studied by Naik [49], where she gave criteria for a given periodic knot to be equivariantly slice, in terms of the

linking number and the homology of the double branched covering. By using the criteria, she presented examples of slice periodic knots which are not equivariantly slice. (See Davis-Naik [22] and Cha-Ko [16] for further development.)

The equivariant cobordism of strongly invertible knots was studied by the third author [54], where the notion of directed strongly invertible knots was introduced so that the connected sum is well-defined, and it was observed that the set $\tilde{\mathcal{C}}$ of the directed strongly invertible knots modulo equivariant cobordism form a group with respect to the connected sum. He then introduced a polynomial invariant $\eta : \tilde{\mathcal{C}} \rightarrow \mathbb{Z}\langle t \rangle$ which is a group homomorphism, and presented a slice strongly invertible knot that is not equivariantly slice. We note that it was recently proved by Prisa [51] that the group $\tilde{\mathcal{C}}$ is not abelian.

These two old works show that there is a gap between the (usual) 4-genus $g_4(K)$ and the equivariant 4-genus $\tilde{g}_4(K)$ for both periodic knots and strongly invertible knots.

In a recent series of works [12, 13, 4, 14, 10, 11], Boyle and his coworkers launched a project to systematically study the equivariant 4-genera of symmetric knots. It should be noted that they treat not only periodic/strongly-invertible knots, but also freely periodic knots and strongly negative amphicheiral knots. In [12, Theorems 2 and 3], Boyle and Issa gave a lower bound of $\tilde{g}_4(K)$ of a periodic knot K in terms of the signatures of K and its quotient knot, and showed that the gap between $g_4(K)$ and $\tilde{g}_4(K)$ can be arbitrary large. They also introduced the notion of the butterfly 4-genus $\tilde{b}g_4(K)$ of a directed (or marked) strongly invertible knot K , gave an estimate of $\tilde{b}g_4(K)$ in terms of the g -signature, and showed that the gap between $g_4(K)$ and $\tilde{b}g_4(K)$ can be arbitrary large [12, Theorem 4].

In [21], Dai, Mallick and Stoffregen introduced equivariant concordance invariants of strongly invertible knots using knot Floer homology, and showed that the gap between the equivariant 4-genus $\tilde{g}_4(K)$ and the genus $g(K)$ for marked strongly invertible knots can be arbitrary large, proving the conjecture [12, Question 1.1] by Boyle and Issa. In fact, they constructed a homomorphism from $\tilde{\mathcal{C}}$ to a certain group \mathfrak{K} , which is not a priori abelian. By using the invariant, they proved that, for the knot K_n defined as the connected sum $K_n := (T_{2n,2n+1} \# T_{2n,2n+1}) \# -(T_{2n,2n+1} \# T_{2n,2n+1})$, the equivariant 4-genus $\tilde{g}_4(K_n)$, with respect to some strong inversion, is at least $2n - 2$ [21, Theorem 1.4], whereas $g_4(K_n) = 0$. Here $T_{2n,2n+1}$ is the torus knot of type $(2n, 2n + 1)$, and “ $-$ ” denoted the reversed mirror image.

On the other hand, since K_n is fibered, the (3-dimensional) equivariant genera of the marked strongly invertible knots associated with K_n are equal to the genus $g(K_n) = 4n(2n - 1)$ (see Proposition 1.5), which is bigger than the estimate $2n - 2$ of $\tilde{g}_4(K_n)$ from below. As far as the authors know, there is no known algebraic invariant that gives an effective estimate of the (3-dimensional) equivariant genera of marked strongly invertible knots, though the (3-dimensional) genus of any knot is estimated by the the Alexander polynomial and moreover it is determined by the

Heegaard Floer homology (Ozsvath-Szabo [50, Theorem 1.2]). As is noted in [21], there has been a renewed interest in strongly invertible knots from the view point of more modern invariants (see Watson [61] and Lobb-Watson [41]). Thus we would like to pose the following question.

Question 6.1. Is there a computable algebraic invariant of a marked strongly invertible knot that gives an effective estimate of the equivariant genus, or more strongly, determines it? In other words, is there a computable, algebraically defined, integer-valued function $I: (K, h, \delta) \mapsto I(K, h, \delta)$ on the set of all marked strongly invertible knots up to equivalence, such that $g(K, h, \delta) \geq I(K, h, \delta)$ and that it does not descend to a function on $\tilde{\mathcal{C}}$?

The last requirement means that we have a chance to have a nontrivial estimate of $g(K, h, \delta)$ by using I even if the equivariant 4-genus is strictly smaller than the equivariant genus. If we drop this requirement, then such invariants are constructed in the above mentioned work by Dai, Mallick and Stoffregen [21]. If we restrict to the marked strongly invertible knots (K, h, δ) such that the constituent knot $\tilde{K} = k \cup \tilde{\delta}$ of the quotient θ -curve $\theta(K, h)$ is alternating, then the works by Kalfagianni and Lee [36], Ito and Takimura [32, 33] and Kindred [37] on crosscap numbers of alternating links give such invariants. In fact, their results together with the classical results by Murasugi [43] and Crowell [20] on the genera of alternating links estimate/determine the band number $b(\tilde{K}) = \min(2g(\tilde{K}), \gamma(\tilde{K}))$ of the alternating knot \tilde{K} in terms of the Jones polynomial of \tilde{K} . Since $g(K, h, \delta) \geq b(\tilde{K})$ by Corollary 4.2, the function I defined by $I(K, h, \delta) := b(\tilde{K})$ on the set of marked strongly invertible knots (K, h, δ) with alternating \tilde{K} satisfies the desired property. We note that all of the above mentioned works [36, 32, 33, 37] depend on the geometric study due to Adams and Kindred [2] which gives an algorithm for determining the cross cap numbers of prime alternating links. We also note Burton and Ozlen [15] present an algorithm that utilizes normal surface theory and integer programming to determine the crosscap numbers of generic knots. However, as far as we know, there are no computable algebraic invariants which give lower bounds of crosscap numbers of generic knots. Moreover, what we really need to estimate is the smallest Betti number of the spanning surfaces for \tilde{K} that satisfy the conditions in Proposition 4.1 (cf. Proposition 3.2).

Acknowledgements M.H. and M.S learned the theory of divides through a lecture by A'Campo in Osaka in 1999, and R.H. learned it through a lecture by A'Campo's former student Masaharu Ishikawa in Hiroshima in 2015. The theory of divides and discussions with A'Campo have been sources of inspiration for the authors. The authors would like to thank Professor Norbert A'Campo for invaluable discussions and encouragements. They would also like to thank the anonymous referee for his or her valuable comments and suggestions that helped them to improve the exposition.

M.H. is supported by JSPS KAKENHI JP18K03296. M.S. is supported by JSPS KAKENHI JP20K03614 and by Osaka Central Advanced Mathematical Institute (MEXT Joint Usage/Research Center on Mathematics and Theoretical Physics JP-MXP0619217849).

REFERENCES

- [1] N. A'Campo, *Generic immersions of curves, knots, monodromy and Gordian number*, Inst. Hautes Études Sci. Publ. Math. No. **88** (1998), 151–169.
- [2] C. Adams and T. A. Kindred, *A classification of spanning surfaces for alternating links*, *Algebr. Geom. Topol.* **13** (2013), no. 5, 2967–3007.
- [3] S. Aimi, D. Lee, S. Sakai and M. Sakuma, *Classification of parabolic generating pairs of Kleinian groups with two parabolic generators*, *Rend. Istit. Mat. Univ. Trieste* **52** (2020), 477–511.
- [4] A. Alfieri and K. Boyle, *Strongly invertible knots, invariant surfaces, and the Atiyah-Singer signature theorem*, arXiv:2109.09915.
- [5] A. Barbensi, D. Buck, H. A. Harrington and M. Lackenby, *Double branched covers of knotoids*, arXiv:1811.09121.
- [6] K. Bessho, *Incompressible surfaces bounded by links*, Master Thesis, Osaka University, 1994 (in Japanese).
- [7] M. Boileau, *Noeuds rigidelement inversibles*, Low-dimensional topology (Chelwood Gate, 1982), 1–18.
- [8] M. Boileau, B. Leeb and J. Porti, *Geometrization of 3-dimensional orbifolds*, *Ann. of Math.* **162** (2005), 195–290.
- [9] M. Boileau and J. Porti, *Geometrization of 3-orbifolds of cyclic type*, *Astérisque Monograph*, **272**, 2001.
- [10] K. Boyle and W. Chen, *Negative amphichiral knots and the half-Conway polynomial*, arXiv:2206.03598.
- [11] ———, *Equivariant topological slice disks and negative amphichiral knots*, arXiv:2207.12593
- [12] K. Boyle and A. Issa, *Equivariant 4-genera of strongly invertible and periodic knots*, arXiv:2101.05413.
- [13] ———, *Equivariantly slicing strongly negative amphichiral knots*, arXiv:2109.01198.
- [14] K. Boyle and J. Musyt, *Equivariant cobordisms between freely-periodic knot*, arXiv:2111.10678.
- [15] B. A. Burton, and M. Ozlen, *Computing the crosscap number of a knot using integer programming and normal surfaces*, *ACM Trans. Math. Software* **39** (2012), no. 1, Art. 4, 18 pp.
- [16] J. C. Cha and K. H. Ko, *On equivariant slice knots*, *Proc. Amer. Math. Soc.* **127** (1999), no. 7, 2175–2182.
- [17] B. E. Clark, *Crosscaps and knots*, *Internat. J. Math. Math. Sci.* **1** (1978), no. 1, 113–123.
- [18] D. Cooper, C. Hodgson and S. Kerckhoff, *Three-dimensional orbifolds and cone-manifolds*, *MSJ Memoirs* **5**, 2000.
- [19] O. Couture, *Strongly invertible links and divides*, *Topology* **47** (2008), no. 5, 316–350.
- [20] R. Crowell, *Genus of alternating link types*, *Ann. of Math. (2)* **69** (1959), 258–275.
- [21] I. Dai, A. Mallick and M. Stoffregen, *Equivariant knots and knot Floer homology*, arXiv:2201.01875.
- [22] J. F. Davis and S. Naik, *Alexander polynomials of equivariant slice and ribbon knots in S^3* , *Trans. Amer. Math. Soc.* **358** (2006), no. 7, 2949–2964.
- [23] J. Dinkelbach and B. Leeb, *Equivariant Ricci flow with surgery and applications to finite group actions on geometric 3-manifolds*, *Geom. Topol.* **13** (2009), 1129–1173.
- [24] A. L. Edmonds, *Least area Seifert surfaces and periodic knots*, *Topology Appl.* **18** (1984), no. 2-3, 109–113.

- [25] A. L. Edmonds and C. Livingston, *Group actions on fibered three-manifolds*. Comment. Math. Helv. **58** (1983), no. 4, 529–542.
- [26] M. Freedman, J. Hass and P. Scott, *Least area incompressible surfaces in 3-manifolds*, Invent. Math. **71** (1983), no. 3, 609–642.
- [27] A. Hatcher and W. Thurston, *Incompressible surfaces in 2-bridge knot complements*, Invent. Math. **79** (1985), no. 2, 225–246.
- [28] M. Hirasawa, *Visualization of A'Campo's fibered links and unknotting operation*, Proceedings of the First Joint Japan-Mexico Meeting in Topology (Morelia, 1999). Topology Appl. **121** (2002), no. 1-2, 287–304.
- [29] M. Hirasawa, R. Hiura and M. Sakuma, *The equivariant genera of marked strongly invertible knots associated with 2-bridge knots*, preliminary draft.
- [30] M. Hirasawa and M. Teragaito, *Crosscap numbers of 2-bridge knots*, Topology **45** (2006), no. 3, 513–530.
- [31] R. Hiura, *Invariant Seifert surfaces for strongly invertible knots*, Master Thesis (in Japanese), Hiroshima University, 2017.
- [32] N. Ito and Y. Takimura, *Crosscap number of knots and volume bounds*, Internat. J. Math. **31** (2020), no. 13, 2050111, 33 pp.
- [33] N. Ito and Y. Takimura, *A lower bound of crosscap numbers of alternating knots*, J. Knot Theory Ramifications **29** (2020), no. 1, 1950092, 15 pp.
- [34] O. Kakimizu, *Finding disjoint incompressible spanning surfaces for a link*, Hiroshima Math. J. **22** (1992), no. 2, 225–236.
- [35] ———, *Classification of the incompressible spanning surfaces for prime knots of 10 or less crossings*, Hiroshima Math. J. **35** (2005), no. 1, 47–92.
- [36] E. Kalfagianni and C. R. S. Lee, *Crosscap numbers and the Jones polynomial*, Adv. Math. **286** (2016), 308–337.
- [37] T. Kindred, *Crosscap numbers of alternating knots via unknotting splices*, Internat. J. Math. **31** (2020), no. 7, 2050057, 30 pp.
- [38] T. Kobayashi, *Uniqueness of minimal genus Seifert surfaces for links*, Topology Appl. **33** (1989), no. 3, 265–279.
- [39] K. Kodama and M. Sakuma, *Symmetry groups of prime knots up to 10 crossings*, Knots 90 (Osaka, 1990), 323–340, de Gruyter, Berlin, 1992.
- [40] S. Kojima, *Finiteness of symmetries of 3-manifolds*, preprint.
- [41] A. Lobb and L. Watson, *A refinement of Khovanov homology*, Geom. Topol. **25** (2021), no. 4, 1861–1917.
- [42] Y. Marumoto, *Relations between some conjectures in knot theory*, Math. Sem. Notes Kobe Univ. **5** (1977), no. 3, 377–388.
- [43] K. Murasugi, *On the genus of the alternating knot. I, II*, J. Math. Soc. Japan **10** (1958), 94–105, 235–248.
- [44] W. H. Meeks and P. Scott, *Finite group actions on 3-manifolds*, Invent. Math. **86** (1986), no. 2, 287–346.
- [45] W. H. Meeks and S. T. Yau, *The classical Plateau problem and the topology of three-dimensional manifolds, The embedding of the solution given by Douglas-Morrey and an analytic proof of Dehn's lemma*, Topology **21** (1982), no. 4, 409–442.
- [46] J. W. Morgan and H. Bass, *The Smith conjecture*, Pure Appl. Math., **112**, Academic Press, Orlando, FL, 1984.
- [47] H. Murakami and A. Yasuhara, *Crosscap number of a knot*, Pacific J. Math. **171** (1995), no. 1, 261–273.
- [48] K. Murasugi, *On periodic knots*, Comment. Math. Helv. **46** (1971), 162–174.

- [49] S. Naik, *Equivariant concordance of knots in S^3* , KNOTS '96 (Tokyo), 81–89, World Sci. Publ., River Edge, NJ, 1997.
- [50] P. Ozsváth and Z. Szabó, *Holomorphic disks and knot invariants*, Adv. Math. **186** (2004), no. 1, 58–116.
- [51] A. Di. Prisa, *The equivariant concordance group is not abelian*, arXiv:2207.04985 [math.GT]
- [52] P. Przytycki and J. Schultens, *Contractibility of the Kakimizu complex and symmetric Seifert surfaces*, Trans. Amer. Math. Soc. **364** (2012), no. 3, 1489–1508.
- [53] R. Riley, *An elliptical path from parabolic representations to hyperbolic structures*, Topology of low-dimensional manifolds (Proc. Second Sussex Conf., Chelwood Gate, 1977), pp. 99–133, Lecture Notes in Math., **722**, Springer, Berlin, 1979.
- [54] M. Sakuma, *On strongly invertible knots*, Algebraic and topological theories (Kinosaki, 1984), 176–196, Kinokuniya, Tokyo, 1986.
- [55] ———, *Uniqueness of symmetries of knots*, Math. Z. **192** (1986), no. 2, 225–242.
- [56] ———, *Minimal genus Seifert surfaces for special arborescent links*, Osaka J. Math. **31** (1994), 861–905.
- [57] J. L. Tollefson, *Periodic homeomorphisms of 3-manifolds fibered over S^1* , Trans. Amer. Math. Soc. **223** (1976), 223–234. Erratum, ibid. **243** (1978), 309–310.
- [58] H. F. Trotter, *Periodic automorphisms of groups and knots*, Duke Math. J. **28** (1961), 553–557.
- [59] ———, *Non-invertible knots exist*, Topology **2** (1963), 275–280.
- [60] V. Turaev, *Knotoids*, Osaka J. Math. **49** (2012), no. 1, 195–223.
- [61] L. Watson, *Khovanov homology and the symmetry group of a knot*, Adv. Math. **313** (2017), 915–946.
- [62] W. Whitten, *Inverting double knots*, Pacific J. Math. **97** (1981), no. 1, 209–216.

DEPARTMENT OF MATHEMATICS, NAGOYA INSTITUTE OF TECHNOLOGY, SHOWA-KU, NAGOYA CITY, AICHI, 466-8555, JAPAN

Email address: hirasawa.mikami@nitech.ac.jp

INUYAMA-MINAMI HIGH SCHOOL, HASUIKE 2-21, INUYAMA CITY, AICHI, 484-0835, JAPAN

Email address: ryhiura@gmail.com

OSAKA CENTRAL ADVANCED MATHEMATICAL INSTITUTE, OSAKA METROPOLITAN UNIVERSITY, 3-3-138, SUGIMOTO, SUMIYOSHI, OSAKA CITY 558-8585, JAPAN

Email address: sakuma@hiroshima-u.ac.jp