

# Equivalence of field theories: Crane-Yetter and the shadow

Jin-Cheng Guu

Compiled Time: [2022-06-10 00:38:40]

## Abstract

It has been open for years to clarify the relationship between two smooth 4-manifolds invariants, the shadow model (motivated by statistical mechanics [Tur91]) and the simplicial Crane-Yetter model (motivated by topological quantum field theory [CY93]), both of which degenerate to the 3D Witten-Reshetikhin-Turaev model in a special case. Despite the seeming difference in their origins and formal constructions, we show that they are in fact equal.

Along the way, we sketch a dictionary between the shadow model and the Crane-Yetter model, provide a brief survey to the shadow construction a la Turaev, and suggest once again that the semisimple models have reached their limits.

## Contents

<b>0</b>	<b>Introduction</b>	<b>2</b>
0.1	Sections summary . . . . .	2
0.2	Note on the arXiv version . . . . .	3
0.3	A summary to experts . . . . .	3
0.4	Conventions . . . . .	3
<b>1</b>	<b>Algebra (<math>A</math>)</b>	<b>3</b>
1.1	Premodular category . . . . .	3
1.2	$6j$ -symbol, $10j$ -symbol, and $15j$ -symbol . . . . .	6
<b>2</b>	<b>Topology (<math>T</math>)</b>	<b>8</b>
2.1	4-manifold . . . . .	8
2.2	Triangulation . . . . .	9
2.3	Handle decomposition . . . . .	10
2.4	Shadow . . . . .	10
<b>3</b>	<b>Sum (<math>\int_T A</math>)</b>	<b>14</b>
3.1	Crane-Yetter state sum . . . . .	14
3.2	Shadow state sum . . . . .	15
3.3	Main result: equivalence of state sums . . . . .	16

# Acknowledgement

The author would like to thank fruitful discussions with Oleg Viro, Alexander Kirillov, Vladimir Turaev, Samuel Auyeung, and Jiahao Hu. The main result of this paper was conjectured by O. Viro two decades ago; to paraphrase, “We have two combinatorial invariants for 4-manifolds. It would be a miracle if they are different.” V. Turaev, as a leading expert of this field, confirmed that it was still open in mid 2021. Without their sharing, the author would not have worked on this problem.

## 0 Introduction

Topology is the wildest in dimension 4. For example, the smooth Poincaré conjecture remains far from proven only for  $n = 4$ , and the topological  $\mathbb{R}^n$  admits exactly one diffeomorphism type unless  $n = 4$ , in which case uncountably many are available. There are gauge-theoretic tools which, to some extent, are sensitive to exotic smooth phenomena, such as the Donaldson and Seiberg-Witten invariants. Despite their successes, they are unable to tackle a large class of problems including the smooth Poincaré conjecture for  $n = 4$ .

In the 90s, a simpler invariant of smooth 4-manifolds was proposed by Crane and Yetter (CY). The original CY invariant could only detect homotopy type but its simplicity leaves room for modifications. Despite several attempts at modification (e.g. [Bär21]), to date, there has not been much success at detecting exotic smooth phenomena. A recent work by Reutter [Reu20] explains the failure, and suggests the need for a non-semisimple or derived variant of the CY model.

Before moving into that direction, the author aims to settle another issue first. There is another invariant of 4-dimensional smooth manifolds, the shadow model à la V. Turaev [Tur91] [Tur10], from statistical mechanics. Moreover, it was known that the shadow model coincides with the CY model when both degenerate [Tur10, X.3.2 & theorem X.3.3] [BGM07] to the 3D Witten-Reshetikhin-Turaev model (also known as the quantized Chern-Simons theory). It is thus necessary to clarify their relationship in the general semisimple case. Despite the difference of their origins and formal definitions, this paper shows them equal, suggesting once again that semisimple models have reached their limit in terms of detecting exotic smooth phenomena.

Along proving the equivalence of the two models, we make heavy use of the construction of the shadow model given in [Tur10]. We include the essential details of the construction in this paper which serve as a digestible survey of the shadow model.

### 0.1 Sections summary

- Section 1: We provide the basics of tensor categories, their graphical calculi and tensor networks, and special numerical entities (nj-symbols). Nothing in this section is new.
- Section 2: We provide three kinds of data that present smooth 4-manifolds: triangulations, handle decompositions, and shadows. We also fully recall the definition of a shadow, which closely resembles foams in the modern literature on Khovanov homology. Nothing in this section is new. Readers can treat this paper as a thin interface to the book [Tur10].
- Section 3: We provide the definitions of the two state sums: the CY model and the shadow model. The novel observation is that the shadow model can be extended from modular categories to premodular categories. We conclude the section by stating and proving the equivalence.

## 0.2 Note on the arXiv version

The tex source file of this paper includes hidden details, which can be displayed by recompiling with toggling details in the source.

## 0.3 A summary to experts

The idea of the proof for the equivalence is simple. Let  $X$  be a 4-manifold. While the CY state sum can be computed from any triangulation  $T$  of  $X$ , the shadow state sum can be computed from any stable shadow of  $X$ . We construct a natural stable shadow  $S$  from  $T$  and compute the shadow sum in terms of  $S$ . If the shadow sum is actually a  $(3 + 1)$ D-TQFT, we can reduce the task to proving that the local shadow evaluates to the local term involved in the CY state sum (namely, the  $10j$ -symbols). However, the author could not prove the semi-locality, but rather found a workaround for the case of closed 4-manifolds. The author expects the shadow sum can be modified to be a fully extended TQFT, which is in turn fully equivalent to the Crane-Yetter model.

## 0.4 Conventions

Some conventions we use globally in the paper:

- We fix a algebraic closed field  $\mathbb{k}$  of characteristic 0.
- By a vector space  $V$  we mean a finite dimensional vector space over the field  $\mathbb{k}$ , unless further specified. The linear dual  $\text{Hom}_{\mathbb{k}}(V, \mathbb{k})$  is denoted by  $V^*$ .
- By a manifold we mean a piecewise-linear, oriented, connected and closed manifold in real dimension 4 unless further specified.
- In this paper, by a monoidal category we mean a strict monoidal category (we do not lose any generality by Mac Lane’s strictness theorem). [For the statement and a full modern proof, see \[Eti+15, theorem 2.8.5\].](#)

# 1 Algebra (A)

## 1.1 Premodular category

The full definition of a premodular category from scratch is tedious. Unfamiliar readers can think of a premodular category roughly as a higher version of the group algebra of a finite group. A formal definition can be found after some motivations (1.1).

Algebraic objects help abstract details in various mathematical problems. However, they sometimes abstract too much to recover information of interest. In recent years, mathematicians “categorify” algebraic objects in order to retain more information. For example, a ring is categorified to a tensor category, and a tensor category with special properties and additional structures could be powerful. For example, a ribbon fusion category provide quantum invariants of knots that generalize the Jones polynomials. A premodular category is a braided fusion category satisfying with a spherical structure. Examples include the (modified) category of representations of finite groups, finite 2-groups, and quantum groups.

**Definition 1.1 (premodular category)** A premodular category is a spherical braided fusion category.  $\diamond$

In particular, a premodular category  $C$  is semisimple,  $\mathbb{k}$ -linear, and fusion. Define its set of simple objects to be the set  $I$  of simple  $C$ -objects up to isomorphism. Denote  $0 \in I$  so that the monoidal identity  $\mathbb{1} \in 0$ . As taking monoidal dual preserves simplicity, for each  $i \in I$  there is a unique element  $i^*$  in  $I$  such that  $V_i^* \in i^*$  whenever  $V_i \in i$ . So  $I$  is a finite set with an involution  $I \xrightarrow{*} I$ . Using the spherical structure, we can define for each  $i \in I$  the number  $\dim_C(i) = \dim(i) \in \mathbb{k}$  as the trace of  $\text{id}_{V_i}$  and the number  $\nu_i \in \mathbb{k}^*$  as the twisting coefficient  $\text{tr}(\theta_{V_i})/\text{tr}(\text{id}_{V_i})$ , where  $\theta_{V_i}$  denotes the endomorphism of  $V_i$  depicted in the following graph.



We further define the Gauss sum of  $C$  to be

$$\Delta_C = \sum_{i \in I} \nu_i^{-1} \dim(i)^2.$$

In order to do computations with a premodular category we need to choose and fix some extra data (called a coordinate). All intrinsic results are independent of the choice (except the square root  $D$  of the global dimension).

**Definition 1.2 (coordinated premodular category)** Let  $C$  be a premodular category and  $I$  its set of simple objects. Choose and fix the following:

- A number  $D \in \mathbb{k}$  such that  $D^2 = \sum_{i \in I} \dim_C(i)^2$  (the global dimension of  $C$ ).
- A set of  $C$ -objects  $\{V_i\}_{i \in I}$  such that  $V_i \in i$  and that  $V_0 = \mathbb{1}$ .
- A set of isomorphisms [Tur10, p.313]  $\{\omega_i : V_i \rightarrow (V_{i^*})^*\}_{i \in I}$ .
- A set of numbers  $\{\dim'_C(i) = \dim'(i) \in \mathbb{k}\}_{i \in I}$  such that  $\dim'_C(0) = 1$ ,  $\dim'_C(i)^2 = \dim_C(i)$ , and  $\dim'_C(i^*) = \dim'_C(i)$ .
- A set of numbers  $\{\nu'_i \in \mathbb{k}\}_{i \in I}$  such that  $\nu'_0 = 1$ ,  $(\nu'_i)^2 = \nu_i$ , and  $\nu'_{i^*} = \nu'_i$  [Tur10, p.313].

Such a 5-tuple  $\vec{d} = (D, \{V_i\}, \{\omega_i\}, \{\dim'(i)\}, \{\nu'_i\})$  is called a coordinate of the premodular category  $C$ . Such a pair  $(C, \vec{d})$  is called a coordinated premodular category.  $\diamond$

We will often confuse a premodular category with a coordinated premodular category.

**Definition 1.3 (multiplicity module)** Let  $C$  be a coordinated premodular category and  $I$  its set of simple objects. Respectively, define  $H^{ijk}$ ,  $H_k^{ij}$ , and  $H_{ij}^k$  to be the  $\mathbb{k}$ -modules  $\text{Hom}_C(\mathbb{1}, V_i \otimes V_j \otimes V_k)$ ,  $\text{Hom}_C(V_k, V_i \otimes V_j)$ , and  $\text{Hom}_C(V_i \otimes V_j, V_k)$ .  $\diamond$

We identify  $H_k^{ij}$  with  $H^{ijk^*}$  and  $H_{ij}^k$  with  $H^{kj^*i^*}$  by the linear maps induced by the following graph and call them the canonical identifications:

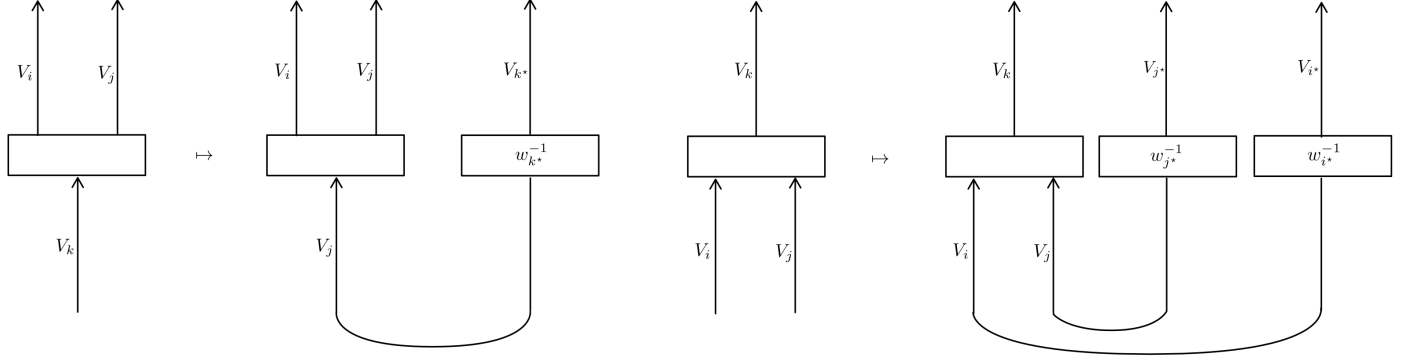

Recall that the natural pairing

$$H_k^{ij} \otimes_{\mathbb{k}} H_{ij}^k \rightarrow \text{Hom}_C(V_k, V_k) \xrightarrow{\text{tr}} \mathbb{k}$$

is nondegenerate by the semisimplicity of  $C$ . The braided structure of  $C$  guarantees that the  $\mathbb{k}$ -modules  $H^{ijk}$ ,  $H^{ikj}$ ,  $H^{jik}$ ,  $H^{jki}$ ,  $H^{kij}$ ,  $H^{kji}$  are all isomorphic. In category theory, we must carefully distinguish equalities from isomorphisms, hence we introduce a way to keep track of the isomorphisms among the  $H^{ijk}$ 's.

**Definition 1.4 (canonical isomorphisms)** Let  $C$  be a premodular category,  $c$  its braided structure,  $I$  its set of simple objects, and  $i, j, k \in I$ . Define the canonical isomorphisms  $H^{ijk} \xrightarrow{\sigma_1(ijk)} H^{jik}$  and  $H^{ijk} \xrightarrow{\sigma_2(ijk)} H^{ikj}$  by

$$\begin{aligned} \sigma_1(ijk) : \phi &\mapsto \nu'_i \nu'_j (\nu'_k)^{-1} (c_{V_i, V_j} \otimes \text{id}_{V_k}) \phi, \\ \sigma_2(ijk) : \phi &\mapsto \nu'_j \nu'_k (\nu'_i)^{-1} (\text{id}_{V_i} \otimes c_{V_j, V_k}) \phi. \end{aligned}$$

◇

It is a simple exercise in the theory of tensor categories to check that

$$\begin{aligned} \sigma_1(jik) \sigma_1(ijk) &= \text{id}, \\ \sigma_2(ikj) \sigma_2(ijk) &= \text{id}, \\ \sigma_1(jki) \sigma_2(jik) \sigma_1(ijk) &= \sigma_2(kij) \sigma_1(ikj) \sigma_2(ijk) \end{aligned} \tag{1.5}$$

so  $\sigma_1$  and  $\sigma_2$  specify the isomorphisms among the six  $\mathbb{k}$ -modules.

**Definition 1.6 (symmetrized multiplicity module)** Let  $C$  be a premodular category,  $I$  its set of simple objects, and  $i, j, k \in I$ . Define the symmetrized multiplicity module  $H(i, j, k)$  to be the  $\mathbb{k}$ -module consisting of functions  $\phi$  that assign an element  $\phi^{i_1 i_2 i_3} \in H^{i_1 i_2 i_3}$  to each ordering  $(i_1, i_2, i_3)$  of the set  $\{i, j, k\}$ . ◇

The point is that all the symmetrized modules  $H(i, j, k)$ ,  $H(i, k, j)$ ,  $H(j, i, k)$ ,  $H(j, k, i)$ ,  $H(k, i, j)$ ,  $H(k, j, i)$  are *equal as sets*. By definition, there is a canonical identification between  $H(i, j, k)$  and  $H^{ijk}$ .

**Definition 1.7 (contraction)** Let  $C$  be a coordinated premodular category,  $I$  its set of simple objects, and  $i, j, k \in I$ . Define the contraction map  $H^{ijk} \otimes H^{k^* j^* i^*} \rightarrow \mathbb{k}$  by the following diagram [Tur10, figure VI.3.5]

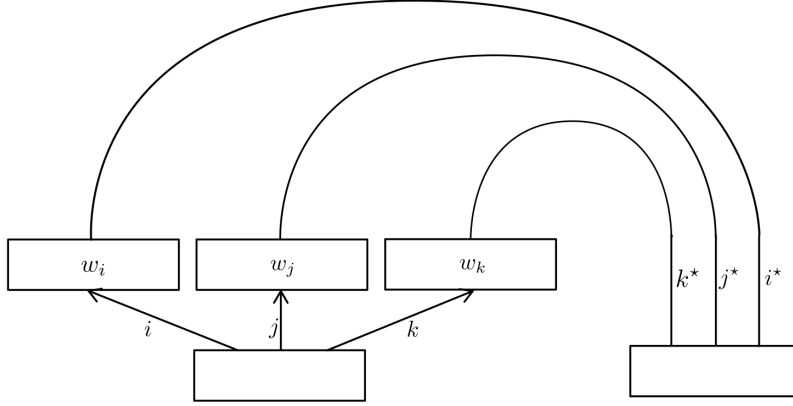

Denote the canonically induced contraction map on the symmetrized modules to be ([Tur10, p.334])

$$*_{ijk} : H(i, j, k) \otimes_{\mathbb{k}} H(i^*, j^*, k^*) \rightarrow \mathbb{k}.$$

This defines a nondegenerate pairing and thus induces a canonical element  $\text{Id}(i, j, k)$  in the domain of  $*_{ijk}$  ([Tur10, p.333]).  $\diamond$

We will abuse notation by denoting natural contractions from the non-ordered tensor products  $V \otimes_{\mathbb{k}} H(i, j, k) \otimes_{\mathbb{k}} H(i^*, j^*, k^*)$  to  $\mathbb{k}$  by  $*_{ijk}$  for any  $\mathbb{k}$ -module  $V$ .

## 1.2 6j-symbol, 10j-symbol, and 15j-symbol

**Definition 1.8 (6j-symbol)** For each  $i, j, k, l, m, n \in I$ , we define the 6j-symbol

$$\begin{bmatrix} i & j & k \\ l & m & n \end{bmatrix} : H_k^{ij} \otimes H_m^{kl} \otimes H_l^n \otimes H_{in}^m \rightarrow \mathbb{k}$$

to be the linear map induced by the partial tensor network on the 2-sphere  $S^2$ :

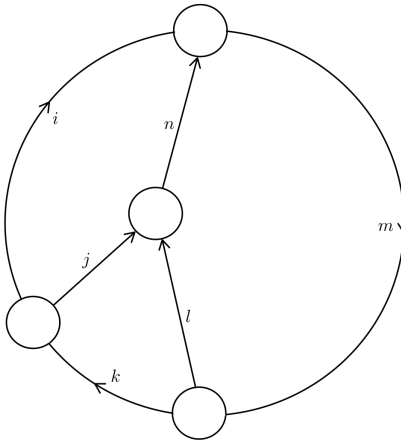

Using the canonical identifications, we define the induced map

$$\left| \begin{bmatrix} i & j & k \\ l & m & n \end{bmatrix} \right| : H(i, j, k^*) \otimes H(k, l, m^*) \otimes H(n, l^*, j^*) \otimes H(m, n^*, i^*) \rightarrow \mathbb{k}$$

to be the normalized 6j-symbol.  $\diamond$

**Proposition 1.9 (basic equalities of 6j symbols)** Let  $\mathcal{C}$  be a coordinated premodular category,  $I$  its set of simple objects,  $i, j, k, k', l, m \in I$ ,  $j_0, j_1, \dots, j_8 \in I$ , and  $\delta$  be the Kronecker delta. Then we have the degenerated 6j symbol

$$\left| \begin{array}{ccc} i & j & k \\ l & m & 0 \end{array} \right| = \delta_{m,i} \delta_{l,j^*} \dim'(i)^{-1} \dim'(j)^{-1} \text{Id}(i, j, k^*) \in H(i, j, k^*) \otimes_{\mathbb{k}} H(i^*, j^*, k). \quad (1.10)$$

We also have the so called Biedenharn-Elliott identity as an equality in the non-ordered tensor product of the  $\mathbb{k}$ -modules

$$H(j_3^*, j_5^*, j_6) \otimes H(j_1^*, j_2^*, j_5) \otimes H(j_4^*, j_6^*, j_0) \otimes H(j_0^*, j_1, j_7) \otimes H(j_7^*, j_2, j_8) \otimes H(j_8^*, j_3, j_4)$$

(in the context of state sum over a triangulation, this corresponds to the Pachner (2,3)-move):

$$*_{j_0^* j_5 j_8} \left( \left| \begin{array}{ccc} j_5 & j_3 & j_6 \\ j_4 & j_0 & j_8 \end{array} \right| \otimes \left| \begin{array}{ccc} j_1 & j_2 & j_5 \\ j_8 & j_0 & j_7 \end{array} \right| \right) = \sum_{j \in I} \dim(j) *_{j^* j_2 j_3} *_{j j_4 j_7^*} *_{j j_1 j_6^*} \left( \left| \begin{array}{ccc} j_1 & j_2 & j_5 \\ j_3 & j_6 & j \end{array} \right| \otimes \left| \begin{array}{ccc} j_1 & j & j_6 \\ j_4 & j_0 & j_7 \end{array} \right| \otimes \left| \begin{array}{ccc} j_2 & j_3 & j \\ j_4 & j_7 & j_8 \end{array} \right| \right). \quad (1.11)$$

We also have the orthonormality relation

$$\delta_{k,k'} \text{Id}(i, j, k^*) \otimes \text{Id}(k, l, m^*) = \dim(k) \sum_{n \in I} \dim(n) *_{i m^* n} *_{j l n^*} \left( \left| \begin{array}{ccc} i^* & j^* & k^* \\ l^* & m^* & n^* \end{array} \right| \otimes \left| \begin{array}{ccc} i & j & k' \\ l & m & n \end{array} \right| \right). \quad (1.12)$$

Finally, we have the Racah identity

$$v'_{j_3} v'_{j_6} (v'_{j_1} v'_{j_2} v'_{j_4} v'_{j_5})^{-1} \left| \begin{array}{ccc} j_1 & j_2 & j_3 \\ j_4 & j_5 & j_6 \end{array} \right| = \sum_{j \in I} (v'_j)^{-1} \dim(j) *_{j^* j_1 j_4} *_{j j_2 j_5^*} \left( \left| \begin{array}{ccc} j_1 & j_4 & j \\ j_2 & j_5 & j_6 \end{array} \right| \otimes \left| \begin{array}{ccc} j_2 & j_1 & j_3 \\ j_4 & j_5 & j \end{array} \right| \right) \quad (1.13)$$

◇

*Proof.* Proofs and references for the modular case can be found in [Tur10, section VI.5.4]. The proof does not use modularity at all, so it carries through for the premodular case verbatim. ■

**Definition 1.14 (10j-symbol)** Let  $\mathcal{C}$  be a coordinated premodular category,  $I$  its set of simple objects, and  $j_{ab} \in I$  with  $j_{ab} = j_{ba}^*$  for  $0 \leq a, b \leq 4$ . Denote  $[x, y, z, w]$  to be the vector space  $\text{Hom}_{\mathcal{C}}(V_0, V_{j_x} \otimes V_{j_y} \otimes V_{j_z} \otimes V_{j_w})$ . Then define the 10j symbol (and its mirror, resp.)

$$\left| \begin{array}{cccc} j_{01} & j_{02} & j_{03} & j_{04} \\ \cdot & j_{12} & j_{13} & j_{14} \\ \cdot & \cdot & j_{23} & j_{24} \\ \cdot & \cdot & \cdot & j_{34} \end{array} \right|_{10j} \quad \left( \left| \begin{array}{cccc} j_{01} & j_{02} & j_{03} & j_{04} \\ \cdot & j_{12} & j_{13} & j_{14} \\ \cdot & \cdot & j_{23} & j_{24} \\ \cdot & \cdot & \cdot & j_{34} \end{array} \right|_{\overline{10j}} \right), \text{ resp.}$$

to be the  $\mathbb{k}$ -linear map from the non-ordered tensor product of  $\mathbb{k}$ -modules

$$[01, 02, 03, 04] \otimes [12, 13, 14, 10] \otimes [23, 24, 20, 21] \otimes [34, 30, 31, 32] \otimes [40, 41, 42, 43]$$

to  $\mathbb{k}$  induced by the following (equivalent)  $\mathcal{C}$ -colored graphs (resp., the same gadget but with the underlying graph mirrored and all arrows reversed).

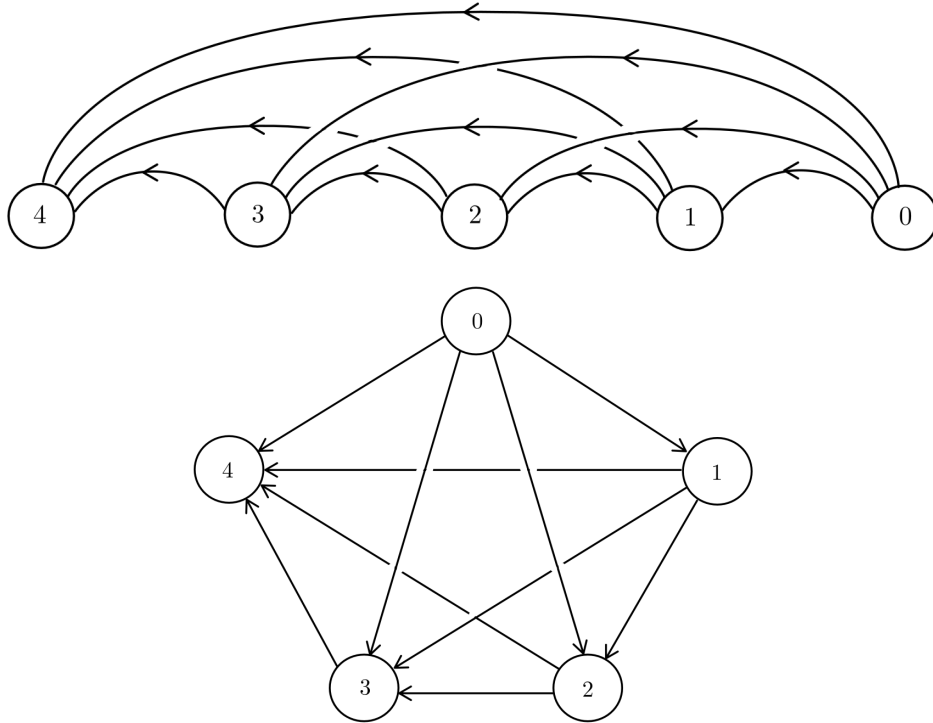

◇

**Remark 1.15 (15j-symbol)** A 15j-symbol is an equivalent variant of a 10j-symbol. It was used in the older literature to make sure the morphism spaces are 1-dimensional. The 10j-symbols are more intrinsic, so we use them instead of the 15j-symbols. ◇

## 2 Topology (T)

### 2.1 4-manifold

Manifolds in real dimension 4 are interesting because of their wildness, witnessed in the following examples:

1. Real dimension 4 is the smallest dimension where the topological structures and the smooth structures disagree.
2. For  $n \in \mathbb{N} \setminus \{4\}$ , the euclidean space  $\mathbb{R}^n$  as a topological space admits exactly one diffeomorphism type, while  $\mathbb{R}^4$  admits infinitely many [Sco][Mil, p.2].
3. The (smooth) Poincare conjecture for the  $n$ -dimensional sphere  $S^n$  has been resolved except for  $n = 4$ , which remains widely open to date despite several attempts.
4. The Universe where we live seems to be best-modeled by a 4-manifold.

Despite its wildness, in dimension 4 the notion of smooth manifolds coincides with the notion of piecewise-linear (PL) manifolds [Tur10, sec.IX.1.1]. The data of the later can be made combinatorial and concrete, and is what we will really be working on. From now on, unless further specified, by a manifold we mean an oriented, connected, closed and piecewise-linear manifold in real dimension 4.



## 2.2 Triangulation

This section is standard [RS, chap.1] [Man16, sec.2] but included for completeness.

**Definition 2.1 (simplicial complex)** An abstract simplicial complex is a pair  $K = (V, S)$  of finite sets  $V$  and  $S \subset 2^V$ , such that  $\tau \in S$  whenever  $\sigma \in S$  and  $\tau \subset \sigma$ . For a subset  $S' \subset S$ , its closure is

$$\overline{S'} = \{\tau \in S \mid \tau \subset \sigma \in S'\}.$$

Given a simplex  $\tau$ , its star and its link are

$$\text{Star}(\tau) := \{\sigma \in S \mid \tau \subset \sigma\}, \quad \text{Link}(\tau) := \{\sigma \in \overline{\text{Star}(\tau)} \mid \tau \cap \sigma = \emptyset\}.$$

We say that  $K$  is an abstract combinatorial manifold (possibly with boundary) of dimension  $n$  if the link of each of its simplices (or equivalently each of its vertices) is PL homeomorphic to either a sphere or a disk, and if top cell has dimension  $n$ . The geometric realization  $|K|$  of  $K$  is defined as usual by gluing  $k$ -dimensional simplices inductively on  $k \geq 0$ .

An orientation of a combinatorial manifold is an ordering of the vertices up to even permutations. We define the standard  $n$ -simplex to be  $\Delta_n = \{0, 1, 2, \dots, n\}$ , with  $[0 < 1 < \dots < n]$  being its standard orientation. Its  $k$ th face is defined to be

$$\Delta_n(\widehat{k}) = (-1)^k \Delta(012 \dots \widehat{k} \dots n).$$

For example, the standard oriented 4-simplex  $\Delta_4(01234)$  has a 3-dimensional face being  $\Delta_4(\widehat{1}) = -\Delta_4(0234) = \Delta_4(2034) = \dots$ . This face, in turn, has another 2-dimensional face  $\Delta_4(\widehat{12}) = \Delta_4(034)$ . In general, for  $i < j$ , denote  $\Delta(\widehat{ij}) = (-1)^{i+j-1} \Delta(0 \dots \widehat{i} \dots \widehat{j} \dots n)$ .  $\diamond$

**Definition 2.2 (Pachner move)** Let an abstract combinatorial manifold  $K = (V, S)$  of dimension  $n$ . A Pachner  $(1, n+1)$ -move along a top-simplex  $\tau \in S$  is defined to be  $K \rightsquigarrow K'$ , where

$$K' = \left( V \amalg \{\star\}, \quad (S \setminus \{\tau\}) \amalg \left( \bigsqcup_f (f \cup \{\star\}) \right) \right),$$

where  $f$  runs through each face of  $\tau$ . A Pachner  $(2, n)$ -move along two top-simplices  $\tau, \tau' \in S$  that share a face  $f \in S$  is defined to be  $K \rightsquigarrow K'$ , where

$$K' = \left( V, \quad (S \setminus \{\tau, \tau'\}) \amalg \left( \bigsqcup_g (g \cup \{\star, \star'\}) \right) \right),$$

where  $g$  runs through each face of  $f$ , and  $\star$  ( $\star'$ , resp.) denotes the opposite vertex of  $f$  in  $\tau$  ( $\tau'$ , resp.). We say the inverses are Pachner  $(n, 2)$ -moves and  $(n+1, 1)$ -moves respectively. Denote  $K \sim K'$  if  $K'$  can be obtained by  $K$  via a finite sequence of Pachner moves.

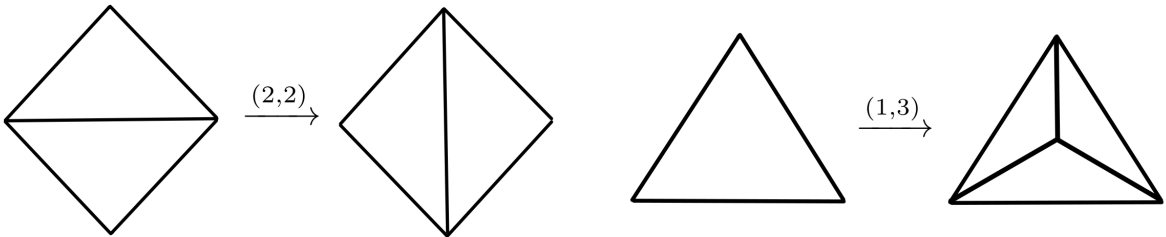

◇

Notice that a Pachner move  $K \rightsquigarrow K'$  induces naturally a PL homeomorphism  $K \xrightarrow{\sim} K'$ .

**Definition 2.3 (triangulation of PL-manifolds)** Let  $X$  be a piecewise-linear manifold. A triangulation of  $X$  is a PL-homeomorphism  $X \xrightarrow{\phi} |K|$  for some combinatorial manifold  $K$ . ◇

**Fact 2.4** Any piecewise-linear manifold  $X$  has a triangulation  $\phi : X \simeq |K|$ . Any other triangulation  $\phi' : X \simeq |K'|$  satisfies  $K \sim K'$ . Finally, an orientation of  $X$  restricts to a coherent orientation for each top cell of  $K$ . ◇

## 2.3 Handle decomposition

By Morse's theory of extremal points, any smooth manifold admits a handle decomposition. By Cerf theory, two handle decompositions present the same manifold (up to diffeomorphism) if and only if both decomposition data are related by a finite sequence of handle creations, handle annihilations, and handle slides [GS]. A triangulation of a manifold admits a natural handle decomposition by taking dual. The correct state sum based on this datum is the universal state sum [Wal21]; it transforms a handle decomposition into a number. A useful fact to notice is that closed 4-manifolds are reconstructible from their handles of indices 0, 1, and 2 (2.23).

## 2.4 Shadow

A shadow is another type of structure that encodes closed 4-manifolds. Roughly speaking, a shadow is a 2-polyhedron with extra decorations (called gleams) that remember the twisting data. A 2-polyhedron is a topological and combinatorial object that encodes 3-dimensional manifolds [Mat]. It is called a pre-foam in the literature of Khovanov homology (from foams) [KR18].

**Definition 2.5 (tripod)** Define the standard tripod to be the topological subspace of  $\mathbb{R}^3$  consisting of the points  $(x, y, z)$  such that at least two of the entries are zero, and the last entry belongs to  $[0, 1]$ . Define a tripod to be any topological space homeomorphic to the standard tripod. ◇

**Definition 2.6 (cone)** For each topological space  $X$ , define its standard open cone  $\text{cone}(X)$  to be the quotient space  $(X \times \mathbb{R}_{\geq 0}) / ((x, 0) \sim (x', 0))$ . Define an open cone of  $X$  to be any topological space homeomorphic to  $\text{cone}(X)$ . ◇

**Definition 2.7 (local shape)** Let  $X$  be a topological space and  $x \in X$ . Denote by  $T$  the standard tripod and  $S$  the 1-skeleton of the boundary of the standard tetrahedron (a trivalent graph with 4 vertices and 6 edges). Respectively, we say that  $x$  is a smooth point, a line point, a tetrahedral point, a boundary smooth point, or a boundary line point of  $X$  if it has a relative neighborhood homeomorphic to  $(\mathbb{R}^2, 0)$ ,  $(T \times \mathbb{R}, (0, 0))$ ,  $(\text{cone}(S), (*, 0))$ ,  $(\mathbb{R} \times \mathbb{R}_{\geq 0}, (0, 0))$ , or  $(T \times \mathbb{R}_{\geq 0}, (0, 0))$ . ◇

**Definition 2.8 (simple 2-polyhedron)** A simple 2-polyhedron with boundary is defined to be a piecewise-linear compact CW-complex  $P$  of real dimension two, such that each of its point  $p$  is either a smooth point, a line point, a tetrahedral point, a boundary smooth point, or a boundary line point. If only the first three types are involved, we call  $P$  a simple 2-polyhedron without boundary. ◇

**Definition 2.9 (components of a simple 2-polyhedron)** Let  $P$  be a simple 2-polyhedron with boundary. Define the set of smooth points (or called interior points) of  $P$  to be  $\text{Int}(P)$ . Define the set of line points, tetrahedral points, and boundary line points to be  $\text{sing}(P)$ . Define the set of boundary line points and boundary smooth points to be  $\partial P$ . Call a connected component of  $\text{Int}(P)$  to be a region of  $P$ ; define the set of regions to be  $\text{Region}(P)$ .  $P$  is said to be orientable if each region of  $P$  is orientable. An orientation of  $P$  is an assignment of orientations to each of the region.  $\diamond$

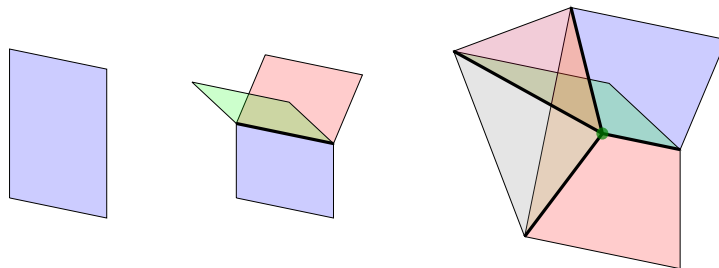

Figure 1: The graphic is taken from [KR18].

**Definition 2.10 (shadowed 2-polyhedron)** Let  $P$  be a simple 2-polyhedron, and  $A$  an abelian group with a distinguished element  $\omega \in A$ . We define a shadow to be a pair of an orientable 2-polyhedron  $P$  and a map (called gleam)  $gl : \text{Region}(P) \rightarrow A$ . Unless specified further, we assume that  $A = \mathbb{Z} \left[ \frac{1}{2} \right]$  and  $\omega = \frac{1}{2}$ . We denote  $-P$  to be the same simple 2-polyhedron but with all gleams flipped by  $(a \mapsto -a)$ .  $\diamond$

For each connected oriented closed surface  $\Sigma$  and each  $a \in A$ , there is a shadowed 2-polyhedron  $\Sigma_a$  which consists of  $\Sigma$  with the gleam  $a$  assigned to the only region. For example,  $S_0^2$  denotes the 0-gleamed 2-sphere.

**Definition 2.11 (nullity of a shadowed 2-polyhedron)** [Tur10, section VIII.5.1] Let  $P$  be an oriented shadowed 2-polyhedron. For each region  $Y$  of  $P$ , the contraction map  $(P/\partial P) \rightarrow P/(P \setminus Y)$  and the orientation of  $Y$  induces a map

$$H_2(P; \partial P) \rightarrow \mathbb{Z}; h \mapsto \langle h|Y \rangle.$$

Define the symmetric bilinear form  $\tilde{Q}_P$  on  $H_2(P; \partial P)$  by summing over all regions of  $Y$

$$\tilde{Q}_P(h_1, h_2) = \sum_Y \langle h_1|Y \rangle \langle h_2|Y \rangle gl(Y) \in A$$

and restrict it to  $Q_P$  along the natural map  $H_2(P) \rightarrow H_2(P; \partial P)$  (which is injective by a usual argument using long exact sequence).  $H_2(P)$  is a free abelian group, and so is  $\text{Ann}(Q_P)$ . Finally, define the nullity of  $P$  to be  $\text{null}(P) = \text{rank}(\text{Ann}(Q_P))$ .  $\diamond$

We remark that if the shadowed polyhedron comes from a 4-manifold  $X$ , then the bilinear form defined in the previous definition coincide with the intersection form of  $X$  [Tur10, section IX.5].

**Definition 2.12 (shadow moves)** [Tur10, section VIII.1.3, p.369]

The basic shadow moves  $P_1, P_2, P_3$  are given in the following graphics (taken from [Tur10]). A shadow move is a finite composition of the  $P_i^{\pm 1}$ 's.

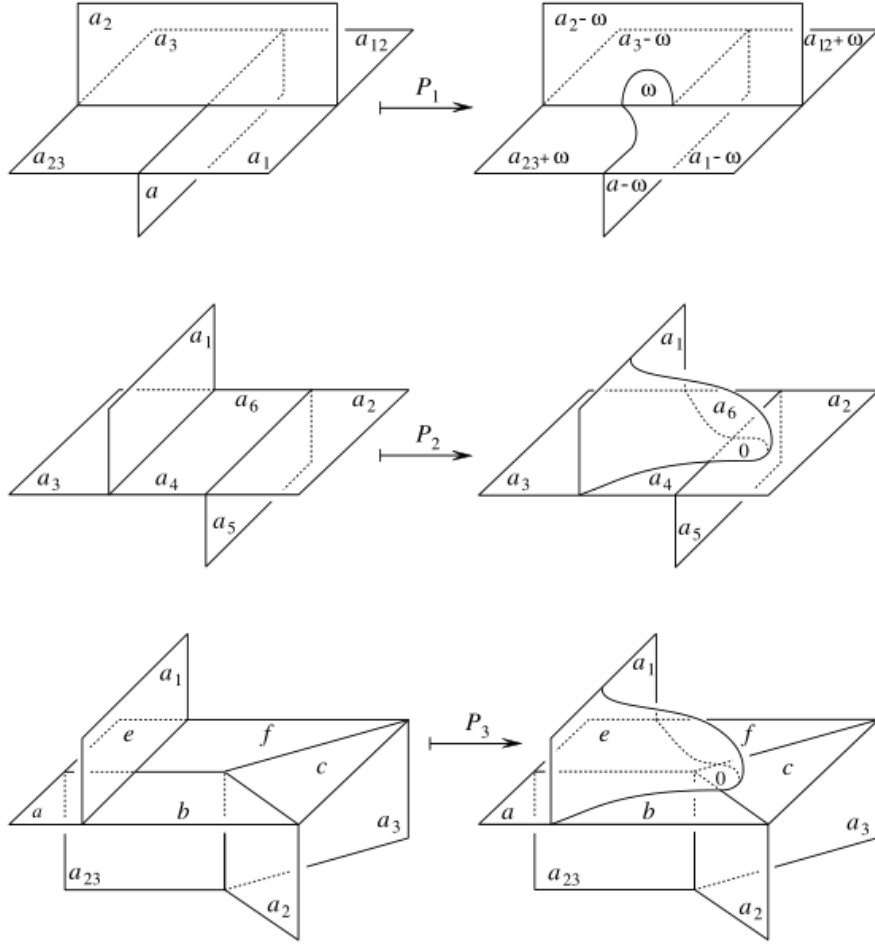

◇

**Definition 2.13 (shadow)** A shadow is an equivalence class of shadowed 2-polyhedron  $P$  up to a shadow move. We denote the shadow by  $[P]$ , and say that  $P$  represents the shadow  $[P]$  [Tur10, p.370]. ◇

For two connected shadow  $[P]$  and  $[P']$ , we construct the shadow  $[P] + [P']$  as follows. Arbitrarily identify two arbitrarily chosen closed disks  $D \subset \text{Int}(P)$  and  $D' \subset \text{Int}(P')$  in  $P \amalg P'$ , and equip the interior of  $D$  (a new region) with gleam 0. So defines a simple 2-polyhedron and we say that it represents  $[P] + [P']$ . It is well-defined by [Tur10, lemma VIII.2.1.1]. For an integer  $m \in \mathbb{Z}_{\geq 0}$ , we define  $m[P]$  as the sum of  $m$ -many  $[P]$ .

**Definition 2.14 (stable shadow)** Two connected shadowed polyhedra  $P, P'$  are called stably shadow equivalent if there exists  $n, n' \in \mathbb{Z}_{\geq 0}$  such that  $[P] + m[S_0^2] = [P'] + m'[S_0^2]$ . Extend the definition to non-connected ones in an obvious fashion. A stable shadow is defined to be a shadowed polyhedron up to stable shadow equivalence. Denote the stable shadow of  $[P]$  to be  $\text{stab}([P])$ . ◇

We are ready to present a closed 4-manifold in terms of shadows.

**Definition 2.15 (locally flat 2-polyhedron in a 4-manifold)** Let  $X$  be a closed 4-manifold. A 2-polyhedron  $P$  in  $X$  is flat at a point  $p \in P$  if there exists a neighborhood  $U$  of  $p$  in  $X$  such that  $U \cap P$  lies in a 3-dimensional submanifold of  $X$ . We say that  $P$  is locally flat if it is flat at all  $p \in P$  ([Tur10, p.394]). ◇

**Definition 2.16 (skeleton of a 4-manifold)** Let  $X$  be a closed 4-manifold. A skeleton [Tur10, p.395] of  $X$  is a locally flat orientable simple 2-polyhedron without boundary  $P$  such that a closed regular neighborhood of it with some 3- and 4-handles form  $X$ .  $\diamond$

For example,  $\mathbb{C}P^1 = \{[x : y : 0]\}$  is a skeleton of  $\mathbb{C}P^2 = \{[x : y : z]\}$ . By [Tur10, theorem IX.1.5], every 4-manifold has a skeleton (by compressing the  $(0, 1, 2)$ -handles in an arbitrary handle decomposition).

**Definition 2.17 (stable shadow of a 4-manifold)** Let  $X$  be a closed 4-manifold. Take a skeleton  $P$  of  $X$  and construct a shadowed simple 2-polyhedron by assigning gleams to the regions  $\Sigma$  in the following way.

1. If  $\Sigma$  is homeomorphic to a closed surface, define the gleam to be the self-intersection (which is independent of the orientation of  $\Sigma$ )

$$([\Sigma] \cdot [\Sigma]) \in H_0(X; \mathbb{Z}) = \mathbb{Z} \subset \mathbb{Z}[1/2].$$

2. Otherwise,  $\Sigma$  is non-compact. Deformation retract it to a compact subsurface  $\Sigma_0$ . Denote  $N$  to be the normal bundle of  $\Sigma_0$  in  $X$ . Consider the line bundle  $l$  over  $\partial\Sigma_0$  by [Tur10, section VIII.6.2, p.397], which may be regarded as a sub-bundle of  $N|_{\partial\Sigma_0}$ . The circle bundle  $\mathbb{P}(N)$  is trivial over  $\Sigma_0$  since the later is a homotopy 1-type. With a choice of an orientation of  $\Sigma_0$  and  $X$ ,  $l$  induces a section of  $\mathbb{P}(N)|_{\partial}$ . The obstruction class of this section to the whole  $\mathbb{P}(N)$  is an element of  $H^2(\Sigma_0, \partial\Sigma_0; \pi_1(S^1)) = \mathbb{Z}$ . Finally, define the gleam to be the half of the resulting integer (which is independent to the choice of  $\Sigma_0$ ).

It is the main theorem of [Tur10, section IX.1.7] that all shadowed polyhedra chosen in such fashion above are all stably shadow equivalent. Therefore, it defines the stable shadow  $sh(X)$  of the closed 4-manifold  $X$ .  $\diamond$

**Example 2.18**  $sh(\pm\mathbb{C}P^2) = \text{stab}([S_{\pm 1}^2])$  and  $sh(S^4) = \text{stab}([S_0^2])$ .  $\diamond$

A handle decomposition of a closed 4-manifold  $X$  gives rise to a shadow of  $X$  [Tur10, section IX.4]. The explicit construction will be recalled below in 2.21, which will be used to prove our main theorem.

**Definition 2.19 (skeleton of a 3-manifold)** Let  $Y$  be a closed 3-manifold. A skeleton of  $Y$  is an orientable simple 2-polyhedron without boundary  $P \subset Y$  such that  $Y \setminus P$  is a disjoint union of open 3-balls [Tur10, p. 400].  $\diamond$

**Definition 2.20 (shadow cone of a framed link in a 3-manifold)** Every compact 3-manifold  $Y$  has a skeleton [Tur10, theorem IX 2.1.1]. For example, the equator  $S^2$  of  $S^3$  is a skeleton. Let  $P$  be a skeleton of  $Y$  and  $l$  be a framed link in  $Y$ . Projecting  $l$  generically onto  $P$  induces a shadow projection. Assign gleams around each crossing point as in [Tur10, figure IX.3.4]. Then construct the shadow by naturally attaching a disk along each projected component on  $P$  (as a new region) endowed with zero gleam. Denote the resulting shadow to be  $CO(Y, l)$  (well-defined up to stable shadow moves [Tur10, section IX.3.3]).  $\diamond$

**Definition 2.21 (shadow of a 4-manifold from a handle decomposition)** Let  $X$  be an oriented 4-manifold and  $H = \bigcup_{i=0}^4 H_i$  be a handle decomposition, where  $H_i$  denotes the union of the handles of index  $i$ . Define  $Y$  to be the closed 3-manifold  $\partial(H_0 \cup H_1)$ . By the definition of handle decomposition, the gluing datum of  $H_2$  onto the handles with lower indices is encoded as a link  $l$  in  $Y$ . Define the stable shadow  $sh'(X, H)$  to be  $CO(Y, l)$ .  $\diamond$

**Remark 2.22** It is a theorem of [Tur10, sec.IX.4.2] that  $sh'(X, H)$  does not depend on the choice of  $H$  as a stable shadow. In fact,  $sh'(X, H)$  equals the stable shadow  $sh(X)$  [Tur10, sec. IX.7].  $\diamond$

**Remark 2.23** [GS, section 4.4] The handles of indices  $\leq 2$  are enough to reconstruct the whole closed 4-manifold.  $\diamond$

### 3 Sum $(\int_{\mathbb{T}} A)$

#### 3.1 Crane-Yetter state sum

Throughout this section, let  $C$  to be a coordinated premodular category and  $I$  be the set of simple  $C$ -objects.

**Definition 3.1 (colored combinatorial manifold)** A  $C$ -coloring of a combinatorial manifold  $X$  is a map  $\beta : X_2 \rightarrow I$ , where  $X_2$  denotes the set of oriented 2-simplices of  $X$ , such that  $\beta(-x) = \beta(x)^*$  for all  $x \in X_2$ . A  $C$ -colored combinatorial manifold is a pair of a combinatorial manifold and a  $C$ -coloring of  $X$ .  $\diamond$

**Definition 3.2 (10j symbol for a colored simplex)** Let  $\Delta$  be a 4-simplex with a total ordering on the set of vertices, and let  $\beta$  to be a  $C$ -coloring for  $\Delta$ .  $C$ -colored simplex. Denote  $\beta_{\widehat{ab}}$  to be the color  $\beta(\Delta_4(\widehat{ab})) \in I$  assigned to the oriented 2-cell  $\Delta_4(\widehat{ab})$ . We define the 10j symbols for  $(\Delta, \beta)$  to be the 10j-symbols (1.14)

$$10j(\Delta) = \left| \begin{array}{cccc} \beta_{\widehat{01}} & \beta_{\widehat{02}} & \beta_{\widehat{03}} & \beta_{\widehat{04}} \\ \cdot & \beta_{\widehat{12}} & \beta_{\widehat{13}} & \beta_{\widehat{14}} \\ \cdot & \cdot & \beta_{\widehat{23}} & \beta_{\widehat{24}} \\ \cdot & \cdot & \cdot & \beta_{\widehat{34}} \end{array} \right|_{10j}, \quad \overline{10j}(\Delta) = \left| \begin{array}{cccc} \beta_{\widehat{01}} & \beta_{\widehat{02}} & \beta_{\widehat{03}} & \beta_{\widehat{04}} \\ \cdot & \beta_{\widehat{12}} & \beta_{\widehat{13}} & \beta_{\widehat{14}} \\ \cdot & \cdot & \beta_{\widehat{23}} & \beta_{\widehat{24}} \\ \cdot & \cdot & \cdot & \beta_{\widehat{34}} \end{array} \right|_{\overline{10j}}.$$

$\diamond$

**Definition 3.3 (Crane-Yetter state sum for a closed 4-manifold)** Let  $X$  be an connected, oriented, closed piecewise-linear manifold,  $\phi : X \xrightarrow{\sim} |K|$  a triangulation,  $\beta : K_2 \rightarrow I$  a  $C$ -coloring of  $K$ , and  $\tau$  a total ordering on the set of vertices of  $K$ .

For each 4-simplex  $\Delta$  of  $K$ , we assign a 10j-symbol  $10J(\beta, \Delta)$  as follows. If the orientation restricted from  $X$  agrees with that from  $\tau$  (i.e.  $[X]_{|\Delta} = \tau|_{\Delta}$ , or say of coherent orientation), then we assign  $10J(\beta, \Delta) = 10j(\Delta, \beta|_{\Delta})$ ; otherwise, if  $[X]_{|\Delta} = -\tau|_{\Delta}$  (or say decoherent orientation), then we assign  $10J(\beta, \Delta) = \overline{10j}(\Delta, \beta|_{\Delta})$ .

Now each 4-simplex has a 10j-symbol, which is just a linear map. Recall that the oriented 3-simplices correspond to morphism spaces. We will contract the linear maps (taking a huge trace) using the fact that each 3-simplex  $\Delta'$  is the face of exactly two 4-simplices. More concretely, observe that there are two cases.

- Both of them have coherent (or decoherent) orientations.
- One of them has coherent orientation, while the other has decoherent orientation.

In the first case, the corresponding vertices (1.14) of the  $C$ -colored graphs that underly the assigned 10j-symbols have the incoming and outgoing arrows exchanged. In the second case, the orientations of the arrows are the same but the colors are dual. Hence in both cases, we can contract the 10j-symbols along  $\Delta'$  as usual (1.7). Since  $X$  is a closed 4-manifold, the final result is an element in the underlying field (i.e. a number).

Finally, we define the Crane-Yetter state sum of  $X$  to be the number

$$\int_X^{\text{CY}} C := D^{2(n_0 - n_1)} \sum_{\beta} \prod_f \dim(\beta(f)) \left( * \bigotimes_{\Delta} 10J(\beta; \Delta) \right),$$

where  $D^2$  denotes the global dimension of  $C$ ,  $n_0$  denotes the amount of vertices,  $n_1$  denotes the amount of edges, the sum runs over all possible  $C$ -colorings  $\beta$  of  $K$ , the product runs through all faces  $f$  of  $K$  (recall  $\dim(x) = \dim(x^*)$  for all  $x$  in  $C$ ), the tensor product runs through all 4-simplices of  $K$ , and  $*$  denotes the large contraction specified above.

The result only depends on the PL-homeomorphism type of  $X$  due to the invariance under Pachner moves. We refer the curious readers to the original paper [CY93] [CKY97].  $\diamond$

The original state sum uses 15j-symbols and therefore involves a product running through the 3-simplices. The term is absent here because it is absorbed into the 10j symbols. The state sum is expected to be extended to a fully extended topological quantum field theory ([BJS21, section 1.5] [Coo19] [BBJ18] [KT21]). For explicit evaluations of the Crane-Yetter model see [Bär21] (for numerical values on 4-folds) and [Guu21] (for categorical values on 2-folds).

## 3.2 Shadow state sum

Throughout this subsection (3.2), we fix an orientable shadowed 2-polyhedron  $P$  (over  $\mathbb{Z}[\frac{1}{2}]$ , with boundary), a coordinated premodular category  $\mathcal{C}$ , and its set of simple objects  $I$ . Our goal is to define the shadow state sum  $\int_P^{\text{sh}} \mathcal{C}$ .

**Definition 3.4 (module of a trivalent graph)** Let  $K_0$  be the empty graph and  $\gamma$  be a trivalent graph. A  $\mathcal{C}$ -coloring of  $\gamma$  is a map

$$\{\text{oriented edge of } \gamma\} \xrightarrow{\lambda} I, \quad \text{with } \lambda(e) = \lambda(-e)^*.$$

Define a  $\mathbb{k}$ -module

$$H(\lambda) = \bigotimes_x H(\lambda_x, \lambda'_x, \lambda''_x),$$

where  $H$  denotes the symmetrized modules (1.6),  $x$  runs through all vertices of  $\gamma$  and the  $\lambda_x$ 's denote the colors assigned to the nearby edges oriented toward  $x$ . Define  $\mathbb{k}$ -modules

$$H(\gamma) = \bigoplus_{\lambda \in \text{color}(\gamma; \mathcal{C})} H(\lambda), \quad H(K_0) = \mathbb{k},$$

where  $\text{color}(\gamma; \mathcal{C})$  denotes the set of  $\mathcal{C}$ -colorings of  $\gamma$ . ◇

By a  $\mathcal{C}$ -coloring of  $P$  we mean a map  $\phi$  from the set of oriented regions of  $P$  to  $I$  such that  $\phi(\Sigma) = \phi(-\Sigma)^*$ . Denote by  $\text{color}(P; \mathcal{C})$  the set of all  $\mathcal{C}$ -colorings of  $P$ . An orientation of a 2D region induces an orientation on its edges by  $(\vec{n} \wedge -)$ , where  $\vec{n}$  denotes a vector pointing outward from the region. Therefore, a  $\mathcal{C}$ -coloring  $\phi$  of  $P$  induces a  $\mathcal{C}$ -coloring  $\partial\phi$  of its boundary  $\partial P$ , a trivalent graph.

**Definition 3.5 (shadow state sum)** [Tur10, section X.1.2]

Every  $\mathcal{C}$ -coloring on  $\partial P$  extends to some  $\mathcal{C}$ -coloring on  $P$ , so  $H(\partial P) = \sum_{\phi \in \text{color}(P; \mathcal{C})} H(\partial\phi)$ . Fix a  $\phi \in \text{color}(P; \mathcal{C})$ , and define the following  $\mathbb{k}$ -modules and vectors.

- For each oriented edge  $\vec{e}$  in  $P \setminus \partial P$ , define  $H_\phi(\vec{e})$  to be  $H(i, i', i'')$  where the  $i$ 's are the colors assigned to the three adjacent regions compatibly oriented with  $\vec{e}$ .
- For each (unoriented) edge  $e$  in  $P \setminus \partial P$ , define  $H_\phi(e)$  to be the non-ordered tensor product  $H_\phi(\vec{e}) \otimes H_\phi(-\vec{e})$  with an arbitrary orientation  $\vec{e}$ . The pairing (1.7) defines a canonical vector  $|e|_\phi \in H_\phi(e)$ .
- For each tetrahedral point  $x \in P$ , pick a small enough neighborhood  $U$  of  $x$  in  $P$  homeomorphic to the cone of the 1-skeleton of the boundary of some tetrahedron. The closure  $\bar{U}$  a  $\mathcal{C}$ -colored 2-polyhedron with four boundary line points  $x_0, x_1, x_2, x_3$  and six  $\mathcal{C}$ -colored regions. Denote by  $\phi_{ij}$  the color for the oriented region  $\overrightarrow{x x_i x_j}$  (clearly,  $\phi_{ij} = \phi_{ji}^*$ ). Finally, define a vector and a  $\mathbb{k}$ -module

$$|x|_\phi := \begin{vmatrix} \phi_{01} & \phi_{02} & \phi_{30} \\ \phi_{32} & \phi_{13} & \phi_{21} \end{vmatrix} \in \bigotimes_{i=0}^3 H_\phi(\overrightarrow{x_i x}) =: H_\phi(x),$$

where  $\otimes$  denotes the unordered tensor product of  $\mathbb{k}$ -modules. The result is independent to the labeling  $0, 1, 2, 3$ .

The procedure above defines a vector in the  $\mathbb{k}$ -module

$$(\otimes_x |x|_\phi) \otimes (\otimes_e |e|_\phi) \in \left( \bigotimes_x H_\phi(x) \right) \otimes \left( \bigotimes_e H_\phi(e) \right)$$

where  $x$  runs over all tetrahedral points of  $P$ , and  $e$  runs over all (nonoriented) edges of  $P \setminus \partial P$ . By contracting the vector along all tetrahedral points  $x$  and all edges  $e$  whose boundary points are not both in  $\partial P$ , we obtain a vector in  $|\phi| \in H(\partial\phi)$ . Finally, we define the shadow state sum to be

$$\left( \int_P^{\text{sh}} C \right) = \left( D^{-b_2(P) - \text{null}(P)} \sum_{\phi \in \text{color}(P)} \sigma_\phi |\phi| \right) \in \sum_\phi H(\partial\phi) = H(\partial P),$$

where  $D$  denotes the global dimension,  $b_2$  denotes the second betti number,  $\text{null}$  denotes the nullity (2.11), and  $\sigma_\phi \in \mathbb{k}$  is a normalizing constant defined as

$$\sigma_\phi = \prod_e \dim'_C(\partial\phi(e))^{-1} \prod_Y \dim_C(\phi(Y))^{\chi(Y)} \nu'_\phi(Y)^{2g(Y)} \prod_g \dim_{\mathbb{k}}(\text{Hom}_C(V_0, V_i \otimes V_j \otimes V_k)),$$

where  $e$  runs over edges of  $\partial P$  (but not circle 1-strata),  $Y$  runs over regions of  $X$ ,  $g$  runs over circle 1-strata of  $\text{sing}(X)$ , and  $\chi$  denotes the Euler characteristics.  $\diamond$

**Proposition 3.6 (shadow state sum is invariant under stable shadow move)** Let  $C$  be a premodular category and  $P, P'$  be 2-polyhedra that are equal as stable shadows. Then

$$\int_P^{\text{sh}} C = \int_{P'}^{\text{sh}} C.$$

Namely, shadow state sum is invariant under stable shadow move.  $\diamond$

*Proof.* We start with the special case where  $C$  is a modular category. For invariance under basic shadow moves, the essential ingredients are the orthonormality relation, the Racah identity, and the Biedenharn-Elliott identity (1.9); see [Tur10, theorem X.2.1] for a proof. For invariance under addition of  $S_0^2$ , it boils down to proving the addition formula

$$|P_1 + P_2| = |P_1| \otimes |P_2|$$

[Tur10, theorem X.2.2] and using the equality  $|S_0^2| = D^{-2} \sum_{i \in I} \dim(i)^2 = 1$ . Both proofs carry through verbatim to the premodular case.  $\blacksquare$

**Definition 3.7 (shadow state sum of a 4-manifold)** Let  $X$  be a closed 4-manifold,  $C$  a coordinated premodular category,  $\text{stab}([P])$  a stable shadow of  $X$  represented by a shadowed 2-polyhedron  $P$ . Define the shadow state sum  $\int_X^{\text{sh}} C$  of  $X$  to be  $\int_P^{\text{sh}} C$ , which is well-defined by 2.22 and 3.6.  $\diamond$

### 3.3 Main result: equivalence of state sums

We state and prove the main theorem of this paper. See 0.3 for the main idea of the proof.



**Theorem 3.8 (equivalence of state sums)** Let  $X$  be a closed 4-manifold and  $C$  be a coordinated pre-modular category. Then

$$\int_X^{\text{CY}} C = \int_X^{\text{sh}} C.$$

Namely, their Crane-Yetter state sum and shadow state sum are equal.  $\diamond$

**Remark 3.9** The Witten-Reshetikhin-Turaev (quantum Chern-Simons) model is known to be the boundary theory of Crane-Yetter model [BGM07] [Tha21]. It is also shown that the former is the boundary theory of the shadow TQFT [Tur10, X.3.2 & theorem X.3.3]. Therefore, theorem 3.8 provides another proof for the first fact.  $\diamond$

*Proof.* Fix a small  $\epsilon > 0$ .

We begin by computing the shadow state sum for  $X$ . First, fix a triangulation  $T$  for  $X$ . Denote by  $T_i$  to be the set of  $i$ -cells of  $T$ , and fix a total ordering on  $T_0$ . Recall that the ordering induces an orientation of each 4-cell. If it agrees with the orientation from  $X$ , we call it a coherently oriented cell; otherwise a decoherently oriented cell. From  $T$  we will construct a shadow of a similar “shape”. Indeed, the dual of the any triangulation provides a handle decomposition  $H$ , in which each  $k$ -cell corresponds to an  $(n - k)$ -handle. The construction in (2.21) constructs a shadow for  $X$ , as follows.

Take the union of the 0-handles and the 1-handles. Its boundary  $Y$  is a connected sum of  $|T_0|$  3-spheres. By (2.21 and 2.20), we need to pick a skeleton of  $Y$ . We will construct a very concrete one as follows. Within each 4-simplex  $\Delta$ ,  $Y \cap \Delta$  is  $S^3 \setminus (5 \times B^3)$ . Think of this as  $\mathbb{R}^3 \setminus \bigcup_{\vec{v}} B_\epsilon(\vec{v})$ , where  $B_r(x)$  denotes the ball of radius  $r$  centered at  $x$ , and  $\vec{v}$  runs through the set  $\{(1, 0, 0), (0, 1, 0), (-1, 0, 0), (0, -1, 0)\}$ . Denote  $S^1(\vec{v})$  to be the equator dual to  $\vec{v}$  of each 2-sphere  $S^2(\vec{v}) := \partial B_\epsilon(\vec{v})$ . The largest component of  $B_0(1) \setminus (\bigcup_{\vec{v}} S^1(\vec{v}))$  is a 4-punctured 2-sphere. Finally, remove an  $\epsilon$ -disk centered at  $(0, 0, 1)$  from it, and let the boundary straightly stretch to  $(0, 0, +\infty)$ ; this is a 5-punctured 2-sphere  $\Sigma$ , which is a local skeleton for  $Y$ .

To continue following (2.21), we need to project to the links (the gluing data of the 2-handles in  $Y$ ) to  $\Sigma$ . It is a geometric exercise to construct a projection so that the projected diagrams look as follows

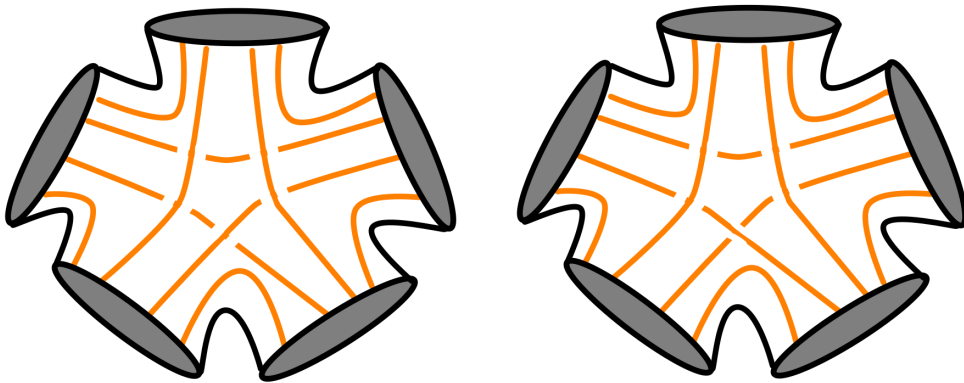

depending on whether the 4-cell is coherently oriented or not. The construction then cones the projected links, and assigns gleams around each intersection of links on  $\Sigma$ . This encodes a local piece of the complete shadow, which is a gleamed 2-polyhedron  $P$  without boundary. However,  $P$  also looks the same locally within each 4-simplex (up to mirror), so for simplicity we will keep working locally.

The shadow state sum, locally, is represented by the following diagram and its mirrored image.

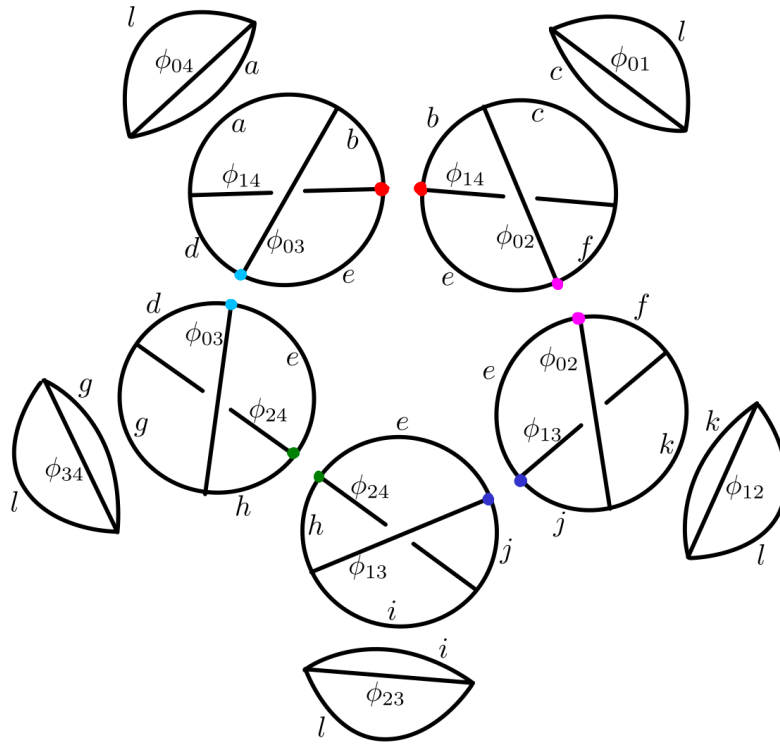

where each of the 5 tetrahedral graphs is obtained by the 6j-symbol twisted with the 4 gleams around the corresponding tetrahedral point. The vertices in the graph are paired (indicated by the colors), and paired vertices are actually labeled by elements of the bases and dual bases of the morphism spaces. We contract them and obtain the following diagram using the techniques given in [KB10, Lemma 1.1, 1.3].

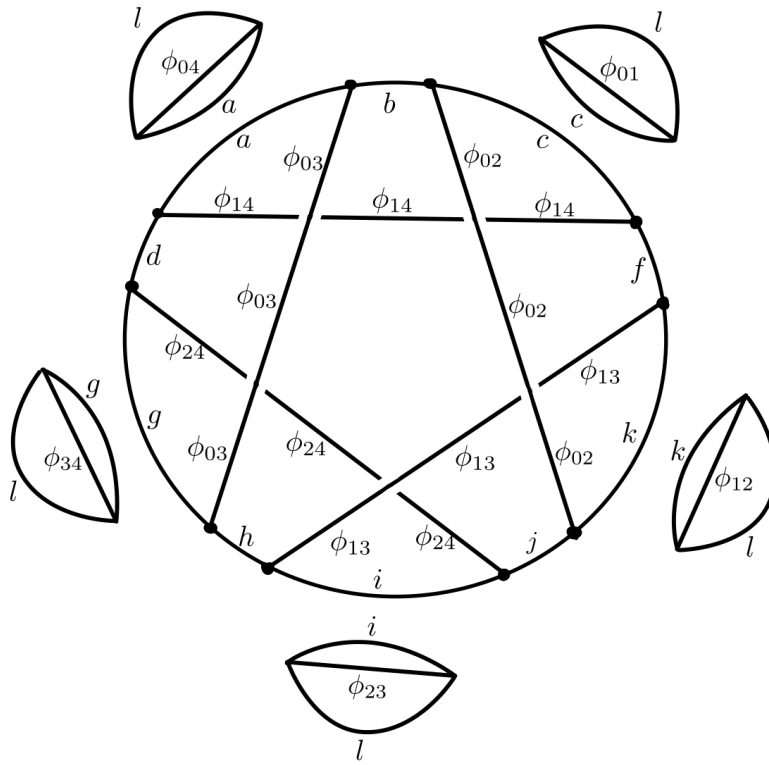

We can further contract each theta graph to the central component using the following procedure.

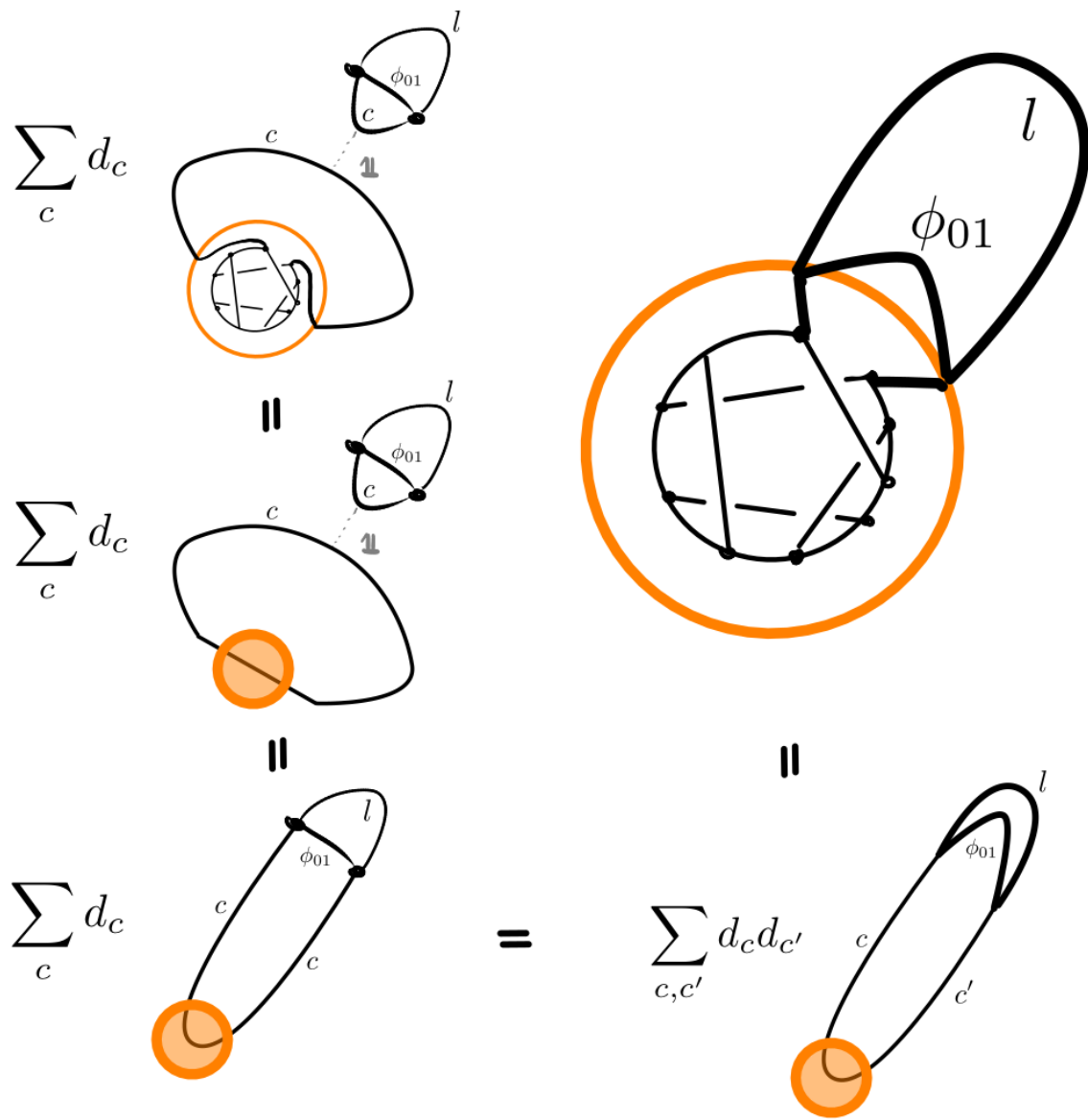

Repeat for five times, and the result is the following

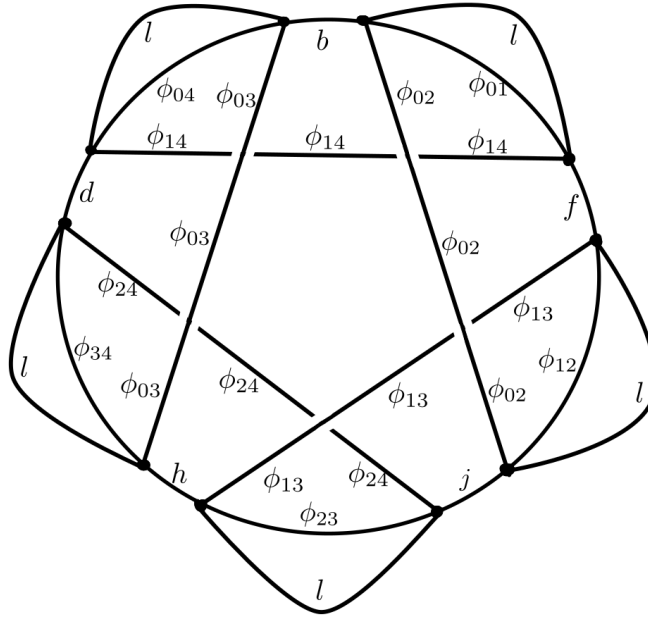

This is almost the 10j-symbol involved in the definition of the  $\int_X^{\text{CY}} C$ , except the extra edges labeled by  $b, d, f, h, j, l$ . However, after contracting the local pieces together, the extra edges form unlinks (colored by the regular coloring  $\Omega = \sum_{i \in I} \dim(i)i$ ) and therefore can be viewed as a factor  $D^2$  and removed from the diagram. The rest of the proof is by counting. ■

## References

- [Bär21] Manuel Bärenz. *Evaluating TQFT invariants from G-crossed braided spherical fusion categories via Kirby diagrams with 3-handles*. 2021. arXiv: [1810.05833](https://arxiv.org/abs/1810.05833) [[math.GT](#)].
- [BBJ18] David Ben-Zvi, Adrien Brochier, and David Jordan. “Integrating quantum groups over surfaces”. In: *Journal of Topology* 11.4 (Aug. 2018), pp. 874–917. ISSN: 1753-8416. DOI: [10.1112/topo.12072](https://doi.org/10.1112/topo.12072). URL: <http://dx.doi.org/10.1112/topo.12072>.
- [BGM07] John W. Barrett, J. Manuel Garcia-Islas, and Joao Faria Martins. “Observables in the Turaev-Viro and Crane-Yetter models”. In: *J. Math. Phys.* 48 (2007), p. 093508. DOI: [10.1063/1.2759440](https://doi.org/10.1063/1.2759440). arXiv: [math/0411281](https://arxiv.org/abs/math/0411281).

- [BJS21] Adrien Brochier, David Jordan, and Noah Snyder. “On dualizability of braided tensor categories”. In: *Compositio Mathematica* 157.3 (Mar. 2021), pp. 435–483. ISSN: 1570-5846. DOI: [10.1112/s0010437x20007630](https://doi.org/10.1112/S0010437X20007630). URL: <http://dx.doi.org/10.1112/S0010437X20007630>.
- [CKY97] Louis Crane, Louis H. Kauffman, and David N. Yetter. “State-Sum Invariants of 4-Manifolds”. In: *Journal of Knot Theory and Its Ramifications / Vol. 06, No. 02, pp. 177-234* (1997).
- [Coo19] Juliet Cooke. “Excision of Skein Categories and Factorisation Homology”. In: (2019). arXiv: [1910.02630](https://arxiv.org/abs/1910.02630) [math.QA].
- [CY93] Louis Crane and David Yetter. “A categorical construction of 4D topological quantum field theories”. In: (1993), pp. 120–130. DOI: [10.1142/9789812796387\\_0005](https://doi.org/10.1142/9789812796387_0005).
- [Eti+15] Pavel Etingof et al. *Tensor Categories*. American Mathematical Society, 2015.
- [GS] Robert E. Gompf and András I. Stipsicz. *4-Manifolds and Kirby Calculus*. ISBN: 0-8218-0994-6.
- [Guu21] Jin-Cheng Guu. “Categorical Center of Higher Genera and 4D Factorization Homology”. In: *submitted to Quantum Topology* (2021). arXiv: [2107.05914](https://arxiv.org/abs/2107.05914) [math.QA].
- [KB10] Alexander Kirillov and Benjamin Balsam. “Turaev-Viro invariants as an extended TQFT”. In: (2010). arXiv: [1004.1533](https://arxiv.org/abs/1004.1533) [math.GT].
- [KR18] Mikhail Khovanov and Louis-Hadrien Robert. *Foam evaluation and Kronheimer–Mrowka theories*. 2018. arXiv: [1808.09662](https://arxiv.org/abs/1808.09662) [math.GT].
- [KT21] Alexander Kirillov and Ying Hong Tham. “Factorization Homology and 4D TQFT”. In: *Quantum Topology (to appear)* (2021). arXiv: [2002.08571](https://arxiv.org/abs/2002.08571).
- [Man16] Ciprian Manolescu. “Lectures on the triangulation conjecture”. In: (2016). arXiv: [1607.08163](https://arxiv.org/abs/1607.08163).
- [Mat] Sergei Matveev. *Algorithmic Topology and Classification of 3-Manifolds*. ISBN: 3-540-44171-9.
- [Mil] John Milnor. “Topological Manifolds and Smooth Manifolds”. In: ().
- [Reu20] David Reutter. *Semisimple 4-dimensional topological field theories cannot detect exotic smooth structure*. 2020. arXiv: [2001.02288](https://arxiv.org/abs/2001.02288) [math.GT].
- [RS] C. P. Rourke and B. J. Sanderson. *Introduction to Piecewise-Linear Topology*. Springer-Verlag New York Heidelberg Berlin. ISBN: 0-387-05800-1.
- [Sco] Alexandru Scorpan. *The Wild World of 4-Manifolds*. ISBN: 0-8218-3749-4.
- [Tha21] Ying Hong Tham. “On the Category of Boundary Values in the Extended Crane-Yetter TQFT”. Ph.D. thesis. 2021. arXiv: [2108.13467](https://arxiv.org/abs/2108.13467) [math.QA].
- [Tur10] Vladimir G. Turaev. *Quantum Invariants of Knots and 3-Manifolds*. De Gruyter, 2010. ISBN: 978-3-11-022183-1.

- [Tur91] Vladimir G. Turaev. “Topology of Shadows”. In: (1991).
- [Wal21] Kevin Walker. *A universal state sum*. 2021. arXiv: [2104.02101](https://arxiv.org/abs/2104.02101) [math.QA].