

Advanced General Relativity Notes

M. Le Delliou

August 5, 2022

In this class is implied the knowledge of a GR1 course.

Conventions: In most of the course we will use

$$c = 1$$

In some parts we will set

$$G = 1$$

Following [Ellis *et al.*(2012)Ellis, Maartens, and MacCallum], we chose the conventions for

- the metric signature in 4D as $- + + +$
- the sign of the Riemann tensor, as set in the Ricci identities

$$2u_{c[b;a]} = R_{abcd}u^d$$

- the sign of the Ricci tensor, from the choice of contraction

$$R_{ab} = R^c_{acb}$$

- the Einstein summation

$$X^a_a \equiv \sum_{a=0}^3 X^a_a$$

- the covariant derivative ($\pm\Gamma$ being the connection, with the sign depending on the indices of X)

$$X_{;a} = \partial_a X + \sum (\pm 1) \Gamma X$$

- the Lie derivative

$$\mathcal{L}_v X = v^a X_{;a} + \sum_{i,j} \left(-v^a_{;b} X^{\dots b \dots} + v^a_{;b_j} X^{\dots a \dots} \right)$$

- the indices (anti)symmetrisations (with σ permutation among indices of signature ϵ_σ)

$$X \left(a_1 \dots a_n \right) = \frac{1}{n!} \sum_{\sigma} X_{\sigma(a_1) \dots \sigma(a_n)}$$

$$X \left[a_1 \dots a_n \right] = \frac{1}{n!} \sum_{\sigma} (-1)^{\epsilon_\sigma} X_{\sigma(a_1) \dots \sigma(a_n)}$$

and in particular, we have

$$X_{(ab)} = \frac{1}{2} (X_{ab} + X_{ba})$$

$$X_{[ab]} = \frac{1}{2} (X_{ab} - X_{ba})$$

Beware that those conventions vary from authors or book to authors or books!

A short bibliography for the class can be given as [[Carroll\(2004\)](#), [Ellis *et al.*\(2012\)](#)[Ellis, Maartens, and MacCrittchen\(2004\)](#), [Chandrasekhar\(1985\)](#), [d’Inverno\(1992\)](#), [Plebanski and Krasinski\(2006\)](#), [Wald\(1984\)](#), [Hawking and Ellis\(1973\)](#), [Misner *et al.*\(1970\)](#)[Misner, Thorne, and Wheeler,](#) [Weinberg\(1972\)](#)]

see at the end of the document for full reference

Contents

1	The many forms of the Schwarzschild BH	9
1.1	Standard Schwarzschild solution	9
1.1.1	Characterisation	9
1.1.2	static, spherical metric	10
1.1.3	EFE solutions	10
1.1.3.1	Geometry of static, spherically symmetric metric	10
1.1.3.2	Solutions of EFE	11
1.2	Spatially conformally flat Schwarzschild metric	13
1.3	Lemaître free-falling Schwarzschild metric	14
1.4	Eddington-Filkenstein metric	15
1.4.1	Singularity of Schwarzschild	15
1.4.2	Light curves in Schwarzschild	16
1.4.3	Tortoise coordinates	16
1.4.4	Eddington-Finkelstein coordinates	17
1.5	Kruskal metric	18
2	Conformal, Carter-Penrose, diagrams	23
2.1	Conformal transformation	23
2.2	Minkowski metric	23
2.2.1	Compactify (t, r)	24
2.2.2	Compactify null coordinates	24
2.3	Non-Trivial example: Power law, flat Robertson-Walker metric .	26
2.4	Case of Schwarzschild	28
3	Birkhoff Theorem	31
3.1	Current general form	31
3.2	Spherical case and classic form	31
3.2.1	Preliminary: Killing equation	32
3.2.2	Proof of the classic form	32
3.2.2.1	General form of the metric	32
3.2.2.2	EFE and final proof of the theorem	33

4	Geodesics and congruences	35
4.1	Geodesic equation	35
4.1.1	Geodesic equation from parallel transport	35
4.1.1.1	Recall: parallel transport	35
4.1.1.2	Geodesic equation	35
4.1.2	Geodesic equation from least action principle	36
4.2	Geodesic deviation	38
4.3	Geodesic congruences	39
4.3.1	Timelike geodesic congruences	40
4.3.1.1	1+3 decomposition (Ellis) optical scalars/tensors	40
4.3.1.2	Evolution	42
4.3.1.3	Aside: Energy conditions	42
4.3.1.4	Energy condition and congruence evolution	47
4.3.2	Null geodesic congruences	47
4.3.2.1	2+2 decomposition (Hayward)	47
4.3.2.2	A hint of 1+1+2 decomposition (Clarkson)	48
4.3.2.3	Evolution	49
5	Horizons and singularity theorems	52
5.1	Horizons	52
5.1.1	Event horizons	52
5.1.2	Importance of E.H.	54
5.1.2.1	Singularity theorems	54
5.1.2.2	Cosmic censorship conjecture	55
5.1.3	Killing horizons	57
5.1.3.1	Surface gravity of K.H.	57
5.2	Singularity theorems	61
5.2.1	First Big Bang Singularity theorem	61
5.2.1.1	Definitions	61
5.2.1.2	Lemmas	64
5.2.1.3	First Big Bang Singularity theorem	71
5.2.2	More general Big Bang Singularity theorem	72
5.2.2.1	Definitions	72
5.2.2.2	Lemmas	74
5.2.2.3	More general Big Bang Singularity theorem	75
5.2.3	First Black Hole Singularity theorem	76
5.2.3.1	Definitions	76
5.2.3.2	Lemmas	77
5.2.3.3	First Black Hole Singularity theorem	78
5.2.4	More general Big Bang and Black Hole Singularity theorem	79
5.2.4.1	Definitions	79
5.2.4.2	Lemmas	80
5.2.4.3	More general Big Bang and Black Hole Singularity theorem	80

6	Kerr BH, Penrose Process & BH Thermodyn.	81
6.1	Rotating Black Hole: Kerr-Newman	81
6.1.1	Metric of charged, rotating BH	81
6.1.2	Definitions of Charges	81
6.1.2.1	From conserved currents	83
6.1.2.2	Killing vectors, conserved mass and spin	83
6.1.3	Boyer-Lindquist coordinates	85
6.1.3.1	Analysis of Minkowski space in Boyer-Lindquist coordinates	85
6.1.3.2	Killing vectors/tensor of Boyer-Lindquist coordinates	86
6.1.4	Horizons, stationary limit and singularity	87
6.1.4.1	Horizons	87
6.1.4.2	Stationary limit	88
6.1.4.3	True singularity	89
6.1.4.4	Analytic continuation and timelike loops	91
6.1.4.5	Ergosphere, framedragging and outer horizon angular velocity	92
6.1.5	Carter-Penrose diagram	94
6.1.5.1	Similar to Schwarzschild	94
6.1.5.2	Different from Schwarzschild	94
6.1.5.3	Infinities	94
6.1.5.4	Timelike curves	96
6.1.6	Geodesic motion	96
6.1.6.1	Equatorial motion	96
6.1.6.2	Non equatorial motion	98
6.2	Penrose process and Energy extraction from Black Holes	98
6.2.1	Killing Horizon	99
6.2.2	BH horizon area changes	100
6.2.3	Superradiance	102
6.2.4	Gravitational waves in binary coalescence	102
6.3	Black Hole Thermodynamics	102
6.3.1	Kerr-Newman BH surface gravity	102
6.3.2	Parallel with thermodynamics	105
7	Relativistic Thermodynamics	107
7.1	Eckart's model	107
7.1.1	Energy-momentum tensor	107
7.1.2	Full energy-momentum tensor	108
7.1.3	Problem with Eckart's model	111
7.2	Israel-Stewart model	111

8	Tetrads and Newman-Penrose Tetrads	114
8.1	Tetrads	114
8.1.1	Tetrad tensor components	116
8.1.1.1	Note on 2-tensors and their matrix representation	116
8.1.2	Directional derivatives, connections and Ricci rotation coefficients	118
8.1.2.1	Properties of γ	119
8.1.2.2	Ricci rotation coefficients as Levi-Civita-like connection	120
8.1.2.3	Commutation and structure constants	120
8.1.2.4	Ricci and Bianchi identities	121
8.1.3	General non-orthonormal tetrads	122
8.2	Tetrads from Einstein-Cartan gravity	122
8.2.1	In the frame bundle	123
8.2.1.1	The canonical form θ	124
8.2.1.2	The soldering form $\tilde{\theta}$	124
8.2.1.3	The section σ in local open set of bundle	124
8.2.1.4	The connection ω	124
8.2.1.5	Curvature and torsion	126
8.3	Newman-Penrose tetrads	126
8.3.1	Transportation equations	128
8.3.2	Commutators	128
8.3.3	Weyl, Ricci and Riemann representations	129
8.3.4	Maxwell's equations	130
8.3.5	Some applications of N-P formalism	131
8.3.5.1	Gravitational waves	131
8.3.5.2	Vaidya metric	132
9	Geodesics from Hamilton-Jacobi	136
9.1	Original derivation of Hamilton-Jacobi equation	137
9.2	Geodesics	139
9.2.1	Jacobi theorem for geodesics	140
9.3	Geodesic deviation (overview)	142
9.3.1	Theorems on geodesic deviation solutions	144
10	Motion of a top: M.P.D. equations	150
10.1	Angular velocity tensor	151
10.2	Construction of top motion Lagrangian	151

List of Figures

1.4.1 Schwarzschild radial spacetime diagram	15
1.4.2 Outer tortoise coordinates spacetime diagram	16
1.4.3 Tortoise null coordinates	17
1.4.4 Eddington-Finkelstein light cones	18
1.5.1 Eddington-Finkelstein past light cones	19
1.5.2 Compact null coordinates sign chart. The $U - V$ plane is divided into four sections numbered I-IV.	20
1.5.3 Kruskal spacetime diagram	22
1.5.4 Kruskal Time slices structure	22
2.2.1 Example of compactification function: $\arctan x$	24
2.2.2 Spherical Minkowski null curves	25
2.2.3 Left: 4-cylinder Minkowski representation; right: Penrose dia- gram for Minkowski space.	27
2.3.1 Penrose diagram for power law, flat, FLRW	28
2.4.1 Penrose diagram for the solution	29
3.2.1 Foliation of spherically symmetric spacetime	32
4.2.1 Geodesic family and its tangent vectors	38
4.3.1 Congruence in an open set. Note it fills the whole spacetime open set $O_p \subset M$ and X is 3D.	40
4.3.2 Optical scalars physical effects	40
5.1.1 Conformal diagram for asymptotically flat spacetimes	53
5.1.2 Schwarzschild white hole Carter-Penrose diagram	56
5.1.3 Reissner-Nordström Carter-Penrose diagrams	56
5.2.1 Conjugate points and Jacobi field	63
5.2.2 Conjugate point to a surface and Jacobi field	63
5.2.3 Illustration of upper semicontinuity	64
5.2.4 Smoothing from geodesic with inner conjugate	67
5.2.5 Piecewise vs Geodesic	69
5.2.6 Proof of Piecewise vs Geodesic	70
5.2.7 Domains of dependence	72
5.2.8 Edge of S	73

5.2.9 Future Cauchy Horizon	74
5.2.10 Sequence of timelike curves from S to p supporting geodesics converging to p	75
5.2.11 Sequence of geodesics from S to p_n converging to a geodesic from S to p	76
5.2.12 Boundary of time orientable spacetime submanifold chronological future.	78
6.1.1 Volume to apply Stokes Theorem	82
6.1.2 Iteration on a surface of Stokes theorem	82
6.1.3 $x - z$ plane of Boyer-Lindquist coordinates	86
6.1.4 $x - y$ plane of Boyer-Lindquist coordinates	87
6.1.5 Horizons, stationary limit and Ergosphere	90
6.1.6 Kerr solution Carter-Penrose diagram	95
8.2.1 Cylinder and Möbius strip bundles	123
8.2.2 Frame Bundles representation	124
8.2.3 Bundle Parallel transport	125
9.1.1 Family of trajectories	138
10.0.1 Motion of a top	151

Chapter 1

The many forms of the Schwarzschild Black Hole

Definition 1.1. Black Hole

Black Holes are vacuum, non-trivial solutions of the General Relativity results of primordial extreme density fluctuations or of end of life process of massive stars.

The simplest types are

- spherically symmetric
- static

This is the Schwarzschild solution.

1.1 Standard Schwarzschild solution

1.1.1 Characterisation

Published first in [[Schwarzschild\(1916\)](#)], it is a

- spherically symmetric solution,

(t, r, θ, φ) independently of the angular variables.
metric on a 2-sphere

$$d\Omega^2 = d\theta^2 + \sin^2 \theta d\varphi^2,$$

- vacuum solution,

$$R_{ab} = 0,$$

- static solution,

$$\begin{aligned} g_{ab} &= g_{ab}(r), \\ g_{0i} &= 0. \end{aligned}$$

Example 1.1. spherical Minkowski

$$ds_M^2 = -dt^2 + dr^2 + r^2 d\Omega^2,$$

Definition 1.2. r areal radius

$$\mathcal{S}_2 = \int_{\mathcal{S}_2} r^2 d\Omega^2 = 4\pi r^2.$$

1.1.2 static, spherical metric

$$ds^2 = -e^{2\alpha(r)} dt^2 + e^{2\beta(r)} dr^2 + e^{2\gamma(r)} r^2 d\Omega^2.$$

Without loss of generality, coordinate change

$$\begin{aligned} \bar{r} &= e^\gamma r \\ \Rightarrow d\bar{r} &= e^\gamma dr + e^\gamma r d\gamma = \left(1 + \frac{d\gamma}{d \ln r}\right) e^\gamma dr, \end{aligned}$$

so the metric reads

$$ds^2 = -e^{2\alpha} dt^2 + (1 + r\gamma')^{-2} e^{2(\beta-\gamma)} d\bar{r}^2 + \bar{r}^2 d\Omega^2,$$

relabel

$$\begin{aligned} \bar{r} &\rightarrow r, \\ (1 + r\gamma')^{-2} e^{2(\beta-\gamma)} &\rightarrow e^{2\beta}, \end{aligned}$$

$$\begin{aligned} ds^2 &= -e^{2\alpha} dt^2 + e^{2\beta} dr^2 + r^2 d\Omega^2 \\ \Leftrightarrow g_{ab} &= \begin{pmatrix} -e^{2\alpha} & & & 0 \\ & e^{2\beta} & & \\ & & r^2 & \\ 0 & & & r^2 \sin^2 \theta \end{pmatrix}. \end{aligned}$$

1.1.3 EFE solutions

1.1.3.1 Geometry of static, spherically symmetric metric

Christoffel (Γ) connection, no torsion $\Gamma_{bc}^a = \frac{g^{ad}}{2} (\partial_b g_{cd} + \partial_c g_{bd} - \partial_d g_{bc})$, only r dependence, $\partial_r \equiv ' ,$

$$\begin{aligned} \Gamma_{01}^0 &= \alpha', & \Gamma_{00}^1 &= e^{2(\alpha-\beta)} \alpha', & \Gamma_{11}^1 &= \beta', \\ \Gamma_{12}^2 &= \frac{1}{r}, & \Gamma_{22}^1 &= -r e^{-2\beta}, & \Gamma_{13}^3 &= \frac{1}{r}, \\ \Gamma_{33}^1 &= -r e^{-2\beta} \sin^2 \theta, & \Gamma_{33}^2 &= -\sin \theta \cos \theta, & \Gamma_{23}^3 &= \cot \theta, \end{aligned}$$

(exercise)rest are 0 or symmetric.

(From

$$2[\nabla_c, \nabla_d]V^a = R^a_{bcd}V^b - T^e_{cd}\nabla_e V^a,$$

$$T^e_{cd} = 2\Gamma^e_{[cd]},$$

$$\begin{aligned} R^a_{bcd} &= \partial_c \Gamma^a_{db} - \partial_d \Gamma^a_{cb} + \Gamma^a_{ce} \Gamma^e_{db} - \Gamma^a_{de} \Gamma^e_{cb} \\ &= 2\Gamma^a_{b[d,c]} + 2\Gamma^a_{[c|e} \Gamma^e_{|d]b} \end{aligned}$$

)Then Riemann

$$\begin{aligned} R^0_{101} &= \alpha' \beta' - \alpha'' - (\alpha')^2, & R^0_{202} &= -re^{-2\beta} \alpha', \\ R^0_{303} &= -re^{-2\beta} \sin^2 \theta \alpha', & R^1_{212} &= re^{-2\beta} \beta', \\ R^1_{313} &= re^{-2\beta} \sin^2 \theta \beta', & R^2_{323} &= (1 - e^{-2\beta}) \sin^2 \theta, \end{aligned}$$

(exercise)rest are 0 or symmetric.

Ricci & Ricci scalar

$$\begin{aligned} R_{00} &= R^1_{010} + R^2_{020} + R^3_{030} = g^{11}g_{00}R^0_{101} + g^{22}g_{00}R^0_{202} + g^{33}g_{00}R^0_{303} \\ &= e^{2(\alpha-\beta)} \left[\alpha'' + (\alpha')^2 - \alpha' \beta' + \frac{2}{r} \alpha' \right], \end{aligned}$$

$$R_{11} = -\alpha'' - (\alpha')^2 + \alpha' \beta' + \frac{2}{r} \beta',$$

$$R_{22} = e^{-2\beta} [r(\beta' - \alpha') - 1] + 1,$$

$$R_{33} = R_{22} \sin^2 \theta,$$

(exercise)rest are 0 or symmetric,

$$\Rightarrow R = e^{-2\beta} \left[\alpha'' + (\alpha')^2 - \alpha' \beta' + \frac{2}{r} (\alpha' - \beta') + \frac{1}{r^2} (1 - e^{2\beta}) \right].$$

1.1.3.2 Solutions of EFE

Vacuum: $R_{ab} = 0$.

•

$$\begin{aligned} 0 &= e^{2(\beta-\alpha)} R_{00} + R_{11} = \frac{2}{r} (\alpha + \beta)' \\ \Rightarrow \alpha &= -\beta + C, \end{aligned}$$

so

$$g_{00} dt^2 = e^{-2\beta} (e^C dt)^2,$$

rescale $t \rightarrow e^{-C} t$ set C to 0

$$\Rightarrow \alpha = -\beta,$$

•

$$\begin{aligned}
 R_{22} &= 0 \\
 \Leftrightarrow 1 &= e^{2\alpha} [1 + 2r\alpha'] = (re^{2\alpha})' \\
 \Rightarrow e^{2\alpha} &= 1 + \frac{A}{r} = 1 - \frac{R_s}{r},
 \end{aligned}$$

choosing A .

Metric becomes

$$ds^2 = - \left(1 - \frac{R_s}{r}\right) dt^2 + \left(1 - \frac{R_s}{r}\right)^{-1} dr^2 + r^2 d\Omega^2.$$

It is easy to verify (exercise) R_s Schwarzschild radius

$$\begin{aligned}
 R_{00} &\propto (re^{2\alpha})'' = 0, \\
 R_{11} &\propto R_{00} = 0.
 \end{aligned}$$

Recall Weak field limit:

To fix $R_s \rightarrow$ Newtonian gravity.

Static field $\partial_0 g_{ab} = 0$

Slowly moving objects : $\frac{dx^i}{d\tau} \ll \frac{dt}{d\tau}$

Geodesic equations :

$$\frac{d^2 x^a}{d\tau^2} + \Gamma_{00}^a \left(\frac{dt}{d\tau}\right)^2 = 0.$$

$$\begin{aligned}
 \partial_0 g_{ab} = 0 &\Rightarrow \Gamma_{00}^a = \frac{g^{ad}}{2} (\partial_0 g_{0d} + \partial_0 g_{0d} - \partial_d g_{00}) \\
 &= -\frac{1}{2} g^{ab} \partial_b g_{00}.
 \end{aligned}$$

Decompose metric into small perturbations around inertial Minkowski

$$\begin{aligned}
 g_{ab} &= \eta_{ab} + h_{ab}, \quad |h_{ab}| \ll 1 \\
 g_{ac} g^{cb} &= \delta_a^b \\
 \Rightarrow g^{ab} &= \eta^{ab} - h^{ab} \text{ to 1st order in } h \\
 \text{with } h^{ab} &= \eta^{ac} \eta^{bd} h_{cd}
 \end{aligned}$$

To first order

$$\begin{aligned}
 \Gamma_{00}^a &= -\frac{1}{2} \eta^{ab} \partial_b h_{00} \text{ and} \\
 \frac{d^2 x^a}{d\tau^2} &= \frac{1}{2} \eta^{ab} \partial_b h_{00} \left(\frac{dt}{d\tau}\right)^2.
 \end{aligned}$$

From $\partial_0 h_{00} = 0$, we get

$$\frac{d^2 x^0}{d\tau^2} = 0 \Leftrightarrow \frac{dt}{d\tau} = cst$$

Thus

$$\begin{aligned} \frac{d^2 x^\mu}{d\tau^2} &= \frac{1}{2} \partial_\mu h_{00} \left(\frac{dt}{d\tau} \right)^2 = \frac{dt}{d\tau} \frac{d}{dt} \left(\frac{dt}{d\tau} \frac{dx^\mu}{dt} \right) = \left(\frac{dt}{d\tau} \right)^2 \frac{d^2 x^\mu}{dt^2} \\ \Leftrightarrow \frac{d^2 x^\mu}{dt^2} &= \frac{1}{2} \partial_\mu h_{00}, \end{aligned}$$

Newton's equation for $h_{00} = -2\Phi$

$$g_{00} \underset{r \gg R_s}{=} -(1 + 2\Phi) = - \left(1 - \frac{R_s}{r} \right).$$

In our case we have vacuum and a central mass

$$\Rightarrow \Phi = - \frac{GM}{r} \quad \Rightarrow R_s = 2GM.$$

M parameter: Newtonian mass in weak field limit $r \gg 2GM$ Schwarzschild metric

$$ds^2 = - \left(1 - \frac{2GM}{r} \right) dt^2 + \left(1 - \frac{2GM}{r} \right)^{-1} dr^2 + r^2 d\Omega^2.$$

Recover Minkowski

$$\begin{aligned} M &\rightarrow 0 \\ r &\rightarrow \infty \end{aligned}$$

\rightarrow asymptotic flatness. G set to 1: natural units

Example 1.2. For the Sun

$$R_\odot = 10^6 GM_\odot \gg R_{s_\odot}.$$

1.2 Spatially conformally flat Schwarzschild metric

A.K.A. Isotropic radial coordinate metric [Stephani(2004), Sec. 23.6], first proposed by Eddington [Eddington(1923), p93]. We want to write Schwarzschild in the Euclidean form

$$\begin{aligned} ds^2 &= -A^2(\bar{r})dt^2 + B^2(\bar{r})d\Sigma^2 \text{ with } d\Sigma^2 = d\bar{r}^2 + \bar{r}^2 d\Omega^2 \\ &= -A^2 dt^2 + B^2 d\bar{r}^2 + B^2 \bar{r}^2 d\Omega^2 \\ &= - \left(1 - \frac{2M}{r} \right) dt^2 + \left(1 - \frac{2M}{r} \right)^{-1} dr^2 + r^2 d\Omega^2, \end{aligned}$$

equate with Schwarzschild

$$r^2 = B^2 \bar{r}^2$$

$$\frac{dr^2}{1 - \frac{2M}{r}} = B^2 d\bar{r}^2$$

Divide:

$$\frac{dr^2}{(r - 2M)r} = \left(\frac{d\bar{r}}{\bar{r}}\right)^2,$$

solution: (exercise: verify solution)

$$r = \bar{r} \left(1 + \frac{M}{2\bar{r}}\right)^2$$

$$\Rightarrow B^2 = \left(\frac{r}{\bar{r}}\right)^2 = \left(1 + \frac{M}{2\bar{r}}\right)^4,$$

$$A^2 = 1 - \frac{2M}{r} = \frac{\bar{r} \left(1 + \frac{2M}{2\bar{r}} + \frac{M^2}{4\bar{r}^2}\right) - 2M}{\bar{r} \left(1 + \frac{M}{2\bar{r}}\right)^2} = \left(\frac{1 - \frac{M}{2\bar{r}}}{1 + \frac{M}{2\bar{r}}}\right)^2.$$

$$ds^2 = - \left(\frac{1 - \frac{M}{2\bar{r}}}{1 + \frac{M}{2\bar{r}}}\right)^2 dt^2 + \left(1 + \frac{M}{2\bar{r}}\right)^4 [d\bar{r}^2 + \bar{r}^2 d\Omega^2].$$

1.3 Lemaître free-falling Schwarzschild metric

Transforming to Lemaître coordinates

$$dT = dt + \sqrt{\frac{2GM}{r}} \frac{dr}{1 - \frac{2GM}{r}} \quad dR = dt + \sqrt{\frac{r}{2GM}} \frac{dr}{1 - \frac{2GM}{r}}$$

yields from Schwarzschild to the Lemaître metric, removing the $r = 2GM$ singularity, a synchronous metric as all static observers admit the same proper time ($g_{tt} = cst$)

$$ds^2 = -dT^2 + \frac{2GM}{r} dR^2 + r^2 d\Omega^2, \quad r = r(T, R).$$

From coordinates transformation, $dR - dT = \sqrt{\frac{r}{2GM}} dr$, which integrates into $r = \left[\frac{3}{2}(R - T)\right]^{\frac{2}{3}} (2GM)^{\frac{1}{3}}$.

Radial free fall can be found for static Lemaître observers:

$$dR = 0 \Rightarrow dt = - \sqrt{\frac{r}{2GM}} \frac{dr}{1 - \frac{2GM}{r}} \Big|_{r \rightarrow (2GM)^+} - \frac{2GM}{r - 2GM} dr \Rightarrow \frac{r - 2GM}{r_i - 2GM} = e^{-\frac{t - t_i}{2GM}}$$

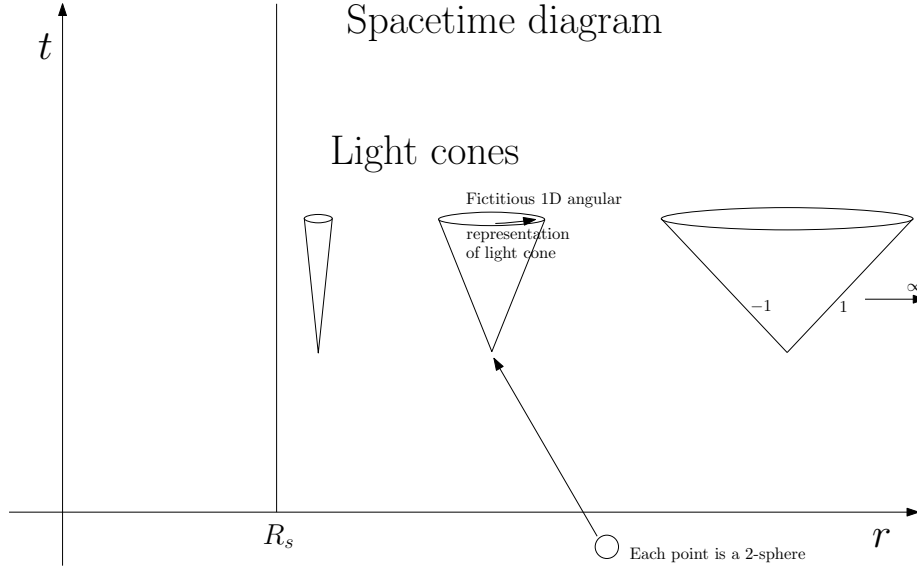

Figure 1.4.1: Schwarzschild radial spacetime diagram

Infinite time t to get to Schwarzschild radius while

$$\begin{aligned} \Delta T_{i \rightarrow Sch.} &= \int_{r_i}^{2GM} dT = \int_{r_i}^{2GM} \sqrt{\frac{r}{2GM}} \left(\frac{2GM}{r} - 1 \right) \frac{dr}{1 - \frac{2GM}{r}} \\ &= - \int_{r_i}^{2GM} \sqrt{\frac{r}{2GM}} dr = \frac{2}{3} \frac{r_i^{3/2} - (2GM)^{3/2}}{\sqrt{2GM}} < \infty \end{aligned}$$

Samely

$$\Delta T_{Sch. \rightarrow 0} = \int_{2GM}^0 dT = \frac{4}{3} GM.$$

1.4 Eddington-Filkenstein metric

1.4.1 Singularity of Schwarzschild

The Sch. metric admits 2 coordinate singularities at $r = 0$ (term $\frac{R_s}{r}$) and $r = 2GM$ (g_{rr} term).

Computing the scalar

$$R_{abcd}R^{abcd} = \frac{48G^2M^2}{r^6},$$

we see 0 is probably a true singularity.

$2GM$ may be a mere coordinate singularity

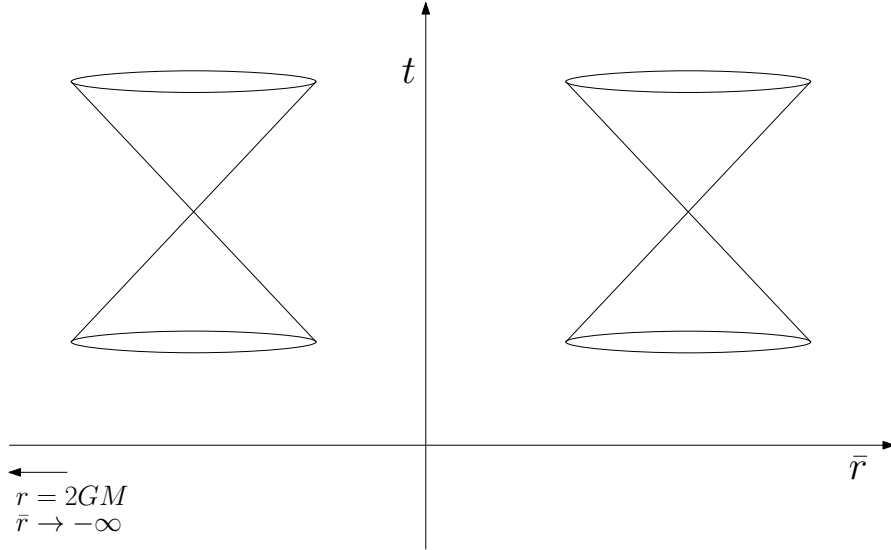

Figure 1.4.2: Outer tortoise coordinates spacetime diagram

1.4.2 Light curves in Schwarzschild

We look at light curves crossing $r = 2GM$ or not.

From metric, radial null curves $d\Omega = 0 = ds^2$

$$\begin{aligned}
 ds^2 = 0 &= - \left(1 - \frac{2GM}{r}\right) dt^2 + \left(1 - \frac{2GM}{r}\right)^{-1} dr^2 \\
 \Rightarrow \frac{dr}{dt} &= \pm \left(1 - \frac{2GM}{r}\right) \begin{cases} \xrightarrow{r \rightarrow R_s} 0 \\ \xrightarrow{r \rightarrow \infty} \pm 1 \end{cases} \\
 \text{or } \frac{dt}{dr} &= \pm \left(1 - \frac{2GM}{r}\right)^{-1} \begin{cases} \xrightarrow{r \rightarrow R_s^+} \pm\infty \\ \xrightarrow{r \rightarrow \infty} \pm 1 \end{cases}
 \end{aligned}$$

thus light cone aperture $\rightarrow 0$

1.4.3 Tortoise coordinates

Solve $\frac{dt}{dr}$ to get new radial coordinates with constant light cone

$$t = \pm \bar{r} + cst.$$

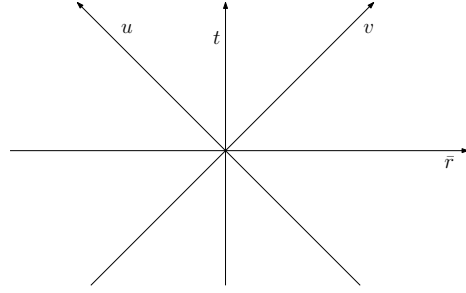

Figure 1.4.3: Tortoise null coordinates

$$\begin{aligned}
 \Rightarrow dt &= \pm \frac{dr}{1 - \frac{2GM}{r}} = \pm \frac{rdr}{r - 2GM} = \pm \left(dr + \frac{2GMdr}{r - 2GM} \right) \\
 &= \left\{ \begin{array}{l} \pm \left(dr + 2GM d \ln \left(\frac{r}{2GM} - 1 \right) \right), \quad r > 2GM \\ \pm \left(dr + 2GM d \ln \left(1 - \frac{r}{2GM} \right) \right), \quad r < 2GM \end{array} \right\} \\
 \Rightarrow \bar{r} &= r + 2GM \ln \left(\frac{r}{2GM} - 1 \right), \quad r > 2GM
 \end{aligned}$$

Metric becomes

$$ds^2 = - \left(1 - \frac{2GM}{r} \right) (-dt^2 + d\bar{r}^2) + r^2 d\Omega^2$$

Light cones constant but $r = 2GM$ corresponds to $\bar{r} \rightarrow -\infty$.

1.4.4 Eddington-Finkelstein coordinates

Natural null coordinates: along tortoise light cones:

$$\begin{array}{ll}
 v = t + \bar{r}, & \text{ingoing curves: } v = cst, \\
 u = t - \bar{r}, & \text{outgoing curves: } u = cst.
 \end{array}$$

Interested in ingoing light curves: choose v and r . Metric becomes Eddington-Finkelstein: (exercise: find E.F. from S.)

$$ds^2 = - \left(1 - \frac{2GM}{r} \right) dv^2 + 2dvdr + r^2 d\Omega^2.$$

At $r = 2GM$, $\det g = -r^4 \sin^2 \theta \neq 0$ so g invertible and R_s not singular.

Null curves (radial)

$$\begin{aligned}
 ds^2 = 0 &= - \left(1 - \frac{2GM}{r} \right) dv^2 + 2dvdr \\
 \Rightarrow \left\{ \begin{array}{ll} \frac{dv}{dr} = 0 & : \text{ingoing} \\ \frac{dv}{dr} = \frac{2}{1 - \frac{2GM}{r}} & : \text{outgoing} \end{array} \right. & \xrightarrow{r \rightarrow 2GM} \infty
 \end{aligned}$$

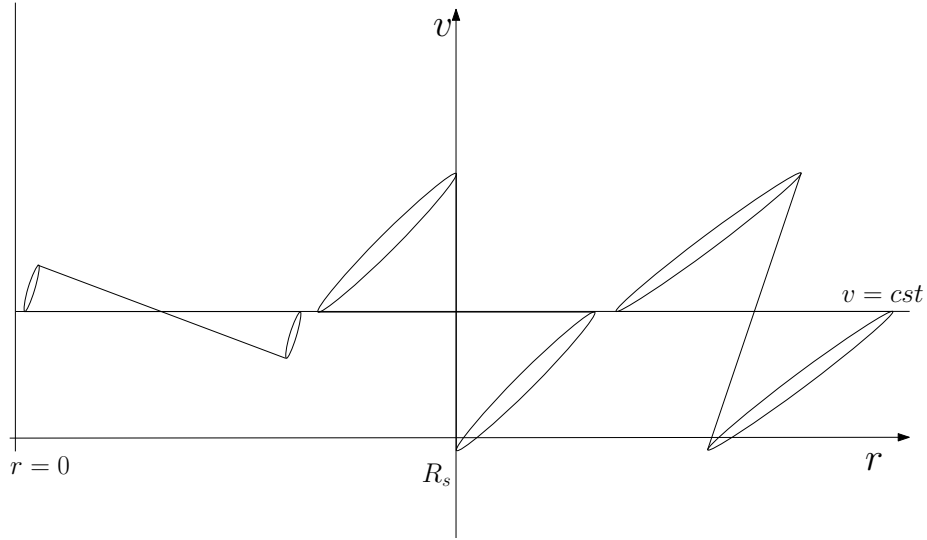

Figure 1.4.4: Eddington-Finkelstein light cones

so outgoing l.c. becomes ingoing too at R_s :
 Event horizon: particle cannot go to bigger r

1.5 Kruskal metric

In E.F., $v = cst$ and $r \searrow R_s^+ \Rightarrow t \rightarrow +\infty$ ($v = t + \bar{r}$)
 $\downarrow R_s$
 $-\infty$

If u is chosen, we get a symmetric picture but $u = cst$ and $r \searrow R_s^+ \Rightarrow t \rightarrow -\infty$ ($u = t - \bar{r}$) (exercise: find this version)
 $\downarrow R_s$
 $-\infty$

$$ds^2 = - \left(1 - \frac{2GM}{r} \right) du^2 - 2dudr + r^2 d\Omega^2.$$

To cover all light curves, use u and v . However r spatial localisation implicit

$$\left. \begin{aligned} dv &= dt + d\bar{r} \\ du &= dt - d\bar{r} \end{aligned} \right\} \Rightarrow -dt^2 + d\bar{r}^2 = -dudv$$

so

$$ds^2 = - \left(1 - \frac{2GM}{r} \right) dudv + r^2 d\Omega^2$$

but

$$\frac{1}{2}(v - u) = \bar{r} = r + 2GM \ln \left(\frac{r}{2GM} - 1 \right) \xrightarrow{r \rightarrow 2GM} -\infty$$

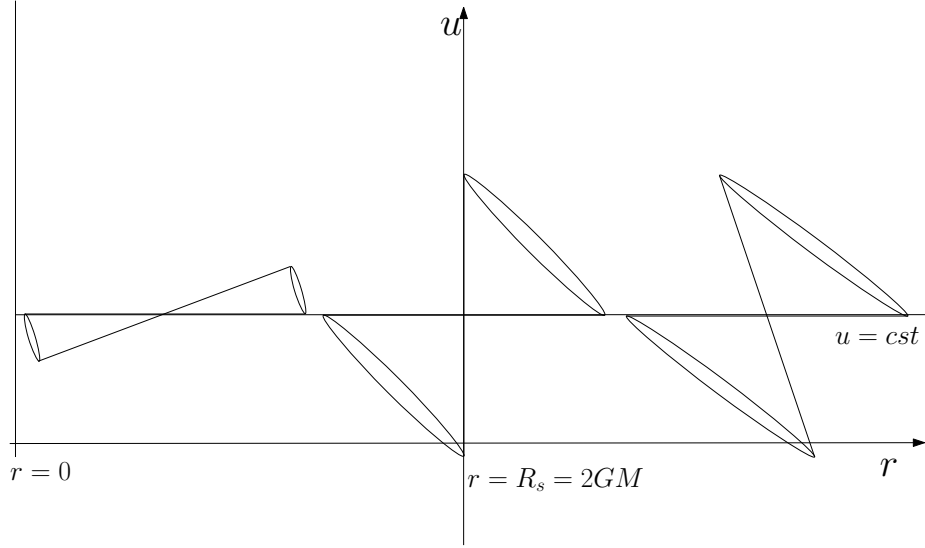

Figure 1.5.1: Eddington-Finkelstein past light cones

so $u \rightarrow +\infty$ or $v \rightarrow -\infty$

We need to compactify the null directions. Tortoise radius in null coordinates yields

$$1 - \frac{2GM}{r} = \frac{2GM}{r} \left(\frac{r}{2GM} - 1 \right) = \frac{2GM}{r} e^{-\frac{r}{2GM}} e^{\frac{v-u}{4GM}} \epsilon_s,$$

so

$$-\left(1 - \frac{2GM}{r}\right) dudv = -\frac{2GM}{r} e^{-\frac{r}{2GM}} \epsilon_s e^{-\frac{u}{4GM}} du e^{\frac{v}{4GM}} dv,$$

from which we can extract

$$e^{-\frac{u}{4GM}} du = 4GM \epsilon_U dU$$

$$e^{\frac{v}{4GM}} dv = 4GM \epsilon_V dV$$

\Rightarrow

$$U = -\epsilon_U e^{-\frac{u}{4GM}} \xrightarrow{u \rightarrow \infty} 0$$

$$V = \epsilon_V e^{\frac{v}{4GM}} \xrightarrow{v \rightarrow -\infty} 0$$

($r \rightarrow R_s$), also given in Schwarzschild coordinates by

$$V = \sqrt{\epsilon_s \left(\frac{r}{2GM} - 1 \right)} \epsilon_V e^{\frac{r+t}{4GM}}$$

$$U = -\sqrt{\epsilon_s \left(\frac{r}{2GM} - 1 \right)} \epsilon_U e^{\frac{r-t}{4GM}}$$

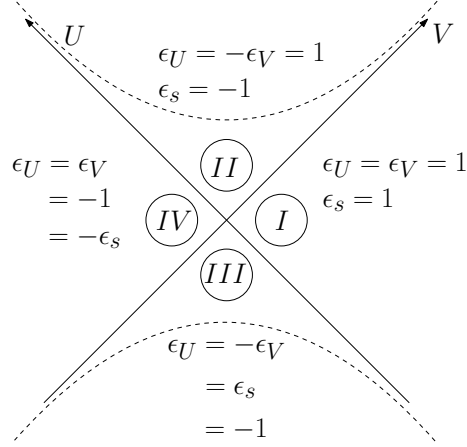

Figure 1.5.2: Compact null coordinates sign chart. The $U - V$ plane is divided into four sections numbered I-IV.

(exercise: from tortoise) and the metric reads (Fig. 1.5.2 $\Rightarrow \epsilon_s = \epsilon_U \epsilon_V$)

$$ds^2 = -\frac{1}{2} \frac{(4GM)^3}{r} e^{-\frac{r}{2GM}} dU dV + r^2 d\Omega^2$$

Go from dual null (U, V, θ, φ) system to (T, R, θ, φ) :

Define

$$\begin{aligned} T &= \frac{1}{2}(U + V) = \sqrt{\epsilon_s \frac{r}{2GM} - 1} e^{\frac{r}{4GM}} \epsilon_V \left[\frac{1 + \epsilon_s}{2} \sinh \frac{t}{4GM} + \frac{1 - \epsilon_s}{2} \cosh \frac{t}{4GM} \right] \\ R &= \frac{1}{2}(V - U) = \sqrt{\epsilon_s \frac{r}{2GM} - 1} e^{\frac{r}{4GM}} \epsilon_V \left[\frac{1 + \epsilon_s}{2} \cosh \frac{t}{4GM} + \frac{1 - \epsilon_s}{2} \sinh \frac{t}{4GM} \right] \\ &\Leftrightarrow \begin{cases} U = T - R \\ V = T + R \end{cases} \end{aligned}$$

Kruskal

Since

$$dT^2 - dR^2 = \frac{1}{4} [dU^2 + dV^2 + 2dU dV - dU^2 - dV^2 + 2dU dV] = dU dV$$

we have the Kruskal metric

$$ds^2 = \frac{32(GM)^3}{r} e^{-\frac{r}{2GM}} (-dT^2 + dR^2) + r^2 d\Omega^2,$$

defining r implicitly from

$$T^2 - R^2 = UV = \left(1 - \frac{r}{2GM}\right) e^{\frac{r}{2GM}}. \quad (1.1)$$

Radial null curves: $u = cst$ or $v = cst \Leftrightarrow U = cst$ or $V = cst \Leftrightarrow T = R + cst$ or $T = -R + cst$

but event horizon $r = 2GM \Rightarrow T^2 = R^2$ so is at $T = \pm R$ which is a null surface!

Constant r surfaces are given by $T^2 - R^2 = cst$: hyperbolae of $T - R$ plane

Constant t surfaces in (I) are given by $\frac{T}{R} = \tanh \frac{t}{4GM} = cst$: lines $T = (\tanh \frac{t}{4GM}) R$. Slope $\tanh \frac{t}{4GM} \xrightarrow{t \rightarrow \pm\infty} \pm 1$ so $t \rightarrow \pm\infty \Leftrightarrow r = 2GM$

T, R range avoids $r = 0 : T^2 - R^2 = 1$

so $T^2 - R^2 - 1 < 0 \Leftrightarrow T^2 < R^2 + 1, R \in \mathbb{R}$

We can now draw a spacetime diagram in the $T - R$ plane (Fig. 1.5.3)

Each point on the diagram is a 2-sphere:

Maximal extension of the Schwarzschild geometry, coords cover the entire solution manifold

divide diagram in 4 regions:

(I): $r > 2GM$, original coords well defined: outer Schwarzschild

(II): inside horizon: BH

Lightcones become spacelike and all end on $r = 0$ singularity

For (II): same procedure gives

$$ds^2 = -\frac{32(GM)^3}{r} e^{-\frac{r}{2GM}} (dT^2 - dR^2) + r^2 d\Omega^2,$$

$$T^2 - R^2 = \left(\frac{r}{2GM} - 1\right) e^{\frac{r}{2GM}}.$$

(exercise: show from tortoise procedure)

R :	spacelike	\neq from Schw.:	t :	spacelike
T :	timelike		r :	timelike

$r = 0$ singularity is spacelike

(III): time reverse of (II): white hole

(IV): mirror image of (I): other side of wormhole (Einstein-Rosen bridge)

instantaneously closed (no timelike curve across)

Spacetime slices: Fig. 1.5.4

Compactify Kruskal diagram for better analysis

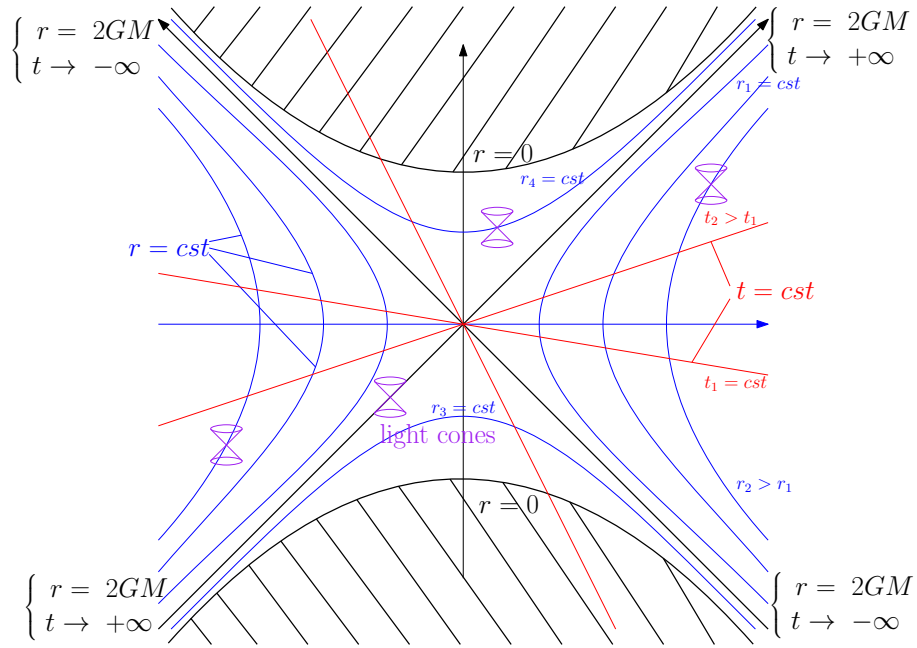

Figure 1.5.3: Kruskal spacetime diagram

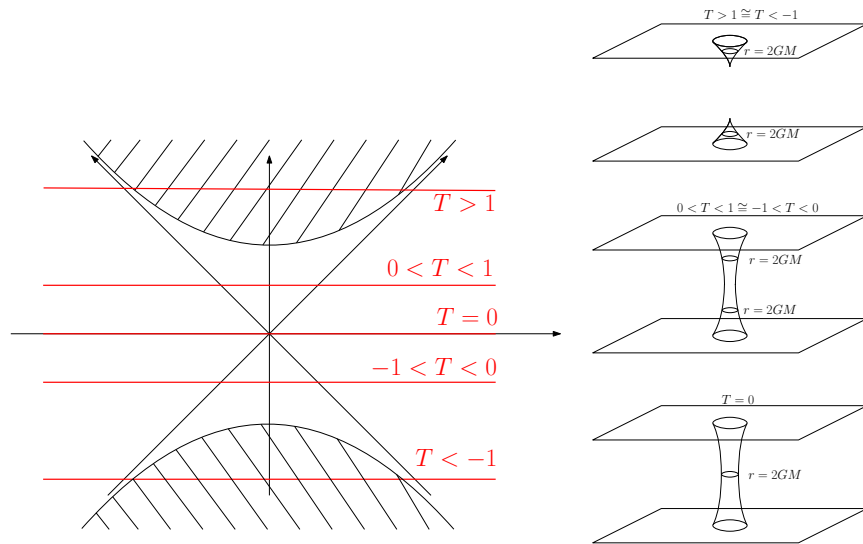

Figure 1.5.4: Kruskal Time slices structure

Chapter 2

Conformal, Carter-Penrose, diagrams

Represent symmetric spacetime in a compact way to explore global and causal structure \Rightarrow keep lightcones evidents.

- Symmetry \longrightarrow ignore angular part: 1D time T , 1D space R
- Causal structure \longrightarrow light cones keep at $dT = \pm dR$ $\begin{cases} r = 2GM \\ t \rightarrow +\infty \end{cases}$

2.1 Conformal transformation

$$\tilde{g}_{ab} = \omega^2(x) g_{ab} \quad \Leftrightarrow \quad d\tilde{s}^2 = \omega^2(x) ds^2$$

$x^a(\lambda)$ null curve $\Rightarrow g_{ab} \frac{dx^a}{d\lambda} \frac{dx^b}{d\lambda} = 0$ tangent vector: null

$\Rightarrow \tilde{g}_{ab} \frac{dx^a}{d\lambda} \frac{dx^b}{d\lambda} = \omega^2 g_{ab} \frac{dx^a}{d\lambda} \frac{dx^b}{d\lambda} = 0$: conformal transformation keeps light curves invariant

2.2 Minkowski metric

In spherical coordinates

$$ds_M^2 = -dt^2 + dr^2 + r^2 d\Omega^2,$$

$d\Omega^2 = d\theta^2 + \sin^2 \theta d\varphi^2$ metric on unit 2-sphere

Radial light cones already at 45°: $dt^2 = dr^2$

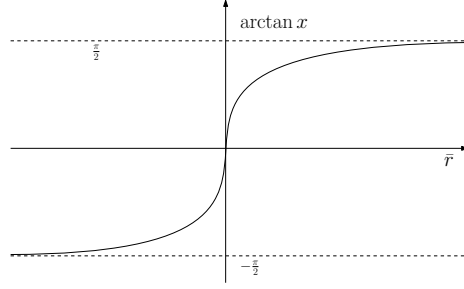
 Figure 2.2.1: Example of compactification function: $\arctan x$

2.2.1 Compactify (t, r)

$$\begin{aligned} t \in \mathbb{R} & \quad \text{Try } \bar{t} = \arctan t \\ r \in \mathbb{R}^+ & \quad \bar{r} = \arctan r \end{aligned}$$

$$\text{Since } d \tan x = \frac{dx}{\cos^2 x},$$

$$d\bar{s}^2 = -\frac{1}{\cos^2 \bar{t}} d\bar{t}^2 + \frac{d\bar{r}^2}{\cos^2 \bar{r}} + \tan^2 \bar{r} d\Omega^2$$

$$\begin{aligned} \bar{t} \in & \left] -\frac{\pi}{2}; \frac{\pi}{2} \right[\quad \text{but } \frac{d\bar{t}}{d\bar{r}} = \pm \frac{\cos^2 \bar{t}}{\cos^2 \bar{r}} \neq \pm 1 \text{ causality spacetime dependent.} \\ \bar{r} \in & \left[0; \frac{\pi}{2} \right[\end{aligned}$$

2.2.2 Compactify null coordinates

Since we want to keep $dt^2 = dr^2$ for null curves, use null coordinates, constant on null curves:

$$\begin{aligned} u = t - r & & u \leq v & & \Leftrightarrow r = \frac{1}{2}(v - u) \geq 0 \\ v = t + r & & u, v \in \mathbb{R} & & t = \frac{1}{2}(v + u) \end{aligned}$$

metric becomes

$$ds^2 = -dudv + \frac{1}{4}(v - u)^2 d\Omega^2,$$

(exercise: proof) then compactify with $\arctan x$

$$\begin{aligned} U = \arctan u & & U \leq V \\ V = \arctan v & & U, V \in \left] -\frac{\pi}{2}; \frac{\pi}{2} \right[\\ \Rightarrow dudv = \frac{dU dV}{\cos^2 U \cos^2 V} & \quad \text{and } (v - u)^2 = (\tan V - \tan U)^2 \\ & & = \frac{1}{\cos^2 U \cos^2 V} (\sin V \cos U - \sin U \cos V)^2 \\ & & = \frac{\sin^2(V - U)}{\cos^2 U \cos^2 V} \end{aligned}$$

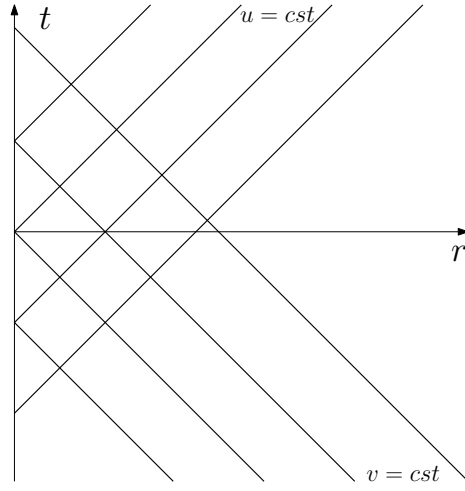

Figure 2.2.2: Spherical Minkowski null curves

metric becomes now

$$ds^2 = \frac{1}{4 \cos^2 U \cos^2 V} [-4dUdV + \sin^2(V - U) d\Omega^2]$$

Return to non-null coords.

$$\begin{aligned} T &= V + U & |T| + R &< \pi \\ R &= V - U & R &\in [0; \pi[\end{aligned}$$

so¹

$$\begin{aligned} ds^2 &= \omega^{-2}(T, R) [-dT^2 + dR^2 + \sin^2 R d\Omega^2] \\ \omega &= 2 \cos U \cos V \\ &= 2 \cos \left[\frac{1}{2}(T - R) \right] \cos \left[\frac{1}{2}(T + R) \right] \\ &= \cos T + \cos R. \end{aligned}$$

¹since

$$\begin{aligned} \cos(a + b) &= \cos a \cos b - \sin a \sin b \\ \text{so } \cos(a - b) \cos(a - b) &= \cos^2 a \cos^2 b - \sin^2 a \sin^2 b \\ &= (\cos^2 a - \sin^2 a) \cos^2 b + (\cos^2 a - \sin^2 a) \sin^2 b \\ &\quad + \sin^2 a (\cos^2 b - \sin^2 b) + \cos^2 a (\cos^2 b - \sin^2 b) \\ &\quad + \sin^2 a \sin^2 b - \cos^2 a \cos^2 b \\ &= \cos 2a (\cos^2 b + \sin^2 b) + (\cos^2 a + \sin^2 a) \cos 2b \\ &\quad - \cos(a - b) \cos(a - b) \\ \Leftrightarrow 2 \cos(a - b) \cos(a - b) &= \cos 2a + \cos 2b. \end{aligned}$$

Thus Minkowski is conformally transformed into a compact metric

$$d\tilde{s}^2 = \omega^2(T, R) ds^2 = -dT^2 + dR^2 + \sin^2 R d\Omega^2$$

describing $\mathbb{R} \times S^3$ with curvature

$$\begin{aligned} \tilde{r} &= \sin R & \Leftrightarrow d\tilde{r} &= \cos R dR \\ & & \Leftrightarrow \frac{d\tilde{r}^2}{1 - \tilde{r}^2} &= dR^2, \end{aligned}$$

so

$$d\tilde{s}^2 = -dT^2 + \frac{d\tilde{r}^2}{1 - \tilde{r}^2} + \tilde{r}^2 d\Omega^2$$

R.W. with positive curvature: Einstein static universe (perfect fluid + cosmological constant)

Representing $\mathbb{R} \times S^3$ as a cylinder, Minkowski is restricted by $|T| + R < \pi$ and $R > 0$

Circles are constant T slices 3-spheres

Unfolding Minkowski gives a triangle which is the conformal compactification of Minkowski:

Minkowski + boundary: conformal infinity

$$\begin{aligned} i^+ &= \text{future timelike infinity } (T = \pi \Rightarrow R = 0) \\ i^0 &= \text{spatial infinity } (T = 0 \Rightarrow R = \pi) \\ i^- &= \text{past timelike infinity } (T = -\pi \Rightarrow R = 0) \\ \mathcal{I}^+ &= \text{future null infinity surface } (T = \pi - R, 0 < R < \pi) \\ &\quad \text{pronounced "scri plus", } \text{\LaTeX \mathscr{I}^+} : \mathcal{I}^+ \\ &\quad \text{or } \text{\LaTeX \mathcal{I}^+} : \mathcal{I}^+ \\ \mathcal{I}^- &= \text{past null infinity surface } (T = R - \pi, 0 < R < \pi) \end{aligned}$$

Properties:

- Lightcones at 45° (radial null geodesics at $\pm 45^\circ$)
- All timelike curves (geodesics) start at i^- and end at i^+
- All null geodesics begin on \mathcal{I}^- and end on \mathcal{I}^+
(reflection across $R = 0$: $T = -R + c$ becomes $T = R + c$)
- All spacelike geodesics begin and end at i^0 (reflection)

Asymptotically flat spacetimes will conserve the \mathcal{I}^+ , i^0 , \mathcal{I}^- structure (e.g. Black Holes)

2.3 Non-Trivial example: Power law, flat Robertson-Walker metric

$$ds^2 = -dt^2 + t^{2q} (dr^2 + r^2 d\Omega^2)$$

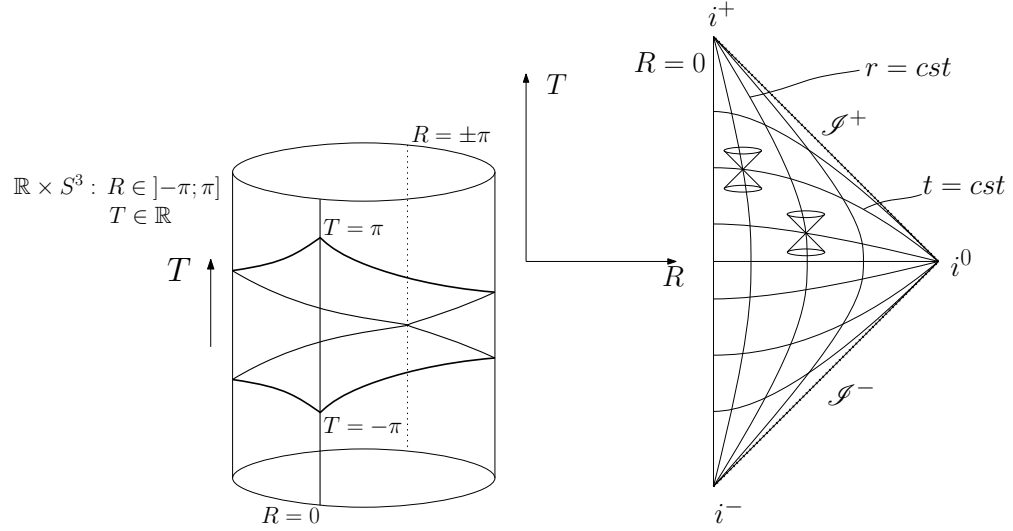

Figure 2.2.3: Left: 4-cylinder Minkowski representation; right: Penrose diagram for Minkowski space.

where scale factor $a = t^q$, $0 < q < 1$.

Singular at $t = 0$ so

$$\begin{aligned} t &\in \mathbb{R}^{*+} \\ r &\in \mathbb{R}^+ \end{aligned}$$

First introduce conformal time so metric appears conformally flat

$$dt^2 = t^{2q} d\eta \quad \Rightarrow \quad \frac{dt}{t^q} = d\eta \quad \Rightarrow \quad \eta = \frac{t^{1-q}}{1-q} \quad \text{or } t = [(1-q)\eta]^{\frac{1}{1-q}}$$

then

$$ds^2 = t^{2q} (-d\eta^2 + dr^2 + r^2 d\Omega^2) = [(1-q)\eta]^{\frac{2q}{1-q}} (-d\eta^2 + dr^2 + r^2 d\Omega^2)$$

Remark η is time coord.: $\eta \in \mathbb{R}^{*+}$

$$g_{ab} \partial_\eta^a \partial_\eta^b < 0.$$

Comoving clock $x^a(\lambda) = (\eta(\lambda) \quad \vec{0})$ proper time: $\tau \propto t \propto \eta^{\frac{1}{1-q}}$ difference between observables and coords!

Use the same procedure than Minkowski to compactify the lightlike direc-

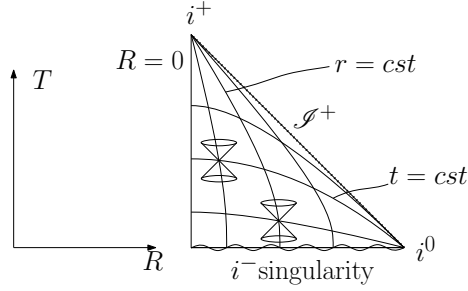

Figure 2.3.1: Penrose diagram for power law, flat, FLRW

tions and keep light cones invariants

$$\begin{aligned}
 u &= \eta - r & \Leftrightarrow & \quad r = \frac{1}{2}(v - u) \geq 0 \Rightarrow u \leq v, u, v \in \mathbb{R} \\
 v &= \eta + r & & \quad \eta = \frac{1}{2}(v + u) > 0 \Rightarrow u > -v \\
 U &= \arctan u & U &\leq V \\
 V &= \arctan v & U &> -V \quad U, V \in \left] -\frac{\pi}{2}; \frac{\pi}{2} \right[\\
 T &= V + U > 0 & R &\in [0; \pi[\\
 R &= V - U \geq 0 & T + R &< \pi
 \end{aligned}$$

and the metric turns to (exercise: calculate ω)

$$ds^2 = \omega^{-2}(T, R) [-dT^2 + dR^2 + \sin^2 R d\Omega^2]$$

(conformal factor times Einstein static universe) where trigonometry reveals

$$\omega(T, R) = \left(\frac{\cos T + \cos R}{(1 - q) \sin T} \right)^{\frac{q}{1-q}} (\cos T + \cos R)$$

so the Penrose diagram reads (Fig 2.3.1)

Same as upper half of Minkowski but with initial past singularity.

It shows how past light cones may never intersect while future light cones always do (horizon problem of cosmology)

2.4 Case of Schwarzschild

To avoid the coordinate singularity of the horizon we start from the null version of Kruskal coordinates and compactify in the same manner as Minkowski

$$ds^2 = -\frac{32(GM)^3}{r} e^{-\frac{r}{2GM}} dU dV + r^2 d\Omega^2, \quad U = -\epsilon_U \sqrt{\left| \frac{r}{2GM} - 1 \right|} e^{\frac{r}{4GM}} e^{-\frac{t}{4GM}} = -\epsilon_U e^{-\frac{u}{4GM}}$$

$$\text{with } UV = \left(\frac{r}{2GM} - 1 \right) e^{\frac{r}{2GM}}, \quad V = \epsilon_V \sqrt{\left| \frac{r}{2GM} - 1 \right|} e^{\frac{r}{4GM}} e^{\frac{t}{4GM}} = \epsilon_V e^{\frac{v}{4GM}}$$

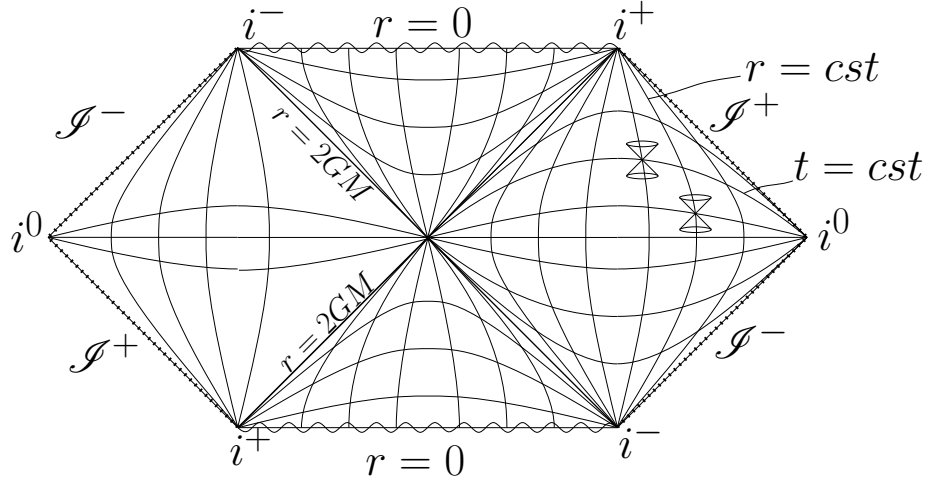

Figure 2.4.1: Penrose diagram for the solution

with
$$\begin{aligned} U_1 &= \arctan U & \text{and} & & T_1 &= V_1 + U_1 \\ V_1 &= \arctan V & & & R_1 &= V_1 - U_1 \end{aligned}$$

$$\begin{aligned} ds^2 &= -\frac{32(GM)^3}{r \cos^2 U_1 \cos^2 V_1} e^{-\frac{r}{2GM}} dU_1 dV_1 + r^2 d\Omega^2 \\ &= -\frac{8(GM)^3 e^{-\frac{r}{2GM}}}{r \cos^2 U_1 \cos^2 V_1} (dT_1^2 - dR_1^2) + r^2 d\Omega^2. \end{aligned}$$

Since $\tan(a+b) = \frac{\tan a + \tan b}{1 - \tan a \tan b}$, then
$$\begin{aligned} T_1 &= \arctan \left(\frac{U+V}{1-UV} \right) \\ R_1 &= \arctan \left(\frac{V-U}{1+UV} \right) \end{aligned}$$

Like for Minkowski, spatial infinity resides at $(\epsilon_U = \epsilon_V)$

$$\left. \begin{aligned} U_1 &\xrightarrow{r \rightarrow \infty} -\epsilon_U \frac{\pi}{2} \\ V_1 &\xrightarrow{r \rightarrow \infty} \epsilon_V \frac{\pi}{2} \end{aligned} \right\} \Leftrightarrow \left\{ \begin{aligned} T_1 &\xrightarrow{r \rightarrow \infty} \epsilon_V \frac{\pi}{2} (1-1) = 0 \\ R_1 &\xrightarrow{r \rightarrow \infty} \epsilon_V \frac{\pi}{2} (1+1) = \epsilon_V \pi \end{aligned} \right.$$

time infinities stand at

$$\left. \begin{aligned} U_1 &\xrightarrow{t \rightarrow \infty} 0 \\ V_1 &\xrightarrow{t \rightarrow \infty} \epsilon_V \frac{\pi}{2} \end{aligned} \right\} \Leftrightarrow \left\{ \begin{aligned} T_1 &\xrightarrow{t \rightarrow \infty} \epsilon_V \frac{\pi}{2} \\ R_1 &\xrightarrow{t \rightarrow \infty} \epsilon_V \frac{\pi}{2} \end{aligned} \right.$$

$$\left. \begin{aligned} U_1 &\xrightarrow{t \rightarrow -\infty} -\epsilon_U \frac{\pi}{2} \\ V_1 &\xrightarrow{t \rightarrow -\infty} 0 \end{aligned} \right\} \Leftrightarrow \left\{ \begin{aligned} T_1 &\xrightarrow{t \rightarrow -\infty} -\epsilon_U \frac{\pi}{2} \\ R_1 &\xrightarrow{t \rightarrow -\infty} \epsilon_U \frac{\pi}{2} \end{aligned} \right.$$

null infinities are

$$\begin{array}{rcl}
 U_1 \xrightarrow{u \rightarrow \infty} & 0, & \\
 U_1 \xrightarrow{u \rightarrow -\infty} & -\epsilon_U \frac{\pi}{2}, & V_1 \text{ unchanged} \\
 V_1 \xrightarrow{v \rightarrow \infty} & \epsilon_V \frac{\pi}{2}, & U_1 \text{ unchanged} \\
 V_1 \xrightarrow{v \rightarrow -\infty} & 0, &
 \end{array}$$

the central singularity yields

$$\begin{array}{rcl}
 UV \xrightarrow{r \rightarrow 0} & 1 & T_1 \xrightarrow{r \rightarrow 0} \epsilon_V \frac{\pi}{2} \\
 (\epsilon_U = \epsilon_V) & R_1(r=0) = & \arctan [R(r=0)]
 \end{array}$$

We thus can build the Carter-Penrose diagram

Asymptotic flatness causes the infinities to match Minkowski

Chapter 3

Birkhoff Theorem

[Birkhoff and Langer(1923)]

Often misunderstood as relativistic version of Newton's "iron spheres" theorem, it is different in scope and hypotheses.

3.1 Current general form

Most evolved current phrasing by Bona [Bona(1988)] for conformally reducible direct products of spacetime:

$$\begin{cases} \hat{g} = Y^2 g \\ ds^2 = g_{ab} dx^a dx^b = \gamma_{AB} dx^A dx^B + h_{\alpha\beta} dy^\alpha dy^\beta \end{cases}$$

where $h_{\alpha\beta}$ and y^α are metric and coords. on 2D orbits O_2 of G_3 , a group of motion, and γ_{AB} , x^A are metric and coords. on V_2 , orthogonal submanifold to O_2 from g

Theorem 3.1. *Metric with a group G_3 of motion on non-null orbits O_2 and with Ricci tensors of the type $[(1 \ 1) (1 \ , 1)]$ and $[(1 \ 1 \ 1 \ , 1)]$ admit a group G_4 provided that $d_a Y \neq 0$.*

3.2 Spherical case and classic form

The original version states, more transparently, that

Theorem 3.2. *Any vacuum, spherically symmetric solution of E.F.E. is also static, and Schwarzschild is its unique form.*

Physically, it implies that radial pulsations of a spherical star cannot propagate gravitational radiations. Conversely, GW require at minimum quadrupolar variations.

The proof involves linking spherical symmetry with foliation of spacetime, then the form of the metric to plug in EFE.

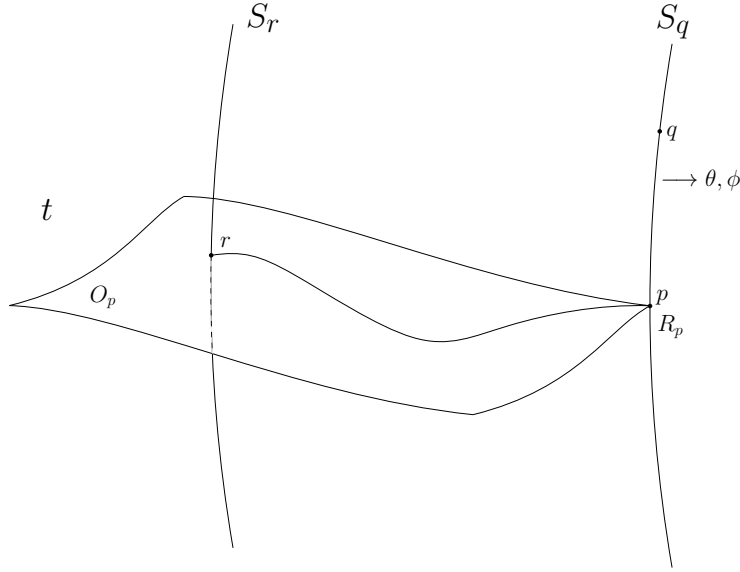

Figure 3.2.1: Foliation of spherically symmetric spacetime

3.2.1 Preliminary: Killing equation

Killing vector: Symmetry yields invariant motion in direction K^a . Observer: u^a timelike vector
 then $K^a u_a$ along u^a is unchanged: u^a motion along K^a is invariant: $\frac{du^a K_a}{d\tau} = 0 = \frac{du^{(K)}}{d\tau} \Leftrightarrow u^a \nabla_a (K^b u_b) = 0 = u^a u^b \nabla_{(a} K_{b)}$
 $\nabla_{(a} K_{b)} = 0$ Killing equation: Definition

3.2.2 Proof of the classic form

3.2.2.1 General form of the metric

Proof. Spherical symmetry is the symmetry of the sphere S_2 , that is the rotation group of \mathbb{R}^3 : $SO(3)$, which generators follow the algebra (Killing vectors)

$$\begin{aligned} [R, S] &= T, \\ [S, T] &= R, \\ [T, R] &= S. \end{aligned}$$

From Frobenius theorem, since the $SO(3)$ Killing vector set closes, then their integral curves cover the submanifold S_2 , and thus S_2 foliates spherically symmetric spacetimes.

The set of all spheres is 2 dimensional since S_2 is 2D, in 4D, thus we can chose (a, b, θ, ϕ) on M, a, b labels each sphere.

For any p on S_q

Invariant under R_p, O_p its orthogonal space, any r on O_p is also invariant and define S_r (as R_p isometry and $O_p \perp S_q$). $S_r \perp O_p$ as R_p leaves also S_r invariant and tangent space to S_r is orthogonal to O_p .

The geodesic linking p and r maps θ, ϕ onto neighbouring spheres, thus they are global coords. Its tangent vector's components along a chosen basis yields (a, b) . Since we decomposed M into S_q and O_p for any q, p , their coordstangent vectors will be orthogonal between (a, b) and (θ, ϕ) , hence no cross terms in the metric which should sport the form

$$ds^2 = g_{aa}(a, b) da^2 + g_{ab}(a, b) (da db + db da) + g_{bb}(a, b) db^2 + r^2(a, b) d\Omega^2,$$

where $d\Omega^2 = d\theta^2 + \sin^2 \theta d\phi^2$ is the metric on S_2 .

We can always choose, if $r(a, b) \rightarrow b(a, r)$ invertible (otherwise choose $r(a, b) \rightarrow a(r, b)$ and relabel $b \rightarrow a$), so

$$ds^2 = g_{aa}(a, r) da^2 + g_{ar}(a, r) (da dr + dr da) + g_{rr}(a, r) dr^2 + r^2 d\Omega^2.$$

Then we choose $t(a, r)$ such as to eliminate the cross terms: $dt = \partial_a t da + \partial_r t dr$ so

$$dt^2 = (\partial_a t)^2 da^2 + \partial_a t \partial_r t (da dr + dr da) + (\partial_r t)^2 dr^2,$$

which yields that to obtain $m dt^2 + n dr^2$ in ds^2 , we need

$$m (\partial_a t)^2 = g_{aa}, \quad n + m (\partial_r t)^2 = g_{rr}, \quad m \partial_a t \partial_r t = g_{ar}$$

which is a system of 3 eqs. for 3 unknowns $t(a, r), m(a, r)$ and $n(a, r)$, completely determined up to initial conditions.

The metric of spherically symmetric M in general writes

$$ds^2 = m(t, r) dt^2 + n(t, r) dr^2 + r^2 d\Omega^2.$$

If we choose t to be timelike and r spacelike, given our Minkowskian signature $- + + +$, yields

$$ds^2 = -e^{2\alpha(t, r)} dt^2 + e^{2\beta(t, r)} dr^2 + r^2 d\Omega^2.$$

□

3.2.2.2 EFE and final proof of the theorem

Proof. Next we need the EFE for vacuum. Note the metric here is time dependent!! but compare with the static form.

Christoffel symbol/connection reads ($\partial_t = \dot{}, \partial_r = '$)

$$\begin{aligned} \Gamma_{00}^0 &= \dot{\alpha}, & \Gamma_{01}^0 &= \alpha', & \Gamma_{11}^0 &= e^{2(\alpha-\beta)} \dot{\beta}, \\ \Gamma_{00}^1 &= e^{2(\alpha-\beta)} \alpha', & \Gamma_{01}^1 &= \dot{\beta}, & \Gamma_{11}^1 &= \beta', \\ \Gamma_{12}^2 &= \frac{1}{r}, & \Gamma_{22}^1 &= -r e^{-2\beta}, & \Gamma_{13}^3 &= \frac{1}{r}, \\ \Gamma_{33}^1 &= -r e^{-2\beta} \sin^2 \theta, & \Gamma_{33}^2 &= -\sin \theta \cos \theta, & \Gamma_{23}^3 &= \cot \theta, \end{aligned}$$

rest are 0 or symmetric.

Riemann then corresponds to

$$\begin{aligned} R_{101}^0 &= e^{2(\alpha-\beta)} \left[\ddot{\beta} + \dot{\beta}^2 - \dot{\alpha}\dot{\beta} \right] + \left[\alpha'\beta' - \alpha'' - (\alpha')^2 \right], \\ R_{202}^0 &= -re^{-2\beta}\alpha', & R_{303}^0 &= -re^{-2\beta}\sin^2\theta\alpha', & R_{212}^0 &= re^{-2\alpha}\dot{\beta}, \\ R_{313}^0 &= re^{-2\alpha}\sin^2\theta\dot{\beta}, & R_{212}^1 &= re^{-2\beta}\beta', & R_{313}^1 &= re^{-2\beta}\sin^2\theta\beta', \\ R_{323}^2 &= (1 - e^{-2\beta})\sin^2\theta, \end{aligned}$$

rest are 0 or symmetric.

Ricci tensor proceeds

$$\begin{aligned} R_{00} &= \left[\ddot{\beta} + \dot{\beta}^2 - \dot{\alpha}\dot{\beta} \right] + e^{2(\alpha-\beta)} \left[\alpha'' + (\alpha')^2 - \alpha'\beta' + \frac{2}{r}\alpha' \right], \\ R_{11} &= - \left[\alpha'' + (\alpha')^2 - \alpha'\beta' - \frac{2}{r}\beta' \right] + e^{2(\beta-\alpha)} \left[\ddot{\beta} + \dot{\beta}^2 - \dot{\alpha}\dot{\beta} \right], \\ R_{01} &= \frac{2}{r}\dot{\beta}, \\ R_{22} &= e^{-2\beta} [r(\beta' - \alpha') - 1] + 1, \quad R_{33} = R_{22}\sin^2\theta, \end{aligned}$$

and the EFE yield $R_{ab} = 0$ in vacuum.

From $R_{01} = 0$: $\dot{\beta} = 0$.

Taking $R_{22} = 0$ with $\dot{\beta} = 0 \Rightarrow \alpha' = 0$ thus

$$\begin{aligned} \dot{\beta} = 0 & \Rightarrow \beta = \beta(r) \\ \alpha' = 0 & \Rightarrow \alpha = f(r) + g(t) \end{aligned}$$

and time can be redefined as $-e^{2\alpha}dt^2 = -e^{2f(r)}e^{2g(t)}dt^2 = -e^{2f(r)}d\bar{t}^2$ hence $\alpha(t, r) = f(r)$ and we obtain

$$ds^2 = -e^{2\alpha(r)}dt^2 + e^{2\beta(r)}dr^2 + r^2d\Omega^2,$$

which is static. □

Chapter 4

Geodesics and congruences

“Straightest” lines followed by test particles and light, in absence of other interactions (shortest distance). It parallel transports its own tangent vector.

4.1 Geodesic equation

4.1.1 Geodesic equation from parallel transport

4.1.1.1 Recall: parallel transport

Conservation of tensors along a curve $x^a(\lambda)$

$$\left(\frac{D}{d\lambda} T\right)_{b_1 \dots b_m}^{a_1 \dots a_n} = \frac{dx^c}{d\lambda} \nabla_c T_{b_1 \dots b_m}^{a_1 \dots a_n} = 0$$

It preserves metric $\frac{D}{d\lambda} g_{ab} = \frac{dx^c}{d\lambda} \nabla_c g_{ab} = 0$
and norm (type) of vectors (so keeps time-/space-like and null)

$$\begin{aligned} \frac{D}{d\lambda} (V^a W_a) &= \frac{D}{d\lambda} (g_{ab}) V^a W^b + \frac{D}{d\lambda} (V^a) g_{ab} W^b + \frac{D}{d\lambda} (W^b) g_{ab} V^a \\ &= 0. \end{aligned}$$

For vectors it reads $\frac{dV^a}{d\lambda} + \Gamma_{bc}^a \frac{dx^b}{d\lambda} V^c = 0$

4.1.1.2 Geodesic equation

For geodesics

$$\frac{D}{d\lambda} \frac{dx^c}{d\lambda} = 0 \quad \Leftrightarrow \quad \frac{d^2 x^a}{d\lambda^2} + \Gamma_{bc}^a \frac{dx^b}{d\lambda} \frac{dx^c}{d\lambda} = 0$$

Remark 4.1. As norm preserved in parallel transport, sign is unchanged and geodesics remain of same type

4.1.2 Geodesic equation from least action principle

Distance between events:

$$d = \int ds \text{ for spacelike paths}$$

$$l = \int ds = 0 \text{ for null paths}$$

$$\tau = \int d\tau = \int \sqrt{-ds^2} \text{ proper time, for timelike curves}$$

Curves changing type have undefined length

Geodesic: extremum of distance: principle of Maupertuis (least action)

For curve $C(\lambda)$ with tangent $T^a = \frac{dx^a}{d\lambda}$, as $ds^2 = g_{ab}dx^a dx^b = g_{ab}T^a T^b d\lambda^2$,

$$d = \int_C (g_{ab}T^a T^b)^{\frac{1}{2}} d\lambda.$$

For $T^a T_a = 0$ (null)

$$l = \int (g_{ab}T^a T^b)^{\frac{1}{2}} d\lambda = 0.$$

For timelike C :

$$\begin{aligned} ds^2 &= g_{ab}T^a T^b d\lambda^2 < 0 \\ &= -d\tau^2, \end{aligned}$$

defines proper time

$$\Rightarrow \tau = \int_C (-g_{ab}T^a T^b)^{\frac{1}{2}} d\lambda$$

choose λ as τ : $T^a = u^a$ 4-vel.

$$\Rightarrow \tau = \int_C (-(-1))^{\frac{1}{2}} d\tau = \int_C d\tau$$

We can do that as length is independent of parameter λ

Proof. New parameter $\mathfrak{s}(\lambda) \Rightarrow$ new tangent $S^a = \frac{d\lambda}{d\mathfrak{s}} T^a$

$$l' = \int \sqrt{|g_{ab}S^a S^b|} d\mathfrak{s} = \int \sqrt{|g_{ab}T^a T^b|} \frac{d\lambda}{d\mathfrak{s}} d\mathfrak{s} = l$$

□

Variation of length for timelike curves yields

$$\delta\tau = \int -\frac{1}{2} \frac{\delta(g_{ab}u^a u^b)}{\sqrt{-g_{ab}u^a u^b}} d\tau = -\frac{1}{2} \int \delta(g_{ab}u^a u^b) d\tau = -\delta I$$

$$\text{with } I = \frac{1}{2} \int g_{ab}u^a u^b d\tau = \int L d\tau$$

where L is Lagrangian

Extremised variation is then given by Euler-Lagrange eq. ($u^a = \frac{dx^a}{d\tau} = \dot{x}^a$):

$$\frac{\partial L}{\partial x^a} = \frac{1}{2}g_{cb,a}u^b u^c, \quad \frac{\partial L}{\partial \dot{x}^a} = g_{ab}u^b \quad \text{so} \quad \frac{d}{d\tau} \left(\frac{\partial L}{\partial \dot{x}^a} \right) = g_{ab,c}u^b u^c + g_{ab}\dot{u}^b$$

$$g_{ab}\dot{u}^b + \left[g_{ab,c} - \frac{1}{2}g_{cb,a} \right] u^b u^c = 0$$

$$\Leftrightarrow \frac{d^2 x^a}{d\lambda^2} + \frac{g^{ad}}{2} [g_{db,c} + g_{dc,b} - g_{cb,d}] = 0,$$

where we recognise the Christoffel connection and the geodesic eq.

Theorem 4.1. *As Christoffel connection not a tensor, we can choose coords for which locally $\Gamma = 0$*

Proof. Since $\nabla_a V^b = \partial_a V^b + \Gamma_{ac}^b V^c$ tensor, so

$$\nabla_{a'} V^{b'} = \frac{\partial x^a}{\partial x^{a'}} \frac{\partial x^{b'}}{\partial x^b} \nabla_a V^b = \partial_{a'} x^a \partial_b x^{b'} \nabla_a V^b$$

and $\frac{\partial}{\partial x^{a'}} = \frac{\partial x^a}{\partial x^{a'}} \frac{\partial}{\partial x^a} = \partial_{a'} x^a \partial_a$, $V^{b'} = \partial_b x^{b'} V^b$ but

$$\begin{aligned} \nabla_{a'} V^{b'} &= \partial_{a'} V^{b'} + \Gamma_{a'c'}^{b'} V^{c'} \\ &= \partial_{a'} x^a \left(\partial_b x^{b'} \underbrace{\partial_a V^b}_{\text{tensor}} + V^b \partial_a \partial_b x^{b'} \right) + \Gamma_{a'c'}^{b'} \partial_c x^{c'} V^c \\ &= \partial_{a'} x^a \partial_b x^{b'} \left(\underbrace{\partial_a V^b}_{\text{tensor}} + \Gamma_{ac}^b V^c \right) \end{aligned}$$

$$\Leftrightarrow \Gamma_{a'c'}^{b'} \partial_c x^{c'} V^c + \partial_{a'} x^a V^c \partial_a \partial_c x^{b'} = \partial_{a'} x^a \partial_b x^{b'} \Gamma_{ac}^b V^c$$

valid $\forall V^c$ so we isolate Γ' by $\times \partial_{d'} x^c$

$$\Leftrightarrow \Gamma_{a'd'}^{b'} = \partial_{a'} x^a \partial_b x^{b'} \partial_{d'} x^c \Gamma_{ac}^b - \partial_{a'} x^a \partial_{d'} x^c \partial_a \partial_c x^{b'}$$

which gives

$$\Gamma_{b'c'}^{a'} = \partial_{b'} x^b \partial_{c'} x^c \partial_a x^{a'} \Gamma_{bc}^a - \partial_{b'} x^b \partial_{c'} x^c \partial_b \partial_c x^{a'}$$

so it is always possible to choose inertial coordinates at p , which vanish Γ :

$$\begin{aligned} \Gamma_{b'c'}^{a'} \Big|_p &= \partial_{b'} x^b \partial_{c'} x^c \left(\partial_a x^{a'} \Gamma_{bc}^a - \partial_b \partial_c x^{a'} \right) \Big|_p = 0 \\ \Leftrightarrow \frac{\partial_b \partial_c x^{a'}}{\partial_a x^{a'}}(p) &= \Gamma_{bc}^a(p) \end{aligned}$$

defines $x^{a'}(x^b)$. □

Locally $\frac{d^2 x^a}{d\lambda^2} = 0$: $\frac{dx^a}{d\tau} = cst$ along geodesic: usual straight line
 \Leftrightarrow inertial frame (local)
 see Equivalence Principle
 \Rightarrow no local way to feel gravity: need to go to geodesic deviation

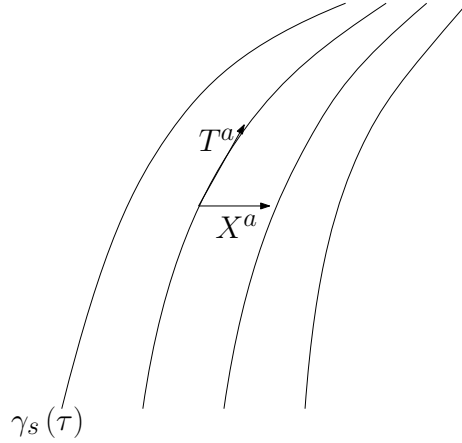

Figure 4.2.1: Geodesic family and its tangent vectors

4.2 Geodesic deviation

Measure how neighbouring geodesics drift away or converge.

Choose a one parameter geodesics family $\gamma_s(\tau)$ with smooth parameter $s \in \mathbb{R}$ and proper time parameter $\tau \in \mathbb{R}$

$$\begin{aligned} \frac{\partial x^a}{\partial \tau} &= T^a \text{ tangent to geodesic } \gamma_s \\ \frac{\partial x^a}{\partial s} &= X^a \text{ infinitesimal displacement to next geodesic } \gamma_{s+ds} \end{aligned}$$

Geodesic tangent

$$T^a \nabla_a T^b = 0$$

Affine parameterization τ of $\gamma_s(\tau)$ means the freedom $\tau' = a(s)\tau + b(s)$, however we can set it by choosing $T^a X_a = 0$ (X^a orthogonal to geodesics):

Proof. • $T^a T_a$ constant along geodesics: $T^b \nabla_b (T^a T_a) = 2(T^a T^b \nabla_b T_a) = 0$

- T^a, X^a are $(\partial_\tau)^a, (\partial_s)^a$, coordinate vector fields \Rightarrow commute

$$\Leftrightarrow T^a \nabla_a X^b = X^a \nabla_a T^b$$

and geodesics don't change their type so we can always normalise T^a : $n^a = \frac{T^a}{\sqrt{|T^b T_b|}} \Rightarrow n^a n_a = \pm 1$ or $T^a T_a = 0$ always along geodesics (reparameterise τ with norm; in fact as τ proper time, T^a normalised)

thus

$$\begin{aligned} T^b \nabla_b (T^a X_a) &= (T^b \nabla_b T^a) X_a + T^a T^b \nabla_b X_a \\ &= T^a X^b \nabla_b T_a = \frac{1}{2} X^b \nabla_b \underbrace{(T^a T_a)}_{=\pm 1, 0} = 0 \end{aligned}$$

so $T^a X_a = cst$ along geodesics

- at $\tau = 0$ we can reparameterise $\tau' = \tau + b(s)$ such that $T^a X_a = 0 \Rightarrow$ everywhere (exercise: find $b(s)$ so $\tau' = \tau + b(s) \Rightarrow T^a X_a = 0$)

□

Relative “velocity” of infinitesimally nearby geodesics

$$V^a = T^b \nabla_b X^a = \frac{dX^a}{d\tau}$$

Relative acceleration

$$\begin{aligned} a^a &= \frac{d^2 X^a}{d\tau^2} = T^c \nabla_c V^a = T^c \nabla_c (T^b \nabla_b X^a) \\ &= T^c \nabla_c (X^b \nabla_b T^a) && \text{: commutation} \\ &= (T^c \nabla_c X^b) \nabla_b T^a + X^b T^c \nabla_c \nabla_b T^a \\ &= (X^c \nabla_c T^b) \nabla_b T^a + X^b T^c \nabla_b \nabla_c T^a - R_{cbd}{}^a X^b T^c T^d \\ &\quad \text{comm.} && \text{Ricci ID} \\ &= X^c \nabla_c (T^b \nabla_b T^a) - R_{cbd}{}^a X^b T^c T^d \\ &= R_{dcb}^a T^d T^c X^b && \text{T geodesics, Riemann symmetries} \\ &= R_{bcd}^a T^b T^c X^d && \text{dummy renaming} \end{aligned}$$

So geodesic deviation equation:

$$\frac{d^2 X^a}{d\tau^2} = T^c \nabla_c (T^b \nabla_b X^a) = R_{bcd}^a T^b T^c X^d.$$

Marks the difference between accelerated frames and the effect of gravity/curvature:

- accelerated frames accelerate neighbouring geodesics the same way: $Rie = 0$
- initially parallel geodesics ($V^a = 0$) will fail to remain parallel $\Leftrightarrow Ric \neq 0$
- manifestation of gravitational tidal force (tidal equation)

This concerns 2D subspaces of geodesic families

What happens for vector fields in 4D?

4.3 Geodesic congruences

Congruence: in open set of spacetime

each point lies in only one geodesic

$U^a = \frac{dx^a}{d\lambda}$ tangent to congruence $\gamma_x(\lambda)$ of geodesic $U^b \nabla_b U^a = 0$

Separation vector X^a

$$\frac{dX^a}{d\lambda} = U^b \nabla_b X^a = X^b \nabla_b U^a = (\nabla_b U^a) X^b = U^a{}_{;b} X^b$$

$\nabla_b U^a$ measure of failure of X to be parallel transported

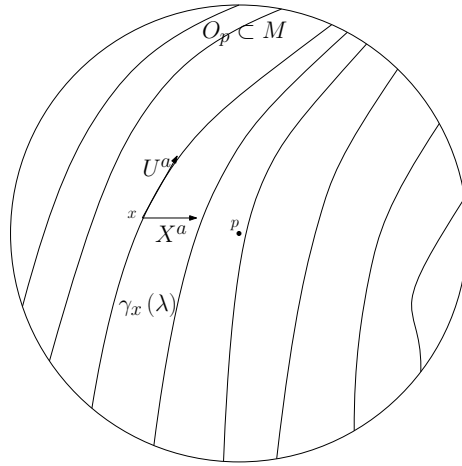

Figure 4.3.1: Congruence in an open set. Note it fills the whole spacetime open set $O_p \subset M$ and X is 3D.

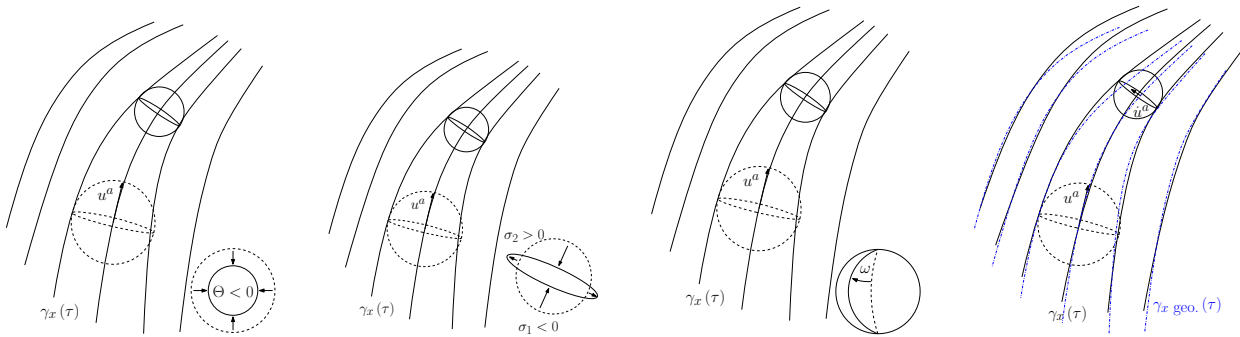

Figure 4.3.2: Optical scalars physical effects

4.3.1 Timelike geodesic congruences

timelike $U \rightarrow u, \lambda \rightarrow \tau, u^a u_a = -1$

4.3.1.1 1+3 decomposition (Ellis) optical scalars/tensors

Projector $\perp u^a$

$$h_{ab} = g_{ab} + u_a u_b$$

$$h_{ab} u^b = 0$$

$$h_a^c h_{cb} = h_{ab}$$

$$u^a u_{a;b} = \frac{1}{2} \left(\underbrace{u^a u_a}_{-1} \right)_{;b} = 0$$

$$u^b u_{a;b} = \dot{u}_a = u^b \nabla_b u_a = 0 \text{ for geodesics} \Rightarrow u_{a;b} = h_a^c h_b^d u_{c;d}$$

Trace $h^{ab} u_{a;b} = u^a_{;a} = \Theta = \text{div } u$ expansion

Symmetric tracefree $h_{(a}^c h_{b)}^d u_{c;d} - h_{ab} \frac{\Theta}{h^c_c} = \sigma_{ab}$ shear; $\frac{1}{2} \sigma^{ab} \sigma_{ab} = \sigma^2$ shear scalar

Antisymmetric part $u_{[a;b]} = \omega_{ab}$ vorticity ; $\frac{1}{2} \omega^{ab} \omega_{ab} = \omega^2$ vorticity scalar
they are both spatial tensors: $u \cdot \sigma = u \cdot \omega = 0$

Projection along $u^a - u^a u^b u_b = u^a$,

$$-u^a u^b u_{b;c} = 0$$

$$-u^a u^c u_{b;c} = -u^a \dot{u}_b \text{ for non-geodesics}$$

In 4D:

Volume element

$$\begin{aligned} \eta_{abcd} &= \epsilon_{abcd} \sqrt{-g} \\ &= \eta_{[abcd]} \\ \eta^{abcd} &= \frac{1}{\sqrt{-g}} \epsilon^{abcd} \end{aligned} \quad (4.1)$$

ϵ_{abcd} : totally antisymmetric tensor (+1 if permutation even; -1 if permutation odd; 0 if repeated indices)

Vorticity vector

$$\omega^a = \frac{1}{2} \eta^{abcd} u_b \omega_{cd} = -\frac{1}{2} \text{curl } u^a$$

inverted by (exercise: check)

$$\eta_{abcd} \omega^c u^d = \omega_{ab}$$

orthogonalities

$$\omega_{ab} u^b = 0$$

$$\omega_a u^a = 0$$

$$\omega_{ab} \omega^a = 0$$

normalisation

$$\omega^a \omega_a = \frac{1}{2} \omega^{ab} \omega_{ab} = \omega^2$$

4.3.1.2 Evolution

$$\begin{aligned}
\frac{d}{d\tau}(u_{a;b}) &= u^c \nabla_c (u_{a;b}) = u^c \nabla_c \nabla_b u_a \\
&= u^c \nabla_b \nabla_c u_a + u^c R_{abc}^d u_d \\
&= \nabla_b (u^c \nabla_c u_a) - (\nabla_b u^c) (\nabla_c u_a) - R_{adb} u^d u^c \\
&= \underbrace{\dot{u}_{a;b}}_{0 \text{ for geodesics}} - u_{a;c} u^c_{;b} - R_{acbd} u^c u^d
\end{aligned}$$

Trace:

$$\frac{d\Theta}{d\tau} = -\frac{\Theta^2}{3} - 2(\sigma^2 - \omega^2) - R_{ab} u^a u^b \quad (+\dot{u}^a_{;a}) \quad (4.2)$$

Raychaudhuri equation for geodesics

Symmetric tracefree part

$$\frac{D\sigma_{ab}}{d\tau} = -\frac{2}{3}\Theta\sigma_{ab} - \sigma_{ac}\sigma_b^c - \omega_{ac}\omega_b^c + \frac{2}{3}h_{ab}(\sigma^2 - \omega^2) + C_{acbd}u^c u^d + \frac{1}{2}{}^3R_{ab} \quad (+{}^3\dot{u}_{a;b}) \quad (4.3)$$

where ${}^3R_{ab}/{}^3\dot{u}_{a;b}$ is projected symmetric tracefree part (PSTF) of Ricci tensor/covariant derivative of acceleration

$$\begin{aligned}
{}^3R_{ab} &= \left(h_a^c h_b^d - h_{ab} \frac{h^{cd}}{h_c^c} \right) R_{cd} \\
{}^3\dot{u}_{a;b} &= \left(h_a^c h_b^d - h_{ab} \frac{h^{cd}}{h_c^c} \right) \dot{u}_{c;d}
\end{aligned}$$

Antisymmetric part:

$$\frac{D\omega_{ab}}{d\tau} = -\frac{2}{3}\Theta\omega_{ab} - \sigma_a^c \omega_{cb} + \sigma_b^c \omega_{ca} \quad (+\dot{u}_{[a;b]})$$

Example In Raychaudhuri, the source term yields the strong energy condition (SEC) from Einstein's Eqs.

$$R_{ab} u^a u^b = \kappa^2 \left(T_{ab} - \frac{T}{2} g_{ab} \right) u^a u^b$$

and the SEC requires

$$\left(T_{ab} - \frac{T}{2} g_{ab} \right) u^a u^b \geq 0 \quad \text{so } R_{ab} u^a u^b \geq 0$$

4.3.1.3 Aside: Energy conditions

Limits to T_{ab} so as to get physically meaningful solutions

Energy momentum tensors and generic vector congruences**Archetypal Examples:****Perfect fluid** (ρ, P, u_a)

$$T_{ab} = \rho u_a u_b + P h_{ab} = (\rho + P) u_a u_b + P g_{ab}$$

Vacuum with cosmological constant

$$T_{ab} = \frac{\Lambda}{\kappa^2} u_a u_b - \frac{\Lambda}{\kappa^2} h_{ab} = -\frac{\Lambda}{\kappa^2} g_{ab}$$

Imperfect fluid with energy density ρ , isotropic pressure P , heat flux q_a and anisotropic stress Π_{ab} (and cosmological constant Λ) (with flow u_a , $u^a u_a = -1$)

$$T_{ab} = \rho u_a u_b + P h_{ab} + 2q_{(a} u_{b)} + \Pi_{ab} - \frac{\Lambda}{\kappa^2} g_{ab}$$

We consider vector fields t^a , timelike, and l^a , null,

$$t^a t_a < 0 \qquad l^a l_a = 0$$

For a fluid description, since any two timelike vectors of same light cone are related by a given vector, we can thus decompose one in terms of the other and a null vector:

$$\forall t^a \text{ timelike } t^a - u^a = S^a$$

$$t^a - u^a = S^0 u^a + \pi S e^a$$

where $S^0 = -S^a u_a$, $\pi S^a = h^a_b S^b = S^a - S^0 u^a$ spacelike

$$\text{so } \pi S = \sqrt{\pi S^a \pi S_a} > 0$$

$$\text{and we define } e^a = \frac{\pi S^a}{\pi S} \text{ such as } e^a e_a = 1, u^a e_a = 0$$

Then

$$\begin{aligned} t^a t_a &= (1 + S^0)^2 u^a u_a + \pi S^a \pi S_a \\ &= - (1 + S^0)^2 + (\pi S)^2 < 0 \end{aligned}$$

as t^a is timelike

$$\text{So we have } (\pi S)^2 < (1 + S^0)^2$$

$$\text{Since } t^a \text{ and } u^a \text{ in same light cone so } 1 + S^0 > 0 \text{ and thus } 1 + S^0 > \pi S$$

$$\text{(In case } t^a \text{ in opposite light cone from } u^a, 1 + S^0 < 0 \Rightarrow 1 + S^0 < -\pi S < \pi S$$

so $1 + S^0 < \pi S$)

$$\text{We can thus write, defining } l^a = u^a + e^a \Rightarrow l^a l_a = 0,$$

$$\begin{aligned} t^a &= (1 + S^0) u^a + \pi S e^a \\ &= (1 + S^0 - \pi S) u^a + \pi S (u^a + e^a) \\ &= (1 + S^0 - \pi S) u^a + \pi S l^a \end{aligned}$$

with $\pi S, 1 + S^0 - \pi S > 0$

Then for any symmetric 2-tensor A_{ab}

$$A_{ab}t^at^b = (1 + S^0 - \pi S)^2 A_{ab}u^au^b + (\pi S)^2 A_{ab}l^al^b + 2\pi S (1 + S^0 - \pi S) A_{ab}u^al^b \quad (4.4)$$

and we are left with

$$\begin{aligned} & A_{ab}u^au^b \\ & A_{ab}l^al^b \\ & A_{ab}u^al^b \end{aligned}$$

and for any vector V^a , the perfect fluid yields

$$\begin{aligned} T_{ab}V^b &= (\rho + P) (V^bu_b) u_a + P V_a \\ \Rightarrow T_{ac}T_b^cV^aV^b &= (\rho + P)^2 (V^bu_b)^2 u^au_a + P^2V^aV_a + 2P(\rho + P) (V^bu_b)^2 \\ &= (\rho + P) (V^bu_b)^2 [-(\rho + P) + 2P] + P^2V^aV_a \\ &= -(\rho^2 - P^2) (V^bu_b)^2 + P^2V^aV_a \end{aligned} \quad (4.5)$$

while the Ricci tensor for a perfect fluid, given the EFE, gives ($T = -\rho + 3P$)

$$\begin{aligned} R_{ab} &= \kappa^2 \left(T_{ab} - \frac{T}{2} g_{ab} \right) \\ &= \kappa^2 \left((\rho + P) u_a u_b + \left(P + \frac{\rho - 3P}{2} \right) g_{ab} \right) \\ &= \kappa^2 \left((\rho + P) u_a u_b + \frac{\rho - P}{2} g_{ab} \right) \\ &= \kappa^2 \left(\frac{\rho + 3P}{2} u_a u_b + \frac{\rho - P}{2} h_{ab} \right) \\ &= \kappa^2 \chi_{ab} \end{aligned} \quad (4.6)$$

Some of the most popular energy conditions are

The weak energy condition (WEC) requires for all timelike vectors t^a

$$\forall t^a, t^a t_a < 0 \quad T_{ab}t^a t^b \geq 0$$

(average energy density as seen by an observer t^a must be positive (see [Rosa and Piçarra(2020)]))

For a perfect fluid:

$$T_{ab}t^a t^b = (1 + S^0 - \pi S)^2 T_{ab}u^a u^b + (\pi S)^2 T_{ab}l^a l^b + 2\pi S (1 + S^0 - \pi S) T_{ab}u^a l^b$$

but

$$T_{ab}u^a u^b = \rho \qquad T_{ab}l^a l^b = (\rho + P)(u^a l_a)^2$$

$$T_{ab}u^a l^b = -\rho u^a l_a = -\rho u^a (u_a + e_a) = \rho$$

Thus

$$T_{ab}t^a t^b \geq 0 \Leftrightarrow \boxed{\rho \geq 0 \text{ and } (\rho + P) \geq 0}$$

The null energy condition (NEC) requires for all null vector L^a

$$\forall L^a, L^a L_a = 0 \qquad T_{ab}L^a L^b \geq 0$$

For a perfect fluid: We have seen

$$\begin{aligned} T_{ab}l^a l^b &= (\rho + P)(u^a l_a)^2 \\ &\Leftrightarrow \boxed{(\rho + P) \geq 0} \end{aligned}$$

note ρ and P can be negative

The dominant energy condition (DEC) requires the WEC with $T^{ab}t_b$ non spacelike, i.e.

$$T_{ac}T_b^c t^a t^b \leq 0$$

(matter must move along timelike or null worldlines: matter momentum density $-T^{ab}t_b$ must also be future directed and non spacelike (see [Rosa and Piçarra(2020)]))

For a perfect fluid:

$$\begin{aligned} T_{ac}T_b^c t^a t^b &= -(\rho^2 - P^2)(u^a t_a)^2 + P^2 t^a t_a \leq 0 \\ &\Rightarrow \rho^2 - P^2 \geq 0 \end{aligned}$$

Since WEC $\Leftrightarrow \rho \geq 0$ and $(\rho + P) \geq 0$
then $\rho - P \geq 0$ so

$$\left. \begin{array}{l} \rho \geq P \\ \rho \geq -P \end{array} \right\} \Leftrightarrow \boxed{\rho \geq |P|}$$

The null dominant energy condition (NDEC) requires the NEC with $T^{ab}l_b$ non spacelike, i.e.

$$T_{ac}T_b^c l^a l^b \leq 0$$

For a perfect fluid:

$$\begin{aligned} T_{ac}T_b^c l^a l^b &= -(\rho^2 - P^2)(u^a l_a)^2 \leq 0 \\ &\Leftrightarrow \rho^2 - P^2 \geq 0 \end{aligned}$$

and $\rho + P \geq 0 \Rightarrow$ either

$$\rho \geq 0, \boxed{\rho \geq |P|}$$

or $\rho < 0$ so $\rho + P \geq 0 \Leftrightarrow P \geq -\rho > 0$ but $\rho^2 - P^2 \geq 0 \Leftrightarrow \rho - P \geq 0 \Rightarrow P \leq \rho < 0$ or $\rho + P \leq 0 \Rightarrow$

$$\boxed{P = -\rho}$$

The strong energy condition (SEC) requires

$$\begin{aligned} \forall t^a, t^a t_a < 0, T_{ab} t^a t^b &\geq \frac{1}{2} T_c^c t^a t_a \\ \Leftrightarrow \chi_{ab} t^a t^b &= \left(T_{ab} - \frac{T}{2} g_{ab} \right) t^a t^b \geq 0 \\ &= (1 + S^0 - \pi S)^2 \chi_{ab} u^a u^b + (\pi S)^2 \chi_{ab} l^a l^b + 2\pi S (1 + S^0 - \pi S) \chi_{ab} u^a l^b \end{aligned}$$

(trace of tidal tensor, i.e. R_{ab} , must be non negative as measured by t^a (see [Rosa and Piçarra(2020)]))

For a perfect fluid:

$$\begin{aligned} \chi_{ab} u^a u^b &= \left(\frac{\rho + 3P}{2} u_a u_b + \frac{\rho - P}{2} h_{ab} \right) u^a u^b = \frac{\rho + 3P}{2} \\ \chi_{ab} l^a l^b &= \left((\rho + P) u_a u_b + \frac{\rho - P}{2} g_{ab} \right) l^a l^b = (\rho + P) (u^a l_a)^2 = \rho + P \\ \chi_{ab} u^a l^b &= -\frac{\rho + 3P}{2} u^a l_a = \frac{\rho + 3P}{2} \end{aligned}$$

Thus

$$\chi_{ab} t^a t^b \geq 0 \Leftrightarrow \boxed{\rho + P \geq 0 \text{ and } \rho + 3P \geq 0}$$

Gravity attractive

Relations between energy conditions Note that

$$\begin{aligned} \text{DEC} &\Rightarrow \text{WEC} \Rightarrow \text{NEC} \\ \text{NDEC} &\Rightarrow \text{NEC} \\ \text{SEC} &\Rightarrow \text{NEC} \end{aligned}$$

Return to Raychaudhuri source for geodesic congruences

4.3.1.4 Energy condition and congruence evolution

Now by Frobenius theorem, u^a hypersurface orthogonal translates as

$$\begin{aligned} u_{[a}\nabla_b u_{c]} &= 0 \\ &= \frac{1}{3} (u_a\nabla_{[b}u_{c]} + u_b\nabla_{[c}u_{a]} + u_c\nabla_{[a}u_{b]}) \end{aligned}$$

and by definition of $\omega_{ab} = \nabla_{[b}u_{a]}$, this yields

$$(u_a\omega_{cb} + u_b\omega_{ac} + u_c\omega_{ba}) = 0$$

Since $u^a\omega_{ab} = 0$, contracting with, say, u^a gives

$$-\omega_{cb} = 0$$

and conversely if $\omega_{ab} = 0$ then $u_{[a}\nabla_b u_{c]} = 0$

Thus $\omega_{ab} = 0 \Leftrightarrow u^a$ hypersurface orthogonal.

Then: the Raychaudhuri Eq. of a hypersurface orthogonal geodesic congruence verifying the SEC implies

$$\begin{aligned} \frac{d\Theta}{d\tau} + \frac{\Theta^2}{3} &= -2\sigma^2 - R_{ab}u^a u^b \leq 0 \\ \Leftrightarrow \frac{d\Theta}{d\tau} &\leq -\frac{\Theta^2}{3} \end{aligned}$$

which integrates into

$$\frac{d\tau}{3} \leq -\frac{d\Theta}{\Theta^2} = d\left(\frac{1}{\Theta}\right) \quad \Rightarrow \Theta^{-1} \geq \Theta_0^{-1} + \frac{\tau}{3}$$

Therefore starting from a converging ($\Theta_0 < 0$) hypersurface orthogonal congruence obeying the SEC can never diverge before hitting a caustic ($\Theta \rightarrow -\infty$, geodesic crossing) in finite proper time ($\tau \leq -3\Theta_0^{-1}$).

4.3.2 Null geodesic congruences

Defined as $k^a = \frac{dx^a}{d\lambda}$, $k^a k_a = 0$. Problem to define orthogonal space, as self orthogonal

Take $l^a l_a = 0$ null with $l^a k_a = -1$, that is pointing in the opposite spatial direction (frame dependent) and parallel transported along k^a : $k^b \nabla_b l^a = 0$

4.3.2.1 2+2 decomposition (Hayward)

Define projector orthogonal to (k, l) , onto

$$T_{\perp} = \{V^a | V^a k_a = 0, V^a l_a = 0\}$$

4.3.2.2 A hint of 1+1+2 decomposition (Clarkson)

From a timelike and spacelike orthogonal pair $u^a u_a = -1$ $e^a e_a = 1$ $u^a e_a = 0$ we can build

$$\begin{cases} k^a = \frac{u^a + e^a}{\sqrt{2}} \\ l^a = \frac{u^a - e^a}{\sqrt{2}} \end{cases} \quad k^a l_a = -1$$

We saw in 1+3: $h_{ab} = g_{ab} + u_a u_b$ projector $\perp u^a$

Iterate in 3D space with metric h_{ab}

Define $N_{ab} = h_{ab} - e_a e_b$

$$\begin{aligned} N_{ab} e^b &= 0 & N_{ab} k^b &= 0 \\ N_{ab} u^b &= 0 & \text{so } N_{ab} l^b &= 0 \end{aligned}$$

This looks right. Since

$$\begin{aligned} u^a &= \frac{k^a + l^a}{\sqrt{2}} \\ e^a &= \frac{k^a - l^a}{\sqrt{2}} \end{aligned}$$

$$\begin{aligned} N_{ab} &= g_{ab} + u_a u_b - e_a e_b \\ &= g_{ab} + \frac{(k_a + l_a)(k_b + l_b)}{2} - \frac{(k_a - l_a)(k_b - l_b)}{2} \\ &= g_{ab} + k_{(a} l_{b)} + k_{(a} l_{b)} = \boxed{g_{ab} + 2k_{(a} l_{b)}} \end{aligned}$$

$\forall V^a, W^a \in T_\perp$

$$\begin{aligned} N_{ab} V^a W^b &= (g_{ab} + 2k_{(a} l_{b)}) V^a W^b \\ &= g_{ab} V^a W^b \\ N_b^a V^b &= g_b^a V^b = V^a \\ N_b^a k^b &= k^a + k^a (l_b k^b) = 0 \\ N_b^a l^b &= l^a + l^a (k_b l^b) = 0 \\ N_c^a N_b^c &= N_c^a (g_b^c + k^c l_b + l^c k_b) \\ &= N_b^a \\ k^c \nabla_c N_b^a &= k^c \nabla_c (g^{ad} N_{db}) = g^{ad} k^c \nabla_c N_{db} \\ &= g^{ad} k^c \nabla_c (g_{db} + 2k_{(d} l_{b)}) \\ &= g^{ad} k^c \nabla_c (\nabla_c (k_{(d} l_{b)}) + k_{(d} \nabla_c l_{b)}) \end{aligned}$$

and since

$$\begin{aligned} k^c \nabla_c k_d &= 0 \text{ (null geodesic)} \\ k^c \nabla_c l_b &= 0 \text{ (parallel transport)} \end{aligned}$$

then $k^c \nabla_c N_b^a = 0$

Again, the failure for a normal separation vector $X^a \in T_\perp$ to be parallel transported, as for timelike congruences, is measured by $k_{;b}^a$ (see deviation and commuting vectors):

$$\frac{DX^a}{d\lambda} = k^b \nabla_b X^a = X^b \nabla_b k^a = \boxed{k_{;b}^a} X^b$$

but here only its projection is needed:

$$\begin{aligned} \frac{DX^a}{d\lambda} &= k^b \nabla_b X^a = k^b \nabla_b (N_c^a X^c) \\ &= N_c^a k^b \nabla_b X^c \\ &= N_c^a X^b \nabla_b k^c \\ &= N_c^a N_d^b k_{;b}^c X^d \\ &= \hat{k}_{;d}^a X^d \end{aligned}$$

where $\hat{k}_{;b}^a = N_c^a N_b^d k_{;d}^c$

Again 2-trace

2-Trace $N^{ab} k_{a;b} = \hat{k}_{;a}^a = \Theta_{(k)}$ 2-expansion

Projected symmetric tracefree $(N_{(a}^c N_{b)}^d - N_{ab} \frac{N^{cd}}{N_c^c}) k_{c;d} = \hat{\sigma}_{ab}$ 2-shear

Antisymmetric part $\hat{k}_{[a;b]} = \hat{\omega}_{ab}$ 2-vorticity

Note $N_c^c = h_c^c - e^c e_c = g_c^c + u^c u_c - e^c e_c = 4 - 1 - 1 = 2$ dimensionality of T_\perp

As in timelike case $k^a \hat{\omega}_{ab} = 0$ and Frobenius lead to $\hat{\omega}_{ab} = 0 \Leftrightarrow k^a T_\perp$ surface orthogonal

4.3.2.3 Evolution

$$\begin{aligned} \frac{D}{d\lambda} (\hat{k}_{a;b}) &= k^c \nabla_c (\hat{k}_{a;b}) = k^e \nabla_e (N_a^c N_b^d k_{c;d}) \\ &= N_a^c N_b^d k^e \nabla_e \nabla_d k_c \\ &= N_a^c N_b^d (k^e \nabla_d \nabla_e k_c + k^e R_{cde}^f k_f) \\ &= N_a^c N_b^d (\nabla_d (k^e \nabla_e k_c) - (\nabla_d k^e) (\nabla_e k_c) - R_{c f d e} k^f k^e) \\ &= \underbrace{N_a^c N_b^d \left(\frac{dk_c}{d\lambda} \right)_{;d}}_{0 \text{ for geodesics}} - \hat{k}_{a;c} \hat{k}_{;b}^c - N_a^c N_b^d R_{c f d e} k^f k^e \end{aligned}$$

since

$$\begin{aligned} \nabla_d k^e \nabla_e k_c &= g^{ef} \nabla_d k_f \nabla_e k_c \\ &= (N^{ef} - 2k^{(e} l^{f)}) \nabla_d k_f \nabla_e k_c \end{aligned}$$

and

$$\begin{aligned} k^e \nabla_e k_c &= 0 \text{ (null geodesic)} \\ l^e \nabla_e k_c &= k^e \nabla_e l_c \text{ (commuting)} \\ &= 0 \text{ (parallel transport)} \end{aligned}$$

so

$$\nabla_d k^e \nabla_e k_c = \nabla_d k_f N^{fe} \nabla_e k_c$$

Furthermore

$$\begin{aligned} \text{tr} N N R k k &= N^{ac} N_a^d R_{c f d e} k^f k^e \\ &= N^{ac} R_{c f a e} k^f k^e \\ &= \left(g^{ac} + 2k^{(a} l^{c)} \right) R_{[c f][a e]} k^{(f} k^{e)} \\ &= g^{ac} R_{c f a e} k^f k^e \\ &= \text{tr} R k k \end{aligned}$$

by anticommutation of Riemann's pairs Following the same path than for the timelike congruences:

Trace:

$$\frac{d\Theta_{(k)}}{d\lambda} = -\frac{\Theta_{(k)}^2}{2} - 2(\hat{\sigma}^2 - \hat{\omega}^2) - R_{ab} k^a k^b \quad (4.7)$$

Raychaudhuri Eq. for null geodesics

Note the $(k, 2)$ -expansion is naturally projected as $k^e \nabla_e k_c = 0$ from geodesics and $k^a \nabla_b k_a = \frac{1}{2} \nabla_b k^a k_a = 0$ from norm, so

$$\begin{aligned} \Theta_{(k)} &= N^{ab} \hat{k}_{a;b} = N^{ab} N_a^c N_b^d k_{c;d} \\ &= N^{cd} k_{c;d} \\ &= \left(g^{ab} + 2k^{(a} l^{b)} \right) k_{a;b} \\ &= g^{ab} k_{a;b} = k^a_{;a} \end{aligned}$$

Samelyfor $\hat{\sigma}^2$ and $\hat{\omega}^2$, noting $\{\}$ for either $()$ or $[\]$, and for the same geodesic/ norm reasons

$$\begin{aligned} \hat{k}^{\{a;b\}} \hat{k}_{\{a;b\}} &= N^{ac} N^{ad} k_{\{c;d\}} k_{\{a;b\}} \\ &= g^{ac} g^{ad} k_{\{c;d\}} k_{\{a;b\}} \\ &= k^{\{a;b\}} k_{\{a;b\}} \end{aligned}$$

thus Raychaudhuri is independent of the arbitrary choice of l^a

The source term is given through EFE (recall $k^a k_a = 0$)

$$R_{ab} k^a k^b = \kappa^2 \left(T_{ab} - \frac{T}{2} g_{ab} \right) k^a k^b = \kappa^2 T_{ab} k^a k^b$$

so this is the base for the NEC: convergence to caustics more general

Projected Symmetric tracefree part

$$\frac{D\hat{\sigma}_{ab}}{d\lambda} = -\Theta_{(k)}\hat{\sigma}_{ab} - N_a^c N_b^d C_{cedf} k^e k^f \quad (4.8)$$

Shear evolution

Antisymmetric part:

$$\frac{D\hat{\omega}_{ab}}{d\lambda} = -\Theta_{(k)}\hat{\omega}_{ab}$$

vorticity evolution

If l^a considered, by symmetry you get

$$\begin{aligned} \text{Raychaudhuri } \frac{d\Theta_{(l)}}{d\nu} &= -\frac{\Theta_{(l)}^2}{2} - 2\left(\hat{\sigma}_{(l)}^2 - \hat{\omega}_{(l)}^2\right) - R_{ab}l^a l^b \\ \text{Shear } \frac{D\hat{\sigma}_{(l)ab}}{d\nu} &= -\Theta_{(l)}\hat{\sigma}_{(l)ab} - N_a^c N_b^d C_{cedf} l^a l^b \\ \text{Vorticity } \frac{D\hat{\omega}_{(l)ab}}{d\nu} &= -\Theta_{(l)}\hat{\omega}_{(l)ab} \end{aligned}$$

and mixed Raychaudhuri can even be considered

$$\frac{1}{2} \left(\frac{d\Theta_{(l)}}{d\lambda} + \frac{d\Theta_{(k)}}{d\nu} - \frac{k_a}{2} [l, k]^a \Theta_{(l)} - \frac{l_a}{2} [k, l]^a \Theta_{(k)} \right) + \Theta_{(k)}\Theta_{(l)} = \frac{g_{ab}k^a l^b}{r^2} + R_{ab}k^a l^b$$

Chapter 5

Horizons and singularity theorems

5.1 Horizons

5.1.1 Event horizons

Definition 5.1. Event Horizon

Hypersurface separating events connected to time infinity by timelike curves from those not connected

 Global concept

In asymptotically flat spacetimes with event horizons (EH)

⇒ conformal diagram with Minkowski-like light and space infinities ($i^0, \mathcal{I}^+, \mathcal{I}^-$, see Fig. 5.1.1)

Timelike infinities aren't necessary to define EH.

Define the causal past of an open set O

$$J^-(O) = \{x \in \mathcal{M} | \exists y \in O, \exists \gamma(\tau), \dot{\gamma}^2 \leq 0, \gamma(\tau_2) = y, \exists \tau_1 < \tau_2, \gamma(\tau_1) = x\} \quad (5.1)$$

i.e. set of events connected by past causal curves to events of O .

Causal future of O

$$J^+(O) = \{x \in \mathcal{M} | \exists y \in O, \exists \gamma(\tau), \dot{\gamma}^2 \leq 0, \gamma(\tau_1) = y, \exists \tau_2 > \tau_1, \gamma(\tau_2) = x\} \quad (5.2)$$

this time, events connected by future curves to O .

Their boundaries yield light cones of events of O

Event Horizons:

Boundary of $J^-(\mathcal{I}^+)$:

$\partial J^-(\mathcal{I}^+)$: future horizon

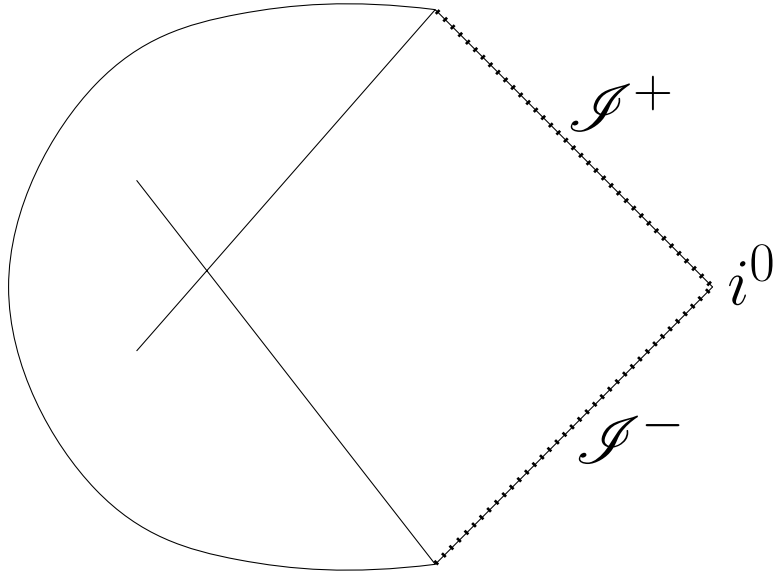

Figure 5.1.1: Conformal diagram for asymptotically flat spacetimes

Boundary of J^+ (\mathcal{I}^-):
 ∂J^+ (\mathcal{I}^-): past horizon

Thus EH are null hypersurfaces

Σ **Hypersurface:** Defined by an equation $f(x) = cst$
 $\partial_a f$ normal vector to Σ

Σ **Null Hypersurface:** $\partial_a f \partial^a f = 0$ thus $\partial_a f$ also tangent to Σ

Generators of Null Hypersurface Σ : $\gamma(\lambda)$ family of null geodesics
 If $\Sigma = \cup \gamma(\lambda)$, the γ 's are called generators of Σ
 Their tangent vectors are proportional to the normal

$$k^a = \frac{dx^a}{d\lambda} = h(x) g^{ab} \partial_b f \Rightarrow k^a \text{ normal}$$

A possible choice of $h(x)$ renders γ affinely parameterised

$$k_a k^a = 0 \qquad k^b \nabla_b k^a = 0 \text{ (geodesic)}$$

$\partial [J^-(\mathcal{I}^+)]$ future EH: γ may end in past, not in future
 $\partial [J^+(\mathcal{I}^-)]$ past EH: γ may end in future, not in past

EH in static spacetimes (Schwarzschild-type)

Stationary metric $\Rightarrow \partial_t$ timelike Killing vector at $r \rightarrow \infty$
 $\partial_a t$ normal to $t = cst$ hypersurfaces

$\partial_a r$ normal to $r = cst$ hypersurfaces which are timelike at $r \rightarrow \infty$ (Minkowski-like)

with norm $g^{ab} \partial_a r \partial_b r = g^{rr}$

$r = cst$ becomes lightlike at $r = r_H$: $g^{rr}(r_H) = 0$

In Schwarzschild $g^{rr} = 1 - \frac{2GM}{r} \xrightarrow{r_H=2GM} 0$

5.1.2 Importance of E.H.

- They often appear to hide singularities (Cosmic Censorship Conjecture)
- Singularities are inevitable (Singularity theorems)

\Rightarrow EH are ubiquitous!

5.1.2.1 Singularity theorems

Singularity theorems: Generic physical initial conditions lead to collapse into singularities, once reaching a certain point (Hawking-Penrose)

- Singularities are marked by geodesic incompleteness (they end at finite affine parameter)
- The point of no return is marked by the appearance of Trapped Surfaces

Trapped surfaces and Trapping Horizons

Trapped Surfaces are local conditions for the appearance of Event Horizons

In spherical symmetry, foliated in spheres with dual null 2+2 decomposition, k^a, l^a lightlike independent directions with $N_{ab} = g_{ab} + k_{(a} l_{b)}$

2-expansion along vector v^a : $\Theta_v = \frac{2}{r} \mathcal{L}_v r$, with r areal radius

- If $\Theta_k \Theta_l < 0$ on a sphere: normal or untrapped
Region foliated with normal surfaces = normal region
- If $\Theta_k \Theta_l > 0$ on a sphere: Trapped Surface
 - $\Theta_k, \Theta_l < 0$: future trapped or simply trapped
 - $\Theta_k, \Theta_l > 0$: past trapped or anti-trapped

Region foliated with trapped (future/past) surfaces = Trapped (future/past) Region

- If $\Theta_k \Theta_l = 0$ on a sphere: Marginal Surface
Without loss of generality, assume $\Theta_k = 0$
 - $\mathcal{L}_l \Theta_k < 0$: outer marginal surface
 - $\mathcal{L}_l \Theta_k > 0$: inner marginal surface
 - $\mathcal{L}_l \Theta_k = 0$: degenerated marginal surface

Definition 5.2. Trapping Horizon

A trapping horizon (TH) is a Lorentzian 3-hypersurface foliated with marginal surfaces

In static solutions $\text{EH}=\text{TH}$

As TH is local while EH is global, TH is used to characterise Black Holes

Examples In Minkowski with a 2-sphere thin shell emitting light outward and inward, governed by Θ_k, Θ_l .

Outwards yield $\Theta_k > 0$

Inwards yield $\Theta_l < 0$

so Minkowski has $\Theta_k \Theta_l < 0 \Rightarrow$ normal region/spacetime

In Schwarzschild, inside r_H , we get

$\Theta_k < 0$ and $\Theta_l < 0 \Rightarrow$ future trapped region

$r = r_H: \Theta_k = 0 \Rightarrow \text{TH}$

We return to singularity theorems later. A possible escape to arisal of singularities could rely on the discovery of quantum gravity.

Or dark energy (violation of SEC)

5.1.2.2 Cosmic censorship conjecture

Conjecture 5.1. *Naked singularities cannot form in gravitational collapse from generic, initially nonsingular states in asymptotically flat spacetimes obeying the DEC.*

Conjecture: yet unproven, for generic initial conditions

Naked singularity: Singularity that can send light to \mathcal{I}^+ unimpeded by EH.

Example 5.1.

- Schwarzschild White Hole

see Fig. 5.1.2

Example 5.2. -Charged BH (Reissner-Nordström)

Q : electric charge

M_B : magnetic charge

$$ds^2 = -\Delta dt^2 + \Delta^{-1} dr^2 + r^2 d\Omega^2$$

$$\Delta = 1 - \frac{2GM}{r} + \frac{G(Q^2 + M_B^2)}{r^2}$$

Electric and magnetic fields are radial (see Fig. 5.1.3)

$$\vec{E} = E_r \vec{e}_r = F_{rt} \vec{e}_r = \frac{Q}{r^2} \vec{e}_r$$

$$\vec{B} = B_r \vec{e}_r = \frac{F_{\theta\phi}}{r^2 \sin\theta} \vec{e}_r = \frac{M_B}{r^2} \vec{e}_r$$

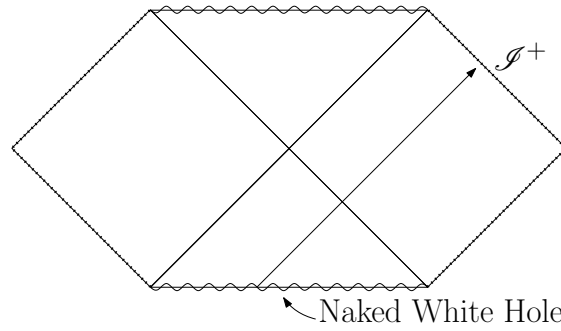

Figure 5.1.2: Schwarzschild white hole Carter-Penrose diagram

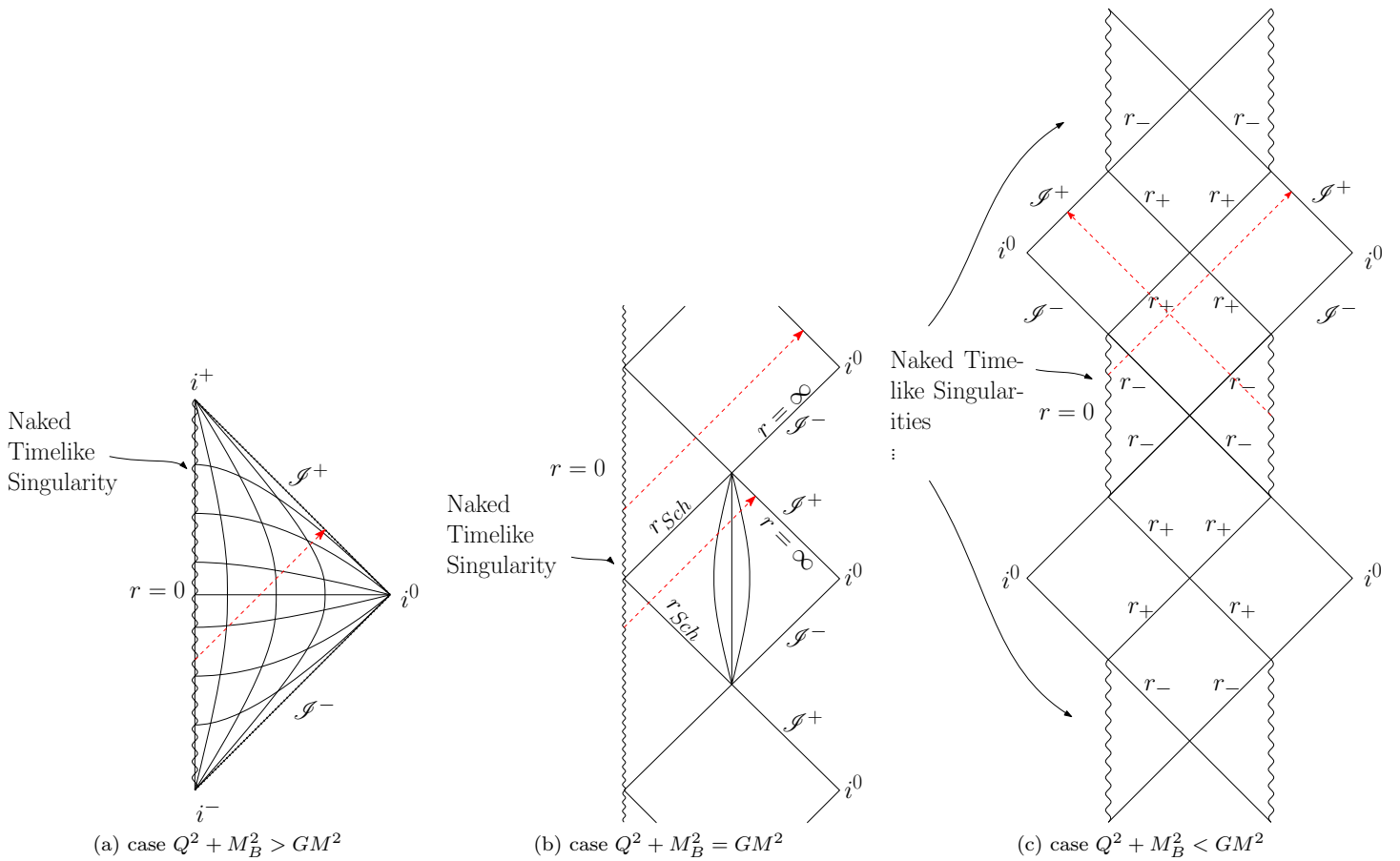

Figure 5.1.3: Reissner-Nordström Carter-Penrose diagrams

5.1.3 Killing horizons

Definition 5.3. A Killing Horizon (K.H.) is a surface Σ where a Killing vector ξ^a becomes null.

e.g. In Schwarzschild, $\xi^a = \partial_t^a$, on K.H. ξ^a is tangent and normal (null)
 In general K.H., T.H. and E.H. are distinct.
 In spacetimes with time-reversal symmetry, K.H. and E.H. are related.

- Every Σ E.H., in stationary, asymptotically flat spacetime, is a K.H. for some Killing field ξ^a
- If spacetime is static, $\xi^a = \partial_t^a = K^a$, time translation at space infinity
- If spacetime stationary, not static, then it is axisymmetric with rotation Killing field $R^a = \partial_\phi^a$ and $\zeta^a = K^a + \Omega_H R^a$ for Ω_H constant

Example 5.3. In Minkowski $ds^2 = -dt^2 + dx^2 + dy^2 + dz^2$

Invariance under boost in x direction \Rightarrow Killing vector $\xi = x\partial_t + t\partial_x$

$$\xi^a \xi_a = -x^2 + t^2 \quad \Rightarrow \xi^a \text{ null on } t = \pm x : \text{ K.H.}$$

so Minkowski is filled with K.H.s

5.1.3.1 Surface gravity of K.H.

Σ K.H. with Killing vector ξ^a

$\Leftrightarrow \xi^a$ normal to Σ and $\xi^a \xi_a = 0$ on Σ

Thus $\nabla_a \xi^b \xi_b$ normal to $\Sigma \Rightarrow$ proportional to ξ^a , normal

$\exists \kappa, \nabla^a \xi^b \xi_b = -2\kappa \xi^a$ and Killing equation $\nabla^a \xi^b = -\nabla^b \xi^a$

so $\xi_b \nabla^b \xi^a = \kappa \xi^a$: geodesic eq. in non-affine parameterisation

We have $\mathcal{L}_\xi (\nabla^a \xi^b \xi_b) = \nabla^a \mathcal{L}_\xi (\xi^b \xi_b) = 0 = -2(\xi^a \mathcal{L}_\xi \kappa + \kappa \mathcal{L}_\xi \xi^a)$
for scalar $\xi^a \xi_a, \xi^a$ K.V. and ∇^a torsionless $\xi^b \xi_b = 0$ along Σ/ξ^a

and $\mathcal{L}_\xi \xi^a = \xi^b \nabla_b \xi^a - \xi^b \nabla_b \xi^a = 0$

$\Rightarrow \mathcal{L}_\xi \kappa = 0$: κ constant along Σ (exercise: show $\mathcal{L}_\xi (\nabla^a \xi^b \xi_b) = \nabla^a \mathcal{L}_\xi (\xi^b \xi_b)$)

κ : failure of Killing parameter v , defined by $\xi^a \nabla_a v = 1$, to agree with affine parameter λ on null generators of Σ

- Define $k^a = \frac{dx^a}{d\lambda}$ on Σ by $k^a = e^{-\kappa v} \xi^a$
 then

$$\begin{aligned} k^b \nabla_b k^a &= e^{-2\kappa v} [\xi^b \nabla_b \xi^a - \xi^a \xi^b \nabla_b (\kappa v)] \\ &= e^{-2\kappa v} \left[\kappa \xi^a - \underbrace{\kappa \xi^a (\xi^b \nabla_b v)}_1 \right] \text{ since } \mathcal{L}_\xi \kappa = \xi^b \nabla_b \kappa = 0 \\ &= 0 \end{aligned}$$

so k is the affinely parameterised null geodesic tangent, generators of Σ ,

and $k^a = \frac{dx^a}{d\lambda}$, $\xi^a = \frac{dx^a}{dv} = \frac{dx^a}{d\lambda} \frac{d\lambda}{dv}$
 $\Rightarrow \frac{d\lambda}{dv} \propto e^{\kappa v} \Rightarrow \kappa \neq 0, \lambda \propto e^{\kappa v}$

Since ξ^a hypersurface \perp at Σ , we can use Frobenius Theorem on Σ

$$\begin{aligned}\xi_{[a}\nabla_b\xi_{c]} &= 0 \\ &= \frac{1}{3}(\xi_a\nabla_{[b}\xi_{c]} + \xi_b\nabla_{[c}\xi_a] + \xi_c\nabla_{[a}\xi_b])\end{aligned}$$

and Killing Eq.

$$\Rightarrow \begin{cases} \nabla_{[a}\xi_{b]} = \nabla_a\xi_b \\ \nabla_a\xi_b = -\nabla_b\xi_a \end{cases}$$

$$\begin{aligned}\Leftrightarrow \xi_c\nabla_a\xi_b &= -\xi_a\nabla_b\xi_c - \xi_b\overbrace{\nabla_c\xi_a}^{-\nabla_a\xi_c} \\ &= (\xi_b\nabla_a - \xi_a\nabla_b)\xi_c \\ &= -2\xi_{[a}\nabla_{b]}\xi_c\end{aligned}$$

Contracting with $\nabla^{[a}\xi^{b]} = \nabla^a\xi^b$

$$\begin{aligned}\xi_c\nabla^a\xi^b\nabla_a\xi_b &= -2(\nabla^a\xi^b)\xi_a\nabla_b\xi_c \\ &= -2\underbrace{(\xi_a\nabla^a\xi^b)}_{\text{geodesic}}(\nabla_b\xi_c) \\ &= -2\underbrace{\kappa\xi^b\nabla_b\xi_c} \\ &= -2\kappa^2\xi_c \\ \Rightarrow \kappa^2 &= -\frac{1}{2}(\nabla^a\xi^b)(\nabla_a\xi_b) \text{ Surface Gravity}\end{aligned}$$

Contracting the Frobenius tensor we get

$$\begin{aligned}f &= 3\xi^{[a}\nabla^b\xi^{c]}\xi_{[a}\nabla_b\xi_{c]} = \xi^{[a}\nabla^b\xi^{c]}(\xi_a\nabla_{[b}\xi_{c]} + \xi_b\nabla_{[c}\xi_a] + \xi_c\nabla_{[a}\xi_b]) \\ &= \frac{1}{3}\left[\begin{aligned} &3\xi^a\xi_a(\nabla^b\xi^c)(\nabla_b\xi_c) + (\xi^a\nabla^b\xi^c)\xi_b\overbrace{\nabla_c\xi_a}^{-\nabla_a\xi_c} + \xi^a\overbrace{\nabla^b\xi^c}^{-\nabla^c\xi^b}(\xi_c\nabla_a\xi_b) \\ &+ \xi^b\overbrace{\nabla^c\xi^a}^{-\nabla^a\xi^c}(\xi_a\nabla_b\xi_c) + (\xi^b\nabla^c\xi^a)\xi_c\overbrace{\nabla_a\xi_b}^{-\nabla_b\xi_a} \\ &(\xi^c\nabla^a\xi^b)\xi_a\overbrace{\nabla_b\xi_c}^{-\nabla_c\xi_b} + \xi^c\overbrace{\nabla^a\xi^b}^{-\nabla^b\xi^a}(\xi_b\nabla_c\xi_a) \end{aligned} \right] \\ &= \xi^a\xi_a(\nabla^b\xi^c)(\nabla_b\xi_c) - 2(\xi^a\nabla_a\xi_c)(\xi_b\nabla^b\xi^c)\end{aligned}$$

and since it is using Frobenius tensor, $f \xrightarrow{\Sigma} 0$

Since $g = \xi^a \xi_a \xrightarrow{\Sigma} 0$ and $\nabla_b (\xi^a \xi_a) = -2\kappa \xi_b \neq 0$ at Σ and

$$\begin{aligned}\nabla f &= 3\nabla (Frob^{abc} Frob_{abc}) \\ &= 6Frob^{abc} \nabla Frob_{abc} = 0 \text{ at } \Sigma\end{aligned}$$

we can apply l'Hospital rule to get

$$\begin{aligned}\lim_{\Sigma} \frac{f}{g} &= \lim_{\Sigma} \frac{\nabla f}{\nabla g} \\ &= 0 \\ &= \lim_{\Sigma} [(\nabla^b \xi^c) (\nabla_b \xi_c)] - 2 \lim_{\Sigma} [(\xi^a \nabla_a \xi_c) (\xi_b \nabla^b \xi^c) / \xi^d \xi_d] \\ &= -2\kappa^2 - 2 \lim_{\Sigma} \left[\frac{(\xi^a \nabla_a \xi_c) (\xi_b \nabla^b \xi^c)}{\xi^d \xi_d} \right] \\ \Leftrightarrow \kappa^2 &= \lim_{\Sigma} \left[-\frac{(\xi^a \nabla_a \xi_c) (\xi_b \nabla^b \xi^c)}{\xi^d \xi_d} \right]\end{aligned}$$

Away from Σ , ξ^a timelike, and we can define

$$\frac{\xi^a}{\sqrt{-\xi^b \xi_b}} = u^a = \frac{dx^a}{d\tau}$$

ξ proportional to time orbit velocity

Thus acceleration

$$\begin{aligned}a^a &= \frac{d^2 x^a}{d\tau^2} = \frac{du^a}{d\tau} = u^b \nabla_b u^a \\ &= \frac{\xi^b \nabla_b \xi^a}{(-\xi^c \xi_c)}\end{aligned}$$

and thus

$$\begin{aligned}\kappa &= \lim_{\Sigma} \sqrt{\frac{(\xi^a \nabla_a \xi_c) (\xi_b \nabla^b \xi^c)}{-\xi^d \xi_d}} = \lim_{\Sigma} \sqrt{a_c a^c (-\xi^c \xi_c)} \\ &= \lim_{\Sigma} (aV)\end{aligned}$$

defining

$$\begin{aligned}a &= \sqrt{a_c a^c} \\ V &= \sqrt{-\xi^c \xi_c}\end{aligned}$$

Interpretation is clear in static, asymptotically flat spacetimes, where $\xi = \partial_t$ and normalised $\xi^c \xi_c (r \rightarrow \infty) = -1$

Static observer has $u^a u_a = -1$ so $\xi^a = V(x) u^a$ and we regain $V = \sqrt{-\xi^c \xi_c}$ going from 0 at Σ to 1 at $r \rightarrow \infty$

Then acceleration, in general, is

$$\begin{aligned}
a^a &= u^b \nabla_b u^a \\
&= u^b \nabla_b (V^{-1} \xi^a) \\
&= V^{-1} u^b \underbrace{\nabla_b \xi^a}_{-\nabla^a \xi_b \text{ Killing Eqs}} + u^b \xi^a \nabla_b V^{-1} \\
&= -V^{-2} \nabla^a \left(\frac{\xi^b \xi_b}{2} \right) - V^{-1} u^b u^a \nabla_b V \\
&= V^{-2} \nabla^a \left(\frac{V^2}{2} \right) - u^b u^a \nabla_b \ln V \\
&= V^{-1} \nabla^a V - u^b u^a \nabla_b \ln V \\
&= \nabla^a \ln V - u^b u^a \nabla_b \ln V
\end{aligned}$$

but

$$\begin{aligned}
a^a u_a &= \frac{du^a}{d\tau} u_a = \frac{du^a u_a}{d\tau} = 0 \\
&= u_a \nabla^a \ln V + u^b \nabla_b \ln V \\
&= 2u_a \nabla^a \ln V \\
\Rightarrow a^a &= \nabla^a \ln V
\end{aligned}$$

Thus the force on a mass m is

$$F = ma = m \sqrt{a_c a^c} = V^{-1} m \sqrt{\nabla^c V \nabla_c V}$$

In the case $\xi = \partial_t$ (static spacetime), energy of a photon with p^a is

$$E = -p^a \xi_a$$

while its frequency, measured by an observer u^a gives

$$\omega = -p^a u_a \Rightarrow \omega = \frac{E}{V}$$

so photons emitted at $\lambda_1 = \frac{2\pi}{\omega_1}$ are received at $\lambda_2 = \frac{V_2}{V_1} \lambda_1$ thus at ∞ : $\lambda_\infty = \frac{\lambda_1}{V_1}$;
 V is redshift seen at ∞

So

$$VF = m \sqrt{\nabla^c V \nabla_c V} = maV$$

the force as measured at ∞

So acceleration at Σ as measured at ∞ is

$$\lim_{\Sigma} (aV) = \kappa$$

In the case only stationary, $K = \partial_t$ is null at ergosurface but $\xi = K + \Omega_H \partial_\theta$ (rotating BH) is the Killing vector and $\xi^a \xi_a = 0$ on E.H.

If we use Schwarzschild

$$ds^2 = - \left(1 - \frac{2GM}{r}\right) dt^2 + \frac{dr^2}{1 - \frac{2GM}{r}} + r^2 d\Omega^2$$

$\xi^a = K^a = (1, \vec{0})$ and static velocity is defined by

$$\begin{aligned} g_{ab} u^a u^b &= -1 = g_{ab} \frac{\xi^a \xi^b}{V^2} \Rightarrow -\frac{\left(1 - \frac{2GM}{r}\right)}{V^2} = -1 \\ \Leftrightarrow V &= \sqrt{1 - \frac{2GM}{r}} \\ \Rightarrow u^a &= \left(\left(1 - \frac{2GM}{r}\right)^{-\frac{1}{2}}, \vec{0} \right) \end{aligned}$$

Thus the acceleration reads

$$a^a = \nabla^a \ln V = \frac{2}{2} \frac{GM}{r^2} \frac{\nabla^a r}{1 - \frac{2GM}{r}} = \frac{GM \nabla^a r}{r^2 \left(1 - \frac{2GM}{r}\right)}$$

but $\nabla^a r = g^{ab} \delta_b^r$

$$\begin{aligned} \Rightarrow a &= \frac{GM}{r^2 \left(1 - \frac{2GM}{r}\right)} \sqrt{g^{ab} \delta_a^r \delta_b^r} = \frac{GM}{r^2 \left(1 - \frac{2GM}{r}\right)} \sqrt{1 - \frac{2GM}{r}} = \frac{GM}{r^2 \sqrt{1 - \frac{2GM}{r}}} = \frac{GM}{V r^2} \\ \Rightarrow \kappa &= \lim_{\Sigma} (aV) = \lim_{r \rightarrow 2GM} (aV) = \frac{GM}{(2GM)^2} = \frac{1}{4GM} \end{aligned}$$

$\kappa \searrow$ with M as $r_H \nearrow$

5.2 Singularity theorems

Singularities, under generic conditions, are inevitable in General Relativity, as given by the Big Bang types and Black Hole types theorems.

Here we will see 2 Big Bang types and 2 B.H. types theorems with various strengthes of hypotheses. We will sketch some proofs and start with definitions and lemmas.

5.2.1 First Big Bang Singularity theorem

5.2.1.1 Definitions

Definition 5.4. Causal curve

$$\gamma(\tau) \text{ causal curve} \Leftrightarrow \forall \tau, \dot{\gamma}^2 \leq 0$$

Definition 5.5. Causal future (recall)

$$J^+(p) = \left\{ q \in M \mid \exists \lambda, \forall \tau, \dot{\lambda}^2 \leq 0, \lambda(0) = p, \lambda(1) = q \right\}$$

(related to set of future directed causal curves from p)

Definition 5.6. Chronological future

$$I^+(p) = \left\{ q \in M \mid \exists \lambda, \forall \tau, \dot{\lambda}^2 < 0, \lambda(0) = p, \lambda(1) = q \right\}$$

(related to set of future directed timelike curves from p)

Thus $J^+(p) - I^+(p) = \{q \in M \mid \exists \gamma, \text{ null geodesic}, \lambda(0) = p, \lambda(1) = q\}$: future light cone of p

Similarly for a set $S \subset M$

Definition 5.7. Causal or chronological futures of a set S

$$J^+(S) = \bigcup_{q \in S} J^+(q) \quad I^+(S) = \bigcup_{q \in S} I^+(q)$$

Definition 5.8. Causal or chronological pasts of an event p or a set S

$$J^-(p) = \left\{ q \in M \mid \exists \lambda, \forall \tau, \dot{\lambda}^2 \leq 0, \lambda(0) = q, \lambda(1) = p \right\} \quad I^-(p) = \left\{ q \in M \mid \exists \lambda, \forall \tau, \dot{\lambda}^2 < 0, \lambda(0) = q, \lambda(1) = p \right\}$$

$$J^-(S) = \bigcup_{q \in S} J^-(q) \quad I^-(S) = \bigcup_{q \in S} I^-(q)$$

Definition 5.9. Causally or chronologically connected parts of M to S

$$J(S) = J^+(S) \cup J^-(S)$$

$$I(S) = I^+(S) \cup I^-(S)$$

Definition 5.10. Achronal Set

S achronal $\Leftrightarrow I^+(S) \cap S = \emptyset$: no point in the future of another point

Generated by spacelike or null curves

Definition 5.11. Cauchy surface

A closed achronal surface Σ with $J^+(\Sigma) \cup J^-(\Sigma) = M$ is called a Cauchy surface

All M events can be causally connected to Σ

Definition 5.12. Globally hyperbolic spacetime

(M, g_{ab}) globally hyperbolic $\Leftrightarrow \exists \Sigma \subset M, \Sigma$ Cauchy

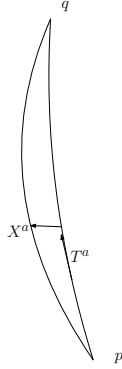

Figure 5.2.1: Conjugate points and Jacobi field

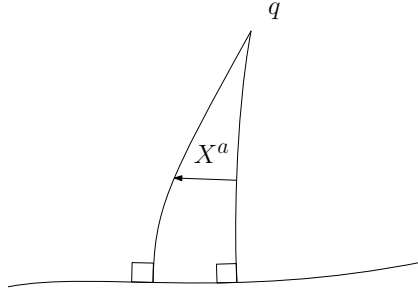

Figure 5.2.2: Conjugate point to a surface and Jacobi field

Definition 5.13. Conjugate points

$\gamma \subset M$, geodesic, $\dot{\gamma} = T$,

X^a solution of geodesic deviation equation

$$T^c \nabla_c (T^b \nabla_b X^a) = R^a{}_{bcd} T^b T^c X^d$$

is called a Jacobi field

$p, q \in M, (p, q)$ conjugates $\Leftrightarrow \exists X^a$ Jacobi field, $X^a \neq 0, X^a(p) = X^a(q) = 0$

See Fig. 5.2.1

Definition 5.14. Point conjugate to a surface

$p \in M, \Sigma \subset M, p \in \gamma$ geodesic, $\gamma \perp \Sigma$ (i.e. $T^a \propto g^{ab} \partial_b \Sigma$)

p conjugate to $\Sigma \Leftrightarrow \exists X^a$ Jacobi field of $\gamma, X^a(\Sigma) \neq 0, X^a \perp g^{ab} \partial_b \Sigma, X^a(p) = 0$

See Fig. 5.2.2

Definition 5.15. Normal neighbourhood

$U \subset M$, normal $\Leftrightarrow \forall q, r \in U, r \in J^+(q), \exists ! \gamma$ geodesic, $\dot{\gamma}^2 \leq 0, \gamma \subset U, \gamma(0) = q, \gamma(1) = r$

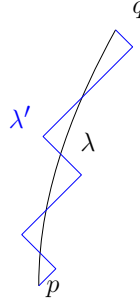

Figure 5.2.3: Illustration of upper semicontinuity

Definition 5.16. Strongly causal spacetime

$$(M, g_{ab}) \text{ strongly causal} \Leftrightarrow \forall p \in M, \quad \forall O(p) \subset M \text{ (neighbourhood)}$$

$$\exists V(p) \subset O(p), \forall \gamma \text{ causal curve, } \exists! \gamma_1, \gamma \cap V = \gamma_1$$

(γ only intersects V once)

(\Rightarrow foliation with causal curve families)

Definition 5.17. Spaces of causal curves

$C(p, q)$, from p to q , or $C(\Sigma, q)$ from Σ to q , are defined as the sets of continuous, future directed causal curves from $\left| \begin{array}{c} p \\ \Sigma \end{array} \right.$ to q .

Property: M globally hyperbolic $\Rightarrow C(\cdot, q)$ compact (“closed” and “bounded”)

Definition 5.18. Length of causal curves

$$\lambda(t) \in C^0, \text{ causal curve, } \dot{\lambda} = T^a \partial_a = \partial_t^a \partial_a, \tau[\lambda] = \int_p^q (-T^a T_a)^{\frac{1}{2}} dt$$

Definition 5.19. Upper semi-continuity of τ

$$\tau \text{ upper semi-continuous on } C(p, q)$$

$$\Leftrightarrow \forall \lambda \in C(p, q), \forall \epsilon > 0 \quad \exists O(\lambda) \subset C(p, q) \text{ (open neighbourhood)}$$

$$\forall \lambda' \in O(\lambda), \tau[\lambda'] \leq \tau[\lambda] + \epsilon$$

Illustration λ' null by parts (segments):

$$\tau[\lambda'] = 0$$

$$\tau[\lambda] = \tau > 0$$

See Fig. 5.2.3

5.2.1.2 Lemmas

Lemma 5.1. *Upper semicontinuity*

(M, g_{ab}) strongly causal, $p, q \in M, q \in J^+(p) \Rightarrow \tau$ upper semi-continuous on $C(p, q)$

Lemma 5.2. *Property geodesic and τ*
 γ geodesic $\Leftrightarrow \gamma$ extremises τ

Lemma 5.3. *Existence of conjugate to Σ in finite τ*

(M, g_{ab}) satisfies S.E.C., Σ spacelike hypersurface with $K = \Theta < 0$ at $q \in \Sigma$
 $(K$ trace of extrinsic curvature for future normal geodesics to Σ
 $\Rightarrow \exists p$ conjugate to Σ along $\gamma \perp \Sigma, q \in \gamma$ within $\tau[\gamma_{qp}] \leq \frac{3}{|K|}$

Proof. We saw from Raychaudhuri equation for S.E.C., hypersurface \perp , geodesic congruences (see Sec. 4.3.1.4) that they converge in finite proper time $\tau \leq \frac{3}{(-\Theta_0)} = \frac{3}{|K|}$ and here it is the condition on $q \in \Sigma$, note that $X^a(p) = 0 \Leftrightarrow \Theta(p) = -\infty$

Hence the condition being valid for $q \in \Sigma$ ($K = \Theta < 0$ with $\gamma \perp \Sigma$)
 $\Rightarrow p$ exists. \square

Lemma 5.4. *Geodesics with no inner conjugates maximise τ*

$\gamma \in C(p, q), \gamma$ smooth timelike

$\{\lambda_\alpha(t)\} \subset C(p, q)$, smooth, one parameter family of smooth timelike curves

$$\lambda_\alpha(a) = p, \quad \lambda_\alpha(b) = q, \quad \lambda_0 = \gamma$$

γ maximises $\tau[\lambda_\alpha] \Leftrightarrow \gamma$ geodesic with no conjugate point between p and q

Proof. Sketch of proof

$\lambda_0 = \gamma, (\partial_t)^a = T^a, (\partial_\alpha)^a = X^a, \mathcal{L}_T X^a = T^b \nabla_b X^a - X^b \nabla_b T^a = 0$ by commutation

$\forall \alpha, \left. \begin{array}{l} q = \lambda_\alpha(b) \\ p = \lambda_\alpha(a) \end{array} \right\} \Rightarrow X^a(a) = X^a(b) = 0; \text{ define } \tau(\alpha) = \tau[\lambda_\alpha] = \int_a^b f(\alpha, t) dt = \int_a^b (-T^a T_a)^{\frac{1}{2}} dt$

Calculate

$$\begin{aligned} \frac{d\tau}{d\alpha} &= \int_a^b \partial_\alpha f dt = \int_a^b X^a \nabla_a (-T^b T_b)^{\frac{1}{2}} dt \\ &= - \int_a^b \frac{X^a T^b}{f} \nabla_a T_b dt \\ &= - \int_a^b \frac{T^a T^b}{f} \nabla_a X_b dt \text{ by commutation} \\ &= - \int_a^b T^a \nabla_a \left(\frac{T^b X_b}{f} \right) dt + \int_a^b T^a X_b \nabla_a \left(\frac{T^b}{f} \right) dt \\ &= - \int_a^b \partial_t \left(\frac{T^b X_b}{f} \right) dt + \int_a^b T^a X_b \nabla_a \left(\frac{T^b}{f} \right) dt \\ &= \left[-\frac{T^b X_b}{f} \right]_a^b + \int_a^b T^a X^b \nabla_a \left(\frac{T_b}{f} \right) dt \end{aligned}$$

The boundary terms vanish as $X^a(a) = X^a(b) = 0$

$$\Rightarrow \frac{d\tau}{d\alpha} = \int_a^b X^b T^a \nabla_a \left(\frac{T_b}{f} \right) dt$$

but $T^a \nabla_a \left(\frac{T_b}{\sqrt{-T^c T_c}} \right)$ is geodesic equation for arbitrary param.

$$\text{So } \left. \frac{d\tau}{d\alpha} \right|_{\alpha=0} = 0 \Leftrightarrow \gamma \text{ geodesic } (\gamma \text{ geodesic locally maximises } \tau)$$

$$(\lambda_0 = \gamma)$$

Now compute

$$\begin{aligned} \frac{d^2\tau}{d\alpha^2} &= \int_a^b X^c \nabla_c \left[X^b T^a \nabla_a \left(\frac{T_b}{f} \right) \right] dt \\ &= \int_a^b (X^c \nabla_c X^b) T^a \nabla_a \left(\frac{T_b}{f} \right) dt + \int_a^b X^b (X^c \nabla_c T^a) \nabla_a \left(\frac{T_b}{f} \right) dt \\ &\quad + \int_a^b X^b T^a X^c \nabla_c \nabla_a \left(\frac{T_b}{f} \right) dt \end{aligned}$$

At $\alpha = 0$, λ_0 geodesic $\left(T^a \nabla_a \left(\frac{T_b}{f} \right) = 0 \right)$ and using Ricci identity, commutation of X and T and relabeling dummy indices

$$\begin{aligned} \left. \frac{d^2\tau}{d\alpha^2} \right|_{\alpha=0} &= \int_a^b X^b (T^c \nabla_c X^a) \nabla_a \left(\frac{T_b}{f} \right) dt + \int_a^b X^b T^a X^c \nabla_a \nabla_c \left(\frac{T_b}{f} \right) dt \\ &\quad + \int_a^b X^b T^a X^c R_{cab}{}^d \frac{T_d}{f} dt \quad \text{Ricci} \\ &= \int_a^b X^b T^c \nabla_c \left[X^a \nabla_a \left(\frac{T_b}{f} \right) \right] dt + \int_a^b X^b T^a X^c R_{cab}{}^d \frac{T_d}{f} dt \quad \text{relabeling} \end{aligned}$$

We can reexpress

$$\begin{aligned} \left[X^a \nabla_a \left(\frac{T_b}{f} \right) \right] &= \frac{X^a}{f} \nabla_a T_b - \frac{T_b}{f^2} X^a \nabla_a f \\ &= \frac{T^a}{f} \nabla_a X_b - \frac{T_b}{f^2} X^a \nabla_a (-T^c T_c)^{\frac{1}{2}} \quad \text{commuting} \\ &= \frac{T^a}{f} \nabla_a X_b + \frac{T_b}{f^2} X^a \frac{T^c}{f} \nabla_a T_c \\ &= \frac{T^a}{f} \nabla_a X_b + \frac{T_b}{f^2} \frac{T^c}{f} (T^a \nabla_a X_c) \quad \text{commuting} \\ &= \frac{T^a}{f} \nabla_a X_b + \frac{T_b}{f^2} \left[T^a \nabla_a \left(\frac{T^c X_c}{f} \right) - \underbrace{X_c T^a \nabla_a \left(\frac{T^c}{f} \right)}_{\text{geodesic at } \alpha=0} \right] \\ &= \frac{T^a}{f} \nabla_a X_b + \frac{T_b}{f^2} T^a \nabla_a \left(\frac{T^c X_c}{f} \right) \end{aligned}$$

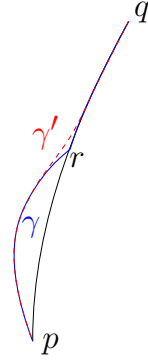

Figure 5.2.4: Smoothing from geodesic with inner conjugate

choosing in addition $f = 1$ along λ_0 , geodesic by affine parameterisation, and $T \perp X$: $T^c X_c = 0$ along λ_0 , we get, relabeling dummy indices

$$\left. \frac{d^2 \tau}{d\alpha^2} \right|_{\alpha=0} = \int_a^b X^a \{ T^c \nabla_c [T^b \nabla_b X_a] + R_{cbad} T^b T^d X^c \} dt$$

The Riemann term can be rewritten

$$\begin{aligned} R_{cbad} T^b T^d X^c &= R_{adcb} T^b T^d X^c && \text{Riemann symmetry} \\ &\rightarrow R_{bcd}^a T^b T^d X^c && \text{relabeling } b \leftrightarrow d \\ &\rightarrow -R_{bdc}^a T^b T^d X^c && \text{Riemann antisymmetry} \end{aligned}$$

We recognise the operator that gives 0 on Jacobi fields: $\mathcal{O}X = 0$

$$\Rightarrow \left. \frac{d^2 \tau}{d\alpha^2} \right|_{\alpha=0} = \int_a^b X_a \mathcal{O}X^a dt$$

If $\lambda_0 = \gamma$ geodesic with conjugate point r between p and q

$\Rightarrow \exists X_0^a \neq 0, \mathcal{O}X_0^a = 0, X_0^a(p) = X_0^a(r) = 0$, taking $X_0^a = 0$ between r and q

then smoothing of the r point into γ' yields $\gamma' - \gamma : X = X_0 + \epsilon$ (see Fig. 5.2.4) since $\left. \begin{array}{l} \dot{\epsilon}^a \epsilon_a = 0 \\ \ddot{\epsilon}^a \dot{\epsilon}_a = 0 \end{array} \right\}$ we take $\ddot{\epsilon}^a = \kappa \epsilon^a, \kappa > 0$ when ϵ grows (before r)

$$RTT\epsilon\epsilon \ll 1 \Rightarrow R_{bcd}^a T^b T^c \epsilon^d \epsilon_a = 0 \Rightarrow R_{bcc}^a T^b T^c \epsilon^d \propto \dot{\epsilon}^a$$

since smoothing is infinitesimal, $\epsilon^a \epsilon_a \gg \dot{\epsilon}^a \dot{\epsilon}_a$ for most of the part where $\epsilon \neq 0$, and $\mathcal{O}X^a = \mathcal{O}X_0^a + \mathcal{O}\epsilon^a \simeq \kappa \epsilon^a$

Thus to first order $X_a \mathcal{O}X^a \simeq X_a \kappa \epsilon^a \simeq \kappa X_0^a \epsilon_a \neq 0$ before r , thus when $\kappa > 0$

Since this is growing phase for ϵ then X_0, ϵ in same direction, then $X_0^a \epsilon_a > 0$ and thus $\left. \frac{d^2 \tau}{d\alpha^2} \right|_{\alpha=0} > 0$ and so $\tau[\gamma'] > \tau[\gamma] = \max \tau$: contradiction!

Conversely, γ geodesic without conjugate point between p and q with T^a tangent. Introduce orthonormal basis $\perp T^a : (e_\mu^a)$ parallelly propagated along γ ($T^b \nabla_b e_\mu^a = 0 = \frac{de_\mu^a}{d\tau}$), choosing $X^a T_a = 0$
 $X^a = X^\mu e_\mu^a$ verify geodesic deviation

$$\begin{aligned} \frac{dX^a}{d\tau} &= \frac{dX^\mu}{d\tau} e_\mu^a + X^\mu \frac{de_\mu^a}{d\tau} = \frac{dX^\mu}{d\tau} e_\mu^a \quad \text{parallel transport} \\ \Rightarrow \frac{d^2 X^a}{d\tau^2} &= \frac{d^2 X^\mu}{d\tau^2} e_\mu^a = R^a_{bc} T^b T^c X^d \\ &= e_\mu^a R^{\mu}_{bc\nu} e^\nu_d T^b T^c X^d \\ &= R^{\mu}_{bc\nu} T^b T^c X^\nu e_\mu^a \\ \Leftrightarrow \frac{d^2 X^\mu}{d\tau^2} &= R^{\mu}_{bc\nu} T^b T^c X^\nu \end{aligned}$$

since $X^\mu(\tau)$ depends linearly on initial data $X^\mu(0)$ and $\frac{dX^\mu}{d\tau}(0)$ where at p , $X^\mu(0) = X^\mu(p) = 0$

then $X^\mu(\tau) = A^\mu_\nu(\tau) \frac{dX^\mu}{d\tau}(0)$ with $A^\mu_\nu(0) = 0$, $\frac{dA^\mu_\nu}{d\tau}(0) = \delta^\mu_\nu$

q conjugate $\Leftrightarrow \exists \frac{dX^\mu}{d\tau}(0) \neq 0$ (non-trivial initial data), $X^\mu(q) = 0$

From $X^\mu = A^\mu_\nu \frac{dX^\mu}{d\tau}(0) \Leftrightarrow \det A(q) = 0$ Thus $\nexists r$ conjugate of p before $q \Leftrightarrow \forall r \in]p, q[, \det A(r) \neq 0$

Define $Y^\mu = (A^{-1})^\mu_\nu X^\nu \Leftrightarrow X^\mu = A^\mu_\nu Y^\nu$ (all possible initial conditions considered)

Thus

$$\frac{d^2 \tau}{d\alpha^2} \Big|_{\alpha=0} = \int_a^b e_\mu^a X^\mu (\mathcal{O} X)_\nu e^\nu_a d\tau = \int_a^b \delta^\mu_\nu X^\mu (\mathcal{O} X)_\nu d\tau = \int_a^b X^\mu (\mathcal{O} X)_\mu d\tau$$

and introducing $X^\mu = A^\mu_\nu \frac{dX^\mu}{d\tau}(0)$ in the geodesic deviation equation, we get

$$\frac{d^2 A^\mu_\nu}{d\tau^2} \frac{dX^\mu}{d\tau}(0) = R^{\mu}_{bc\beta} T^b T^c A^\beta_\nu \frac{dX^\mu}{d\tau}(0) \quad \Leftrightarrow \frac{d^2 A^\mu_\nu}{d\tau^2} = R^{\mu}_{bc\beta} T^b T^c A^\beta_\nu$$

and

$$\begin{aligned} (\mathcal{O} X)_\mu &= \frac{d^2 X_\mu}{d\tau^2} - R_{\mu bc\nu} T^b T^c X^\nu \\ &= \left(\frac{d^2 A_{\mu\nu}}{d\tau^2} - R_{\mu bc\beta} A^\beta_\nu \right) Y^\nu + 2 \frac{dA_{\mu\nu}}{d\tau} \frac{dY^\nu}{d\tau} + A_{\mu\nu} \frac{d^2 Y^\nu}{d\tau^2} \end{aligned}$$

so

$$\frac{d^2 \tau}{d\alpha^2} \Big|_{\alpha=0} = \int_a^b A^{\mu\alpha} Y_\alpha \left(2 \frac{dA_{\mu\beta}}{d\tau} \frac{dY^\beta}{d\tau} + A_{\mu\beta} \frac{d^2 Y^\beta}{d\tau^2} \right) d\tau$$

From [Hawking and Ellis(1973)] Proposition 4.5.8, this can be shown negative definite \Rightarrow any curve away from γ has $\tau < \tau[\gamma]$ \square

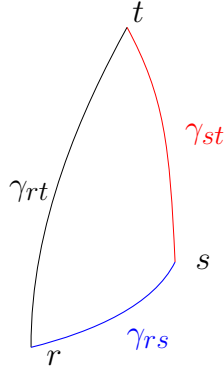

Figure 5.2.5: Piecewise vs Geodesic

Lemma 5.5. *Geodesics without inner conjugate to Σ maximise τ*

$p \in M, \forall q \in \Sigma$, smooth, spacelike hypersurface, $\gamma \in C(q, p)$, γ smooth, timelike

$\lambda_\alpha(t)$ smooth one parameter family of smooth timelike curves, $\{\lambda_\alpha(t)\} \subset C(q, p)$, $\lambda_\alpha(a) = q$, $\lambda_\alpha(b) = p$, $\lambda_0 = \gamma$

γ maximises $\tau[\lambda_\alpha] \Leftrightarrow \gamma$ geodesic $\perp \Sigma$ with no conjugate points between Σ and p

Proof. Similar to Lemma 5.4 (Geodesics with no inner conjugates maximise τ) \square

Lemma 5.6. *Maximum of τ on $C(\Sigma, p)$ is geodesics without inner conjugate to Σ*

(M, g_{ab}) strongly causal, $p \in M$, Σ achronal, smooth, spacelike hypersurface
 τ defined on $C(\Sigma, p)$

τ maximum on $\gamma \in C(\Sigma, p) \Rightarrow \gamma$ geodesic, $\perp \Sigma$ with no conjugate points between Σ and p

Proof. Sketch of proof

$\gamma \in C(\Sigma, p) \Rightarrow \gamma$ continuous

- If γ smooth, Lemma 5.5 (Geodesics without inner conjugate to Σ maximise τ) gives τ maximum on $\gamma \Leftrightarrow \gamma$ geodesic $\perp \Sigma$ without conjugate
- If γ not smooth: we are going to prove that any piecewise curve cannot have larger τ than a single smooth geodesic.

$\forall U$ convex normal neighbourhood

$r, s, t \in U$, $s \in J^+(r)$, $t \in J^+(r) \cap J^+(s)$, $\gamma_{rt}, \gamma_{rs}, \gamma_{st}$ geodesics with $\gamma \cap C(r, t) = \gamma_{rt}$ (see Fig. 5.2.5)

$$\tau[\gamma_{rt}] > \tau[\gamma_{rs}] + \tau[\gamma_{st}]$$

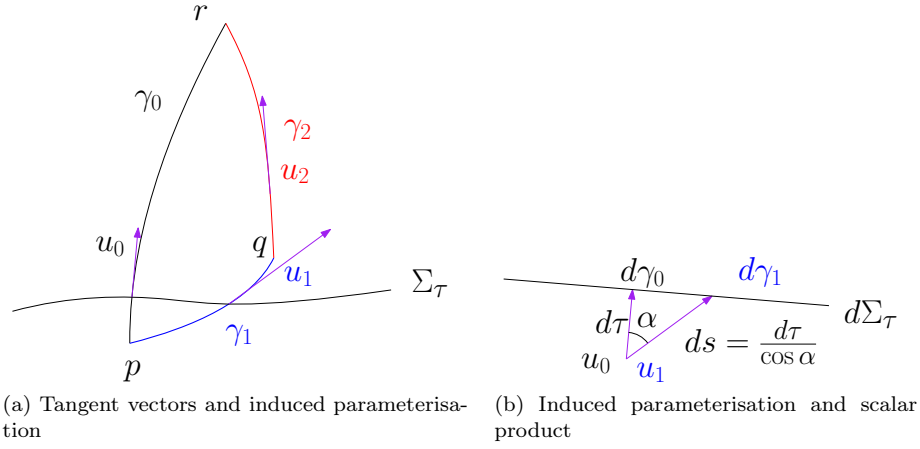

Figure 5.2.6: Proof of Piecewise vs Geodesic

Proof. that $\tau[\gamma_0] > \tau[\gamma_1] + \tau[\gamma_2]$ (see Fig. 5.2.6)

Use proper time on γ_0 parameterisation

Since U convex normal neighbourhood

$\exists \Sigma_\tau$ a family of hypersurfaces normal to $u_0 = \frac{dx}{d\tau} \Big|_{\gamma_0}$ inducing parameterisation on γ_1 and γ_2 (see Fig. 5.2.6a):

$$u_1 = \frac{dx}{d\tau_1} \Big|_{\gamma_1} \qquad u_2 = \frac{dx}{d\tau_2} \Big|_{\gamma_2}$$

From decomposition of any timelike vector into another normalised timelike vector and a spacelike vector, as in Sec. 4.3.1.3

$$\begin{aligned} u_1 &= (u_0 \cdot u_1) u_0 + \pi S_1 e \\ \text{with } \pi S_1 e &= u_1 - (u_0 \cdot u_1) u_0, \\ e \cdot e &= 1, \\ \pi S_1 &= \sqrt{\pi S_1 e \cdot \pi S_1 e} > 0 \end{aligned}$$

as u_0 and u_1 in same light cone with same parameter τ

$$|u_0 \cdot u_1| = -u_0 \cdot u_1 < 1$$

as (following Fig. 5.2.6b)

$$\begin{aligned} u_0^a &= \frac{dx^a}{d\tau} \Big|_{\gamma_0} \\ u_1^a &= \frac{dx^a}{ds} \Big|_{\gamma_1} = \frac{dx^a}{d\tau} \frac{d\tau}{ds} \Big|_{\gamma_1} \\ \Rightarrow |u_0 \cdot u_1| &= ||u_0| \cdot (|u_0| \cos \alpha) \cos \alpha| \\ &= \cos^2 \alpha < 1 \end{aligned}$$

Thus

$$\begin{aligned}\tau_1 &= \int_p^q \sqrt{-u_1 \cdot u_1} d\tau = \int_p^q \sqrt{(u_0 \cdot u_1)^2 - (\pi S_1)^2} d\tau \\ &\leq \int_p^q |u_0 \cdot u_1| d\tau \\ &< \int_p^q d\tau\end{aligned}$$

and samely

$$\tau_2 = \int_q^r \sqrt{-u_2 \cdot u_2} d\tau < \int_q^r d\tau$$

so

$$\tau_1 + \tau_2 < \int_p^q d\tau + \int_q^r d\tau = \tau_0$$

□

By upper semicontinuity, $\forall \mu \in C(r, t), \tau[\mu] \leq \tau[\gamma_{rt}]$

If $\tau[\mu] = \tau[\gamma_{rt}]$ with $\mu \neq \gamma_{rt}, \exists q \in \mu, q \notin \gamma_{rt}, \gamma_1, \gamma_2$ geodesics, $\gamma_1 = \gamma_{rs}, \gamma_2 = \gamma_{st}$

$$\left. \begin{array}{l} \gamma_1 \text{ maximises } \tau \text{ between } r \text{ and } s \\ \gamma_2 \text{ maximises } \tau \text{ between } s \text{ and } t \end{array} \right| \Rightarrow \tau[\gamma_1] + \tau[\gamma_2] \geq \tau[\mu] = \tau[\gamma_{rt}]$$

Contradiction!

$\Rightarrow \gamma$ unique curve, hence the result is proven

□

Lemma 5.7. *Existence of maximum τ causal curves*

(M, g_{ab}) globally hyperbolic, $p \in M$

$\Sigma \subset M$ Cauchy surface $\Rightarrow \exists \gamma \in C(\Sigma, p), \tau[\gamma]$ maximum on $C(\Sigma, p)$

Proof. Sketch of proof

$C(\Sigma, p)$ compact and from Lemma 5.1 (Upper semicontinuity)

τ is upper semi-continuous \Rightarrow maximum is attained inside $C(\Sigma, p)$

□

We are now ready to prove the first Big Bang Singularity theorem

5.2.1.3 First Big Bang Singularity theorem

Theorem 5.1. *Big Bang Singularity theorem 1*

(M, g_{ab}) globally hyperbolic with S.E.C.

Suppose $\exists \Sigma, C^2$ (smooth) Cauchy (initial) surface with $-\Theta \leq C < 0, C$ constant, everywhere on Σ (trace of extinsic curvature for past directed normal geodesic $K = -\Theta$)

Then $\forall \gamma \subset J^-(\Sigma), \dot{\gamma}^2 \leq 0, \tau = \int_{-\infty}^{\Sigma} \sqrt{-\dot{\gamma}^2} dt \leq \frac{3}{|C|}$

In particular: past directed timelike geodesics are incomplete

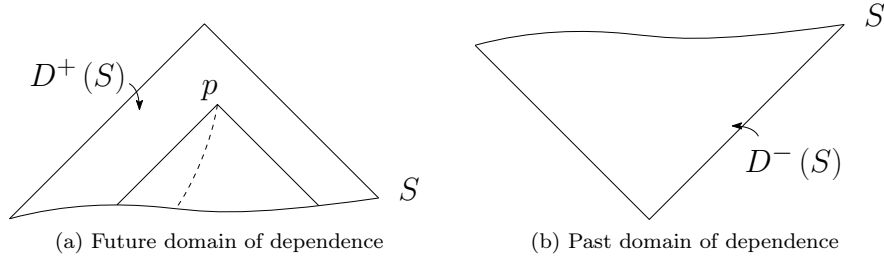

Figure 5.2.7: Domains of dependence

Proof. Suppose $\exists \lambda \subset J^-(\Sigma)$, $\dot{\lambda}^2 \leq 0$, $\tau = \int_{-\infty}^{\Sigma} \sqrt{-\dot{\lambda}^2} dt > \frac{3}{|C|}$

$$p = \lambda(t_1), \tau(p) \equiv \int_p^{\Sigma} \sqrt{-\dot{\lambda}^2} dt > \frac{3}{|C|} (\geq \frac{3}{\Theta})$$

From Lemma 5.7 (Existence of maximum τ causal curve) $\exists \gamma$ of maximum $\tau \geq \frac{3}{|C|}$

From Lemma 5.6 (Maximum of τ on $C(\Sigma, p)$ is geodesics without inner conjugate to Σ) γ geodesic $\perp \Sigma$ with no conjugate point

But from Lemma 5.3 (Existence of conjugate to Σ in finite τ) $\exists p, \tau(p) \leq \frac{3}{\Theta}$, conjugate to Σ

resulting in a contradiction, which proves the theorem \square

However the globally hyperbolic condition is very strong! Hawking (1967) found a weaker condition

5.2.2 More general Big Bang Singularity theorem

5.2.2.1 Definitions

Definition 5.20. Future endpoint of γ

$$p \in M \text{ future endpoint of } \gamma \Leftrightarrow \forall O(p) \subset M \text{ open, } \exists t_0, \forall t > t_0, \gamma(t) \in O(p)$$

Definition 5.21. Future inextendible curve γ

$$\gamma \text{ future inextendible curve} \Leftrightarrow \nexists \text{ future endpoint of } \gamma$$

Definition 5.22. Domain of dependence

Future

$$D^+(S) = \{p \in M | \forall \gamma, \text{ past inextendible causal, } \exists \tau_p, \gamma(\tau_p) = p, \gamma \cap S \neq \emptyset\}$$

(every past past inextendible causal curve through p intersects S , see Fig. 5.2.7a)

Past

$$D^-(S) = \{p \in M | \forall \gamma, \text{ future inextendible causal, } \exists \tau_p, \gamma(\tau_p) = p, \gamma \cap S \neq \emptyset\}$$

(see Fig. 5.2.7b)

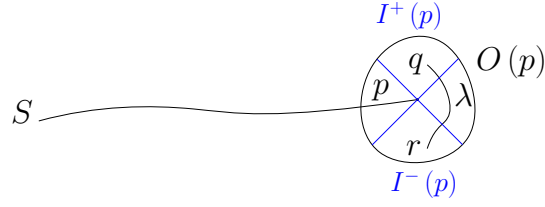

Figure 5.2.8: Edge of S

Full

$$D(S) = D^+(S) \cup D^-(S)$$

Definition 5.23. Interior of A

$$\text{Int}[A] = \bigcup_{\forall O \subset A} O$$

Union of all open sets contained in A

Definition 5.24. Closure of A

$$\bar{A} = A + \lim A = \bigcap_{\forall C \supset A} C$$

Intersection of all closed sets containing A

Definition 5.25. Boundary of A

$$\dot{A} = \partial A = \bar{A} - \text{Int}[A]$$

Definition 5.26. Edge of S

$$p \in \text{Edge}(S) \Leftrightarrow \forall O(p), \exists q \in I^+(p) \cap O(p), \exists r \in I^-(p) \cap O(p), \exists \lambda, \dot{\lambda}^2 < 0, \lambda \subset O(p), \\ \lambda(0) = r, \lambda(1) = q, \lambda \cap (S \cup \{p\}) = \emptyset$$

See Fig. 5.2.8

Definition 5.27. Cauchy Horizon

S closed, achronal

Future:

$$H^+(S) = \overline{D^+(S)} - I^-[D^+(S)]$$

(see Fig. 5.2.9)

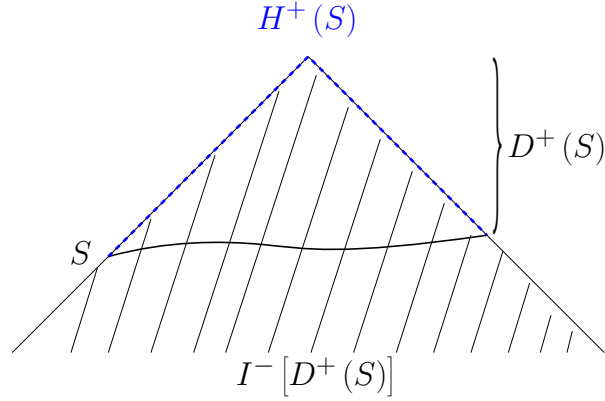

Figure 5.2.9: Future Cauchy Horizon

Past:

$$H^-(S) = \overline{D^-(S)} - I^+[D^-(S)]$$

Full:

$$H(S) = H^+(S) \cup H^-(S)$$

Property Cauchy horizons and geodesicsFuture Cauchy Horizon

$$H^+(S) = \left\{ p \in M \mid \exists \lambda, \dot{\lambda}^2 = 0 \text{ geodesic, } p \in \lambda, \lambda \subset H^+(S) \Leftrightarrow \lambda \left\{ \begin{array}{l} \text{past inextendible} \\ \text{or} \\ \text{with past endpoint on Edge}(S) \end{array} \right\} \right\}$$

Past Cauchy Horizon

$$H^-(S) = \left\{ p \in M \mid \exists \lambda, \dot{\lambda}^2 = 0 \text{ geodesic, } p \in \lambda, \lambda \subset H^-(S) \Leftrightarrow \lambda \left\{ \begin{array}{l} \text{future inextendible} \\ \text{or} \\ \text{with future endpoint on Edge}(S) \end{array} \right\} \right\}$$

5.2.2.2 Lemmas**Lemma 5.8.** *Cauchy horizon and domain of dependence* $H(S) = \dot{D}(S)$: full Cauchy horizon is boundary of domain of dependence**Lemma 5.9.** *Cauchy horizon decomposition* $\forall p \in H^\pm(S), p \in \lambda \subset H^\pm(S)$ λ either -past/future inextendible, or
-past/future endpoint \in Edge(S)**Lemma 5.10.** *Causal curves in compact submanifolds* (M, g_{ab}) strongly causal, $K \subset M$ compact $\Rightarrow (\forall \mathcal{C} \subset K, \mathcal{C}^2 \leq 0 \text{ (causal)} \Rightarrow \text{past and future endpoints of } \mathcal{C} \in K)$

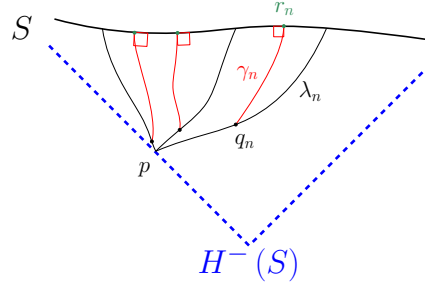

Figure 5.2.10: Sequence of timelike curves from S to p supporting geodesics converging to p .

5.2.2.3 More general Big Bang Singularity theorem

Theorem 5.2. *Big Bang Singularity theorem 2 (Hawking 1967, more general)*
 (M, g_{ab}) strongly causal with S.E.C.

Suppose $\exists S$ compact, edgeless, achronal, smooth spacelike hypersurface with $-\Theta \leq C < 0$ everywhere on S (trace of extinsic curvature for past directed normal geodesic $K = -\Theta$)

Then $\exists \gamma \subset J^-(S)$, $\dot{\gamma}^2 \leq 0$, γ inextendible geodesic and

$$\tau = \int_{-\infty}^S \sqrt{-\dot{\gamma}^2} dt \leq \frac{3}{|C|}$$

Proof. Sketch of proof

Suppose $\forall \gamma$, $\dot{\gamma}^2 \leq 0$, past directed inextendible geodesic $\perp S$ with $\tau[\gamma] > \frac{3}{|C|}$

$(\text{Int}[D(S)], g_{ab})$ globally hyperbolic (S : Cauchy surface of $\text{Int}[D(S)]$) by construction of $D(S)$)

Then it satisfies Theorem 5.1 $\Rightarrow \forall \gamma$ inextendible past directed geodesic, with $\dot{\gamma}^2 \leq 0$, it must leave $\text{Int}[D(S)]$ (as $\tau[\gamma|_{\text{Int}[D(S)]}] \leq \frac{3}{|C|}$)

As $H(S)$ is boundary of $D(S)$ from Lemma 5.8 (Cauchy horizon and domain of dependence), then they must intersect $H^-(S)$ before $\tau[\gamma_{Sq}] > \frac{3}{|C|} \Rightarrow H^-(S) \neq \emptyset$ as $H^-(S) = \dot{D}^-(S)$

$$\forall p \in H^-(S), \forall l \in C(S, p), \tau[l] \leq \frac{3}{|C|} \quad (5.3)$$

so $\exists \tau_0$, least upper bound of $\tau[l]$

$\{\lambda_n\}$ sequence of timelike curves from S to p , $\lim_{n \rightarrow \infty} \tau[\lambda_n] = \tau_0$

$q_n \in \lambda_n$, $q_n \neq p$, $\lim_{n \rightarrow \infty} q_n = p$, $q_n \in I^+(p) \Rightarrow q_n \in \text{Int}[D^-(S)]$ (as $q_n \leftrightarrow p$ by $\dot{\lambda}_n^2 < 0$)

From Lemma 5.7 (Existence of maximum τ causal curves)

$\exists \gamma_n \in C(S, q_n)$, $\tau[\gamma_n]$ maximum on $C(S, q_n)$, and Lemma 5.6 (existence of geodesics without inner conjugate to Σ) gives γ_n geodesic $\perp S$

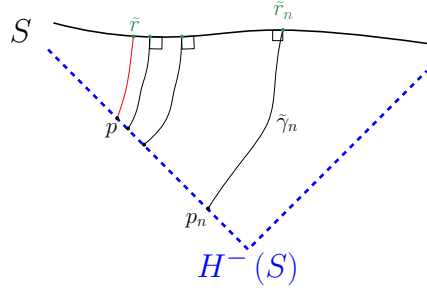

Figure 5.2.11: Sequence of geodesics from S to p_n converging to a geodesic from S to p .

Thus $\lim_{n \rightarrow \infty} \tau[\gamma_n] = \tau_0$ (see Fig. 5.2.10)

Naming $r_n = \gamma_n \cap S$; since S compact $\lim_{n \rightarrow \infty} r_n = r \in S$

$\exists \gamma$ geodesic $\perp S, r \in S \Rightarrow$ by continuity of r_n and of the \perp tangent vectors to γ_n : $\gamma \cap H^-(S) = p$ and $\tau[\gamma] = \lim_{n \rightarrow \infty} \tau[\gamma_n] = \tau_0$

Thus $\forall p \in H^-(S), \exists \gamma$ geodesic $\perp S, \tau[\gamma] = \tau_0$ least upper bound of τ over $C(S, p)$

$\{\tilde{\gamma}_n\}$ any sequence of geodesics $\perp S$, maximum length, to $p_n \in H^-(S)$

$\tilde{r}_n = S \cap \tilde{\gamma}_n$; since S compact $\lim_{n \rightarrow \infty} \tilde{r}_n = \tilde{r} \in S$

$\exists \tilde{\gamma}$ geodesic $\perp S, \tilde{r} \in \tilde{\gamma}, \tilde{\gamma} \cap H^-(S) = p$ (see Fig. 5.2.11)

By continuity of \tilde{r}_n and $\tilde{\gamma}_n, p$ accumulation point of $\{p_n\} \Rightarrow H^-(S)$ compact

Since $\text{Edge}(S) = \emptyset$, by Lemma 5.9 (Cauchy horizon decomposition) $\exists \gamma, \dot{\gamma}^2 = 0$ inextendible future geodesic, $\gamma \subset H^-(S)$

Since (M, g_{ab}) strongly causal and $H^-(S) \subset M$, compact

from Lemma 5.10 (Causal curves in compact submanifolds) $\forall \lambda$ causal, $\lambda \in H^-(S)$ must have past and future endpoints in $H^-(S)$, thus contradicting that γ is inextendible!

$\exists \gamma$ past inextendible, $\dot{\gamma}^2 \leq 0, \perp S, \tau[\gamma] < \frac{3}{|C|}$

At least γ , past directed timelike geodesic is incomplete □

Those theorems predict the existence of Big Bang (in a cosmological context). Next we deal with gravitational collapse with the first singularity theorem discovered by Penrose (1965)

5.2.3 First Black Hole Singularity theorem

5.2.3.1 Definitions

Definition 5.28. Length of a null curve

$$\gamma(\lambda), \dot{\gamma}^2 = 0, \lambda[\gamma] = \int_{\gamma} d\lambda$$

Definition 5.29. Time orientable manifolds

(M, g_{ab}) time orientable $\Leftrightarrow \exists t^a$ on M , smooth, non-vanishing, timelike vector field

Definition 5.30. Metric “opener”

In (M, g_{ab}) , $\exists t^a, t^a t_a < 0$, define $\tilde{g}_{ab} = g_{ab} - t_a t_b$

\tilde{g}_{ab} has Lorentz signature and light cones strictly larger than g_{ab} :

$$\forall l^a, l^a l_a = 0 \Rightarrow \tilde{g}_{ab} l^a l^b = l^a l_a - (t^a l_a)^2 = -(t^a l_a)^2 < 0$$

Thus if (M, g_{ab}) on verge of having timelike closed curves then (M, \tilde{g}_{ab}) contains timelike closed curves

Definition 5.31. Stably causal spacetime

(M, g_{ab}) stably causal $\Leftrightarrow \exists t^a, t^a t_a < 0$, continuous non-vanishing vector field, (M, \tilde{g}_{ab}) has no closed timelike curves

5.2.3.2 Lemmas

Lemma 5.11. Existence of conjugate to S in finite λ

(M, g_{ab}) with N.E.C., S smooth 2D spacelike submanifold with $\Theta_+(q) = \Theta_0 < 0, q \in S$ (outgoing null geodesic)

$$\Rightarrow \exists p \text{ conjugate to } S \text{ along } \mu(\lambda), \dot{\mu}^2 = 0, q \in \mu \text{ for } \lambda \leq \frac{2}{|\Theta_0|}$$

Proof. (by analogy to Lemma 5.3: Existence of conjugate to Σ in finite τ) \square

Lemma 5.12. Null geodesics with no inner conjugates to K

(M, g_{ab}) globally hyperbolic, K compact, orientable, 2D, spacelike, $K \subset M$
 $p \in \dot{I}^+(K) \Rightarrow \exists \mu, p \in \mu, \dot{\mu}^2 = 0$ future geodesic, $\mu \cap K \neq \emptyset, \mu \perp K$ with no conjugate between K and p

Proof. (by analogy to Lemma 5.4: Geodesics with no inner conjugates maximise τ) \square

Lemma 5.13. Globally hyperbolic time orientability

Globally hyperbolic spacetimes are time orientable

Lemma 5.14. Boundary of time orientable spacetime submanifold

(M, g_{ab}) time orientable, $S \subset M \Rightarrow \dot{I}^+(S)$ achronal, 3D, C^0 submanifold of M

See Fig. 5.2.12

Lemma 5.15. Topology of globally hyperbolic spacetimes

(M, g_{ab}) globally hyperbolic $\Rightarrow (M, g_{ab})$ stably causal

Furthermore, $\exists f$ global time function, $f = \text{cst}$: Cauchy surface $\Sigma \Rightarrow M$ foliated by Σ with topology of $\mathbb{R} \times \Sigma$

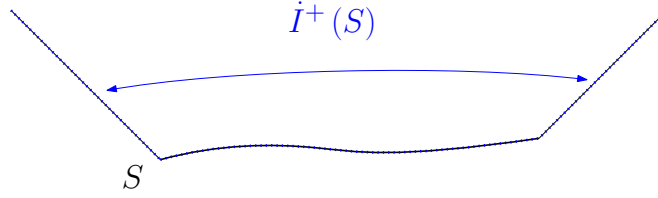

Figure 5.2.12: Boundary of time orientable spacetime submanifold chronological future.

5.2.3.3 First Black Hole Singularity theorem

Theorem 5.3. *Black Hole Singularity theorem 1 (Penrose 1965)*

(M, g_{ab}) connected, globally hyperbolic, with Σ non-compact Cauchy surface and N.E.C.

$\exists T \subset M$ trapped surface, $\Theta_0 < 0$ maximum of Θ_+ , Θ_- , outgoing and ingoing null geodesic expansions, each geodesic $\perp T$

$\Rightarrow \exists \gamma, \dot{\gamma}^2 = 0$ future inextendible $\perp T$ with affine length

$$\lambda[\gamma] \leq \frac{2}{|\Theta_0|}$$

Proof. Suppose $\forall \gamma, \dot{\gamma}^2 = 0$ future geodesic $\perp T$, and $\lambda[\gamma] \geq \frac{2}{|\Theta_0|}$

Then define the maps

$$\begin{aligned} f_+ : T \times \left[0; \frac{2}{|\Theta_0|}\right] &\longrightarrow M \\ q, a &\longrightarrow f_+(q, a) = \gamma_{\text{out}}(a), \\ \dot{\gamma}_{\text{out}}^2 &= 0, \gamma_{\text{out}} \perp T, \gamma_{\text{out}} \cap T = q \end{aligned}$$

$$\begin{aligned} f_- : T \times \left[0; \frac{2}{|\Theta_0|}\right] &\longrightarrow M \\ q, a &\longrightarrow f_-(q, a) = \gamma_{\text{in}}(a), \\ \dot{\gamma}_{\text{in}}^2 &= 0, \gamma_{\text{in}} \perp T, \gamma_{\text{in}} \cap T = q \end{aligned}$$

Since $\left[0; \frac{2}{|\Theta_0|}\right]$ compact and f_+, f_- continuous, then

$$A = f_+ \left\{ T \times \left[0; \frac{2}{|\Theta_0|}\right] \right\} \cup f_- \left\{ T \times \left[0; \frac{2}{|\Theta_0|}\right] \right\}$$

compact.

By Lemma 5.11 (Existence of conjugate to T in finite λ) and Lemma 5.12 (Null geodesics with no inner conjugates to K), $I^+(T)$, the boundary of future of T , is made of future null geodesic, hence in A

So $\dot{I}^+(T) \subset A$ and since $\dot{I}^+(T)$ closed $\Rightarrow \boxed{\dot{I}^+(T) \text{ compact}}$

Using Lemma 5.13 (Globally hyperbolic time orientability) and definition of time orientability, we define t^a smooth, $t^a t_a < 0$, on M

Since $\dot{I}^+(T)$ achronal (Lemma 5.14: Boundary of time orientable spacetime submanifold) i.e. the boundary of the future of T is spacelike, or null

$$\left[\left(\text{then } I^+(\dot{I}^+(T)) \neq \emptyset \Rightarrow I^+(\dot{I}^+(T)) \cap \dot{I}^+(T) = \emptyset \right)! \right]$$

$$\Rightarrow \forall \gamma \text{ integral curve of } t^a (\dot{\gamma} = t^a \partial_a), \gamma \cap \dot{I}^+(T) = \begin{cases} q \\ \text{or} \\ \emptyset \end{cases} \quad (\text{at most once})$$

while $\gamma \cap \Sigma = p$ by definition of Σ Cauchy

Define the map

$$\begin{aligned} \Psi : \dot{I}^+(T) &\longrightarrow \Sigma \\ \gamma(\tau_1) = q &\longrightarrow p = \gamma(\tau_0) \end{aligned}$$

$S \subset \Sigma, S = \Psi[\dot{I}^+(T)]$ with topology induced by Σ

Then $\bar{\Psi} = \Psi : \dot{I}^+(T) \longrightarrow S$ homeomorphism

$\dot{I}^+(T)$ compact $\Rightarrow S$ compact, with $S \subset \Sigma \Rightarrow S$ closed

$\dot{I}^+(T)$ is C^0 from Lemma 5.14, so $\forall q \in \dot{I}^+(T), \exists \mathcal{O}(q)$ homeomorphic to an open ball of \mathbb{R}^3

$\bar{\Psi}$ homeomorphism \Rightarrow same holds for S , hence S open

However since M connected, from Lemma 5.15 (Topology of globally hyperbolic spacetimes) Σ also connected

Therefore $\dot{I}^+(T) \neq \emptyset \Rightarrow S = \Sigma$: contradiction! as S compact and Σ non-compact

$$\Rightarrow \exists \gamma, \dot{\gamma}^2 = 0 \text{ future geodesic } \perp T, \lambda[\gamma] \leq \frac{2}{|\Theta_0|}$$

i.e. there exists at least one future null geodesic that is incomplete \square

Again, the global hyperbolicity hypothesis is very strong

Hawking and Penrose found a weaker condition that we just give here (for proof, see [Hawking and Ellis(1973)])

5.2.4 More general Big Bang and Black Hole Singularity theorem

5.2.4.1 Definitions

Definition 5.32. Timelike generic condition (T.G.C.)

(M, g_{ab}) satisfies timelike generic condition

$$\Leftrightarrow \forall \gamma \subset M, \xi^2 = \dot{\gamma}^2 < 0 \text{ geodesic, } \exists p \in \gamma, R_{abcd} \xi^a \xi^d(p) \neq 0$$

Definition 5.33. Null generic condition (N.G.C.)

(M, g_{ab}) satisfies null generic condition

$$\Leftrightarrow \forall \mu \subset M, k^2 = \dot{\mu}^2 = 0, \exists p \in \mu, k_{[e} R_{a]bc[d} k_{f]} k^b k^c(p) \neq 0$$

$$\left(\Leftrightarrow \begin{cases} R_{ab}k^ak^b(p) \neq 0 \\ \text{or} \\ k_{[e}C_{a]bc[d}k_{f]}k^bk^c(p) \neq 0 \end{cases} \right)$$

5.2.4.2 Lemmas

Lemma 5.16. *Existence of conjugates for complete geodesics with S.E.C.*

$$(M, g_{ab}) \text{ verifies } \begin{cases} S.E.C. \\ T.G.C. \end{cases} \Rightarrow (\forall \gamma, \dot{\gamma}^2 < 0 \text{ complete geodesic} \Rightarrow \exists p, q \in \gamma, p \neq q, X^a(p) = X^a(q) = 0 \text{ Jacobi field})$$

Lemma 5.17. *Existence of conjugates for complete null geodesics with N.E.C.*

$$(M, g_{ab}) \text{ verifies } \begin{cases} N.E.C. \\ N.G.C. \end{cases} \Rightarrow (\forall \mu, \dot{\mu}^2 = 0 \text{ complete geodesic} \Rightarrow \exists p, q \in \mu, p \neq q, X^a(p) = X^a(q) = 0 \text{ Jacobi field})$$

Now we have the tools to write the more general theorem

5.2.4.3 More general Big Bang and Black Hole Singularity theorem

Theorem 5.4. *Black Hole Singularity theorem 2 (Hawking and Penrose 1970) [Hawking and Ellis(1973), Theorem 2 p266]*

(M, g_{ab}) verifies

1. *S.E.C.*
2. *Timelike and Null generic conditions (and Lemmas 5.16 and 5.17)*
3. $\nexists \gamma, \dot{\gamma}^2 \leq 0, \gamma$ *closed (no closed causal curves)*
4. *At least one of*
 - (a) $\exists S \subset M, S$ *closed, achronal, Edge(S) = ∅ (M closed universe)*
 - (b) $\exists S \subset M, S$ *trapped surface*
 - (c) $\exists p \in M, \forall \lambda_\alpha \subset M, p \in \lambda_\alpha, \dot{\lambda}_\alpha^2 = 0$ *future (past) directed $\Theta_{\lambda_\alpha} < 0$*

$\Rightarrow \exists \gamma, \dot{\gamma}^2 < 0$ *or $\dot{\gamma}^2 = 0$ geodesic, γ incomplete*

This theorem actually can also be applied to B.B. singularities: our universe looks very much like an FLRW, almost flat ($k \simeq 0$) in our causal past, and seems to obey theorem 5.4 conditions 1-3 as well as 4c for past events p even after matter-radiation decoupling (past directed $\Theta < 0$). Normal matter is certainly obeying the S.E.C.

Maybe escaped with
 exotic matter?
 quantum gravity?
 bounce?

Chapter 6

Kerr Black Hole, Penrose Process and Black Hole Thermodynamics

6.1 Rotating Black Hole: Kerr-Newman

6.1.1 Metric of charged, rotating BH

[Kerr(1963)], [Newman *et al.*(1965)Newman, Couch, Chinnapared, Exton, Prakash, and Torrence]Axially symmetric stationary solutions to E.F.E. in vacuum result in

$$ds^2 = - \left(1 - \frac{C}{\rho^2}\right) dt^2 - \frac{Ca \sin^2 \theta}{\rho^2} (dt d\phi + d\phi dt) + \frac{\rho^2}{\Delta} dr^2 + \rho^2 d\theta^2 + \frac{\sin^2 \theta}{\rho^2} \left[(r^2 + a^2)^2 - \Delta a^2 \sin^2 \theta \right] d\phi^2 \quad (6.1)$$

$$\begin{aligned} \text{with } \rho^2(r, \theta) &= r^2 + a^2 \cos^2 \theta \\ C(r) &= 2GMr - G(e^2 + m^2) \end{aligned} \quad \begin{array}{l} \text{the BH charge decomposed into } \\ e : \text{ electric charge} \\ m : \text{ magnetic charge} \\ M : \text{ mass charge} \end{array}$$

$$\Delta(r) = r^2 + a^2 - C$$

6.1.2 Definitions of Charges

They are defined with

Theorem 6.1. *Stokestheorem*

M n dimensional manifold, ∂M its boundary

ω (n - 1)-form

$$\int_M d\omega = \int_{\partial M} \omega$$

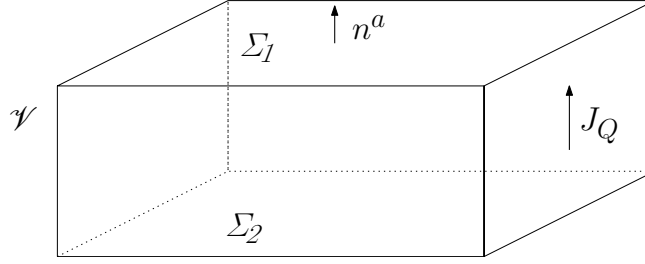

Figure 6.1.1: Volume to apply Stokes Theorem

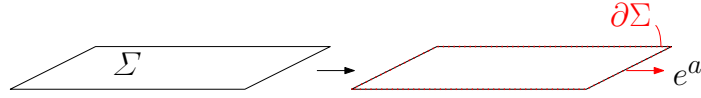

Figure 6.1.2: Iteration on a surface of Stokes theorem

There exists a 1-form $V, \omega = \star V$ using the Hodge dual, i.e. the volume n -form. $V = (-1)^{s+n-1} \star \omega$ s : signature

$$\omega_{a_1 \dots a_{n-1}} dx^{a_1} \dots dx^{a_{n-1}} = \eta_{b a_1 \dots a_{n-1}} V^b dx^{a_1} \dots dx^{a_{n-1}} \text{ and } d\omega = d \star V \Leftrightarrow$$

Corollary 6.1. *to Stokes theorem*

$$\int_M d^n x \sqrt{|g|} \nabla_a V^a = \int_{\partial M} d^{n-1} y \sqrt{|\gamma|} n_a V^a$$

where g metric on M

γ metric on ∂M

n^a normal to ∂M

so we define the charge on a hypersurface Σ of M as

$$\begin{aligned} Q &= - \int_{\Sigma} d^{n-1} y \sqrt{|\gamma|} n_a J_Q^a = - \int_{\Sigma} \star J_Q \\ &= - \int_{\partial \Sigma} d^{n-2} z \sqrt{|\gamma^{(\partial \Sigma)}|} n_a e_b S_Q^{ab} \\ &\text{where } J_Q^a = \nabla_b S_Q^{ab} \end{aligned}$$

using again Stokes for \mathcal{V} interior of Σ_1, Σ_2 and joining current lines (see Fig. 6.1.1; J_Q current vector conserved: $\nabla_a J_Q^a = 0 \Leftrightarrow d \star J_Q = 0$)

$$0 = \int_{\mathcal{V}} d \star J_Q = \int_{\partial \mathcal{V}} \star J_Q = \int_{\Sigma_1} \star J_Q - \int_{\Sigma_2} \star J_Q = Q_2 - Q_1$$

then (note $\mathcal{V} \neq M$) we apply Stokes again to get the result (see Fig. 6.1.2)

6.1.2.1 From conserved currents

For electric and magnetic charges, the conserved currents are

$$\begin{aligned} J_e^a &= \nabla_b F^{ab}, \text{ conserved as} & \nabla_{(a} \nabla_{b)} F^{[ab]} &= 0 = \nabla_a J_e^a \\ J_m^a &= \nabla_b \star F^{ab}, \text{ conserved as} & \nabla_{(a} \nabla_{b)} \star F^{[ab]} &= 0 = \nabla_a J_m^a \\ \text{with } \star F^{ab} &= \frac{1}{2} \eta^{abcd} F_{cd} \end{aligned}$$

that define the electric and magnetic charges

$$e = - \int_{\Sigma} d^{n-1} y \sqrt{|\gamma|} n_a \nabla_b F^{ab} = - \int_{\partial\Sigma} d^{n-2} z \sqrt{|\gamma^{(\partial\Sigma)}|} n_a e_b F^{ab}$$

(sending $\partial\Sigma$ at infinity ds^2 is Minkowski-like and we recover the correct sign)

$$m = - \int_{\partial\Sigma} d^{n-2} z \sqrt{|\gamma^{(\partial\Sigma)}|} n_a e_b \frac{1}{2} \eta^{abcd} F_{cd} = - \int_{\partial\Sigma} d^{n-2} z \sqrt{|\gamma^{(\partial\Sigma)}|} \frac{\eta^{ab} F_{ab}}{2}.$$

For the rest, unless specified, we set $e = m = 0$ but keep general charge C when its expression is not needed.

6.1.2.2 Killing vectors, conserved mass and spin

As the metric is independent of t, ϕ , it admits $K = \partial_t$ and $L = \partial_\phi$ as Killing vectors (recall definition in Sec. 3.2.1).

This is used to define

- the mass as Komar energy
- the spin $a = \frac{J}{GM}$ from J , Komar angular momentum

The conserved currents are based on the Ricci tensor

$J_{KR}^a = K_b R^{ab}$ for K the timelike Killing vector: Komar energy, valid for asymptotically flat spacetimes

J_{KR}^a conserved as

$$\begin{aligned} \nabla_a J_{KR}^a &= \underbrace{\nabla_{[a} K_{b]} R^{(ab)}}_{0 \text{ from Killing Eq.}} + \underbrace{K_b \nabla_a R^{ab}}_{0 \text{ from Bianchi Id.}} \\ &= 0 \end{aligned}$$

Proof. From Bianchi Id. $\nabla_a R^{ab} = \frac{1}{2} \nabla^b R$ so we need $K_b \nabla^b R \stackrel{?}{=} 0$

From the contracted Bianchi Id., we have $\nabla_{[a} R_{bc]}^{bc} = 0$

$$\Leftrightarrow K^a \nabla_a R + K^a \nabla_b R_{ca}{}^{bc} + K^a \nabla_c R_{ab}{}^{bc} = 0$$

$$\begin{aligned}
 \Leftrightarrow K^a \nabla_a R &= K^a \nabla_b R_{ac}{}^{bc} + K^a \nabla_c R_{ab}{}^{cb} \text{ (antisym. of Riemann)} \\
 &= 2K^a \nabla_b R_a{}^b \text{ (Riemann } \rightarrow \text{ Ricci)} \\
 &= 2\nabla_b (K^a R_a{}^b) - 2 \underbrace{R^{(ab)} \nabla_{[b} K_{a]}}_{0 \text{ from Killing Eq.}}
 \end{aligned}$$

and since Ricci Id. gives

$$\begin{aligned}
 (\nabla_a \nabla_b K_c - \underbrace{\nabla_b \nabla_a K_c}_{0 \text{ from Killing Eq.}} &= (R_{abcd} \\
 + \underbrace{\nabla_c \nabla_b K_a}_{0 \text{ from Killing Eq.}} - \underbrace{\nabla_b \nabla_c K_a}_{0 \text{ from Killing Eq.}} &+ R_{cbad} \\
 + \underbrace{\nabla_c \nabla_a K_b}_{0 \text{ from Killing Eq.}} - \underbrace{\nabla_a \nabla_c K_b}_{0 \text{ from Killing Eq.}} &= +R_{cbad}) K^d \\
 \Leftrightarrow 2\nabla_a \nabla_b K_c &= \left(R_{cbad} + \underbrace{R_{cdab} + R_{cabd}}_{\substack{= -R_{cbda} \\ = R_{cbad}} \text{ from } R_{c[dab]}} \right) K^d \text{ from Riemann symmetries} \\
 \Rightarrow \nabla_b \nabla_a K^b &= R^b{}_{abd} K^d = R_{ab} K^b
 \end{aligned}$$

Therefore

$$\begin{aligned}
 K^a \nabla_a R &= 2\nabla_b (K^a R_a{}^b) = 2\nabla_{(b} \nabla_{c)} \nabla^{[b} K^{c]} \\
 &= 0 \text{ from Killing Eq.}
 \end{aligned}$$

Thus we get

$$\nabla_b (K^a R_a{}^b) = \frac{1}{2} K^a \nabla_a R = 0 = \nabla_a J_{KR}^a$$

□

For the spacelike (rotation) Killing vector

$J_{LR}^a = L_b R^{ab}$ for K yields Komar angular momentum, conserved as

$$\begin{aligned}
 \nabla_a J_{LR}^a &= \underbrace{\nabla_{[a} L_{b]} R^{(ab)}}_{0 \text{ from Killing Eq.}} + L_b \nabla_a R^{ab} \\
 &= \frac{L^a}{2} \nabla_a R = 0 \text{ as proof only uses Killing Eq.}
 \end{aligned}$$

They define the conserved mass and spin as

$$J_{KR}^a = \nabla_b \nabla^a K^b \Rightarrow S_M^{ab} = \nabla^a K^b \text{ and } J_{LR}^a = \nabla_b \nabla^a L^b \Rightarrow S_J^{ab} = \nabla^a L^b$$

$$\left\{ \begin{array}{l} M = -\frac{1}{4\pi G} \int_{\partial\Sigma} d^2z \sqrt{|\gamma^{(\partial\Sigma)}|} n_a e_b \nabla^a K^b \\ J = -\frac{1}{8\pi G} \int_{\partial\Sigma} d^2z \sqrt{|\gamma^{(\partial\Sigma)}|} n_a e_b \nabla^a L^b \end{array} \right. \text{with } a = \frac{GJ}{GM} = \frac{J}{M}$$

For $e \neq 0$, defining $F_{ab} = 2\partial_{[a}A_{b]}$ one can get $m \neq 0$

$$A_a = \frac{er - ma \cos \theta}{\rho^2} dt_a + \frac{-ear \sin^2 \theta + m(r^2 + a^2) \cos^2 \theta}{\rho^2} d\phi_a$$

We keep $e = m = 0$ for the rest.

6.1.3 Boyer-Lindquist coordinates

(t, r, θ, ϕ) are the Boyer-Lindquist coordinates.

For $a \rightarrow 0$ the metric reduces to Schwarzschild ([verify](#))

6.1.3.1 Analysis of Minkowski space in Boyer-Lindquist coordinates

For $M \rightarrow 0$ they reduce to flat spacetime but
(C)

$$ds^2 = -dt^2 + \frac{r^2 + a^2 \cos^2 \theta}{r^2 + a^2} dr^2 + (r^2 + a^2 \cos^2 \theta) d\theta^2 + (r^2 + a^2) \sin^2 \theta d\phi^2$$

is not simply Minkowski: it is so using ellipsoidal coordinates (in spacelike hyperplanes)

$$\begin{cases} x = \sqrt{r^2 + a^2} \sin \theta \cos \phi \\ y = \sqrt{r^2 + a^2} \sin \theta \sin \phi \\ z = r \cos \theta \end{cases} \Rightarrow ds^2 = -dt^2 + dx^2 + dy^2 + dz^2$$

They represent:

- revolution ellipsoids for $r = cst$

$$\left(\frac{x}{\sqrt{r^2 + a^2}} \right)^2 + \left(\frac{y}{\sqrt{r^2 + a^2}} \right)^2 + \left(\frac{z}{r} \right)^2 = 1$$

- revolution hyperboloids for $\theta = cst$

$$\left(\frac{x}{a \sin \theta} \right)^2 + \left(\frac{y}{a \sin \theta} \right)^2 - \left(\frac{z}{a \cos \theta} \right)^2 = \left(\frac{r}{a} \right)^2 + 1 - \left(\frac{r}{a} \right)^2 = 1$$

- circles for $\theta, r = cst$

$$\frac{x^2}{(r^2 + a^2) \sin^2 \theta} + \frac{y^2}{(r^2 + a^2) \sin^2 \theta} = 1$$

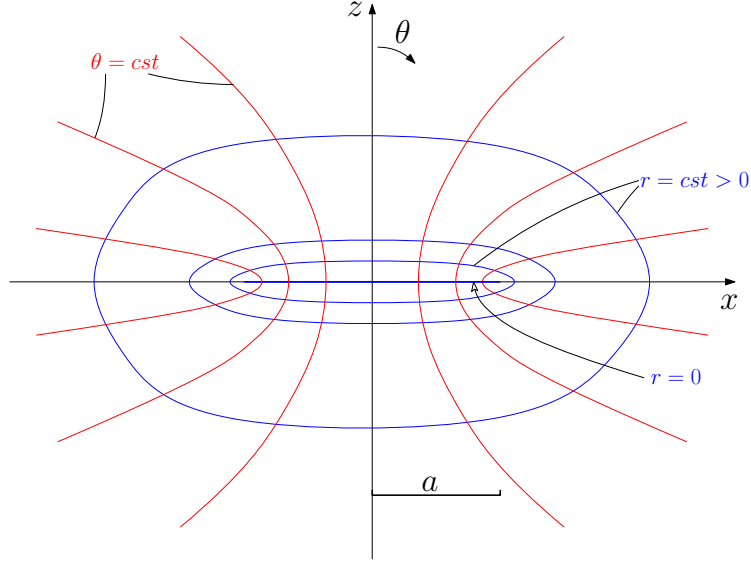
 Figure 6.1.3: $x - z$ plane of Boyer-Lindquist coordinates

so in the plane $\phi = 0 \Rightarrow y = 0 : (x, z)$ plane

we restrict ellipsoids to ellipses at $r = cst : \left(\frac{x}{\sqrt{r^2+a^2}}\right)^2 + \left(\frac{z}{r}\right)^2 = 1$ of semi axes $r, \sqrt{r^2+a^2}$ and thus semifocus $\sqrt{(\sqrt{r^2+a^2})^2 - r^2} = a$

while hyperboloids become hyperbolae at $\theta = cst$: $\theta = 0 \Rightarrow x = 0 : z$ axis
 $\theta = \frac{\pi}{2} \Rightarrow z = 0 : x$ axis

$\left(\frac{x}{a \sin \theta}\right)^2 - \left(\frac{z}{a \cos \theta}\right)^2 = 1$ with linear excentricity (origin to focus distance)
 $\sqrt{(a \sin \theta)^2 + (a \cos \theta)^2} = a$, asymptote slope $\frac{a \cos \theta}{a \sin \theta} = \cot \theta$ and the $r = 0$ locus defined as

$$z = 0$$

$$x \in [-a; a]$$

$$y \in [-a; a]$$

$$x^2 + y^2 = a^2 \sin^2 \theta \leq a^2 : \text{Disk}$$

(see Fig. 6.1.3)

In $\theta = \frac{\pi}{2}$ plane $\Rightarrow r = 0 : (x, y)$ plane

we restrict the ellipsoids to circles at $\theta, r = cst : \frac{x^2}{r^2+a^2} + \frac{y^2}{r^2+a^2} = 1$ of radius $R_c = \sqrt{r^2+a^2} \geq a$

and for $\phi = cst$, we have straight lines of slope $\frac{y}{x} = \tan \phi$ (see Fig. 6.1.4)

6.1.3.2 Killing vectors/tensor of Boyer-Lindquist coordinates

We have seen that $K = \partial_t$ and $L = \partial_\phi$ are Killing vectors

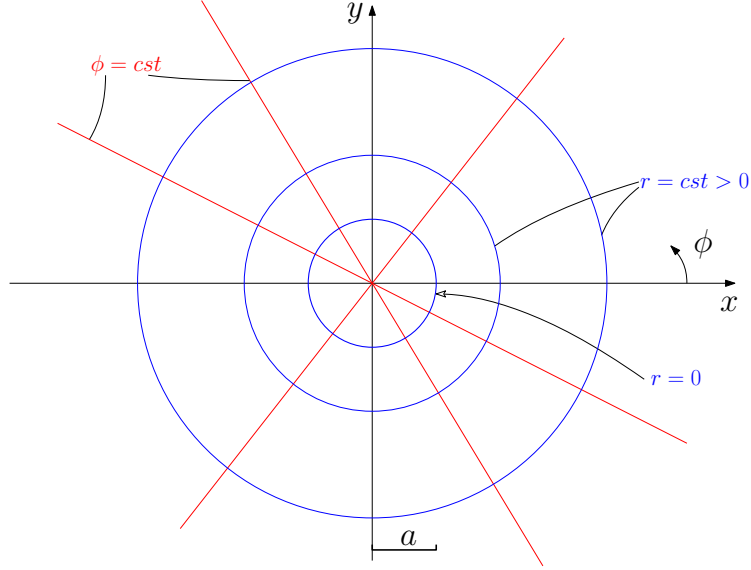
 Figure 6.1.4: $x - y$ plane of Boyer-Lindquist coordinates

Defining the repeated principal null vectors

$$k^a = \frac{1}{\Delta} \begin{pmatrix} (r^2 + a^2)K^a + \Delta\partial_r + aL^a \\ \parallel \\ R_c^2 \end{pmatrix}$$

$$l^a = \frac{1}{2\rho^2} (R_c^2 K^a - \Delta\partial_r + aL^a)$$

one can verify $k^a k_a = 0 = l^a l_a$ and $k^a l_a = -1$ (k, l null) and $\sigma_{ab} = 2\rho^2 k_{(a} l_{b)} + r^2 g_{ab}$ verifies $\sigma_{(ab;c)} = 0$ so σ_{ab} is a Killing tensor

6.1.4 Horizons, stationary limit and singularity

6.1.4.1 Horizons

We have event horizons for $g^{rr} = 0$
 (recall Schwarzschild: $g^{rr} = 1 - \frac{2GM}{r}$)

Here $g^{rr} = \frac{\Delta}{\rho^2} = 0 \Rightarrow \Delta = 0$

$$\begin{aligned} \Leftrightarrow r^2 - 2GMr + a^2 = 0 &= (r - GM)^2 + a^2 - (GM)^2 \\ \Leftrightarrow (r - GM)^2 &= (GM)^2 - a^2 < 0 : \text{Naked singularity} \\ &= 0 : \text{unstable, so we restrict to} \\ &> 0 : \text{two horizons} \\ \Rightarrow r_{\pm} &= GM \pm \sqrt{(GM)^2 - a^2} : \text{null surfaces} \end{aligned}$$

We have 2 event horizons

Since metric is stationary but not static, r_{\pm} not Killing Horizons for K^a
In fact, since

$$\begin{aligned} g_{tt} &= - \left(1 - \frac{C}{\rho^2} \right) = - \frac{1}{\rho^2} (\rho^2 - C) = - \frac{1}{\rho^2} (r^2 + a^2 \cos^2 \theta - C) \\ &= - \frac{(r^2 + a^2 - C - a^2 \sin^2 \theta)}{\rho^2} = - \frac{1}{\rho^2} (\Delta - a^2 \sin^2 \theta) \end{aligned}$$

we have at horizons

$$K^a K_a = g_{tt} = - \frac{1}{\rho^2} (\Delta - a^2 \sin^2 \theta) = \|K\|^2 \neq 0 \text{ (at } \Delta = 0)$$

and in fact already

$$\|K\|^2 = \frac{a^2}{\rho^2} \sin^2 \theta \geq 0 : K \text{ is spacelike at } r_{\pm}$$

$$\text{null at } r_{\pm}, \theta = \begin{cases} 0 & : \text{poles of } z \text{ axis} \\ \pi \end{cases}$$

6.1.4.2 Stationary limit

$\|K\|^2 = 0$ defines the stationary limit surface

$$\Rightarrow \Delta = a^2 \sin^2 \theta \Leftrightarrow (r - GM)^2 = (GM)^2 - a^2 \cos^2 \theta$$

Take + solution: $r_e \geq r_+$

Defines circles at $\theta = cst$ in (x, y) planes (for $z = r \cos \theta$) with maximum radius at $\theta = \frac{\pi}{2}$ ($\Rightarrow r = 0$)

$$r_{e,max} = r_e|_{\theta=\frac{\pi}{2}} = 2GM = r_{Sch}$$

In the $\phi = 0$ plane ($y = 0$) r_e goes from x maximum to $x = 0$ ($\Rightarrow \theta = 0$)
and so $z = r_+ = r_e$ touches the outer Horizon

In general: the stationary limit

$$r_e = GM + \sqrt{(GM)^2 - a^2 \cos^2 \theta}$$

$$\begin{cases} x = r_e(\theta) \sin \theta \\ z = r_e(\theta) \cos \theta \end{cases} \quad \theta \in [0; 2\pi]$$

This surface contains the Ergosphere, where pure radial motion is not possible, only in the direction of rotation a , but $r < r_+$ still can escape (see Fig. 6.1.5)

6.1.4.3 True singularity

$\rho^2 = 0 = r^2 + a^2 \cos^2 \theta$ is a true singularity: $R^{abcd} R_{abcd} \xrightarrow{\rho \rightarrow 0} \infty$

$$\rho^2 = 0 \Leftrightarrow \begin{cases} r = 0 \\ \text{and} \\ \theta = \frac{\pi}{2} (\pi) \end{cases}$$

$r = 0$:

$$\begin{cases} z = 0 \\ x = a \sin \theta \cos \phi \\ y = a \sin \theta \sin \phi \end{cases} : x^2 + y^2 = a^2 \sin^2 \theta \quad \theta \in [0; \pi] \quad \boxed{\text{Disk}}$$

$\theta = \frac{\pi}{2} (\pi)$:

$$\begin{cases} z = 0 \\ x = \sqrt{r^2 + a^2} \cos \phi \\ y = \sqrt{r^2 + a^2} \sin \phi \end{cases} \quad \begin{matrix} r^2 \in \mathbb{R}^+ \\ \phi \in [0; 2\pi] \end{matrix} : x^2 + y^2 = r^2 + a^2 = R_c^2, \text{ circles of } R_c \geq a \quad \boxed{\text{Plane } z = 0 - \text{Disk}}$$

$$\left. \begin{matrix} r = 0 \\ \theta = \frac{\pi}{2} (\pi) \end{matrix} \right\} \Rightarrow$$

$$\begin{cases} z = 0 \\ x = a \cos \phi \\ y = a \sin \phi \end{cases} : \boxed{\text{Ring}}$$

so $\rho = 0$: $\boxed{\text{Ring Singularity}}$

Only seen from $\theta = \frac{\pi}{2} (\pi)$?

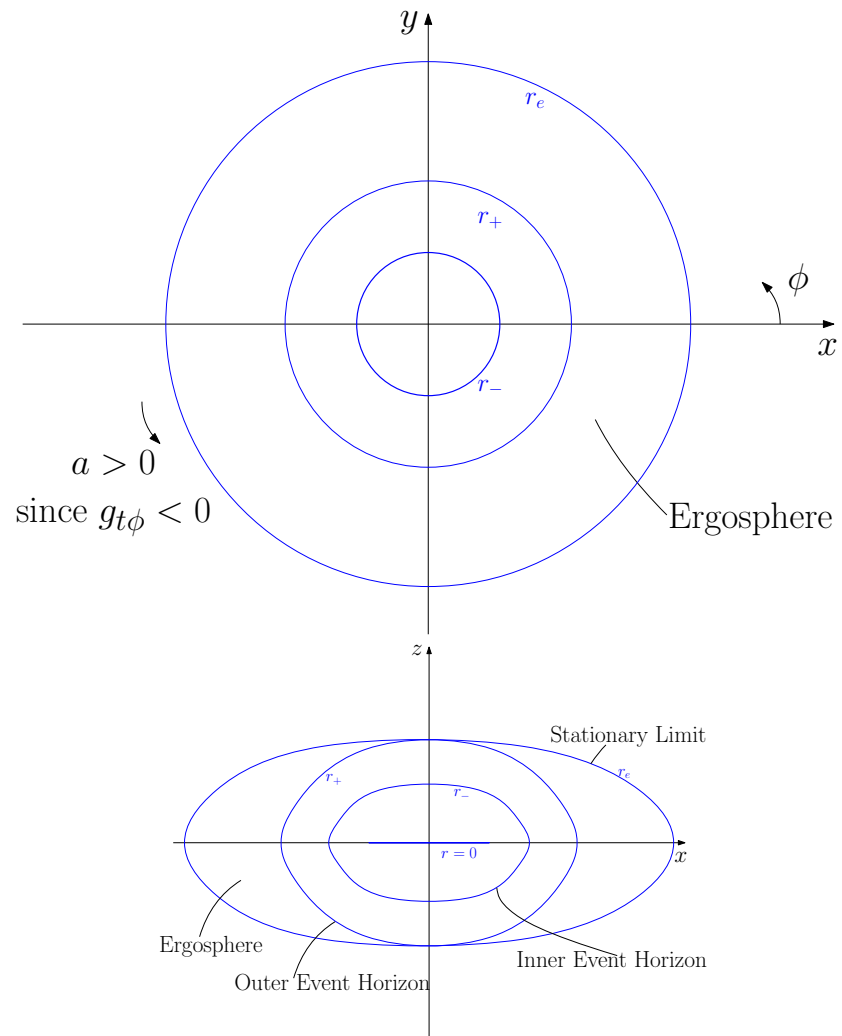

Figure 6.1.5: Horizons, stationary limit and Ergosphere

In $y = 0$ plane ($\phi = 0$): If we go to the ring at fixed x :

$$\begin{aligned}
 x = a = \sqrt{r^2 + a^2} \sin \theta &\Leftrightarrow r^2 + a^2 = \frac{a^2}{\sin^2 \theta} = a^2 \left(1 + \frac{\cos^2 \theta}{\sin^2 \theta}\right) \\
 &\Leftrightarrow r^2 = a^2 \frac{\cos^2 \theta}{\sin^2 \theta} \\
 &\Rightarrow \cos \theta = \pm \frac{r}{a} |\sin \theta| \\
 \Rightarrow z = r \cos \theta &= a \cos \theta \frac{|\cos \theta|}{|\sin \theta|} \xrightarrow{\theta \rightarrow \frac{\pi}{2}} 0 \\
 &= \pm \frac{r^2}{a} |\sin \theta| \xrightarrow{r \rightarrow 0} 0 : \text{ hit singularity Ring}
 \end{aligned}$$

6.1.4.4 Analytic continuation and timelike loops

Analytic continuation allows to go through the disk to $r < 0$ for $\theta \neq \frac{\pi}{2}$ (π) like in Schwarzschild.

However $r < 0 \Rightarrow \Delta > 0$: no horizons!

Moreover for $r < 0$ and small, fixed θ and t gives $dt = dr = d\theta = 0$ and θ close to $\frac{\pi}{2}$ ($z = 0$ plane) we get

$$\begin{aligned}
 ds^2 &\simeq \frac{\sin^2 \theta}{r^2 + a^2 \cos^2 \theta} \left[(r^2 + a^2)^2 - (r^2 + a^2 - 2GM r) a^2 \sin^2 \theta \right] d\phi^2 \\
 &= \frac{\sin^2 \theta}{r^2 + a^2 \cos^2 \theta} \left[(r^2 + a^2) (r^2 + a^2 - a^2 \sin^2 \theta) + 2GM r a^2 \sin^2 \theta \right] d\phi^2 \\
 &= \sin^2 \theta \left[r^2 + a^2 + \frac{2GM r a^2 \sin^2 \theta}{r^2 + a^2 \cos^2 \theta} \right] d\phi^2
 \end{aligned}$$

with the restriction

$$\begin{aligned}
 \theta \sim \frac{\pi}{2} &\Rightarrow \begin{cases} \cos^2 \theta \ll 1 \\ \sin^2 \theta \sim 1 \end{cases} \\
 0 < -r &\ll 1
 \end{aligned}$$

$$\begin{aligned}
 ds^2 &= a^2 (1 - \cos^2 \theta) \left[1 + \left(\frac{r}{a}\right)^2 + \frac{2GM}{r \left(\frac{1}{1 - \cos^2 \theta} + \left(\frac{a}{r}\right)^2 \frac{\cos^2 \theta}{1 - \cos^2 \theta}\right)} \right] d\phi^2 \quad \text{take } \frac{a^2 \cos^2 \theta}{r^2} \ll 1 \\
 &\simeq a^2 \left[1 + \frac{2GM}{r} \right] d\phi^2 < 0
 \end{aligned}$$

so L^a timelike for a region of $r < 0$ around $z = 0$. Since L^a goes in circles; it creates the possibility of timelike loops!

6.1.4.5 Ergosphere, framedragging and outer horizon angular velocity

Another look at the Ergosphere There

$$K^a K_a = g_{tt} = \frac{1}{\rho^2} (a^2 \sin^2 \theta - \Delta) \geq 0 : r_+ < r \leq r_e$$

$$< \frac{a^2 \sin^2 \theta}{\rho^2}$$

Thus all metric terms are positive except the cross terms.

For a timelike observer $t^a = \frac{dx^a}{d\tau}$

$$g_{ab} t^a t^b < 0 \Rightarrow 2g_{t\phi} t^t t^\phi = 2g_{t\phi} \frac{dt}{d\tau} \frac{d\phi}{d\tau}$$

$$= 2g_{t\phi} (t^a \nabla_a t) (t^b \nabla_b \phi) < 0$$

but $\nabla_a t = \partial_a t = \begin{pmatrix} 1 \\ \vec{0} \end{pmatrix} \Rightarrow t^a \nabla_a t = t^t \geq 0$ since t^a future timelike and

$$g_{t\phi} < 0 \Rightarrow \boxed{\frac{d\phi}{d\tau} > 0}$$

In the $\theta = \frac{\pi}{2}$ plane ($z = 0$) Take null rotating curves: photon emitted in L^a direction

$$ds^2 = g_{tt} dt^2 + g_{t\phi} (dt d\phi + d\phi dt) + g_{\phi\phi} d\phi^2 = 0$$

$$\Leftrightarrow \left(\frac{d\phi}{dt}\right)^2 + 2 \frac{g_{t\phi}}{g_{\phi\phi}} \frac{d\phi}{dt} + \frac{g_{tt}}{g_{\phi\phi}} = 0$$

$$\Rightarrow \frac{d\phi}{dt} = -\frac{g_{t\phi}}{g_{\phi\phi}} \pm \sqrt{\left(\frac{g_{t\phi}}{g_{\phi\phi}}\right)^2 - \frac{g_{tt}}{g_{\phi\phi}}} > 0 \text{ for } g_{tt} > 0 \text{ and } g_{t\phi} < 0$$

Photons emitted in opposite directions rotate in the same direction

Furthermore, on the stationary limit ($g_{tt} = \|K\|^2 = 0$) $\Delta = a^2 \sin^2 \theta$ so

$$\frac{d\phi}{dt} = \begin{cases} 0 \\ \text{or} \\ -2 \frac{g_{t\phi}}{g_{\phi\phi}} = \frac{2Ca}{(r^2+a^2)^2 - \Delta a^2 \sin^2 \theta} \end{cases}$$

Since $\Delta = r^2 + a^2 - C$ and $\theta = \frac{\pi}{2}$

$$\Rightarrow \left. \frac{d\phi}{dt} \right|_e = \frac{2Ca}{(\Delta + C)^2 - \Delta a^2 \sin^2 \theta} \stackrel{\Delta = a^2 \sin^2 \theta}{=} \frac{2Ca}{C(C + 2a^2 \sin^2 \theta)}$$

$$\stackrel{\theta = \frac{\pi}{2}}{=} \frac{2a}{C + 2a^2}$$

we have

$$\begin{aligned}
 C &= 2GM r_e \\
 &= 2GM \left(GM + \sqrt{(GM)^2 - a^2 \cos^2 \theta} \right) \\
 &\underset{\theta=\frac{\pi}{2}}{=} (2GM)^2
 \end{aligned}$$

so $\frac{d\phi}{dt} = \frac{a}{2(GM)^2 + a^2}$ with the same sign as a : photons rotate in the same direction as B.H. rotation

This illustrates the “dragging of the inertial frame”

Locally nonrotating future pointing observer far from the B.H. can be chosen as $v^a = -\frac{\nabla^a t}{\sqrt{-\nabla^b t \nabla_b t}}$ since we have seen $t^b \nabla_b t > 0$ so $(\nabla^b t) \delta_a^t < 0$

$$v^a = -\frac{g^{at}}{\sqrt{-g^{tt}}} = \begin{pmatrix} \frac{dt}{d\tau} \\ 0 \\ 0 \\ \frac{d\phi}{d\tau} \end{pmatrix} = \begin{pmatrix} \sqrt{-g^{tt}} \\ 0 \\ 0 \\ -\frac{g^{t\phi}}{\sqrt{-g^{tt}}} \end{pmatrix} \xrightarrow{r=\infty} \begin{pmatrix} 1 \\ \vec{0} \end{pmatrix}$$

Angular velocity is

$$\frac{d\phi}{dt} = \frac{\frac{d\phi}{d\tau}}{\frac{dt}{d\tau}} = \frac{g^{t\phi}}{g^{tt}}$$

so we need to invert the metric from

$$g_{ab} = \begin{pmatrix} g_{tt} & g_{t\phi} & 0 & 0 \\ g_{t\phi} & g_{\phi\phi} & 0 & 0 \\ 0 & 0 & g_{rr} & 0 \\ 0 & 0 & 0 & g_{\theta\theta} \end{pmatrix}$$

into

$$\begin{aligned}
 g^{ab} &= \begin{pmatrix} g^{tt} & g^{t\phi} & 0 & 0 \\ g^{t\phi} & g^{\phi\phi} & 0 & 0 \\ 0 & 0 & \frac{1}{g_{rr}} & 0 \\ 0 & 0 & 0 & \frac{1}{g_{\theta\theta}} \end{pmatrix} \Rightarrow \begin{cases} g^{tt} g_{tt} + g_{t\phi} g^{t\phi} = 1 \\ g_{\phi\phi} g^{t\phi} + g_{t\phi} g^{tt} = 0 \\ g_{tt} g^{t\phi} + g_{t\phi} g^{\phi\phi} = 0 \\ g_{t\phi} g^{t\phi} + g_{\phi\phi} g^{\phi\phi} = 1 \end{cases} \\
 \Rightarrow -g^{tt} \frac{g_{t\phi}}{g_{\phi\phi}} &= g^{t\phi} = -g^{\phi\phi} \frac{g_{t\phi}}{g_{tt}}
 \end{aligned}$$

and so $g^{tt} \left(g_{tt} - \frac{g_{t\phi}^2}{g_{\phi\phi}} \right) = 1 = g^{\phi\phi} \left(g_{\phi\phi} - \frac{g_{t\phi}^2}{g_{tt}} \right)$

$$\Rightarrow g^{ab} = \begin{pmatrix} \frac{g_{\phi\phi}}{g_{tt} g_{\phi\phi} - g_{t\phi}^2} & \frac{-g_{t\phi}}{g_{tt} g_{\phi\phi} - g_{t\phi}^2} & 0 & 0 \\ \frac{-g_{t\phi}}{g_{tt} g_{\phi\phi} - g_{t\phi}^2} & \frac{g_{tt}}{g_{tt} g_{\phi\phi} - g_{t\phi}^2} & 0 & 0 \\ 0 & 0 & \frac{1}{g_{rr}} & 0 \\ 0 & 0 & 0 & \frac{1}{g_{\theta\theta}} \end{pmatrix}$$

We therefore get

$$\Omega = \frac{d\phi}{dt} = \frac{-g_{t\phi}}{g_{\phi\phi}} = \frac{Ca}{(r^2 + a^2)^2 - \Delta a^2 \sin^2 \theta} \text{ and } \Delta = r^2 + a^2 - C$$

$$= \frac{a(r^2 + a^2 - C)}{(r^2 + a^2)^2 - \Delta a^2 \sin^2 \theta}$$

on outer horizon, $r = r_+$, $\Delta = 0$

$$\Rightarrow \boxed{\Omega_H = \frac{a}{r_+^2 + a^2}}$$

6.1.5 Carter-Penrose diagram

Kerr has no spherical symmetry: Carter-Penrose (T, R) diagram cannot capture differences in geometry in (θ, ϕ) !

We can still compactify (t, r) (see Fig. 6.1.6)

6.1.5.1 Similar to Schwarzschild

Minkowski-like asymptotic region $\textcircled{\text{I}}$ limited by r_+ horizon with $\textcircled{\text{II}}$ inside r_+ being the B.H., region $\textcircled{\text{III}}$ also giving a W.H., by extension through the coordinate singularity at $\Delta = 0$.

As in the Schwarzschild case, extending from $\textcircled{\text{II}}$ and $\textcircled{\text{III}}$ we get a symmetric asymptotic region $\textcircled{\text{IV}}$

6.1.5.2 Different from Schwarzschild

$\textcircled{\text{II}}$ and $\textcircled{\text{III}}$ are not barred by spacelike singularity/ next horizon/coordinate singularity r_- can be reached (null surface).

Extending further, we find regions $\textcircled{\text{V}}$ and $\textcircled{\text{VI}}$ where $r < r_-$.

They contain the $\rho = 0$ (at $r = 0$) true singularity, however $r = 0$ is only singular at $\theta = \frac{\pi}{2}$, so for $\theta \neq \frac{\pi}{2}$ it can be traversed to $r < 0$ where no horizon exists.

Regions $\textcircled{\text{V}}$ and $\textcircled{\text{VI}}$ for $r < 0$ (noted $\textcircled{\text{V}'}$ and $\textcircled{\text{VI}'}$) are also asymptotically flat and the ring singularity is naked for its observers, with a mass $-M$.

Regions $\textcircled{\text{V}}$ and $\textcircled{\text{VI}}$ can be further extended to another region $\textcircled{\text{III}}_2$ and corresponding regions $\textcircled{\text{I}}_2, \textcircled{\text{IV}}_2, \dots$, infinitely up to future and down to past.

6.1.5.3 Infinities

Regions $\textcircled{\text{I}}$ and $\textcircled{\text{IV}}$, similarly to Schwarzschild, get a space infinity i^0 , a future time i^+ and past time i^- infinities and future and past null infinity surfaces.

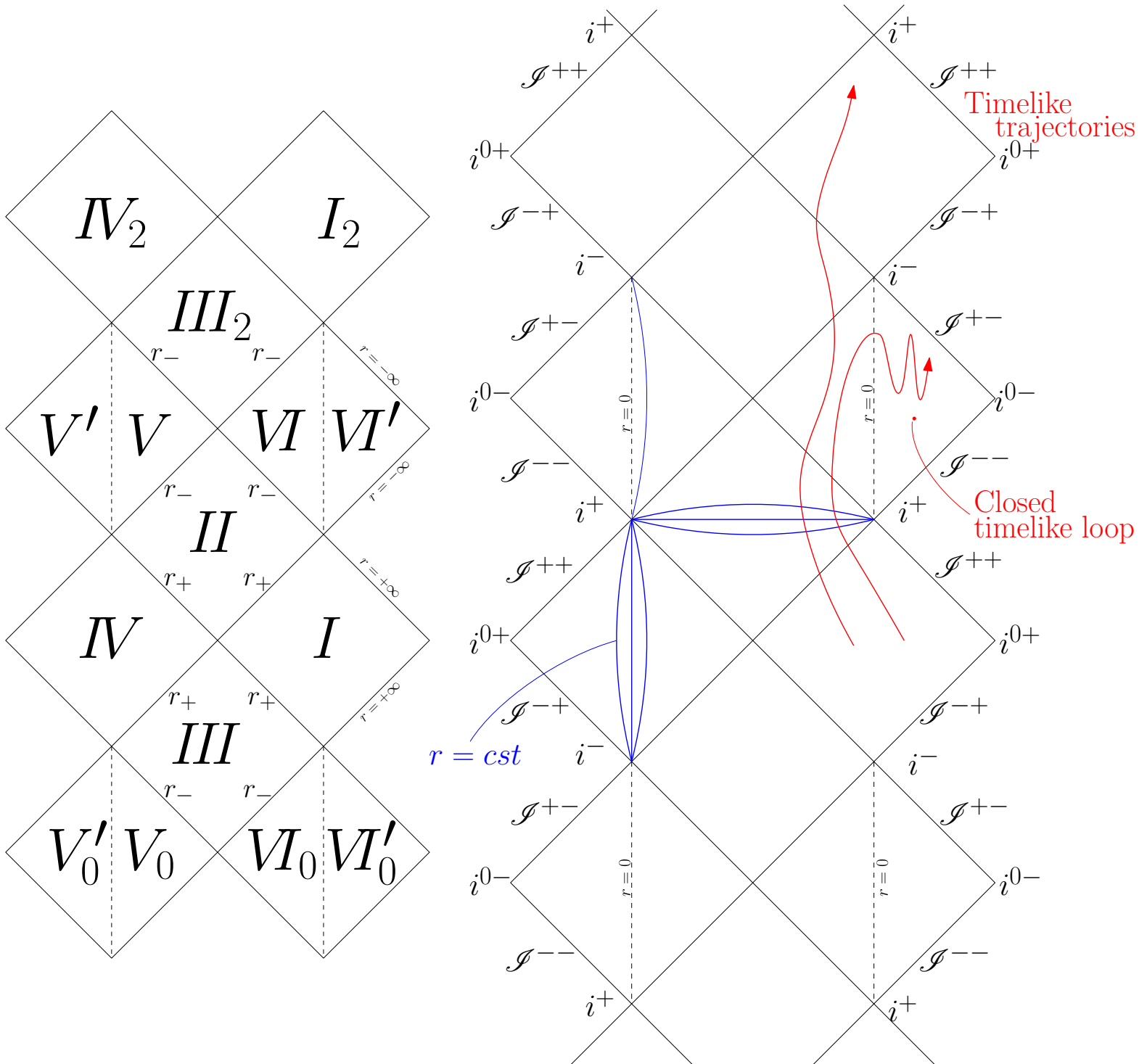

Figure 6.1.6: Kerr solution Carter-Penrose diagram

However asymptotically flat regions (V') and (VI') have similar structure with space, future and past null infinities.

We differentiate them by adding an exponent for the corresponding space r -infinity:

$$i^0 (r = \pm\infty) = i^{0\pm}; \quad \mathcal{I}^\pm (r = \pm\infty) = \mathcal{I}^{\pm\pm}.$$

6.1.5.4 Timelike curves

(I) , (IV) , (V') , (VI') have the same $r = cst$ curves as in Schwarzschild. Between r_+ and r_- ((II) , (III)), as in Schwarzschild, $r = cst$ becomes spacelike.

As in Reissner-Nordström charged B.H., timelike trajectories can travel through to a W.H..

However, if they cross $r = 0$ to $r < 0$, timelike loops become possible ($\dot{\phi}$ loops) and paradoxes are appearing.

6.1.6 Geodesic motion

Any geodesic trajectory follows

$$u^a = \dot{t}\partial_t^a + \dot{\phi}\partial_\phi^a + \dot{r}\partial_r^a + \dot{\theta}\partial_\theta^a = \frac{dx^a}{d\lambda}$$

For timelike geodesics, $\lambda = \tau$, $u^a u_a = -1$

As u^a and K^a , timelike Killing vector, are future pointing, $K_a u^a < 0$ at radial infinity and can there define u^a 's energy per unit mass, conserved along u^a :

$$E = -u^a K_a = g_{ab} u^a K^b = \left(1 - \frac{C}{\rho^2}\right) \dot{t} + \frac{Ca \sin^2 \theta}{\rho^2} \dot{\phi}$$

The spacelike Killing vector L^a define u^a 's angular momentum per unit mass

$$J = u^a L_a = g_{ab} u^a L^b = -\frac{Ca \sin^2 \theta}{\rho^2} \dot{t} + \frac{\sin^2 \theta}{\rho^2} \left[(r^2 + a^2)^2 - \Delta a^2 \sin^2 \theta \right] \dot{\phi}$$

so we have the system

$$\begin{cases} E = \frac{Ca \sin^2 \theta}{\rho^2} \dot{\phi} + \left(1 - \frac{C}{\rho^2}\right) \dot{t} \\ J = -\frac{Ca \sin^2 \theta}{\rho^2} \dot{t} + \frac{\sin^2 \theta}{\rho^2} \left[(r^2 + a^2)^2 - \Delta a^2 \sin^2 \theta \right] \dot{\phi} \end{cases}$$

6.1.6.1 Equatorial motion

We restrict to the $\theta = \frac{\pi}{2}$ ($\Rightarrow z = 0$) plane $\Rightarrow \rho^2 = r^2$

$$\Delta = r^2 + a^2 - C \text{ with } C = 2GMr \text{ (no charge from } F^{ab}) \Rightarrow \Delta = r^2 + a^2 - 2GMr$$

We have seen $g_{\phi\phi} = \sin^2 \theta \left[r^2 + a^2 + \frac{2GMra^2 \sin^2 \theta}{r^2 + a^2 \cos^2 \theta} \right]$ so the system reads

$$\begin{cases} E = \frac{2GMa}{r} \dot{\phi} + \left(1 - \frac{2GM}{r}\right) \dot{t} = At + B\dot{\phi} \\ J = \left[r^2 + a^2 + \frac{2GMa^2}{r} \right] \dot{\phi} - \frac{2GMa}{r} \dot{t} = -B\dot{t} + C\dot{\phi} \end{cases}$$

and the metric restricts to

$$g_{ab} = \begin{pmatrix} -A & -B & 0 & 0 \\ -B & C & 0 & 0 \\ 0 & 0 & \frac{r^2}{\Delta} & 0 \\ 0 & 0 & 0 & r^2 \end{pmatrix}$$

The determinant of the system is

$$\begin{aligned} AC + B^2 &= \left(1 - \frac{2GM}{r}\right) \left[r^2 + a^2 + \frac{2GMa^2}{r} \right] + \left(\frac{2GMa}{r} \right)^2 \\ &= r^2 + a^2 + \frac{2GMa^2}{r} - [r^2 + a^2] \frac{2GM}{r} \\ &= r^2 + a^2 - 2GMr = \Delta \end{aligned}$$

so we have

$$\begin{cases} CE - BJ = [AC + B^2] \dot{t} = \Delta \dot{t} \\ AJ + BE = [AC + B^2] \dot{\phi} = \Delta \dot{\phi} \end{cases} \\ \Leftrightarrow \begin{cases} \dot{t} = \frac{1}{\Delta} \left[\left(r^2 + a^2 + \frac{2GMa^2}{r} \right) E - \frac{2GMa}{r} J \right] \\ \dot{\phi} = \frac{1}{\Delta} \left[\left(1 - \frac{2GM}{r} \right) J + \frac{2GMa}{r} E \right] \end{cases}$$

Allowing for timelike
spacelike geodesics, $u^a u_a = -s = \begin{cases} -1 \\ 1 \\ 0 \end{cases}$
and null

we can write (recall $\theta = \frac{\pi}{2} \Rightarrow \dot{\theta} = 0$)

$$\begin{aligned} -s &= g_{ab} u^a u^b \\ &= -At^2 - 2Bt\dot{\phi} + C\dot{\phi}^2 + \frac{r^2}{\Delta} \dot{r}^2 \text{ and using the system of invariants} \\ &= - \underbrace{[At + B\dot{\phi}]}_E \dot{t} + \underbrace{[C\dot{\phi} - Bt]}_J \dot{\phi} + \frac{r^2}{\Delta} \dot{r}^2 \\ &= -Et + J\dot{\phi} + \frac{r^2}{\Delta} \dot{r}^2 \end{aligned}$$

Now using its solution

$$\begin{aligned} \Leftrightarrow \dot{r}^2 &= \frac{\Delta}{r^2} (Et - J\dot{\phi} - s) \\ &= \frac{1}{r^2} (E[CE - BJ] - J[AJ + BE] - \Delta s) \\ &= \frac{1}{r^2} (CE^2 - AJ^2 - 2BEJ - \Delta s) \end{aligned}$$

Defining now from their expressions $A = 1 - Y$, $B = aY$, $C = X + a^2Y$ so $\Delta = X - r^2Y \Leftrightarrow Y = \frac{2GM}{r}$, $X = r^2 + a^2$

$$\begin{aligned} \Rightarrow \dot{r}^2 &= \frac{1}{r^2} [(X + a^2Y) E^2 - (1 - Y) J^2 - 2aY EJ - (X - r^2Y) s] \\ &= \frac{1}{r^2} \left[X (E^2 - s) + Y \left\{ \underbrace{(a^2 E^2 + J^2 - 2aEJ)}_{(J-aE)^2} + r^2 s \right\} - J^2 \right] \\ &\Leftrightarrow \frac{\dot{r}^2}{2} + V(E, J, r) = 0 \end{aligned}$$

where

$$\begin{aligned} V &= \frac{1}{r^2} \left[\frac{J^2}{2} - sr^2 \frac{Y}{2} + \frac{1}{2} (s - E^2) X - \frac{Y}{2} (J - aE)^2 \right] \\ &= \frac{J^2}{2r^2} - s \frac{GM}{r} + \frac{1}{2} (s - E^2) \left(1 + \left(\frac{a}{r} \right)^2 \right) - \frac{GM}{r} (J - aE)^2 \end{aligned}$$

As in Schwarzschild: motion in an effective 1D potential.

6.1.6.2 Non equatorial motion

Add also conserved quantity from Killing tensor σ : since $\sigma_{(ab;c)} = 0$, along geodesics with tangent u^a

$$\begin{aligned} u^c \nabla_c (\sigma_{ab} u^a u^b) &\equiv u^c \nabla_c (\mathcal{E}) \\ &= u^{(a} u^b u^{c)} \underbrace{\nabla_c \sigma_{ab}}_{\text{Killing Eq.}} + u^a \sigma_{ab} \underbrace{u^c \nabla_c u^b}_{\text{Geo. Eq.}} + u^b \sigma_{ab} \underbrace{u^c \nabla_c u^a}_{\text{Geo. Eq.}} \\ &= 0 \\ \Rightarrow \mathcal{E} = \sigma_{ab} u^a u^b &\text{ conserved} \end{aligned}$$

6.2 Penrose process and Energy extraction from Black Holes

From geodesic motion of test particle of mass m , its 4-momentum writes $p^a = mu^a$ and we similarly define its energy

$$\mathcal{E} = -p^a K_a$$

and angular momentum

$$\mathcal{J} = p^a L_a$$

We thus have the system

$$\begin{cases} \mathcal{E} = m \frac{Ca \sin^2 \theta}{\rho^2} \dot{\phi} + m \left(1 - \frac{C}{\rho^2}\right) \dot{t} \\ \mathcal{J} = -m \frac{Ca \sin^2 \theta}{\rho^2} \dot{t} + m \frac{\sin^2 \theta}{\rho^2} \left[(r^2 + a^2)^2 - \Delta a^2 \sin^2 \theta \right] \dot{\phi} \end{cases}$$

Since K^a becomes spacelike in the Ergosphere, we can have $\mathcal{E} < 0$ inside of it.

If the B.H. absorb an $\mathcal{E} < 0$ particle, we can extract energy from it.

Suppose we throw a particle with p_0^a into the Ergosphere.

Its energy $\mathcal{E}_0 = -p_0^a K_a > 0$ since outside the Ergosphere K^a timelike

Now we split it in 2 parts. Conservation of momentum yields

$$p_0^a = p_1^a + p_2^a$$

contracting with K^a

$$\mathcal{E}_0 = \mathcal{E}_1 + \mathcal{E}_2$$

If we set the first fragment to have $\mathcal{E}_1 < 0$ then $\mathcal{E}_2 = \mathcal{E}_0 + |\mathcal{E}_1| > \mathcal{E}_0$ and we have $M_{BH} = M_{INITIAL} - |\mathcal{E}_1| : |\mathcal{E}_1|$ has been extracted from the B.H.

This is called the Penrose process

6.2.1 Killing Horizon

r_+ is a Killing Horizon

$\chi_a = K_a + \Omega_H L_a$ is Killing vector and null at $r_+ \Leftrightarrow r_+$ horizon is a Killing horizon

Proof. :

- $\chi_{(a;b)} = K_{(a;b)} + \Omega_H L_{(a;b)}$ since $\Omega_H = cst.$ So χ_a Killing
- Since

$$K^a L_a = g_{t\phi} = -\frac{Ca \sin^2 \theta}{\rho^2}$$

$$K^a K_a = g_{tt} = -\frac{\Delta - a^2 \sin^2 \theta}{\rho^2} \quad (\text{with } \Delta = r^2 + a^2 - C)$$

$$L^a L_a = g_{\phi\phi} = \sin^2 \theta \left[r^2 + a^2 + \frac{Ca^2 \sin^2 \theta}{\rho^2} \right] = \sin^2 \theta \left[\Delta + \frac{C}{\rho^2} (\rho^2 + a^2 \sin^2 \theta) \right]$$

and recall $\Omega_H = -\frac{g_{t\phi}}{g_{\phi\phi}} \Big|_{r_+}$ so we can write

$$\begin{aligned} \chi^a \chi_a &= K^a K_a + \Omega_H^2 L^a L_a + 2\Omega_H K^a L_a \\ &= g_{tt} + \left(\frac{g_{t\phi}}{g_{\phi\phi}} \right)^2 (r_+) g_{\phi\phi} - 2 \left(\frac{g_{t\phi}}{g_{\phi\phi}} \right) (r_+) g_{t\phi} \end{aligned}$$

so at r_+ (where $\Delta = 0$)

$$\begin{aligned}
 \chi^a \chi_a &= g_{tt}|_{r_+} - \frac{g_{t\phi}^2}{g_{\phi\phi}} \Big|_{r_+} = \frac{a^2 \sin^2 \theta}{\rho^2} - \frac{(Ca \sin^2 \theta)^2}{\rho^2 \sin^2 \theta C (\rho^2 + a^2 \sin^2 \theta)} \\
 &= \frac{a^2 \sin^2 \theta}{\rho^2} \left(1 - \frac{C}{r_+^2 + a^2} \right) \\
 &= \frac{a^2 \sin^2 \theta}{\rho^2} \left(1 - \frac{C}{\Delta + C} \right) \Big|_{r_+} \\
 &= 0
 \end{aligned}$$

Moreover, χ is future directed (as K^a) so any particle entering the B.H. at r_+ have

$$\begin{aligned}
 0 \geq p_1^a \chi_a &= p_1^a (K_a + \Omega_H L_a) = -\mathcal{E}_1 + \Omega_H \mathcal{J}_1 \\
 &\Rightarrow \mathcal{J}_1 \leq \frac{\mathcal{E}_1}{\Omega_H}
 \end{aligned}$$

Negative \mathcal{E}_1 particles carry $\mathcal{J}_1 < 0$ (moving against B.H. rotation)

After the B.H. swallows p_1 , it settles to a new Kerr solution with $\delta M = \mathcal{E}_1$ and $\delta J = \mathcal{J}_1$

$$\Rightarrow \boxed{\delta J \leq \frac{\delta M}{\Omega_H}}$$

□

6.2.2 BH horizon area changes

At r_+ the induced metric is given for $dt = 0 = dr$

$$\begin{aligned}
 ds^2 \Big|_{\substack{dt = \\ r = r_+}} \Big|_{dr = 0} &= \gamma_{ij} dx^i dx^j = \rho_+^2 d\theta^2 + \sin^2 \theta \frac{(r_+^2 + a^2)^2}{\rho_+^2} d\phi^2 \\
 &\Rightarrow \sqrt{|\gamma|} = \sqrt{|g_{\theta\theta}^+ g_{\phi\phi}^+|} = \sqrt{\sin^2 \theta (r_+^2 + a^2)^2} = (r_+^2 + a^2) |\sin \theta|
 \end{aligned}$$

so the horizon area calculates

$$A_+ = \int \sqrt{|\gamma|} d\theta d\phi = 4\pi (r_+^2 + a^2)$$

Define the irreducible mass of the B.H., since $r_+ = GM + \sqrt{(GM)^2 - a^2}$,

$$\begin{aligned} M_{irr}^2 &= \frac{A_+}{16\pi G^2} = \frac{r_+^2 + a^2}{4G^2} \\ &= \frac{1}{4G^2} \left((GM)^2 + (GM)^2 - a^2 + a^2 + 2GM\sqrt{(GM)^2 - a^2} \right) \\ &= \frac{1}{2} \left(M^2 + M\sqrt{M^2 - \left(\frac{a}{G}\right)^2} \right) \\ \Rightarrow M_{irr}^2 &= \frac{1}{2} \left(M^2 + \sqrt{M^4 - \left(\frac{Ma}{G}\right)^2} \right) \end{aligned}$$

recall $Ma = J$ and since $\Omega_H = \frac{a}{r_+^2 + a^2}$,

$$M_{irr}^2 = \frac{r_+^2 + a^2}{4G^2} = \frac{a\Omega_H^{-1}}{4G^2} \Leftrightarrow \frac{a\Omega_H^{-1}}{2G^2} = M^2 + \sqrt{M^4 - \left(\frac{J}{G}\right)^2}$$

Differentiating M_{irr}^2

$$\begin{aligned} \Rightarrow 2M_{irr}\delta M_{irr} &= M\delta M + \frac{1}{4} \frac{4M^3\delta M - \frac{2J\delta J}{G^2}}{\sqrt{M^4 - \left(\frac{J}{G}\right)^2}} \\ &= \frac{\left(M^3 + M\sqrt{M^4 - \left(\frac{J}{G}\right)^2} \right) \delta M - \frac{J}{2G^2} \delta J}{\sqrt{M^4 - \left(\frac{J}{G}\right)^2}} \\ &= \frac{M \frac{a\Omega_H^{-1}}{2G^2} \delta M - \frac{Ma}{2G^2} \delta J}{M\sqrt{M^2 - \left(\frac{a}{G}\right)^2}} \\ &= \frac{a}{2G\sqrt{(GM)^2 - a^2}} (\Omega_H^{-1} \delta M - \delta J) \text{ and since } \delta J \leq \frac{\delta M}{\Omega_H} \\ \Leftrightarrow \delta M_{irr} &= \frac{a}{4GM_{irr}\sqrt{(GM)^2 - a^2}} (\Omega_H^{-1} \delta M - \delta J) \geq 0 \end{aligned}$$

The irreducible mass can never be reduced

This is a corollary to the area theorem (Hawking 1971)

Inverting M_{irr} definition,

$$\begin{aligned} (2M_{irr}^2 - M^2)^2 &= M^4 - \left(\frac{J}{G}\right)^2 \\ \Leftrightarrow 4M_{irr}^4 - 4M_{irr}^2 M^2 &= -\left(\frac{J}{G}\right)^2 \\ \Leftrightarrow M^2 &= M_{irr}^2 + \left(\frac{J}{2GM_{irr}}\right)^2 \geq M_{irr}^2 \end{aligned}$$

so the mass of the B.H. cannot reduce below M_{irr} from Penrose process.

At most we can get $J = 0$, extracting from it

$$\Delta M_{max} = M - M_{irr} = M - \frac{1}{\sqrt{2}} \sqrt{M^2 + \sqrt{M^4 - \left(\frac{J}{G}\right)^2}}$$

leaving a Schwarzschild B.H.

From a maximally rotating B.H.

$$(GM_0)^2 = a_0^2 \Leftrightarrow GM_0^2 = J_0$$

Maximal extraction of mass-energy can reach

$$\frac{\Delta M_{max}}{M_0} = 1 - \frac{1}{\sqrt{2}} \simeq 29\%.$$

6.2.3 Superradiance

Equivalent of Penrose process for radiation exists. If absorbed radiation is of negative energy, reflected part can gain intensity.

6.2.4 Gravitational waves in binary coalescence

The area theorem can be used to get upper limit of GW energy emitted from 2 B.H. merger. Start from 2 Schwarzschild B.H. that merge and settle down to another Schwarzschild merger B.H.

$$E_{rad} = M_1 + M_2 - M$$

Initial area is

$$A_{+i} = A_{+1} + A_{+2} = 16\pi G^2 (M_1^2 + M_2^2)$$

Final area

$$A_{+f} = 16\pi G^2 M^2$$

By the area theorem, $A_{+f} \geq A_{+i} \Rightarrow M \geq \sqrt{M_1^2 + M_2^2}$ so $E_{rad} = M_1 + M_2 - M \leq M_1 + M_2 - \sqrt{M_1^2 + M_2^2}$

For $M_1 = M_2$, at most $\frac{E_{rad}}{M_1 + M_2} \leq 1 - \frac{1}{\sqrt{2}} \simeq 29\%$ can be radiated away

6.3 Black Hole Thermodynamics

6.3.1 Kerr-Newman BH surface gravity

From the Chapter 5 on horizons, we can deduce that, since r_+ is a Killing horizon (χ^a null at r_+ and Killing) we can define its surface gravity as κ :

$$\nabla^a (\chi^b \chi_b) = -2\kappa \chi^a \text{ such as } \mathcal{L}_\chi \kappa = 0 \text{ on } r_+ : \kappa \text{ constant at the horizon}$$

Recall

- $\Omega_H = -\frac{g_{t\phi}}{g_{\phi\phi}}\Big|_{r_+}$ but $\Omega = -\frac{g_{t\phi}}{g_{\phi\phi}} = \frac{Ca \sin^2 \theta}{\rho^2 g_{\phi\phi}}$ in general for the rotation around the B.H.
- $g_{\phi\phi} = \frac{\sin^2 \theta}{\rho^2} \left[(r^2 + a^2)^2 - \Delta a^2 \sin^2 \theta \right]$ Define $X = (r^2 + a^2)^2 - \Delta a^2 \sin^2 \theta = (r^2 + a^2)(r^2 + a^2 - a^2 \sin^2 \theta) + Ca^2 \sin^2 \theta$ so $g_{\phi\phi} = \frac{\sin^2 \theta}{\rho^2} X$ and $\Omega = \frac{Ca}{X}$

We also have $g_{t\phi} = -\Omega g_{\phi\phi}$ and $\chi^a = K^a + \Omega_H L^a$ so since $K = \partial_t, L = \partial_\phi$ we have $K^a K_a = g_{tt}$ and so

$$L^a K_a = g_{t\phi}$$

$$L^a L_a = g_{\phi\phi}$$

$$\chi^a \chi_a = g_{tt} + 2\Omega_H g_{t\phi} + \Omega_H^2 g_{\phi\phi} \text{ and using } g_{t\phi} = -\Omega g_{\phi\phi}$$

$$= g_{tt} - 2\Omega_H \Omega g_{\phi\phi} + \Omega_H^2 g_{\phi\phi} \text{ so we can write}$$

$$\chi^2 = (\Omega - \Omega_H)^2 g_{\phi\phi} + g_{tt} - \Omega^2 g_{\phi\phi}$$

From the definitions above we have $\Omega^2 g_{\phi\phi} = \frac{(Ca)^2 \sin^2 \theta}{X}$ so we can calculate

$$\begin{aligned} g_{tt} - \Omega^2 g_{\phi\phi} &= -\left(1 - \frac{C}{\rho^2}\right) - \frac{(Ca)^2 \sin^2 \theta}{X \rho^2} \\ &= \frac{1}{\rho^2 X} \left[(C - \rho^2) X - (Ca)^2 \sin^2 \theta \right] \end{aligned}$$

We proceed, noting $R^2 = r^2 + a^2$

$$\Rightarrow \begin{cases} C = R^2 - \Delta \\ \rho^2 = R^2 - a^2 \sin^2 \theta \\ X = R^2 \rho^2 + Ca^2 \sin^2 \theta = R^4 - \Delta a^2 \sin^2 \theta \end{cases}$$

so

$$\begin{aligned} g_{tt} - \Omega^2 g_{\phi\phi} &= \frac{1}{\rho^2 X} \left[(C - \rho^2) (R^2 \rho^2 + Ca^2 \sin^2 \theta) - (Ca)^2 \sin^2 \theta \right] \\ &= \frac{1}{\rho^2 X} [CR^2 \rho^2 - \rho^2 (R^2 \rho^2 + Ca^2 \sin^2 \theta)] \\ &= \frac{1}{X} [R^2 (C - \rho^2) - Ca^2 \sin^2 \theta] \\ &= \frac{1}{X} [R^2 (a^2 \sin^2 \theta - \Delta) - Ca^2 \sin^2 \theta] \\ &= \frac{1}{X} [\Delta a^2 \sin^2 \theta - R^2 \Delta] = -\frac{\rho^2 \Delta}{X} \\ \Rightarrow \chi^a \chi_a &= (\Omega - \Omega_H)^2 \frac{\sin^2 \theta}{\rho^2} X - \frac{\rho^2 \Delta}{X} \end{aligned} \quad \begin{array}{l} \longrightarrow \\ r \rightarrow r_+ \\ \Delta \rightarrow 0 \\ \left(\Leftrightarrow \begin{array}{l} \Omega \rightarrow \Omega_H \end{array} \right) \end{array} \quad 0$$

as expected

Now since κ is constant over the horizon, we can restrict to the $\theta = \frac{\pi}{2}$ plane to compute

$$\begin{aligned}\nabla_a \chi^2 &= e_r \partial_r \chi^2 \\ &= \left[(\Omega - \Omega_H) \left\{ 2\partial_r \Omega \frac{X}{\rho^2} + (\Omega - \Omega_H) \partial_r \left(\frac{X}{\rho^2} \right) \right\} - \partial_r \left(\frac{\rho^2}{X} \right) \Delta - \frac{\rho^2}{X} \partial_r \Delta \right] e_r\end{aligned}$$

since it only depends on r now

Furthermore, since at r_+ , $\Omega = \Omega_H$ and $\Delta = 0 \Rightarrow \nabla_a \chi^2 = -\frac{\rho^2}{X} \partial_r \Delta e_r$ and since χ is null at $r_+ \Rightarrow \chi$ normal to itself so $\chi \propto$ normal to horizon $r_+ = cst : e_r$

This can be written as $\chi^a = N e_r^a$ and $|\chi^2| = N^2 |g^{rr}| = \frac{N^2}{|g_{rr}|} = \frac{N^2 \Delta}{\rho^2}$. Since $\Delta > 0$ and $\chi^2 < 0$ for $r > r_+$,

Proof. As $\chi^2 = (\Omega - \Omega_H)^2 \frac{\sin^2 \theta}{\rho^2} X - \frac{\rho^2 \Delta}{X}$, with $X = (r^2 + a^2)^2 - \Delta a^2 \sin^2 \theta$, $\rho^2 = r^2 + a^2 \cos^2 \theta$, $\Delta = r^2 + a^2 - C$, $C = 2GM r$ and $\Omega = \frac{C a}{X}$,

$$\text{at } r = r_+, \Delta = 0 \Leftrightarrow C_+ = r_+^2 + a^2 = 2GM r_+ \text{ with } r_+ = GM + \sqrt{(GM)^2 - a^2}$$

$$\Delta = 0 \Leftrightarrow C_+ = r_+^2 + a^2 = 2GM r_+ \text{ with } r_+ = GM + \sqrt{(GM)^2 - a^2}$$

$$X_+ = (r_+^2 + a^2)^2 = C_+^2$$

$$\text{and } \Omega = \Omega_H = \frac{C_+ a}{C_+^2} = \frac{a}{r_+^2 + a^2}$$

then at $r = r_+ + \epsilon$ to first order in ϵ

$$\Delta = \Delta_+ + (2r_+ - 2GM) \epsilon = 2(r_+ - GM) \epsilon = 2\sqrt{(GM)^2 - a^2} \epsilon$$

$$X = (r_+^2 + a^2 + 2r_+ \epsilon)^2 - 2\sqrt{(GM)^2 - a^2} a^2 \sin^2 \theta \epsilon$$

$$= C_+^2 + \left[\frac{4r_+}{C_+} - 2\sqrt{(GM)^2 - a^2} a^2 \sin^2 \theta \right] \epsilon$$

$$= C_+^2 \left(1 + 2 \frac{\left[2r_+ - C_+ \sqrt{(GM)^2 - a^2} a^2 \sin^2 \theta \right]}{C_+^3} \epsilon \right)$$

$$\Rightarrow \Omega = \frac{2GM r_+ a \left(1 + \frac{\epsilon}{r_+} \right)}{C_+^2 \left(1 + 2 \frac{\left[2r_+ - C_+ \sqrt{(GM)^2 - a^2} a^2 \sin^2 \theta \right]}{C_+^3} \epsilon \right)}$$

$$= \Omega_H \left(1 + \left\{ \frac{1}{r_+} - 2 \frac{\left[2r_+ - C_+ \sqrt{(GM)^2 - a^2} a^2 \sin^2 \theta \right]}{C_+^3} \right\} \epsilon \right) \Rightarrow \Omega - \Omega_H \propto \epsilon$$

so $(\Omega - \Omega_H)^2 \frac{\sin^2 \theta}{\rho^2} X \propto \epsilon^2$

$$\Rightarrow \chi^2 = -\frac{\rho_+^2}{X_+} \left(\Delta_+ + 2\sqrt{(GM)^2 - a^2 \epsilon} \right) = -\frac{\rho_+^2}{C_+^2} 2\sqrt{(GM)^2 - a^2 \epsilon} < 0 \text{ for } \epsilon > 0.$$

□

$$\begin{aligned} \Rightarrow -\frac{N^2 \Delta}{\rho^2} &= (\Omega - \Omega_H)^2 g_{\phi\phi} - \frac{\rho^2 \Delta}{X} \\ \Rightarrow N^2 &= -\rho^2 \frac{(\Omega - \Omega_H)^2}{\Delta} g_{\phi\phi} + \frac{\rho^4}{X} \xrightarrow[\Omega \rightarrow \Omega_H]{\Delta \rightarrow 0} \frac{\rho^4}{X} \end{aligned}$$

so if we define κ from $\nabla_a \chi^2 = -2\kappa \chi_a$, κ surface gravity, we get $\nabla_a \chi^2 = -\frac{\rho^2}{X} \partial_r \Delta (e_r)_a = -2\kappa \frac{\rho^2}{\sqrt{X}} (e_r)_a$

$$\Rightarrow \kappa = \frac{\partial_r \Delta}{2\sqrt{X}} \text{ with } \partial_r \Delta = \partial_r (r^2 + a^2 - C) \text{ while } C = 2GMr - G(e^2 + m^2)$$

and $\Delta = 0 \Rightarrow r = r_+ = GM + \sqrt{(GM)^2 - a^2 - G(e^2 + m^2)}$

so $\partial_r \Delta_+ = 2r_+ - 2GM = 2\sqrt{(GM)^2 - a^2 - G(e^2 + m^2)}$ and $X_+ = R_+^4 - \Delta a^2 \sin^2 \theta = R_+^4 \Rightarrow \sqrt{X_+} = R_+^2 = r_+^2 + a^2$

then

$$\begin{aligned} \sqrt{X_+} &= (GM)^2 + (GM)^2 - a^2 - G(e^2 + m^2) + 2GM\sqrt{(GM)^2 - a^2 - G(e^2 + m^2)} + a^2 \\ &= 2GM \left(GM + \sqrt{(GM)^2 - a^2 - G(e^2 + m^2)} \right) - G(e^2 + m^2) \end{aligned}$$

and finally

$$\kappa = \frac{\sqrt{(GM)^2 - a^2 - G(e^2 + m^2)}}{2GM \left(GM + \sqrt{(GM)^2 - a^2 - G(e^2 + m^2)} \right) - G(e^2 + m^2)}$$

6.3.2 Parallel with thermodynamics

We have seen $\Omega_H = \frac{Ca}{X}|_+ = \frac{R_+^2 a}{R_+^4} = \frac{a}{\sqrt{X_+}}$

$$\text{so } \kappa = \frac{\sqrt{(GM)^2 - a^2 - G(e^2 + m^2)}}{\sqrt{X_+}} = \sqrt{(GM)^2 - a^2 - G(e^2 + m^2)} \frac{\Omega_H}{a}$$

Moreover, setting $e = m = 0$, since $2M_{irr} \delta M_{irr} = \frac{\delta A}{16\pi G^2} = \frac{a}{2G\sqrt{(GM)^2 - a^2 \Omega_H}} (\delta M - \Omega_H \delta J)$

we then have

$$\begin{aligned} \frac{\delta A}{16\pi G^2} &= \frac{1}{2G\kappa} (\delta M - \Omega_H \delta J) \\ \Leftrightarrow \delta M &= \frac{\kappa}{8\pi G} \delta A + \Omega_H \delta J \end{aligned}$$

Law	Thermodynamics	B.H.
0 th	T constant in equilibrium system	$\kappa = cst$ on horizon of stationary B.H.
1 st	$dE = TdS + \text{work done}$	$dM = \frac{\kappa}{8\pi G} dA + \Omega_H dJ$
2 nd	$\delta S \geq 0$ in any process	$\delta A \geq 0$ in any process
3 rd	impossible to achieve $T = 0$ by physical process	impossible to achieve $\kappa = 0$ by physical process

Table 6.1: Black Hole Thermodynamics analogy

Recall First law of thermodynamics

$$dE = TdS - PdV$$

where E energy, S entropy, T temperature, P pressure and V volume of the system.

- PdV is elementary work done on system
- $\Omega_H \delta J$ can be seen as work done on B.H. by sending $\delta J < 0$ particles in it.
- δM is variation of mass-energy of B.H.

Then we can propose the analogy

$$\begin{aligned} E &\longleftrightarrow M \\ S &\longleftrightarrow \frac{A}{4G} \\ T &\longleftrightarrow \frac{\kappa}{2\pi} \end{aligned}$$

Normalisation is fixed from the Black Body Temperature of Hawking radiation being $T = \frac{k\kappa}{2\pi cV}$ where $V = \sqrt{-K^a K_a} \xrightarrow{r \rightarrow \infty} 1$

We can then extend the analogy (see Table 6.1)

0th **law** we have shown $\mathcal{L}_\chi \kappa = 0$ for stationary B.H.

1st **law** we just shown it

2nd **law** consequence of B.H. area theorem, we have shown

$$\frac{\delta A}{16\pi G^2} = \delta M_{irr}^2 > 0$$

in any process of Penrose

3rd **law** only extremum B.H., that is $(GM)^2 = a^2 + G(e^2 + m^2)$, yields $\kappa = 0$.

Wald [Wald(1974), Wald(1984)] shown it gets harder and harder from non-extremal B.H. to go near extremal

However, at $\kappa = 0$, $A \neq 0$ contrary to $S = 0$ for $T = 0$ in thermodynamics!

Finally Bekenstein [Bekenstein(1973)] showed a generalised entropy combines B.H. and matter

$$S' = S + \frac{1}{4} k \frac{c^3 A}{G\hbar}$$

such as $\delta S' \geq 0$

Chapter 7

Relativistic Thermodynamics

John M. Stewart [[Stewart\(1971\)](#)] "Non-Equilibrium Relativistic Kinetic Theory"

Two main approaches to extending thermodynamics to relativistic fluids and gravitation.

This is distinct from Black Hole thermodynamics: non-singular fluids, starting from perfect fluid

Connected to Fourier heat transport, fluid entropy and conservation or increase of entropy.

Assume particle number conservation (decays and particle physics not treated)

Recall $a, b \in [0; 3]$ spacetime indices

$\mu, \nu \in [1; 3]$ space indices

$N^a = nu^a$ particle flow, u^a : flow 4-velocity

n particle number density

u^a timelike: $u^a u_a = -1$

At rest, $N^\mu = 0$ conservation: $N_{,0}^0 = 0$ (Newtonian)

$N_{;a}^a = 0$ (Relativistic)

7.1 Eckart's model

7.1.1 Energy-momentum tensor

Decomposed into: -perfect fluid
-rest

$$T^{ab} = T_{PF}^{ab} + \Delta T^{ab}$$

$$N^a = nu^a + \Delta N^a \quad \rightarrow \Delta N^a = 0 \text{ assumed for conserved particle number}$$

$$\Rightarrow N^a \parallel n^a$$

$$\Rightarrow T^{ab} = (\rho + P) u^a u^b + P g^{ab} + \Delta T^{ab} = \rho u^a u^b + P h^{ab} + \Delta T^{ab}$$

for ρ : energy density $h^{ab} = g^{ab} + u^a u^b$: projector $\perp u^a$
 P : isotropic pressure

We have the Bianchi identity for P.F.: $T_{PF}^{ab}{}_{;b} = P^{;a} + [(\rho + P) u^a u^b]_{;b}$
particle number conservation: $N^a{}_{;a} = nu^a{}_{;a} + u^a n_{;a}$
 $= \dot{n} + nu^a{}_{;a}$
 $= 0$

Projected along the flow

$$\begin{aligned} u_a T_{PF}^{ab}{}_{;b} &= u^a P_{;a} - [(\rho + P) u^b]_{;b} + (\rho + P) \underbrace{u^b u^a{}_{;b} u_a}_0 \\ &= \dot{P} - [(\rho + P) u^b]_{;b} \\ &= u^b P_{;b} - \left[\frac{\rho + P}{n} nu^b \right]_{;b} = u^b P_{;b} - \left[\frac{\rho + P}{n} \right]_{;b} N^b \quad (N \text{ conserved}) \\ &= -N^b \left(\frac{\rho}{n} \right)_{;b} + u^b P_{;b} - \frac{P_{;b}}{n} nu^b - P \left(\frac{1}{n} \right)_{;b} N^b \\ &= -N^a \left[\left(\frac{\rho}{n} \right)_{;a} + P \left(\frac{1}{n} \right)_{;a} \right] \end{aligned}$$

Now Gibb's equation applied to densities reads

$$\begin{aligned} du = Tds - Pdv \quad u = \frac{\rho}{n} &: \text{energy per particle} \\ s = k\sigma &: \text{entropy per particle (} k \text{ Planck constant)} \\ v = \frac{1}{n} &: \text{volume per particle} \end{aligned}$$

$$\Rightarrow d\left(\frac{\rho}{n}\right) = kT d\sigma - Pd\left(\frac{1}{n}\right)$$

$$\boxed{d\left(\frac{\rho}{n}\right) + Pd\left(\frac{1}{n}\right) = kT d\sigma}$$

We recognise the term in the energy-momentum conservation along the flow

$$\begin{aligned} u_a T_{PF}^{ab}{}_{;b} &= -nu^a \left[\left(\frac{\rho}{n} \right)_{;a} + P \left(\frac{1}{n} \right)_{;a} \right] = -nu^a kT \sigma_{;a} \\ &\stackrel{\text{P. cons.}}{=} -kT (nu^a \sigma)_{;a} \end{aligned}$$

7.1.2 Full energy-momentum tensor

$$\begin{aligned} u_a T^{ab}{}_{;b} &= 0 \\ \Leftrightarrow (nu^a \sigma)_{;a} &= \frac{1}{kT} u_a \Delta T^{ab}{}_{;b} \end{aligned}$$

This can be rewritten to define Eckart's entropy flow/current

$$\begin{aligned} \left(nk u^a \sigma - \frac{1}{T} u_b \Delta T^{ab} \right)_{;a} &= \frac{1}{T} u_a \Delta T^{ab}{}_{;b} - \frac{1}{T} u_b \Delta T^{ab}{}_{;a} - \frac{1}{T} u_{b;a} \Delta T^{ab} + \frac{1}{T^2} u_b \Delta T^{ab} T_{;a} \\ &= -\frac{1}{T} u_{a;b} \Delta T^{ab} + \frac{1}{T^2} u_a \Delta T^{ab} T_{;b} \\ &= S^a{}_{;a} \end{aligned}$$

Defining R^a , that depends up to 1st order in ΔT^{ab} ,

$$S^a = S_{PF}^a + \frac{1}{T} R^a \quad (R^a = -u_b \Delta T^{ab})$$

The 2nd law of thermodynamics is then expressed as

$$\boxed{S^a{}_{;a} \geq 0}$$

Recall General 2-tensor decomposition along u^a

$$V_{ab} = Au_a u_b + B_a u_b + C_b u_a + F_{ab} \text{ always possible with } B_a u^a = C_a u^a = 0$$

$$\text{and } F_{ab} = h_a^c h_b^d V_{cd} \Rightarrow F_{ab} u^a = F_{ab} u^b = 0$$

We can decompose further into symmetric and antisymmetric parts

$F_{ab} = F_{(ab)} + F_{[ab]}$ and the symmetric part yields the trace and projected symmetric tracefree (PSTF):

$$F_{(ab)} = \frac{1}{3} h_{ab} F^c{}_c + F_{\langle ab \rangle} \text{ with } F_{\langle ab \rangle} = h_a^c h_b^d [F_{(cd)} - \frac{1}{3} h_{cd} F^{ef} h_{ef}] \text{ so}$$

$$V_{ab} = Au_a u_b + B_a u_b + C_b u_a + \frac{h_{ab}}{3} h^{cd} V_{cd} + V_{\langle ab \rangle} + \underbrace{h_a^c h_b^d V_{[cd]}}_{0 \text{ for } V \text{ sym.}}$$

Restrict to V symmetric

$$V_{ab} = Au_a u_b + 2B_{\langle a} u_{b \rangle} + \frac{h_{ab}}{3} h^{cd} V_{cd} + V_{\langle ab \rangle}$$

Apply to T^{ab}

$$T^{ab} = T_{PF}^{ab} + \Delta T^{ab} \text{ yields}$$

$$\Delta T_{ab} = \pi h_{ab} + 2q_{\langle a} u_{b \rangle} + \pi_{ab} (+Au_a u_b)$$

with $\pi_{ab} = \pi_{\langle ab \rangle}$

If we choose u^a such that

out of equilibrium quantities match quantities in equilibrium

$$\begin{array}{ccc} \tilde{\rho} & \longrightarrow & \rho \\ \tilde{n} & \longrightarrow & n \\ \tilde{P} & \longrightarrow & P + \pi \end{array}$$

then $A = 0$ and we have

$$T_{ab} = \rho u_a u_b + \begin{array}{c} (P + \pi) h_{ab} \\ \downarrow \\ \text{bulk viscous} \\ \text{pressure} \end{array} + \begin{array}{c} + 2q_{\langle a} u_{b \rangle} \\ \downarrow \\ \text{heat} \\ \text{flow} \end{array} + \begin{array}{c} \pi_{ab} \\ \downarrow \\ \text{anisotropic} \\ \text{stress} \end{array}$$

and the entropy flow $S^a = \underbrace{k\sigma}_{S} nu^a + \frac{R^a}{T}$ with S specific entropy scalar

Following Eckart's postulate

$$\begin{aligned} R^a &= -u_b \Delta T^{ab} \\ &= -u_b \left(\pi h^{ab} + 2q^{(a} u^{b)} + \pi^{ab} \right) \\ &= -u_b q^a u^b - u_b q^b u^a = q^a \end{aligned}$$

so $S^a = SN^a + \frac{q^a}{T}$ Eckart Entropy

From the second law of thermodynamics application:

$$\begin{aligned} S^a_{;a} &= \left(-\frac{1}{T} u_{a;b} + \frac{1}{T^2} u_a T_{;b} \right) \Delta T^{ab} = -\Delta T^{ab} \left[\frac{1}{T} u_a \right]_{;b} \geq 0 \\ \Rightarrow TS^a_{;a} &= - \left[\pi h^{ab} + 2q^{(a} u^{b)} + \pi^{ab} \right] \left(u_{a;b} - u_a \frac{T_{;b}}{T} \right) \end{aligned}$$

Here we further decompose the flow derivative

$$u_{a;b} = -\dot{u}_a u_b + \frac{\Theta}{3} h_{ab} + \sigma_{\langle ab \rangle} + \omega_{[ab]}$$

with $\dot{u}_a = u^b u_{a;b}$: acceleration
 $\Theta = u^a_{;a}$: expansion
 $\sigma_{\langle ab \rangle} = u_{\langle a;b \rangle}$: shear
 $\omega_{[ab]} = h^c_a h^d_b u_{[c;d]}$: vorticity

So

$$\begin{aligned} TS^a_{;a} &= - \left[\pi \Theta + q^a \dot{u}_a + \pi^{ab} \sigma_{ab} \right] + \frac{1}{T} \left[\pi h^{ab} + 2q^{(a} u^{b)} + \pi^{ab} \right] (u_a T_{;b}) \\ &= - \left[\pi \Theta + q^a \left(\dot{u}_a + \frac{T_{;a}}{T} \right) + \pi^{ab} \sigma_{ab} \right] \geq 0 \end{aligned}$$

This constraint leads to Eckart's assumptions (with each $u_{a;b}$ terms independent)

$$\left. \begin{aligned} \pi &= -\zeta \Theta \\ q_a &= -\chi (T_{;a} + T \dot{u}_a) \\ \pi_{ab} &= -2\eta \sigma_{ab} \end{aligned} \right\} \text{Eckart constitutive equations with } \left. \begin{aligned} \zeta &: \text{bulk viscosity} \\ \chi &: \text{heat conductivity} \\ \eta &: \text{shear viscosity} \end{aligned} \right\} > 0$$

where we recognise the equations for

q_a : Fourier transport equation
 π_{ab} : Newton shear viscosity
 π : Stokes law of fluid mechanics

so the entropy derivative is quadratic in π, q^a, π^{ab}

$$S^a_{;a} = \frac{\pi^2}{\zeta T} + \frac{q^a q_a}{\chi T} + \frac{\pi^{ab} \pi_{ab}}{2\eta T} \quad (= 0 \text{ for perfect fluid})$$

(\Rightarrow P.F. always evolve adiabatically) while the entropy flow is 1st order in π, q^a, π^{ab} through R^a

$$S^a = SN^a + \frac{q^a}{T}$$

7.1.3 Problem with Eckart's model

Algebraic relations between flow and fluid quantities

\Rightarrow infinite propagation speed

\Rightarrow unstable perturbations from equilibrium of the flow: $\dot{u} = 0$
 $\Theta = 0$
 $\sigma = 0$

\rightarrow need for a better model: Israel-Stewart

7.2 Israel-Stewart model

Find R^a up to 2nd order. Add to Eckart 2nd order terms: postulate the form

$$R^a = q^a - \frac{u^a}{2} (\beta_0 \pi^2 + \beta_1 q_b q^b + \beta_2 \pi^{bc} \pi_{bc}) \quad (\text{quadratic terms})$$

$$+ \alpha_0 \pi q^a + \alpha_1 \pi^{ab} q_b \underbrace{(+\alpha_2 \pi u_b \pi^{ab})}_0 \quad (\text{cross terms})$$

orthogonal

which yields the entropy flow

$$S^a = SN^a + \frac{1}{T} \left[q^a - \frac{u^a}{2} (\beta_0 \pi^2 + \beta_1 q_b q^b + \beta_2 \pi^{bc} \pi_{bc}) + \alpha_0 \pi q^a + \alpha_1 \pi^{ab} q_b \right] \quad \rightarrow \text{heat/viscosity coupling}$$

and along the flow (comoving observer's entropy)

$$u_a S^a = -nS + \frac{1}{2T} (\beta_0 \pi^2 + \beta_1 q_b q^b + \beta_2 \pi^{bc} \pi_{bc})$$

Since it doesn't depend on the α_i terms, we neglect them and assume for the rest that $\alpha_i = 0$

Thus

$$S^a = S_E^a - \frac{u^a}{2T} (\beta_0 \pi^2 + \beta_1 q_b q^b + \beta_2 \pi^{bc} \pi_{bc})$$

and

$$TS^a_{;a} = TS^a_{E;a} - \frac{T}{2} \left[\frac{u^a}{T} (\beta_0 \pi^2 + \beta_1 q_b q^b + \beta_2 \pi^{bc} \pi_{bc}) \right]_{;a}$$

$$= TS^a_{E;a} - \Delta (TS^a_{;a})$$

We have seen previously that

$$TS^a_{;a} = - \left[\pi \Theta + q^a \left(\dot{u}_a + \frac{T_{;a}}{T} \right) + \pi^{ab} \sigma_{ab} \right]$$

and

$$\begin{aligned} \Delta(TS^a_{;a}) &= \frac{T}{2} \left(\frac{u^a}{T} \right)_{;a} (\beta_0 \pi^2 + \beta_1 q_b q^b + \beta_2 \pi^{bc} \pi_{bc}) + u^a (\beta_0 \pi \pi_{;a} + \beta_1 q^b q_{b;a} + \beta_2 \pi^{bc} \pi_{bc;a}) \\ &= \beta_0 \pi \left(\dot{\pi} + \frac{T}{2} \pi \left(\frac{u^a}{T} \right)_{;a} \right) + \beta_1 q^b \left(\dot{q}_b + \frac{T}{2} q_b \left(\frac{u^a}{T} \right)_{;a} \right) + \beta_2 \pi^{bc} \left(\dot{\pi}_{bc} + \frac{T}{2} \pi_{bc} \left(\frac{u^a}{T} \right)_{;a} \right) \end{aligned}$$

Therefore

$$\begin{aligned} TS^a_{;a} &= - \pi \left[\Theta + \beta_0 \dot{\pi} + \frac{T}{2} \left(\frac{\beta_0 u^a}{T} \right)_{;a} \pi \right] \\ &\quad - q^a \left[\frac{T_{;a}}{T} + \dot{u}_a + \beta_1 \dot{q}_a + \frac{T}{2} \left(\frac{\beta_1 u^b}{T} \right)_{;b} q_a \right] \\ &\quad - \pi^{ab} \left[\sigma_{ab} + \beta_2 \dot{\pi}_{ab} + \frac{T}{2} \left(\frac{\beta_2 u^c}{T} \right)_{;c} \pi_{ab} \right] \geq 0 \end{aligned}$$

The last condition imposed by the 2nd law of thermodynamics

In order to keep $TS^a_{;a}$ quadratic and thus the 2nd law, we can choose each square bracket proportional to their respective factors π, q^a, π^{ab} (recall $q^a = h^a_b q^b, \pi^{ab} = h^a_c h^b_d \pi^{cd}$)

$$\left\{ \begin{array}{ll} \zeta \beta_0 \dot{\pi} + \pi = -\zeta \Theta - \zeta \left[\frac{T}{2} \left(\frac{\beta_0 u^a}{T} \right)_{;a} \pi \right] & \text{(from } \pi = -\zeta \square_{\pi} \text{)} \\ \chi T \beta_1 h^b_a \dot{q}_b + q_a = -\chi (h^b_a T_{;b} + T \dot{u}_a) - \chi \left[\frac{T^2}{2} \left(\frac{\beta_1 u^b}{T} \right)_{;b} q_a \right] & \text{(from } q_a = -\chi T \square_{q} \text{)} \\ 2\eta \beta_2 h^c_a h^d_b \dot{\pi}_{cd} + \pi_{ab} = -2\eta \sigma_{ab} - \eta \left[T \left(\frac{\beta_2 u^c}{T} \right)_{;c} \pi_{ab} \right] & \text{(from } \pi_{ab} = -2\eta \square_{\pi_{ab}} \text{)} \end{array} \right.$$

Israel-Stewart equations with the same ζ : bulk viscosity
 χ : heat conductivity
 η : shear viscosity

which ensure

$$TS^a_{;a} = \frac{\pi^2}{\zeta} + \frac{q^a q_a}{\chi} + \frac{\pi^{ab} \pi_{ab}}{2\eta} \geq 0$$

for $\zeta, \chi, \eta > 0$ and define the relaxation times

$$\left\{ \begin{array}{l} \tau_0 = \zeta \beta_0 \\ \tau_1 = \chi T \beta_1 \\ \tau_2 = 2\eta \beta_2 \end{array} \right. \quad \text{and recall } \tau \sim \frac{1}{n\sigma v}$$

If we neglect the 2nd R.H.S. terms (collisional time small) we obtain the truncated I-S equations

$$\begin{cases} \tau_0 \dot{\pi} + \pi = -\zeta \Theta \\ \tau_1 h_a^b \dot{q}_b + q_a = -\chi (h_a^b T_{;b} + T \dot{u}_a) \\ \tau_2 h_a^c h_b^d \dot{\pi}_{cd} + \pi^{ab} = -2\eta \sigma_{ab} \end{cases}$$

which introduce dynamic corrections to the Eckart equations.

We assume to be close to equilibrium

$$\begin{aligned} |\pi| &\ll P \\ (\pi^{ab} \pi_{ab})^{\frac{1}{2}} &\ll P \\ (q^a q_a)^{\frac{1}{2}} &\ll \rho \end{aligned}$$

and thus

$$\begin{aligned} S^a_{;a} &= \left(S N^a + \frac{R^a}{T} \right)_{;a} = n \dot{S} + \left(\frac{R^a}{T} \right)_{;a} \quad (\text{part. nb con.}) \\ &= n \dot{S} + \left(\frac{q^a}{T} \right)_{;a} + \left(\frac{\Delta R^a}{T} \right)_{;a} \simeq n \dot{S} + \left(\frac{q^a}{T} \right)_{;a} \end{aligned}$$

and

$$T S^a_{;a} = T S^a_{E;a} - \Delta (T S^a_{;a}) \simeq T S^a_{E;a}$$

we have in Eckart and Israel-Stewart models in that case

$$\boxed{T n \dot{S} = -\pi \Theta - q^a \dot{u}_a - q^a_{;a} - \pi^{ab} \sigma_{ab}}$$

Specific entropy evolution: measures evolution of entropy of the fluid along the flow

Example 7.1. Entropy contained in comoving FLRW volume

$$\begin{aligned} \Sigma &= \int (-S^a u_a) \frac{dV}{v} = \left[S n - \frac{1}{2} (\beta_0 \pi^2 + \beta_1 q_b q^b + \beta_2 \pi^{bc} \pi_{bc}) \right] a^3 \\ &= a^3 n S : \end{aligned}$$

$$\boxed{\Sigma = a^3 n S} \text{ with the previous assumptions}$$

Chapter 8

Tetrads and Newman-Penrose Tetrads

We saw $1+3$
 $1+1+2$ formalisms in congruences
 $2+2$
 $(e_\mu)^a \perp T^a$ in singularities

8.1 Tetrads

Some vectors can be decomposed on others

Vectors as components in coordinate basis $V = V^a \partial_a$
can be generalised as tetrads $V = V^A e_A$

Following Chandrasekhar [Chandrasekhar(1985)] "The mathematical theory of black holes", Ashtekar [Ashtekar *et al.*(2000)Ashtekar, Fairhurst, and Krishnan] "Isolated horizons: Hamiltonian evolution and the first law" Appendix B, Trautman "Einstein-Cartan theory", and Newman-Penrose formalism, Vaidya metric we explore tetrads.

In 4D spacetime: tetrads vector labels $:A, B, \dots : e_A$
spacetime indices $:a, b, \dots : \partial_a$

so $e_A = e_A^i \partial_i$ with $\left. \begin{matrix} i \\ A \end{matrix} \right\} \in [0; 3]$ or $i \in [0; 3]$
 $A \in [\square, I, II, III]$

Also designated e_A^i with corresponding forms
 $e_A^i = g_{ij} e_B^j$, g_{ij} metric ($e_A = e_A^i dx^i$)

Assume e_A orthonormal and e_\square timelike, e_I, e_{II}, e_{III} spacelike (or noted $e_{(0)}$ and $e_{(1)}, e_{(2)}, e_{(3)}$) then

$$g_{ij} e_A^i e_B^j = \eta_{AB} = (e_A, e_B)$$

with η Minkowski metric. This can be seen as the line element in tangent

Minkowski space

$$g_{ij}e_A^i e_B^j dx^A dx^B = \eta_{AB} dx^A dx^B = ds_{MT}^2 = (e_A, e_B) x^A dx^B$$

Note in general e_A is not orthonormal and $(e_A, e_B) = \eta_{AB}$ metric of general tangent manifold to spacetime.

For most of the rest, we assume η constant Minkowski

$$\exists \eta^{AB} \text{ inverse: } \eta^{AC} \eta_{CB} = \delta_B^A$$

$\Rightarrow \eta^{AB} e_B = e^A = e_i^A dx^i$ inverse form basis, so line element in spacetime can be seen as

$$\begin{aligned} \eta_{AB} e^A e^B &= \eta_{AB} e_i^A e_j^B dx^i dx^j = g_{ij} dx^i dx^j = ds^2 \\ &= \eta_{AB} \eta^{AC} e_C \eta^{BD} e_D \\ &= \delta_B^C \eta^{BD} e_C e_D = \eta^{CD} e_C e_D = e^D e_D \end{aligned}$$

so $g_{ij} = \eta_{AB} e_i^A e_j^B$

$$\exists g^{ij} \text{ inverse: } g^{ik} g_{kj} = \delta_j^i \text{ and}$$

$$\eta_{AB} e^B = \eta_{AB} \eta^{BC} e_C = \delta_A^C e_C = e_A \Rightarrow (\eta_{AB} e^B)^i \partial_i = e_A^i \partial_i = \eta_{AB} e_j^B g^{ij} \partial_i$$

$$\text{Samely } e^A = \eta^{AB} e_B \Rightarrow (\eta^{AB} e_B)^i \partial_i = e_j^A g^{ij} \partial_i$$

while

$$\begin{aligned} \delta_j^i &= g^{ik} g_{kj} = \eta_{AB} e_k^A e_j^B g^{ik} \\ &= e_B^i e_j^B : e_i^A \text{ spacetime inverse of } e_A^j \end{aligned}$$

Thus as

$$\begin{aligned} \eta^{AB} e_A^i e_B^k g_{kj} &= e_A^i e_l^A g^{kl} g_{kj} \\ &= \delta_l^i \delta_j^l = \delta_j^i = g^{ik} g_{kj} \end{aligned}$$

we also have

$$g^{ij} = \eta^{AB} e_A^i e_B^j$$

as well as

$$\begin{aligned} \delta_B^A &= \eta^{AC} \eta_{CB} = \eta^{AC} g_{ij} e_C^i e_B^j \\ &= e_B^j \eta^{AC} e_C^i g_{ij} \\ &= e_B^j e_j^A : e_i^A \text{ tangent space inverse of } e_B^i \end{aligned}$$

$$\text{and finally } g^{ij} e_i^A e_j^B = \eta^{AC} e_C^j e_j^B = \eta^{AC} \delta_C^B = \eta^{AB}$$

In summary Basis $e_A = e_i^A \partial_i$, inverse form basis $\eta^{AB} e_B = e^A = e_i^A dx^i$

$$\begin{array}{l} \text{orthonormalisation} \quad \eta_{AB} = g_{ij} e_A^i e_B^j \\ \text{inverse:} \quad \eta^{AB} = g^{ij} e_i^A e_j^B \quad \text{as } \eta^{AC} \eta_{CB} = \delta_B^A \\ \text{tangent space metric} \end{array}$$

spacetime line element $ds^2 = \eta_{AB}e^Ae^B$ metric $g_{ij} = \eta_{AB}e^A_i e^B_j$
 inverse metric $g^{ij} = \eta^{AB}e^i_A e^j_B$ as $g^{ik}g_{kj} = \delta^i_j$
 form basis $e_A = e^i_A g_{ij} dx^j$ vector inverse basis $e^A = e^A_j g^{ij} \partial_i$
 so components of basis inverse of components of form basis
 right inverse: $e^A_j e^i_A = \delta^i_j$ spacetime inverse
 left inverse: $e^i_A e^B_i = \delta^B_A$ tangent space inverse
 and we can define form component $g_{ij}e^j_A = e_{A i}$
 vector component $g^{ij}e^A_j = e^{A i}$

Since, choosing e_{\square} timelike,

$$\eta_{AB} = \eta^{AB} = \begin{pmatrix} -1 & 0 & 0 & 0 \\ 0 & 1 & 0 & 0 \\ 0 & 0 & 1 & 0 \\ 0 & 0 & 0 & 1 \end{pmatrix}$$

$e^A_i = \eta^{AB}e_{B i}$ then $e^{\square}_i = -e_{\square i}$ and $e^{(\mu)}_i = -e_{(\mu) i}, \mu \in [1; 3]$ so the metric reads

$$g_{ij} = e^{\square}_i e^{\square}_j + e^I_i e^I_j + e^II_i e^II_j + e^III_i e^III_j \\ = -e_{\square i} e_{\square j} + e_{I i} e_{I j} + e_{II i} e_{II j} + e_{III i} e_{III j}$$

(recall 1+1+2)

8.1.1 Tetrad tensor components

Any tensor can be projected onto tetrad frame

$$A_A = e_{A i} A^i = e^i_A A_i \text{ for 1- tensors} \\ A^A = \eta^{AB} A_B = e^A_i A^i = e^{A i} A_i$$

with spacetime tensors given by

$$A^i = e^i_A A^A = e^{A i} A_A, \quad A_i = e^A_i A_A = e_{A i} A^A$$

For a 2-tensor

$$T_{AB} = e^i_A e^j_B T_{ij} = e^i_A T_{iB}$$

inverted by

$$T_{ij} = e^A_i e^B_j T_{AB} = e^A_i T_{Aj}$$

Indices are contracted, raised and lowered with respective metrics

8.1.1.1 Note on 2-tensors and their matrix representation

The tensorial product has no order, keeping origin in mind

$$T_{abc}X_{de} = X_{de}T_{abc}$$

same numbers but

$$A_{abcde} \equiv T_{abc}X_{de} \neq X_{de}T_{abc}$$

Contractions only care about index positions

$$T_{ab}X^{bc} = X^{bc}T_{ab} \neq X^{cb}T_{ab} \text{ unless } X \text{ symmetric}$$

Symmetrisations require indices at same level in general: $T_{[a}^{b]}$ has no sense

$$\text{Trace is contraction with metric } T_a^a = T_{ab}g^{ab}$$

Matrix representation of 2-tensors

$$[T_{ab}] = [T_{a1}, \dots, T_{an}] = \begin{bmatrix} T_{1b} \\ \vdots \\ T_{nb} \end{bmatrix}$$

Line or column division is selected when using matrix product to represent tensor contraction. Then first index stands for line number while second is column number. Index position is encoded in matrix relative position for contraction.

Example 8.1.

$$A_{ab} = \begin{pmatrix} 0 & A_{01} & 0 & 0 \\ 0 & A_{11} & 0 & 0 \\ 0 & 0 & 0 & 0 \\ 0 & 0 & 0 & 0 \end{pmatrix} = A_{01}\delta_a^0\delta_b^1 + A_{11}\delta_a^1\delta_b^1$$

$$B^{ab} = \begin{pmatrix} B^{00} & B^{01} & 0 & 0 \\ 0 & 0 & 0 & 0 \\ 0 & 0 & 0 & 0 \\ 0 & 0 & 0 & 0 \end{pmatrix} = B^{00}\delta_0^a\delta_0^b + B^{01}\delta_0^a\delta_1^b$$

same order as matrix product

$$A_{ac}B^{cb} = 0 = (A_{01}\delta_a^0\delta_c^1 + A_{11}\delta_a^1\delta_c^1) (B^{00}\delta_0^c\delta_0^b + B^{01}\delta_0^c\delta_1^b)$$

$$= A_{01}B^{00}\delta_a^0\delta_0^b\delta_0^1 + A_{01}B^{01}\delta_a^0\delta_0^b\delta_0^1 + A_{11}B^{00}\delta_a^1\delta_0^b\delta_0^1 + A_{11}B^{01}\delta_a^1\delta_0^b\delta_0^1 = 0$$

opposite order

$$A_{cb}B^{ac} = [B^{ac}][A_{cb}] = \begin{pmatrix} 0 & A_{01}B^{00} + A_{11}B^{01} & 0 & 0 \\ 0 & 0 & 0 & 0 \\ 0 & 0 & 0 & 0 \\ 0 & 0 & 0 & 0 \end{pmatrix}$$

$$= (A_{01}\delta_c^0\delta_b^1 + A_{11}\delta_c^1\delta_b^1) (B^{00}\delta_0^a\delta_0^c + B^{01}\delta_0^a\delta_1^c)$$

$$= A_{01}B^{00}\delta_b^1\delta_0^a\delta_0^0 + A_{01}B^{01}\delta_b^1\delta_0^a\delta_0^1 + A_{11}B^{00}\delta_b^1\delta_0^a\delta_0^1 + A_{11}B^{01}\delta_b^1\delta_0^a\delta_0^1$$

$$= (A_{01}B^{00} + A_{11}B^{01})\delta_0^a\delta_b^1$$

traces: $A = A_{01}g^{01} + A_{11}g^{11} \neq A_{11}$, $B = B^{00}g_{00} + B^{01}g_{01} \neq B^{00}$
 Trace = matrix trace only for A_a^b or B_b^a !

8.1.2 Directional derivatives, connections and Ricci rotation coefficients

Recall: Vectors are differential operators

$e_A = e_A^i \partial_i$ generalises with covariant derivative $e_A = e_A^i \nabla_i = \nabla_{e_A} = \nabla_A$
 Partial derivatives generalise as (ϕ scalar function)

$$\phi_{,A} = e_A^i \partial_i \phi = e_A^i \phi_{,i} = e_A^i \phi_{;i} \text{ for scalars}$$

Applied to a form

$$\begin{aligned} A_{A;B} &= e_B^i \nabla_i A_A = e_B^i \nabla_i (e_A^j A_j) = e_B^i \nabla_{\partial_i} (e_A^j A_j) \\ &= e_B^i \left[e_A^j A_{j;i} + A_j e_{A;i}^j \right] \\ &= e_A^j A_{j;i} e_B^i + e_B^i e_{A;j}^i e_C^j A^C \end{aligned}$$

Recall: connection defined by $\nabla_b \partial_a = \Gamma_{ab}^c \partial_c$

Proof. Connection definition

From directional derivative of a vector $\nabla_X Y$ in a basis e_A

$$X^A \nabla_{e_A} (Y^B e_B) = X^A Y_{,A}^B e_B + Y^B X^A \nabla_{e_A} e_B$$

define connection as decomposition of $\nabla_{e_A} e_B$ on e_C

$$\begin{aligned} \nabla_{e_A} e_B &= \omega_{BA}^C e_C \\ \Rightarrow \nabla_X Y &= X^A (Y_{,A}^B e_B + Y^B \omega_{BA}^C e_C) \\ &= X^A (Y_{,A}^C + Y^B \omega_{BA}^C) e_C = X^A (\nabla_{e_A} Y)^C e_C \\ \Rightarrow (\nabla_{e_A} Y)^C &= Y_{,A}^C + Y^B \omega_{BA}^C \end{aligned}$$

Choose $e_A = \partial_a$, $Y = \partial_a = \delta_a^b \partial_b$

$$(\nabla_a \partial_b)^c = (\delta_b^c)_{,a} + \omega_{b'a}^c \delta_b^{b'} = \omega_{ba}^c = \Gamma_{ba}^c$$

or

$$\nabla_a \partial_b = \Gamma_{ba}^c \partial_c$$

□

Here

$$\begin{aligned} \nabla_B e_A &= \Gamma_{AB}^C e_C = \Gamma_{AB}^C e_C^i \partial_i \\ &= e_B^b \nabla_b e_A = e_{A;b} e_B^b = e_{A;b}^i e_B^b \partial_i \end{aligned}$$

⚠ Γ_{AB}^C may not have same symmetries as Γ_{ab}^c !

So connection coefficients read

$$\begin{aligned} e_B^i e_{A;i}^j &= \Gamma_{CAB} \eta^{CD} e_D^j \Rightarrow g_{jk} e_C^k e_{A;i}^j e_B^i = \Gamma_{FAB} \eta^{FD} e_D^j g_{jk} e_C^k \\ &= \Gamma_{FAB} \eta^{FD} \eta_{DC} \\ &= \Gamma_{FAB} \delta_C^F = \Gamma_{CAB} \end{aligned}$$

Defining Ricci rotation coefficients (connection)

$$\begin{aligned} \gamma_{CAB} &= e_C^j e_{A;j}^i e_B^i = \Gamma_{CAB} \text{ we get} \\ A_{A;B} &= e_A^j A_{j;i} e_B^i + \gamma_{CAB} A^C \end{aligned}$$

8.1.2.1 Properties of γ

$$e_{A;i;j} = e_i^C \gamma_{CAB} e_j^B = \delta_i^k e_{A;k;l} \delta_j^l$$

Antisymmetry in first pair: $\gamma_{CAB} = -\gamma_{ACB}$ ($\gamma_{[CA]B} = \gamma_{CAB}$)

Proof. From $0 = \eta_{AB;i} = [e_{A_j} e_B^j]_{;i}$ (not valid for non-orthonormal basis!)

$$\begin{aligned} [e_{A_j} e_B^j]_{;i} &= e_{A_j;i} e_B^j + e_{A_j} e_{B;i}^j \\ &= e_j^C \gamma_{CAD} e_i^D e_B^j + e_{A_j} e^{Cj} \gamma_{CBD} e_i^D \\ &= \gamma_{BADE} e_i^D + \gamma_{ABDE} e_i^D = \eta_{AB;i} = 0 \\ \Rightarrow \gamma_{ABD} &= -\gamma_{BAD} \end{aligned}$$

□

Returning to 1-form directional derivative equation

Totally projected covariant derivative of frame/tetrad defines: intrinsic derivative (notation)

$$\begin{aligned} A_{A|B} &= e_A^i A_{i;j} e_B^j \Leftrightarrow A_{i;j} = e_i^A A_{A|B} e_j^B \\ &= A_{A;B} - \gamma_{NAB} \eta^{NM} A_M \end{aligned}$$

(Notation change: $X_{[a|b|c]}$ to $X_{[A|B|C]} = \eta_{BD} X_{[A}^D C]$)

This can be generalised to any tensor (e.g. Riemann)

So Riemann covariant derivative leads to

$$\begin{aligned} R_{ABCD|F} &= R_{ijkl;m} e_A^i e_B^j e_C^k e_D^l e_F^m \\ \text{with } R_{ABCD;F} &= [R_{ijkl;m} e_A^i e_B^j e_C^k e_D^l]_{;m} e_F^m \\ \Rightarrow R_{ABCD|F} &= R_{ABCD;F} - \eta^{NM} [\gamma_{NAF} R_{MBCD} + \gamma_{NBF} R_{AMCD} + \gamma_{NCF} R_{ABMD} + \gamma_{NDF} R_{ABCM}] \end{aligned}$$

8.1.2.2 Ricci rotation coefficients as Levi-Civita-like connection

The γ can be computed from mere partial derivatives

Define

$$\begin{aligned}\lambda_{ABC} &= e_{B;i;j} \left[e_A^i e_C^j - e_A^j e_C^i \right] \\ &= 2e_{B;i;j} e_A^{[i} e_C^{j]} \\ &= 2e_{B[i;j]} e_A^i e_C^j = [e_{B,i,j} - e_{B,j,i}] e_A^i e_C^j\end{aligned}$$

as covariant derivative connection Γ is symmetric in GR and

$$e_{B[i;j]} = e_{B[i,j]} - \Gamma_{[ij]}^k e_{Bk} = e_{B[i,j]}$$

Moreover, as

$$\begin{aligned}e_A^i e_{B;i;j} e_C^j &= e_A^i e_i^D \gamma_{DBF} e_j^F e_C^j \\ &= \gamma_{ABC}\end{aligned}$$

we have

$$\lambda_{ABC} = \gamma_{ABC} - \gamma_{CBA}$$

By circular permutation and using γ antisymmetry

$$\begin{aligned}\lambda_{ABC} - \lambda_{BCA} + \lambda_{CAB} &= \gamma_{ABC} - \gamma_{CBA} \\ &\quad - \gamma_{BCA} + \gamma_{ACB} \\ &\quad + \gamma_{CAB} - \gamma_{BAC} \\ &= 2\gamma_{ABC} \\ \Leftrightarrow \gamma_{ABC} &= \frac{1}{2} (\lambda_{ABC} - \lambda_{BCA} + \lambda_{CAB})\end{aligned}$$

looking like a Levi-Civita connection for the metric derivative-like λ

By construction $\lambda_{ABC} = -\lambda_{CBA}$

8.1.2.3 Commutation and structure constants

The Lie bracket of tetrad yields an algebra defined by its structure constants

$$\begin{aligned}[e_A, e_B] f &= e_A^i \left[e_B^j f_{,j} \right]_{;i} - e_B^j \left[e_A^i f_{,i} \right]_{;j} \\ &= \left[e_A^i e_B^j_{;i} - e_B^i e_A^j_{;i} \right] f_{,j} \text{ as } f_{,i;j} = f_{,j;i} \\ &= \left[e^{Dj} \gamma_{DBF} e_i^F e_A^i - e^{Dj} \gamma_{DAF} e_i^F e_B^i \right] f_{,j} \\ &= [\gamma_{DBA} - \gamma_{DAB}] e^{Dj} f_{,j} \\ &= [-\gamma_{BDA} + \gamma_{ADB}] \eta^{DC} e_C^j f_{,j} \\ &= (-\gamma_{BA}^C + \gamma_{AB}^C) e_C^j f_{,j} = \left(\gamma_{AB}^j - \gamma_{BA}^j \right) f_{,j} \\ &\equiv C_{AB}^C e_C f = C_{AB}^C e_C^j f_{,j} \\ \Leftrightarrow C_{AB}^C &= \gamma_{BA}^C - \gamma_{AB}^C\end{aligned}$$

(If basis commute, e.g. $\partial_a, C_{AB}^C = 0$)

8.1.2.4 Ricci and Bianchi identities

The Ricci identities applied to tetrads yield

$$2e_{A i[k;l]} = R_{mikl}e_A^m = R_{Aikl}$$

Projecting on the remaining indices

$$\begin{aligned} R_{ABCD} &= R_{Aikl}e_B^i e_C^k e_D^l \\ &= \{e_{A i;k;l} - e_{A i;l;k}\} e_B^i e_C^k e_D^l \\ &= \left\{ [e_{i;l}^F \gamma_{FAC} e_k^G]_{;l} - [e_{i;l}^F \gamma_{FAC} e_l^G]_{;k} \right\} e_B^i e_C^k e_D^l \\ &= \{e_{i;l}^F \gamma_{FAC} e_B^i e_D^l + \gamma_{BAC;D} + \gamma_{BAG} e_{k;l}^G e_C^k e_D^l \\ &\quad - e_{i;k}^F \gamma_{FAD} e_B^i e_C^k - \gamma_{BAD;C} - \gamma_{BAG} e_{l;k}^G e_C^k e_D^l\} \\ &= \gamma_{BAC;D} - \gamma_{BAD;C} + \gamma_{FAC} e_B^i e_i^G \gamma_G^F e_H^H e_D^l - \gamma_{FAD} e_B^i e_i^G \gamma_G^F e_H^H e_C^k \\ &\quad + \gamma_{BAG} [e_C^k e_k^F \gamma_F^G e_H^H e_D^l - e_D^l e_l^F \gamma_F^G e_H^H e_C^k] \\ &= \gamma_{BAC;D} - \gamma_{BAD;C} + \gamma_{FAC} \gamma_B^F \gamma_D^G - \gamma_{FAD} \gamma_B^G \gamma_C^G + \gamma_{BAG} [\gamma_C^G \gamma_D^G - \gamma_D^G \gamma_C^G] \end{aligned}$$

The Bianchi identities can also be expressed as combination of Riemann and Ricci totation coefficients

Bianchi in in coordinates implies, in basis components:

$$R_{ij[kl;m]} = 0 \Leftrightarrow R_{AB[CD|F]} = 0 = e_A^i e_B^j e_C^k e_D^l e_F^m R_{ij[kl;m]}$$

from Riemann symmetries and antisymmetrisation development

$$\begin{aligned} R_{ij[kl;m]} &= \frac{1}{3} [R_{ijkl;m} + R_{ijlm;k} + R_{ijmk;l}] \\ &\Leftrightarrow 0 = \frac{1}{3} [R_{ABCD|F} + R_{ABDF|C} + R_{ABFC|D}] \end{aligned}$$

and

$$\begin{aligned} R_{ABCD|F} &= R_{ABCD;F} - e_{A;m}^i R_{iBCD} e_F^m \\ &\quad - e_{B;m}^j R_{AjCD} e_F^m \\ &\quad - e_{C;m}^k e_F^m R_{ABkD} \\ &\quad - e_{D;m}^l e_F^m R_{ABCl} \end{aligned}$$

each term built on same model

$$\begin{aligned} e_{A;m}^i e_F^m R_{iBCD} &= e^{Gi} \gamma_{GAH} e_m^H e_F^m R_{iBCD} \\ &= \eta^{GN} e_N^i \gamma_{GAF} R_{iBCD} \\ &= \eta^{GN} \gamma_{GAF} R_{NBCD} \end{aligned}$$

so Bianchi identity reads

$$\begin{aligned}
0 &= R_{AB[CD;F]} - \frac{\eta^{NM}}{3} \left\{ \begin{aligned} &-\gamma_{\underline{AN}}^{\underline{NAF}} R_{MB\overline{CD}} + -\gamma_{\underline{AN}}^{\underline{NAC}} R_{MB\overline{DF}} + -\gamma_{\underline{AN}}^{\underline{NAD}} R_{MB\overline{FC}} + \gamma_{\underline{BN}}^{\underline{NBF}} R_{\underline{AM}\overline{CD}} + \gamma_{\underline{BN}}^{\underline{NBC}} R_{\underline{AM}\overline{DF}} + \gamma_{\underline{BN}}^{\underline{NBD}} R_{\underline{AM}\overline{FC}} \\ &+ \gamma_{\underline{CN}}^{\underline{NCF}} R_{\underline{AB}\overline{MD}} + \gamma_{\underline{DN}}^{\underline{NDC}} R_{\underline{AB}\overline{MF}} + \gamma_{\underline{FN}}^{\underline{NFD}} R_{\underline{AB}\overline{MC}} + -\gamma_{\underline{DN}}^{\underline{NDF}} R_{\underline{AB}\overline{CM}} + -\gamma_{\underline{FN}}^{\underline{NFC}} R_{\underline{AB}\overline{DM}} - \gamma_{\underline{CN}}^{\underline{NCD}} R_{\underline{AB}\overline{FM}} \end{aligned} \right\} \\
&= R_{AB[CD;F]} - \frac{\eta^{NM}}{3} \left\{ 2 \left[\gamma_{N[B^iF} R_{iA]M\overline{CD}} + \gamma_{N[B^iD} R_{iA]M\overline{FC}} + \gamma_{N[B^iD} R_{iA]M\overline{FC}} \right] \right. \\
&\quad \left. + \lambda_{FND} R_{\underline{AB}\overline{CM}} + \lambda_{CNF} R_{\underline{AB}\overline{DM}} + \lambda_{DNC} R_{\underline{AB}\overline{FM}} \right\}
\end{aligned}$$

Application (see Ch. 10)

8.1.3 General non-orthonormal tetrads

In case η_{AB} is not Minkowski the Ricci coefficients are NOT antisymmetric but from covariant derivative projection, we get

$$\eta_{AB;i} e_C^i = \eta_{AB;C} = \gamma_{BAC} + \gamma_{ABC} \neq 0$$

Avoiding use of antisymmetry, expression for structure coefficients remains

$$C_{AB}^C = \gamma_{AB}^C - \gamma_{BA}^C$$

It turns out that Ricci and Bianchi identities also retain the same forms

8.2 Tetrads from Einstein-Cartan gravity

Nomenclature tetrad=vierbein=4D $\left| \begin{array}{l} \text{frame} \\ \text{basis} \end{array} \right.$

In n dimensions: vielbein= n D $\left| \begin{array}{l} \text{frame} \\ \text{basis} \end{array} \right.$

One can represent gravity with the frame bundle FM : for a spacetime M of dimension n , $FM = P(GL(n, \mathbb{R}), M, \pi)$ with connection ω , canonical form θ and soldering form $\tilde{\theta}$

Frame bundle: principal bundle with structure group $GL(n, \mathbb{R})$ and projection π on the base M

Definition 8.1. Fiber bundle

Manifold with

- a base manifold: M
- Fibers, isomorphic to the bundle structure group: $F \sim G$, here $G = SO_0(1, 3)$

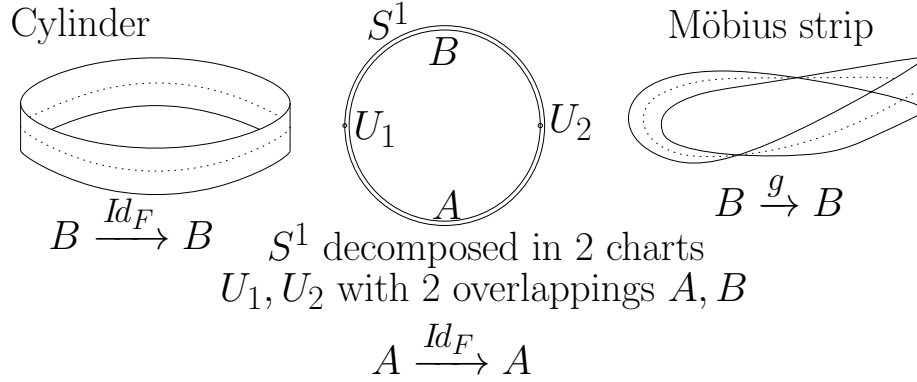

Figure 8.2.1: Cylinder and Möbius strip bundles

- a projector π from the bundle manifold onto the base manifold: $\pi(p) = x$
See [Isham(1999), Nakahara(2003), Fecko, M.(2006)]
- In the same way as a manifold is locally Minkowski
a bundle is locally $M \times F$
- G the structure group glues the fibers together

Example 8.2. see [Nakahara(2003), p372]

The cylinder is the trivial bundle $S^1 \times F$ with S^1 , the circle for the structure group $G = \{Id_{F \rightarrow F}\}$
while $F = [-1, 1]$

while the Möbius strip is locally $S^1 \times F$ but for $G = \mathbb{Z}_2 = \{Id_{F \rightarrow F}, g\}$ and $g : F \rightarrow F$ (see Fig. 8.2.1)
 $t \mapsto -t$

8.2.1 In the frame bundle

At one point of M one can choose a frame e_A

The transforms from e_A to $e'_A = g e_A$ is done by linear maps: elements of $GL(n, \mathbb{R})$. This induces a bijection between e_A and $g \in GL(n, \mathbb{R})$

$GL(n, \mathbb{R})$ implies the fiber to be made of any vielbein

So η is then not Minkowski.

The restriction from $GL(n, \mathbb{R})$ to the Lorentz group $SO_0(1, 3) \Rightarrow$ orthonormal bases, related by Lorentz transforms (see Fig. 8.2.2)

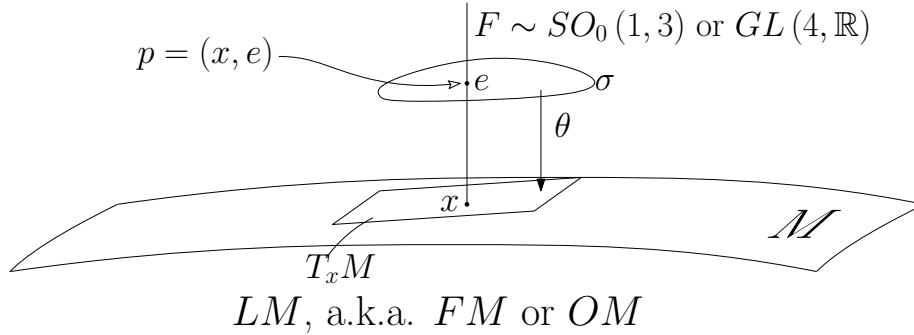

Figure 8.2.2: Frame Bundles representation

8.2.1.1 The canonical form θ

gives horizontal vector components of bundle vector in a basis

$$\begin{aligned} \theta(e, v) &= \{v^A\} && \text{for } V = V^A e_A && \text{horizontal part} \\ \theta_{e_A}(v) &= V^A && + V^v && \text{vertical part} \end{aligned}$$

in the tangent to the bundle and realises

8.2.1.2 The soldering form $\tilde{\theta}$

Displacement along the fiber (here a Lorentz transform) also corresponds to moving on the base M (Lorentz transform in the spacetime manifold)

8.2.1.3 The section σ in local open set of bundle

Choose a basis (element of fiber) above a spacetime point neighbourhood
 $\sigma(p) = e(x)$: element of fiber group (here frame) in a neighbourhood
 In LM , $\sigma^* \theta = e$ on M : $\sigma^* \theta^A = e^A$
 (σ^* equivalent to π : projection, in this context)

8.2.1.4 The connection ω

Ensures parallel transport/covariant derivative

Parallel transport in bundles: offers a different approach

γ , curve in base M , is lifted to γ'

The connection defines the horizontal part of the tangent plane to the bundle manifold, while the fiber is canonically vertical.

The vertical drift of γ' measures the bundle curvature

For γ closed loops, see Fig. 8.2.3a

In parallel transport, $\dot{\gamma}'$ remains horizontal (geodesic on M , see Fig. 8.2.3b)

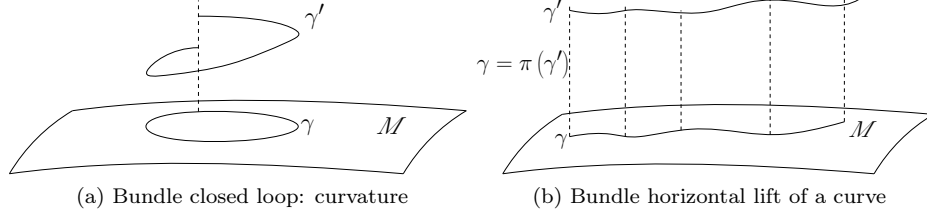

Figure 8.2.3: Bundle Parallel transport

ϕ : quantity transported along γ'

$$\dot{\gamma}\phi = D\phi[\dot{\gamma}']$$

$$\text{on } M : \dot{\gamma}\pi\phi = \nabla_{\dot{\gamma}}\pi\phi[\dot{\gamma}]$$

Using the connection

$$\text{in frame bundle } \omega = \omega_B^A \theta_A \theta^B$$

$$\text{on } M \sigma^* \omega = \Gamma_{BC}^A e_A e^B e^C$$

$$\text{with } \nabla_{e_A} e_B = \Gamma_{AB}^C e_C$$

Definition 8.2. Connections

- ω is an Ehresmann connection
- Γ is a Koszul connection (as in GR)

Connections were developed first by Lie to study solutions of differential equations as trajectories on manifolds. Lie PhD student Cartan introduced torsion and connections with frames.

While Riemann geometry describes manifolds compared with tangent planes, Cartan geometry defines manifolds from the motion of a mobile frame on them.

Cartan's PhD student Ehresmann defined a more general connection independent of frames, without the need for soldering.

Its abstract use allowed to describe gauge theories with fiber bundles in which the covariant derivative on the base yields, as a connection, the gauge field coupling.

- Connections have been applied to - gravitation, GR,... (e.g. Penrose)
- particle physics, gauge theory

Applied to a frame form e^A on M (\mathcal{D} exterior covariant derivative on M)

$$\mathcal{D}e^A = de^A + \hat{\omega}_B^A \wedge e^B$$

Advantage: with appropriate representation, spinors can be coupled to gravity with the Fock-Ivanenko covariant derivative

$$D_A \psi = \partial_A \psi - \frac{i}{2} \omega_A^{bc} S_{bc} \psi$$

where S_{bc} is the Fock-Ivanenko coefficient in spinor space and ω_A^{bc} is the connection representation called spin connection

8.2.1.5 Curvature and torsion

are defined as parallel transport of

- connection: curvature 2-form

$$\Omega_B^A = d\omega_B^A + \omega_C^A \wedge \omega_B^C$$

and

$$\Omega_B^A = \frac{1}{2} R_{BCD}^A e^C \wedge e^D \text{ in terms of Riemann}$$

- canonical form: torsion 2-form

$$\Theta^A = d\theta^A + \omega_B^A \wedge \theta^B$$

and

$$= \frac{1}{2}$$

$$\Theta^A = \frac{1}{2} T_{BC}^A e^B \wedge e^C \text{ in terms of torsion tensor}$$

For $de^A = 0$ (holonomic frames, similar to ∂_a)

$$T_{BC}^A = 2\Gamma_{[BC]}^A$$

In GR $\Gamma_{BC}^A = \Gamma_{(BC)}^A$ so $T_{BC}^A = 0$

8.3 Newman-Penrose tetrads

From a usual tetrad with e_{\square} timelike orthonormal!

$e_{(\mu)}$ spacelike
we can build a fully null basis $z^a_A = (l^a, n^a, m^a, \bar{m}^a)$

$$l = \frac{e_{\square} + e_I}{\sqrt{2}}, \quad n = \frac{e_{\square} - e_I}{\sqrt{2}}, \quad \text{and} \quad m = \frac{e_{II} + i e_{III}}{\sqrt{2}} \Rightarrow \bar{m} = \frac{e_{II} - i e_{III}}{\sqrt{2}}$$

Null basis

$$l.l = \frac{e_{\square}^2 + e_I^2}{2} = 0 = n.n = m.m = \frac{e_{II}^2 - e_{III}^2}{2} = \bar{m}.\bar{m}$$

Orthonormal by blocks

$$l.m = l.\bar{m} = n.m = n.\bar{m} = 0$$

Normalisation

$$l.n = \frac{e_{\square}^2 - e_I^2}{2} = -1 \quad \text{and} \quad m.\bar{m} = \frac{e_{II}^2 + e_{III}^2}{2} = 1$$

Then the metric becomes, through normalisation

$$\eta_{AB} = \eta^{AB} = \begin{bmatrix} 0 & -1 & 0 & 0 \\ -1 & 0 & 0 & 0 \\ 0 & 0 & 0 & 1 \\ 0 & 0 & 1 & 0 \end{bmatrix}$$

which yields the basis and form basis

$$\begin{aligned} e_1 = l, & & e_2 = n, & & e_3 = m, & & e_4 = \bar{m} : & z_A = (l, n, m, \bar{m}) \\ e^1 = \eta^{1B} e_B = -n, & & e^2 = \eta^{2B} e_B = -l, & & e^3 = \bar{m}, & & e^4 = m : & z^A = (-n, -l, \bar{m}, m) \end{aligned}$$

and the metric

$$g_{ab} = \eta_{AB} z_a^A z_b^B = -2(l_{(a} n_{b)} - m_{(a} \bar{m}_{b)})$$

Basis vectors as directional derivatives are given symbols:

$$e_1 = e_1^a \partial_a \equiv D = l^a \nabla_a, \quad e_2 = n^a \nabla_a \equiv \Delta, \quad e_3 = m^a \nabla_a \equiv \delta, \quad e_4 = \bar{m}^a \nabla_a \equiv \bar{\delta}$$

The connection full information lies in the Ricci rotation coefficients named Newman-Penrose spin coefficients:

$$\begin{aligned} \varkappa = \gamma_{311} = -m^a l^b \nabla_b l_a & & \pi = \gamma_{241} = \bar{m}^a l^b \nabla_b n_a & & \varepsilon = \frac{1}{2} (\gamma_{211} + \overbrace{\gamma_{341}}^{-\gamma_{431}}) \\ & & = -\gamma_{421} & & = \frac{1}{2} (\bar{m}^a l^b \nabla_b m_a - n^a l^b \nabla_b l_a) \\ \sigma = \gamma_{313} = -m^a m^b \nabla_b l_a & & \mu = \gamma_{243} = \bar{m}^a m^b \nabla_b n_a & & \beta = \frac{1}{2} (\gamma_{213} + \overbrace{\gamma_{343}}^{-\gamma_{433}}) \\ & & = -\gamma_{423} & & = \frac{1}{2} (\bar{m}^a m^b \nabla_b m_a - n^a m^b \nabla_b l_a) \\ \varrho = \gamma_{314} = -m^a \bar{m}^b \nabla_b l_a & & \lambda = \gamma_{244} = \bar{m}^a \bar{m}^b \nabla_b n_a & & \alpha = \frac{1}{2} (\gamma_{214} + \overbrace{\gamma_{344}}^{-\gamma_{434}}) \\ & & = -\gamma_{424} & & = \frac{1}{2} (\bar{m}^a \bar{m}^b \nabla_b m_a - n^a \bar{m}^b \nabla_b l_a) \\ \tau = \gamma_{312} = -m^a n^b \nabla_b l_a & & \nu = \gamma_{242} = \bar{m}^a n^b \nabla_b n_a & & \gamma = \frac{1}{2} (\gamma_{212} + \overbrace{\gamma_{342}}^{-\gamma_{432}}) \\ & & = -\gamma_{422} & & = \frac{1}{2} (\bar{m}^a n^b \nabla_b m_a - n^a n^b \nabla_b l_a) \end{aligned}$$

Complex conjugation simply involves exchanging indices 3 and 4 or m and \bar{m}

8.3.1 Transportation equations

Directional derivatives applied to the NP tetrad yields

$$\begin{aligned}
 Dl &= (\varepsilon + \bar{\varepsilon})l - \bar{\varkappa}m - \varkappa\bar{m} & Dn &= -(\varepsilon + \bar{\varepsilon})n + \pi m + \bar{\pi}\bar{m} \\
 \Delta l &= (\gamma + \bar{\gamma})l - \bar{\tau}m - \tau\bar{m} & \Delta n &= -(\gamma + \bar{\gamma})n + \nu m + \bar{\nu}\bar{m} \\
 \delta l &= (\bar{\alpha} + \beta)l - \bar{\varrho}m - \sigma\bar{m} & \delta n &= -(\bar{\alpha} + \beta)n + \mu m + \bar{\lambda}\bar{m} \\
 Dm &= \bar{\pi}l - \varkappa n + (\varepsilon - \bar{\varepsilon})m & \Delta m &= \bar{\nu}l - \tau n + (\gamma - \bar{\gamma})m \\
 \delta m &= \bar{\lambda}l - \sigma n + (\beta - \bar{\alpha})m & \bar{\delta} m &= \bar{\mu}l - \varrho n + (\alpha - \bar{\beta})m
 \end{aligned}$$

Application:

- l is tangent to geodesics $\Leftrightarrow \varkappa = 0$
then $Dl = (\varepsilon + \bar{\varepsilon})l$, non affine geodesics equation
- l tangent to affinely parameterised geodesics $\Leftrightarrow \varkappa = 0$ and $\varepsilon = -\bar{\varepsilon}$ ($\varepsilon = i\mathcal{E}$): then $Dl = 0$

Samely

- n tangent to geodesics $\Leftrightarrow \nu = 0$ so $\Delta n = -(\gamma + \bar{\gamma})n$
- n affinely parameterised tangent to geodesics $\Leftrightarrow \nu = 0$ and $\gamma = -\bar{\gamma}$ ($\gamma = i\mathcal{G}$) so that $\Delta n = 0$

8.3.2 Commutators

The connection torsion freeness is equivalent to the forms of the directional derivatives commutators:

$$\begin{aligned}
 [z_m, z_n] &= \nabla_m z_n - \nabla_n z_m \\
 &= -2\Gamma_{nm}^k z_k
 \end{aligned}$$

Explicitly

$$\begin{aligned}
 [\Delta, D] &= (\gamma + \bar{\gamma})D + (\varepsilon + \bar{\varepsilon})\Delta - (\pi + \bar{\tau})\delta - (\tau + \bar{\pi})\bar{\delta} \\
 [\delta, D] &= (\bar{\alpha} + \beta - \bar{\pi})D + \varkappa\Delta - (\bar{\varrho} + \varepsilon - \bar{\varepsilon})\delta - \sigma\bar{\delta} \\
 [\delta, \Delta] &= -\bar{\nu}D + (\tau - \bar{\alpha} - \bar{\beta})\Delta + (\mu - \gamma + \bar{\gamma})\delta + \bar{\lambda}\bar{\delta} \\
 [\bar{\delta}, \delta] &= (\bar{\mu} - \mu)D + (\bar{\varrho} - \varrho)\Delta + (\alpha - \bar{\beta})\delta - (\bar{\alpha} - \beta)\bar{\delta}
 \end{aligned}$$

Replace second directional derivative by its vector on the L.H.S. and the directional derivatives by their vectors on the R.H.S. yields combinations of transport equations

8.3.3 Weyl, Ricci and Riemann representations

From the Riemann decomposition into Weyl and its trace [Carroll(2004), Eq: 3.147] the tetrad components of Riemann, Weyl and Ricci can be written as

$$R^{AB}{}_{CD} = C^{AB}{}_{CD} + \frac{4}{n-2} R^{[A}{}_{[C} \eta^{B]}{}_{D]} - \frac{2R}{(n-1)(n-2)} \eta^{[A}{}_{[C} \eta^{B]}{}_{D]}$$

with the tetrad components of Ricci:

$$R_{AC} = \eta^{BD} R_{ABCD} \quad \text{and} \quad R = \eta^{AB} R_{AB}$$

For NP tetrads:

$$R = 2(-R_{12} + R_{34})$$

The tracefreeness of Weyl leads to

$$\eta^{AD} C_{ABCD} = -C_{1BC2} - C_{2BC1} + C_{3BC4} + C_{4BC3} = 0$$

and if in addition

$$B = C \Rightarrow C_{1314} = C_{2324} = C_{1332} = C_{1442} = 0$$

Moreover, the Riemann symmetries yield

$$\begin{aligned} R_{a[bcd]} &= \frac{1}{3} (R_{abcd} + R_{acdb} + R_{adbc}) = 0 \\ &\Rightarrow C_{1234} + C_{1342} + C_{1423} = 0 \end{aligned}$$

Therefore, in the case $b \neq c$, together with the above cyclic antisymmetry, Weyl tracelessness gives

$$\begin{aligned} C_{1231} &= C_{1334}; & C_{1241} &= C_{1443}; & C_{1232} &= C_{2343}; & C_{1242} &= C_{2434} \\ C_{1212} &= C_{3434}; & C_{1342} &= \frac{1}{2} (C_{1212} - C_{1234}) = \frac{1}{2} (C_{3434} - C_{1234}) \end{aligned}$$

so the Riemann tensor can be decomposed with its symmetries and its writing in terms of Weyl and Ricci

The 10 independent components of the Weyl tensor can be encoded into 5 complex N-P scalars

$$\begin{aligned} \psi_0 &= C_{1313} = C_{abcd} l^a m^b l^c m^d \\ \psi_1 &= C_{1213} = C_{abcd} l^a n^b l^c m^d \\ \psi_2 &= C_{1342} = C_{abcd} l^a m^b \bar{m}^c n^d \\ \psi_3 &= C_{1242} = C_{abcd} l^a n^b \bar{m}^c n^d \\ \psi_4 &= C_{2424} = C_{abcd} n^a \bar{m}^b n^c \bar{m}^d \end{aligned}$$

Encoding the Riemann symmetries into the symbol:

$$\{wxyz\} = 8 ([wx][yz]) = 4 [wx][yz] + 4 [yz][wx]$$

the Weyl tensor can be decomposed on the NP basis

$$\begin{aligned} C_{abcd} = & (\psi_2 + \bar{\psi}_2) [\{l_a n_b l_c n_d\} + \{m_a \bar{m}_b m_c \bar{m}_d\}] + (\bar{\psi}_2 - \psi_2) \{l_a n_b m_c \bar{m}_d\} \\ & (\psi_0 \{n_a \bar{m}_b n_c \bar{m}_d\} + \psi_4 \{l_a m_b l_c m_d\} - \psi_2 \{l_a m_b n_c \bar{m}_d\} + \psi_1 [\{l_a n_b n_c \bar{m}_d\} + \{n_a \bar{m}_b \bar{m}_c m_d\}] \\ & - \psi_3 [\{l_a n_b l_c m_d\} - \{l_a m_b m_c \bar{m}_d\}] + \text{complex conjugates}) \end{aligned}$$

The 10 independent components of the Ricci tensor can be encoded into 4 real scalars $\{\Phi_{00}, \Phi_{11}, \Phi_{22}, \Lambda\}$ and 3 complex scalars $\{\Phi_{01}, \Phi_{02}, \Phi_{12}\}$

$$\begin{aligned} \Phi_{00} &= \frac{1}{2} R_{ab} l^a l^b & \Phi_{01} &= \frac{1}{2} R_{ab} l^a m^b & \Rightarrow \Phi_{10} &= \frac{1}{2} R_{ab} l^a \bar{m}_b &= \overline{\Phi_{01}} \\ \Phi_{11} &= \frac{1}{4} R_{ab} (l^a n^b + m_a \bar{m}_b) & \Phi_{02} &= \frac{1}{2} R_{ab} m^a m^b & \Rightarrow \Phi_{20} &= \frac{1}{2} R_{ab} \bar{m}^a \bar{m}_b &= \overline{\Phi_{02}} \\ \Phi_{22} &= \frac{1}{2} R_{ab} n^a n^b & \Phi_{12} &= \frac{1}{2} R_{ab} m^a n^b & \Rightarrow \Phi_{21} &= \frac{1}{2} R_{ab} \bar{m}^a n_b &= \overline{\Phi_{12}} \\ \Lambda &= \frac{R}{4!} \end{aligned}$$

Because of N-P orthonormalisation of the N-P tetrads, R_{ab} in the definitions above can be replaced with

- the tracefree Ricci $Q_{ab} = R_{ab} - \frac{R}{4} g_{ab}$
- the Einstein tensor $G_{ab} = R_{ab} - \frac{R}{2} g_{ab}$

The Ricci and Bianchi identities can written using the above N-P scalars and their derivatives into scalar N-P equations (see [Chandrasekhar(1985)], or more modernly, [Frolov and Novikov(1998)])

8.3.4 Maxwell's equations

In N-P formalism, the Faraday tensor's 6 independent components are encoded in 3 complex Maxwell-NP scalars

$$\begin{aligned} \phi_0 = F_{13} &= F_{ab} l^a m^b; & \phi_1 &= \frac{1}{2} (F_{12} + F_{43}) = \frac{1}{2} F_{ab} (l^a n^b - m_a \bar{m}_b) \\ \phi_2 = F_{42} &= -F_{ab} n_a \bar{m}_b \end{aligned}$$

and Maxwell's equations in differential geometric form

$$d \star F = 0 \qquad dF = 0$$

in coordinate form

$$F_{[ab;c]} = 0 \qquad g^{ac} F_{ab;c} = 0$$

in tetrad form

$$F_{[AB|C]} = 0 \qquad \eta^{BC} F_{AB|C} = 0$$

are replaced by (in NP formalism)

$$\begin{aligned}\phi_{1|1} - \phi_{0|4} &= 0 & \phi_{2|1} - \phi_{1|4} &= 0 \\ \phi_{1|3} - \phi_{0|2} &= 0 & \phi_{2|3} - \phi_{1|2} &= 0\end{aligned}$$

In terms of spin coefficients, we can write, e.g., the first two terms as

$$\begin{aligned}\phi_{1|1} &= \frac{1}{2} (F_{21|1} + F_{43|1}) \\ &= \frac{1}{2} [-F_{12;1} + \eta^{nm} (\gamma_{n11} F_{m2} + \gamma_{n21} F_{1m}) + F_{43;1} - \eta^{nm} (\gamma_{n41} F_{m3} + \gamma_{n31} F_{4m})] \\ &= \phi_{1;1} - (\gamma_{131} F_{42} + \gamma_{241} F_{13}) \\ &= D\phi_1 + \varkappa\phi_2 - \pi\phi_0.\end{aligned}$$

Samely

$$\phi_{0|4} = \bar{\delta}\phi_0 - 2\alpha\phi_0 + 2\rho\phi_1$$

Applying the same procedure to the remaining of the 8 real Maxwell equations components leads to

$$\begin{aligned}D\phi_1 - \bar{\delta}\phi_0 &= (\pi - 2\alpha)\phi_0 + 2\rho\phi_1 - \varkappa\phi_2, \\ D\phi_2 - \bar{\delta}\phi_1 &= -\lambda\phi_0 + 2\pi\phi_1 + (\varrho - 2\varepsilon)\phi_2, \\ \Delta\phi_0 - \delta\phi_1 &= (2\gamma - \mu)\phi_0 - 2\tau\phi_1 + \sigma\phi_2, \\ \Delta\phi_1 - \delta\phi_2 &= \nu\phi_0 - 2\mu\phi_1 + (2\beta - \tau)\phi_2.\end{aligned}$$

The energy-momentum of Faraday is

$$\begin{aligned}T_{ab} &= g^{cd} F_{ac} F_{bd} - \frac{g^{ab}}{4} F_{ef} F^{ef} \\ \Rightarrow T_{AB} &= \eta^{CD} F_{AC} F_{BD} - \frac{\eta_{AB}}{4} F_{EF} F^{EF}\end{aligned}$$

In terms of NP scalars

$$\begin{aligned}-\frac{1}{2}T_{11} &= \phi_0\bar{\phi}_0, & -\frac{1}{2}T_{13} &= \phi_0\bar{\phi}_1, & -\frac{1}{4}(T_{12} + T_{34}) &= \phi_1\bar{\phi}_1, \\ -\frac{1}{2}T_{11} &= \phi_1\bar{\phi}_2, & -\frac{1}{2}T_{11} &= \phi_2\bar{\phi}_2, & -\frac{1}{2}T_{11} &= \phi_0\bar{\phi}_2,\end{aligned}$$

while $T^A_A = F_{AC} F^{AC} - \frac{4}{4} F_{EF} F^{EF} = 0$, so EFE yield (recall Φ_{nm} can be written with G_{ab}) for pure Faraday sources (only electromagnetic)

$$\Lambda = 0 \text{ and } \Phi_{nm} = \kappa\phi_n\bar{\phi}_m$$

8.3.5 Some applications of N-P formalism

8.3.5.1 Gravitational waves

Governed exclusively by $\psi_4 = C_{abcd} n^a \bar{m}^b n^c \bar{m}^d$

Choosing at infinity $l^a = \frac{(\hat{t}+\hat{r})^a}{\sqrt{2}}, n^a = \frac{(\hat{t}-\hat{r})^a}{\sqrt{2}}, m^a = \frac{(\hat{\theta}+i\hat{\varphi})^a}{\sqrt{2}}$

In the transverse traceless gauge, linearised G.W. yield, assuming propagation in \hat{r} direction

$$\begin{aligned} -\frac{1}{4} \left(\ddot{h}_{\hat{\theta}\hat{\theta}} - \ddot{h}_{\hat{\varphi}\hat{\varphi}} \right) &= -R_{\hat{t}\hat{\theta}\hat{t}\hat{\theta}} = -R_{\hat{t}\hat{\varphi}\hat{t}\hat{\varphi}} = -R_{\hat{r}\hat{\theta}\hat{r}\hat{\theta}} = -R_{\hat{r}\hat{\varphi}\hat{r}\hat{\varphi}} \\ \frac{1}{2} \ddot{h}_{\hat{\theta}\hat{\varphi}} &= -R_{\hat{t}\hat{\theta}\hat{t}\hat{\varphi}} = -R_{\hat{r}\hat{\theta}\hat{r}\hat{\varphi}} = R_{\hat{t}\hat{\theta}\hat{r}\hat{\varphi}} = R_{\hat{r}\hat{\theta}\hat{t}\hat{\varphi}}. \end{aligned}$$

Their combination yields

$$\psi_4 = \frac{1}{2} \left(\ddot{h}_{\hat{\theta}\hat{\theta}} - \ddot{h}_{\hat{\varphi}\hat{\varphi}} \right) + i\ddot{h}_{\hat{\theta}\hat{\varphi}} = -\ddot{h}_+ + i\ddot{h}_\times$$

so ψ_4 encodes all outgoing GW

8.3.5.2 Vaidya metric

A generalisation of Schwarzschild, Vaidya solution represents spherical distribution of null dust. Recall the tortoise radius outside the horizon (see Sec. 1.4.3)

$$d\bar{r} = \frac{dr}{1 - \frac{2M}{r}} = dr + \frac{2Mdr}{r(1 - \frac{2M}{r})} = d \left[r + 2M \ln \left(\frac{r}{2M} - 1 \right) \right]$$

to build Minkowski-like null coordinates

$$\left. \begin{aligned} u &= t - \bar{r} & v &= t + \bar{r} \\ \Rightarrow t &= u + \bar{r} & \Rightarrow t &= v - \bar{r} \end{aligned} \right\} \Rightarrow dt = \begin{aligned} du + d\bar{r} &= dv - d\bar{r} \\ &= du + \frac{dr}{1 - \frac{2M}{r}} &= dv - \frac{dr}{1 - \frac{2M}{r}} \end{aligned}$$

Then they are used to obtain the Eddington-Filkenstein retarded/outgoing metric (see Sec. 1.4.4)

$$ds^2 = - \left(1 - \frac{2M}{r} \right) du^2 - 2dudr + r^2 d\Omega^2$$

advanced/ingoing metric

$$ds^2 = - \left(1 - \frac{2M}{r} \right) dv^2 + 2dvdr + r^2 d\Omega^2$$

To obtain the Vaidya metric requires to turn the mass parameter into a mass distribution of the null coordinate. As constant mass corresponds to constant null coordinate, behaving like dust with radius turned to null directions (expanding or collapsing at light speed) this is interpreted as pressureless gas of photons or null particles: null dust

As in E-F Schwarzschild solution, there are 2 cases

Outgoing null dust

$$\begin{aligned} ds^2 &= - \left(1 - \frac{2M(u)}{r} \right) du^2 - 2dudr + r^2 d\Omega^2 \\ &= \frac{2M(u)}{r} du^2 + ds_M^2 \end{aligned}$$

Ingoing null dust

$$\begin{aligned} ds^2 &= - \left(1 - \frac{2M(v)}{r} \right) dv^2 + 2dvdr + r^2 d\Omega^2 \\ &= \frac{2M(v)}{r} dv^2 + ds_M^2 \end{aligned}$$

as Minkowski verifies

$$\begin{aligned} ds_M^2 &= - dt^2 + dr^2 + r^2 d\Omega^2 \\ &= - du^2 - 2dudr + r^2 d\Omega^2 \\ &= - dv^2 + 2dvdr + r^2 d\Omega^2 \end{aligned}$$

Analysis of both cases is simplified in N-P formalism

Emitting Vaidya and NP tetrads Because of the extra terms from Minkowski the only non-zero Ricci is

$$R_{uu} = - \frac{2M_{,u}(u)}{r^2}$$

while $g^{uu} = 0 \Rightarrow R = R_{ab}g^{ab} = 0$ so EFE yield $G_{ab} = R_{ab} = \kappa T_{ab} = 8\pi T_{ab}$

$$\Rightarrow T_{ab} = - \frac{M_{,u}(u)}{4\pi r^2} l_a l_b \text{ with } l_a dx^a = du$$

Choosing $l_a = -\partial_a u$, $l^a = g^{ab}l_b$ we recognise the energy momentum of pure radiation dust with $\rho = -\frac{M_{,u}(u)}{4\pi r^2}$

$$\text{From NEC (see Sec. 4.3.1.3), } \rho \geq 0 \Rightarrow M_{,u} < 0$$

so the central body loses mass by emitting radiations out (photons, neutrinos,...)

Applying N-P formalism, non-zero scalars are

$$\psi_2 = - \frac{M(u)}{r^3}, \quad \Phi_{22} = - \frac{M_{,u}}{r^2}$$

$\triangle!$ Maxwell N-P equations are not satisfied!

Expansions:

$$\begin{aligned} \Theta_l &= - (\varrho + \bar{\varrho}) = \frac{2}{r} \\ \Theta_n &= \mu + \bar{\mu} = \frac{-r + 2M(u)}{r^2} \end{aligned}$$

Building the radial null dust Lagrangian ($\mathcal{L} = 0$, $\dot{\theta} = \dot{\varphi} = 0$, from $(\frac{ds}{d\lambda})^2 = 0$)

$$\mathcal{L} = 0 = - \left(1 - \frac{2M(u)}{r} \right) \dot{u}^2 + 2\dot{u}\dot{r}$$

2 solutions

- $\dot{u} = 0$ outgoing ($r \nearrow$ for $t \nearrow$)
- $\dot{r} = \frac{1}{2} \left(1 - \frac{2M(u)}{r} \right) \dot{u}$ ingoing ($r \searrow$ for $t \nearrow$)

In terms of NP tetrad

$$l^a = (0, 1, 0, 0) \quad n^a = \left(1, -\frac{(1-2M)}{2r}, 0, 0 \right) \quad m^a = \frac{1}{\sqrt{2}r} \left(0, 0, 1, \frac{i}{\sin\theta} \right)$$

and their dual basis

$$l_a = (-1, 0, 0, 0) \quad n_a = \left(-\frac{(1-2M)}{2r}, -1, 0, 0 \right) \quad m_a = \frac{r}{\sqrt{2}} \left(0, 0, 1, i \sin\theta \right)$$

The spin coefficients (connection) verify

$$\begin{aligned} \kappa = \sigma = \tau = \nu = \lambda = \pi = \varepsilon = 0 \\ \varrho = -\frac{1}{r}, \mu = -\frac{1}{2r} \left(1 - \frac{2M}{r} \right), \alpha = -\beta = -\frac{\sqrt{2} \cot\theta}{4r}, \gamma = \frac{M(u)}{2r^2} \end{aligned}$$

The restriction to Schwarzschild is simply obtained from setting $M(u) = M = cst$: only $\psi_2 \neq 0$

Pure absorbing Vaidya In this case, the non-zero Ricci becomes

$$R_{vv} = \frac{2M_{,v}}{r^2}$$

and since again $g^{vv} = 0 \Rightarrow R = g^{ab}R_{ab} = 0$ which leads, through EFE to $T_{ab} = \frac{M_{,v}}{4\pi r^2} n_a n_b$ for $n_a dx^a = -dv$, again the EMT of pure radiation dust with $\rho = \frac{M_{,v}}{4\pi r^2}$ which once again from NEC has $\rho \geq 0 \Rightarrow M_{,v} > 0$ and leads to the interpretation of an absorbing central object for ingoing dust radiation.

The non-zero N-P scalars are

$$\psi_2 = -\frac{M(v)}{r^3}, \quad \Phi_{00} = \frac{M_{,v}}{r^2}$$

The expansions are now

$$\begin{aligned} \Theta_l = -(\varrho + \bar{\varrho}) = \frac{r - 2M(v)}{r^2} \\ \Theta_n = \mu + \bar{\mu} = -\frac{2}{r} \end{aligned}$$

As ingoing Vaidya is one of the few exact dynamical solutions, it can be used to explore B.H. physics, like check differences between, e.g., Event Horizons and quasi-local Trapping Horizons (see Defs. 5.1 and 5.2; also refer to Defs. 5.3 and 5.27).

Note $r = 2M(v)$ is always marginally outer Trapped Horizon ($\Theta_l = 0, \Theta_n < 0$)

Radial null Vaidya Lagrangian ($\mathcal{L} = 0, \dot{\theta} = \dot{\varphi} = 0$)

$$\mathcal{L} = 0 = - \left(1 - \frac{2M}{r} \right) \dot{v}^2 + 2\dot{v}\dot{r}$$

also has

- ingoing $\dot{v} = 0$ solution
- outgoing $\dot{r} = \frac{1}{2} \left(1 - \frac{2M}{r} \right) \dot{v}$ solution

The adapted N-P tetrad to ingoing null dust analysis can be set as

$$l^a = \left(1, -\frac{(1-\frac{2M}{r})}{2}, 0, 0 \right) \quad n^a = (0, -1, 0, 0) \quad m^a = \frac{1}{\sqrt{2}r} \left(0, 0, 1, \frac{i}{\sin\theta} \right)$$

and their dual basis is

$$l_a = \left(-\frac{(1-\frac{2M}{r})}{2}, -1, 0, 0 \right) \quad n_a = (-1, 0, 0, 0) \quad m_a = \frac{r}{\sqrt{2}} \left(0, 0, 1, i \sin\theta \right)$$

The corresponding spin coefficients are

$$\begin{aligned} \kappa = \sigma = \tau = \nu = \lambda = \pi = \gamma = 0 \\ \varrho = -\frac{1}{2r} \left(1 - \frac{2M}{r} \right), \mu = -\frac{1}{r}, \alpha = -\beta = -\frac{\sqrt{2} \cot\theta}{4r}, \varepsilon = \frac{M(v)}{r^2} \end{aligned}$$

Thus the Weyl and Ricci N-P scalars turn as

$$\begin{aligned} \psi_0 = \psi_1 = \psi_3 = \psi_4 = 0, \quad \psi_2 = -\frac{M(v)}{r^3} \\ \Phi_{10} = \Phi_{20} = \Phi_{11} = \Phi_{12} = \Phi_{22} = \Lambda = 0, \quad \Phi_{00} = \frac{M_{,v}}{r^2} \end{aligned}$$

Again, restricting to Schwarzschild summarises as $M(v) = M = cst$ and only $\psi_2 \neq 0$

Note $\psi_4 = 0 \Rightarrow$ no radiation (G.W.)

Chapter 9

Geodesics from Hamilton-Jacobi Formalism

(From [Bazanski(1989)])

Hamilton-Jacobi Formalism (recall) In the canonical view, one starts from a Hamiltonian H with canonical variables q and p , and look at canonical transformations of H, q, p into \mathcal{H}, Q, P . They obey canonical equations

$$\begin{cases} \dot{q} = \frac{\partial H}{\partial p} \\ \dot{p} = -\frac{\partial H}{\partial q} \end{cases} \text{ and } \begin{cases} \dot{Q} = \frac{\partial \mathcal{H}}{\partial P} \\ \dot{P} = -\frac{\partial \mathcal{H}}{\partial Q} \end{cases}$$

and their Lagrangian only differs by a differential of a Generating function

$$L - \mathcal{L} = p.\dot{q} - H - P.\dot{Q} + \mathcal{H} = \frac{dF}{dt}(q, p, Q, P, t)$$

Then Hamilton's Principal function $S(q, t) = \int^{(q,t)} L dt$ (action) which is obtained from the Generating function by a Legendre transform

$$S(q, P) = F + Q.P$$

Thus

$$\begin{aligned} \frac{dS}{dt} &= p.\dot{q} - H - P.\dot{Q} + \mathcal{H} + \dot{Q}.P + Q.\dot{P} = \frac{\partial S}{\partial q}\dot{q} + \frac{\partial S}{\partial P}\dot{P} + \partial_t S \\ &\Leftrightarrow (p - \partial_q S)\dot{q} + (Q - \partial_P S)\dot{P} + (\mathcal{H} - H - \partial_t S) = 0 \\ &\Leftrightarrow \begin{cases} \partial_q S = p \\ \partial_P S = Q \\ \mathcal{H} - H = \partial_t S \end{cases} \end{aligned}$$

Choose $\mathcal{H} = 0$ ($\Rightarrow P, Q = cst$) constants of motion

$$\boxed{H(q, \partial_q S, t) + \partial_t S = \mathcal{H} = 0}$$

Now if $H = \frac{1}{2}g_{ab}u^a u^b$ for geodesics, $q^a = x^a, p_a = \frac{dx^a}{d\tau}$ $\mathcal{H} = 0$ $Q^a, P_a = cst$ then we have

$$\begin{aligned} L &= p_a \dot{x}^a - H \\ \mathcal{L} &= P_a Q^a - \mathcal{H} \end{aligned} \quad \frac{dF}{d\tau} = p_a \dot{x}^a - H - P_a \dot{Q}^a + \mathcal{H}$$

Define $S(x^a, P_a) = F + Q^a P_a$ then

$$\begin{aligned} \frac{dS}{d\tau} &= p_a \dot{x}^a - H - P_a \dot{Q}^a + \mathcal{H} + \dot{Q}^a P_a + Q^a \dot{P}_a \\ &= \partial_a S \dot{x}^a + \partial_{P_a} S \dot{P}_a + \partial_\tau S \end{aligned}$$

and we get

$$\begin{aligned} \partial_a S &= p_a \\ \partial_{P_a} S &= Q^a \\ \mathcal{H} - H &= \partial_\tau S \end{aligned}$$

so if $\mathcal{H} = 0$ ($\Rightarrow P_a, Q^a = cst$ of motion) $H + \partial_t S = \mathcal{H} = 0$

Thus

$$\begin{aligned} \partial_{P_a} S = Q^a &\Rightarrow S = Q^a P_a + f(\tau, x^a) \\ \partial_a f = \partial_a S = p_a &\Rightarrow S = Q^a P_a + p_a x^a + g(\tau) \\ d_\tau g = \partial_\tau S = -H &\Rightarrow S = Q^a P_a + p_a x^a - \int \frac{1}{2} g_{ab} u^a u^b d\tau \end{aligned}$$

but this is not very enlightening. Use [Bazanski(1989)]

9.1 Original derivation of Hamilton-Jacobi equation

From Hamilton: denote neighbouring family of trajectories by ϵ with Lagrangian $\mathcal{L}(q, \dot{q}, t)$ and end points at t_0, t_1 :

$q = q(t, \epsilon)$ trajectory, $q(t_i, \epsilon) = q(t_i)$ $i = 0, 1$ (see Fig. 9.1.1)

Thus variations yield $\bar{\delta} q^k = \partial_\epsilon q^k(t, 0) \delta\epsilon$, $\delta t = \frac{dt}{d\epsilon}(0) \delta\epsilon$

so $\delta q^k = \bar{\delta} q^k + \dot{q}^k \delta t = (\partial_\epsilon q^k + \frac{dt}{d\epsilon})(0) \delta\epsilon$

The variation of the action yields from $S = \int_{t_0}^{t_1} \mathcal{L}(q, \dot{q}, t) dt$

$$\delta S = [\mathcal{L} \delta t]_{t_0}^{t_1} + \int_{t_0}^{t_1} \bar{\delta} \mathcal{L} dt$$

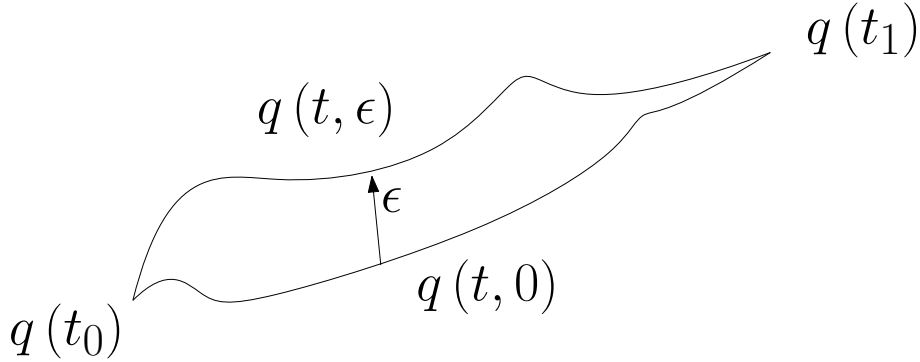

Figure 9.1.1: Family of trajectories

Adding and subtracting to the first term $\partial_{\dot{q}^k} \mathcal{L} \dot{q}^k \frac{dt}{d\epsilon} \delta\epsilon = \partial_{\dot{q}^k} \mathcal{L} \dot{q}^k \delta t$ and explic-
 iting with integration by part for the second term,

$$\int_{t_0}^{t_1} \partial_{\dot{q}^k} \mathcal{L} \bar{\delta} \dot{q}^k dt = [\partial_{\dot{q}^k} \mathcal{L} \bar{\delta} q^k]_{t_0}^{t_1} - \int_{t_0}^{t_1} \frac{d}{dt} (\partial_{\dot{q}^k} \mathcal{L}) \bar{\delta} q^k dt$$

for $\bar{\delta} \dot{q} = \partial_{\epsilon} \dot{q} \delta\epsilon = \frac{d}{dt} (\bar{\delta} q)$ we get

$$\delta S = [\partial_{\dot{q}^k} \mathcal{L} \delta q^k - (\partial_{\dot{q}^k} \mathcal{L} \dot{q}^k - \mathcal{L}) \delta t]_{t_0}^{t_1} + \int_{t_0}^{t_1} \left[\partial_{q^k} \mathcal{L} - \frac{d}{dt} (\partial_{\dot{q}^k} \mathcal{L}) \right] \bar{\delta} q^k dt$$

Taking $\delta q = \delta t = 0$ at t_0, t_1 yields the usual - Lagrange equations
 -Noether identities

Thus the differential of the Principal function $S(q, t)$

$$dS = [\partial_{\dot{q}^k} \mathcal{L} .dq - (\partial_{\dot{q}^k} \mathcal{L} .\dot{q} - \mathcal{L}) dt]_{t_0}^{t_1} + \int_{t_0}^{t_1} \left[\partial_q \mathcal{L} - \frac{d}{dt} (\partial_{\dot{q}^k} \mathcal{L}) \right] dq dt \text{ on shell}$$

$$= \partial_q S .dq + \partial_t S dt$$

(with $\partial_q \mathcal{L} - \frac{d}{dt} (\partial_{\dot{q}^k} \mathcal{L}) = 0$) one gets

$$\begin{aligned} \partial_{q^k} S &= \partial_{\dot{q}^k} \mathcal{L} = p_k \\ -\partial_t S &= p .\dot{q} - \mathcal{L} = H(q^k, \partial_{q^k} S, t) \end{aligned}$$

Thus we have the

Theorem 9.1. *Jacobi theorem*

$S : Q_n \times \mathbb{R}^{n+1} \rightarrow \mathbb{R}$ $S = S(q^k, a^l, t)$ is a complete integral of the Hamilton-
 Jacobi equation

$$\Rightarrow \partial_{a^l} S = \alpha_l$$

defines implicitly

1. $q^k = \xi^k(t, a^l, \alpha_m)$ satisfies $\partial_{a^l} S = \partial_{q^k} S \partial_{a^l} \xi^k = \alpha_l$

2. $p_k = \eta_k(t, a^l, \alpha_m) = \partial_{q^k} S(\xi^k, a^l, t) = \partial_{q^k} S(\xi^k(t, a^l, \alpha_m), t)$

and p and q are solutions of Hamilton's equations

9.2 Geodesics

In manifold (M, g_{ab}) , we have γ timelike curve with parameter $\tau \in [\tau_0, \tau_1]$, $x^a = \xi^a(\tau)$

The action functional for it to be geodesic writes

$$U[\gamma] = \int_{\tau_0}^{\tau_1} \sqrt{-g_{ab} \dot{\xi}^a \dot{\xi}^b} d\tau \quad \text{where} \quad \begin{aligned} \dot{\xi}^a &= \frac{d\xi^a}{d\tau} \\ \bar{\delta}\xi^a &= \partial_\epsilon \xi^a(\tau, 0) \delta\epsilon \\ \delta\tau &= \partial_\epsilon \tau(0) \delta\epsilon \end{aligned}$$

so $\delta\xi^a = \bar{\delta}\xi^a + \dot{\xi}^a \delta\tau$

We have

$$\begin{cases} \partial_{\dot{x}^a} \mathcal{L} = \frac{-g_{ab} \dot{\xi}^b}{\sqrt{-g_{ab} \dot{\xi}^a \dot{\xi}^b}} & \Rightarrow \partial_{\dot{x}^a} \mathcal{L} \dot{\xi}^a = \sqrt{-g_{ab} \dot{\xi}^a \dot{\xi}^b} = \mathcal{L} \\ \partial_a \mathcal{L} = 0 \end{cases}$$

so applying the same procedure

$$\delta U = \left[\frac{-g_{ab} \dot{\xi}^b}{\sqrt{-\dot{\xi}^c \dot{\xi}^c}} \delta\xi^a \right]_{\tau_0}^{\tau_1} + \int_{\tau_0}^{\tau_1} d\tau \left[\frac{D}{d\tau} \left(\frac{g_{ab} \dot{\xi}^b}{\sqrt{-\dot{\xi}^c \dot{\xi}^c}} \right) \right] \bar{\delta}\xi^a$$

Accordingly the Principal function $U(x^a, \tau)$ is constructed so that

$$dU = \frac{-g_{ab} \dot{\xi}^b}{\sqrt{-\dot{\xi}^c \dot{\xi}^c}} dx^a \Rightarrow \begin{cases} \partial_a U = -\frac{g_{ab} \dot{\xi}^b}{\sqrt{-\dot{\xi}^c \dot{\xi}^c}} \\ \partial_\epsilon U = 0 \text{ which is the Hamilton-Jacobi equation} \end{cases}$$

but we also have

$$\begin{aligned} g^{ab} \partial_a U \partial_b U &= g^{ab} \times -\frac{g_{ac} \dot{\xi}^c}{\sqrt{-\dot{\xi}^2}} \times -\frac{g_{bd} \dot{\xi}^d}{\sqrt{-\dot{\xi}^2}} \\ &= \frac{g_{ac} \dot{\xi}^c \dot{\xi}^a}{-\dot{\xi}^d \dot{\xi}^d} = -1 \end{aligned}$$

If we proceed like for the Jacobi theorem, we would break covariance, so we need a covariant version

9.2.1 Jacobi theorem for geodesics

We consider $g^{ab}\partial_a U \partial_b U = -1$ a PDE for $U = U(x^a)$ and define a complete integral for it

Definition 9.1. $U : M \times \mathbb{R}^3 \rightarrow \mathbb{R}$ $U = U(x^a, a^k)$ is a complete integral of $g^{ab}\partial_a U \partial_b U = -1 \Leftrightarrow$

1. $U(x^a, a^k)$ verifies $\forall a^l \in I_{(l)}, g^{ab}\partial_a U \partial_b U = -1$, where $I_{(l)}$ open set of \mathbb{R}^3
2. $\partial_{a, a^k}^2 U$ is a 4×3 matrix of rank 3

Note

- a^k are scalars (independent variables of $x^a \Leftrightarrow \partial_a a^k = 0$)
- Since we can Taylor expand

$$\partial_a U = \partial_a U(x^b, 0) + \partial_{a, a^k}^2 U \cdot a^k + O((a^k)^2)$$

and $\partial_{a, a^k}^2 U$ 4×3 of rank 3, it can be inverted

and $a^k = \left(\partial_{a, a^k}^2 U\right)^{-1} (\partial_a U - \partial_a U_0)$ so

$$\begin{aligned} g^{ab}\partial_a U \partial_b U = -1 &= g^{ab}\partial_a U \left(x^c, \left(\partial_{d, a^k}^2 U\right)^{-1} (\partial_d U - \partial_d U_0) \right) \\ &\quad \partial_b U \left(x^e, \left(\partial_{f, a^k}^2 U\right)^{-1} (\partial_f U - \partial_f U_0) \right) \\ &\Leftrightarrow \Psi(x^a, \partial_d U) = 0 \end{aligned}$$

Theorem 9.2. *Jacobi theorem for geodesics*

$U = U(x^a, a^k)$ complete integral of $g^{ab}\partial_a U \partial_b U = -1 \Rightarrow \partial_{a^k} U = \alpha_k, \alpha_k \in \mathbb{R}^3$ determines $\xi^a : \mathbb{R}^7 \rightarrow \mathbb{R}, x^a = \xi^a(f(\tau), a^k, \alpha_l)$ family of worldlines in M , f arbitrary and monotonous, verifying

1. $\partial_{a^k} U = \alpha_k$
2. $\exists \lambda = \lambda(\tau), \lambda \partial_a U = g_{ab} \frac{d\xi^b}{d\tau}$
3. $x^a = \xi^a(f(\tau), a^k, \alpha_l)$ geodesics

$$\frac{D}{d\tau} \left[g_{ab} \frac{d\xi^b}{d\tau} \right] = \frac{\dot{\lambda}}{\lambda} g_{ab} \frac{d\xi^b}{d\tau}$$

4. $\frac{df}{d\tau} = \pm \lambda \Leftrightarrow s = f(\tau)$ proper time along geodesics

Note if τ proper time, $f(\tau) = \tau = s \Rightarrow \frac{df}{d\tau} = 1 = \pm \lambda \Rightarrow \dot{\lambda} = 0$

$$\frac{D}{d\tau} \left[g_{ab} \frac{d\xi^b}{d\tau} \right] = 0$$

so we get usual geodesic definition

Proof. There always exists (simplectic structure) $\varphi(x^a, a^k) = \tau$ such as $(\partial_{a,a^k}^2 U, \partial_b \varphi)$

↓
rank 3

is 4×4 of rank 4 (non-singular), and for f monotonous ($f \neq 0$)

$$\begin{cases} \phi(x^a, a^k) = f(\tau) & \text{can supplement} \\ \partial_{a^k} U(x^a, a^k) = \alpha_k \end{cases}$$

and the 4×4 system can be locally inverted into

$$\boxed{x^a = \xi^a(f(\tau), a^k, \alpha_l)}$$

Plug into algebraic equations, it verifies Condition 1: $\partial_{a^k} U(\xi^a, a^k) = \alpha_k$

As a complete integral, U verifies

$$g^{ab} \partial_a U \partial_b U = -1$$

so $\partial_a U$ is timelike

Differentiating

$$g^{ab} \partial_a U \partial_{b,a^k}^2 U = 0$$

so the $\partial_{a,a^k}^2 U$ are orthogonal, thus spacelike and, from definition, linearly independent

$\Rightarrow \partial_a U, \partial_{a,a^k}^2 U$ linearly independent

$$\frac{d}{d\tau} (\partial_{a^k} U(\xi^a, a^k) = \alpha_k) \Leftrightarrow \partial_{a,a^k}^2 U \frac{d\xi^a}{d\tau} = 0$$

Thus $\frac{d\xi^a}{d\tau}$ orthogonal to all three $\partial_{a,a^k}^2 U$, therefore parallel to $\partial_a U$ (in 4D), thus

proportional, and we get $\boxed{g_{ab} \frac{d\xi^b}{d\tau} = \lambda \partial_a U}$ for $\lambda(\tau, x^a, a^k, \alpha_l)$

Using it into $g^{ab} \partial_a U \partial_b U = -1$, we get

$$g^{ab} g_{ac} \frac{d\xi^c}{\lambda} \frac{g_{bd}}{\lambda} \frac{d\xi^d}{d\tau} = \frac{g_{ac}}{\lambda^2} \frac{d\xi^c}{d\tau} \frac{d\xi^a}{d\tau} = -1$$

Now choose $f(\tau) = s$ proper time, then $g_{ab} \frac{d\xi^a}{ds} \frac{d\xi^b}{ds} = -1$

Since $\frac{d\xi^a}{d\tau} = \frac{d\xi^a}{ds} \frac{ds}{d\tau} = \frac{d\xi^a}{ds} \frac{df}{d\tau}$ then we have $-1 = \frac{g_{ab}}{\lambda^2} \frac{d\xi^a}{ds} \frac{d\xi^b}{ds} \left(\frac{df}{d\tau}\right)^2 = -\left(\frac{df}{\lambda}\right)^2$

thus $\boxed{\frac{df}{d\tau} = \pm \lambda(\tau)}$ which yields Conditions 2 and 4

Now from $g_{ab} \frac{d\xi^b}{d\tau} = \lambda \partial_a U$, we can write

$$\frac{D}{d\tau} \left[g_{ab} \frac{d\xi^b}{d\tau} \right] = \dot{\lambda} \partial_a U + \lambda (\partial_a U)_{;b} \frac{d\xi^b}{d\tau}$$

and for a scalar ϕ

$$\begin{aligned}\phi_{;ab} &= (\phi_{,a})_{;b} \\ &= \phi_{,ab} - \Gamma_{ab}^c \phi_{,c} \\ &= \phi_{,ba} - \Gamma_{ba}^c \phi_{,c} \\ &= (\phi_{,b})_{;a} = \phi_{;ba}\end{aligned}$$

thus

$$\begin{aligned}\boxed{\frac{D}{d\tau} \left[g_{ab} \frac{d\xi^b}{d\tau} \right]} &= \dot{\lambda} \partial_a U + \lambda^2 g^{bc} (\partial_a U)_{;b} \partial_c U \\ &= \dot{\lambda} \partial_a U + \frac{\lambda^2}{2} \nabla_b (g^{bc} \partial_a U \partial_c U) \\ &= \dot{\lambda} \partial_a U = \boxed{\frac{\dot{\lambda}}{\lambda} g_{ab} \frac{d\xi^b}{d\tau}}\end{aligned}$$

□

Of course $\partial_{a^k} U = \alpha_k$ is also telling α_k constant of motion of geodesics ξ^a :
 $\frac{D}{d\tau} \left[\frac{d\xi_a}{d\tau} \right] = \frac{\dot{\lambda}}{\lambda} \frac{d\xi_a}{d\tau}$ using the set

$$\begin{cases} U = s - s_0 \\ \partial_{a^k} U = \alpha_k \end{cases}$$

instead of an arbitrary function yields a unique solution $x^a = \xi^a (s - s_0, a^k, \alpha_l)$
 geodesic for proper time s

9.3 Geodesic deviation (overview)

The action functional for evolution of geodesic deviation r^a along geodesic γ :
 $x^a = \xi^a (\tau)$ reads

$$S[\gamma, r] = \int_{\tau_0}^{\tau_1} d\tau g_{ab} \frac{\dot{\xi}^a}{(-\dot{\xi}^c \dot{\xi}_c)^{\frac{1}{2}}} \frac{Dr^b}{d\tau}$$

Variations with respect to r^a yield geodesic equation on ξ^a
 while ξ^a geodesic deviation equation on r^a . As before

$$\begin{aligned}\bar{\delta} \xi^a &= \partial_\epsilon \xi^a (\tau, 0) \delta \epsilon \\ \bar{\delta} r^a &= \partial_\epsilon r^a (\tau, 0) \delta \epsilon \\ \delta \tau &= \partial_\epsilon \tau (0) \delta \epsilon\end{aligned}$$

and complete variations are

$$\begin{aligned}\delta \xi^a &= \bar{\delta} \xi^a + \dot{\xi}^a \delta \tau \\ \delta r^a &= \bar{\delta} r^a + \dot{r}^a \delta \tau\end{aligned}$$

Thus we get, with $h_{ab} = g_{ab} + \frac{\xi_a \dot{\xi}_b}{(-\dot{\xi}^c \dot{\xi}_c)}$ projector on space

$$\begin{aligned} \delta S = & \left[\frac{1}{(-\dot{\xi}^c \dot{\xi}_c)^{\frac{1}{2}}} \left(h_{ab} \frac{Dr^b}{d\tau} + \Gamma_{ac}^b r^c \dot{\xi}_b \right) \delta \xi^a - \frac{1}{(-\dot{\xi}^c \dot{\xi}_c)^{\frac{1}{2}}} g_{ab} \dot{\xi}^a \delta r^b \right]_{\tau_0}^{\tau_1} \\ & - \int_{\tau_0}^{\tau_1} d\tau \left\{ \left[\frac{D}{d\tau} \left(\frac{h_{ab}}{(-\dot{\xi}^c \dot{\xi}_c)^{\frac{1}{2}}} \frac{Dr^b}{d\tau} \right) + \frac{R_{abcd} \dot{\xi}^b r^c \dot{\xi}^d}{(-\dot{\xi}^c \dot{\xi}_c)^{\frac{1}{2}}} + \Gamma_{ab}^c r^b \frac{D}{d\tau} \left(\frac{1}{(-\dot{\xi}^c \dot{\xi}_c)^{\frac{1}{2}}} \right) \right] \bar{\delta} \xi^a \right. \\ & \left. + \frac{D}{d\tau} \left(\frac{\dot{\xi}^a}{(-\dot{\xi}^c \dot{\xi}_c)^{\frac{1}{2}}} \right) \bar{\delta} r^a \right\} \end{aligned}$$

When $\delta \epsilon = 0$, δr^a and $\delta \xi^a$ independent and vanishing at τ_0, τ_1 ,

$$\delta S = 0 \Leftrightarrow \begin{cases} \frac{D}{d\tau} \left(\frac{\dot{\xi}^a}{(-\dot{\xi}^c \dot{\xi}_c)^{\frac{1}{2}}} \right) = 0 \text{ geodesic equation} \\ \frac{D}{d\tau} \left(\frac{h_{ab}}{(-\dot{\xi}^c \dot{\xi}_c)^{\frac{1}{2}}} \frac{Dr^b}{d\tau} \right) + \frac{R_{abcd} \dot{\xi}^b r^c \dot{\xi}^d}{(-\dot{\xi}^c \dot{\xi}_c)^{\frac{1}{2}}} = 0 \text{ geodesic deviation equation} \end{cases}$$

Solutions: $\xi^a(\tau), r^a(\tau)$ so Principal function is

$$S(\xi^a, r^a, \tau) = \int_{\tau_0}^{\tau_1} d\tau g_{ab} \frac{\dot{\xi}^a}{(-\dot{\xi}^c \dot{\xi}_c)^{\frac{1}{2}}} \frac{Dr^b}{d\tau}$$

and differential for solutions ξ^a, r^a yield

$$dS = \frac{1}{(-\dot{\xi}^c \dot{\xi}_c)^{\frac{1}{2}}} \left(h_{ab} \frac{Dr^b}{d\tau} + g_{bd} \Gamma_{ac}^b r^c \dot{\xi}^d \right) dx^a + g_{ab} \frac{\dot{\xi}^b}{(-\dot{\xi}^c \dot{\xi}_c)^{\frac{1}{2}}} dr^a$$

therefore

$$\begin{aligned} \partial_{r^a} S &= 0 \quad \partial_{r^a} S = g_{ab} \frac{\dot{\xi}^b}{(-\dot{\xi}^c \dot{\xi}_c)^{\frac{1}{2}}} \\ \partial_a S &= \frac{1}{(-\dot{\xi}^c \dot{\xi}_c)^{\frac{1}{2}}} \left(h_{ab} \frac{Dr^b}{d\tau} + g_{bd} \Gamma_{ac}^b r^c \dot{\xi}^d \right) \end{aligned}$$

and we can combine them into

- $g^{ab} \partial_{r^a} S \partial_{r^b} S = -1$ as previously $\frac{\dot{\xi}^a \dot{\xi}_a}{-\dot{\xi}^d \dot{\xi}_d} = -1$
and $\partial_a S - \Gamma_{ac}^b r^c \partial_{r^b} S = \frac{h_{ab}}{(-\dot{\xi}^c \dot{\xi}_c)^{\frac{1}{2}}} \frac{Dr^b}{d\tau}$, so

•

$$g^{ab}\partial_{r^a}S(\partial_a S - \Gamma_{ac}^b r^c \partial_{r^b}S) = \frac{\dot{\xi}^b}{\left(-\dot{\xi}^d \dot{\xi}_d\right)^{\frac{1}{2}}} \frac{h_{bc}}{\left(-\dot{\xi}^e \dot{\xi}_e\right)^{\frac{1}{2}}} \frac{Dr^c}{d\tau}$$

$$= 0 \text{ since } h_{bc}\dot{\xi}^b = 0$$

Those last two equations are the Hamilton-JACOBI equations for $\begin{cases} \text{geodesics} \\ \text{geodesic deviation} \end{cases}$
 Now we will solve them with additional Jacobi-type theorems

9.3.1 Theorems on geodesic deviation solutions

We solve the system

$$\begin{cases} g^{ab}\partial_{r^a}S\partial_{r^b}S = -1 \\ g^{ab}\partial_{r^b}S(\partial_a S - \Gamma_{ac}^b r^c \partial_{r^b}S) = 0 \end{cases}$$

for S defined in tangent bundle TM and take values in $M(x^a)$ and in $T_x M$, tangent space at x

Definition 9.2. S complete integral of $\begin{cases} g\partial_r S\partial_r S = -1 \\ g\partial_r S(\partial S - \Gamma r\partial_r S) = 0 \end{cases}$
 $S : M \times T_x M \times \mathbb{R}^6 \longrightarrow \mathbb{R}, S = S(x^a, r^b, a^k, b^l) \Leftrightarrow$

1. S solution of $\forall (a^k, b^l) \in \mathbb{R}^6$
- 2.

$$M_{8 \times 6} = \begin{pmatrix} \partial_{a,a^k}^2 S & \partial_{b,b^l}^2 S \\ \partial_{r^a, a^k}^2 S & \partial_{r^b, b^l}^2 S \end{pmatrix}$$

is rank 6

Existence of complete integral follows

Theorem 9.3. *of existence*

All complete integral $U(x^a, a^k)$ of $g^{ab}\partial_a U\partial_b U = -1$ generates a complete integral $S(x^a, r^b, a^k, b^l)$ of $\begin{cases} g\partial_r S\partial_r S = -1 \text{ in the form} \\ g\partial_r S(\partial S - \Gamma r\partial_r S) = 0 \end{cases}$

$$S = \partial_a U r^a + \partial_{a^k} U b^k$$

From form

- $\partial_{r^a} S = \partial_a U$ and $g\partial U\partial U = -1 \Rightarrow g\partial_r S\partial_r S = -1$
- $\partial_a S = \partial_{ab}^2 U r^b + \partial_{a,a^k}^2 U b^k$

so

$$\begin{aligned}
g\partial_r S (\partial S - \Gamma r \partial_r S) &= g^{ab} \partial_a U \left(\partial_{bc}^2 U r^c + \partial_{b,a^k}^2 U b^k - \Gamma_{bc}^d r^c \partial_d U \right) \\
&= g^{ab} \partial_a U (\partial_b U)_{;c} r^c + g^{ab} \partial_a U \partial_{b,a^k}^2 U b^k \\
&= \underbrace{\left(\frac{g^{ab}}{2} \partial_a U \partial_b U \right)}_{-\frac{1}{2}}_{;c} + \partial_{a^k} \underbrace{\left(\frac{g^{ab}}{2} \partial_a U \partial_b U \right)}_{-\frac{1}{2}} b^k \\
&= 0
\end{aligned}$$

So S verifies definition 9.2-1

From form $S = \partial_a U r^a + \partial_{a^k} U b^k$ we get

$$M_{8 \times 6} = \begin{pmatrix} \partial_{a,a^k}^2 S & \partial_{b,a^l}^2 U \\ \partial_{a,a^k}^2 U & 0 \end{pmatrix}$$

since $\partial_{b^i} (\partial_b U) = 0$

As $\partial_{a,a^k}^2 U$ are 3 linearly independent 4-vectors (rank 3) then the columns of $M_{8 \times 6}$ are 6 L.I. 8-vectors and $M_{8 \times 6}$ is of rank 6 (Def. 9.2-2)

Theorem 9.4. *Jacobi theorem on geodesic deviations*

$S = \partial_a U r^a + \partial_{a^k} U b^k$ where U complete integral of $g^{ab} \partial_a U \partial_b U = -1 \Rightarrow$

1. $\partial_{b^k} S = \partial_{a^k} U = \alpha_k$ determines a family of geodesics $x^a = \xi^a (f(\tau), a^k, \alpha_l)$ from Jacobi theorem on geodesics (9.2)
- 2.

$$\begin{cases} \partial_{a^k} S (\xi^a, r^b, a^m, b^l) = \beta_k \\ \partial_{r^a} S r^a = \mu(\tau) \end{cases}$$

with $\beta_k \in \mathbb{R}^3$ and μ arbitrary can be solved locally for r^a and determine $r^a = \rho^a (\tau, a^k, \alpha_l, b^m, \beta_n, \mu(\tau))$ which defines for constant $a^k, \alpha_l, b^m, \beta_n$ a vector field along ξ^a geodesic

3. ρ^a verifies

$$(a) \partial_{r^a} S \frac{D\rho^a}{d\tau} = \dot{\mu}(\tau) \text{ for } \begin{cases} x^a = \xi^a \\ r^a = \rho^a \end{cases} \text{ and from } \begin{cases} \lambda \partial_a U = g_{ab} \frac{d\xi^b}{d\tau} \\ \partial_{r^a} S = \partial_a U \end{cases}$$

$$\lambda \partial_{r^a} S \frac{D\rho^a}{d\tau} = \lambda \partial_a U \frac{D\rho^a}{d\tau} = \boxed{g_{ab} \frac{d\xi^b}{d\tau} \frac{D\rho^a}{d\tau} = \lambda \dot{\mu}}$$

- (b)

$$\begin{aligned}
\frac{D\rho^a}{d\tau} &= [\lambda g^{ab} (\partial_b S - \Gamma_{bd}^c r^d \partial_{r^c} S) - \dot{\mu} g^{ab} \partial_{r^b} S] \begin{matrix} x = \xi \\ r = \rho \end{matrix} \\
&= \lambda g^{ab} [(\partial_b U)_{;d} r^d + \partial_{b,a^k}^2 U b^k] \begin{matrix} x = \xi \\ r = \rho \end{matrix} - [\dot{\mu} g^{ab} \partial_b U] \begin{matrix} x = \xi \\ r = \rho \end{matrix}
\end{aligned}$$

(c) Geodesic deviation equation

$$\frac{D^2 \rho^a}{d\tau^2} + R_{abcd} \frac{d\xi^b}{d\tau} \rho^c \frac{d\xi^d}{d\tau} = \frac{\dot{\lambda}}{\lambda} \frac{D\rho^a}{d\tau} - \frac{d}{d\tau} \left(\frac{\dot{\mu}}{\lambda} \right) \frac{d\xi^a}{d\tau}$$

Note as before that τ proper time and $\mu(\tau) = \tau$ yields usual geodesic deviation.

Proof.

- From $S = \partial_a U r^a + \partial_{a^k} U b^k$
 - $\partial_{b^k} S = \partial_{a^k} U = \alpha_k$ from Geodesic Jacobi theorem (9.2) and thus 9.4-1 is fulfilled from it
 - We can rewrite the system

$$\begin{cases} \partial_{a^k} S = \partial_{a, a^k}^2 U r^a + \partial_{a^k a^l}^2 U b^l = \beta_k \\ \partial_{r^a} S r^a = \partial_a U r^a = \mu \end{cases} \Rightarrow \begin{cases} \partial_{a, a^k}^2 U r^a = \beta_k - \partial_{a^k a^l}^2 U b^l \\ \partial_a U r^a = \mu \end{cases}$$

while $\partial_a U, \partial_{a, a^k}^2 U$ are linearly independent, so this invertible linear system ensure existence and unicity of $r^a = \rho^a(\tau, a^k, \alpha_l, b^m, \beta_n, \mu)$ (9.4-2)

- Since $\partial_a U r^a = \mu \Rightarrow \lambda \partial_a U \rho^a = \lambda \mu$ and given U complete integral of $g^{ab} \partial_a U \partial_b U = -1$, so

$$\begin{cases} \lambda \partial_a U = g_{ab} \frac{d\xi^b}{d\tau} \\ \frac{D}{d\tau} \left[g_{ab} \frac{d\xi^b}{d\tau} \right] = \frac{\dot{\lambda}}{\lambda} g_{ab} \frac{d\xi^b}{d\tau}, \end{cases}$$

then $g_{ab} \frac{d\xi^b}{d\tau} \rho^a = \lambda \mu$. Taking its $\frac{D}{d\tau}$ we get

$$\begin{aligned} \frac{D}{d\tau} \left[g_{ab} \frac{d\xi^b}{d\tau} \rho^a \right] &= \dot{\lambda} \mu + \lambda \dot{\mu} \\ &= \frac{\dot{\lambda}}{\lambda} g_{ab} \frac{d\xi^b}{d\tau} \rho^a + g_{ab} \frac{d\xi^b}{d\tau} \frac{D\rho^a}{d\tau} \\ &= \dot{\lambda} \partial_a U \rho^a + \lambda \partial_a U \frac{D\rho^a}{d\tau} \\ &= \dot{\lambda} \mu + \lambda \partial_a U \frac{D\rho^a}{d\tau} \\ \Leftrightarrow \lambda \partial_a U \frac{D\rho^a}{d\tau} &= \lambda \dot{\mu} \\ \Rightarrow \partial_{r^a} S \frac{D\rho^a}{d\tau} &= \dot{\mu} \end{aligned}$$

(9.4-3a)

- Now from $\partial_{a^k} S = \beta_k = cst$ we can use again $S = \partial_a U r^a + \partial_{a^k} U b^k$ on shell $\begin{pmatrix} x = \xi \\ r = \rho \end{pmatrix}$ to write

$$\begin{aligned} 0 &= \frac{D}{d\tau} \beta_k = \frac{D}{d\tau} (\partial_{a^k} S) = \frac{D}{d\tau} \left(\partial_{a,a^k}^2 U \rho^a + \partial_{a^k a^l}^2 U b^l \right) \\ &= \partial_{a,a^k}^2 U \frac{D\rho^a}{d\tau} + \frac{D}{d\tau} \left(\partial_{a,a^k}^2 U \right) \rho^a + \partial_{a,a^k a^l}^3 U \frac{d\xi^a}{d\tau} b^l \end{aligned}$$

since b^l independent parameter

2nd term

$$\begin{aligned} \frac{D}{d\tau} \left(\partial_{a,a^k}^2 U \right) &= \left(\partial_{a,a^k}^2 U \right)_{;b} \frac{d\xi^b}{d\tau} = \left(\partial_{a,a^k}^2 U \right)_{;b} \lambda g^{bc} \partial_c U && \text{from } \lambda \partial_a U = g_{ab} \frac{d\xi^b}{d\tau} \text{ (} U \text{ complete integral)} \\ &= \lambda g^{bc} \left(\partial_{b,a^k}^2 U \right)_{;a} \partial_c U && \text{from } \phi_{;ab} = \phi_{;ba} = (\phi_{,a})_{;b} \\ &= -\lambda g^{bc} \partial_{b,a^k}^2 U (\partial_c U)_{;a} && \text{from } g^{ab} \partial_a U \partial_{b,a^k}^2 U = 0 \text{ (} U \text{ complete integral)} \end{aligned}$$

3rd term from

$$\begin{aligned} 0 &= \partial_{a^k} \left(g^{ab} \partial_b U \partial_{a,a^l}^2 U \right) \\ &= g^{ab} \partial_{a,a^k a^l}^3 U \partial_b U + g^{ab} \partial_{a,a^l}^2 U \partial_{b,a^k}^2 U \end{aligned}$$

and with $\lambda \partial_a U = g_{ab} \frac{d\xi^b}{d\tau}$ we get

$$\partial_{a,a^k a^l}^3 U \frac{d\xi^a}{d\tau} = \lambda g^{ab} \partial_{a,a^k a^l}^3 U \partial_b U = -\lambda g^{ab} \partial_{a,a^l}^2 U \partial_{b,a^k}^2 U$$

Thus

$$0 = \partial_{a,a^l}^2 U \left\{ \frac{D\rho^a}{d\tau} - \lambda g^{ab} \left[(\partial_b U)_{;c} \rho^c + \partial_{b,a^k}^2 U b^l \right] \right\}$$

Since the vectors $\partial_{a,a^k}^2 U$ are linearly independent in 4D, bracket is proportional to $g^{ab} \partial_b U$:

$$\exists \bar{\mu}(\tau), \{ \} = \bar{\mu} g^{ab} \partial_b U \Leftrightarrow \frac{D\rho^a}{d\tau} = \lambda g^{ab} \left[(\partial_b U)_{;c} \rho^c + \partial_{b,a^l}^2 U b^l \right] + \bar{\mu} g^{ab} \partial_b U$$

Contracting with $\partial_a U$ we get

$$\begin{aligned} \partial_a U \frac{D\rho^a}{d\tau} &= \dot{\mu} \\ &= \lambda \left[g^{ab} \partial_a U (\partial_b U)_{;c} \rho^c + g^{ab} \partial_a U \partial_{b,a^l}^2 U b^l \right] + \bar{\mu} g^{ab} \partial_a U \partial_b U \end{aligned}$$

Since $g^{ab} \partial_a U \partial_b U = -1$ then any derivatives, including $g^{ab} \partial_a U (\partial_b U)_{;c} = 0 = g^{ab} \partial_a U \partial_{b,a^k}^2 U$ (U complete integral)

so $\dot{\mu} = -\bar{\mu}$

Thus

$$\boxed{\frac{D\rho^a}{d\tau} = \lambda g^{ab} \left[(\partial_b U)_{;c} r^c + \partial_{b,a^k}^2 U b^k \right] \begin{matrix} x = \xi \\ r = \rho \end{matrix} - \dot{\mu} g^{ab} [\partial_b U] \begin{matrix} x = \xi \\ r = \rho \end{matrix}}$$

and $(\partial_b U)_{;c} = \partial_c (\partial_b U) - \Gamma_{bc}^d \partial_d U$ while $\partial_a U = \partial_{r^a} S$ and $\partial_a S = \partial_{ab}^2 U r^b + \partial_{a,a^k}^2 U b^k$ so

$$\boxed{\frac{D\rho^a}{d\tau} = [\lambda g^{ab} (\partial_b S - \Gamma_{bc}^d r^c \partial_{r^d} S) - \dot{\mu} g^{ab} \partial_{r^b} S] \begin{matrix} x = \xi \\ r = \rho \end{matrix}}$$

which is (9.4-3b)

- From (U complete integral) $\lambda g^{ab} \partial_b U = \frac{d\xi^a}{d\tau}$ the previous equation can write

$$\frac{D\rho^a}{d\tau} = \lambda g^{ab} \left[(\partial_b U)_{;c} \rho^c + \partial_{b,a^k}^2 U b^k \right] - \frac{\dot{\mu}}{\lambda} \frac{d\xi^a}{d\tau}$$

and taking $\frac{D}{d\tau}$

$$\begin{aligned} \frac{D^2 \rho^a}{d\tau^2} &= \dot{\lambda} g^{ab} \left[(\partial_b U)_{;c} \rho^c + \partial_{b,a^k}^2 U b^k \right] + \lambda \frac{D}{d\tau} \left(g^{ab} \left[(\partial_b U)_{;c} \rho^c + \partial_{b,a^k}^2 U b^k \right] \right) - \frac{d}{d\tau} \left(\frac{\dot{\mu}}{\lambda} \right) \frac{d\xi^a}{d\tau} - \frac{\dot{\mu} \dot{\lambda}}{\lambda^2} \frac{d\xi^a}{d\tau} \\ &\quad \text{from } \frac{D}{d\tau} \left[\frac{d\xi^a}{d\tau} \right] = \frac{\dot{\lambda}}{\lambda} \frac{d\xi^a}{d\tau} \\ &= \frac{\dot{\lambda}}{\lambda} \frac{D\rho^a}{d\tau} + \lambda \frac{D}{d\tau} \left(g^{ab} \left[(\partial_b U)_{;c} \rho^c + \partial_{b,a^k}^2 U b^k \right] \right) - \frac{d}{d\tau} \left(\frac{\dot{\mu}}{\lambda} \right) \lambda g^{ab} \partial_b U \end{aligned}$$

The second term can be decomposed in two, the first of which yields

$$\frac{D}{d\tau} \left[g^{ab} (\partial_b U)_{;c} \rho^c \right] = g^{ab} (\partial_b U)_{;cd} \rho^c \frac{d\xi^d}{d\tau} + g^{ab} (\partial_b U)_{;c} \frac{D\rho^c}{d\tau}$$

and commutation of covariant derivatives on scalar

$$= g^{ab} (\partial_c U)_{;bd} \rho^c \frac{d\xi^d}{d\tau} + g^{ab} (\partial_c U)_{;b} \frac{D\rho^c}{d\tau}$$

while the second gives, from $\left[g^{ab} \partial_{a,a^k}^2 U \partial_b U \right]_{;c} = 0$, $\phi_{,ab} = \phi_{,ba}$ and $\frac{d\xi^a}{d\tau} = \lambda g^{ab} \partial_b U$ (complete integral), as well as b^k independent parameter

$$\begin{aligned} \frac{D}{d\tau} \left[g^{ab} \partial_{b,a^k}^2 U b^k \right] &= g^{ab} \left(\partial_{b,a^k}^2 U \right)_{;c} \frac{d\xi^c}{d\tau} b^k \\ &= \lambda g^{ab} \left(\partial_{c,a^k}^2 U \right)_{;b} g^{cd} \partial_d U b^k \\ &= -\lambda g^{ab} \partial_{c,a^k}^2 U (\partial_d U)_{;b} g^{cd} b^k \end{aligned}$$

Substituting $\frac{D\rho}{d\tau}$ and summing those two terms, the second one cancels the “ b^k ” term of the $\frac{D\rho}{d\tau}$ development

$$\begin{aligned} \frac{D}{d\tau} \left(g^{ab} \left[(\partial_b U)_{;c} \rho^c + \partial_{b,a^k}^2 U b^k \right] \right) &= g^{ab} (\partial_c U)_{;bd} \rho^c \frac{d\xi^d}{d\tau} + g^{ab} (\partial_d U)_{;b} \left[\lambda g^{dc} (\partial_c U)_{;e} \rho^e + \lambda g^{dc} \partial_{c,a^k}^2 U b^k \right. \\ &\quad \left. - \dot{\mu} g^{dc} \partial_c U \right] - \lambda g^{ab} g^{cd} \partial_{e,a^k}^2 U (\partial_d U)_{;b} b^k \end{aligned}$$

so we have (using $g^{cd} \partial_c U (\partial_d U)_{;b} = 0$)

$$\frac{D^2 \rho^a}{d\tau^2} = \frac{\dot{\lambda}}{\lambda} \frac{D\rho^a}{d\tau} - \frac{d}{d\tau} \left(\frac{\dot{\mu}}{\lambda} \right) \frac{d\xi^a}{d\tau} + \lambda g^{ab} (\partial_c U)_{;bd} \rho^c \frac{d\xi^d}{d\tau} + \lambda^2 g^{dc} g^{ab} (\partial_d U)_{;b} (\partial_c U)_{;e} \rho^e$$

The last term reads

$$\begin{aligned} g^{ab} g^{cd} (\partial_d U)_{;b} (\partial_c U)_{;e} &= g^{ab} \left[(\partial_d U) (\partial_c U)_{;e} g^{cd} \right]_{;b} - g^{ab} (\partial_c U)_{;eb} \partial_d U g^{cd} \\ &= -g^{ab} (\partial_c U)_{;eb} \partial_d U g^{cd} \text{ since } g^{cd} \partial_c U \partial_d U = -1 \end{aligned}$$

Since U complete integral, $\lambda \partial_d U g^{cd} = \frac{d\xi^c}{d\tau}$ so

$$\lambda g^{dc} g^{ab} (\partial_d U)_{;b} (\partial_c U)_{;e} = -g^{ab} (\partial_c U)_{;eb} \frac{d\xi^c}{d\tau}$$

and the full equation reads, using $\phi_{;ab} = \phi_{;ba}$

$$\begin{aligned} \frac{D^2 \rho^a}{d\tau^2} &= \frac{\dot{\lambda}}{\lambda} \frac{D\rho^a}{d\tau} - \frac{d}{d\tau} \left(\frac{\dot{\mu}}{\lambda} \right) \frac{d\xi^a}{d\tau} + \lambda g^{ab} \left[(\partial_c U)_{;bd} \rho^c \frac{d\xi^d}{d\tau} - (\partial_c U)_{;eb} \frac{d\xi^c}{d\tau} \rho^e \right] \\ &= \frac{\dot{\lambda}}{\lambda} \frac{D\rho^a}{d\tau} - \frac{d}{d\tau} \left(\frac{\dot{\mu}}{\lambda} \right) \frac{d\xi^a}{d\tau} + \lambda g^{ab} \left[(\partial_c U)_{;bd} \frac{d\xi^d}{d\tau} \rho^c - (\partial_e U)_{;cb} \frac{d\xi^c}{d\tau} \rho^e \right] \\ &= \frac{\dot{\lambda}}{\lambda} \frac{D\rho^a}{d\tau} - \frac{d}{d\tau} \left(\frac{\dot{\mu}}{\lambda} \right) \frac{d\xi^a}{d\tau} + \lambda g^{ab} \left[(\partial_c U)_{;bd} - (\partial_c U)_{;db} \right] \rho^c \frac{d\xi^d}{d\tau} \end{aligned}$$

The Ricci identity here gives, using the Riemann symmetries and $\lambda g^{df} \partial_f U = \frac{d\xi^d}{d\tau}$

$$\begin{aligned} \lambda g^{ab} \rho^c \frac{d\xi^d}{d\tau} 2 (\partial_c U)_{;[bd]} &= \lambda g^{ab} \rho^c \frac{d\xi^d}{d\tau} R_{dbce} g^{ef} \partial_f U \\ &= -\lambda R^a_{dce} g^{ef} \partial_f U \rho^c \frac{d\xi^d}{d\tau} \\ &= -\lambda R^a_{bcd} g^{df} \partial_f U \rho^c \frac{d\xi^b}{d\tau} \\ &= -R^a_{bcd} \frac{d\xi^d}{d\tau} \rho^c \frac{d\xi^b}{d\tau} \end{aligned}$$

which gives (9.4-3c), the geodesic deviation equation

□

Chapter 10

Motion of a top in Relativity: the M.P.D. equations

[Mathisson(1937), Papapetrou(1951), Dixon(1970), Hojman(1975)]

Describe a top by its worldline $x^a(\tau)$ and the frame field (orthonormal) attached to it, represented by a tetrad $e_{(A)}^a(\tau)$ (see Fig. 10.0.1) also known as vierbein (vier=4 in German; $d = n$: vielbein)

The tetrad verifies 10 orthonormal relations

$$e_A^a e_B^b g_{ab} = \eta_{AB}$$

that defines the Minkowski tangent space

$$\eta_{AC} \eta^{CB} = \delta_A^B$$

and the manifold metric and its inverse with

$$e_A^a e_B^b \eta^{AB} = g^{ab}, \quad g^{ac} g_{cb} = \delta_b^a$$

Any vectors $V^a = V^A e_A^a$, $W^b = W^B e_B^b$ are defined also in the tangent space and their scalar product is given with metric in M and in Minkowski tangent space:

$$V^a W^b g_{ab} = V^A W^B e_A^a e_B^b g_{ab} = \eta_{AB} V^A W^B$$

We define the velocity on the top trajectory and the parallel transport of its tetrad as

$$\begin{aligned} \frac{dx^a}{d\tau} &= \dot{x}^a = u^a \\ \dot{e}_A^a &= \frac{D e_A^a}{d\tau} = \frac{d e_A^a}{d\tau} + \Gamma_{bc}^a e_A^b u^c \end{aligned}$$

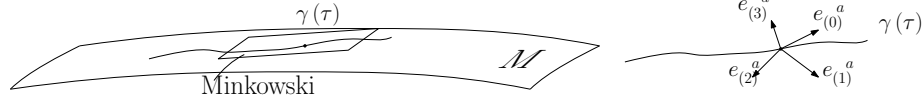

Figure 10.0.1: Motion of a top

10.1 Angular velocity tensor

We define the angular velocity tensor

$$\sigma^{ab} = \eta^{AB} e_A^a \frac{D e_B^b}{d\tau}$$

It is antisymmetric as

$$\begin{aligned} \frac{D}{d\tau} (e_A^a e_B^b \eta^{AB}) &= \frac{D}{d\tau} (g^{ab}) = 0 \text{ since } g^{ab} \text{ parallel transported (metricity)} \\ &= \overset{\circ}{e}_A^a e_B^b \eta^{AB} + e_A^a \overset{\circ}{e}_B^b \eta^{AB} \\ &\Leftrightarrow \sigma^{ab} = -\sigma^{ba} \end{aligned}$$

thus

$$\sigma_{ab} = \sigma_{[ab]}$$

It also defines the parallel transport of the tetrad since

$$\begin{aligned} \frac{D}{d\tau} (e_A^a e_B^b g_{ab}) &= \overset{\circ}{\eta}_{AB} = 0 \\ &= \overset{\circ}{e}_A^a e_B^b g_{ab} + e_A^a \overset{\circ}{e}_B^b g_{ab} \end{aligned}$$

Multiplying by $\eta^{CB} e_C^c$ one gets (after relabelling dummy indices)

$$\begin{aligned} \overset{\circ}{e}_A^c e_C^a e_B^b \eta^{CB} g_{cb} &= -e_A^c \underbrace{\eta^{CB} e_C^a e_B^b}_{\sigma^{ab}} g_{ab} \\ &\Leftrightarrow \overset{\circ}{e}_A^a = - (e_A)_b \sigma^{ab} \end{aligned}$$

10.2 Construction of top motion Lagrangian

We build now the Lagrangian from σ^{ab} , u^a and g_{ab} such that it is homogeneous of degree one in the velocities (u, σ) and constructed out of the 4 invariants:

$$\begin{aligned} a_1 &= g_{ab} u^a u^b = u^2 \\ a_2 &= g_{ac} g_{bd} \sigma^{ab} \sigma^{cd} = \text{tr} \sigma^2 \\ a_3 &= g_{ac} g_{bd} g_{ef} u^a \sigma^{ce} u^b \sigma^{fd} = u \sigma \sigma u \\ a_4 &= g_{ac} g_{bd} g_{ef} g_{gh} \sigma^{ha} \sigma^{bc} \sigma^{de} \sigma^{fg} = \text{tr} \sigma^4 \end{aligned}$$

so $\mathcal{L} = \mathcal{L}(a_1, a_2, a_3, a_4) = \mathcal{L}(u^2, \text{tr}\sigma^2, u\sigma\sigma u, \text{tr}\sigma^4)$

To get the equations of motion requires to vary \mathcal{L} with respect to the 6 independent components of e_A^a and to x^a . We obtain them through the anti-symmetric tensor θ^{ab} , which variation is defined as (with 6 non zero components)

$$\delta\theta^{ab} = \eta^{AB} e_A^a D e_B^b = \eta^{AB} e_A^a (\delta e_B^b + \Gamma_{cd}^b e_B^c \delta x^d) = -\delta\theta^{ba}$$

from variation of the metric

Let us relate now $\delta\sigma^{ab}$ with $\frac{D\delta\theta^{ab}}{d\tau}$ to use $\delta\theta^{ab}$ related to σ_{ab} as δx^a to u^a

Parallel transport for tensors gives us

$$D\sigma^{ab} = \delta\sigma^{ab} + \Gamma_{cd}^a \sigma^{cb} \delta x^d + \Gamma_{cd}^b \sigma^{ac} \delta x^d$$

and

$$\frac{D\delta\theta^{ab}}{d\tau} = \frac{d}{d\tau} (\delta\theta^{ab}) + \Gamma_{cd}^a \delta\theta^{cb} u^d + \Gamma_{cd}^b \delta\theta^{ac} u^d$$

Since equations are tensorial, they are independent of frame.

Choosing a locally flat frame ($\Gamma = 0$, which we always can from the equivalence principle, and see Theorem 4.1) this becomes

$$\left\{ \begin{array}{ll} D\sigma^{ab} = \delta\sigma^{ab} & \text{and using } \sigma^{ab} = \eta^{AB} e_A^a \overset{\circ}{e}_B^b \\ \frac{D\delta\theta^{ab}}{d\tau} = \frac{d}{d\tau} (\delta\theta^{ab}) & \text{and } \overset{\circ}{e}_A^a = \dot{e}_A^a + \underbrace{\Gamma_{cd}^a}_{=0 \text{ locally}} e_A^c u^d \end{array} \right.$$

we have

•

$$\begin{aligned} D\sigma^{ab} &= \eta^{AB} \left(\delta e_A^a \overset{\circ}{e}_B^b + e_A^a \delta \left(\overset{\circ}{e}_B^b \right) \right) \\ &= \eta^{AB} [\delta e_A^a \dot{e}_B^b + e_A^a (\delta \dot{e}_B^b + \Gamma_{cd,e}^b e_B^c u^d \delta x^e)] \end{aligned}$$

•

$$\begin{aligned} \frac{D\delta\theta^{ab}}{d\tau} &= \frac{d\delta\theta^{ab}}{d\tau} = \frac{d}{d\tau} (\eta^{AB} e_A^a (\delta e_B^b + \Gamma_{cd}^b e_B^c \delta x^d)) \\ &= \eta^{AB} (\dot{e}_A^a \delta e_B^b + e_A^a [\delta \dot{e}_B^b + \Gamma_{cd,e}^b e_B^c \delta x^d u^e]) \end{aligned}$$

Subtracting

$$D\sigma^{ab} - \frac{D\delta\theta^{ab}}{d\tau} = \eta^{AB} \left[\delta e_A^a \dot{e}_B^b - \dot{e}_A^a \delta e_B^b + e_A^a \left(2\Gamma_{c[d,e]}^b e_B^c u^d \delta x^e \right) \right]$$

and we recognise the Riemann tensor for $\Gamma = 0$ case in $2\Gamma_{c[d,e]}^a$ from its definition $R_{bcd}^a = -2\Gamma_{b[c,d]}^a + 2\Gamma_{[c|e}^a \Gamma_{|d]b}^e$

Moreover for $\Gamma = 0$, the definition $\delta\theta^{ab} = \eta^{AB} e_A^a \delta e_B^b$ gives

$$g_{bc} e_A^c \delta\theta^{ba} = \eta^{BC} (e_A)_b e_B^b \delta e_C^a = \eta^{BC} \eta_{AB} \delta e_C^a = \delta e_A^a$$

as well as $\dot{e}_A^a = \dot{e}_A^a = - (e_A)_b \sigma^{ab}$

so the difference reads

$$\begin{aligned} D\sigma^{ab} - \frac{D\delta\theta^{ab}}{d\tau} &= \eta^{AB} \left[\underbrace{-g_{dc} e_A^c \delta\theta^{da} (e_B)_e}_{-\delta\theta^{ad} g_{de}} \sigma^{be} + \underbrace{(e_A)_c \sigma^{ac} g_{de} e_B^e \delta\theta^{bd}}_{\sigma^{ac} g_{dc} \delta\theta^{bd}} + \underbrace{e_A^a e_B^c 2\Gamma_{c[d,e]}^b}_{g^{ac}} u^d \delta x^e \right] \\ &= \delta\theta^{ad} \sigma^b_d - \sigma^{ac} \delta\theta^b_c + g^{ac} R^b_{ced} u^d \delta x^e \\ &\Leftrightarrow D\sigma^{ab} = \frac{D\delta\theta^{ab}}{d\tau} + \sigma^{ac} \delta\theta^b_c - \delta\theta^{ac} \sigma^b_c - g^{ac} R^b_{cde} u^d \delta x^e \end{aligned}$$

For the variational principle, we use $\delta\sigma^{ab}$ so recall the parallel transport variations

$$D\sigma^{ab} = \delta\sigma^{ab} + \Gamma^a_{cd} \sigma^{cb} \delta x^d + \Gamma^b_{cd} \sigma^{ac} \delta x^d$$

and

$$\frac{D\delta\theta^{ab}}{d\tau} = \delta\dot{\theta}^{ab} + \Gamma^a_{cd} \delta\theta^{cb} u^d + \Gamma^b_{cd} \delta\theta^{ac} u^d$$

so we can extract

$$\delta\sigma^{ab} = \delta\dot{\theta}^{ab} + \Gamma^a_{cd} (\delta\theta^{cb} u^d - \sigma^{cb} \delta x^d) + \Gamma^b_{cd} (\delta\theta^{ac} u^d - \sigma^{ac} \delta x^d) + \sigma^{ac} \delta\theta^b_c - \delta\theta^{ac} \sigma^b_c - g^{ac} R^b_{cde} u^d \delta x^e$$

that should be used in the variational principle. We also need the canonical momenta

Defining $L_i = \frac{\partial \mathcal{L}}{\partial a_i}$, we also need the derivatives of the invariants with respect to the velocities:

$$\begin{aligned} \bullet \frac{\partial u^2}{\partial u_a} &= \frac{\partial (u_b u_c g^{bc})}{\partial u_a} = \delta_b^a u_c g^{bc} + \delta_c^a u_b g^{bc} = u^a + u^a = 2u^a \\ \bullet \frac{\partial (u\sigma\sigma u)}{\partial u_a} &= \frac{\partial ((u\sigma)_b (u\sigma)_c g^{bc})}{\partial u_a} = \frac{\partial (u\sigma)_b}{\partial u_a} (u\sigma)_c g^{bc} + \frac{\partial (u\sigma)_c}{\partial u_a} (u\sigma)_b g^{bc} \\ &= \frac{\partial (u_d \sigma^{de} g_{eb})}{\partial u_a} (u\sigma)_c g^{bc} + \frac{\partial (u_d \sigma^{ed} g_{ec})}{\partial u_a} (u\sigma)_b g^{bc} \\ &= \delta_d^a \sigma^{de} g_{eb} \sigma^{bf} u_f + \delta_d^a \underbrace{\sigma^{ed}}_{-\sigma^{de}} g_{ec} u_f \underbrace{\sigma^{fc}}_{-\sigma^{cf}} \\ &= 2\delta_d^a \sigma^{de} \sigma_e^f u_f \\ &= 2\sigma^{ab} \sigma_{bc} u^c \end{aligned}$$

and since $\sigma_{ab} = \sigma_{[ab]}$

- $$\begin{aligned} \frac{\partial(\operatorname{tr}\sigma^2)}{\partial\sigma_{ab}} &= \frac{\partial(\sigma_{cd}\sigma_{ef}g^{de}g^{cf})}{\partial\sigma_{ab}} = \frac{1}{2}(\delta_c^a\delta_d^b - \delta_c^b\delta_d^a)\sigma_{ef}g^{de}g^{cf} + \frac{1}{2}(\delta_e^a\delta_f^b - \delta_e^b\delta_f^a)\sigma_{cd}g^{de}g^{cf} \\ &= \frac{1}{2}(\sigma^{ba} - \sigma^{ab} + \sigma^{ba} - \sigma^{ab}) \\ &= -2\sigma^{ab} = 2\sigma^{ba} \end{aligned}$$
- $$\begin{aligned} \frac{\partial(\operatorname{tr}\sigma^4)}{\partial\sigma_{ab}} &= \frac{\partial(\sigma_{cd}\sigma_{ef}\sigma_{gh}\sigma_{ij}g^{cj}g^{de}g^{fg}g^{hi})}{\partial\sigma_{ab}} \\ &= \left[\frac{1}{2}(\delta_c^a\delta_d^b - \delta_c^b\delta_d^a)\sigma_{ef}\sigma_{gh}\sigma_{ij} + \frac{1}{2}(\delta_e^a\delta_f^b - \delta_e^b\delta_f^a)\sigma_{cd}\sigma_{gh}\sigma_{ij} + \frac{1}{2}(\delta_g^a\delta_h^b - \delta_g^b\delta_h^a)\sigma_{cd}\sigma_{ef}\sigma_{ij} \right. \\ &\quad \left. + \frac{1}{2}(\delta_i^a\delta_j^b - \delta_i^b\delta_j^a)\sigma_{cd}\sigma_{ef}\sigma_{gh} \right] g^{cj}g^{de}g^{fg}g^{hi} \\ &= \frac{1}{2}[\sigma_f^b\sigma^{fi}\sigma_i^a - \sigma_f^a\sigma^{fi}\sigma_i^b + \sigma_c^a\sigma_h^b\sigma^{ch} - \sigma_c^b\sigma_h^a\sigma^{hc} + \sigma_{cd}\sigma^{da}\sigma^{bc} - \sigma_{cd}\sigma^{db}\sigma^{ac} + \sigma_d^b\sigma^{df}\sigma_f^a \\ &\quad - \sigma_d^a\sigma^{df}\sigma_f^b] \\ &= \frac{1}{2}[\sigma^{bc}\sigma_{cd}\sigma^{da} + \sigma^{da}\sigma_{cd}\sigma^{bc} + \sigma^{da}\sigma^{bc}\sigma_{cd} + \sigma^{bc}\sigma^{da}\sigma_{cd} + \sigma^{bc}\sigma_{cd}\sigma^{da} + \sigma_{dc}\sigma^{bd}\sigma^{ca} + \sigma^{bc}\sigma_{cd}\sigma^{da} \\ &\quad + \sigma^{da}\sigma_{cd}\sigma^{bc}] \\ &= 4\sigma^{bc}\sigma_{cd}\sigma^{da} \end{aligned}$$
- $$\begin{aligned} \frac{\partial(u\sigma\sigma u)}{\partial\sigma_{ab}} &= \frac{\partial(u^c\sigma_{cd}g^{de}\sigma_{ef}u^f)}{\partial\sigma_{ab}} \\ &= \frac{u^c}{2}(\delta_c^a\delta_d^b - \delta_c^b\delta_d^a)g^{de}\sigma_{ef}u^f + u^c\sigma_{cd}\frac{g^{de}}{2}(\delta_e^a\delta_f^b - \delta_e^b\delta_f^a)u^f \\ &= \frac{1}{2}(u^a\sigma^{bc}u_c - u^b\sigma^{ac}u_c + u_c\sigma^{ca}u^b - u_c\sigma^{cb}u^a) \\ &= \frac{1}{2}(2u^{[a}\sigma^{b]c}u_c) \\ &= 2u^{[a}\sigma^{b]c}u_c \end{aligned}$$

We can now write the momenta

$$\begin{aligned} P^a &\equiv -\frac{\partial\mathcal{L}}{\partial u_a} = -\frac{\partial u^2}{\partial u_a}L_1 - \frac{\partial(u\sigma\sigma u)}{\partial u_a}L_3 \\ &= -2u^aL_1 - 2\sigma^{ab}\sigma_{bc}u^cL_3 \\ S^{ab} &\equiv -\frac{\partial\mathcal{L}}{\partial\sigma_{ab}} = -\frac{\partial(\operatorname{tr}\sigma^2)}{\partial\sigma_{ab}}L_2 - \frac{\partial(u\sigma\sigma u)}{\partial\sigma_{ab}}L_3 - \frac{\partial(\operatorname{tr}\sigma^4)}{\partial\sigma_{ab}}L_4 \\ &= -2\sigma^{ba}L_2 - 2u^{[a}\sigma^{b]c}u_cL_3 - 4\sigma^{bc}\sigma_{cd}\sigma^{da}L_4 \end{aligned}$$

To obtain the variations δx we will need to vary \mathcal{L} with g_{ab} , and so, for the symmetric tensor g_{ab} , we compute the derivatives of the invariants w.r.t. g_{ab} :

- $$\frac{\partial u^2}{\partial g_{ab}} = \frac{\partial(u^c u^d g_{cd})}{\partial g_{ab}} = \delta_c^{(a}\delta_d^{b)}u^c u^d = u^{(a}u^{b)} = u^a u^b$$

First

$$\begin{aligned}
\sigma^{ac} S_c^b - S^{ac} \sigma_c^b &= \sigma_c^a \left(-2\sigma^{bc} L_2 - 2u^{[c} \sigma^{b]d} u_d L_3 - 4\sigma^{bd} \sigma_{de} \sigma^{ec} L_4 \right) \\
&\quad + \left(2\sigma^{ca} L_2 + 2u^{[a} \sigma^{c]d} u_d L_3 + 4\sigma^{cd} \sigma_{de} \sigma^{ea} L_4 \right) \sigma_c^b \\
&= 2 \underbrace{(\sigma^{ac} \sigma_c^b - \sigma^{ac} \sigma_c^b)}_0 L_2 + ([u^a \sigma^{cd} u_d - u^c \sigma^{ad} u_d] \sigma_c^b + \sigma_c^a u^b \sigma^{cd} u_d - \sigma_c^a u^c \sigma^{bd} u_d) L_3 \\
&\quad + 4 \underbrace{(\sigma_c^a \sigma^{ce} \sigma_{ed} \sigma^{db} - \sigma^{ae} \sigma_{ed} \sigma^{dc} \sigma_c^b)}_0 L_4 \\
&= (u^b \sigma^{ac} \sigma_{cd} u^d - u^a \sigma^{bc} \sigma_{cd} u^d + \underbrace{\sigma^{ad} u_d \sigma^{bc} u_c - \sigma^{ac} u_c \sigma^{bd} u_d}_0) L_3 \\
&= -2u^{[a} \sigma^{b]c} \sigma_{cd} u^d L_3
\end{aligned}$$

while

$$\begin{aligned}
u^a P^b - u^b P^a &= u^a \underbrace{(-2u^b L_1 - 2\sigma^{bc} \sigma_{cd} u^d L_3)}_0 + (2u^a L_1 + 2\sigma^{ac} \sigma_{cd} u^d L_3) u^b \\
&= 2(u^b \sigma^{ac} \sigma_{cd} u^d - u^a \sigma^{bc} \sigma_{cd} u^d) L_3 \\
&= 2 \times -2u^{[a} \sigma^{b]c} \sigma_{cd} u^d L_3 \\
&= 2(\sigma^{ac} S_c^b - S^{ac} \sigma_c^b) \\
&\Leftrightarrow \boxed{2u^{[a} P^{b]} = 4\sigma^{[a|c} S_c^{b]}}
\end{aligned}$$

This result can be used in the form

$$2S^{bc} \sigma_c^a = 2u^{[a} P^{b]} + 2S^{ac} \sigma_c^b$$

to simplify the writing of Q^{ab} following

$$\begin{aligned}
\boxed{2u^{(a} P^{b)} - 4S^{(a|c} \sigma_c^{b)}} &= 2u^{(a} P^{b)} - 2(S^{ac} \sigma_c^b + S^{bc} \sigma_c^a) \\
&= 2(u^{(a} P^{b)} - u^{[a} P^{b]}) - 4S^{ac} \sigma_c^b \\
&= 2P^a u^b - 4S^{ac} \sigma_c^b
\end{aligned}$$

$$\begin{aligned}
\text{and using definitions} &= 2(-2u^a L_1 - 2\sigma^{ac} \sigma_{cd} u^d L_3) u^b + 4(2\sigma^{ca} L_2 + 2u^{[a} \sigma^{c]d} u_d L_3 + 4\sigma^{cd} \sigma_{de} \sigma^{ea} L_4) \sigma_c^b \\
&= 4(-u^a u^b L_1 - 2\sigma^{ac} \sigma_c^b L_2 - [u^b \sigma^{ac} \sigma_{cd} u^d + u^a \sigma^{cd} u_d \sigma_c^b + u^c \sigma^{ad} u_d \sigma_c^b] L_3 \\
&\quad - 4\sigma^{ea} \sigma^{bc} \sigma_{cd} \sigma_e^d L_4) \\
&= 4(-u^a u^b L_1 - 2\sigma^{ac} \sigma_c^b L_2 - [u^a \sigma^{bc} \sigma_{cd} u^d + u_d \sigma^{da} \sigma^{bc} u_c + u^d \sigma_{dc} \sigma^{ca} u^b] L_3 \\
&\quad - 4\sigma^{ea} \sigma^{bc} \sigma_{cd} \sigma_e^d L_4) \\
&= \boxed{4Q^{ab}}
\end{aligned}$$

We can now write the variations of the Lagrangian \mathcal{L} with respect to variations of independent variables u^a, x^a, σ^{ab}

$$\begin{aligned}\delta\mathcal{L} &= \frac{\partial\mathcal{L}}{\partial u_a} \delta u^a + \frac{\partial\mathcal{L}}{\partial\sigma_{ab}} \delta\sigma^{ab} + \frac{\partial\mathcal{L}}{\partial g^{bc}} \frac{\partial g^{bc}}{\partial x^a} \delta x^a \\ &= -P_a \delta u^a - S_{ab} \delta\sigma^{ab} - Q^{bc} g_{bc,a} \delta x^a\end{aligned}$$

Recall $\delta\sigma^{ab}$ as a function of $\delta\theta^{ab}$ and δx^a , we get

$$\begin{aligned}\delta\mathcal{L} &= -P_a \delta u^a - S_{ab} \left\{ \delta\dot{\theta}^{ab} + \sigma^{ac} \delta\theta_c^b - \delta\theta^{ac} \sigma_c^b + \Gamma_{cd}^a u^d \delta\theta^{cb} + \Gamma_{cd}^b u^d \delta\theta^{ac} \right. \\ &\quad \left. - (\Gamma_{cd}^a \sigma^{cb} + \Gamma_{cd}^b \sigma^{ac} + g^{ac} R_{ced}^b u^e) \delta x^d \right\} - \frac{1}{4} \left(2u^{(b} P^{c)} - 4S^{(b|d} \sigma_d^{c)} \right) g_{bc,a} \delta x^a \\ &= -P_a \delta u^a - S_{ab} \left(\delta\dot{\theta}^{ab} + \sigma^{ac} \delta\theta_c^b - \delta\theta^{ac} \sigma_c^b + \Gamma_{cd}^a u^d \delta\theta^{cb} + \Gamma_{cd}^b u^d \delta\theta^{ac} \right) \\ &\quad + \left[S_{ab} (\Gamma_{cd}^a \sigma^{cb} + \Gamma_{cd}^b \sigma^{ac} + g^{ac} R_{ced}^b u^e) - \frac{1}{4} \left(2u^{(b} P^{c)} - 4S^{(b|e} \sigma_e^{c)} \right) g_{bc,d} \right] \delta x^d\end{aligned}$$

We can simplify the first and last 2 terms of the δx factor using the momenta correspondance in the form $2S^{ce} \sigma_e^b = 2S^{be} \sigma_e^c + 2u^{[b} P^{c]}$ and relabelling dummy indices

$$\begin{aligned}\mathcal{J} &= S_{ab} (\Gamma_{cd}^a \sigma^{cb} + \Gamma_{cd}^b \sigma^{ac}) - \frac{1}{4} \left(2u^{(b} P^{c)} - 4S^{(b|e} \sigma_e^{c)} \right) g_{bc,d} \\ &= \Gamma_{cd}^a (S_{ab} \sigma^{cb} + S_{ba} \sigma^{bc}) - \frac{1}{4} \left(2 \left[u^{(b} P^{c)} - u^{[b} P^{c]} \right] - 2 \left[2S^{be} \sigma_e^c \right] \right) g_{bc,d} \\ &= -2S_{ae} \sigma^{ec} \Gamma_{cd}^a - \frac{g_{bc,d}}{2} (P^b u^c - 2S^{be} \sigma_e^c)\end{aligned}$$

since S and σ are antisymmetric. We can also introduce g^{ab} as a label intermediate

$$\begin{aligned}\mathcal{J} &= -2S_{ae} \sigma^{ec} \Gamma_{cd}^a - \frac{g^{ab}}{2} g_{bc,d} (P_a u^c - 2S_{ae} \sigma^{ec}) \\ &= S_{ae} \sigma^{ec} \left(\frac{g^{ab}}{2} g_{bc,d} - \Gamma_{cd}^a \right) - \frac{g^{ab}}{2} g_{bc,d} P_a u^c\end{aligned}$$

Using again the momenta correspondance with

$$2S_{ae} \sigma^{ec} = 2S^{ce} \sigma_{ea} - u_a P^c + P_a u^c$$

giving also

$$\begin{aligned}A^{cb} &\equiv 2S^{ce} \sigma_e^b - u^b P^c = 2S^{be} \sigma_e^c - u^c P^b \\ &= A^{bc} = A^{(cb)}\end{aligned}$$

recalling

$$\Gamma_{cd}^a = \frac{g^{ab}}{2} (g_{cb,d} + g_{db,c} - g_{cd,b})$$

$$\begin{aligned}
\mathcal{J} &= (A^c_a + P_a u^c) \left(\frac{g^{ab}}{2} g_{bc,d} - \Gamma_{cd}^a \right) - \frac{g^{ab}}{2} g_{bc,d} P_a u^c \\
&= A^c_a \frac{g^{ab}}{2} (g_{bc,d} - g_{cb,d} - g_{db,c} + g_{cd,b}) + P_a u^c \left(\frac{g^{ab}}{2} g_{bc,d} - \Gamma_{cd}^a - \frac{g^{ab}}{2} g_{bc,d} \right) \\
&= \frac{A^{(cb)}}{2} (g_{cd,b} - g_{bd,c}) - \Gamma_{cd}^a P_a u^c \\
&= -\Gamma_{cd}^a P_a u^c + A^{(cb)} g_{[c|d,|b]} = -\Gamma_{cd}^a P_a u^c
\end{aligned}$$

since $A^{(cb)} B_{[cb]} = -A^{(bc)} B_{[bc]} = -A^{(cb)} B_{[cb]} = 0$

Thus we can write

$$\begin{aligned}
\delta\mathcal{L} &= -P_a \delta u^a + (S_{ab} g^{ac} R_{ced}^b u^e - \Gamma_{cd}^a P_a u^c) \delta x^d - S_{ab} \left(\frac{D\delta\theta^{ab}}{d\tau} + \sigma^{ac} \delta\theta_c^b - \delta\theta^{ac} \sigma_c^b \right) \\
&= \frac{\partial\mathcal{L}}{\partial u_a} \delta u^a + \frac{\partial\mathcal{L}}{\partial x^a} \delta x^a + \frac{\partial\mathcal{L}}{\partial\theta_{ab}} \delta\theta^{ab}
\end{aligned}$$

and we can proceed to the equations of motion. First noting

$$\int \frac{\partial\mathcal{L}}{\partial x^a} \delta x^a d\tau = \int S^{cb} R_{bcea} u^e \delta x^a d\tau - \int \Gamma_{ca}^b P_b u^c \delta x^a d\tau$$

We recognise $\Gamma_{ca}^b P_b u^c \delta x^a = P_b \left(\frac{D\delta x^b}{d\tau} - \frac{d\delta x^b}{d\tau} \right)$ and proceed with an integration by parts which surface terms, where conventionally the variations are set to 0, are vanishing:

$$- \int \Gamma_{ca}^b P_b u^c \delta x^a d\tau = \int \left(\frac{DP_b}{d\tau} - \frac{dP_b}{d\tau} \right) \delta x^b d\tau + 0$$

and the corresponding Euler-Lagrange equation yields

$$\begin{aligned}
-\frac{D}{d\tau} \left(\frac{\partial\mathcal{L}}{\partial u_a} \right) &= \frac{DP^a}{d\tau} = -\frac{\partial\mathcal{L}}{\partial x_a} = -R_{ebc}^a u^e S^{bc} - \frac{DP^a}{d\tau} + \frac{dP^a}{d\tau} \\
&\Leftrightarrow \boxed{\frac{DP^a}{d\tau} = -\frac{1}{2} R_{ebc}^a u^e S^{bc} + \frac{1}{2} \frac{dP^a}{d\tau}}
\end{aligned}$$

Similarly

$$\int \frac{\partial\mathcal{L}}{\partial\theta_{ab}} \delta\theta^{ab} d\tau = \int (S_{bc} \sigma_c^a - S_{ac} \sigma_b^c) \delta\theta^{ab} d\tau + \int \frac{D\delta\theta^{ab}}{d\tau} S_{ab} d\tau$$

and a similar integration by parts with vanishing surface terms reads

$$\int \frac{D\delta\theta^{ab}}{d\tau} S_{ab} d\tau = - \int \frac{DS_{ab}}{d\tau} \delta\theta^{ab} d\tau + 0$$

The Euler-Lagrange equation of motion, this time, is

$$\begin{aligned}
-\frac{D}{d\tau} \left(\frac{\partial\mathcal{L}}{\partial\sigma_{ab}} \right) &= \frac{DS^{ab}}{d\tau} = -\frac{\partial\mathcal{L}}{\partial\theta_{ab}} = S^{ac} \sigma_c^b - S^{bc} \sigma_c^a - \frac{DS^{ab}}{d\tau} \\
&\Leftrightarrow \boxed{\frac{DS^{ab}}{d\tau} = \frac{1}{2} (S^{ac} \sigma_c^b - S^{bc} \sigma_c^a)}
\end{aligned}$$

and the momenta correspondence allows to write

$$\boxed{\frac{DS^{ab}}{d\tau} = \frac{1}{4} (P^a u^b - P^b u^a)}$$

We can prove that $J^2 = \frac{1}{2} g_{ab} g_{cd} S^{ac} S^{bd}$ is a constant of motion: (S_{ab} antisymmetric)

Proof.

$$\begin{aligned} \frac{DJ^2}{d\tau} &= \frac{\partial J^2}{\partial S^{ab}} \frac{DS^{ab}}{d\tau} = \frac{1}{2} g_{cd} g_{ef} \left[\frac{1}{2} (\delta_a^c \delta_b^e - \delta_a^e \delta_b^c) S^{df} + \frac{1}{2} (\delta_a^d \delta_b^f - \delta_a^f \delta_b^d) S^{ce} \right] \frac{DS^{ab}}{d\tau} \\ &= \frac{1}{2} \left[\frac{1}{2} (g_{ad} g_{bf} - g_{bd} g_{af}) S^{[df]} + \frac{1}{2} (g_{ca} g_{eb} - g_{cb} g_{ea}) S^{[ce]} \right] \frac{1}{2} P^{[a} u^{b]} \\ &= \frac{1}{2} \left[\frac{1}{2} (S_{ab} + S_{ab}) + \frac{1}{2} (S_{ab} + S_{ab}) \right] \frac{P^{[a} u^{b]}}{2} \\ &= S_{[ab]} \frac{P^{[a} u^{b]}}{2} = \frac{1}{2} S_{ab} P^a u^b = 0 \end{aligned}$$

since $S_{ab} u^b = 0$ □

The equations of motions are then

$$\boxed{\begin{aligned} \frac{DP^a}{d\tau} &= -\frac{1}{2} R^a{}_{ebc} u^e S^{bc} \\ \frac{DS^{ab}}{d\tau} &= \frac{1}{2} P^{[a} u^{b]} \end{aligned}}$$

[Hojman(1975)] uses a definition of anticommutators from quantum mechanics $[ab]_{Hoj} = 2[ab]$, and some ad hoc and non-constant modifications in $\delta\mathcal{L}$ ($\frac{1}{2}$ factor in front of his $\frac{\partial\mathcal{L}}{\partial\sigma^{ab}}\delta\sigma^{ab}$) that leads to $S_{Hoj}^{ab} \equiv 2S^{ab}$ and $u^{[a} P^{b]}_{Hoj} = 2u^{[a} P^{b]} = 4\sigma^{[a|c} S_c^{b]} = 2\sigma^{[a|c} S_{Hoj\ c}^{b]} = \sigma^{[a|c} S_{Hoj\ c}^{b]}_{Hoj}$ and would yield

$$\begin{aligned} \frac{DP^a}{d\tau} &= -\frac{1}{4} R^a{}_{ebc} u^e S_{Hoj}^{bc} \\ \frac{DS_{Hoj}^{ab}}{d\tau} &= S_{Hoj}^{[a|c} \sigma_c^{b]} = \frac{1}{2} S_{Hoj}^{[a|c} \sigma_c^{b]}_{Hoj} = \frac{1}{2} P^{[a} u^{b]}_{Hoj} = \frac{1}{2} (P^a u^b - P^b u^a) \end{aligned}$$

However he writes what we will take as a theorem and can be obtained by ad hoc redefinition of $u^a_{Hoj} = \frac{1}{2} u^a$

$$\begin{aligned} \frac{DP^a}{d\tau} &= -\frac{1}{2} R^a{}_{ebc} u^e_{Hoj} S_{Hoj}^{bc} \\ \frac{DS_{Hoj}^{ab}}{d\tau} &= P^a u^b_{Hoj} - P^b u^a_{Hoj} \end{aligned}$$

Dropping the *Hoj* index, it looks like the MPD equations found in [Papapetrou(1951)] in the form

$$\begin{aligned} \frac{D}{ds} \left(mu^a + \frac{DS^{ab}}{ds} u_b \right) &= -\frac{1}{2} R^a{}_{bcd} u^b S^{cd} \\ \frac{DS^{ab}}{ds} + u^a \frac{DS^{bc}}{ds} u_c - u^b \frac{DS^{ac}}{ds} u_c &= 0 \end{aligned}$$

if one defines

$$P^a = mu^a + \frac{DS^{ab}}{ds} u_b$$

These were not obtained from canonical formalism. Since S^{ab} antisymmetric, it preserves the Papapetrou definition of mass:

$$m = -u_a P^a = m - \frac{DS^{[ab]}}{ds} u_{(a} u_{b)} = m$$

which is however not satisfactory as it should be $M = \sqrt{-P^a P_a}$.

Now

$$\begin{aligned} P^a &= \frac{u^b u_b}{u^c u_c} P^a + \frac{u^a P^b u_b}{u^c u_c} - \frac{u^a P^b u_b}{u^c u_c} \\ &= \frac{(P^b u_b)}{u^c u_c} u^a + \frac{P^a u^b - P^b u^a}{u^c u_c} u_b \text{ and } P^a u^b - P^b u^a = \frac{DS^{ab}}{d\tau} \\ &= \frac{P^b u_b}{u^c u_c} u^a + \frac{DS^{ab}}{d\tau} \frac{u_b}{u^c u_c} \end{aligned}$$

Since $P^a u_a = -m$, choosing $u^c u_c = -1$ and $s = -\tau$, we get the Papapetrou form of P but with

$$P_a P^a = -M^2 = -m^2 - P_a \frac{DS^{ab}}{ds} u_b$$

Papapetrou's $\frac{DP}{d\tau}$ equation actually contains 3rd derivatives in s :

$$\frac{D}{ds} \left(\dots + \frac{DS^{ab}}{ds} u_b \right) \text{ while } S^{ab} = \frac{\partial \mathcal{L}}{\partial \frac{D\theta_{ab}}{ds}} \equiv \frac{D\theta^{ab}}{ds}$$

so it does not necessarily conserve spins

Hojman [Hojman(1975)] and Papapetrou [Papapetrou(1951)] don't agree because of the presence of S in $\frac{DP}{d\tau}$ but coincide in the limit of small spins using the same gauges and constraints as Hanson and Regge

For the special relativistic case, we add the choices

$$\begin{aligned} S^{ab} P_b &= 0 \\ e_{(0)}^a &= \frac{P^a}{M} \\ x^0 &= \tau \\ P^a P_a &= -M^2 = f \left(\frac{1}{2} S^{ab} S_{ab} \right), \end{aligned}$$

that is $\exists f, -M^2 = f(J^2)$: f is a Regge trajectory that allows to construct \mathcal{L}

Bibliography

- [Ellis *et al.*(2012)Ellis, Maartens, and MacCallum] G. F. R. Ellis, R. Maartens, and M. A. H. MacCallum, *Relativistic Cosmology* (Cambridge University Press, 2012, Cambridge, UK, 2012).
- [Carroll(2004)] S. Carroll, *Spacetime and Geometry* (Addison-Wesley Publishing Company, San Francisco, 2004).
- [Stephani(2004)] H. Stephani, *Relativity: An introduction to special and general relativity* (Cambridge University Press, 2012, Cambridge, UK, 2004).
- [Chandrasekhar(1985)] S. Chandrasekhar, *The mathematical theory of black holes* (Clarendon, Oxford, UK, 1985).
- [d’Inverno(1992)] R. d’Inverno, *Introducing Einstein’s Relativity* (Clarendon Press, Oxford, 1992).
- [Plebanski and Krasinski(2006)] J. Plebanski and A. Krasinski, *An introduction to general relativity and cosmology* (Univ. Pr., Cambridge, UK, 2006).
- [Wald(1984)] R. M. Wald, *General Relativity* (University of Chicago Press, 1984).
- [Hawking and Ellis(1973)] S. W. Hawking and G. F. R. Ellis, *The Large Scale Structure of Space-Time* (Cambridge University Press, Cambridge, 1973).
- [Misner *et al.*(1970)Misner, Thorne, and Wheeler] C. W. Misner, K. S. Thorne, and J. A. Wheeler, *Gravitation* (W. H. Freeman and Company, New York, 1970).
- [Weinberg(1972)] S. Weinberg, *Gravitation and Cosmology* (John Wiley & Sons, 1972).
- [Schwarzschild(1916)] K. Schwarzschild, *Sitzungsber. Preuss. Akad. Wiss. Berlin (Math. Phys.)* **1916**, 189 (1916), [arXiv:physics/9905030](https://arxiv.org/abs/physics/9905030) .
- [Eddington(1923)] A. S. Eddington, *The mathematical theory of relativity* (1923).

- [Birkhoff and Langer(1923)] G. D. Birkhoff and R. E. Langer, *Relativity and Modern Physics* (Harvard U. Press, Cambridge, MA, 1923).
- [Bona(1988)] C. Bona, *Journal of Mathematical Physics* **29** (1988).
- [Rosa and Piçarra(2020)] J. a. L. Rosa and P. Piçarra, *Phys. Rev. D* **102**, 6 (2020), [arXiv:2006.09854 \[gr-qc\]](#) .
- [Kerr(1963)] R. P. Kerr, *Phys. Rev. Lett.* **11**, 237 (1963).
- [Newman *et al.*(1965)] Newman, Couch, Chinnapared, Exton, Prakash, and Torrence] E. T. Newman, R. Couch, K. Chinnapared, A. Exton, A. Prakash, and R. Torrence, *J. Math. Phys.* **6**, 918 (1965).
- [Wald(1974)] R. M. Wald, *Ann. Phys. (NY)* **82**, 548 (1974).
- [Bekenstein(1973)] J. D. Bekenstein, *Phys. Rev. D* **7** (1973).
- [Stewart(1971)] J. M. Stewart, *Non-Equilibrium Relativistic Kinetic Theory*, Vol. 10 (1971).
- [Ashtekar *et al.*(2000)] Ashtekar, Fairhurst, and Krishnan] A. Ashtekar, S. Fairhurst, and B. Krishnan, *Phys. Rev. D* **62**, 104025 (2000), [arXiv:gr-qc/0005083](#) .
- [Isham(1999)] C. J. Isham, *Modern differential geometry for physicists* (World Scientific, Singapore, 1999).
- [Nakahara(2003)] M. Nakahara, *Geometry, topology, and physics*, 2nd ed., Graduate student series in physics (Institute of Physics Publishing, 2003).
- [Fecko, M.(2006)] Fecko, M., *Differential Geometry and Lie Groups for Physicists* (Cambridge University Press, 2006).
- [Frolov and Novikov(1998)] V. P. Frolov and I. D. Novikov, *Black Hole Physics: Basic Concepts and New Developments*, Fundamental Theories of Physics, Vol. 96 (Kluwer Academic Publishers, Dordrecht, 1998).
- [Bazanski(1989)] S. L. Bazanski, *J. Math. Phys.* **30**, 1018 (1989).
- [Mathisson(1937)] M. Mathisson, *Acta Phys. Polon.* **6**, 163 (1937).
- [Papapetrou(1951)] A. Papapetrou, *Proc. Roy. Soc. Lond. A* **209**, 248 (1951).
- [Dixon(1970)] W. G. Dixon, *Proc. Roy. Soc. Lond. A* **314**, 499 (1970).
- [Hojman(1975)] S. A. Hojman, *Electromagnetic and Gravitational Interactions of a Relativistic Spherical Top.*, Ph.D. thesis, Princeton University, New Jersey (1975).