

A CLASS OF SELF-AFFINE TILES IN \mathbb{R}^d THAT ARE d -DIMENSIONAL TAME BALLS

GUOTAI DENG

*School of Mathematics and Statistics & Hubei Key Laboratory of Mathematical Sciences,
Central China Normal University, Wuhan 430079, P.R. China*

CHUNTAI LIU

*School of Mathematics and Computer Science, Wuhan Polytechnic University, Wuhan
430023, P. R. China*

SZE-MAN NGAI

*Key Laboratory of High Performance Computing and Stochastic Information Processing
(HPCSIP) (Ministry of Education of China), College of Mathematics and Statistics,
Hunan Normal University, Changsha, Hunan 410081, P. R. China,
Department of Mathematical Sciences, Georgia Southern University Statesboro, GA
30460-8093, USA.*

ABSTRACT. We study a family of self-affine tiles in \mathbb{R}^d ($d \geq 2$) with noncollinear digit sets, which naturally generalizes a class studied originally by Deng and Lau in \mathbb{R}^2 and its extension to \mathbb{R}^3 by the authors. By using Brouwer's invariance of domain theorem, along with a tool which we call horizontal distance, we obtain necessary and sufficient conditions for the tiles to be d -dimensional tame balls. This answers positively the conjecture in an earlier paper by the authors stating that a member in a certain class of self-affine tiles is homeomorphic to a d -dimensional ball if and only if its interior is connected.

E-mail addresses: hilltower@163.com, lct984@163.com, smngai@georgiasouthern.edu .

2010 Mathematics Subject Classification. Primary 28A80, 52C22; Secondary 05B45, 51M20.

Key words and phrases. Self-affine tile, tame ball, ball-like tile, horizontal distance, Brouwer's invariance of domain theorem.

The first author is supported by the National Natural Science Foundation of China grant (12071171), Hubei Provincial Natural Science Foundation of China (2020CFB833), and Science Foundation of Jiangxi Education Department (GJJ202302). The second author is supported in part by the National Natural Science Foundation of China grant (11601403), and Hubei Provincial Natural Science Foundation of China (2019CFB602). The third author is supported in part by the National Natural Science Foundation of China grant (11771136), the Hunan Province' Hundred Talents Program, Construct Program of the Key Discipline in Hunan Province, and a Faculty Research Scholarly Pursuit Award from Georgia Southern University.

CONTENTS

1. Introduction	2
2. Notation and preliminaries	6
3. Construction of a quasi-hyperplane	9
4. A key homeomorphism on \mathbb{R}^d	21
5. Preparation for the construction	35
6. Proof of Theorem 5.1	43
7. Final comments	54
References	55

1. INTRODUCTION

Let $d \geq 1$ be an integer and A be a $d \times d$ expanding matrix (i.e., all of its eigenvalues are greater than 1 in modulus). It is well known that (see, e.g., [19, 26]) for any finite set $\mathcal{D} \subset \mathbb{R}^d$ there exists a unique nonempty compact set $T = T(A, \mathcal{D})$ such that

$$T = \bigcup_{d_i \in \mathcal{D}} A^{-1}(T + d_i).$$

The above set equation can be rewritten as $AT = T + \mathcal{D}$ and T can be expressed as

$$T = \left\{ \sum_{k \geq 1} A^{-k} d_{i_k} : d_{i_k} \in \mathcal{D} \right\}. \quad (1.1)$$

We call \mathcal{D} a *digit set*, (A, \mathcal{D}) a *self-affine pair*, and T a *self-affine set*. If $\#\mathcal{D} = |\det(A)|$ is an integer and the interior of T (denoted by T°) is nonempty, the set T actually tiles \mathbb{R}^d in the sense that there exists a discrete set $\mathcal{L} \subset \mathbb{R}^d$ which satisfies (i) $T + \mathcal{L} = \mathbb{R}^d$ and (ii) $(T^\circ + \iota_1) \cap (T^\circ + \iota_2) = \emptyset$ for all distinct $\iota_1, \iota_2 \in \mathcal{L}$. Such a T is called a *self-affine tile*.

The theory of self-affine tiles was established by Kenyon [22], Lagarias and Wang [26–28, 38] in the 1990s. In recent years, self-affine tiles play an important role in fractal geometry, wavelet theory and other fields. A basic central topic about self-affine sets is to study their topological properties and structure, including connectedness (see, e.g., [1, 18, 23, 24, 29, 30] and the references therein), and ball-likeness (see, e.g. [6, 9, 11, 12, 20, 29, 35] and the references therein). Here a set $E \subset \mathbb{R}^d$ is said to be *ball-like* if it is homeomorphic to a d -dimensional unit ball. If $d = 2$, a ball-like set is also called a *disk-like set*. All the balls mentioned in this paper are closed.

When the integral expanding matrix $A \in \mathbb{R}^{d \times d}$ is given, the structure of the digit set strongly affects the topological properties of the self-affine set T . Hata [17] obtained an important tool to study the connectedness of more general self-similar sets. By using a

graph structure on \mathcal{D} , Kirat and Lau [23] developed the following criterion for the connectedness of self-affine tiles generated by collinear digit sets: If $\mathcal{D} = \{0, v, \dots, |(\det A) - 1|v\}$ and the characteristic polynomial of A is height reducing, then $T = T(A, \mathcal{D})$ is connected (see also [24]). As it is easy to describe all quadratic polynomials by this method, Kirat and Lau proved the connectedness of a class of tiles in \mathbb{R}^2 .

Akiyama and Gjini [1] extended Kirat-Lau's conclusion to the case of $d = 3, 4$ by using the Schur-Cohn criterion. They confirmed that all characteristic polynomials are height reducing when $d \leq 4$. For $d > 4$, He *et al.* [18] described an algorithm to determine whether a polynomial is height reducing. This method is not applicable if the digit set is nonconsecutive or noncollinear. A lot of research has focused on collinear digit sets or more special consecutive digit sets (see [18, 23, 32]). One of the reasons is that this case involves canonical number systems. It is a widely studied basic case (for canonical number systems and tiles see [16, 21, 25]; for some progress on the topology of the tiles, see [2, 3]). Another reason is that in most cases, the connectedness can be revealed only by consecutive digits. If, on the other hand, a "scattered" digit set is used, it is easy to find a disconnected sub-block, making it more difficult to study the topological structure of the tile.

In 2011, Deng and Lau [13] initiated the study of self-affine tiles with noncollinear digit sets, and obtained the following result concerning connectedness.

Theorem 1.1. (Deng-Lau [13]) *Let $p, q \in \mathbb{Z}$ with $|p|, |q| \geq 2$, $a \in \mathbb{R}$, and $b_i \in \mathbb{R}$, $i \in \{0, 1, \dots, |p| - 1\}$. Let*

$$A = \begin{pmatrix} p & 0 \\ -a & q \end{pmatrix}, \mathcal{D} = \{(i, j + b_i) : 0 \leq i \leq |p| - 1, 0 \leq j \leq |q| - 1\}. \quad (1.2)$$

Then the self-affine set $T = T(A, \mathcal{D})$ is a tile, and it is connected if and only if

$$\left| \frac{b_{i+1} - b_i}{q} + \frac{\text{sign}(p)(b_0 - b_{|p|-1}) - a}{q(q - \text{sign}(p))} \right| \leq 1, \text{ for all } i, \quad (1.3)$$

where $\text{sign}(x) = -1, 0$ or 1 according to $x < 0, x = 0$ or $x > 0$.

Leung and Luo [31] showed the connectedness of the self-affine set T in the case $\mathcal{D} = \{0, \mathbf{v}, \pm A\mathbf{v}\}$ ($\mathbf{v}, A\mathbf{v}$ are linearly independent), under the condition that $|\det A| = 3$. The result in [13] has been extended by Liu *et al.* [33] to the digit set $\mathcal{D} = \mathbb{Z}_m \times \mathbb{Z}_n$. Moreover, various other extensions in \mathbb{R}^2 have been obtained by a number of authors (see [34, 36]).

In the two-dimensional case, the topological structure of tiles has been studied extensively, and disk-like tiles have been identified in many cases. Due to the existence of Alexander's horned balls in \mathbb{R}^3 , it is very difficult to verify whether a specific three-dimensional self-affine tile is ball-like. So, when $d \geq 3$, the topology of self-affine tiles is very complex and little is known. In studying higher-dimensional tiles, Gelbrich [15] first proposed a part of the following question, which appeared recently in [4, 10].

Question 1.2. *Can a self-affine tile (or its boundary) in \mathbb{R}^d become a manifold in a nontrivial way, and is there a method to identify whether a self-affine tile (or its boundary) can be a manifold?*

We recall the definitions of tame ball and wild ball. Suppose a set $E \subset \mathbb{R}^d$ is homeomorphic to a d -dimensional unit ball. If the homeomorphism can be extended to \mathbb{R}^d , E is called a *tame ball*; otherwise E is called a *wild ball*. In 2015, Kamae, Luo and Tan [20] used Barnsley's theory of attractors with condensation [7] to construct a class of d -dimensional self-affine tiles $T = T(A, \mathcal{D})$ that are tame balls; here $A := 3\text{diag}(1, \dots, 1) \in \mathbb{R}^{d \times d}$,

$$\mathcal{D} := \left\{ \left(i_1, \dots, i_n + t \left(1 - \sum_{j=1}^{n-1} i_j^2 \right) \right) : i_j \in \{-1, 0, 1\}, 1 \leq j \leq n \right\},$$

and $t \in (-3, 3)$. In 2016, Conner and Thuswaldner [9] proposed an algebraic method to determine whether a given three dimensional self-affine tile is a tame ball, by using geometric topology tools developed by Cannon and Edwards. They confirmed that several known three-dimensional self-affine tiles [5, 15] are ball-like. They also constructed a self-affine tile in \mathbb{R}^3 that is not a topological manifold (its boundary is a two-dimensional wild sphere). Their method makes use of the representation of a class of algebraic geometric complexes with recursive structure (which allowed arbitrary precision calculations). These complexes were used to approximate self-affine tiles, and then determine the homeomorphism type of the boundary with the help of computer. In 2020, Thuswaldner and Zhang [37] considered the boundary problem of self-affine tiles. Under the assumption that the digit set is consecutive, they constructed a class of self-affine tiles each of whose boundary is a two-dimensional sphere.

In [11], authors of the present paper studied Question 1.2 and extended some results in [13] to \mathbb{R}^3 . By assuming that A is a special lower triangle matrix, they constructed a family of ball-like self-affine tiles. The main technique is to restructure a self-affine tile by a cut-and-paste process, which allows one to construct a homeomorphism from T to a ball in \mathbb{R}^3 . The following is a part of the main result in [11].

Theorem 1.3. (Deng-Liu-Ngai [11]) *Let (A, \mathcal{D}) be given as follows:*

$$A = \begin{pmatrix} p & 0 & 0 \\ 0 & q & 0 \\ -t & -s & r \end{pmatrix} \quad \text{and} \quad \mathcal{D} = \left\{ (i, j, k) : \begin{array}{l} 0 \leq i < |p|, \\ 0 \leq j < |q|, 0 \leq k < |r| \end{array} \right\}, \quad (1.4)$$

where p, q, r are integers not less than 2 in absolute value and s, t are real numbers. If $st \geq 0$, then $T = T(A, \mathcal{D})$ is homeomorphic to a ball if and only if $|s + t| < |r(r - 1)|$.

By assuming that A is an upper triangular matrix, authors of the present paper further extended some of the results in [11] to \mathbb{R}^d for $d \geq 2$ [12]. By constructing homotopy

mappings, they obtained a necessary and sufficient condition for T to be contractible (to a single point) and hence T° is simply connected.

Theorem 1.4. (Deng-Liu-Ngai [12]) *For $d \geq 2$, let p_1, \dots, p_d be integers with $|p_i| \geq 2$ for $1 \leq i \leq d$. Let A_1 be the diagonal matrix $\text{diag}(p_1, \dots, p_{d-1})$ and $\mathbf{s} = (s_1, \dots, s_{d-1}) \in \mathbb{R}^{d-1}$. Suppose the self-affine pair (A, \mathcal{D}) satisfies*

$$A = \begin{pmatrix} A_1 & -\mathbf{s} \\ 0 & p_d \end{pmatrix}, \quad \mathcal{D} = \{(i_1, \dots, i_d) : 0 \leq i_j < |p_j|, 1 \leq j \leq d\}. \quad (1.5)$$

Then T is a self-affine tile and the following statements are equivalent.

(1) *T is connected if and only if*

$$\max_{1 \leq j \leq d-1} \left\{ \left| \frac{s_j}{p_j(p_j - \text{sign}(p_d))} \right| \right\} \leq 1. \quad (1.6)$$

(2) *T° is connected if and only if the inequality in (1.6) is strict. Moreover, if T° is connected then T° is contractible to a single point.*

Although T is contractible, one cannot deduce that T is homeomorphic to a d -dimensional ball. The following is conjectured in [12].

Conjecture 1.5. *Assume the same hypotheses of Theorem 1.4. Then T is homeomorphic to a d -dimension ball if and only if T° is connected.*

The main purpose of this paper is to give a positive answer to Conjecture 1.5. We use a purely analytic approach to show that the connectedness of T° implies that T is a d -dimensional tame ball. The following is our main result.

Theorem 1.6. *For $d \geq 2$, let (A, \mathcal{D}) be given as in (1.5), and let $T = T(A, \mathcal{D})$ be the corresponding self-affine tile. Then the following statements are equivalent.*

- (1) *T° is connected;*
- (2) *T is a d -dimensional tame ball;*
- (3) *the following inequality holds*

$$\max_{1 \leq j \leq d-1} \left\{ \left| \frac{s_j}{p_j(p_j - \text{sign}(p_d))} \right| \right\} < 1.$$

In fact, in Section 5, we will prove a generalized version of Theorem 1.6 by using more general digit sets (see Theorem 5.1).

As the proof of (3) \Rightarrow (2) in Theorem 1.6 is long and complicated, we outline the main steps here, using the concrete example in Figure 1 as an aid. We begin with a d -dimensional slant prism (see Figure 1(a)) that is the union of convex combinations of the top surface and the bottom surface of the self-affine tile T (for the definition of such a convex combination of sets, see (3.3)). Then we define five homeomorphisms on \mathbb{R}^d that transform \mathbb{R}^d and the original prism successively. The first is an affine transformation (see

Figure 1(a)–(b)) that sets the slant prism vertical. We then use three transformations: squeeze (see Figure 1(b)–(c)), translation (see Figure 1(c)–(d)), and flattening (see Figure 1(d)–(e)), to turn the d -dimensional vertical prism to a union of smaller d -dimensional vertical prisms. The fifth homeomorphism is another affine transformation (see Figure 1(e)–(f1)/f(2)) that moves the top surface so that it coincides with the top surface of the original d -dimensional slant prism. We call this process an *iteration*. For each of these smaller d -dimensional slant prisms, we perform a similar iteration to get several even smaller d -dimensional slant prisms, keeping the top and bottom surfaces unchanged. By applying this iteration repeatedly (see Figure 2(a)–(e)), we can define a mapping h on \mathbb{R}^d that sends the original d -dimensional slant prism to the self-affine tile T . We remark that Figure 2(e) shows a close approximation to the tile. Finally, we use Brouwer’s invariance of domain theorem [8] to show that h is a desired homeomorphism on \mathbb{R}^d .

Theorem 1.7 (Brouwer [8]). *Let $V \subset \mathbb{R}^d$ be an open set and h a mapping on V . If h is injective and continuous, then h is a homeomorphism from V onto $h(V)$.*

The continuity and surjectivity of h can be obtained quite easily (Lemma 6.1), but it is difficult to prove the injectivity (Lemma 6.4). To this end, we investigate some analytic properties of each iteration (Proposition 4.9) and obtain: (1) the height of a point (i.e., the last coordinate in \mathbb{R}^d) that is not in the vertical boundary of the original d -dimensional slant prism will be fixed after finitely many iterations, and (2) under some mild condition, the absolute value of the height difference of two points that are in the interior of the vertical boundary of the original d -dimensional slant prism will not drop. These conclusions, together with a tool which we call *horizontal distance*, imply the injectivity of the mapping h .

The rest of this paper is organized as follows. We introduce some notation and concepts in Section 2, and describe the construction of a quasi-hypersurface in Section 3. In Section 4, we prove some analytic properties of one iteration, which lead up to Proposition 4.9. Section 5 consists of preparations for constructing the mapping h that sends the self-affine tile to a tame ball. The proof that h is the desired homeomorphism is given in Section 6. Finally, in Section 7, we state some comments on Theorem 1.3, which is partly proved in [11].

2. NOTATION AND PRELIMINARIES

2.1. Symbolic space. For an integer $m \geq 2$, denote $\Sigma_m^k := \{0, 1, \dots, m-1\}^k$, $\Sigma_m^* := \cup_{k \geq 0} \Sigma_m^k$ and $\Sigma_m^{\mathbb{N}} := \{0, 1, \dots, m-1\}^{\mathbb{N}}$, where $\Sigma_m^0 := \{\emptyset\}$ (\emptyset stands for the *empty word*).

We call $\mathbf{i} \in \Sigma_m^k$ a *word* of length k , and denote its length by $|\mathbf{i}|$. For $\mathbf{i} = i_1 \cdots i_k \in \Sigma_m^k$ and $\mathbf{j} = j_1 j_2 \cdots \in \Sigma_m^* \cup \Sigma_m^{\mathbb{N}}$, let $\mathbf{ij} = i_1 \cdots i_k j_1 j_2 \cdots$. For $\mathbf{i} \in \Sigma_m^*$, we denote the infinite word $\mathbf{ii} \cdots$ by $\bar{\mathbf{i}}$.

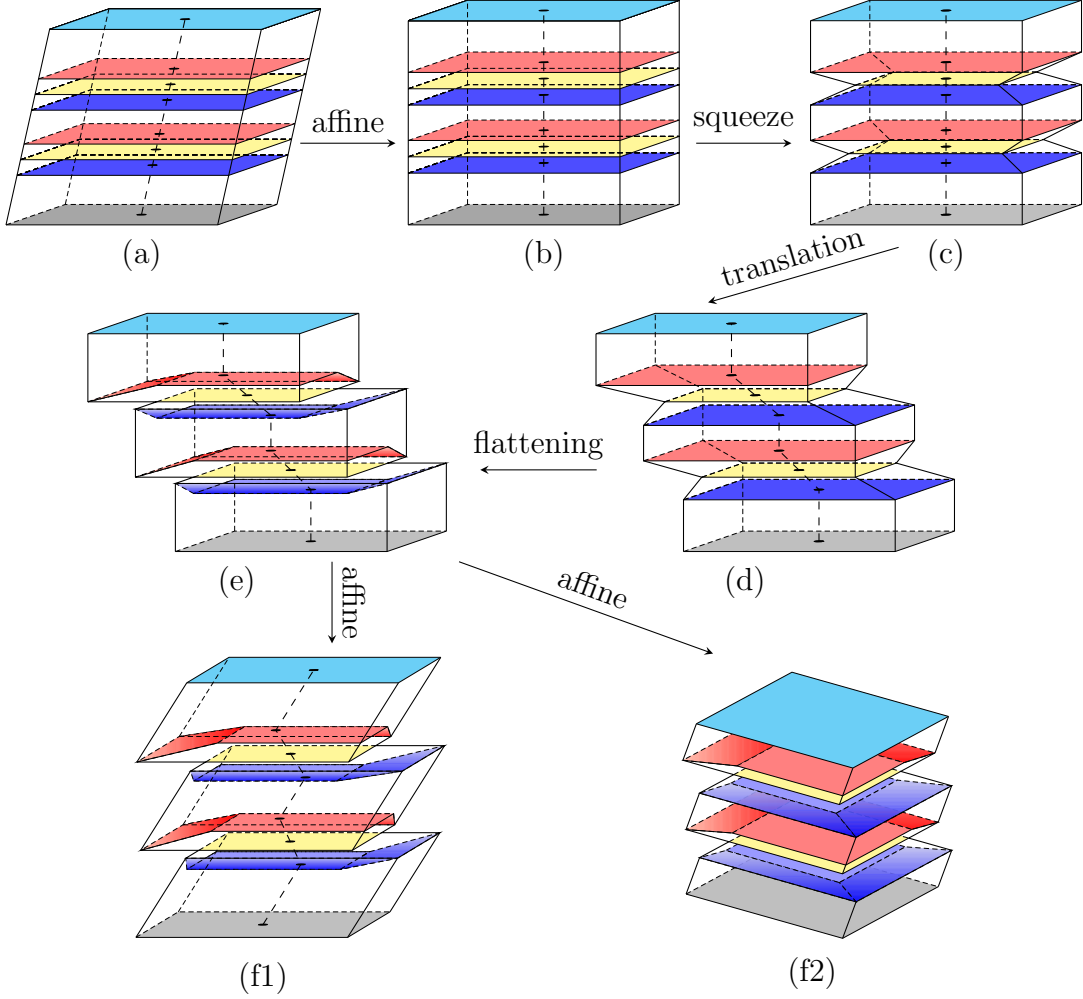

FIGURE 1. Five homeomorphisms on a slant prism, from (a) to (f1) and (f2). Figures (f1) and (f2) show the same set, with different viewpoints and with auxiliary dashed line segments in (f1). This figure is drawn with $p_1 = p_2 = p_3 = 3$, $\mathbf{s} = (2, 1.8)$ and $\mathcal{D} = \{(i_1 + a_k^1, i_2 + a_k^2, k) : i_1, i_2, k = 0, 1, 2\}$, where $(a_0^1, a_0^2) = (0, 0)$, $(a_1^1, a_1^2) = (-0.55, -0.45)$, and $(a_2^1, a_2^2) = (-1.25, -1.05)$.

It is well known that the map $\varphi_m : \Sigma_m^{\mathbb{N}} \rightarrow [0, 1]$ defined as

$$\varphi_m(\mathbf{i}) := \sum_{n \geq 1} \frac{i_n}{m^n}, \quad \mathbf{i} = i_1 i_2 \cdots,$$

is surjective. We also define $\varphi_m(\mathbf{i}) := \sum_{n=1}^{|\mathbf{i}|} m^{-n} i_n$ for $\mathbf{i} \in \Sigma_m^*$.

2.2. Some notation in \mathbb{R}^d . For $\mathbf{x} \in \mathbb{R}^d$, we denote the j th component of \mathbf{x} , $1 \leq j \leq d$, by x_j or $\omega_j(\mathbf{x})$. For $E \subset \mathbb{R}^d$, denote $\omega_j(E) = \{\omega_j(\mathbf{x}) : \mathbf{x} \in E\}$. We let $\mathbf{1}_d := (1, \dots, 1) \in \mathbb{R}^d$ be the vector whose components are all 1.

For $\mathbf{x} \in \mathbb{R}^d$ and $y \in \mathbb{R}$, let

$$y + \mathbf{x} := (y + \omega_1(\mathbf{x}), \dots, y + \omega_d(\mathbf{x})), \quad y\mathbf{x} := (y\omega_1(\mathbf{x}), \dots, y\omega_d(\mathbf{x})),$$

$$\|\mathbf{x}\|_{\infty} := \max\{|\omega_j(\mathbf{x})| : 1 \leq j \leq d\}.$$

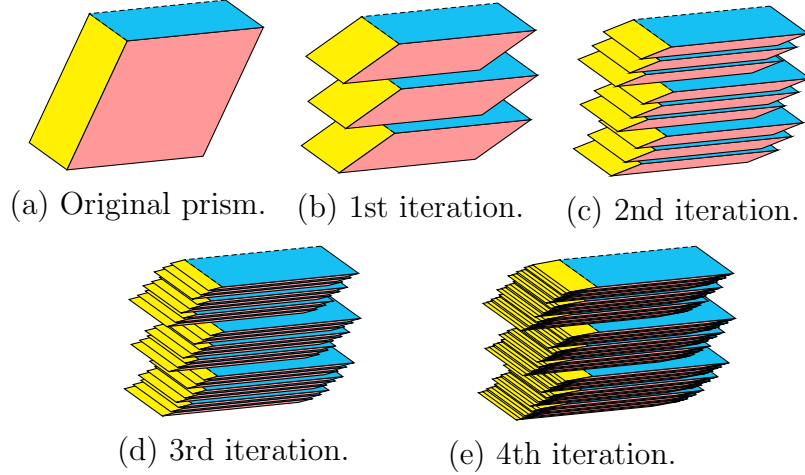

FIGURE 2. First few iterations on a slant prism in \mathbb{R}^3 . The figures are drawn by using the data from Figure 1, but with a different viewpoint. The figure in (e) is intended to show a close approximation to the tile.

We say that $\{\mathbf{x}_m\}_{m \geq 1}$ is $o(1)$, denoted $\mathbf{x}_m = o(1)$, if $\lim_{m \rightarrow \infty} \|\mathbf{x}_m\|_\infty = 0$. For two vectors $\mathbf{x}, \mathbf{y} \in \mathbb{R}^d$, we write $\mathbf{x} \leq \mathbf{y}$ or $\mathbf{y} \geq \mathbf{x}$ if $\omega_j(\mathbf{x}) \leq \omega_j(\mathbf{y})$ for all j and write $\mathbf{x} < \mathbf{y}$ or $\mathbf{y} > \mathbf{x}$ if $\omega_j(\mathbf{x}) < \omega_j(\mathbf{y})$ for all j .

Define a new multiplication on \mathbb{R}^d as follows

$$\mathbf{x} \square \mathbf{y} := (x_1 y_1, \dots, x_d y_d). \quad (2.1)$$

We also write $\mathbf{x} \square \mathbf{y}$ as $\mathbf{x}\mathbf{y}$ for short. For convenience, we let $\mathbf{x} \square E = \mathbf{x}E = \{\mathbf{x} \square \mathbf{y} : \mathbf{y} \in E\}$ for $\mathbf{x} \in \mathbb{R}^d$ and $E \subset \mathbb{R}^d$. Recall $\text{sign}(x) := 0, 1$, or -1 according to $x = 0, x > 0$ or $x < 0$. Let $\text{sign}(\mathbf{x})$ stand for the vector

$$(\text{sign}(\omega_1(\mathbf{x})), \dots, \text{sign}(\omega_d(\mathbf{x}))),$$

and let $\mathbf{x}^\oplus := \text{sign}(\mathbf{x})\mathbf{x} = (|x_1|, \dots, |x_d|)$. For two sets $E, F \subset \mathbb{R}^d$, define the *sum* of E and F as

$$E + F := \{e + f : e \in E, f \in F\}.$$

If $F = \{f\}$, a singleton, then we also write $E + F$ simply as $E + f$. For a set $E \subset \mathbb{R}^d$, let $-E = \{-\mathbf{x} : \mathbf{x} \in E\}$ and let E° (or $\text{int } E$), E^c , and ∂E denote the interior, complement, and boundary of E respectively.

We point out that the notation and definitions introduced on \mathbb{R}^d ($d \geq 2$) are applicable to sets and vectors in \mathbb{R}^{d-1} . However, if the ambient space \mathbb{R}^d is fixed, the following two concepts are defined only for vectors in \mathbb{R}^d . For $\mathbf{x} \in \mathbb{R}^d$ ($d \geq 2$), we call $\mathcal{P}_h(\mathbf{x}) = (\omega_1(\mathbf{x}), \dots, \omega_{d-1}(\mathbf{x}))$ the *horizontal coordinates* of \mathbf{x} and $\mathcal{P}_v(\mathbf{x}) = \omega_d(\mathbf{x})$ the *vertical coordinate* of \mathbf{x} . We also call $\mathcal{P}_v(\mathbf{x})$ the *height* of \mathbf{x} .

2.3. Other notation. Let $r \geq 2$ be an integer and $b > 0$ be a constant. For an integer k satisfying $0 \leq k \leq r$, denote

$$y_k := kb \cdot r^{-1}. \quad (2.2)$$

Clearly, $y_0 = 0$ and $y_r = b$. For $0 < k < r$, let $\mathbf{u}_k \in 2U^\circ := (-1, 1)^{d-1}$ be fixed. In Section 5, we will define \mathbf{u}_k that have specific geometric meaning in the self-affine tile; we refer the reader to (5.14). Let \mathbf{v}_0 stand for the origin in \mathbb{R}^{d-1} and let $\mathbf{v}_k := \mathbf{u}_1 + \cdots + \mathbf{u}_k$ for $k \geq 1$.

We choose $\varepsilon \in \mathbb{R}$ small enough such that

$$0 < \varepsilon < (2r)^{-1}b. \quad (2.3)$$

For $1 \leq k < r$, let $I_{\varepsilon,k} = [y_k - \varepsilon, y_k + \varepsilon]$ and $I_\varepsilon = \bigcup_{k=1}^{r-1} I_{\varepsilon,k}$. Let $\mathbf{x}(y)$ and $\boldsymbol{\rho}(y)$ be vector-valued functions defined as

$$\mathbf{x}(y) := \begin{cases} \mathbf{v}_k, & y \in [y_k, y_{k+1}] \setminus I_\varepsilon, 0 \leq k < r; \\ (2\varepsilon)^{-1}(\varepsilon + y - y_k)\mathbf{u}_k + \mathbf{v}_{k-1}, & y \in I_{\varepsilon,k}, 1 \leq k < r, \end{cases} \quad (2.4)$$

$$\boldsymbol{\rho}(y) := \begin{cases} \mathbf{1}_{d-1}, & y \notin I_\varepsilon; \\ \varepsilon^{-1}|y - y_k|\mathbf{u}_k^\oplus + 1 - \mathbf{u}_k^\oplus, & y \in I_{\varepsilon,k}, 1 \leq k < r. \end{cases} \quad (2.5)$$

In particular, $\boldsymbol{\rho}(y_k) = 1 - \mathbf{u}_k^\oplus$ and $\mathbf{x}(y_k) = 2^{-1}\mathbf{u}_k + \mathbf{v}_{k-1}$. For the geometric significance of $\mathbf{x}(y)$ and $\boldsymbol{\rho}(y)$, see Figure 11 and Lemma 4.4. Finally, we define a constant c corresponding to $\{\mathbf{u}_k\}$ as

$$c = c(\{\mathbf{u}_k\}) := \sum_{k=1}^{r-1} \|\mathbf{u}_k\|_\infty. \quad (2.6)$$

3. CONSTRUCTION OF A QUASI-HYPERPLANE

The structure of the tile allows us to construct a homeomorphism from a d -dimensional prism onto a union of some smaller d -dimensional prisms (see Figure 1(b)–(e)). However, if we want to extend the domain of such a homeomorphism to the whole space \mathbb{R}^d , we need to slice \mathbb{R}^d in such a way that the flattening map (see Figure 1(d)–(e)), which is well-defined on the prism, can be extended to \mathbb{R}^d . To achieve this, it is necessary to construct non-trivial quasi-hyperplanes to slice \mathbb{R}^d in a desired way, and this is the main objective of this section.

3.1. Some notation on U . We assume $\mathbf{u} \in (-1, 1)^{d-1}$ and denote $u_j := \omega_j(\mathbf{u})$. We always assume the index j is in $\{1, 2, \dots, d-1\}$ and $\mathbf{u} \neq (0, \dots, 0) \in \mathbb{R}^{d-1}$ unless stated otherwise.

Recall that $U = [-1/2, 1/2]^{d-1}$ and ∂U denotes its boundary, i.e., $\partial U = \{\mathbf{x} \in U : \omega_j(\mathbf{x}) = \pm 2^{-1} \text{ for some } j\}$. With respect to the given vector \mathbf{u} , the boundary of U can be divided into three parts, not necessarily disjoint, as follows:

$$\partial U = \partial U^+ \cup \partial U^- \cup \partial U^\dagger, \quad (3.1)$$

where

$$\partial U^+ = \partial U_{\mathbf{u}}^+ := \{\mathbf{x} \in \partial U : 2\omega_j(\mathbf{x}) = \text{sign}(\omega_j(\mathbf{u})) \neq 0 \text{ for some } j\},$$

$$\partial U^- = \partial U_{\mathbf{u}}^- := -\partial U^+,$$

$$\partial U^\dagger = \partial U_{\mathbf{u}}^\dagger := \{\mathbf{x} \in \partial U : 2\omega_j(\mathbf{x}) = \pm 1 \text{ and } \omega_j(\mathbf{u}) = 0 \text{ for some } j\},$$

The set ∂U^\dagger is empty if none of the components of \mathbf{u} is zero. To explain our idea more clearly, we present the following example.

Example 3.1. Let $I := [-1/2, 1/2]$.

(1) If $d = 4$ and $\mathbf{u} = (-0.1, 0.2, 0)$, then (see Figure 3(a,b,c))

$$\partial U^+ = \left(\left\{ -\frac{1}{2} \right\} \times I^2 \right) \cup \left(I \times \left\{ \frac{1}{2} \right\} \times I \right),$$

$$\partial U^- = \left(\left\{ \frac{1}{2} \right\} \times I^2 \right) \cup \left(I \times \left\{ -\frac{1}{2} \right\} \times I \right),$$

$$\partial U^\dagger = I^2 \times \left\{ -\frac{1}{2}, \frac{1}{2} \right\}.$$

(2) If $d = 4$, $\mathbf{u} = (0.1, -0.2, -0.3)$, then $\partial U^\dagger = \emptyset$ and (see Figure 3(d,e))

$$\partial U^+ = \left(\left\{ \frac{1}{2} \right\} \times I^2 \right) \cup \left(I \times \left\{ -\frac{1}{2} \right\} \times I \right) \cup \left(I^2 \times \left\{ -\frac{1}{2} \right\} \right),$$

$$\partial U^- = \left(\left\{ -\frac{1}{2} \right\} \times I^2 \right) \cup \left(I \times \left\{ \frac{1}{2} \right\} \times I \right) \cup \left(I^2 \times \left\{ \frac{1}{2} \right\} \right).$$

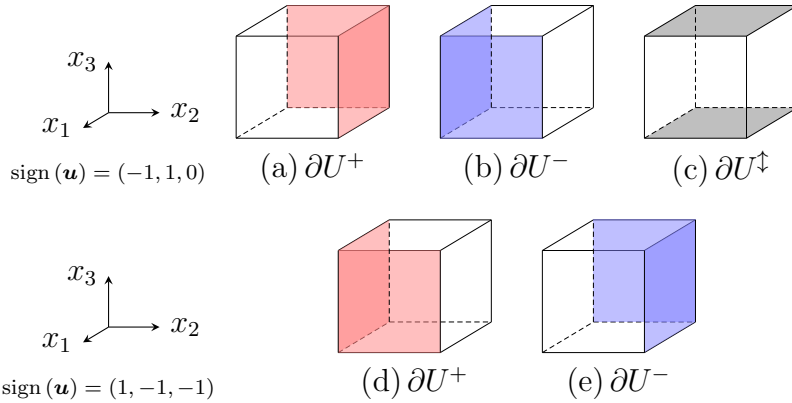

FIGURE 3. Illustration of the decomposition of ∂U with respect to the vector \mathbf{u} . The surfaces colored red, blue, and black are the sets ∂U^+ , ∂U^- , and ∂U^\dagger respectively.

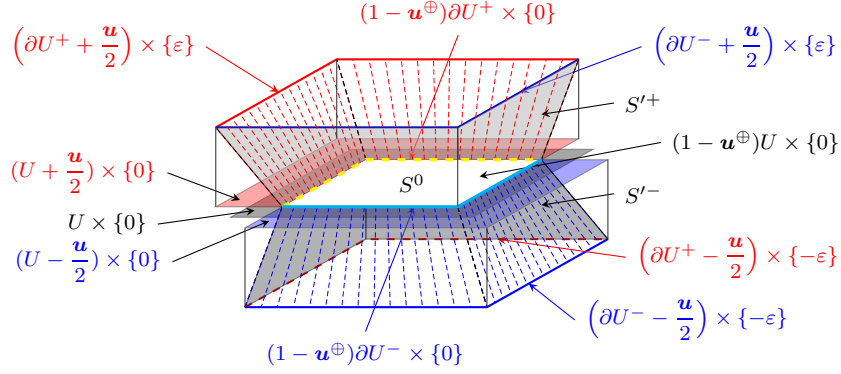

FIGURE 4. An illustration of S^0, S^+, S^-, S'^+ and S'^- . This figure is drawn with $d = 3$ and $\mathbf{u} = (-0.3, -0.25)$.

3.2. Construction of quasi-hyperplane. We continue to use the assumptions and notation in Section 3.1. Recall that $\mathbf{x}E = \{\mathbf{x}\mathbf{y} : \mathbf{y} \in E\}$ for $\mathbf{x} \in \mathbb{R}^n$ and $E \subset \mathbb{R}^n$, where $n = d - 1$ or $n = d$. Let $\varepsilon > 0$ be small enough. Denote $S^0 := ((1 - \mathbf{u}^\oplus)U) \times \{0\}$. Let

$$\hat{\mathbf{u}}_t := (1 - t)(1 - \mathbf{u}^\oplus) + t \times \mathbf{1}_{d-1} = t\mathbf{u}^\oplus + 1 - \mathbf{u}^\oplus, \quad 0 \leq t \leq 1.$$

$\hat{\mathbf{u}}_t$ is the convex combination of the vectors $1 - \mathbf{u}^\oplus$ and $\mathbf{1}_{d-1}$ with parameter t ; it specifies the amount of contraction in each of the $d - 1$ directions, in the range determined by \mathbf{u} and $\mathbf{1}_{d-1}$. Define

$$\begin{aligned} S^+ = S_{\mathbf{u}}^+ &:= \bigcup_{0 \leq t \leq 1} \left(\hat{\mathbf{u}}_t \partial U^+ + \frac{t}{2} \mathbf{u} \right) \times \{t\varepsilon\}, \\ S'^+ = S_{\mathbf{u}}'^+ &:= \bigcup_{0 \leq t \leq 1} \left(\hat{\mathbf{u}}_t (\partial U^- \cup \partial U^\dagger) + \frac{t}{2} \mathbf{u} \right) \times \{t\varepsilon\}. \end{aligned} \quad (3.2)$$

We can use the notion of convex combination to describe these sets. For $E \subset \mathbb{R}^{d-1}$, $\mathbf{x}_1, \mathbf{x}_2, \mathbf{t}_1, \mathbf{t}_2 \in \mathbb{R}^{d-1}$, and $y_1, y_2 \in \mathbb{R}$, the *convex combination* of two sets $(\mathbf{t}_1 E + \mathbf{x}_1) \times \{y_1\}$ and $(\mathbf{t}_2 E + \mathbf{x}_2) \times \{y_2\}$ with respect to the combination coefficient t is defined to be the set

$$\left\{ ((1 - t)(\mathbf{t}_1 \mathbf{x} + \mathbf{x}_1) + t(\mathbf{t}_2 \mathbf{x} + \mathbf{x}_2), (1 - t)y_1 + ty_2) : \mathbf{x} \in E \right\}. \quad (3.3)$$

Now S^+ can be described as the union of the convex combinations of

$$((1 - \mathbf{u}^\oplus) \partial U^+) \times \{0\} \quad \text{and} \quad \left(\partial U^+ + \frac{\mathbf{u}}{2} \right) \times \{\varepsilon\},$$

while S'^+ is that of

$$((1 - \mathbf{u}^\oplus) (\partial U^- \cup \partial U^\dagger)) \times \{0\} \quad \text{and} \quad \left(\partial U^- \cup \partial U^\dagger + \frac{\mathbf{u}}{2} \right) \times \{\varepsilon\}.$$

See Figure 4 for an illustration. We also point out that if we let

$$\pi(y) := \mathbb{R}^{d-1} \times \{y\}, \quad y \in \mathbb{R},$$

then S'^+ is perpendicular to the hyperplane $\pi(0)$, i.e., any normal vector of S'^+ is parallel to $\pi(0)$. Let $S^- := -S^+$ and $S'^- := -S'^+$.

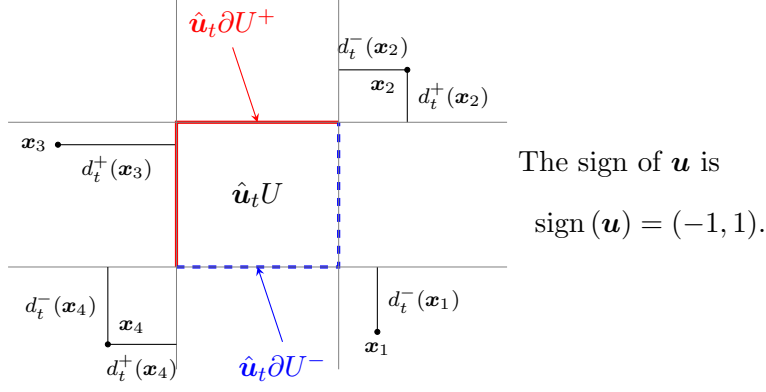

FIGURE 5. Illustration of d_t^+ and d_t^- . The union of the thick lines (in red) stands for $\hat{\mathbf{u}}_t \partial U^+$, while the union of the dashed lines (in blue) stands for $\hat{\mathbf{u}}_t \partial U^-$. This figure is drawn with $\mathbf{u} = (-0.5, 0.6)$ and $t = 0.3$.

Next we will extend the surface $S^0 \cup S^+ \cup S^-$ to a $(d-1)$ -dimensional quasi-hyperplane $S_{\mathbf{u}}$. As the extension is nontrivial and needs some fine structure, we introduce some additional notation. For $\mathbf{x} \in \mathbb{R}^{d-1}$, let

$$\ell_{\mathbf{x}} := \{\mathbf{x}\} \times \mathbb{R}. \quad (3.4)$$

Next, we introduce some concepts on the difference of components with respect to the given vector \mathbf{u} , which will make the extension easier. For $0 \leq t \leq 1$, define two pseudo-distances between a point $\mathbf{x} \notin \hat{\mathbf{u}}_t U^\circ$ and the set $\hat{\mathbf{u}}_t U$ as follows:

$$d_t^+(\mathbf{x}) := \max \left\{ |x_j| - \frac{1}{2} \omega_j(\hat{\mathbf{u}}_t) : x_j u_j > 0, |x_j| \geq \frac{1}{2} \omega_j(\hat{\mathbf{u}}_t), j = 1, \dots, d-1 \right\},$$

$$d_t^-(\mathbf{x}) := \max \left\{ |x_j| - \frac{1}{2} \omega_j(\hat{\mathbf{u}}_t) : x_j u_j \leq 0, |x_j| \geq \frac{1}{2} \omega_j(\hat{\mathbf{u}}_t), j = 1, \dots, d-1 \right\},$$

where the maximum of an empty set is defined to be $-\infty$. We will explain the geometric meanings of d_t^+ and d_t^- following Lemma 3.4, or more precisely, following Equation (3.9). We now present an example to illustrate these definitions.

Example 3.2. Assume $d = 3$, $\mathbf{u} = (-0.5, 0.6)$ and $t = 0.3$. Then

$$\hat{\mathbf{u}}_t = (1 - 0.3)(1 - (0.5, 0.6)) + 0.3(1, 1) = (0.65, 0.58).$$

For $\mathbf{x}_1 = (0.48, -0.55)$, $\mathbf{x}_2 = (0.6, 0.5)$, $\mathbf{x}_3 = (-0.8, 0.2)$, $\mathbf{x}_4 = (-0.6, -0.6)$, we have (see Figure 5)

$$d_t^+(\mathbf{x}_1) = -\infty, \quad d_t^-(\mathbf{x}_1) = |\omega_2(\mathbf{x}_1)| - \frac{1}{2} \omega_2(\hat{\mathbf{u}}_t) = 0.55 - 0.29 = 0.26,$$

$$d_t^+(\mathbf{x}_2) = \omega_2(\mathbf{x}_2) - \frac{1}{2} \omega_2(\hat{\mathbf{u}}_t) = 0.21, \quad d_t^-(\mathbf{x}_2) = |\omega_1(\mathbf{x}_2)| - \frac{1}{2} \omega_1(\hat{\mathbf{u}}_t) = 0.275,$$

$$d_t^+(\mathbf{x}_3) = |\omega_1(\mathbf{x}_3)| - \frac{1}{2} \omega_1(\hat{\mathbf{u}}_t) = 0.475, \quad d_t^-(\mathbf{x}_3) = -\infty,$$

$$d_t^+(\mathbf{x}_4) = 0.275, \quad d_t^-(\mathbf{x}_4) = 0.31.$$

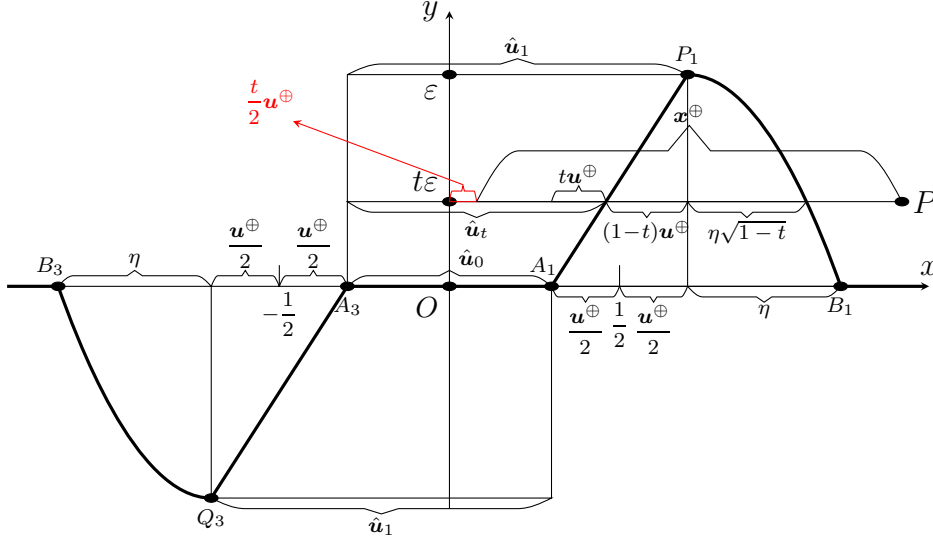

FIGURE 6. An illustration of $\eta\sqrt{1-t}$ and $\hat{\mathbf{u}}_t$ for some fixed $\mathbf{x} \in \mathbb{R}^{d-1}$. The thick piecewise curve stands for the quasi-hyperplane $S_{\mathbf{u}}$. The line segment A_1P_1 , the line segment A_3Q_3 , the curve $A_1P_1B_1$, and the curve $A_3Q_3B_3$ represent S^+ , S^- , $S^{'+}$, and $S^{'-}$, respectively. The horizontal coordinate of P is $\mathbf{x} + \frac{t}{2}\mathbf{u}$, which is used in the proof of Lemma 3.4.

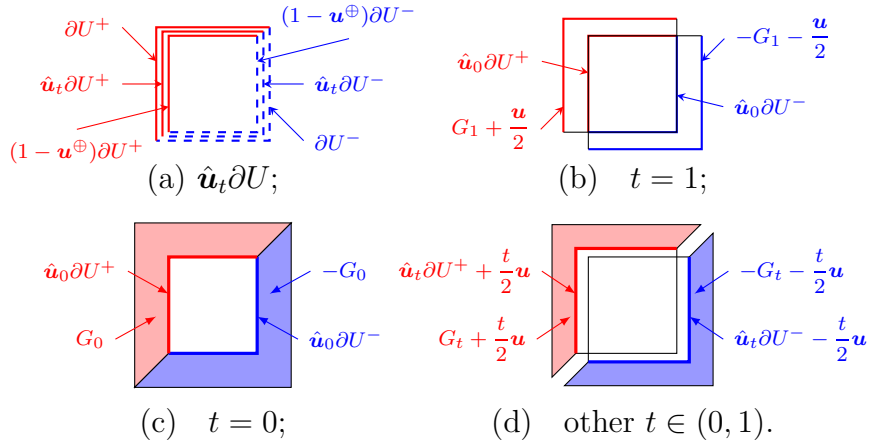

FIGURE 7. An illustration of ∂U^+ , ∂U^- and $G_t, -G_t$ with none of the components of \mathbf{u} being zero. This figure is drawn with $\mathbf{u} = (-0.22, 0.15)$.

Recall that for two vector $\mathbf{x}, \mathbf{y} \in \mathbb{R}^{d-1}$, $\mathbf{x} \leq \mathbf{y}$ (resp. $\mathbf{x} < \mathbf{y}$) means

$$\omega_j(\mathbf{x}) \leq \omega_j(\mathbf{y}) \quad (\text{resp. } \omega_j(\mathbf{x}) < \omega_j(\mathbf{y})), \quad 1 \leq j \leq d-1.$$

Also, $U^\circ = U \setminus \partial U = \{\mathbf{x} \in U : -2^{-1}\mathbf{1}_{d-1} < \mathbf{x} < 2^{-1}\mathbf{1}\}$. According to the size of the quantities d_t^+ and d_t^- , we define the following subset of \mathbb{R}^{d-1} :

$$G_t = \{\mathbf{x} \in \mathbb{R}^{d-1} : \hat{\mathbf{u}}_t \leq 2\mathbf{x}^\oplus \leq 2\eta\sqrt{1-t} + 1 + (1-t)\mathbf{u}^\oplus, d_t^+(\mathbf{x}) \geq d_t^-(\mathbf{x})\}, \quad (3.5)$$

where $\eta \in (\|\mathbf{u}\|_\infty, 1)$ is some constant. We note that $G_1 = \partial G_1 = \partial U^+$. See Figure 6 for an illustration of $\eta\sqrt{1-t}$ and $\hat{\mathbf{u}}_t$ and see Figures 7, 8 and 9 for an illustration of G_t .

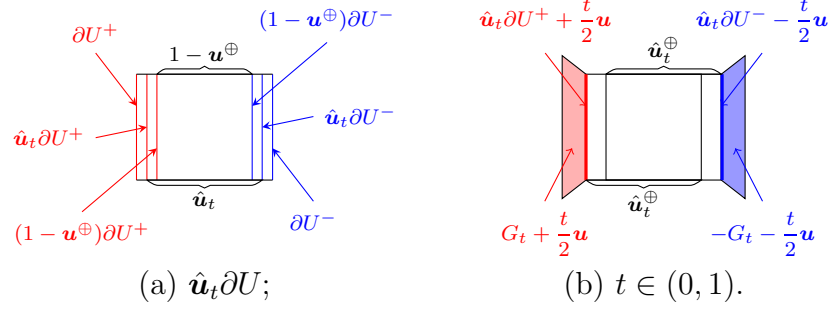

FIGURE 8. An illustration of ∂U^+ , ∂U^- , G_t and $-G_t$ with some component of \mathbf{u} being zero. This figure is drawn with $\mathbf{u} = (-0.3, 0)$.

Set	Property
$W = \{(\mathbf{x}, 0) : \mathbf{x} \notin \mathcal{P}_h(S''^+ \cup S''^-)\}$	contains S^0 and is the set of all points in S with height zero
$S''^+ = \bigcup_{0 \leq t \leq 1} \left(\partial G_t + \frac{t}{2} \mathbf{u} \right) \times \{t\varepsilon\}$	containing S^+
$S''^- = -S''^+$	a reflection of S''^+ about the origin
$G_t = \{ \mathbf{x} : \hat{\mathbf{u}}_t \leq 2\mathbf{x}^\oplus \leq 2\eta\sqrt{1-t} + 1 + (1-t)\mathbf{u}^\oplus, d_t^+(\mathbf{x}) \geq d_t^-(\mathbf{x}) \}$	$d_h(\mathbf{x}, \hat{\mathbf{u}}_t \partial U^+) \geq d_h(\mathbf{x}, \hat{\mathbf{u}}_t (\partial U^- \cup \partial U^\dagger))$, if we ignore the components of \mathbf{x} and \mathbf{u} with different signs on the left side of this inequality, and only consider the components of \mathbf{x} and \mathbf{u} with different signs on the right side
$S^0 = (1 - \mathbf{u}^\oplus)U \times \{0\}$	a shrunk $(d-1)$ -dimensional hypercube in $\pi(0)$
$S^+ = \bigcup_{0 \leq t \leq 1} \left(\hat{\mathbf{u}}_t \partial U^+ + \frac{t}{2} \mathbf{u} \right) \times \{t\varepsilon\}$	a convex combination of $((1 - \mathbf{u}^\oplus) \partial U^+) \times \{0\}$ and $(\partial U^+ + 2^{-1} \mathbf{u}) \times \{\varepsilon\}$
$S^- = -S^+$	a reflection of S^+ about the origin

TABLE 1. Some properties of the sets related to $S = W \cup S''^+ \cup S''^-$, an extension of $S^0 \cup S^+ \cup S^-$.

Let

$$S''^+ := \bigcup_{0 \leq t \leq 1} \left(\partial G_t + \frac{t}{2} \mathbf{u} \right) \times \{t\varepsilon\} \quad \text{and} \quad S''^- := -S''^+.$$

(see Figure 9) and let $W := \{(\mathbf{x}, 0) : \mathbf{x} \notin \mathcal{P}_h(S''^+ \cup S''^-)\}$. We now define the *quasi-hyperplane determined by \mathbf{u}* , denoted $S_{\mathbf{u}}$, as

$$S_{\mathbf{u}} := \begin{cases} \pi(0), & \mathbf{u} = (0, \dots, 0) \in \mathbb{R}^{d-1}, \\ W \cup S''^+ \cup S''^-, & \mathbf{u} \in (-1, 1)^{d-1} \setminus \{(0, \dots, 0)\}. \end{cases} \quad (3.6)$$

3.3. Some lemmas. We now introduce a tool d_h called *horizontal distance* in \mathbb{R}^d , which helps us get some useful analytic properties of $S_{\mathbf{u}}$ (Lemmas 3.3 and 3.6) and plays a key

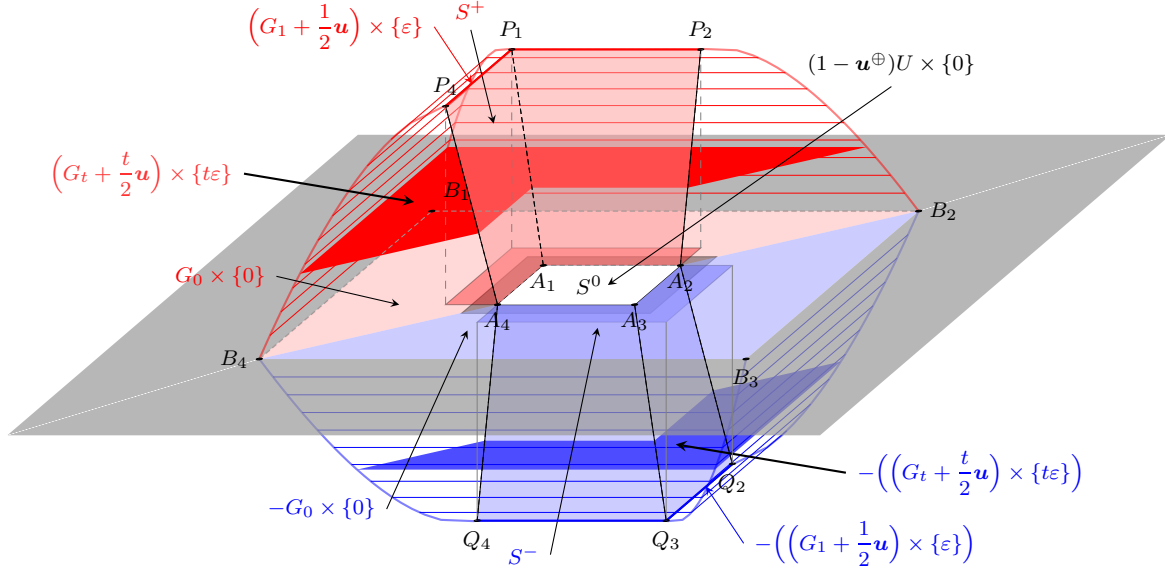

- S^+ is the union of the trapezoids $A_1A_2P_2P_1$ and $A_1A_4P_4P_1$;
- S^- is the union of the trapezoids $A_2A_3Q_3Q_2$ and $A_3A_4Q_4Q_3$;
- G_0 is the polygon $A_4A_1A_2B_2B_1B_4$; $-G_0$ is the polygon $A_4A_3A_2B_2B_3B_4$;
- $G_t + \frac{t}{2}\mathbf{u}$ is the section in red lying above S^0 ;
- $-G_t - \frac{t}{2}\mathbf{u}$ is the section in blue lying below S^0 ;
- $S^{'+}$ is the union of S^+ and the four surfaces $A_4B_4P_4$, $B_1B_4P_4P_1$, $B_1B_2P_2P_1$, $A_2B_2P_2$;
- $S^{-'}$ is the union of S^- and the four surfaces $A_4B_4Q_4$, $B_3B_4Q_4Q_3$, $B_2B_3Q_3Q_2$, $A_2B_2Q_2$.

FIGURE 9. An illustration of S^0 , S^+ , S^- , $S^{'+}$ and $S^{-'}$. This figure is drawn with $d = 3$ and $\mathbf{u} = (-0.3, -0.3)$.

role in the proof of Theorem 1.6. The horizontal distance d_h between two points P and P' is defined as

$$d_h(P, P') := \begin{cases} \|\mathcal{P}_h(P) - \mathcal{P}_h(P')\|_\infty, & \mathcal{P}_v(P) = \mathcal{P}_v(P'); \\ +\infty, & \text{otherwise.} \end{cases} \quad (3.7)$$

For convenience, we let $d_h(\mathbf{x}, \mathbf{x}') := \|\mathbf{x} - \mathbf{x}'\|_\infty$ if $\mathbf{x}, \mathbf{x}' \in \mathbb{R}^{d-1}$. For $P \in \mathbb{R}^d$ and $E \subset \mathbb{R}^d$, let

$$d_h(P, E) := \inf\{d_h(P, Q) : Q \in E\}.$$

Clearly,

$$d_h(P, E) = d_h(P, E|_{\pi(\mathcal{P}_v(P))}),$$

where $E|_{\pi(y)}$ stands for the restriction of E on $\pi(y)$, i.e.,

$$E|_{\pi(y)} := \{P \in E : \mathcal{P}_v(P) = y\}.$$

We point out that d_h is not a metric on \mathbb{R}^d , since the triangle inequality may fail. Nevertheless, the following limit property holds. We omit the proof.

Lemma 3.3. *Let $\{P_n\}, \{Q_n\} \subset \mathbb{R}^d$ be two convergent sequences in the sense of the norm $\|\cdot\|_\infty$. If for each $n \geq 1$, P_n and Q_n have the same height, then*

$$\lim_{n \rightarrow +\infty} d_h(P_n, Q_n) = d_h\left(\lim_{n \rightarrow +\infty} P_n, \lim_{n \rightarrow +\infty} Q_n\right).$$

For $\mathbf{x} \in \mathbb{R}^d$ satisfying $2\mathbf{x}^\oplus \geq \hat{\mathbf{u}}_t$, we divide the index set $\{j : |2x_j| \geq \omega_j(\hat{\mathbf{u}}_t)\}$ into three parts as follows.

$$\begin{aligned} \Lambda_1 &:= \{j : x_j u_j > 0, 2|x_j| \geq \omega_j(\hat{\mathbf{u}}_t)\}, \\ \Lambda_2 &:= \{j : x_j u_j < 0, 2|x_j| \geq \omega_j(\hat{\mathbf{u}}_t)\}, \\ \Lambda_3 &:= \{j : 2|x_j| \geq \omega_j(\hat{\mathbf{u}}_t) = 1, u_j = 0\}. \end{aligned} \tag{3.8}$$

So, we can rewrite the pseudo-distances $d_t^+(\mathbf{x})$ and $d_t^-(\mathbf{x})$ as

$$\begin{aligned} d_t^+(\mathbf{x}) &:= \max \left\{ |x_j| - \frac{1}{2} \omega_j(\hat{\mathbf{u}}_t) : j \in \Lambda_1 \right\}; \\ d_t^-(\mathbf{x}) &:= \max \left\{ |x_j| - \frac{1}{2} \omega_j(\hat{\mathbf{u}}_t) : j \in \Lambda_2 \cup \Lambda_3 \right\}. \end{aligned} \tag{3.9}$$

These new expressions in fact give the geometric meanings of d_t^+ and d_t^- . Roughly speaking, $d_t^+(\mathbf{x})$ is the horizontal distance between \mathbf{x} and $\hat{\mathbf{u}}_t \partial U^+$ if we ignore all components of \mathbf{x} and \mathbf{u} that have different signs, while $d_t^-(\mathbf{x})$ is the horizontal distance between \mathbf{x} and $\hat{\mathbf{u}}_t(\partial U^+ \cup \partial U^\dagger)$ if we only consider the components of \mathbf{x} and \mathbf{u} that have different signs. This fact will be applied to the proofs of Lemmas 3.4 and 3.6, which will be used to estimate the horizontal distances of prisms and points in the next section.

Lemma 3.4. *Let $t \in [0, 1)$. Suppose $P = \left(\mathbf{x} + \frac{t}{2}\mathbf{u}, t\varepsilon\right)$ with $2\mathbf{x}^\oplus \geq \hat{\mathbf{u}}_t$.*

(1) *If P lies below $S_{\mathbf{u}}$, then*

$$d_h\left(\mathbf{x}, U - \frac{1+t}{2}\mathbf{u}\right) \geq d_h(\mathbf{x}, \hat{\mathbf{u}}_t \partial U).$$

(2) *If P lies above $S_{\mathbf{u}}$ or $P \in S_{\mathbf{u}}$, then*

$$d_h\left(\mathbf{x}, U + \frac{1-t}{2}\mathbf{u}\right) \geq (1 - \|\mathbf{u}\|_\infty)^{1/\eta} d_h(\mathbf{x}, \hat{\mathbf{u}}_t \partial U).$$

To prove Lemma 3.4, we need the following lemma.

Lemma 3.5. *Suppose $0 < \delta < 1$ and $x \geq \eta$. Then for $t \in [0, 1]$, we have*

$$x\sqrt{1-t} \geq (1-\delta)^{1/\eta} (x\sqrt{1-t} + (1-t)\delta).$$

Proof. Note that $\eta \in (0, 1)$. By the mean-value theorem, there exists some $\xi \in (0, \delta)$ such that

$$\frac{1 - (1-\delta)^{1/\eta}}{\delta} \times \frac{1}{(1-\delta)^{1/\eta}} = \frac{1}{\eta} (1-\xi)^{1/\eta-1} \frac{1}{(1-\delta)^{1/\eta}} > \frac{1}{\eta}.$$

Hence,

$$x\sqrt{1-t} \geq \eta\sqrt{1-t} \geq \frac{(1-\delta)^{1/\eta}\delta\sqrt{1-t}}{1-(1-\delta)^{1/\eta}} \geq \frac{(1-\delta)^{1/\eta}\delta(1-t)}{1-(1-\delta)^{1/\eta}}.$$

This implies the conclusion. \square

Proof of Lemma 3.4. When $\mathbf{u} = (0, \dots, 0)$, we know that $\hat{\mathbf{u}}_t = \mathbf{1}_{d-1}$ and hence

$$d_h\left(\mathbf{x}, U - \frac{1+t}{2}\mathbf{u}\right) = d_h\left(\mathbf{x}, U + \frac{1-t}{2}\mathbf{u}\right) = d_h(\mathbf{x}, \hat{\mathbf{u}}_t\partial U),$$

provided $2\mathbf{x}^\oplus \geq \hat{\mathbf{u}}_t U$. Thus, conclusions (1) and (2) are true.

Next, we assume $\mathbf{u} \neq (0, \dots, 0)$.

(1) Assume P lies below $S_{\mathbf{u}}$. Then $\mathbf{x} \in \text{int } G_t$, which implies that $d_t^+(\mathbf{x}) > d_t^-(\mathbf{x})$, namely,

$$\max_{j \in \Lambda_1} \left\{ |x_j| - \frac{1}{2}\omega_j(\hat{\mathbf{u}}_t) \right\} > \max_{j \in \Lambda_2 \cup \Lambda_3} \left\{ |x_j| - \frac{1}{2}\omega_j(\hat{\mathbf{u}}_t) \right\}.$$

So, by setting $x'_j = \omega_j(\mathbf{x}')$, we have

$$\begin{aligned} d_h(\mathbf{x}, \hat{\mathbf{u}}_t\partial U) &= \min\{\|\mathbf{x} - \mathbf{x}'\|_\infty : \mathbf{x}' \in \hat{\mathbf{u}}_t\partial U\} \\ &= \min\left\{ \max\{|x_j - x'_j| : j \in \Lambda_1 \cup \Lambda_2 \cup \Lambda_3\} : \mathbf{x}' \in \hat{\mathbf{u}}_t\partial U \right\} \\ &= \max\left\{ |x_j| - \frac{1}{2}\omega_j(\hat{\mathbf{u}}_t) : j \in \Lambda_1 \cup \Lambda_2 \cup \Lambda_3 \right\} \\ &= \max\left\{ |x_j| - \frac{1}{2}\omega_j(\hat{\mathbf{u}}_t) : j \in \Lambda_1 \right\} = d_t^+(\mathbf{x}), \end{aligned}$$

where $\Lambda_1, \Lambda_2, \Lambda_3$ are given as in (3.8). Recall that $\omega_j(\hat{\mathbf{u}}_t) = t|u_j| + 1 - |u_j|$. Without loss of generality, we assume

$$u_1 > 0 \quad \text{and} \quad d_t^+(\mathbf{x}) = x_1 - \frac{1}{2}\omega_1(\hat{\mathbf{u}}_t) = x_1 - \frac{tu_1 + 1 - u_1}{2}. \quad (3.10)$$

On the other hand,

$$d_h\left(\mathbf{x}, U - \frac{1+t}{2}\mathbf{u}\right) \geq x_1 - \left(\frac{1}{2} - \frac{1+t}{2}u_1\right) = x_1 - \frac{-tu_1 + 1 - u_1}{2} \geq d_t^+(\mathbf{x}).$$

So the conclusion is true in this case.

(2) Assume P lies on or above $S_{\mathbf{u}}$. When $d_t^+(\mathbf{x}) > d_t^-(\mathbf{x})$, we also get $d_h(\mathbf{x}, \hat{\mathbf{u}}_t U) = d_t^+(\mathbf{x})$. Again we suppose that assumption (3.10) holds. Since P lies on or above $S_{\mathbf{u}}$, we know $\mathbf{x} \notin (2\eta\sqrt{1-t} + 1 + (1-t)\mathbf{u}^\oplus)U^\circ$ by the definition of $S_{\mathbf{u}}$, which implies that (see Figure 6 for the location of P)

$$d_t^+(\mathbf{x}) \geq \eta\sqrt{1-t} + (1-t)u_1.$$

Notice that

$$\begin{aligned} d_h\left(\mathbf{x}, U + \frac{1-t}{2}\mathbf{u}\right) &\geq x_1 - \left(\frac{1}{2} + \frac{1-t}{2}u_1\right) \\ &= d_t^+(\mathbf{x}) - (1-t)u_1 \geq \eta\sqrt{1-t}. \end{aligned}$$

Applying Lemma 3.5 for $x = (\sqrt{1-t})^{-1}d_h(\mathbf{x}, U + 2^{-1}(1-t)\mathbf{u})$ and $\delta = u_1$, we have

$$\begin{aligned} x\sqrt{1-t} &= d_h\left(\mathbf{x}, U + \frac{1-t}{2}\mathbf{u}\right) \\ &\geq (1-u_1)^{1/\eta}\left(d_h\left(\mathbf{x}, U + \frac{1-t}{2}\mathbf{u}\right) + (1-t)u_1\right) \\ &\geq (1-\|\mathbf{u}\|_\infty)^{1/\eta}d_t^+(\mathbf{x}) \\ &= (1-\|\mathbf{u}\|_\infty)^{1/\eta}d_h(\mathbf{x}, \hat{\mathbf{u}}_t\partial U). \end{aligned}$$

When $d_t^+(\mathbf{x}) \leq d_t^-(\mathbf{x})$, we know $d_h(\mathbf{x}, \hat{\mathbf{u}}_t\partial U) = d_t^-(\mathbf{x})$. Without loss of generality, we assume $u_1 \leq 0$ and

$$d_t^-(\mathbf{x}) = x_1 - \frac{1}{2}\omega_1(\hat{\mathbf{u}}_t) = x_1 - \frac{-tu_1 + 1 + u_1}{2}.$$

Then

$$d_h\left(\mathbf{x}, U + \frac{1-t}{2}\mathbf{u}\right) \geq x_1 - \left(\frac{1}{2} + \frac{(1-t)u_1}{2}\right) = d_t^-(\mathbf{x}).$$

So the conclusion also holds in this case since $(1-\|\mathbf{u}\|_\infty)^{1/\eta} \leq 1$. \square

Lemma 3.6. *The following assertions concerning $S_{\mathbf{u}}$ hold.*

- (1) For each $\mathbf{x} \in \mathbb{R}^{d-1}$, the set $S_{\mathbf{u}} \cap \ell_{\mathbf{x}}$ contains exactly one element and

$$\mathcal{P}_h(S^+ \cup S^- \cup S^0) = (U + 2^{-1}\mathbf{u}) \bigcup (U - 2^{-1}\mathbf{u}).$$

- (2) The height of $P \in S_{\mathbf{u}}$ is zero if $\mathcal{P}_h(P) \in (1+2\eta+\mathbf{u}^\oplus)U^c$ or $\mathcal{P}_h(P) \in (1-\|\mathbf{u}\|_\infty)U$, where $U^c = \mathbb{R}^{d-1} \setminus U$.

- (3) Let $P = (\mathbf{x}, y) \in S_{\mathbf{u}}$, where $\mathbf{x} \in \partial U + 2^{-1}\mathbf{u}$ such that

$$\text{either } \omega_j(2\mathbf{x} - \mathbf{u}) = \pm 1 \quad \text{or} \quad |\omega_j(2\mathbf{x} - \mathbf{u})| < 1 - 2\|\mathbf{u}\|_\infty. \quad (3.11)$$

Then

$$y = \begin{cases} \varepsilon, & \mathbf{x} \in \partial U^+ + 2^{-1}\mathbf{u}, \\ 0, & \mathbf{x} \in (\partial U^- \cup \partial U^\dagger + 2^{-1}\mathbf{u}) \setminus (\partial U^+ + 2^{-1}\mathbf{u}). \end{cases}$$

- (4) Let $P = (\mathbf{x}, y) \in S_{\mathbf{u}}$, where $\mathbf{x} \in \partial U - 2^{-1}\mathbf{u}$ such that

$$\text{either } \omega_j(2\mathbf{x} + \mathbf{u}) = \pm 1 \quad \text{or} \quad |\omega_j(2\mathbf{x} + \mathbf{u})| < 1 - 2\|\mathbf{u}\|_\infty.$$

Then

$$y = \begin{cases} -\varepsilon, & \mathbf{x} \in \partial U^- - 2^{-1}\mathbf{u}, \\ 0, & \mathbf{x} \in (\partial U^+ \cup \partial U^\dagger - 2^{-1}\mathbf{u}) \setminus (\partial U^- - 2^{-1}\mathbf{u}). \end{cases}$$

Proof. We first consider the case $\mathbf{u} = (0, \dots, 0)$. We have $S^+ = S^- = \emptyset$ and $S^0 = U \times \{0\}$. So, $S_{\mathbf{u}} \cap \ell_{\mathbf{x}} = \{(\mathbf{x}, 0)\}$ and $\mathcal{P}_h(S^0) = U$, which implies conclusion (1). Conclusion (2) is obvious since each point in $S_{\mathbf{u}}$ has height zero. Note that $\partial U^+ + 2^{-1}\mathbf{u} = \partial U^- - 2^{-1}\mathbf{u} = \emptyset$ and $\partial U^\dagger + 2^{-1}\mathbf{u} = \partial U$. Now conclusions (3) and (4) become: If $P = (\mathbf{x}, y) \in S_{\mathbf{u}}$ with $\mathbf{x} \in \partial U$, then $y = 0$ when $\mathbf{x} \in \partial U^\dagger$. This is obvious since $P = (\mathbf{x}, y) \in S_{\mathbf{u}}$ implies that $y = 0$. Now, we assume $\mathbf{u} \neq (0, \dots, 0)$.

(1) For a given vector $\mathbf{x} \in \mathbb{R}^{d-1}$, we denote $\mathbf{x}' = \mathbf{x} + 2^{-1}(t - t')\mathbf{u}$, where $t, t' \in [0, 1]$ satisfy $t > t'$. We begin the proof with the following claim.

Claim. (i) If $\mathbf{x} \in \hat{\mathbf{u}}_t(U^c \cup \partial U^+)$, then $\mathbf{x}' \notin \hat{\mathbf{u}}_{t'}U$. (ii) If $\mathbf{x} \in (2\eta\sqrt{1-t} + 1 + (1-t)\mathbf{u}^\oplus)U$, then $\mathbf{x}' \in (2\eta\sqrt{1-t'} + 1 + (1-t')\mathbf{u}^\oplus)U^\circ$. (iii) If $d_t^+(\mathbf{x}) \geq d_t^-(\mathbf{x})$, then $d_{t'}^+(\mathbf{x}') > d_{t'}^-(\mathbf{x}')$.

Proof of the claim. When $\mathbf{x} \in \hat{\mathbf{u}}_t\partial U^+$, there exists an index j such that $x_j u_j > 0$ and $|x_j| = 2^{-1}(t|u_j| + 1 - |u_j|)$. Without loss of generality, we assume $j = 1$ and $u_1 > 0$. Then

$$x'_1 = x_1 + \frac{t-t'}{2}u_1 = \frac{1}{2}(tu_1 + 1 - u_1) + \frac{t-t'}{2}u_1 = \frac{1}{2}(t'u_1 + 1 - u_1) + (t-t')u_1,$$

which implies $\mathbf{x}' \notin \hat{\mathbf{u}}_{t'}U$. When $\mathbf{x} \notin \hat{\mathbf{u}}_tU$, there exists an index j such that $|2x_j| > t|u_j| + 1 - |u_j|$. So,

$$\begin{aligned} |2x'_j| &= |2x_j + (t-t')u_j| \geq |2x_j| - (t-t')|u_j| \\ &> t|u_j| + 1 - |u_j| - (t-t')|u_j| = t'|u_j| + 1 - |u_j|, \end{aligned}$$

which again implies $\mathbf{x}' \notin \hat{\mathbf{u}}_{t'}U$, and thus (i) holds.

From the fact that $\eta > \|\mathbf{u}\|_\infty$, we have

$$\begin{aligned} &2\eta\sqrt{1-t} + (1-t)\mathbf{u}^\oplus + (t-t')\|\mathbf{u}\|_\infty \\ &= 2\eta\sqrt{1-t'} + 2\eta\frac{t-t}{\sqrt{1-t} + \sqrt{1-t'}} + (1-t)\mathbf{u}^\oplus + (t-t')\|\mathbf{u}\|_\infty \\ &\leq 2\eta\sqrt{1-t'} + (1-t')\mathbf{u}^\oplus + (\|\mathbf{u}\|_\infty - \eta)(t-t') \\ &< 2\eta\sqrt{1-t'} + (1-t')\mathbf{u}^\oplus, \end{aligned}$$

which implies

$$(2\eta\sqrt{1-t} + 1 + (1-t)\mathbf{u}^\oplus)U + \frac{t-t'}{2}\mathbf{u} \subset (2\eta\sqrt{1-t'} + 1 + (1-t')\mathbf{u}^\oplus)U^\circ. \quad (3.12)$$

Thus, (ii) holds.

As for (iii), we let $\Lambda_1, \Lambda_2, \Lambda_3$ be given as in (3.8). Since $\mathbf{x} \notin \hat{\mathbf{u}}_tU$, not all sets $\Lambda_1, \Lambda_2, \Lambda_3$ are empty. The assumption $d_t^+(\mathbf{x}) \geq d_t^-(\mathbf{x})$ implies $\Lambda_1 \neq \emptyset$ by (3.9). Without loss of generality, we assume

$$u_1 > 0 \quad \text{and} \quad d_t^+(\mathbf{x}) = x_1 - \frac{1}{2}\omega_1(\hat{\mathbf{u}}_t) = x_1 - \frac{tu_1 + 1 - u_1}{2}.$$

Then

$$\begin{aligned} d_{t'}^+(\mathbf{x}') &\geq \left(x_1 + \frac{t-t'}{2}u_1\right) - \frac{1}{2}(t'u_1 + 1 - u_1) \\ &= x_1 - \frac{1}{2}(tu_1 + 1 - u_1) + (t-t')u_1 > d_t^+(\mathbf{x}). \end{aligned} \quad (3.13)$$

Note that

$$d_t^-(\mathbf{x}) = \max \left\{ |x_j| - \frac{1}{2}\omega_j(\hat{\mathbf{u}}_t) : j \in \Lambda_2 \cup \Lambda_3 \right\}.$$

When $j \in \Lambda_2$ (in this case, $x_j u_j < 0$),

$$\begin{aligned} & \left| x_j + \frac{t-t'}{2} u_j \right| - \frac{1}{2} (t'|u_j| + 1 - |u_j|) \\ &= |x_j| - \frac{t-t'}{2} |u_j| - \frac{1}{2} (t'|u_j| + 1 - |u_j|) \\ &= |x_j| - \frac{1}{2} (t|u_j| + 1 - |u_j|), \end{aligned}$$

where the first equality holds because $2|x_j| \geq t|u_j| + 1 - |u_j|$ and

$$t|u_j| + 1 - |u_j| - (t-t')|u_j| = t'|u_j| + 1 - |u_j| > 0.$$

When $j \in \Lambda_3$ (in this case, $u_j = 0$),

$$\left| x_j + \frac{t-t'}{2} u_j \right| - \frac{1}{2} (t'|u_j| + 1 - |u_j|) = |x_j| - \frac{1}{2} (t|u_j| + 1 - |u_j|)$$

So, for $j \in \Lambda_2 \cup \Lambda_3$, we have $|x'_j| - \frac{1}{2} \omega_j(\hat{\mathbf{u}}_{t'}) = |x_j| - \frac{1}{2} \omega_j(\hat{\mathbf{u}}_t)$, which implies

$$d_t^-(\mathbf{x}) = d_{t'}^-(\mathbf{x}').$$

Hence, (iii) holds by (3.13), which completes the proof of the claim.

From the expression of G_t (see (3.5)), we get

$$\partial G_t = E_1 \cup E_2 \cup E_3,$$

$$\text{int } G_{t'} = \{\mathbf{x} \in \mathbb{R}^{d-1} : d_{t'}^+(\mathbf{x}) > d_t^-(\mathbf{x}), \hat{\mathbf{u}}_{t'} < 2\mathbf{x}^\oplus < 2\eta\sqrt{1-t'} + 1 + (1-t')\mathbf{u}^\oplus\},$$

where

$$E_1 := \{\mathbf{x} \in \hat{\mathbf{u}}_t \partial U : d_t^+(\mathbf{x}) \geq d_t^-(\mathbf{x})\} \subset (2\eta\sqrt{1-t} + 1 + (1-t)\mathbf{u}^\oplus)U^\circ,$$

$$E_2 := \{\mathbf{x} \in (2\eta\sqrt{1-t} + 1 + (1-t)\mathbf{u}^\oplus)\partial U : d_t^+(\mathbf{x}) \geq d_t^-(\mathbf{x})\},$$

$$E_3 := \{\mathbf{x} : d_t^+(\mathbf{x}) = d_t^-(\mathbf{x}), \hat{\mathbf{u}}_{t'} < 2\mathbf{x}^\oplus < 2\eta\sqrt{1-t'} + 1 + (1-t)\mathbf{u}^\oplus\}.$$

Now, the claim implies that $\mathbf{x}' \in \text{int } G_{t'}$ when $\mathbf{x} \in E_1 \cup E_2 \cup E_3$. This implies the following relationship among the G_t : for $t, t' \in [0, 1]$ with $t > t'$,

$$\partial G_t + \frac{t}{2}\mathbf{u} \subset \text{int } G_{t'} + \frac{t'}{2}\mathbf{u}. \quad (3.14)$$

Now, it follows from the construction of $S_{\mathbf{u}}$ that $\ell_{\mathbf{x}} \cap S_{\mathbf{u}}$ is a singleton. The latter part of the conclusion in (1) is obvious since $\mathcal{P}_h(S^+)$ is the closure of $(U + 2^{-1}\mathbf{u}) \setminus (1 - \mathbf{u}^\oplus)U$, $\mathcal{P}_h(S^-)$ is the closure of $(U - 2^{-1}\mathbf{u}) \setminus (1 - \mathbf{u}^\oplus)U$, and $\mathcal{P}_h(S^0) = (1 - \mathbf{u}^\oplus)U$.

(2) The height of $P \in S_{\mathbf{u}}$ is not equal to zero only if $P \in S''^+ \cup S''^-$, the horizontal coordinate of which is in

$$(1 + 2\eta + \|\mathbf{u}\|_\infty)U \setminus (1 - \|\mathbf{u}\|_\infty)U.$$

So, the conclusion follows.

We now show (3). By (1), the given condition $\mathbf{x} \in \partial U + 2^{-1}\mathbf{u}$ implies that $P \in S^+ \cup S^0$. Since S^0 lies in $\pi(0)$ and S^+ is the union of the convex combinations $((1 - \mathbf{u}^\oplus)\partial U^+) \times \{0\}$

and $(\partial U^+ + 2^{-1}\mathbf{u}) \times \{\varepsilon\}$, the height of P is equal to ε if and only if $\mathbf{x} \in \partial U^+ + 2^{-1}\mathbf{u}$. Next, we assume $\mathbf{x} \in \partial U^- \cup \partial U^\dagger + 2^{-1}\mathbf{u}$ but $\mathbf{x} \notin \partial U^+ + 2^{-1}\mathbf{u}$. If the height of P is positive, then $P \in S^+$ and $0 < \mathbf{y} < \varepsilon$. By the expression of S^+ (see (3.2)) there exist $\mathbf{y} \in \partial U^+$ and $t \in (0, 1)$ such that

$$\mathbf{x} = \hat{\mathbf{u}}_t \mathbf{y} + \frac{t}{2} \mathbf{u}.$$

Since $\mathbf{y} \in \partial U^+$, we choose some index j such that $2\omega_j(\mathbf{y}) = \text{sign}(u_j) \neq 0$. So,

$$\begin{aligned} |\omega_j(2\mathbf{x} - \mathbf{u})| &= |(t|u_j| + 1 - |u_j|) \cdot 2\omega_j(\mathbf{y}) + tu_j - u_j| \\ &= |2tu_j + \text{sign}(u_j) - 2u_j| = |1 - 2(1-t)|u_j|| \\ &\in (1 - 2|u_j|(1-t), 1) \subset (1 - 2\|\mathbf{u}\|_\infty, 1). \end{aligned}$$

This contradicts condition (3.11) and thus (3) holds.

The proof of (4) is analogous to that of (3). This completes the proof. \square

4. A KEY HOMEOMORPHISM ON \mathbb{R}^d

4.1. Definitions of transformations. In this subsection we present four transformations on \mathbb{R}^d , which will be used to construct the desired homeomorphism on \mathbb{R}^d . Before doing this, we introduce some notation, in addition to those in Subsection 2.3. Let $b > 0$ be a fixed positive constant as in Subsection 2.3. We choose ε stated as in Subsection 2.3 small enough such that the union $\cup_{k=0}^r S_k$ is disjoint, where $S_0 = \pi(0)$, $S_r = \pi(b)$ and

$$S_k = S_{\mathbf{u}_k} + \left(\frac{1}{2} \mathbf{u}_k + \mathbf{v}_{k-1}, y_k \right), \quad 1 \leq k < r. \quad (4.1)$$

Hence $S_{\mathbf{u}_k}$ is defined as in (3.6) with \mathbf{u} replaced by \mathbf{u}_k and η is a constant satisfying

$$\max_{0 < k < r} \{\|\mathbf{u}_k\|_\infty\} < \eta < 1. \quad (4.2)$$

For $1 \leq k < r$, $S_k^0, S_k^+, S_k^-, S_k'^+, S_k'^-$ are defined similarly. For convenience, we set

$$S_0^0 = U \times \{0\}, \quad S_r^0 = (U + \mathbf{v}_{r-1}) \times \{b\}, \quad \text{and} \quad S_0^+ = S_0^- = S_r^+ = S_r^- = \emptyset.$$

We use P to denote $(\mathbf{x}, y) \in \mathbb{R}^{d-1} \times [0, b]$, unless stated otherwise. Let $\mathbf{t} \in \mathbb{R}^{d-1}$ and $\mathbf{x}(y), \boldsymbol{\rho}(y)$ be defined as in (2.4), (2.5) respectively with $\mathbf{u}_1, \dots, \mathbf{u}_{r-1}$ given as in Subsection 2.3. Define an *affine transformation* $f_{\mathbf{t}}$, a *squeezing transformation* f_S , and a *translation* f_T as follows

$$f_{\mathbf{t}}(P) := P + \left(\frac{y\mathbf{t}}{b}, 0 \right), \quad (4.3)$$

$$f_S(P) := (\boldsymbol{\rho}(y), 1)P, \quad (4.4)$$

$$f_T(P) := P + (\mathbf{x}(y), 0). \quad (4.5)$$

Figure 1(a)–(d) show how these maps transform the prism.

We introduce some additional notation. Assume quasi-hyperplanes S_k are given as in Section 3. For a vertical line $\ell_{\mathbf{x}}$ (given as in (3.4)), denote by $Q_k = Q_k(\mathbf{x})$ the intersection of $\ell_{\mathbf{x}}$ and S_k (see Lemma 3.6(1) for the existence and uniqueness of Q_k) and denote $y'_k = y'_k(\mathbf{x}) = \omega_d(Q_k)$ for $0 \leq k \leq r$. Clearly $y'_0 = 0$ and $y'_r = b$. We now define the fourth transformation f_F , called a *flattening transformation*, as follows. Recall $P = (\mathbf{x}, y) \in \mathbb{R}^{d-1} \times [0, b]$. Let $k = k(P)$ be equal to r or the unique integer that satisfies $y'_k \leq y < y'_{k+1}$ according to $y = b$ or $y < b$, where y_k is as in (2.2). Define f_F on $\mathbb{R}^{d-1} \times [0, b]$ as (see Figure 10)

$$f_F(P) := (\mathbf{x}, \varphi(P)), \quad (4.6)$$

where

$$\varphi(P) := \begin{cases} \frac{b}{r} \cdot \frac{y - y'_k(\mathbf{x})}{y'_{k+1}(\mathbf{x}) - y'_k(\mathbf{x})} + y_k, & y < b; \\ b, & y = b. \end{cases} \quad (4.7)$$

Figure 1(d)–(e) show the restriction of f_F to the figure in (d).

We comment on the functions φ and f_F . Let $X_k \subset \mathbb{R}^d$ be the horizontal slab-shaped closed region bounded on the top and bottom by the irregular surfaces S_k and S_{k+1} . Then f_F maps each X_k onto the horizontal slab-shaped region $\mathbb{R}^{d-1} \times [y_k, y_{k+1}]$, and is piecewise linear on each vertical line segment. More precisely, on each vertical line segment

$$\{\mathbf{x}\} \times [0, b] = \bigcup_{k=0}^{r-1} \{\mathbf{x}\} \times [y'_k, y'_{k+1}],$$

f_F maps the k th line segment $\{\mathbf{x}\} \times [y'_k, y'_{k+1}]$ to the line segment $\{\mathbf{x}\} \times [y_k, y_{k+1}]$. Furthermore, we get the following estimation on the height difference between P and its image $f_F(P)$, which will be used to prove the continuity of the desired homeomorphism (Lemma 5.7).

Lemma 4.1. *Let f_F be defined as above and let $\varepsilon > 0$ be as in (2.3). Then, for each $P \in \mathbb{R}^{d-1} \times [0, b]$, we have*

$$|\mathcal{P}_v(f_F(P)) - \mathcal{P}_v(P)| \leq \varepsilon. \quad (4.8)$$

Proof. Let $P = (\mathbf{x}, y) \in \mathbb{R}^{d-1} \times [0, b]$. We may assume the height of P is in $[y'_k, y'_{k+1}]$ for some $0 \leq k < r$, since $\mathcal{P}_v(f_F(P)) = \mathcal{P}_v(P) = b$ when $y = b$. Note that

$$\mathcal{P}_v(f_F(P)) - \mathcal{P}_v(P) = \varphi(P) - \mathcal{P}_v(P) = \frac{b}{r} \cdot \frac{y - y'_k(\mathbf{x})}{y'_{k+1}(\mathbf{x}) - y'_k(\mathbf{x})} + y_k - y$$

is a linear function of the variable y . The maximum in absolute value of such a linear function can only be obtained at the end-points of the interval $[y'_k, y'_{k+1}]$, which are

$$\varphi((\mathbf{x}, y'_k)) - y'_k = y_k - y'_k \text{ and } \varphi((\mathbf{x}, y'_{k+1})) - y'_{k+1} = y_{k+1} - y'_{k+1}.$$

From the construction of S_k and S_{k+1} , for all $\mathbf{x} \in \mathbb{R}^{d-1}$, we know

$$y'_n \in (y_n - \varepsilon, y_n + \varepsilon), \quad n = k, k + 1.$$

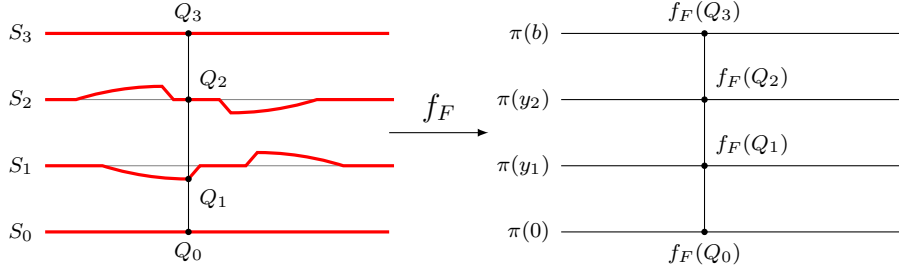

FIGURE 10. An illustration of f_F . The vertical line segment $Q_0Q_3 = \{\mathbf{x}\} \times [0, b]$ intersects S_i at Q_i , $i = 0, \dots, 3$. The last coordinate of $f_F(Q_i)$ is $\varphi(Q_i)$. This figure is drawn with $r = 3$.

Hence, (4.8) follows and the proof is complete. \square

4.2. **Some lemmas.** Define a map f as

$$f(P) = f_F \circ f_T \circ f_S(P), \quad P \in \mathbb{R}^{d-1} \times [0, b]. \quad (4.9)$$

Denote $f_T \circ f_S$ by f_{TS} for short. One can easily check that the mapping f is a homeomorphism on $\mathbb{R}^{d-1} \times [0, b]$. In this subsection we prove some properties of the several mappings on $\mathbb{R}^{d-1} \times [0, b]$ that we have defined.

In view of the complexity of f_F or f on the set $\partial U \times [0, b]$, we will decompose $\partial U \times [0, b]$. For $\mathbf{i} = i_1 \cdots i_{d-1} \in \{-1, 0, 1\}^{d-1}$, let

$$U_{\mathbf{i}} := \{\mathbf{x} \in U : \omega_j(\mathbf{x}) = 2^{-1}i_j \text{ if } i_j \neq 0 \text{ and } \omega_j(\mathbf{x}) \in [-2^{-1}, 2^{-1}] \text{ if } i_j = 0\};$$

$$\text{int } U_{\mathbf{i}} = U_{\mathbf{i}}^\circ = \{\mathbf{x} \in U_{\mathbf{i}} : \omega_j(\mathbf{x}) \in (-1/2, 1/2) \text{ if } i_j = 0\};$$

$$\partial U_{\mathbf{i}} = U_{\mathbf{i}} \setminus \text{int } U_{\mathbf{i}}$$

and

$$H_{\mathbf{i}} := U_{\mathbf{i}} \times [0, b], \quad \text{int}_v H_{\mathbf{i}} := \text{int } U_{\mathbf{i}} \times [0, b], \quad \partial_v H_{\mathbf{i}} := \partial U_{\mathbf{i}} \times [0, b].$$

The following facts are clear. First, $U = U_{\mathbf{i}}$ and $\partial U = \partial U_{\mathbf{i}}$ when $\mathbf{i} = 0^{d-1}$. Second, $\partial U_{\mathbf{i}} = U_{\mathbf{i}}$, $\text{int } U_{\mathbf{i}} = \emptyset$ (and hence $\text{int}_v H_{\mathbf{i}} = \emptyset$) if no component of \mathbf{i} is zero. Finally,

$$\partial U_{\mathbf{i}} = \{\mathbf{x} \in U_{\mathbf{i}} : \exists j \text{ s.t. } \omega_j(\mathbf{x}) = \pm 2^{-1} \text{ and } i_j = 0\}$$

if \mathbf{i} has at least one zero component. We call $\partial_v H_{\mathbf{i}}$ the *vertical boundary* of $H_{\mathbf{i}}$, which is different from $\partial H_{\mathbf{i}}$ in the set $U_{\mathbf{i}}^\circ \times \{0, b\}$. For simplicity, denote $H_{0^{d-1}}$ by H . For a set $E \subset \mathbb{R}^{d-1} \times [0, b]$, we use E^{TS} to denote the image of E under f_{TS} , e.g.,

$$H^{TS} = f_{TS}(H).$$

The following lemma is obvious; we omit its proof.

Lemma 4.2. *Let f_t and f_T be defined as above. Then for $P, P' \in \mathbb{R}^{d-1} \times [0, b]$, we have*

$$d_h(P, P') = d_h(f_t(P), f_t(P')) = d_h(f_T(P), f_T(P')).$$

Consequently, For any compact set $E \subset \mathbb{R}^d$ with $\mathcal{P}_v(E) = [0, b]$, we have

$$d_h(P, E) = d_h(f_t(P), f_t(E)) = d_h(f_T(P), f_T(E)), \quad P \in \mathbb{R}^{d-1} \times [0, b].$$

In particular, for $\mathbf{i} \in \{-1, 0, 1\}^{d-1}$ and $P \in \mathbb{R}^{d-1} \times [0, b]$,

$$d_h(P, \partial_v H_{\mathbf{i}}) = d_h(f_t(P), f_t(\partial_v H_{\mathbf{i}})) = d_h(f_T(P), f_T(\partial_v H_{\mathbf{i}})).$$

Recall the constant $c = \sum_{k=1}^{r-1} \|\mathbf{u}_k\|_{\infty}$.

Lemma 4.3. *Use the above notation. If P, P' are both in $\mathbb{R}^{d-1} \times [0, b]$, then*

$$d_h(f_S(P), f_S(P')) \geq (1 - c)d_h(P, P'). \quad (4.10)$$

Consequently, for $\mathbf{i} \in \{-1, 0, 1\}^{d-1}$ and for $P \in H_{\mathbf{i}}$, we have

$$d_h(f_S(P), f_S(\partial_v H_{\mathbf{i}})) \geq (1 - c)d_h(P, \partial_v H_{\mathbf{i}}). \quad (4.11)$$

Moreover, for $P \in \mathbb{R}^{d-1} \times [0, b]$,

$$d_h(f_S(P), f_S(\partial_v H)) \geq (1 - c)d_h(P, \partial_v H). \quad (4.12)$$

Proof. If $\mathcal{P}_v(P) \neq \mathcal{P}_v(P')$, (4.10) holds since both sides are equal to $+\infty$. So, we assume $P = (\mathbf{x}, y), P' = (\mathbf{x}', y) \in \mathbb{R}^{d-1} \times [0, b]$. Hence,

$$\begin{aligned} d_h(f_S(P), f_S(P')) &= \|\boldsymbol{\rho}(y)(\mathbf{x} - \mathbf{x}')\|_{\infty} \geq (1 - c)\|\mathbf{x} - \mathbf{x}'\|_{\infty} \\ &= (1 - c)d_h(P, P'). \end{aligned}$$

Let $\mathbf{i} \in \{-1, 0, 1\}^{d-1}$ be fixed. For $P = (\mathbf{x}, y) \in H_{\mathbf{i}}$, it follows from the definition of f_S that

$$\begin{aligned} d_h(f_S(P), f_S(\partial_v H_{\mathbf{i}})) &= \inf \{d_h(f_S(P), f_S(P')) : P' \in \partial_v H_{\mathbf{i}}\} \\ &\geq \inf \{(1 - c)d_h(P, P') : P' \in \partial_v H_{\mathbf{i}}\} \\ &= (1 - c)d_h(P, \partial_v H_{\mathbf{i}}). \end{aligned}$$

The inequality in (4.12) can be proved similarly. This completes the proof. \square

We now discuss the relationship between the horizontal distance from P to $\partial_v H^{TS}$ as defined in (3.7) and the horizontal distance between their images under the transformation f_F . The transformation f_F is determined by the quasi-hyperplanes defined in Subsection 4.1, or more precisely in Section 3. In order to state our idea clearly, we first comment on H^{TS} and $f_F(H^{TS}) = f(H)$ (see Figure 11 for an illustration). The set H^{TS} (see Figure 11 (a1,a2)) is a d -dimensional polytope (whose height is in $[0, b]$), the center axis of which is $\mathbf{x}(y)$, $0 \leq y \leq d$, and the restriction of which on the hyperplane $\pi(y)$, $0 \leq y \leq b$, is a $(d - 1)$ -dimensional hypercube with edge length vector being $\boldsymbol{\rho}(y)$. The d -dimensional

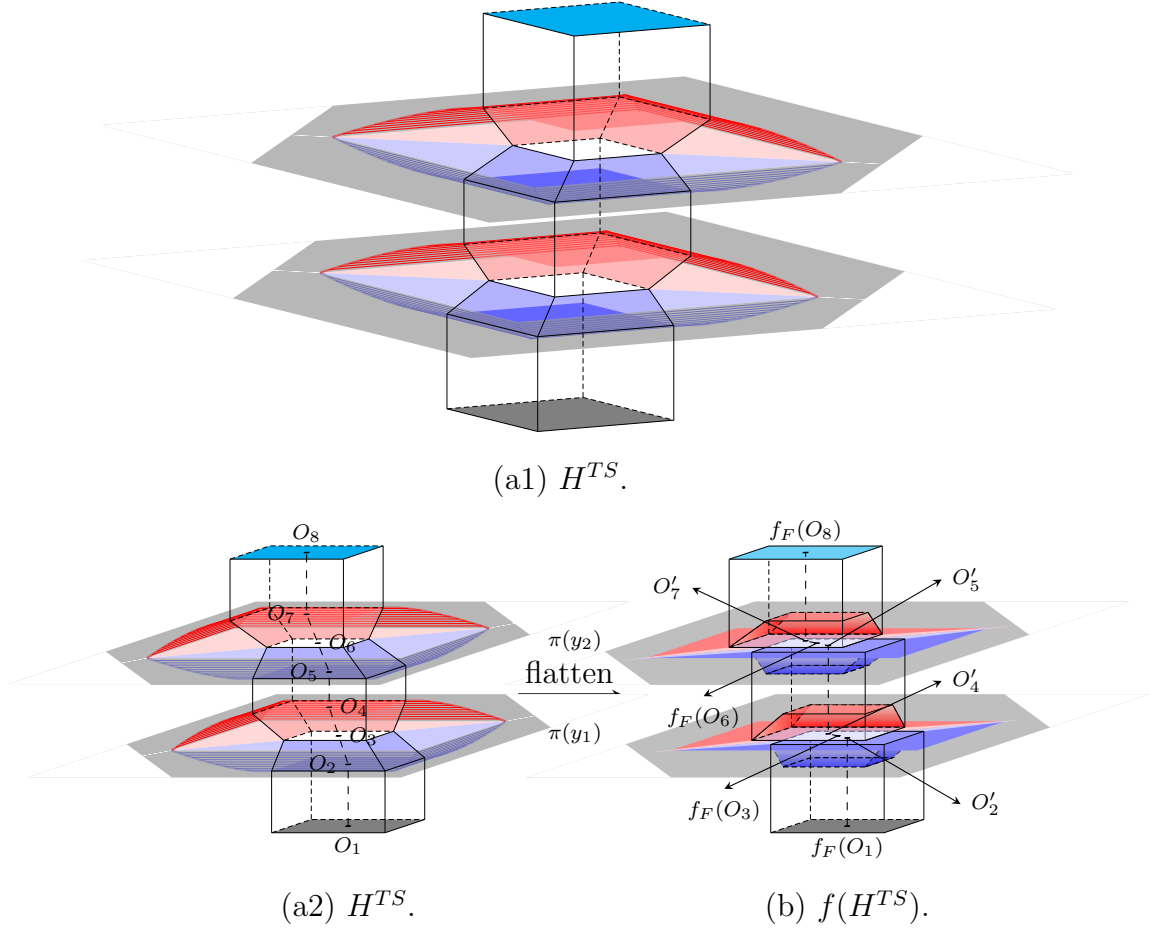

FIGURE 11. The sets H^{TS} and $f_F(H^{TS})$, along with the quasi-hyperplanes. (a1) and (a2) are the same set H^{TS} , with different viewpoints. The center axis of H^{TS} is the dashed line $O_1O_2 \cdots O_8$, the coordinates of which are $(\mathbf{x}(y), y)$ and $0 \leq y \leq b$. The restriction of H^{TS} on the hyperplane $\pi(y)$ is a $(d-1)$ -dimensional hypercube with edge length vector $\boldsymbol{\rho}(y)$. The line segment $O'_2f_F(O_3)O'_4$ is in the plane $\pi(y_1)$, while the line segment $O'_5f_F(O_6)O'_7$ is in the plane $\pi(y_2)$. This figure is drawn with $d = 3$, $\mathbf{u}_1 = (-0.3, -0.2)$, $\mathbf{u}_2 = (-0.5, -0.35)$, $b = 1$, and $\varepsilon = 0.1$.

polytope $f_F(H^{TS})$ (see Figure 11(b)) is a union of r small vertical d -dimensional prisms (the height of the k th small d -dimensional prism is in $[y_k, y_{k+1}]$), the restriction of which on the hyperplane $\pi(y)$, $0 \leq y \leq b$, is a unit hypercube or a union of two unit hypercubes according to $y \notin \{y_1, \dots, y_{r-1}\}$ or not.

We state a lemma concerning the boundary of H_i . We omit the proof since the conclusion follows directly from the definitions of f_T , f_S , f_F and $\boldsymbol{\rho}(\cdot)$, $\mathbf{x}(\cdot)$.

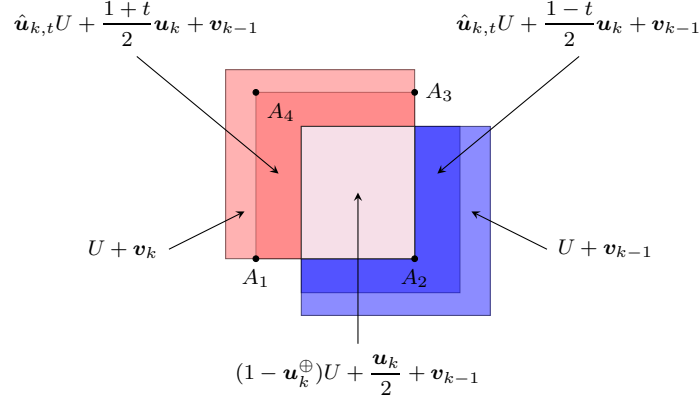

FIGURE 12. The projection of $H^{TS} \cap (\mathbb{R}^{d-1} \times [y_k - \varepsilon, y_k + \varepsilon])$ on the plane $\pi(y_k)$. If $P = (\mathbf{x}, y) \notin H^{TS}$ with $y \in (y_k, y_k + \varepsilon)$, then $\mathbf{x} = \mathcal{P}_h(P)$ is not in the rectangle $A_1A_2A_3A_4$, which is just $\hat{\mathbf{u}}_{k,t}U + 2^{-1}(t-1)\mathbf{u}_k + \mathbf{v}_k$. This figure is drawn with $\mathbf{u}_k = (-0.4, 0.3)$ and $t = 0.4$, $d = 3$.

Lemma 4.4. For each $\mathbf{i} \in \{-1, 0, 1\}^{d-1}$, the sets $H_{\mathbf{i}}^{TS}$ and $f_F(H_{\mathbf{i}}^{TS})$ can be rewritten as

$$H_{\mathbf{i}}^{TS} = \bigcup_{k=0}^{r-1} \bigcup_{y \in [y_k, y_{k+1}]} (\boldsymbol{\rho}(y)U_{\mathbf{i}} + \mathbf{x}(y)) \times \{y\}, \quad (4.13)$$

$$f_F(H_{\mathbf{i}}^{TS}) = \bigcup_{k=0}^{r-1} (U_{\mathbf{i}} + \mathbf{v}_k) \times [y_k, y_{k+1}]. \quad (4.14)$$

In the following three lemmas we establish some properties of the interior, exterior, and vertical boundary of H .

Recall that $\text{int}_v H^{TS} = f_{TS}(\text{int}_v H)$.

Lemma 4.5 (Interior). Let f be given as in (4.9). For $P \in \text{int}_v H$, we have

$$d_h(f(P), f(\partial_v H)) \geq (1-c)d_h(P, \partial_v H).$$

Proof. We first claim that

$$d_h(f_F(P), f_F(\partial_v H^{TS})) \geq d_h(P, \partial_v H^{TS}), \text{ for } P \in \text{int}_v H^{TS}. \quad (4.15)$$

Suppose $P = (\mathbf{x}, y) \in \text{int}_v H^{TS}$ and let $y' := \omega_d(f_F(P))$. We prove the claim for different values of y . If $y = 0$ or b , (4.15) holds since f_F is an identity on $\pi(0) \cup \pi(b)$. Now, let $y = y_k$ for some $k \in \{1, 2, \dots, r-1\}$. Since $P \in S_k^0$, we have (see Figure 12)

$$\mathbf{x} \in \boldsymbol{\rho}(y_k)U + \mathbf{x}(y_k) = (1 - \mathbf{u}_k^\oplus)U + \frac{\mathbf{u}_k}{2} + \mathbf{v}_{k-1} = (U + \mathbf{v}_{k-1}) \cap (U + \mathbf{v}_k). \quad (4.16)$$

The fact

$$\mathcal{P}_h\left(f_F(H^{TS}) \cap \pi(y_k)\right) = (U + \mathbf{v}_{k-1}) \cup (U + \mathbf{v}_k),$$

together with (4.16), implies that

$$\begin{aligned} d_h(f_F(P), f_F(\partial_v H^{TS})) &= d_h(\mathbf{x}, \partial((U + \mathbf{v}_{k-1}) \cup (U + \mathbf{v}_k))) \\ &= d_h(\mathbf{x}, \partial((U + \mathbf{v}_{k-1}) \cap (U + \mathbf{v}_k))) \\ &= d_h(\mathbf{x}, \boldsymbol{\rho}(y_k) \partial U + \mathbf{x}(y_k)), \end{aligned}$$

where we have used the expressions for $\boldsymbol{\rho}(y)$ and $\mathbf{x}(y)$ (see (2.4) and (2.5)) and the fact that f_F is an identity on S_k^0 (see Figures 10 and 12). Now, the conclusion follows from

$$d_h(P, \partial_v H^{TS}) = d_h(\mathbf{x}, \boldsymbol{\rho}(y_k) \partial U + \mathbf{x}(y_k)).$$

If $y \notin I_\varepsilon$, by (2.4) and (2.5) again we know $\boldsymbol{\rho}(y)U = U$ and $\mathbf{x}(y) = \mathbf{v}_k$, where k is the integer satisfying $y_k < y < y_{k+1}$. This implies

$$d_h(P, \partial_v H^{TS}) = d_h(f_F(P), f_F(\partial_v H^{TS}))$$

by (4.13), (4.14) and the fact $y' \in (y_k, y_{k+1})$.

Next, we assume $y \in I_{\varepsilon, k}$ for some $k \in \{1, \dots, r-1\}$ and $y \neq y_k$. By symmetry, we assume $y_k < y < y_k + \varepsilon$. The definition of f_F yields $y' \in (y_k, y_k + \varepsilon)$, which implies

$$d_h(f_F(P), f_F(\partial_v H^{TS})) = d_h(\mathbf{x}, \partial U + \mathbf{v}_k).$$

Setting $t = \varepsilon^{-1}(y - y_k) \in [0, 1]$, we see that

$$(t\mathbf{u}_k^\oplus + 1 - \mathbf{u}_k^\oplus)U + \frac{t-1}{2}\mathbf{u}_k \subset (t\mathbf{u}_k^\oplus + 1 - \mathbf{u}_k^\oplus + (1-t)\mathbf{u}_k^\oplus)U = U.$$

Adding \mathbf{v}_k to both sides, we get $\boldsymbol{\rho}(y)U + \mathbf{x}(y) \subset U + \mathbf{v}_k$, which leads to (4.15) since

$$d_h(P, \partial_v H^{TS}) = d_h(\mathbf{x}, \boldsymbol{\rho}(y) \partial U + \mathbf{x}(y)).$$

Now, (4.15), together with Lemmas 4.2 and 4.3, yields

$$\begin{aligned} d_h(f(P), f(\partial_v H)) &\geq d_h(f_{TS}(P), f_{TS}(\partial_v H)) \\ &= d_h(f_S(P), f_S(\partial_v H)) \\ &\geq (1-c)d_h(P, \partial_v H), \end{aligned}$$

which completes the proof. \square

Lemma 4.6 (Exterior). *Let f be given as in (4.9). Let $P \in \mathbb{R}^{d-1} \times [0, b]$. If $P \notin H$, then*

$$d_h(f(P), f(\partial_v H)) \geq (1-c)^{1/\eta+1} d_h(P, \partial_v H).$$

Proof. We first prove the following inequality

$$d_h(f_F(P), f_F(\partial_v H^{TS})) \geq (1-c)^{1/\eta} d_h(P, \partial_v H^{TS}), \quad \text{for } P \notin H^{TS}. \quad (4.17)$$

Since f_F is an identity on $\pi(0)$ and $\pi(b)$, we assume $P = (\mathbf{x}, y) \notin H^{TS}$ satisfying $y \in [y_k, y_{k+1})$ for $0 \leq k < r$. If $y \notin I_\varepsilon$, we see that $\boldsymbol{\rho}(y)U + \mathbf{x}(y) = U + \mathbf{v}_k$. By (4.13) and (4.14), we know

$$\begin{aligned} d_h(f_F(P), f_F(\partial_v H^{TS})) &= d_h(\mathbf{x}, U + \mathbf{v}_k) = d_h(\mathbf{x}, \boldsymbol{\rho}(y)U + \mathbf{x}(y)) \\ &= d_h(P, \partial_v H^{TS}). \end{aligned}$$

Next we assume $y \in I_\varepsilon$, which implies $y \in I_{\varepsilon, k}$ if $y \leq y_k + \varepsilon$ with $k > 0$ and $y \in I_{\varepsilon, k+1}$ if $y > y_{k+1} - \varepsilon$ with $y < r$. By symmetry, we consider the case $y_k \leq y \leq y_k + \varepsilon$ and $k > 0$. From (4.1), we know that

$$S_{u_k} = S_k - \left(\frac{1}{2} \mathbf{u}_k + \mathbf{v}_{k-1}, y_k \right),$$

and

$$S_{u_k}^+ = S_k^+ - \left(\frac{1}{2} \mathbf{u}_k + \mathbf{v}_{k-1}, y_k \right), \quad S_{u_k}'^+ = S_k'^+ - \left(\frac{1}{2} \mathbf{u}_k + \mathbf{v}_{k-1}, y_k \right).$$

Denote $P' = P - (2^{-1} \mathbf{u}_k + \mathbf{v}_{k-1}, y_k)$. Since $P \notin H^{TS}$ and $y_k \leq y \leq y_k + \varepsilon$, we know $\mathcal{P}_h(P') \notin \hat{\mathbf{u}}_{k,t}U + 2^{-1}t\mathbf{u}_k$, where $t = y'/\varepsilon = (y - y_k)/\varepsilon$ and $\hat{\mathbf{u}}_{k,t} = t\mathbf{u}_k^\oplus + 1 - \mathbf{u}_k^\oplus$ (see Figure 12). Thus, we denote $\mathcal{P}_h(P')$ by $\mathbf{x}' + 2^{-1}t\mathbf{u}_k$. Then

$$\mathbf{x}' + \frac{t}{2} \mathbf{u}_k = \mathbf{x} - \frac{1}{2} \mathbf{u}_k - \mathbf{v}_{k-1}.$$

So the horizontal distance on the right side of (4.17) is

$$\begin{aligned} d_h(P, \partial_v H^{TS}) &= d_h(P, S_k^+ \cup S_k'^+) = d_h(P', S_{u_k}^+ \cup S_{u_k}'^+) \\ &= d_h\left(\mathbf{x}' + \frac{t}{2} \mathbf{u}_k, \hat{\mathbf{u}}_{k,t} \partial U + \frac{t}{2} \mathbf{u}_k\right). \\ &= d_h(\mathbf{x}', \hat{\mathbf{u}}_{k,t} \partial U). \end{aligned}$$

If P lies below S_k , which means that P' lies below S_{u_k} , we see that $f_F(P)$ lies below $\pi(y_k)$. Hence

$$\begin{aligned} d_h(f_F(P), f_F(\partial H_v^{TS})) &= d_h(\mathbf{x}, U + \mathbf{v}_{k-1}) \\ &= d_h\left(\mathbf{x} - \mathbf{v}_{k-1} - \frac{1+t}{2} \mathbf{u}_k, U - \frac{1+t}{2} \mathbf{u}_k\right). \\ &= d_h\left(\mathbf{x}', U - \frac{1+t}{2} \mathbf{u}_k\right). \end{aligned}$$

If P lies above S_k or P is in S_k , which means P' lies above S_{u_k} or P' is in S_{u_k} , we know $f_F(P)$ lies above $\pi(y_k)$ or $f_F(P)$ is in $\pi(y_k)$. Thus, so

$$\begin{aligned} d_h(f_F(P), f_F(\partial H^{TS})) &= d_h(\mathbf{x}, U + \mathbf{v}_k) \\ &= d_h\left(\mathbf{x} - \mathbf{v}_{k-1} - \frac{1+t}{2} \mathbf{u}_k, U + \frac{1-t}{2} \mathbf{u}_k\right) \\ &= d_h\left(\mathbf{x}', U + \frac{1-t}{2} \mathbf{u}_k\right). \end{aligned}$$

Applying Lemma 3.4, we get the inequality (4.17). Now, the result follows from Lemmas 4.2 and 4.3 and (4.17). \square

Lemma 4.7 (Boundary). *Let $0^{d-1} \neq \mathbf{i} \in \{-1, 0, 1\}^{d-1}$. If $P \in \text{int}_v H_{\mathbf{i}}$ and the height of $f(P)$ is not in $\{y_0, \dots, y_r\}$, then*

$$d_h(f(P), f(\partial_v H_{\mathbf{i}})) \geq (1 - c)d_h(P, \partial_v H_{\mathbf{i}}).$$

Proof. Let $P = (\mathbf{x}, y) \in \text{int}_v H_{\mathbf{i}}$, $P' = f_{TS}(P) := (\mathbf{x}', y)$ and denote by y' the height of $f(P)$. Then $\mathbf{x}' = \boldsymbol{\rho}(y)\mathbf{x} + \mathbf{x}(y)$. Since f_F is an identity on $\cup_{k=0}^r S_k^0$, Lemma 4.2 and (4.11) in Lemma 4.3 imply $y' = y_k$ if $y = y_k$ for any k . So, by the assumption that the height of $f(P)$ is not in $\{y_0, \dots, y_r\}$, we assume $y \in (y_k, y_{k+1})$ for some $0 < k < r$, which implies $y' \in (y_k, y_{k+1})$. If $y \notin I_\varepsilon$, we know that $\mathbf{x}(y) = \mathbf{v}_k$ and $\boldsymbol{\rho}(y) = \mathbf{1}_{d-1}$ by (2.4) and (2.5). Hence, the restriction of $f(H_{\mathbf{i}})$ on $\pi(y')$ is $(U_{\mathbf{i}} + \mathbf{v}_k) \times \{y'\}$ by (4.14). Thus

$$\begin{aligned} d_h(f(P), f(\partial H_{\mathbf{i}})) &= d_h(\mathbf{x}', \partial U_{\mathbf{i}} + \mathbf{v}_k) \\ &= d_h(\boldsymbol{\rho}(y)\mathbf{x} + \mathbf{x}(y), \partial U_{\mathbf{i}} + \mathbf{x}(y)) \\ &= d_h(\mathbf{x}, \partial U_{\mathbf{i}}) = d_h(P, \partial H_{\mathbf{i}}). \end{aligned}$$

If $y \in I_\varepsilon$, we may assume, in view of symmetry, that $y \in (y_k, y_k + \varepsilon)$. For such y , we claim that $\boldsymbol{\rho}(y)U_{\mathbf{i}} + \mathbf{x}(y) \subset U_{\mathbf{i}} + \mathbf{v}_k$. If the claim holds, then

$$\begin{aligned} d_h(f(P), f(\partial_v H_{\mathbf{i}})) &= d_h(\boldsymbol{\rho}(y)\mathbf{x} + \mathbf{x}(y), \partial U_{\mathbf{i}} + \mathbf{v}_k) \\ &\geq d_h(\boldsymbol{\rho}(y)\mathbf{x} + \mathbf{x}(y), \boldsymbol{\rho}(y)\partial U_{\mathbf{i}} + \mathbf{x}(y)) \\ &= \boldsymbol{\rho}(y)d_h(\mathbf{x}, \partial U_{\mathbf{i}}) \geq (1 - c)d_h(P, \partial_v H_{\mathbf{i}}). \end{aligned}$$

The first inequality above holds since $\boldsymbol{\rho}(y)\mathbf{x} + \mathbf{x}(y) \in \boldsymbol{\rho}(y)U_{\mathbf{i}} + \mathbf{x}(y)$ (see Figure 13). Thus, the conclusion holds.

Next, we prove the claim by considering the components of horizontal coordinates of $\boldsymbol{\rho}(y)U_{\mathbf{i}} + \mathbf{x}(y)$ and $\mathbf{u}_i + \mathbf{v}_k$. Let $u_{kj} := \omega_j(\mathbf{u}_k)$ and let

$$\Lambda_1 = \{j : i_j u_{kj} < 0\}, \quad \Lambda_2 = \{j : i_j \neq 0, u_{kj} = 0\}, \quad \Lambda_3 = \{j : i_j = 0\}.$$

Since $P' \notin S_k^+$ (using the given condition $\mathcal{P}_v(f(P)) \notin \{y_0, \dots, y_r\}$), we know that $\Lambda_1, \Lambda_2, \Lambda_3$ form a partition of $\{1, \dots, d-1\}$. So, for each $\mathbf{y} \in U_{\mathbf{i}}$, we have

$$2\omega_j(\mathbf{y}) = -\text{sign}(u_{kj}), \quad 2\omega_j(\mathbf{y}) = i_j \quad \text{or} \quad 2\omega_j(\mathbf{y}) \in [-1, 1],$$

according to $j \in \Lambda_1$, $j \in \Lambda_2$ or $j \in \Lambda_3$. It follows that

$$\omega_j(\boldsymbol{\rho}(y)U_{\mathbf{i}} + \mathbf{x}(y)) = \{2^{-1}i_j + \omega_j(\mathbf{v}_k)\} = \omega_j(U_{\mathbf{i}} + \mathbf{v}_k)$$

or

$$\omega_j(\boldsymbol{\rho}(y)U_{\mathbf{i}} + \mathbf{x}(y)) \subset [-1/2, 1/2] + \omega_j(\mathbf{v}_k) = \omega_j(U_{\mathbf{i}} + \mathbf{v}_k),$$

according to $j \in \Lambda_1 \cup \Lambda_2$ or $j \in \Lambda_3$. This proves the claim and completes the proof of the lemma. \square

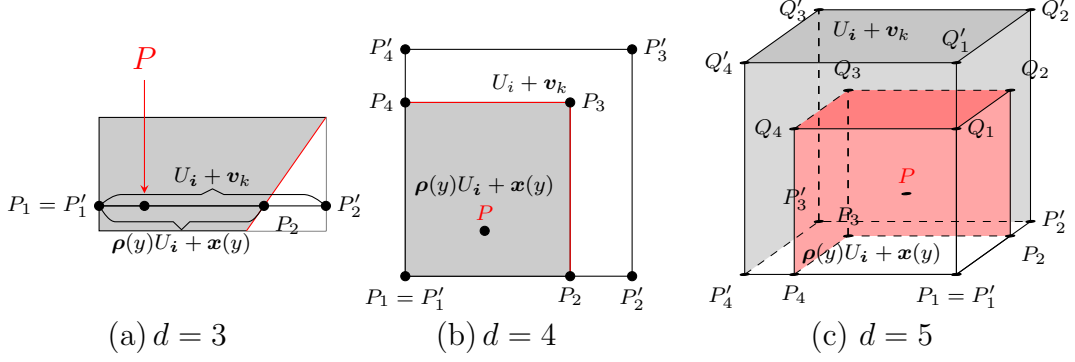

FIGURE 13. An illustration of Lemma 4.7. Figure (a) is the intersection of H_i^{TS} and $(U_i + \mathbf{v}_k) \times [y_k, y_k + \varepsilon]$ for the case $d = 3$. Figures (b) and (c) are the intersections of H_i^{TS} and $(U_i + \mathbf{v}_k) \times \{y\}$, where (b) is for $d = 4$ and (c) is for $d = 5$. The line P_1P_2 in (a), the rectangle $P_1P_2P_3P_4$ in (b), the cuboid $P_1P_2P_3P_4-Q_1Q_2Q_3Q_4$ in (c) are $\rho(y)U_i + \mathbf{x}(y)$, while the line $P_1'P_2'$ in (a), the rectangle $P_1'P_2'P_3'P_4'$ in (b) and the cuboid $P_1'P_2'P_3'P_4'-Q_1'Q_2'Q_3'Q_4'$ in (c) are $U_i + \mathbf{v}_k$. The figures are drawn with $y = y_k + 0.22\varepsilon$ and $\mathbf{u} = (u_1, 0.35)$, $\mathbf{i} = 10$ in (a), $\mathbf{u} = (u_1, 0.35, 0.3)$, $\mathbf{i} = 100$ in (b) and $\mathbf{u} = (u_1, 0.35, 0.3, 0.4)$, $\mathbf{i} = 1000$ in (c), where u_1 is a constant in $(0, 1)$.

For $P, P' \in \mathbb{R}^d$ and $E \subset \mathbb{R}^d$, let

$$d_v(P, P') := |\mathcal{P}_v(P) - \mathcal{P}_v(P')| \quad \text{and} \quad d_v(P, E) := \inf\{d_v(P, P') : P' \in E\}.$$

A word $\mathbf{i} = i_1 \dots i_{d-1}$ in $\{-1, 0, 1\}^{d-1}$ will determine a vector $(i_1, \dots, i_{d-1}) \in \mathbb{R}^{d-1}$. We use \mathbf{i} to denote such a vector if there is no confusion. The following lemma concerns the horizontal distance and the height difference of two points and their images under f .

Lemma 4.8 (Distance between two points). *Let $P, P' \in \mathbb{R}^{d-1} \times [0, b]$. Suppose $c < 4^{-1}$.*

- (1) (Not in $\partial_v H$) *If the horizontal distance between P and $\partial_v H$ satisfies*

$$d_h(P, \partial_v H) \geq \begin{cases} \frac{1}{2}(1 + 2\eta + 4c)^2 - \frac{1}{2}, & P \notin H; \\ 2c, & P \in H, \end{cases}$$

then $f(P)$ has the same height as P . If $d_h(P', \partial_v H)$ also satisfies the inequality stated above, then

$$d_h(f(P), f(P')) \geq (1 - c)^{1/\eta} d_h(P, P'). \quad (4.18)$$

- (2) (In $\partial_v H$) *Let $0^{d-1} \neq \mathbf{i} \in \{-1, 0, 1\}^{d-1}$ and $P, P' \in H_{\mathbf{i}}$. Assume there exists k , $0 \leq k < r$, such that the heights of $f(P), f(P')$ are both in the interval (y_k, y_{k+1}) . If none of the components of \mathbf{i} is zero, then*

$$d_v(f(P), f(P')) \geq d_v(P, P'). \quad (4.19)$$

If some component of \mathbf{i} is zero and $P, P' \in \text{int}_v H_{\mathbf{i}}$ satisfy $d_h(P, \partial_v H_{\mathbf{i}}) > 2c$ and $d_h(P', \partial_v H_{\mathbf{i}}) > 2c$, then (4.18) and (4.19) also hold. In particular, if $d_v(f(P), \pi(0) \cup \pi(b)) < b/r$, then

$$d_v(f(P), \pi(0) \cup \pi(b)) \geq d_v(P, \pi(0) \cup \pi(b)).$$

Proof. Let $P = (\mathbf{x}, y)$ and $P' = (\mathbf{x}', y') \in \mathbb{R}^{d-1} \times [0, b]$.

(1) We first consider the case $P \notin H$. This implies $\mathbf{x} \in (1+2\eta+4c)^2 U^c$. As $0 < c < 1/4$ and $\eta > 0$, we have $(1-c)(1+2\eta+4c) > 1+3c-4c^2 \geq 1+2c > 1$. For $1 \leq k < r$ and $y \in [y_k, y_{k+1}]$, we have

$$\begin{aligned} \mathcal{P}_h\left(f_{TS}\left((1+2\eta+4c)^2 U^c \times \{y_k\}\right)\right) &= \boldsymbol{\rho}(y)(1+2\eta+4c)^2 U^c + \mathbf{x}(y) \\ &\subset \frac{\boldsymbol{\rho}(y)}{1-c}(1+2\eta+4c)U^c + \mathbf{x}(y) \\ &\subset (1+2\eta+4c)U^c + \mathbf{x}(y) \\ &\subset (1+2\eta+4c-2\|\mathbf{x}(y)\|_\infty)U^c \subset (1+2\eta+2c)U^c. \end{aligned}$$

On the other hand $\varphi(\mathbf{z}, y_k) = y_k$ for $0 \leq k \leq r$ if $\mathbf{z} \in \mathcal{P}_h(\hat{S}_k^0)$, where

$$\hat{S}_n^0 = \left((1+2\eta+\|\mathbf{u}_n\|_\infty)U^c + \frac{1}{2}\mathbf{u}_n + \mathbf{v}_{n-1} \right) \times \{y_n\}, \quad 0 < n < r,$$

and $\hat{S}_0^0 = \hat{S}_1^0$, $\hat{S}_r^0 = \hat{S}_{r-1}^0$. This implies, by the definitions of φ and f_F , that f_F is an identity on $\{\mathbf{z}\} \times [y_k, y_{k+1}]$ when $\mathbf{z} \in \cap_{n=0}^r \mathcal{P}_h(\hat{S}_k^0)$. For $1 \leq k < r$,

$$(1+2\eta+\|\mathbf{u}_k\|_\infty)U + \frac{\mathbf{u}_k}{2} + \mathbf{v}_{k-1} \subset (1+2\eta+2c)U, \quad (4.20)$$

which implies

$$\bigcap_{k=0}^r \mathcal{P}_h(\hat{S}_k^0) \supset (1+2\eta+2c)U^c.$$

Consequently, f does not change the height of each point in $(1+2\eta+4c)^2 U^c \times [0, b]$.

Next we consider the case $P \in H$. The given hypothesis implies $\mathbf{x} \in (1-4c)U$. For each $1 \leq k < r$,

$$\boldsymbol{\rho}(y_k)(1-4c)U + \mathbf{x}(y_k) \subset (1-4c)U + \frac{1}{2}\mathbf{u}_k + \mathbf{v}_{k-1} \subset (1-2c)U. \quad (4.21)$$

On the other hand, from Lemma 3.6(2) and (4.1), we see that

$$\begin{aligned} \bigcap_{n=0}^r \mathcal{P}_h(S_n^0) &= \bigcap_{n=1}^{r-1} \left((1-\mathbf{u}_n^+)U + \frac{1}{2}\mathbf{u}_n + \mathbf{v}_{n-1} \right) \\ &\supset \bigcap_{n=1}^{r-1} \left(1 - 2 \sum_{m=1}^n \|\mathbf{u}_m\|_\infty \right) U \supset (1-2c)U. \end{aligned} \quad (4.22)$$

(4.21) and (4.22) imply that f does not change the height of $P \in (1-4c)U \times [0, b]$.

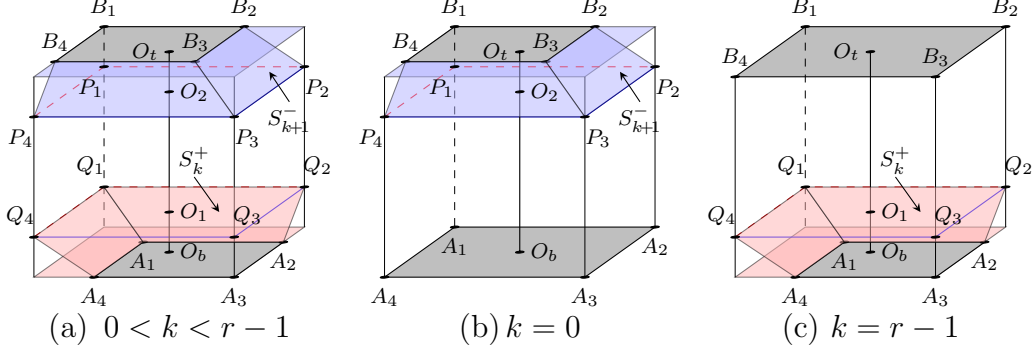

FIGURE 14. The restrictions of H^{TS} and $f_F(H^{TS})$ on $\mathbb{R}^{d-1} \times [y_k, y_{k+1}]$, where (a) is for the case $k \neq 0, r-1$; (b) and (c) are for the cases $k = 0$ and $k = r-1$ respectively. The line segment $O_b O_t$ is in the line $\ell_{\mathbf{v}_k}$, which is the center axis of $(U + \mathbf{v}_k) \times [y_k, y_{k+1}]$. The ranges of heights of $O_b O_1$, $O_1 O_2$ and $O_2 O_t$ in (a)–(c) are $I^{(b)}$, $I^{(m)}$ and $I^{(t)}$ respectively.

Now we show (4.18). The above discussion says that the heights of $f(P)$ and $f(P')$ are y and y' respectively. If $y \neq y'$, the left side of (4.18) is $+\infty$, and thus (4.18) holds trivially. If $y = y'$, a straightforward computation yields

$$\begin{aligned} d_h(f(P), f(P')) &= d_h(\boldsymbol{\rho}(y)\mathbf{x} + \mathbf{x}(y), \boldsymbol{\rho}(y)\mathbf{x}' + \mathbf{x}(y)) \\ &\geq \boldsymbol{\rho}(y)d_h(\mathbf{x}, \mathbf{x}') \geq (1-c)^{1/\eta}d_h(P, P'), \end{aligned}$$

since $0 < \eta < 1$ and $0 \leq c < 1$.

(2) The condition $\mathbf{i} \neq 0^{d-1}$ implies that $P \in \partial_v H$. We may assume $y \in [y_k, y_{k+1}]$ for some k . Let $P_1 = f_{TS}(P) = (\mathbf{x}_1, y)$ and let

$$I^{(b)} = \begin{cases} \emptyset, & k = 0; \\ [y_k, y_k + \varepsilon), & k > 0, \end{cases} \quad I^{(t)} = \begin{cases} \emptyset, & k = r-1; \\ (y_{k+1} - \varepsilon, y_{k+1}], & k < r-1, \end{cases}$$

and $I^{(m)} = [y_k + \varepsilon - \delta_k(0)\varepsilon, y_{k+1} - \varepsilon + \delta_{k+1}(r)\varepsilon]$, where $\delta_x(\cdot)$ is the Dirac function on \mathbb{R} ; see Figure 14. From the given condition on the height of $f(P)$, we see that

$$\mathbf{x}_1 - \mathbf{v}_k \in \begin{cases} (\partial U_{\mathbf{u}_k}^- \cup U_{\mathbf{u}_k}^0) \setminus (\partial U_{\mathbf{u}_k}^+), & y \in I^{(b)}; \\ (\partial U_{\mathbf{u}_{k+1}}^+ \cup \partial U_{\mathbf{u}_{k+1}}^0) \setminus (\partial U_{\mathbf{u}_{k+1}}^-), & y \in I^{(t)}; \\ \partial U, & y \in I^{(m)}. \end{cases} \quad (4.23)$$

Let $t_1 = \varepsilon^{-1}(y - y_k)$ and $t_2 = \varepsilon^{-1}(y_{k+1} - y)$. For $j \in \Lambda := \{j : i_j \neq 0\}$, it follows from $\mathbf{x}_1 = \boldsymbol{\rho}(y)\mathbf{x} + \mathbf{x}(y)$, $\mathbf{x} \in U_i$ and (4.23) that

$$\begin{aligned} & \omega_j(2\mathbf{x}_1 - 2\mathbf{v}_k) \\ &= \begin{cases} \omega_j((t_1\mathbf{u}_k^\oplus + 1 - \mathbf{u}_k^\oplus)i_j + (t_1 - 1)\mathbf{u}_k), & y \in I^{(b)}; \\ \omega_j((t_2\mathbf{u}_{k+1}^\oplus + 1 - \mathbf{u}_{k+1}^\oplus)i_j - (t_2 - 1)\mathbf{u}_{k+1}), & y \in I^{(t)}; \\ \omega_j(2(\mathbf{x} + \mathbf{v}_k) - 2\mathbf{v}_k), & y \in I^{(m)} \end{cases} \\ &= i_j = \pm 1. \end{aligned}$$

If \mathbf{i} has some a component, the hypothesis $d_h(P_1, \partial_v H_i) > 2c$ yields $|\omega_j(2\mathbf{x})| \leq 1 - 4c$ for $j \notin \Lambda$, which implies that

$$\begin{aligned} |\omega_j(2\mathbf{x}_1 - 2\mathbf{v}_k)| &= |\omega_j(2\boldsymbol{\rho}(y)\mathbf{x} + 2\mathbf{x}(y) - 2\mathbf{v}_k)| \\ &\leq \|\boldsymbol{\rho}(y)\|_\infty \omega_j(2\mathbf{x}^\oplus) + 2(\omega_j(\mathbf{u}_k^\oplus) + \omega_j(\mathbf{u}_{k+1}^\oplus)) \\ &\leq 1 - 4c + 2c \\ &\leq \min \{1 - 2\|\mathbf{u}_k\|_\infty, 1 - 2\|\mathbf{u}_{k+1}\|_\infty\}, \end{aligned}$$

where we set $\mathbf{u}_0 = \mathbf{u}_r = \mathbf{v}_0$. Recall that

$$S_n = S_{\mathbf{u}_n} + \frac{1}{2}\mathbf{u}_n + \mathbf{v}_{n-1} = S_{\mathbf{u}_n} - \frac{1}{2}\mathbf{u}_n + \mathbf{v}_n, \quad 1 \leq n < r.$$

Denote by y'_k, y'_{k+1} the heights of the intersections of $\ell_{\mathbf{x}_1}$ and S_k, S_{k+1} respectively. Applying Lemma 3.6(3,4) to such $\ell_{\mathbf{x}}$ and S_k, S_{k+1} , we have

$$y'_k = \begin{cases} y_k, & \text{if } \Lambda_1 = \emptyset; \\ y_k + \varepsilon, & \text{if } \Lambda_1 \neq \emptyset, \end{cases} \quad y'_{k+1} = \begin{cases} y_{k+1}, & \text{if } \Lambda_2 = \emptyset; \\ y_{k+1} - \varepsilon, & \text{if } \Lambda_2 \neq \emptyset, \end{cases} \quad (4.24)$$

where $\Lambda_1 = \{j : \omega_j(\mathbf{u}_k)i_j > 0\}$ and $\Lambda_2 = \{j : \omega_j(\mathbf{u}_{k+1})i_j < 0\}$. So if \mathbf{i} has a zero component, the height of $f(P)$, given by

$$\mathcal{P}_v(f(P)) = \frac{b}{r} \cdot \frac{y - y'_k}{y'_{k+1} - y'_k} + y_k \in [y_k, y_{k+1}] \quad (4.25)$$

is determined only by $y, \mathbf{i}, \mathbf{u}_k$ and \mathbf{u}_{k+1} , and is independent of \mathbf{x} (i.e., independent of the horizontal coordinates of Q, Q'). Assume the height of $f(P')$ is given as in (4.25) with y replaced by y' . Then

$$\begin{aligned} d_v(f(P), f(P')) &= \left| \frac{b}{r} \cdot \frac{y - y'_k}{y'_{k+1} - y'_k} - \frac{b}{r} \cdot \frac{y' - y'_k}{y'_{k+1} - y'_k} \right| \\ &= \left| \frac{b/r}{y'_{k+1} - y'_k} (y - y') \right| \\ &\geq |y - y'| = d_v(P, P') \end{aligned}$$

since $|y'_{k+1} - y'_k| \leq b/r$ by (4.24) and (2.3). We prove (4.19) for case \mathbf{i} has a zero component and the case \mathbf{i} does not have any zero component. Now, (4.18) follows from Lemmas 4.2 and 4.3. To prove the rest of the conclusion, we let $P' \in S_0^0$ or $P' \in S_r^0$ according to

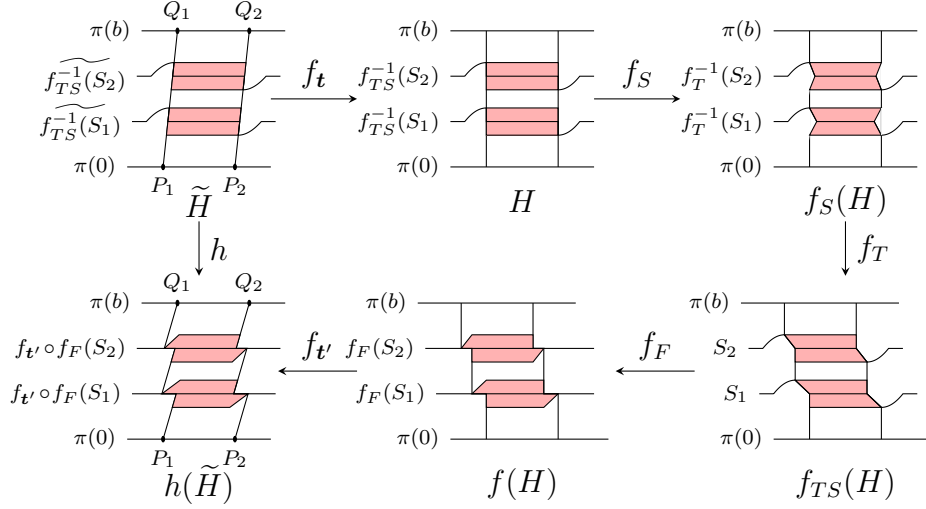

FIGURE 15. An illustration of h , where $\mathbf{t}' = \mathbf{t} - \mathbf{v}_{r-1}$.

whether the height of $f(P)$ is less than y_1 or larger than y_{r-1} and then apply (4.19) for such P and P' . This completes the proof. \square

Define a homeomorphism h on \mathbb{R}^d as follows (see Figure 15):

$$h(P) := \begin{cases} f_{\mathbf{t} - \sum \mathbf{u}_k} \circ f \circ f_{-\mathbf{t}}(P), & \mathcal{P}_v(P) \in [0, b]; \\ P, & \mathcal{P}_v(P) \notin (0, b). \end{cases} \quad (4.26)$$

We will denote h by $h_{\mathbf{t}, \{\mathbf{u}_k\}}$ when we want to emphasize that h is determined by the vectors $\mathbf{t}, \mathbf{u}_1, \dots, \mathbf{u}_{r-1}$.

For a set $E \subset \mathbb{R}^d$, we denote $f_{\mathbf{t}}(E)$ by \tilde{E} , e.g.,

$$\begin{aligned} \tilde{H}_i = f_{\mathbf{t}}(H_i) &= \left\{ \left(\frac{y\mathbf{t}}{b}, y \right) : 0 \leq y \leq b \right\} + U_i \times \{0\} \\ &= \left\{ \mathbf{t}(\mathbf{t}, b) : 0 \leq t \leq 1 \right\} + U_i \times \{0\}, \end{aligned} \quad (4.27)$$

$\text{int}_v \tilde{H} = f_{\mathbf{t}}(\text{int}_v H)$, $\partial_v \tilde{H}_i = f_{\mathbf{t}}(\partial_v H_i)$, and so on. Noting that $0 < \eta < 1$, $f_{\mathbf{t}}^{-1} = f_{-\mathbf{t}}$, we get the following useful proposition.

Proposition 4.9. *Assume $\mathbf{t}, \mathbf{u}_1, \dots, \mathbf{u}_{r-1}$ are $(d-1)$ -dimensional vectors satisfying $\{\mathbf{u}_k\} \subset 2U^\circ$ and $\eta \in (\max\{\|\mathbf{u}_k\|_\infty\}, 1)$. Then the function h , defined as in (4.26) with respect to the vectors $\mathbf{t}, \mathbf{u}_1, \dots, \mathbf{u}_{r-1}$, is a homeomorphism on \mathbb{R}^d . Moreover, if $c = \sum \|\mathbf{u}_k\|_\infty < 4^{-1}$, then the following statements hold.*

- (1) **(General property)** *The mapping h is an identity on $\mathbb{R}^{d-1} \times ((-\infty, 0] \cup [b, +\infty))$ satisfying*

$$h(\tilde{H}) = \bigcup_{k=0}^{r-1} \bigcup_{y_k \leq y \leq y_{k+1}} \left(U + \sum_{m=1}^k \mathbf{u}_m + \frac{y}{b} \left(\mathbf{t} - \sum_{m=1}^{r-1} \mathbf{u}_m \right) \right) \times \{y\} \quad (4.28)$$

(where we set an empty sum to be zero).

(2) (**Not on boundary**) For $P \notin \partial_v \tilde{H}$, we have

$$d_h(h(P), h(\partial_v \tilde{H})) \geq (1 - c)^{2/\eta} d_h(P, \partial_v \tilde{H}).$$

(3) (**Boundary**) Assume $0^{d-1} \neq \mathbf{i} \in \{-1, 0, 1\}^{d-1}$. If $P \in \text{int}_v \tilde{H}_{\mathbf{i}}$ is such that the height of $f(P)$ is not in $\{y_0, \dots, y_r\}$, then

$$d_h(h(P), h(\partial_v \tilde{H}_{\mathbf{i}})) \geq (1 - c)^{2/\eta} d_h(P, \partial_v \tilde{H}_{\mathbf{i}}).$$

(4) (**Distance between points**) Assume $P, P' \in \mathbb{R}^{d-1} \times [0, b]$.

(i) (**Not in $\partial_v \tilde{H}$**) If the horizontal distance between P and $\partial_v \tilde{H}$ satisfies

$$d_h(P, \partial_v \tilde{H}) \geq \begin{cases} \frac{1}{2}(1 + 2\eta + 4c)^2 - \frac{1}{2}, & P \notin \tilde{H}; \\ 2c, & P \in \tilde{H}, \end{cases}$$

then $h(P)$ has the same height as P . If $d_h(P', \partial_v \tilde{H})$ also satisfies the inequality stated above, then

$$d_h(h(P), h(P')) \geq (1 - c)^{2/\eta} d_h(P, P'). \quad (4.29)$$

(ii) (**In $\partial_v \tilde{H}$**) Let $0^{d-1} \neq \mathbf{i} \in \{-1, 0, 1\}^{d-1}$ and $P, P' \in \tilde{H}_{\mathbf{i}}$. Assume there exists k , $0 \leq k < r$, such that the heights of both $h(P)$ and $h(P')$ are in the interval (y_k, y_{k+1}) . If none of the components of \mathbf{i} is zero, then

$$d_v(h(P), h(P')) \geq d_v(P, P'). \quad (4.30)$$

If some component of \mathbf{i} is zero and $P, P' \in \text{int}_v \tilde{H}_{\mathbf{i}}$ satisfy

$$d_h(P, \partial_v \tilde{H}_{\mathbf{i}}), d_h(P', \partial_v \tilde{H}_{\mathbf{i}}) > 2c,$$

then (4.29) and (4.30) also hold. In particular, if $d_v(h(P), \pi(0) \cup \pi(b)) < b/r$, then

$$d_v(h(P), \pi(0) \cup \pi(b)) \geq d_v(P, \pi(0) \cup \pi(b)).$$

Proof. That the mapping h is a homeomorphism on \mathbb{R}^d follows directly from our construction. Conclusion (1) is a consequence of Lemma 4.4 and the definition of h . Conclusion (2) is a corollary of Lemmas 4.2, 4.5, and 4.6. Conclusion (3) follows from Lemmas 4.2 and 4.7. Lemmas 4.2 and 4.8 yield conclusions (4)(i) and (4)(ii). The proof is complete. \square

5. PREPARATION FOR THE CONSTRUCTION

In this section, we introduce some notation concerning the self-affine tile $T(A, \mathcal{D})$, some of which come from [12]. Let (A, \mathcal{D}) be the self-affine pair as in (1.5). For convenience, we also use r to denote p_d . Let $\mathcal{L}_{d-1} := \prod_{j=1}^{d-1} [0, |p_j|] \cap \mathbb{Z}^d$. For each digit $(\boldsymbol{\iota}, k) \in \mathcal{D}$ in Theorem 1.6 we add a perturbation $\mathbf{a}_k = (a_k^{(1)}, \dots, a_k^{(d-1)}) \in \mathbb{R}^{d-1}$ to the horizontal coordinate $\boldsymbol{\iota}$. Using a translation, we assume $\mathbf{a}_0 = (0, \dots, 0)$, which implies that the

origin of \mathbb{R}^d is in the new digit set. The new digit set can be expressed in a more general form:

$$\tilde{\mathcal{D}} = \{(\boldsymbol{\iota} + \mathbf{a}_k, k) : 0 \leq k < |r|, \boldsymbol{\iota} \in \mathcal{L}_{d-1}\}. \quad (5.1)$$

Theorem 1.6 can be adjusted to a general form as follows.

Theorem 5.1. *For $d \geq 2$, let A and $\tilde{\mathcal{D}}$ be as in (1.5) and (5.1) respectively, and let $T = T(A, \tilde{\mathcal{D}})$ be the self-affine tile. Then the following statements are equivalent.*

- (1) T° is connected;
- (2) T is a d -dimensional tame ball;
- (3) the following inequality holds:

$$\max_{\substack{0 \leq k < |r|-1 \\ 1 \leq j \leq d-1}} \left\{ \left| \frac{a_{k+1}^{(j)} - a_k^{(j)}}{p_j} - \frac{\text{sign}(r) \cdot a_{|r|-1}^{(j)} + s_j}{p_j(p_j - \text{sign}(r))} \right| \right\} < 1. \quad (5.2)$$

The following lemma, proved in [12], explains why we use this perturbation strategy.

Lemma 5.2. *Let A and $\tilde{\mathcal{D}}$ be as in (1.5) and (5.1) respectively. Then there exists another self-affine pair (A^2, \mathcal{D}') such that $T(A^2, \mathcal{D}')$ is a translation of $T(A, \tilde{\mathcal{D}})$ and the condition (5.2) for $(A, \tilde{\mathcal{D}})$ is equivalent to its analogue for (A^2, \mathcal{D}') .*

Remark 5.3. From the above lemma, we assume throughout the rest of this paper that the matrix A in the self-affine pair $(A, \tilde{\mathcal{D}})$ satisfies (1.5) with positive eigenvalues, the digit set $\tilde{\mathcal{D}}$ has the form (5.1), and $(0, \dots, 0) \in \tilde{\mathcal{D}}$.

Recall that the multiplication of vectors in \mathbb{R}^d is defined as in (2.1), i.e.,

$$\mathbf{x} \boxtimes \mathbf{y} = \mathbf{xy} := (\omega_1(\mathbf{x})\omega_1(\mathbf{y}), \dots, \omega_n(\mathbf{x})\omega_n(\mathbf{y})), \quad \mathbf{x}, \mathbf{y} \in \mathbb{R}^d.$$

From the form of the matrix A , we see that

$$A^{-n} = \begin{pmatrix} A_1^{-n} & \mathbf{s} \boxtimes \mathbf{s}_n \\ 0 & r^{-n} \end{pmatrix}, \quad n \geq 1,$$

where $\mathbf{s}_n = (s_n^{(1)}, \dots, s_n^{(d-1)})$ and

$$s_n^{(j)} := \lim_{q \rightarrow p_j} \frac{q^{-n} - r^{-n}}{r - q} = \begin{cases} \frac{p_j^{-n} - r^{-n}}{r - p_j}, & p_j \neq r, \\ \frac{n}{r^{n+1}}, & p_j = r. \end{cases} \quad (5.3)$$

For $\mathbf{k} = (k_1, \dots, k_{|\mathbf{k}|}) \in \Sigma_r^* \cup \Sigma_r^{\mathbb{N}}$, let

$$\mathbf{a}(\mathbf{k}) := (a_1(\mathbf{k}), \dots, a_{d-1}(\mathbf{k})), \quad \mathbf{s}(\mathbf{k}) := (s_1(\mathbf{k}), \dots, s_{d-1}(\mathbf{k})), \quad (5.4)$$

where

$$a_j(\mathbf{k}) := \sum_n \frac{a_{k_n}^{(j)}}{p_j^n}, \quad s_j(\mathbf{k}) := \sum_n s_n^{(j)} k_n, \quad 1 \leq j < d, \quad (5.5)$$

and let

$$\mathbf{b}(\mathbf{k}) := \mathbf{a}(\mathbf{k}) + \mathbf{s} \square \mathbf{s}(\mathbf{k}).$$

Here the empty sum is defined to be zero. Hence $\mathbf{b}(\emptyset) = \mathbf{a}(\emptyset) = \mathbf{s}(\emptyset) = (0, \dots, 0) \in \mathbb{R}^{d-1}$.

Let

$$S_{\iota, k}(P) := A^{-1}(P + (\iota + \mathbf{a}_k, k)), \quad \iota \in \mathcal{L}_{d-1}, \quad 0 \leq k < r, \quad (5.6)$$

be the iterated function system associated with $(A, \tilde{\mathcal{D}})$. Then it follows from the definition of T that

$$T = \bigcup_{\iota \in \mathcal{L}_{d-1}, 0 \leq k \leq r-1} S_{\iota, k}(T) \quad (5.7)$$

$$\begin{aligned} &= \left\{ \left(\mathbf{b}(\mathbf{k}) + (\varphi_{p_1}(\mathbf{i}_1), \dots, \varphi_{p_{d-1}}(\mathbf{i}_{d-1})), \varphi_r(\mathbf{k}) \right) : \mathbf{i}_j \in \Sigma_{p_j}^{\mathbb{N}}, \mathbf{k} \in \Sigma_r^{\mathbb{N}} \right\} \\ &= \left\{ (\mathbf{b}(\mathbf{k}), \varphi_r(\mathbf{k})) : \mathbf{k} \in \Sigma_r^{\mathbb{N}} \right\} + [0, 1]^{d-1} \times \{0\}. \end{aligned} \quad (5.8)$$

Define

$$S_{\iota_1 \dots \iota_n, k_1 \dots k_n} := S_{\iota_1, k_1} \circ \dots \circ S_{\iota_n, k_n}, \quad n \geq 1.$$

We now introduce the symbol $T_{\mathbf{k}}$ which will help us simplify the proof of Theorem 5.1. Recall that the convex combination of two sets is defined in Subsection 3, or more precisely in (3.3). For $n \geq 1$ and $\mathbf{k} \in \Sigma_r^{n-1}$, let $T_{\mathbf{k}}$ be the union of the convex combinations of the top and bottom surfaces of the following iterates of T :

$$S_{\iota_1 \dots \iota_n, \mathbf{k}}(T), \quad \iota_i \in \mathcal{L}_{d-1}, \quad 1 \leq i \leq n.$$

In other words, $T_{\mathbf{k}}$ is the union of the convex combination of two hypercubes, namely,

$$([0, 1]^{d-1} + \mathbf{b}(\mathbf{k})) \times \{\varphi_r(\mathbf{k})\}$$

and

$$([0, 1]^{d-1} + \mathbf{b}(\overline{\mathbf{k}r-1})) \times \left\{ \varphi_r(\mathbf{k}) + \frac{1}{r^{n-1}} \right\}.$$

Hence (see Figure 16(a) for $d = 3$ and (c) for $d = 2$),

$$\begin{aligned} T_{\mathbf{k}} &= \left\{ \left((1-t)\mathbf{b}(\mathbf{k}\bar{0}) + t\mathbf{b}(\overline{\mathbf{k}r-1}), \frac{t}{r^{n-1}} \right) : 0 \leq t \leq 1 \right\} + [0, 1]^{d-1} \times \{\varphi_r(\mathbf{k})\} \\ &= \left\{ t \left(\mathbf{b}(\overline{0^{n-1}r-1}), \frac{1}{r^{n-1}} \right) : 0 \leq t \leq 1 \right\} + [0, 1]^{d-1} \times \{0\} + (\mathbf{b}(\mathbf{k}), \varphi_r(\mathbf{k})) \end{aligned} \quad (5.9)$$

$$= \left\{ (\mathbf{b}(\mathbf{k}), \varphi_r(\mathbf{k})) + t \left(\mathbf{b}(\overline{0^{n-1}r-1}), \frac{1}{r^{n-1}} \right) : 0 \leq t \leq 1 \right\} + [0, 1]^{d-1} \times \{0\} \quad (5.10)$$

Comparing (5.8) and (5.10), the expressions for T and $T_{\mathbf{k}}$, we obtain the following lemma.

Lemma 5.4. *For $n \geq 1$ and $\mathbf{k} \in \Sigma_r^{n-1}$, let $T_{\mathbf{k}}$ is defined as above. Then*

$$T = \lim_{n \rightarrow \infty} \bigcup_{\mathbf{k} \in \Sigma_r^n} T_{\mathbf{k}}$$

in the Hausdorff distance.

Proof. Note that T is the attractor of the iterated function system $\{S_{\ell,k}\}$ defined as in (5.6). It follows that

$$T = \lim_{n \rightarrow \infty} \bigcup_{\substack{\ell_i \in \mathcal{L}_{d-1}, 0 \leq k_i < r, \\ 1 \leq i \leq n}} S_{\ell_1 \dots \ell_n, k_1 \dots k_n}(E)$$

in the Hausdorff distance [14], where E is any compact subset of \mathbb{R}^d . In particular, the above limit also exists if we set $E = T_\emptyset$. On the other hand, by iterating n times, one obtains, for $\mathbf{k} \in \Sigma_r^n$,

$$\bigcup_{\substack{\ell_i \in \mathcal{L}_{d-1}, \\ 1 \leq i \leq n}} S_{\ell_1 \dots \ell_n, \mathbf{k}}(T_\emptyset) = T_{\mathbf{k}}.$$

The conclusion follows. \square

We will employ the homeomorphism defined in (4.26) to construct a desired homeomorphism on \mathbb{R}^d . For this purpose, we need some additional notation, some of which has been introduced in [11, 12]. For a set $E \subset \mathbb{R}^d$, let $\|E\|_\infty := \sup\{\|P\|_\infty : P \in E\}$. Denote $a := \max\{\|\mathbf{a}_k\|_\infty : 1 \leq k < r\}$, $p := \min\{p_j : 1 \leq j \leq d\}$ and $s := \|\mathbf{s}\|_\infty$, where \mathbf{s} is given as in (1.5). For $n \geq 1$, let

$$\varepsilon_n := \frac{1}{3r^{2n}}, \quad c_n := \sum_{k=1}^{r-1} \|\mathbf{u}_{n,k}\|_\infty, \quad (5.11)$$

$$\mathbf{t}_n := \mathbf{b}(0^{n-1}\overline{r-1}), \quad (5.12)$$

$$Y_n := \left\{ \frac{k}{r^{n-1}} : 0 \leq k \leq r^{n-1} \right\} = \{\varphi_r(\mathbf{k}) : \mathbf{k} \in \Sigma_r^{n-1}\} \cup \{1\}, \quad (5.13)$$

where

$$\mathbf{u}_{n,k} := \mathbf{b}(0^{n-1}k) - \mathbf{b}(0^{n-1}(k-1)\overline{r-1}), \quad \text{for } 0 < k < r, \quad (5.14)$$

and let

$$\eta_n := \max \left\{ \left\| \{\mathbf{u}_{n,k}\}_{k=1}^r \right\|_\infty \left(\frac{1}{2} + \frac{1}{2 \left\| \{\mathbf{u}_{n,k}\}_{k=1}^r \right\|_\infty} \right), \frac{1}{n+1} \right\}. \quad (5.15)$$

We point out here that the sequence $\{\eta_n\}$ can be replaced by any sequence satisfying $\|\{\mathbf{u}_{1,k}\}\|_\infty < \eta_1 < 1$, and decreasing to 0 slowly so that the homeomorphism $h_{\mathbf{t}_n, \{\mathbf{u}_{n,k}\}}$ is well-defined.

For $n \geq 1$ and $\mathbf{k} \in \Sigma_r^{n-1}$, define

$$\mathbf{w}(\mathbf{k}) := (2^{-1}\mathbf{1}_{d-1} + \mathbf{b}(\mathbf{k}), \varphi_r(\mathbf{k})) \quad (5.16)$$

which is the center of the hypercube

$$T_{\mathbf{k}}|_{\pi(\varphi_r(\mathbf{k}))} = U \times \{0\} + \mathbf{w}(\mathbf{k}).$$

We comment on the vectors \mathbf{t}_n and $\mathbf{u}_{n,k}$ (see Figure 16). For $n \geq 1$, $0 < k < r$, $\mathbf{u}_{n,k}$ is the difference of the centers of two $(d-1)$ -dimensional unit hypercubes in $T|_{\pi(\varphi(\mathbf{k}k))}$ (where \mathbf{k} is any word in Σ_r^{n-1}), namely, $U + \mathbf{b}(\mathbf{k}k)$ and $U + \mathbf{b}(\mathbf{k}(k-1)\overline{r-1})$. In fact,

$$\mathbf{b}(\mathbf{k}k) - \mathbf{b}(\mathbf{k}(k-1)\overline{r-1}) = \mathbf{b}(0^{n-1}k) - \mathbf{b}(0^{n-1}(k-1)\overline{r-1}) = \mathbf{u}_{n,k}.$$

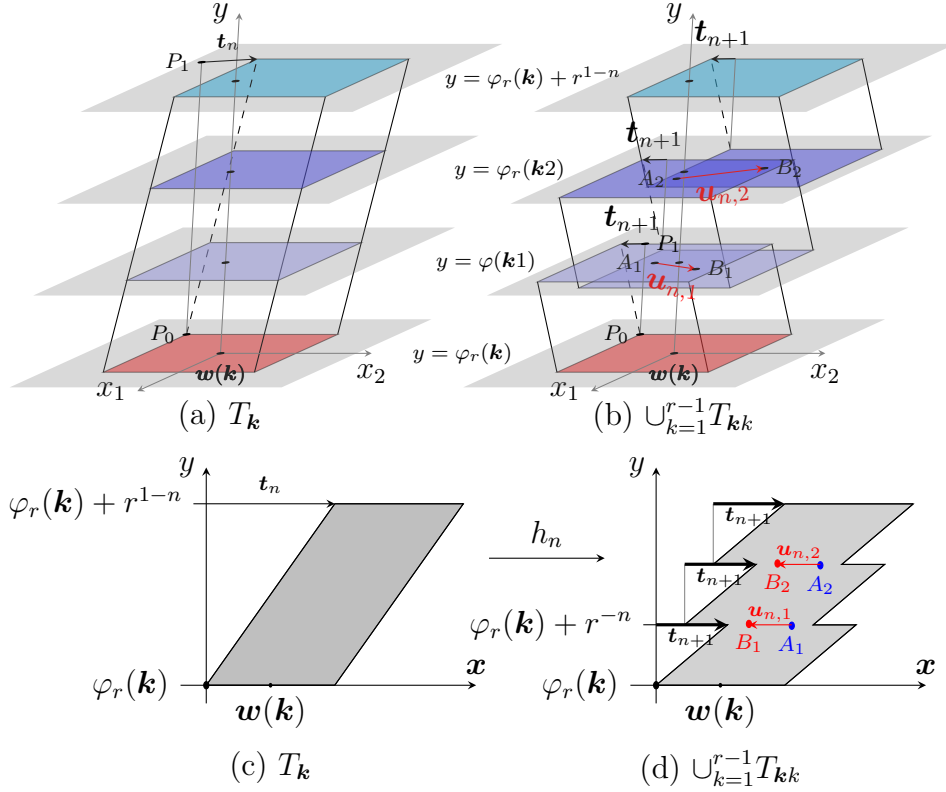

FIGURE 16. An illustration of \mathbf{t}_n , $\{\mathbf{u}_{n,k}\}$ and $\mathbf{w}(\mathbf{k})$ and the homeomorphism h_n on $T_{\mathbf{k}}$, where $n \geq 1$ and $\mathbf{k} \in \Sigma_r^{n-1}$. The vectors $\mathbf{u}_{n,k}$ in (b) and (d) are $\overrightarrow{A_k B_k}$, where A_k is the center of $U + \mathbf{b}(\mathbf{k}(k-1)\overline{r-1})$, while B_k is the center of $U + \mathbf{b}(\mathbf{k}k)$, $k = 1, 2$. The line segment $P_0 P_1$ (in (a) and (b)) is in the line $\ell_{\mathbf{b}(\mathbf{k})}$. The vector $\mathbf{t}_n = \mathbf{b}(0^{n-1}\overline{r-1}) = \mathbf{b}(\overline{\mathbf{k}r-1}) - \mathbf{b}(\mathbf{k})$. This figure is drawn with $r = 3$; moreover, $d = 3$ in (a) and (b), while $d = 2$ in (c) and (d).

For each $\mathbf{k} \in \Sigma_r^{n-1}$, \mathbf{t}_n is the vector corresponding to an affine transformation defined as in (4.3) with $b = r^{1-n}$ in a suitable rectangular coordinate system (moving the origin to $\mathbf{w}(\mathbf{k})$), the inverse of which transforms $T_{\mathbf{k}}$ into a vertical d -dimensional prism, namely,

$$f_{-\mathbf{t}_n}(T_{\mathbf{k}} - \mathbf{w}(\mathbf{k})) = U \times [0, r^{1-n}].$$

Both $\mathbf{u}_{n,k}$ and \mathbf{t}_n are determined by the self-affine pair (A, \tilde{D}) but are independent of $\mathbf{k} \in \Sigma_r^{n-1}$.

For $n \geq 1$ and $\mathbf{k} \in \Sigma_r^{n-1}$, we can use the symbols introduced above to rewrite the expression for $T_{\mathbf{k}}$ defined as in (5.9) as

$$\begin{aligned} T_{\mathbf{k}} &= \left\{ t\left(\mathbf{t}_n, \frac{1}{r^{n-1}}\right) : 0 \leq t \leq 1 \right\} + U \times \{0\} + \mathbf{w}(\mathbf{k}) \\ &= \left\{ \left(\frac{y}{r^{1-n}}\mathbf{t}_n, y\right) : 0 \leq y \leq \frac{1}{r^{n-1}} \right\} + U \times \{0\} + \mathbf{w}(\mathbf{k}). \end{aligned} \quad (5.17)$$

Combining (4.27) and (5.17), we know that

$$T_{\mathbf{k}} = \tilde{H} + \mathbf{w}(\mathbf{k}) \quad (5.18)$$

with r^{1-n} , \mathbf{t}_n replacing b , \mathbf{t} respectively. In view of the relation between $T_{\mathbf{k}}$ and \tilde{H} , we let

$$T_{\mathbf{k},i} := \tilde{H}_i + \mathbf{w}(\mathbf{k}), \quad \text{int}_v T_{\mathbf{k},i} := \text{int}_v \tilde{H}_i + \mathbf{w}(\mathbf{k}), \quad \partial_v T_{\mathbf{k},i} := \partial_v \tilde{H}_i + \mathbf{w}(\mathbf{k}). \quad (5.19)$$

These relations allow us to define a homeomorphism h_n under the condition

$$\|\{\mathbf{u}_{1,k}\}\|_\infty < 1,$$

by using the function $h_{\mathbf{t}_n, \{\mathbf{u}_{n,k}\}}$ defined in (4.26), with $\varepsilon = \varepsilon_n$, $\eta = \eta_n$ and $\mathbf{u}_k = \mathbf{u}_{n,k}$. We first point out that if all $\mathbf{u}_{1,k}$, $1 \leq k < r$, are in $2U^\circ$, then homeomorphism $h_{\mathbf{t}_n, \{\mathbf{u}_{n,k}\}}$ is well-defined. In fact, what we need to check are that ε_n satisfies (2.3) (which is obvious from the first formula in (5.11)) and that $\|\{\mathbf{u}_{n,k}\}\|_\infty < \eta_n < 1$. The definition of η_n in (5.15), together with the monotonicity of $\{\|\mathbf{u}_{n,k}\|_\infty\}_{n \geq 1}$, $1 \leq k < r$, implies that such an η_n satisfies the requirement. Hence, $h_{\mathbf{t}_n, \{\mathbf{u}_{n,k}\}}$ is well-defined.

Now we defined h_n as follows. We let h_n be an identity on $\mathbb{R}^{d-1} \times (\mathbb{R} \setminus [0, 1])$. For each slab $\mathbb{R}^{d-1} \times ([0, r^{1-n}] + \varphi_r(\mathbf{k}))$, where $\mathbf{k} \in \Sigma_r^{n-1}$, we move the origin of \mathbb{R}^d to $\mathbf{w}(\mathbf{k})$, which sends $T_{\mathbf{k}}$ to \tilde{H} , and then move the origin back after applying $h_{\mathbf{t}_n, \{\mathbf{u}_{n,k}\}}$ on \mathbb{R}^d , resulting in the map h_n on the slab $\mathbb{R}^{d-1} \times ([0, r^{1-n}] + \varphi_r(\mathbf{k}))$ (see Figure 16), namely,

$$h_n(P) = \begin{cases} P, & \mathcal{P}_v(P) \notin [0, 1]; \\ h_{\mathbf{t}_n, \{\mathbf{u}_{n,k}\}}(P - \mathbf{w}(\mathbf{k})) + \mathbf{w}(\mathbf{k}), & \mathcal{P}_v(P) \in [0, r^{1-n}] + \varphi_r(\mathbf{k}), \mathbf{k} \in \Sigma_r^{n-1}. \end{cases} \quad (5.20)$$

We point out that if $n \geq 1$ and $\mathcal{P}_v(P) \in [0, r^{1-n}] + \varphi_r(\mathbf{k})$ with $\mathbf{k} \in \Sigma_r^{n-1}$, then

$$h_n(P) - \mathbf{w}(\mathbf{k}) = h_{\mathbf{t}_n, \{\mathbf{u}_{n,k}\}}(P - \mathbf{w}(\mathbf{k})).$$

From the definition of h_n , we obtain the following lemma.

Lemma 5.5. *Let $n \geq 1$, $\|\{\mathbf{u}_{n,k}\}\|_\infty < 1$, and $y \in Y_n$. Then h_n is an identity on the hyperplane $\pi(y)$ and maps $\mathbb{R}^{d-1} \times [y, y + r^{1-n}]$ onto itself. In addition, for $\mathbf{k} \in \Sigma_r^{n-1}$,*

$$h_n(T_{\mathbf{k}}) = \bigcup_{k=0}^{r-1} T_{\mathbf{k}k}. \quad (5.21)$$

Proof. The first part of the conclusion can be obtained easily by using the definition of h_n ; we will prove (5.21). Fix a word $\mathbf{k} \in \Sigma_r^{n-1}$. Let $h_{\mathbf{t}_n, \{\mathbf{u}_{n,k}\}}$ be defined as in (4.26) with respect to $\varepsilon = \varepsilon_n$ and $b = r^{1-n}$. We first list some formulas which will simplify our proof. By (5.16), we get

$$\mathbf{w}(\mathbf{k}k) - \mathbf{w}(\mathbf{k}) = (\mathbf{b}(0^{n-1}k), \varphi_r(0^{n-1}k)) = (\mathbf{b}(0^{n-1}k), y_k), \quad (5.22)$$

where $y_k = kb/r = kr^{-n}$. By (5.14) and the fact that $\mathbf{b}(\mathbf{k}\mathbf{k}') = \mathbf{b}(\mathbf{k}) + \mathbf{b}(0^{|\mathbf{k}|}\mathbf{k}')$ for $\mathbf{k}, \mathbf{k}' \in \Sigma_r^*$, we get

$$\begin{aligned} \sum_{m=1}^k \mathbf{u}_{n,m} &= \sum_{m=1}^k \left(\mathbf{b}(0^{n-1}m) - \mathbf{b}(0^{n-1}(m-1)\overline{r-1}) \right) \\ &= \mathbf{b}(0^{n-1}k) - k\mathbf{b}(0^n\overline{r-1}). \end{aligned} \quad (5.23)$$

This, together with the expressions for \mathbf{t}_n (see (5.12)), implies

$$\begin{aligned} \mathbf{t}_n - \sum_{k=1}^{r-1} \mathbf{u}_{n,k} &= \mathbf{b}(0^{n-1}\overline{r-1}) - \mathbf{b}(0^{n-1}(r-1)) + (r-1)\mathbf{b}(0^n\overline{r-1}) \\ &= r\mathbf{b}(0^n\overline{r-1}) = r\mathbf{t}_{n+1}. \end{aligned} \quad (5.24)$$

For $t \in [0, 1]$, let $y = y_k + tr^{-n} = y_k + tb/r \in [y_k, y_k + b/r]$. It follows from (5.23) and (5.24) that

$$\begin{aligned} t \cdot \mathbf{t}_{n+1} + \mathbf{b}(0^{n-1}k) &= \frac{y}{b} \left(\mathbf{t}_n - \sum_{m=1}^{r-1} \mathbf{u}_{n,m} \right) - \frac{y_k}{b} \times r \cdot \mathbf{t}_{n+1} + \mathbf{b}(0^{n-1}k) \\ &= \frac{y}{b} \left(\mathbf{t}_n - \sum_{m=1}^{r-1} \mathbf{u}_{n,m} \right) + \mathbf{b}(0^{n-1}k) - k\mathbf{b}(0^n\overline{r-1}) \\ &= \frac{y}{b} \left(\mathbf{t}_n - \sum_{m=1}^{r-1} \mathbf{u}_{n,m} \right) + \sum_{m=1}^k \mathbf{u}_{n,m}. \end{aligned} \quad (5.25)$$

We now turn to the proof of (5.21). By the relationship between $T_{\mathbf{k}}$ and \tilde{H} and the expression (5.17) for $T_{\mathbf{k}}$, we see that (5.21) is equivalent to

$$h_{\mathbf{t}_n, \{\mathbf{u}_{n,k}\}}(\tilde{H}) = \bigcup_{k=0}^{r-1} \left(\left\{ t \left(\mathbf{t}_{n+1}, \frac{1}{r^n} \right) : 0 \leq t \leq 1 \right\} + U \times \{0\} + \mathbf{w}(\mathbf{k}k) - \mathbf{w}(\mathbf{k}) \right). \quad (5.26)$$

So, from (5.22) and (5.25), we see that the k th term in the union on the right side of (5.26) is (recall that $b = r^{1-n}$)

$$\begin{aligned} &\left\{ t \left(\mathbf{t}_{n+1}, \frac{1}{r^n} \right) : 0 \leq t \leq 1 \right\} + U \times \{0\} + (\mathbf{b}(0^n k), y_k) \\ &= \bigcup_{0 \leq t \leq 1} \left(U + t \cdot \mathbf{t}_{n+1} + \mathbf{b}(0^n k) \right) \times \left\{ y_k + \frac{t}{r^n} \right\} \\ &= \bigcup_{y_k \leq y \leq y_k + r^{-n}} \left(U + \frac{y}{b} \left(\mathbf{t}_n - \sum_{m=1}^{r-1} \mathbf{u}_{n,m} \right) + \sum_{m=1}^k \mathbf{u}_{n,m} \right) \times \{y\}. \end{aligned}$$

The last line is just the k th term in the union in (4.28). Hence, (5.26) holds and the proof is complete. \square

In the following lemma we prove some analytic properties of the quantities $\mathbf{u}_{n,k}$, \mathbf{t}_n and c_n , $\mathbf{w}(\mathbf{k})$. Recall that $a := \max\{\|\mathbf{a}_k\|_\infty\}$, $s := \|\mathbf{s}\|_\infty$ and $p := \min\{p_j : 1 \leq j \leq d\} > 1$.

Lemma 5.6. *Let $\mathbf{u}_{n,k}$, \mathbf{t}_n and c_n , $\mathbf{w}(\mathbf{k})$ be given as in (5.14), (5.12), (5.11), and (5.16). Then the following statements hold.*

(1) *For all $k \in \mathbb{N}$, $\|\mathbf{u}_{n,k}\|_\infty < 1$ if and only if*

$$\max_{\substack{1 \leq k < r, \\ 1 \leq j < d}} \left\{ \left| \frac{a_{k+1}^{(j)} - a_k^{(j)}}{p_j^n} - \frac{a_{r-1}^{(j)} + s_j}{p_j^n(p_j - 1)} \right| \right\} < 1. \quad (5.27)$$

(2) $\|\mathbf{t}_n\|_\infty \leq p^{1-n}(a+s)$ and $\mathbf{w}(\mathbf{k})$ are bounded. Moreover, for all n and all $\mathbf{k} \in \Sigma_r^*$, we have

$$\|\mathbf{t}_n\|_\infty + \|\mathbf{w}(\mathbf{k})\|_\infty \leq 2(a+s+1). \quad (5.28)$$

(3) $c_n \leq p^{-n}(4ar+sr)$ and $\lambda_1 := \prod_{n=1}^{\mathbb{N}}(1+c_n) < +\infty$. Furthermore, if $c_1 < 1$, then

$$\lambda_2 := \prod_{n \geq 1} (1-c_n)^{2/\eta_n} > 0. \quad (5.29)$$

Proof. (1) It follows from the expansion for $\mathbf{b}(\mathbf{k})$ that the j th component of $\mathbf{u}_{n,k}$ is

$$\omega_j(\mathbf{u}_{n,k}) = \frac{a_k^{(j)} - a_{k-1}^{(j)}}{p_j^n} - \frac{a_{r-1}^{(j)} + s_j}{p_j^n(p_j - 1)}. \quad (5.30)$$

Hence conclusion (1) holds.

(2) From (5.30) we know that

$$|\omega_j(\mathbf{u}_{n,k})| \leq \frac{2a}{p^n} + \frac{a+s}{p^n(p-1)} \leq \frac{3a+s}{p^n}.$$

The definition of $\mathbf{b}(\mathbf{k})$ implies that for $\mathbf{k} \in \Sigma_r^* \cup \Sigma_r^{\mathbb{N}}$,

$$\begin{aligned} \|\mathbf{b}(\mathbf{k})\|_\infty &\leq \|\mathbf{a}(\mathbf{k})\|_\infty + s \cdot \|\mathbf{s}(\mathbf{k})\|_\infty \\ &\leq a \sum_{n \geq 1} \frac{1}{p^n} + s(r-1) \max \left\{ \sum_{n \geq 1} s_n^{(j)} : 1 \leq j < d \right\} \\ &\leq \frac{a+s}{p-1} \leq a+s. \end{aligned}$$

Consequently, $\|\mathbf{w}(\mathbf{k})\|_\infty \leq \|2^{-1}\mathbf{1}_{d-1}\|_\infty + \|\mathbf{b}(\mathbf{k})\|_\infty + |\varphi_r(\mathbf{k})| \leq 3/2 + a + s$. Using similar arguments, we get

$$\|\mathbf{t}_n\|_\infty = \|\mathbf{b}(0^{n-1}\overline{r-1})\|_\infty \leq \frac{a+s}{p^{n-1}}.$$

Thus (5.28) holds.

(3) By (5.30) again, we know that

$$c_n = \sum_{k=1}^{r-1} \|\mathbf{u}_{n,k}\|_\infty \leq (r-1) \cdot \frac{4a+s}{p^n} \leq \frac{4ar+sr}{p^n}.$$

By the estimation

$$\sum_{n \geq 1} \ln(1+c_n) \leq \sum_{n \geq 1} c_n \leq \frac{pc_1}{p-1} \leq 2c_1,$$

we get $\lambda_1 < +\infty$. Next, we assume $c_1 < 1$. Note that $\eta_n = (n+1)^{-1}$ for all n sufficiently large. This implies the convergence of the series

$$\sum_{n \geq 1} \frac{1}{\eta_n} |\ln(1-c_n)| \leq \sum_{n \geq 1} \frac{1}{\eta_n} \left| \ln \left(1 - \frac{4ar+sr}{p^n} \right) \right|.$$

Thus $\lambda_2 > 0$. □

In the rest of this paper, we assume λ_1 and λ_2 are defined as in Lemma 5.6(3) and let

$$\lambda_3 := 2(a + s + 2) \sum_{n \geq 1} (c_n + \|\mathbf{t}_n\|_\infty + \varepsilon_n), \quad (5.31)$$

which converges by Lemma 5.6(2,3) and the expression for ε_n (see (5.11)). The following lemma will be used to prove the continuity of the desired homeomorphism.

Lemma 5.7. *Let h_n be defined as in (5.20). Then, for $P \in \mathbb{R}^d$, we have*

$$d_v(h_n(P), P) \leq \varepsilon_n, \quad (5.32)$$

and

$$\|h_n(P) - P\|_\infty \leq c_n \|P\|_\infty + 2(a + s + 2)c_n + \|\mathbf{t}_n\|_\infty + \varepsilon_n. \quad (5.33)$$

Proof. Since h_n is an identity on $\mathbb{R}^{d-1} \times (\mathbb{R} \setminus (0, 1))$, we may assume $P = (\mathbf{x}, y) \in \mathbb{R}^d \times (0, 1)$. Let $h_n(P) := (\mathbf{x}', y')$, $\mathbf{v}_n := \sum_{k=1}^{r-1} \mathbf{u}_{n,k}$ and $\mathbf{t}'_n := \mathbf{t}_n - \mathbf{v}_n$. Furthermore, we assume $y \in [0, r^{1-n}] + \varphi_r(\mathbf{k})$ with $\mathbf{k} \in \Sigma_r^{n-1}$. Hence h_n can be written as

$$h_n(P) = f_{\mathbf{t}'_n} \circ f_F \circ f_T \circ f_S \circ f_{-\mathbf{t}_n}(P - \mathbf{w}(\mathbf{k})) + \mathbf{w}(\mathbf{k}). \quad (5.34)$$

Among the functions on the right side, f_F is the only one that can change the height of a point. From (4.8) and (5.34), we get

$$|y - y'| = |y - \varphi(P')| \leq \varepsilon_n,$$

where $P' = f_T \circ f_S \circ f_{-\mathbf{t}_n}(P - \mathbf{w}(\mathbf{k}))$. This is just (5.32).

Next, we show (5.33). Let $z = y - \varphi_r(\mathbf{k})$ and $z' = y' - \varphi_r(\mathbf{k})$. The horizontal coordinate of $h_n(P)$ is

$$\rho(z) \left(\mathbf{x} - \frac{z}{b} \cdot \mathbf{t}_n - \mathbf{w}(\mathbf{k}) \right) + \mathbf{x}(z) + \frac{z'}{b} (\mathbf{t}_n - \mathbf{v}_n) + \mathbf{w}(k),$$

where $b = r^{1-n}$. This implies that

$$\begin{aligned} \|\mathcal{P}_h(h_n(P)) - \mathbf{x}\|_\infty &\leq \left\| (\rho(z) - 1) \left(\mathbf{x} - \frac{z}{b} \mathbf{t}_n - \mathbf{w}(\mathbf{k}) \right) \right\|_\infty \\ &\quad + \frac{|z' - z|}{b} \|\mathbf{t}_n\|_\infty + \left\| \mathbf{x}(z) - \frac{z'}{b} \mathbf{v}_n \right\|_\infty \\ &\leq c_n (\|\mathbf{x}\|_\infty + \|\mathbf{t}_n\|_\infty + \|\mathbf{w}(\mathbf{k})\|_\infty + 2) + \|\mathbf{t}_n\|_\infty \\ &\leq c_n \|\mathbf{x}\|_\infty + 2(a + s + 2)c_n + \|\mathbf{t}_n\|_\infty. \end{aligned}$$

The last line follows from (5.28). Hence (5.33) holds, and this completes the proof. \square

6. PROOF OF THEOREM 5.1

This section is devoted to the proof of Theorem 5.1. To this end, we first present the definition of the homeomorphism h_∞ by using the homeomorphisms h_n defined in (5.20). The map h_∞ sends a d -dimensional slant prism to the self-affine tile in \mathbb{R}^d . Then we show that h_∞ is a continuous surjection. After that, we use three lemmas to prove the injectivity of h_∞ . Finally, we present the proof of Theorem 5.1.

Let g_0 be the identity on \mathbb{R}^d and let $g_n := h_n \circ h_{n-1} \circ \cdots \circ h_1$ for $n \geq 1$, where h_n is defined as in (5.20). Now, define the desired homeomorphism as

$$h_\infty := \lim_{n \rightarrow +\infty} g_n = \lim_{n \rightarrow +\infty} h_n \circ \cdots \circ h_1. \quad (6.1)$$

For $P \in \mathbb{R}^d$, let $B(P, R)$ be the closed ball with radius R centered at P , namely,

$$B(P, R) := \{P' : \|P - P'\|_\infty \leq R\}.$$

Lemma 6.1. *Let h_∞ be defined as above. Then h_∞ is a continuous surjection on \mathbb{R}^d .*

Proof. We first show h_∞ is a well-defined. For $P \in \mathbb{R}^d$, by (5.33) we see

$$\begin{aligned} \|h_n(P)\|_\infty &\leq \|P\|_\infty + \|h_n(P) - P\|_\infty \\ &\leq (1 + c_n)\|P\|_\infty + 2(a + s + 2)c_n + \|\mathbf{t}_n\|_\infty + \varepsilon_n. \end{aligned}$$

By induction, for $n \geq 1$,

$$\begin{aligned} \|g_n(P)\|_\infty &\leq (1 + c_n)\|g_{n-1}(P)\|_\infty + 2(a + s + 2)c_n + \|\mathbf{t}_n\|_\infty + \varepsilon_n \\ &\leq (1 + c_1) \cdots (1 + c_n) \left(\|P\|_\infty + \sum_{m=1}^n (2(a + s + 2)c_m + \|\mathbf{t}_m\|_\infty + \varepsilon_m) \right) \\ &\leq \lambda_1 \|P\|_\infty + \lambda_1 \lambda_3. \end{aligned} \quad (6.2)$$

So, for any two integers $n, m \geq 0$ with $n > m$,

$$\begin{aligned} \|g_n(P) - g_m(P)\|_\infty &\leq \sum_{i=m+1}^n \|g_i(P) - g_{i-1}(P)\|_\infty \\ &\leq \sum_{i=m+1}^n \left(c_i \|g_{i-1}(P)\|_\infty + 2(a + s + 2)c_i + \|\mathbf{t}_i\|_\infty + \varepsilon_i \right) \\ &\leq \sum_{i=m+1}^n \left((\lambda_1 \|P\|_\infty + \lambda_1 \lambda_3 + 2(a + s + 2))c_i + \|\mathbf{t}_i\|_\infty + \varepsilon_i \right) \\ &\leq \lambda_1 \|P\|_\infty \sum_{i>m} c_i + C \sum_{i>m} (c_i + \|\mathbf{t}_i\|_\infty + \varepsilon_i), \end{aligned} \quad (6.3)$$

where the constant C is $\lambda_1 \lambda_3 + 2(a + s + 2)$. Thus $\{g_n(P)\}$ is a Cauchy's sequence and $h_\infty(P)$ exists. Hence h_∞ is well-defined on \mathbb{R}^d .

Next, we show the continuity of h_∞ . Let $P_0 \in \mathbb{R}^d$ and $\varepsilon > 0$ be fixed. Since $\sum_{n \geq 1} (c_n + \|\mathbf{t}_n\|_\infty + \varepsilon_n)$ converges, there exists $N > 0$ such that

$$\sum_{n \geq N} (c_n + \|\mathbf{t}_n\|_\infty + \varepsilon_n) < \varepsilon.$$

From the continuity of each h_n , we obtain the continuity of $g_N = h_N \circ \cdots \circ h_1$. Hence there exists $\delta > 0$, such that $\|P - P_0\|_\infty < \delta$ implies that $\|g_N(P) - g_N(P_0)\|_\infty < \varepsilon$. By

(6.3), if $P \in \mathbb{R}^d$ satisfies $\|P - P_0\|_\infty < \delta$, we have

$$\begin{aligned}
 \|h_\infty(P) - h_\infty(P_0)\|_\infty &= \left\| \lim_{n \rightarrow +\infty} (g_n(P) - g_n(P_0)) \right\|_\infty \\
 &= \lim_{n \rightarrow +\infty} \|g_n(P) - g_m(P) + g_m(P) - g_m(P_0) + g_m(P_0) - g_n(P_0)\|_\infty \\
 &\leq \varepsilon + \lim_{n \rightarrow +\infty} (\|g_n(P) - g_m(P)\|_\infty + \|g_m(P_0) - g_n(P_0)\|_\infty) \\
 &\leq \varepsilon + (\lambda_1 \|P\|_\infty + \lambda_1 \|P_0\|_\infty) \sum_{n>m} c_n + 2C \sum_{n>m} (c_n + \|\mathbf{t}_n\|_\infty + \varepsilon_n) \\
 &\leq (2\lambda_1 \|P_0\|_\infty + \lambda_1 \delta + 2C + 1)\varepsilon.
 \end{aligned}$$

So, h_∞ is continuous on \mathbb{R}^d .

Finally, we show h_∞ is surjective. Let N be sufficiently large so that $\lambda_1 \sum_{n \geq N} c_n < 1$. Let $P_\infty \in \mathbb{R}^d$ be fixed and let

$$\tilde{g}_n := g_{n+N} \circ g_N^{-1} = h_{n+N} \circ \cdots \circ h_{N+1},$$

where g_N^{-1} is the inverse of g_N . For convenience, we let \tilde{g}_0 be the identity. Since each \tilde{g}_n is a homeomorphism on \mathbb{R}^d , there exists a sequence of points $\{P_n\}$ such that $\tilde{g}_n(P_n) = P_\infty$. We claim that $\{P_n\}$ is bounded. Otherwise, there would exist a subsequence $\{P_{n_k}\}$ satisfying $\lim_{k \rightarrow +\infty} \|P_{n_k}\|_\infty = +\infty$. Noting that $P_\infty = \tilde{g}_{n_k}(P_{n_k})$, $k \geq 1$, is fixed, we have

$$\lim_{k \rightarrow +\infty} \frac{\|\tilde{g}_{n_k}(P_{n_k}) - P_{n_k}\|_\infty}{\|P_{n_k}\|_\infty} \geq \lim_{k \rightarrow +\infty} \frac{\|P_{n_k}\|_\infty - \|P_\infty\|_\infty}{\|P_{n_k}\|_\infty} = 1.$$

On the other hands, similar to the proof of (6.3) with n, m replaced by $n_k, 0$, we get

$$\|\tilde{g}_{n_k}(P_{n_k}) - P_{n_k}\|_\infty \leq \lambda_1 \|P_{n_k}\|_\infty \sum_{n \geq N} c_n + C \sum_{n \geq N} (c_n + \|\mathbf{t}_n\|_\infty + \varepsilon_n),$$

which implies, by the choice of N , that

$$\lim_{k \rightarrow +\infty} \frac{\|\tilde{g}_{n_k}(P_{n_k}) - P_{n_k}\|_\infty}{\|P_{n_k}\|_\infty} \leq \lambda_1 \sum_{m \geq 1} c_m + \lim_{k \rightarrow +\infty} \frac{C \sum_{m \geq 1} (c_m + \|\mathbf{t}_m\|_\infty + \varepsilon_m)}{\|P_{n_k}\|_\infty} < 1,$$

a contradiction. So, $\{P_n\}$ is bounded. Let $\{P_{n_k}\}$ be a subsequence which converges to some P_0 . For any fixed $\varepsilon > 0$, there exists $\delta = \delta(\varepsilon) > 0$ such that

$$P \in B(P_0, \delta) \Rightarrow \|h_\infty \circ g_N^{-1}(P) - h_\infty \circ g_N^{-1}(P_0)\|_\infty < \varepsilon$$

by the continuity of h_∞ and g_N^{-1} . By (5.33), $\{\tilde{g}_n\}$ (and hence $\{\tilde{g}_{n_k}\}$) converges uniformly (to $h_\infty \circ g_N^{-1}$) on any compact subset of \mathbb{R}^d ; more precisely, for the above $\varepsilon > 0$, there exists $K > 0$ such that $\|h_\infty \circ g_N^{-1}(P) - \tilde{g}_{n_k}(P)\|_\infty \leq \varepsilon$ for all $P \in B(P_0, \delta)$. We also assume K satisfies $P_{n_K} \in B(P_0, \delta)$. So,

$$\begin{aligned}
 &\|\tilde{g}_{n_K}(P_{n_K}) - \tilde{g}_{n_K}(P_0)\|_\infty \\
 &= \|\tilde{g}_{n_K}(P_{n_K}) - h_\infty \circ g_N^{-1}(P_{n_K}) + h_\infty \circ g_N^{-1}(P_{n_K}) - h_\infty \circ g_N^{-1}(P_0) \\
 &\quad + h_\infty \circ g_N^{-1}(P_0) - \tilde{g}_{n_K}(P_0)\| \\
 &< 3\varepsilon.
 \end{aligned}$$

Hence,

$$\begin{aligned} \|h_\infty \circ g_N^{-1}(P_0) - P_\infty\|_\infty &\leq \|h_\infty \circ g_N^{-1}(P_0) - \tilde{g}_{n_K}(P_0)\|_\infty + \|\tilde{g}_{n_K}(P_0) - P_\infty\|_\infty \\ &\leq \varepsilon + \|\tilde{g}_{n_K}(P_0) - \tilde{g}_{n_K}(P_{n_K})\|_\infty < 4\varepsilon. \end{aligned}$$

Since $\varepsilon > 0$ was arbitrary, $h_\infty \circ g_N^{-1}(P_0) = P_\infty$. So, $h_\infty \circ g_N^{-1}$ is a surjection. This proves that h_∞ is surjective. \square

In the rest of this section, we prove the injectivity of h_∞ . For this purpose, we let

$$(\mathbf{x}_n, y_n) := g_n(P), \quad (\mathbf{x}'_n, y'_n) := g_n(P'), \quad n \geq 1, \quad (6.4)$$

where $P, P' \in \mathbb{R}^d$, and let

$$(\mathbf{x}_\infty, y_\infty) := h_\infty(P), \quad (\mathbf{x}'_\infty, y'_\infty) := h_\infty(P'). \quad (6.5)$$

We point out that the quantities y_n, y'_n in this section are different from the ones in Section 4. The following is a key lemma to deal with the horizontal distance between $h_\infty(P)$ and the image of the vertical boundary of $T_{\emptyset, i}$ under the map h_∞ . Note that d_h is not a real metric on \mathbb{R}^d , and hence it may not be valid to interchange d_h and the limit as follows

$$d_h(h_\infty(P), h_\infty(\partial T_{\emptyset, i})) = \lim_{n \rightarrow +\infty} d_h(g_n(P), g_n(\partial T_{\emptyset, i})).$$

We will make full use of the construction of $T_{\mathbf{k}}$ to overcome this difficulty. Recall that for $E \subset \mathbb{R}^d$ and $y \in \mathbb{R}$,

$$E|_{\pi(y)} = \{P \in E : \mathcal{P}_v(P) = y\}.$$

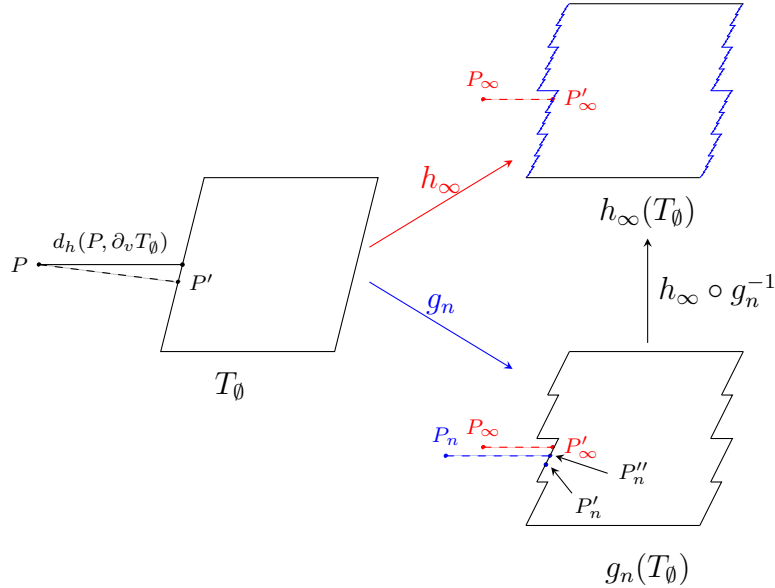

FIGURE 17. An illustration of $d_h(h_\infty(P), h_\infty(P'))$. $P_n = g_n(P)$, $P'_n = g_n(P')$, $P_\infty = h_\infty(P)$, and $P'_\infty = h_\infty(P')$. P''_n and P_n have the same height.

Lemma 6.2. *Let h_∞ be defined as in (6.1) and suppose $\mathbf{i} \in \{-1, 0, 1\}^{d-1}$ and $P \in (\mathbb{R}^{d-1} \times [0, 1]) \setminus (\partial_v T_{\emptyset, \mathbf{i}})$. If $c_1 < 1/4$, then*

$$d_h(h_\infty(P), h_\infty(\partial_v T_{\emptyset, \mathbf{i}})) > 0.$$

Proof. In view of the equality $h_\infty = \lim_{n \rightarrow +\infty} g_n$, we will estimate the horizontal distance between $g_n(P)$ and $g_n(\partial_v T_{\emptyset, \mathbf{i}})$. Recall that $(\mathbf{x}_n, y_n) = g_n(P)$. Note that h_n is an identity on each hyperplane $\pi(y)$, $y \in Y_n$, which implies that $h_\infty = g_n$ on such hyperplanes. Since g_n is a homeomorphism on \mathbb{R}^d , for each $\mathbf{i} \in \{-1, 0, 1\}$ and for each $P \in (\mathbb{R}^{d-1} \times [0, 1]) \setminus (\partial_v T_{\emptyset, \mathbf{i}})$ with $y_n \in Y_n$, we have

$$\begin{aligned} d_h(h_\infty(P), h_\infty(\partial_v T_{\emptyset, \mathbf{i}})) &= d_h(h_\infty(P), h_\infty(\partial_v T_{\emptyset, \mathbf{i}})|_{\pi(y_n)}) \\ &= d_h(g_n(P), g_n(\partial_v T_{\emptyset, \mathbf{i}})|_{\pi(y_n)}), \end{aligned}$$

which is positive by the compactness of $\partial_v T_{\emptyset, \mathbf{i}}$ and the continuity of g_n . Next, we assume

$$P \notin \bigcup_{n \geq 1} g_n^{-1} \left(\bigcup_{y \in Y_n} \pi(y) \right), \quad (6.6)$$

where g_n^{-1} is the inverse of g_n . Let P_∞ be given as in (6.5) and let $\mathbf{k}_n \in \Sigma_r^n$ such that $y_n \in (0, r^{-n}) + \varphi_r(\mathbf{k}_n)$. Such a \mathbf{k}_n does exist since (6.6) holds. By (6.6) again, for $n \geq 1$, we see that

$$\begin{aligned} d_h(g_n(P), g_n(\partial_v T_{\emptyset, \mathbf{i}})) &= d_h(g_n(P), g_n(\partial_v T_{\emptyset, \mathbf{i}})|_{\pi(y_n)}) \\ &= d_h(g_n(P), \partial_v T_{\mathbf{k}_n, \mathbf{i}}|_{\pi(y_n)}), \end{aligned} \quad (6.7)$$

and $T_{\mathbf{k}_n}|_{\pi(y_n)}$ (the restriction of $T_{\mathbf{k}_n}$ on the hyperplane $\pi(y_n)$) is a unit hypercube. Recall that

$$T_{\mathbf{k}_n} = \bigcup_{0 \leq y - \varphi_r(\mathbf{k}_n) \leq r^{-n}} \left(U + \frac{y - \varphi_r(\mathbf{k}_n)}{r^{-n}} \mathbf{t}_{n+1} \right) \times \{y - \varphi_r(\mathbf{k}_n)\} + \mathbf{w}(\mathbf{k}_n). \quad (6.8)$$

Before the proof, we state some facts which will help to clarify our idea. It follows from the formula $h_n(T_{\mathbf{k}_{n-1}}) = \cup_{k=0}^{r-1} T_{\mathbf{k}_{n-1}k}$ that with respect to h_n , $T_{\mathbf{k}_n}$ is a subset of the image $h_n(T_{\mathbf{k}_{n-1}})$ and $T_{\mathbf{k}_{n-1}}$ is the inverse image $h_n^{-1}(\cup_{k=0}^{r-1} T_{\mathbf{k}_{n-1}k})$. Also, the range of height of $T_{\mathbf{k}_n}$ is $[0, r^{-n}] + \varphi_r(\mathbf{k}_n)$.

We now divided the proof into three cases: (i) $P \notin \partial_v T_\emptyset$, (ii) $P \in T_{\emptyset, \mathbf{i}}$ and (iii) $P \in \partial_v T_\emptyset \setminus T_{\emptyset, \mathbf{i}}$.

Case 1. $P \notin \partial_v T_\emptyset$. In this case, Proposition 4.9(2), together with Lemma 5.6, implies that for $n \geq 1$,

$$d_h(g_n(P), g_n(\partial_v T_\emptyset)) \geq \lambda_2 d_h(P, \partial_v T_\emptyset) > 0.$$

In order to estimate the value

$$d_h(h_\infty(P), h_\infty(\partial_v T_{\emptyset, \mathbf{i}})) = d_h(h_\infty(P), h_\infty(\partial_v T_{\emptyset, \mathbf{i}})|_{\pi(y_\infty)}), \quad (6.9)$$

we let $P'_\infty = (\mathbf{x}'_\infty, y_\infty) \in h_\infty(\partial_v T_\emptyset)$ be fixed. So there exists $P' = (\mathbf{x}', y')$ $\in \partial_v T_\emptyset$ such that $P'_\infty = h_\infty(P')$. For $n \geq 1$, let

$$(\mathbf{x}'_n, y'_n) := g_n(P'),$$

which belongs to $g_n(\partial_v T_\emptyset)$. By Lemma 5.5, we see that, for each $n \geq 1$, $y'_n \in (0, r^{-n}) + \varphi_r(\mathbf{k}_n)$ which might not equal y_n . In order to apply the quantity

$$d_h(g_n(P), g_n(\partial_v T_\emptyset)) = d_h(g_n(P), \partial_v T_{\mathbf{k}_n} |_{\pi(y_n)}),$$

we will choose (based on $g_n(P')$) another point $P''_n \in \partial_v T_{\mathbf{k}_n}$, which satisfies $\mathcal{P}_v(P''_n) = y_n$ and the difference in norm $\|\cdot\|_\infty$ between the horizontal coordinates of $g_n(P)$ and P''_n is $o(1)$ as $n \rightarrow \infty$. Since $g_n(P') \in \partial_v T_{\mathbf{k}_n}$, it follows from (6.8) that there exists $\mathbf{y} \in \partial U$ such that

$$\mathbf{x}'_n = \frac{y'_n - \varphi_r(\mathbf{k}_n)}{r^{-n}} \mathbf{t}_{n+1} + \mathbf{y} + \mathbf{b}(\mathbf{k}_n) + 2^{-1} \mathbf{1}_{d-1}. \quad (6.10)$$

Let $P''_n = (\mathbf{x}''_n, y_n) \in \partial_v T_{\mathbf{k}_n}$, where

$$\mathbf{x}''_n = \frac{y_n - \varphi_r(\mathbf{k}_n)}{r^{-n}} \mathbf{t}_{n+1} + \mathbf{y} + \mathbf{b}(\mathbf{k}_n) + 2^{-1} \mathbf{1}_{d-1}. \quad (6.11)$$

Using (6.10), (6.11) and the fact that $y_n, y'_n \in [0, r^{-n}] + \varphi_r(\mathbf{k}_n)$, we get

$$\|\mathbf{x}'_n - \mathbf{x}''_n\|_\infty = \frac{|y_n - y'_n|}{r^{-n}} \|\mathbf{t}_{n+1}\|_\infty \leq \|\mathbf{t}_{n+1}\|_\infty = o(1).$$

The last equality follows from Lemma 5.6(2). Next, we estimate the difference in norm $\|\cdot\|_\infty$ between the horizontal coordinates of $h_\infty(P)$ and $g_n(P)$. From (5.33), we get

$$\begin{aligned} \|\mathbf{x}_\infty - \mathbf{x}_n\|_\infty &\leq \|h_\infty(P) - g_n(P)\|_\infty \\ &= \lim_{m \rightarrow +\infty} \|h_m \circ \cdots \circ h_{n+1}(g_n(P)) - g_n(P)\|_\infty \\ &\leq \sum_{m \geq n} \|h_{m+1}(g_m(P)) - g_m(P)\|_\infty \\ &\leq \sum_{m \geq n} (c_m \|g_m(P)\|_\infty + 2(a+s+2)c_m + \|\mathbf{t}_m\|_\infty + \varepsilon_m) \\ &= o(1). \end{aligned}$$

The last equality holds because $\sum_{n \geq 1} (c_n + \|\mathbf{t}_n\|_\infty + \varepsilon_n)$ converges and $\{g_n(P)\}$ is a Cauchy's sequence. Analogously, we have

$$\|\mathbf{x}'_\infty - \mathbf{x}'_n\|_\infty \leq \|h_\infty(P') - g_n(P')\|_\infty = o(1) \quad \text{as } n \rightarrow \infty.$$

Recall that $P_\infty = (\mathbf{x}_\infty, y_\infty)$, $P'_\infty = (\mathbf{x}'_\infty, y_\infty)$, and $g_n(P') = (\mathbf{x}'_n, y'_n)$; moreover, $g_n(P) = (\mathbf{x}_n, y_n)$ and $g_n(P'') = (\mathbf{x}''_n, y_n)$ have the same height. The discussion above yields, for n sufficiently large,

$$\|\mathbf{x}_\infty - \mathbf{x}_n\|_\infty + \|\mathbf{x}'_\infty - \mathbf{x}'_n\|_\infty + \|\mathbf{x}'_n - \mathbf{x}''_n\|_\infty < \frac{1}{2} \lambda_2 d_h(P, \partial_v T_\emptyset).$$

Now, for such n (see Figure 17),

$$\begin{aligned}
 d_h(h_\infty(P), P'_\infty) &= \|\mathbf{x}_\infty - \mathbf{x}'_\infty\|_\infty \\
 &= \|\mathbf{x}_\infty - \mathbf{x}_n + \mathbf{x}_n - \mathbf{x}''_n + \mathbf{x}''_n - \mathbf{x}'_n + \mathbf{x}'_n - \mathbf{x}'_\infty\|_\infty \\
 &\geq \|\mathbf{x}_n - \mathbf{x}''_n\|_\infty - \|\mathbf{x}_\infty - \mathbf{x}_n\|_\infty - \|\mathbf{x}'_\infty - \mathbf{x}'_n\|_\infty - \|\mathbf{x}'_n - \mathbf{x}''_n\|_\infty \\
 &> \|g_n(P) - g_n(P'')\|_\infty - \frac{1}{2}\lambda_2 d_h(P, \partial_v T_\emptyset) \\
 &\geq d_h(g_n(P), g_n(\partial_v T_\emptyset)) - \frac{1}{2}\lambda_2 d_h(P, \partial_v T_\emptyset) \geq \frac{1}{2}d_h(P, \partial_v T_\emptyset),
 \end{aligned}$$

where the last inequality follows from (6.9). Since $P'_\infty \in h_\infty(\partial_v T_\emptyset)$ was arbitrary, we get

$$d_h(h_\infty(P), h_\infty(\partial_v T_\emptyset)) > 0.$$

Now, for each $\mathbf{i} \in \{-1, 0, 1\}^{d-1}$, we have $\partial_v T_{\emptyset, \mathbf{i}} \subset \partial T_\emptyset$, which implies that

$$d_h(h_\infty(P), h_\infty(\partial_v T_{\emptyset, \mathbf{i}})) \geq d_h(h_\infty(P), h_\infty(\partial_v T_\emptyset)) > 0.$$

Case 2. $P \in T_{\emptyset, \mathbf{i}}$. In this case $P \in \text{int}_v T_{\emptyset, \mathbf{i}}$. Proposition 4.9(3) and Lemma 5.6 imply that

$$d_h(g_n(P), g_n(\partial_v T_{\emptyset, \mathbf{i}})) \geq \lambda_2 d_h(P, \partial_v T_{\emptyset, \mathbf{i}}).$$

For a fixed $P'_\infty \in h_\infty(\partial_v T_{\emptyset, \mathbf{i}})$ with height y_∞ , we let $g_n(P')$, $g_n(P'')$ be as in Case 1, with $T_{\emptyset, \mathbf{i}}$ replacing T_\emptyset . A proof analogous to that for Case 1 forces $d_h(h_\infty(P), h_\infty(\partial_v T_{\emptyset, \mathbf{i}})) > 0$.

Case 3. $P \in \partial_v T_\emptyset \setminus T_{\emptyset, \mathbf{i}}$. Since $P = (\mathbf{x}, y) \in \partial_v T_\emptyset$, by using the expression for T_\emptyset in (5.17), we see that there exists $\mathbf{y} \in \partial U$ and $y \in [0, 1]$ such that

$$P = (\mathbf{y} + \mathbf{y}\mathbf{t}_1, y) + 2^{-1}(\mathbf{1}_{d-1}, 0).$$

Let $\mathbf{j} = (j_1, \dots, j_{d-1}) \in \{-1, 0, 1\}^{d-1}$, where the m th component of \mathbf{j} is defined as

$$j_m = \begin{cases} 2\omega_m(\mathbf{y}), & 2\omega_m(\mathbf{y}) = \pm 1; \\ 0, & 2\omega_m(\mathbf{y}) \in (-1, 1). \end{cases}$$

Let $(\mathbf{x}_n, y_n) := g_n(P)$. In view of (6.8) and the expression for $T_{\mathbf{k}_n}$, we get

$$\mathbf{x}_n \in U_{\mathbf{j}} + \mathbf{z} \quad \text{and} \quad T_{\mathbf{k}_n, \mathbf{i}}|_{\pi(y_n)} = (U_{\mathbf{i}} + \mathbf{z}) \times \{y_n\}, \quad (6.12)$$

where

$$\mathbf{z} = \frac{y_n - \varphi_r \mathbf{k}_n}{r^{-n}} \mathbf{t}_{n+1} + \mathbf{b}(\mathbf{k}_n) + 2^{-1} \mathbf{1}_{d-1}.$$

From $P \in \partial_v T_\emptyset$, we know that $P \in \text{int}_v T_{\emptyset, \mathbf{j}}$ if \mathbf{j} has a zero component, while $P \in \partial_v T_{\emptyset, \mathbf{j}}$ if all components of \mathbf{j} are nonzero. Define

$$\Gamma_1 := \{m : i_m = -j_m \neq 0\},$$

$$\Gamma_2 := \{m : i_m = 0, j_m \neq 0\},$$

$$\Gamma_3 := \{m : i_m \neq 0, j_m = 0\}.$$

Then the assumption $P \notin T_{\emptyset,i}$ implies that $\Gamma_1 \cup \Gamma_2 \cup \Gamma_3 \neq \emptyset$. When $\Gamma_1 \neq \emptyset$, (6.12) says that for any $m \in \Gamma_1$ and any $\mathbf{y}' \in U_i$,

$$\|(\mathbf{x}_n - z) - \mathbf{y}'\|_\infty \geq |\omega_m(\mathbf{x}_n - z) - \omega_m(\mathbf{y}')| = \left| \frac{1}{2}i_m - \frac{1}{2}j_m \right| = 1.$$

This, together with (6.7), implies that

$$\|d_h(g_n(P), g_n(T_{\emptyset,i}))\| \geq \min\{\|(\mathbf{x}_n - z) - \mathbf{y}'\|_\infty : \mathbf{y}' \in U_i\} = 1.$$

Similar to Case 1, we get

$$\|d_h(h_\infty(P), h_\infty(T_{\emptyset,i}))\| > 0.$$

Next, we assume $\Gamma_1 = \emptyset$. It follows that $\Gamma_3 \neq \emptyset$, since $T_{\emptyset,j} \subset \partial_v T_{\emptyset,i}$ when $\Gamma_3 = \emptyset$. If $\Gamma_2 = \emptyset$, we see that $P \in \text{int}_v T_{\emptyset,j}$ and $T_{\emptyset,i} \subset \partial_v T_{\emptyset,j}$. From Case 2, we get

$$d_h(h_\infty(P), h_\infty(T_{\emptyset,i})) \geq d_h(h_\infty(P), h_\infty(\partial_v T_{\emptyset,j})) > 0.$$

Finally, we consider the case $\Gamma_1 = \emptyset$ and $\Gamma_2 \neq \emptyset$. We delete all components of vectors in \mathbb{R}^d whose indices are in Γ_2 , and obtain a system with lower dimension. For example, suppose $P = (x_1, \dots, x_{d-1}, y) \in \mathbb{R}^d$ and $\Gamma_2 = \{d-1\}$. Then we delete the $(d-1)$ th component of P and get a new point (x_1, \dots, x_{d-2}, y) . For convenience, we use the original notation. Then in the new system, $P \in \text{int}_v T_{\emptyset,j}$ and $T_{\emptyset,i} \subset \partial_v T_{\emptyset,j}$. Now similar to Case 2, we obtain

$$d_h(h_\infty(P), h_\infty(T_{\emptyset,i})) \geq d_h(h_\infty(P), h_\infty(\partial_v T_{\emptyset,j})) > 0.$$

This completes the proof. □

Lemma 6.3. *Let h_∞ be defined as in (6.1). If $c_1 < 1/4$, then h_∞ is injective on $\partial_v T_\emptyset$.*

Proof. We suppose on the contrary that h_∞ is not injective on $\partial_v T_\emptyset$, i.e., there exist two distinct points $P = (\mathbf{x}, y), P' = (\mathbf{x}', y')$ in $\partial_v T_\emptyset$ satisfying $h_\infty(P) = h_\infty(P')$. Let P_∞, P'_∞ be given as in (6.5) and assume that the coordinates of $g_n(P)$ and $g_n(P')$ are given as in (6.4). We first prove the following claim.

Claim. *For any $n \geq 1$, the following statements hold: (i) $|y_n - y'_n| < r^{-n}$; (ii) neither y_n nor y'_n is in Y_n ; (iii) there does not exist $y_0 \in Y_n$ that lies between y_n and y'_n .*

To prove the claim, we note that if conclusion (i) fails, then there would exist some $N > 0$ such that

$$|y_N - y'_N| \geq \frac{1}{r^N}.$$

Hence by (5.32) and (5.11),

$$\begin{aligned} |y_\infty - y'_\infty| &= \left| \left(y_N + \sum_{n \geq N} (y_{n+1} - y_n) \right) - \left(y'_N + \sum_{n \geq N} (y'_{n+1} - y'_n) \right) \right| \\ &\geq |y_N - y'_N| - \sum_{n \geq N} |y_{n+1} - y_n| - \sum_{n \geq N} |y'_{n+1} - y'_n| \\ &\geq \frac{1}{r^N} - 2 \sum_{n \geq N} \varepsilon_n \geq \frac{1}{r^N} - \frac{2}{3} \sum_{n \geq N} \frac{1}{r^{2n}} > 0, \end{aligned}$$

which is impossible, since $P_\infty = P'_\infty$, $y_\infty = \mathcal{P}_v(P_\infty)$, and $y'_\infty = \mathcal{P}_v(P'_\infty)$.

If conclusion (ii) fails, we assume $y_N \in Y_N$ for some N . It follows that $P_\infty = g_n(P) = g_N(P)$ for all $n \geq N$. If there exists some $N' > 0$ such that $y'_{N'} \in Y_{N'}$, then $h_\infty(P') = g_n(P')$ for $n > \max\{N, N'\}$. The injectivity of g_n implies that $P_\infty \neq P'_\infty$. It follows from Lemma 5.5 and conclusion (i) that for each $n > N$, there exists $\mathbf{k}_n \in \Sigma_r^n$ such that

$$g_n(P), g_n(P') \in \mathbb{R}^{d-1} \times ([0, r^{-n}] + \varphi_r(\mathbf{k}_n))$$

and $y_N = \varphi_r(\mathbf{k}_n)$ or $y_N = \varphi_r(\mathbf{k}_n) + r^{1-n}$. So,

$$d_v(g_n(P), g_n(P')) = d_v\left(g_n(P'), \pi(\varphi_r(\mathbf{k}_n)) \cup \pi(\varphi_r(\mathbf{k}_n) + r^{-n})\right) < \frac{1}{r^n}. \quad (6.13)$$

Proposition 4.9(4-ii) says that

$$d_v(g_n(P), g_n(P')) \geq d_v(g_{n-1}(P), g_{n-1}(P')) \geq \cdots \geq d_v(g_N(P), g_N(P')),$$

which is positive, since P'_N does not lie in the hyperplane $\pi(y_N)$. Letting n tend to infinity, we see that $P_\infty \neq P'_\infty$, a contradiction.

If conclusion (iii) fails, there exist $N > 0$ and $y_0 \in Y_N$ that lies between y_N and y'_N . Without loss of generality, assume $y_N > y'_N$. By Lemma 5.5 again, we see that

$$y'_n < y_0 < y_n \quad \text{for } n \geq N.$$

From the proof for conclusion (ii), we get, for $n > N$,

$$d_v(g_n(P), g_n(P')) \geq d_v(g_n(P), \pi(y_0)) \geq d_v(g_N(P), \pi(y_0)),$$

which is impossible, since

$$\lim_{n \rightarrow +\infty} d_v(g_n(P), g_n(P')) = d_v(P_\infty, P'_\infty) = 0.$$

This proves the claim.

We now use this claim to prove the lemma. Recall $\mathbf{1}_{d-1} = (1, \dots, 1) \in \mathbb{R}^{d-1}$. Since $P, P' \in \partial_v T_\emptyset$, there exist $\mathbf{y}, \mathbf{y}' \in \partial U$ such that

$$\mathbf{x} = \mathbf{y} + \mathbf{y}t_1 + 2^{-1}\mathbf{1}_{d-1} \quad \text{and} \quad \mathbf{x}' = \mathbf{y}' + \mathbf{y}'t_1 + 2^{-1}\mathbf{1}_{d-1}.$$

From \mathbf{y}, \mathbf{y}' , we define two words $\mathbf{j} = j_1 \dots j_{d-1}, \mathbf{i} = i_1 \dots i_{d-1} \in \{-1, 0, 1\}^{d-1}$ as follows

$$j_m := \begin{cases} 2\omega_m(\mathbf{y}), & 2\omega_m(\mathbf{y}) = \pm 1; \\ 0, & 2\omega_m(\mathbf{y}) \in (-1, 1), \end{cases} \quad i_m := \begin{cases} 2\omega_m(\mathbf{y}'), & 2\omega_m(\mathbf{y}') = \pm 1; \\ 0, & 2\omega_m(\mathbf{y}') \in (-1, 1), \end{cases}$$

and define

$$\begin{aligned} \Delta_1 &:= \{m : j_m = -i_m \neq 0\}, \\ \Delta_2 &:= \{m : j_m = 0, i_m \neq 0\}, \\ \Delta_3 &:= \{m : j_m \neq 0, i_m = 0\}. \end{aligned}$$

Assume $\mathbf{i} \neq \mathbf{j}$ so that $\Delta_1 \cup \Delta_2 \cup \Delta_3 \neq \emptyset$. By interchanging the roles of P and P' if necessary, it suffices to consider the following two cases: (i) $\Delta_1 \neq \emptyset$ and (ii) $\Delta_1 = \emptyset$ but $\Delta_3 \neq \emptyset$. However, in both cases we have shown in Case 3 of the proof of Lemma 6.2 that

$$d_h(P_\infty, P'_\infty) \geq d_h(h_\infty(P), h_\infty(T_{\emptyset, \mathbf{i}})) > 0,$$

a contradiction.

We now assume $\mathbf{j} = \mathbf{i}$. Note that either $P, P' \in \partial_v T_{\emptyset, \mathbf{j}}$ or $P, P' \in \text{int}_v T_{\emptyset, \mathbf{j}}$. If $P, P' \in \partial_v T_{\emptyset, \mathbf{j}}$, which means that all components of \mathbf{j} are nonzero, we see that $\mathbf{y} = \mathbf{y}'$ and $y \neq y'$, since $P \neq P'$. The above claim, together with Proposition 4.9(4)(ii), implies that for all $n \geq 1$,

$$\begin{aligned} d_v(g_n(P), g_n(P')) &\geq d_v(g_{n-1}(P), g_{n-1}(P')) \\ &\geq \dots \geq d_v(P, P') \\ &= |y - y'| > 0, \end{aligned}$$

which contradicts the hypothesis $P_\infty = P'_\infty$. Now, we show the remaining case that $P, P' \in \text{int}_v T_{\emptyset, \mathbf{j}}$. The assumption $c_1 < 4^{-1}$ implies $c_n < 4^{-1}$ for all n . Let λ_2 be given as in (5.29). Then Proposition 4.9(3) implies that there exists sufficiently large $N > 0$ such that, for $n \geq N$, the horizontal distance between $g_n(P)$ and $g_n(\partial_v T_{\emptyset, \mathbf{j}})$ is no less than $\lambda_2 d_h(P, \partial_v T_{\emptyset, \mathbf{j}})$, which is larger than $2c_n$ since $c_n = o(1)$ by Lemma 5.6, i.e.,

$$d_h(g_n(P), g_n(\partial_v T_{\emptyset, \mathbf{j}})) > 2c_n \quad \text{for all } n \geq N.$$

Analogously, we have $d_h(g_n(P'), g_n(\partial_v T_{\emptyset, \mathbf{j}})) > 2c_n$ for $n \geq N$. Now, Proposition 4.9(4)(ii), or more precisely (4.30), says that

$$d_v(g_n(P), g_n(P')) \geq d_v(g_N(P), g_N(P')).$$

Letting n tend to infinity, we get

$$0 = d_v(h_\infty(P), h_\infty(P')) = \lim_{n \rightarrow \infty} d_v(g_n(P), g_n(P')) \geq d_v(g_N(P), g_N(P')).$$

So, for $n \geq N$, $g_n(P)$ and $g_n(P')$ have the same height. Proposition 4.9(4)(ii) or (4.29), together with Lemma 3.3, implies that

$$d_h(P_\infty, P'_\infty) = \lim_{n \rightarrow +\infty} d_h(g_n(P), g_n(P')) \geq \lambda_2 d_h(g_N(P), g_N(P')) > 0,$$

which is a contradiction. Hence h_∞ is injective on $\partial_v T_\emptyset$. \square

Lemma 6.4. *Let h_∞ be defined as in (6.1) and assume $c_1 < 1/4$. Then h_∞ is injective on \mathbb{R}^d .*

Proof. Since h_∞ is an identity on $\mathbb{R}^{d-1} \times (\mathbb{R} \setminus (0, 1))$, we only study the behavior of h_∞ on the region $\mathbb{R}^{d-1} \times [0, 1]$. From Lemmas 6.2 and 6.3, we need to show that h_∞ is injective on

$$(\mathbb{R}^{d-1} \times [0, 1]) \setminus \partial_v T_\emptyset.$$

For this purpose, we let $P, P' \in \mathbb{R}^{d-1} \times [0, 1]$ be two distinct points which are not in $\partial_v T_\emptyset$. From Proposition 4.9(2), we get, for $n \geq 1$,

$$d_h(g_n(P), g_n(\partial_v T_\emptyset)) \geq \prod_{m=1}^n (1 - c_m)^{2/\eta_m} d_h(P, \partial_v T_\emptyset) > \lambda_2 d_h(P, \partial_v T_\emptyset).$$

By the definitions of $\{c_n\}$ and $\{\eta_n\}$, $(1 + 2\eta_n + 4c_n)^2 - 1 = o(1)$ and $c_n = o(1)$. Hence, there exists an $N_1 > 0$ such that for $n > N_1$,

$$d_h(g_n(P), g_n(\partial_v T_\emptyset)) > \frac{1}{2} \left(1 + 2\eta_n + 4c_n\right)^2 - \frac{1}{2} \geq c_n.$$

Hence, all the $g_n(P)$ with $n > N_1$ have the same height. Similarly, there exists $N_2 > 0$ such that all the $g_n(P')$ with $n > N_2$ have the same height. Let $N = N_1 + N_2$. If $g_N(P)$ and $g_N(P')$ have different heights, we get

$$d_v(P_\infty, P'_\infty) = |\mathcal{P}_v(g_N(P)) - \mathcal{P}_v(g_N(P'))| > 0.$$

If $g_N(P)$ and $g_N(P')$ have the same height, then

$$\begin{aligned} & d_h(P_\infty, P'_\infty) \\ &= d_h\left(\lim_{n \rightarrow +\infty} h_n \circ \cdots \circ h_{N+1}(g_N(P)), \lim_{n \rightarrow +\infty} h_n \circ \cdots \circ h_{N+1}(g_N(P'))\right) \\ &= \lim_{n \rightarrow +\infty} d_h(h_n \circ \cdots \circ h_{N+1}(g_N(P)), h_n \circ \cdots \circ h_{N+1}(g_N(P'))) \\ &\geq \lambda_2 d_h(g_N(P), g_N(P')), \end{aligned}$$

where the second equality follows from Lemma 3.3, and the inequality follows from (4.29) and Lemma 5.6. Since each g_n is injective, the right side of the last inequality above is positive. In both cases, we see that $P_\infty \neq P'_\infty$. This completes the proof that h_∞ is injective on \mathbb{R}^d . \square

We now return to the proof of Theorem 5.1.

Proof of Theorem 5.1. Since (2) implies (1), and in [12] we have shown that (1) is equivalent to (3), we only need to prove that (3) implies (2). By (3), we know that all $\mathbf{u}_{n,k}$ belong to $2U^\circ$, so the map h_∞ in (6.1) is a well-defined continuous surjection on \mathbb{R}^d (Lemma 6.1), mapping T_\emptyset onto T (Lemmas 5.4 and 5.5). If $c_1 < 1/4$, Lemma 6.4 says that h_∞ is injective on \mathbb{R}^d . So by Brouwer's domain invariance theorem (Theorem 1.7), h_∞ is a homeomorphism on \mathbb{R}^d , which implies that $T = h_\infty(T_\emptyset)$ is a d -dimensional tame ball. If $c_1 \geq 1/4$, we can choose N sufficiently large so that $c_N < 1/4$ (Lemma 5.6(3)). For each $\mathbf{k} \in \Sigma_r^{N-1}$, we apply Lemma 6.4 on $T_{\mathbf{k}}$ to prove that $h_{\mathbf{k},\infty}(T_{\mathbf{k}})$ is a d -dimensional tame ball, where $h_{\mathbf{k},\infty}$ is defined as

$$h_{\mathbf{k},\infty}(P) := \begin{cases} \lim_{n \rightarrow +\infty} h_n \circ \cdots \circ h_N(P), & \mathcal{P}_v(P) - \varphi_r(\mathbf{k}) \in [0, r^{N-1}]; \\ P, & \text{otherwise.} \end{cases}$$

Note that if two sets $h_{\mathbf{k}_1,\infty}(T_{\mathbf{k}_1})$ and $h_{\mathbf{k}_2,\infty}(T_{\mathbf{k}_2})$ intersect, the intersection is a $(d-1)$ -dimensional hypercube. So

$$\begin{aligned} T &= \left\{ \left(\mathbf{b}(\mathbf{k}) + (\varphi_{p_1}(\mathbf{i}_1), \dots, \varphi_{p_{d-1}}(\mathbf{i}_{d-1})), \varphi_r(\mathbf{k}) \right) : \mathbf{i}_j \in \Sigma_{p_j}^{\mathbb{N}}, \mathbf{k} \in \Sigma_r^{\mathbb{N}} \right\} \\ &= \bigcup_{\mathbf{k} \in \Sigma_r^{N-1}} \left\{ \left(\mathbf{b}(\mathbf{k}\mathbf{k}') + (\varphi_{p_1}(\mathbf{i}_1), \dots, \varphi_{p_{d-1}}(\mathbf{i}_{d-1})), \varphi_r(\mathbf{k}\mathbf{k}') \right) : \right. \\ &\quad \left. \mathbf{i}_j \in \Sigma_{p_j}^{\mathbb{N}}, \mathbf{k}' \in \Sigma_r^{\mathbb{N}} \right\} \\ &= \bigcup_{\mathbf{k} \in \Sigma_r^{N-1}} h_{\mathbf{k},\infty}(T_{\mathbf{k}}) \end{aligned}$$

is a d -dimensional tame ball. This completes the proof. \square

7. FINAL COMMENTS

In [11], the authors of the present paper used a cut-and-paste technique to obtain a necessary and sufficient condition for a class of self-affine tiles $T \subset \mathbb{R}^3$ to be ball-like, under the assumption that $st \geq 0$ (see Theorem 1.3). If $st < 0$, this cut-and-paste technique fails, as T cannot be expressed as a limit of the union of basic blocks. Perhaps by suitably modifying the construction of basic blocks, the restriction $st \geq 0$ can be removed.

Using the techniques in this paper, i.e., re-constructing the self-affine tile by an iterating process and defining a homeomorphism on \mathbb{R}^3 associated to each step of the iteration, we think that the following more general conjecture is true.

Conjecture 7.1. *Let (A, \mathcal{D}) be given as follows:*

$$A := \begin{pmatrix} p & 0 & 0 \\ 0 & q & 0 \\ -t & -s & r \end{pmatrix}$$

and

$$\mathcal{D} := \{(i, j, k + a_i + b_j) : 0 \leq i < |p|, 0 \leq j < |q|, 0 \leq k < |r|\},$$

where p, q, r are integers not less than 2 in absolute value and s, t, a_i, b_j are real numbers. If for all i, j ,

$$\left| \frac{a_{|p|-1} - a_\infty + t}{r(r-1)} + \frac{a_i - a_{i+1}}{r} \right| + \left| \frac{b_{|q|-1} - b_\infty + s}{r(r-1)} + \frac{b_j - b_{j+1}}{r} \right| < 1,$$

then $T = T(A, \mathcal{D})$ is a tame ball in \mathbb{R}^3 .

Acknowledgements. Part of this work was carried out when the first two authors were visiting the Department of Mathematical Sciences of Georgia Southern University. They thank the Department for its hospitality and support. The authors are indebted to Xi-anhong Chen for many helpful discussions and for pointing out the relevance of the Brouwer's invariance of domain theorem, which plays a key role in the paper. The authors thank the anonymous referee for some helpful comments and suggestions.

REFERENCES

- [1] S. Akiyama and N. Gjini, On the connectedness of self-affine attractors, *Arch. Math.* **82** (2004), 153–63.
- [2] S. Akiyama and J. Thuswaldner, Topological properties of two-dimensional number systems, *J. Théor. Nombres. Bordx.* **12** (2000), 69–79.
- [3] S. Akiyama and J. Thuswaldner, On the topological structure of fractal tilings generated by quadratic number systems, *Comput. Math. Appl.* **49** (2005), 1439–1485.
- [4] C. Bandt, Combinatorial topology of three-dimensional self-affine tiles, (preprint) <http://arxiv.org/pdf/1002.0710.pdf>.
- [5] C. Bandt and M. Mésing, Self-affine fractals of finite type, *Banach Center Publ.*, **84** (2009), 131–148.
- [6] C. Bandt and Y. Wang, Disk-like self-affine tiles in \mathbb{R}^2 , *Discrete Comput. Geom.* **26** (2001), 591–601.
- [7] M.F. Barnsley, *Fractals everywhere, 2nd ed.* Academic Press Professional, Boston, MA (1993). Revised with the assistance of and with a foreword by Hawley Rising, III.
- [8] L.E.J. Brouwer, Zur invarianz des n -dimensionalen gebiets, *Math. Ann.* **72** (1912), 55–56.
- [9] G.R. Conner and J.M. Thuswaldner, Self-affine manifolds, *Adv. Math.* **289** (2016), 725–783.
- [10] D.-W. Deng, T. Jiang and S.-M. Ngai, Structure of planar integral self-affine tilings, *Math. Nachr.* **285** (2012), 447–475.
- [11] G.T. Deng, C.T. Liu and S.-M. Ngai, Topological properties of a class of self-affine tiles in \mathbb{R}^3 , *Trans. Amer. Math. Soc.* **370** (2018), 1321–1350.
- [12] G.T. Deng, C.T. Liu and S.-M. Ngai, Topological properties of a class of higher-dimensional self-affine tiles, *Canad. Math. Bull.* **62** (2019), 727–740.
- [13] Q.R. Deng and K.S. Lau, Connectedness of a class of planar self-affine tiles, *J. Math. Anal. Appl.* **380**(2) (2011), 493–500.
- [14] K. Falconer, *Fractal geometry: Mathematical foundations and applications*, John Wiley & Sons, Inc., Hoboken, NJ, 2003.
- [15] G. Gelbrich, Self-affine lattice reptiles with two pieces in \mathbb{R}^n , *Math. Nachr.* **178** (1996), 129–134.
- [16] W.J. Gilbert, Radix representations of quadratic number fields, *J. Math. Anal. Appl.* **83** (1981), 263–274.

- [17] M. Hata, On the structure of self-similar sets, *Japan J. Appl. Math.* **2** (1985), 381–414.
- [18] X.G. He, I. Kirat and K.S. Lau, Height reducing property of polynomials and self-affine tiles, *Geom. Dedicata* **152** (2011), 153–164.
- [19] J.E. Hutchinson, Fractals and self-similarity, *Indiana Univ. Math. J.* **30** (1981), 713–747.
- [20] T. Kamae, J. Luo and B. Tan, A gluing lemma for iterated function systems, *Fractals* **23** (2015), 1550019.
- [21] I. Kátai and I. Környei, On number systems in algebraic number fields, *Publ. Math. Debrecen* **41** (1992), 289–294.
- [22] R. Kenyon, Self-replicating tilings, *symbolic dynamics and its applications* (New Haven, CT, 1991), Contemp. Math., 135, Amer. Math. Soc., Providence, RI, 1992, 239–263.
- [23] I. Kirat and K.S. Lau, On the connectedness of self-affine tiles, *J. Lond. Math. Soc. (2)* **62** (2000), 291–304.
- [24] I. Kirat, K.S. Lau and H. Rao, Expanding polynomials and connectedness of self-affine tiles, *Discrete Comput. Geom.* **31** (2004), 275–286.
- [25] B. Kovács and A. Pethő, Number systems in integral domains, especially in orders of algebraic number fields, *Acta Sci. Math. Szeged* **55** (1991), 287–299.
- [26] J.C. Lagarias and Y. Wang, Self-affine tiles in \mathbb{R}^n , *Adv. Math.* **121** (1996), 21–49.
- [27] J.C. Lagarias and Y. Wang, Integral self-affine tiles in \mathbb{R}^n I. Standard and nonstandard digit sets, *J. Lond. Math. Soc.* **54** (1996), 161–179.
- [28] J.C. Lagarias and Y. Wang, Integral self-affine tiles in \mathbb{R}^n II. Lattice tilings, *J. Fourier Anal. Appl.* **3** (1997), 83–102.
- [29] K.S. Leung and K.S. Lau, Disklikeness of planar self-affine tiles, *Trans. Amer. Math. Soc.* **359** (2007), 3337–3355.
- [30] K.S. Leung and J.J. Luo, Connectedness of planar self-affine sets associated with non-consecutive collinear digit sets, *J. Math. Anal. Appl.* **395** (2012), 208–217.
- [31] K.S. Leung and J.J. Luo, Connectedness of planar self-affine sets associated with non-collinear digit sets, *Geom. Dedicata* **175** (2015), 145–157.
- [32] J.C. Liu, J.J. Luo and H. Xie, On the connectedness of planar self-affine sets, *Chaos Soliton Fract.* **69** (2014), 107–116.
- [33] J.C. Liu, J.J. Luo and K. Tang, Connectedness of self-affine sets with product digit sets, *Fractals* **25** (2017), 1750053.
- [34] J. Liu, S.-M. Ngai and J. Tao, Connectedness of a class of two-dimensional self-affine tiles associated with triangular matrices, *J. Math. Anal. Appl.* **435** (2016), 1499–1513.
- [35] J. Luo, H. Rao and B. Tan, Topological structure of self-similar sets, *Fractals* **10** (2002), 223–227.
- [36] Y. Ma, X.-H. Dong and Q.-R. Deng, The connectedness of some two-dimensional self-affine sets, *J. Math. Anal. Appl.* **420** (2014), 1604–1616.
- [37] J. Thuswaldner and S.Q. Zhang, On self-affine tiles whose boundary is a sphere, *Trans. Amer. Math. Soc.* **373** (2020), 491–527.
- [38] Y. Wang, Self-affine tiles, *Advances in Wavelets* (Hong Kong, 1997), 261–282, Springer, Singapore, 1999.