

Pyrit: A Finite Element Based Field Simulation Software Written in Python

Jonas Bundschuh^{*,†}, M. Greta Ruppert^{*,†} and Yvonne Späck-Leigsnering^{*,†}

^{*}Institut für Teilchenbeschleunigung und Elektromagnetische Felder (TEMF), TU Darmstadt, Germany

[†]Graduate School of Excellence Computational Engineering, 64293 Darmstadt, Germany

E-mail: jonas.bundschuh@tu-darmstadt.de

Abstract

Purpose — The purpose of this paper is to present the freely available finite element simulation software *Pyrit*.

Design/methodology/approach — In a first step, the design principles and the objective of the software project are defined. Then, the software's structure is established: The software is organized in packages for which an overview is given. The structure is based on the typical steps of a simulation workflow, i.e., problem definition, problem solving and post-processing. State-of-the-art software engineering principles are applied to ensure a high code quality at all times. Finally, the modeling and simulation workflow of *Pyrit* is demonstrated by three examples.

Findings — *Pyrit* is a field simulation software based on the finite element method written in Python to solve coupled systems of partial differential equations. It is designed as a modular software that is easily modifiable and extendable. The framework can, therefore, be adapted to various activities, i.e., research, education and industry collaboration.

Research limitations/implications — The focus of *Pyrit* are static and quasistatic electromagnetic problems as well as (coupled) heat conduction problems. It allows for both time domain as well as frequency domain simulations.

Originality/value — In research, problem specific modifications and direct access to the source code of simulation tools are essential. With *Pyrit*, the authors present a computationally efficient and platform-independent simulation software for various electromagnetic and thermal field problems.

Keywords — Finite element method, computational electromagnetics, coupled systems, field circuit models

Paper type — Research paper

I. INTRODUCTION

Today, electromagnetic (EM) field simulation software is essential for the design of electric equipment, e.g., electric power converters and transmission systems, electronics and particle accelerator components. Many different tools for EM field simulation based on the finite-element (FE) method have been developed over time. Commercial software tools, e.g., Ansys Maxwell[®] (Ansys Maxwell 2022), CST EM STUDIO[®] (CST EM Studio 2022), Flux2D/3D[®] (Altair Flux 2022), JMAG[®] (JMAG 2022), and COMSOL MULTIPHYSICS[®] (Comsol Multiphysics 2022), are designed to solve universal EM field problems with standard computational methods. The design principles of commercial packages are, first of all, a broad applicability. Second, the software is made easy to use by powerful graphical user interfaces and template-based workflows. However, users cannot customize and access the internal routines and system solvers.

In a research setting, however, problem-specific modifications and direct access to the FE matrices is indispensable. Various available freeware FE tools offer different levels of abstraction: General FE research tools with a focus on numerical mathematics are e.g., *Deal* (Arndt et al. 2022), *FEniCS* (Alnæs et al. 2015), and *GetDP* (Dular et al. 1998). However, these tools typically require an in-depth knowledge of the FE method. Besides, research tools motivated by electrical engineering

problems are, e.g., *Agros* (Karban et al. 2013), *FEMM* (Meeker 2022), *openCFS* (*openCFS* 2022), and for electrical machine problems *Pyleecan* (Bonneel et al. 2018). These tools allow to study and further develop formulations, discretization techniques and solver strategies for electromagnetic field simulation, thereby covering a large fraction of research in a computational electromagnetics research group. Nevertheless, there is an additional need for a research code built from scratch, with access to all basic routines, with full flexibility and possibly adapted to a few specific lines of research.

Pyrit ¹ is a FE solver developed from the perspective of the electric field simulation workflow. In order to allow a fast prototyping and due to its popularity in industry and academia, it is written in Python². In general, it solves static and quasistatic EM and heat transfer problems. One of the central aims of *Pyrit* is to provide a user-friendly and computationally efficient FE code with a template-based structure for standard and coupled EM and thermal problems. Furthermore, a plain user interface via Python scripts supports the implementation of new modeling and simulation ideas. Its inherent structure supports students to learn how to implement and use a FE solver.

II. DESIGN PRINCIPLES

Pyrit is developed collaboratively based on the following principles: it is robust, portable, scriptable, extensible

¹*Pyrit*'s public wiki:

<https://git.rwth-aachen.de/jonas.bundschuh/pyrit-wiki>

²Python website: <https://www.python.org/>

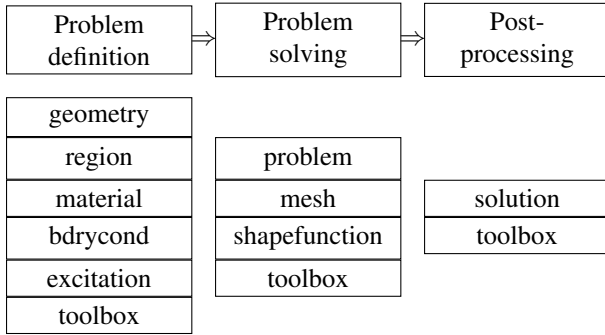

Fig. 1: Assignment of the packages to the steps “Problem definition”, “Problem solving” and “Post-processing” of a field simulation workflow.

and thoroughly documented. Users organize the simulation workflow with Python scripts or Jupyter notebooks (Perkel 2018). Therefore, the full capabilities of Python can be exploited, and studies can be tailored to the needs of individual users.

The object-oriented structure of *Pyrit* allows, in contrast to other FE software packages, different levels of abstraction: On one hand, the user can access and customize the basic and physics-independent FE routines. On the other hand, *Pyrit* offers classes that serve as templates and predefined solvers for a set of selected EM and thermal problems. This allows to model and simulate field problems without detailed knowledge of the weak formulation or of the FE method. Additionally, *Pyrit* provides standard post-processing routines as well as the possibility to export results to Paraview and \LaTeX (for plotting with pgfplots). *Pyrit* is user-friendly as all packages, modules, classes, functions and methods are thoroughly documented. The documentation of the whole software is stripped directly from the source files and is therefore always up-to-date. Supplementary information such as tutorials further extends the documentation. Furthermore, the geometry and mesh generation of the open source software *Gmsh* (Geuzaine and Remacle 2009) is used. In order to make the geometry generation more convenient, the package *geometry* provides a unified interface to *Gmsh*.

III. SOFTWARE STRUCTURE

Pyrit's modeling and simulation workflow is organized in packages. They are assigned to the three steps in Fig. 1 that are described in this section. Since the *toolbox* package can be associated with all three steps, it is described here:

toolbox This package is a collection of different toolboxes with additional functionalities that are not solely associated to one package. It contains, inter alia, a material and geometry library (for the problem definition step), a circuit simulation and a time integration toolbox (for the problem solving step) and a post-processing and export toolbox (for the post-processing step).

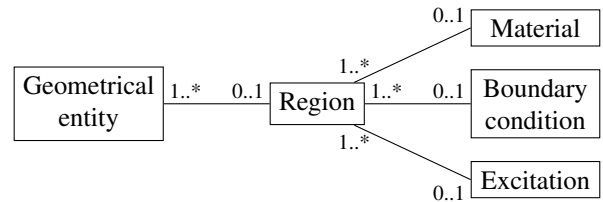

Fig. 2: UML class diagram of the assignment of materials, boundary conditions and excitations to physical groups. They, in turn, are then assigned to geometrical entities, as points, lines, triangles and tetrahedra. An object of a class can have at most one object of a class to its right but one or more objects of a class to its left.

A. Problem definition

Before a simulation is executed, *Pyrit* defines a field problem. This first step is the choice of the problem type. This includes the differential equation to be solved, the dimension of the problem and the time dependency. Subsequently, the geometry is built and the materials, boundary conditions and excitations are assigned. The assignment relies on the concept of physical groups of *Gmsh*, as indicated by an UML class diagram in Fig. 2. The pendant in *Pyrit* are regions. A region has one or more geometrical entities that share a material, a boundary condition or an excitation. Consequently, a geometrical entity can have at most one region.

The following packages are associated with the problem definition step:

bdrycond In this package, boundary conditions are defined. Besides the standard Dirichlet and Neumann boundary conditions, also Robin, periodic, anti-periodic and floating boundary conditions are supported (De Gersem, Wilke, et al. 2004). There is a container class that manages all boundary conditions of a problem and can apply them to the system of equations of the corresponding problem.

excitation In this package, excitations for problems are defined. Its structure is similar to *bdrycond*. Typical excitations are charges, charge densities, currents or current densities. In addition to that, the field-circuit coupling models solid and stranded conductor (De Gersem, Hameyer, et al. 2004) are also implemented in this package. Like in the previous package, there is also a container class that manages all excitations of a problem.

geometry In this package, the interaction between *Pyrit* and *Gmsh* is handled via the *Gmsh* Python API. This includes primarily the generation of geometries and meshes and the extraction of the relevant data for *Pyrit*. There are also several wrapper classes for geometrical entities to simplify the geometry generation.

material In this package, the management of material information is implemented. Materials can be defined by giving them a set of material properties, e.g., a conductivity or a permeability. The values of the material properties can be constants or functions that can depend, in particular, on space, time or

other field values. They can be scalar or tensor valued. With this, a nonlinear, inhomogeneous and anisotropic material can be defined. A container class manages all the materials of a problem.

region In this package, classes for the organization of materials, boundary conditions and excitations on the mesh are provided. Regions can be seen as discrete counterpart to physical groups and are defined on the mesh. The package includes a class for defining a region and a container class that manages different regions.

B. Problem solving

Now that the problem is completely defined, it can be solved. For that, a mesh object and a shape function object are required. The former can be generated and extracted from *Gmsh* with the *geometry* package. The latter is fixed by the chosen problem. With the shape function object, the required matrices and vectors can be computed and assembled into the final system of equations. This can be solved using a predefined `solve` routine defined in the problem class or any other solve method. Currently, there exist wrappers for direct and iterative solvers for sparse matrices from SciPy ³ and Pardiso ⁴.

The relevant packages in this step are:

mesh In this package, classes for different kinds of meshes are defined, e.g., a triangular mesh for two-dimensional domains or a tetrahedral mesh for three-dimensional domains. These classes are responsible for the mesh data. They store the coordinates of all nodes and the definition of the higher dimensional entities (edges, triangles and tetrahedra).

problem This package collects classes that represent standard problem formulations. They provide a framework for organizing all the data needed for defining a problem. Furthermore, the classes in the *problem* package implement a `solve` method that provides a convenient way to solve a problem, i.e., to setup and solve the system of equations. There are separate classes for static, harmonic and transient problems per problem type, i.e., the underlying differential equation.

shapefunction This package provides the core of the FE method, i.e., the different shape functions. There is one class per FE shape function and dimension of the domain. For example, there is a class for nodal shape functions in cylindrical coordinates or a class for edge shape functions in two dimensional Cartesian coordinates. These classes implement the routines to compute the FE matrices. Currently, nodal shape functions are implemented for two and

three dimensional Cartesian and cylindrical coordinates. Furthermore, edge functions are implemented for two dimensional Cartesian and cylindrical coordinates.

C. Post-processing

The result from the problem solving step is a vector or several vectors, depending on the problem, respectively. Each problem class is equipped with a corresponding solution class. These implement standard post-processing routines and allow for a straight-forward visualization of the results. This step also includes the export of the data to files of different formats.

The post-processing step comprises the following package:

solution This package collects solution classes for standard problem formulations. For each class in the *problem* package, there is an associated class in this package. The `solve` routine returns a solution object of correct type that contains the simulation result. In the solution class, standard post-processing and visualization routines, specific for this problem type, are implemented. In the case of an electrostatic problem this includes for example the computation and visualization of the electric displacement field from the electric scalar potential.

IV. QUALITY MANAGEMENT

In the development of *Pyrit*, state-of-the-art software engineering principles were applied to ensure a good code quality and a high usability and reproducibility. This section addresses testing, linting, and the documentation of the code. Continuous integration (CI) ensures that the code fulfills these requirements.

A dedicated focus lies on developing the software collaboratively. For that reason, the version control system Git⁵ is used. It keeps track of the evolving software project and serves as a backup. It also helps distributing the code between the developers and users.

In order to ensure the correctness and robustness of the code in presence and in future, there are many tests for *Pyrit*. They range from testing the functionality of single functions and methods over the interaction of modules to integration tests, i.e., the test of whole simulation procedures. The tests of the shape functions cover, in particular, the consistency and convergence of the implemented FE method.

The coding style, which can vary depending on the collaborator, and the readability of the code are optimized through the use of a linter, i.e., a static code analyzer that finds discrepancies between the code and a predefined style.

A crucial part for every software is its documentation, since it guides the user through the software's functionalities. In *Pyrit*, the documentation is automatically

³<https://docs.scipy.org/doc/scipy/reference/sparse.linalg.html>

⁴<https://www.intel.com/content/www/us/en/docs/onemkl/developer-reference-fortran/2023-0/onemkl-pardiso-parallel-direct-sparse-solver-interface.html>

⁵Git website: <https://git-scm.com/>

generated based on the provided docstrings of the source files. This implies that the documentation file is always up-to-date. Furthermore, the documentation is enriched by application examples and tutorials of EM and thermal field problems.

The tasks in the described aspects of quality management, i.e., testing, linting and documentation, have to be executed regularly, but at least after a commit has been pushed. This is automated on Git with CI. After new commits have been pushed, a so called pipeline is started where first *Pyrit* is installed with the recent dependencies and, then, tested and linted. The single tasks are executed via Docker⁶ in containers on a separate machine (Merkel 2014).

V. EXAMPLES

Three examples show the modeling and simulation workflow in *Pyrit*. The first two examples use a predefined problem class of *Pyrit*, i.e., the user models the EM problem. Subsequently, the predefined template is used to setup, solve and post-process the FE system. The third example shows how *Pyrit* can be customized. There, a system of equations from the FE formulation is built and extended by a field-circuit coupling.

A. Template-based simulation example

As a starting point, a simple example shows the basic procedure of the problem definition. It is an electrostatic simulation of a plate capacitor in 2D Cartesian coordinates filled with two materials (see Fig. 3a). The bottom plate is grounded and the top plate is set to a potential of 1 V. On the left and right side homogeneous Neumann boundary conditions are imposed.

We start at a point where the mesh and the regions already exist. The geometry was build with the *Gmsh* Python API and imported into *Pyrit* with the *geometry* package.

```
1 | model = PlateCapacitor()
2 | mesh, regions = model.create_geometry()
```

Next, the materials and boundary conditions of this example are defined:

```
3 | materials = Materials(
4 |     material_bot := Mat("Mat_bot",
5 |     ↪ Permittivity(eps_0)),
6 |     material_top := Mat("Mat_top",
7 |     ↪ Permittivity(2 * eps_0))
8 | )
9 | boundary_conditions = BdryCond(
10 | bc_ground := BCDirichlet(0),
11 | bc_voltage := BCDirichlet(1))
```

With the region IDs from Fig. 3a, materials and boundary conditions can be assigned to the regions:

```
10 | regions.get_regi(1).bc = bc_ground.ID
11 | regions.get_regi(2).bc = bc_voltage.ID
12 | regions.get_regi(3).mat = material_bot.ID
13 | regions.get_regi(4).mat = material_top.ID
```

⁶Docker website: <https://www.docker.com/>

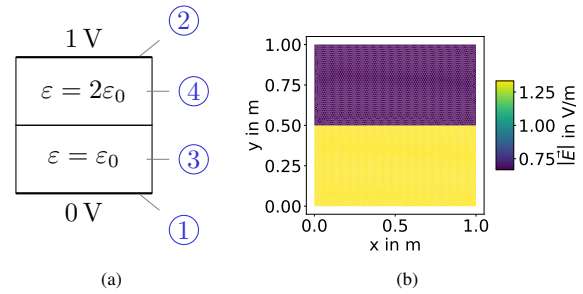

Fig. 3: Plate capacitor with two materials. In (a) the model is shown with the region IDs in blue. In (b) the electric field strength is plotted.

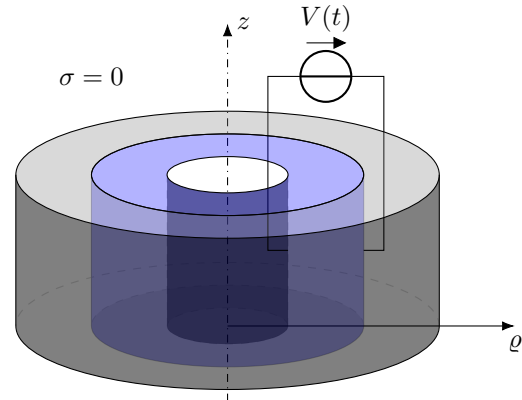

Fig. 4: Schematic of the second example. The cylindrical resistor consists of a nonlinear material (blue) with an inner radius of 0.1 m and an outer radius of 0.3 m. The material is located between two electrodes to which a transient voltage $V(t)$ is applied, where t denotes the time. The resistor is surrounded by a layer of soil (gray) with a thickness of 0.7 m. The inner surface of the resistor and the outer surface of the soil are at a fixed temperature of 60°C and 20°C, respectively. The surrounding space is non-conductive.

With that, the problem is completely defined and all data structures necessary to instantiate an object of the problem class `ElectricProblemCartStatic` are available. The `solve` routine then solves the problem and returns an object of the associate solution class `ElectricSolutionCartStatic`:

```
14 | problem = ElectricProblemCartStatic("Plate
15 |     ↪ Capacitor", mesh, regions, materials,
16 |     ↪ boundary_conditions, Excitations())
17 | solution := problem.solve()
```

The solution object can be used to plot for instance the electric field strength (see Fig. 3b):

```
16 | solution.plot_e_field(plot_type='abs')
```

B. Template-based nonlinear simulation example

The second example is a nonlinear electrothermal simulation of a cylindrical resistor (see Fig. 4). The resistor consists of a nonlinear material, which features a strongly field- and temperature-dependent electric conductivity (see Fig. 5). Such nonlinear materials are employed in field grading layers of high-voltage cable systems (Hussain and Hinrichsen 2017; Ruppert et al. 2023). The material is located between two electrodes to which a

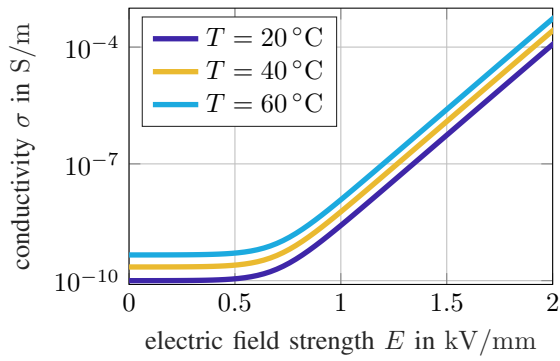

Fig. 5: Field- and temperature-dependent conductivity $\sigma(E, T)$ of the nonlinear material. The electric field strength and the temperature are denoted as E and T , respectively.

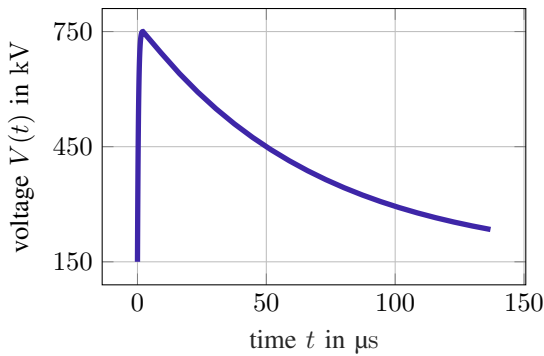

Fig. 6: Transient voltage $V(t)$ over the time t .

transient voltage $V(t)$ is applied (see Fig. 6). The resistor is surrounded by a layer of soil. The inner surface of the resistor and the outer surface of the soil are at a fixed temperature of 60°C and 20°C , respectively. For a more detailed description of the model configuration and material parameters see (Ruppert et al. 2023).

The first step in the simulation process is the definition of the geometry. *Pyrit* offers several ways to do this: The user can import a step file, create a geometry using *Pyrit's geometry* package, or import an already existing *Gmsh* file. For this example, an already existing *Gmsh* file is imported:

```
1 | # Import mesh from GMSH file
2 | filename = './gmsh/cylindrical_resistor'
```

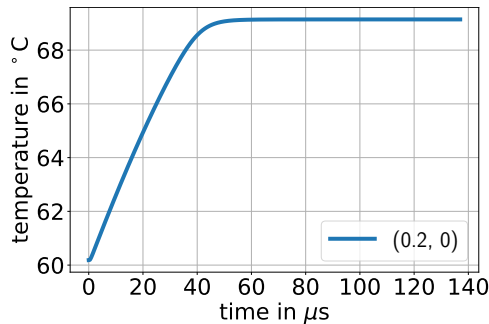

Fig. 7: Plot generated by the method `plot_temperature_at_` position of the temperature evaluated at $\rho = 0.2\text{m}$ inside the resistor depicted in Fig. 4 over time.

```
3 | mesh = read_msh_file(filename,
  |   ↪ mesh_type=AxiMesh)
```

Second, the materials and boundary conditions are defined. The excitation voltage and fixed temperatures are implemented as Dirichlet boundary conditions of the electric potential and temperature, respectively:

```
4 | # Define materials
5 | field_grading_material =
  |   ↪ MaterialLibrary.get_material("FGM")
6 | soil = Mat("Soil", ThermalConductivity(0.8),
  |   ↪ VolumetricHeatCapacity(2333e3))
7 | materials = Materials(field_grading_material,
  |   ↪ soil)
8 |
9 | # Define boundary conditions of the electric
  |   ↪ subproblem
10 | ground = BCDirichlet(0, "ground")
11 | voltage = BCDirichlet(
  |   ↪ ExcitationLibrary.get_excitation(
  |   ↪ "lightning_impulse"), "V")
12 | boundary_conditions_electric =
  |   ↪ BdryCond(ground, voltage)
13 |
14 | # Define boundary conditions of the thermal
  |   ↪ subproblem
15 | temperature_fgm = BCDirichlet(333.15,
  |   ↪ "temperature_inner")
16 | temperature_soil = BCDirichlet(293.15,
  |   ↪ "temperature_outer")
17 | boundary_conditions_thermal =
  |   ↪ BdryCond(temperature_fgm,
  |   ↪ temperature_soil)
```

The homogeneous Neumann boundary conditions of the lower and upper boundary in the z -direction are automatically satisfied by the FE ansatz.

Finally, the material properties and boundary conditions are assigned to the geometry. A region maps the physical properties to corresponding edges and elements in the FE mesh:

```
18 | # Define regions of the electric subproblem
19 | regions_electric = generate_regions(filename,
  |   ↪ materials, boundary_conditions_electric)
20 |
21 | # Define regions of the thermal subproblem
22 | regions_thermal = generate_regions(filename,
  |   ↪ materials, boundary_conditions_thermal)
```

As stated in Sec. III, *Pyrit* offers classes for EM and heat transfer problems of any time dependence. This allows to solve field problems based on a template-based workflow. Here, the class `ElectrothermalProblemAxiTransient`, that represents a coupled transient electrothermal problem in cylindrical coordinates, is utilized. It is composed of two subproblems containing the boundary conditions of the electric and thermal subsystem, respectively:

```
23 | # Define time axis
24 | time_steps =
  |   ↪ numpy.append(numpy.linspace(0, 2e-6, 150),
  |   ↪ numpy.linspace(2e-6, 140e-6, 150)[1:])
25 |
26 | # Define the electro-quasistatic subproblem
27 | problem_electric =
  |   ↪ CurrentFlowProblemAxiTransient(
  |   ↪ "cylindrical_resistor", mesh,
  |   ↪ regions_electric, materials,
  |   ↪ boundary_conditions_electric, time_steps)
```

```

28 |
29 | # Define the transient heat conduction
    | ↪ subproblem
30 | problem_thermal = ThermalProblemAxiTransient(
    | ↪ "cylindrical_resistor", mesh,
    | ↪ regions_thermal, materials,
    | ↪ boundary_conditions_thermal, time_steps)
31 |
32 | # Combine the subproblems to a coupled
    | ↪ electrothermal problem
33 | problem_coupled =
    | ↪ ElectrothermalProblemAxiTransient(
    | ↪ problem_electric, problem_thermal)

```

The `ElectrothermalProblemAxiTransient` class offers a `solve` method for running the electrothermal simulation. It automatically handles the coupling of the two subproblems either by a weak coupling scheme or a successive substitution iteration. The nonlinearity arising in the electric subproblem due to the nonlinearity of the nonlinear material is solved using a damped Newton method:

```

34 | # Load previously computed steady-state
    | ↪ solutions that serve as initial
    | ↪ conditions for the electric potential and
    | ↪ temperature
35 | initial_value_potential =
    | ↪ Solution.load("steady_state_electric.pkl")
36 | initial_value_temperature =
    | ↪ Solution.load("steady_state_thermal.pkl")
37 |
38 | # Run simulation
39 | solution_electric, solution_thermal =
    | ↪ problem_coupled.solve(
    | ↪ initial_value_potential,
    | ↪ initial_value_temperature)

```

The solutions returned by the `solve` method come with a set of post-processing and plotting routines:

```

40 | # Print power loss during peak excitation
41 | print(f"Power loss:
    | ↪ {solution_electric.joule_loss_power(
    | ↪ time=2e-6)} W")
42 | # Animate the electric potential over time
    | ↪ solution_electric.animate_potential()
43 | # Plot the temperature at a specified
    | ↪ position over time
44 | position = (0.2, 0)
45 | solution_thermal.plot_temperature_at_position(
    | ↪ position, celsius=True)

```

Figure 7 exemplarily shows the plot generated by the method `plot_temperature_at_position`.

C. Customized example

In the third example, no predefined problem class is used. A field-circuit coupled problem with a magnetoquasistatic field problem is considered (Fig. 8). It consists of an electrical circuit (see Fig. 8a) with a transformer that is represented by a field model (see Fig. 8b). The lumped elements in the circuit are $R = 1\ \Omega$, $R_L = 10\ \Omega$ and $C = 0.1\ \mu\text{F}$. The voltage source is $V_s = \hat{V}_s \sin(\omega t)$, with $\hat{V}_s = 1\ \text{V}$, the angular frequency $\omega = 2\pi f$, the frequency $f = 3\ \text{kHz}$ and the time variable t . The field model of the transformer uses a stranded conductor model for both coils (De Gersem, Hameyer, et al. 2004). The primary

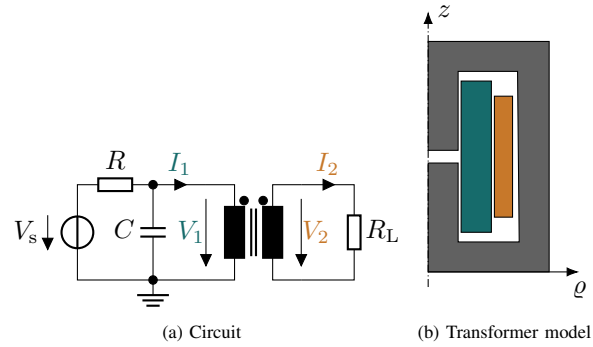

Fig. 8: Configuration of the third example. The circuit for the field-circuit coupling (a) with a transformer resolved in a field model (b). The transformer is described in axisymmetric coordinates and consists of a highly permeable yoke (gray) and a primary windings (teal) and secondary windings (orange).

coil (teal) and the secondary coil (orange) have 300 and 500 turns, respectively.

In the following, one system for the magnetoquasistatics and one for the circuit is built in the frequency domain. These are then coupled with field-circuit coupling matrices.

The geometry and the mesh of this example were generated and exported to *Pyrit* with the *Gmsh* Python API. Since the focus of this example is on the field-circuit coupling, these steps are not shown here. We start with a `problem` object on which the shape functions, the mesh and the materials and boundary conditions already exist:

```
1 | problem = model.create_geometry()
```

Now, the right-hand side vector and the FE matrices are retrieved from the shape function object and combined into the system of equations of the magnetoquasistatic formulation:

```

2 | curlcurl =
    | ↪ shape_function.curlcurl_operator(regions,
    | ↪ materials, Reluctivity)
3 | mass = shape_function.mass_matrix(regions,
    | ↪ materials, Conductivity)
4 | rhs = shape_function.load_vector(0)
5 |
6 | matrix = curlcurl + 1j * omega * mass

```

The system representing the circuit (see Fig. 8a) is built with the values of the lumped elements:

```

7 | circuit_matrix = sparse.coo_matrix(
8 | numpy.array([[R, 1+R*1j*omega*C, 0, 0],
9 | [0, 0, -R_L, 1]]))
10 | circuit_rhs = sparse.coo_matrix([[V_s, ],
    | ↪ ([0, ], [0, ])], shape=(2, 1))

```

The coupling matrices from the field-circuit coupling are generated by a class that represents stranded conductors:

```

11 | bottom_matrix, right_matrix, \
12 | diagonal_matrix, rhs_vector =
13 | str_cond.get_coupling_matrices(problem)

```

Inserting the boundary conditions with the method

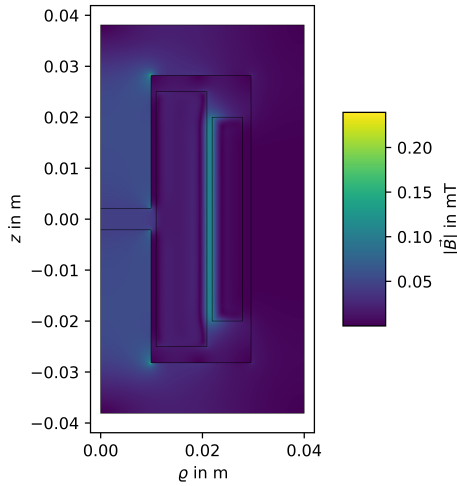

Fig. 9: Absolute values of the magnetic flux density at phase 0 in the transformer.

`shrink` yields the system matrix and the system vector. With these, the new system is given by:

```

14 | matrix, rhs =
    | ↪ problem.shape_function.shrink(matrix,
    | ↪ rhs, problem)
15 |
16 | matrix_sys = sparse.bmat(
17 | [[matrix_shrink, right_matrix],
18 | [bottom_matrix, diagonal_matrix]])
19 | rhs_sys = sparse.vstack([rhs_shrink,
    | ↪ rhs_vector])

```

Finally, we insert the circuit system:

```

20 | matrix_sys = sparse.vstack(
21 | [matrix_sys,
22 | sparse.hstack([zeros, circuit_matrix]])
23 | rhs_sys = sparse.vstack(
24 | [rhs_sys, circuit_rhs])

```

After solving the system, the circuit solution consists of the voltages and currents at the transformer. The boundary conditions are integrated into the field solution that is then evaluated with a predefined solution class for magnetoquasistatic problems:

```

25 | sol = problem.solve_linear_system(
    | ↪ matrix_sys, rhs_sys)[0]
26 |
27 | I_1, V_1, I_2, V_2 = sol[-4:]
28 | solution = inflate(sol, problem)

```

The `solution` object provides post-processing routines:

```

29 | print(f"Energy: {solution.energy()} J")
30 | solution.plot_b_field('abs', mesh=False)

```

The plot of the magnetic flux density at a phase of 0, generated by the method `plot_b_field`, is shown in Fig. 9.

VI. CONCLUSION

Pyrit is a finite-element software environment for simulating electromagnetic and thermal field problems of any time dependence (static, transient or harmonic). Its

software structure is based on an engineering workflow for solving a field problem numerically, i.e., problem definition, problem solution and post-processing. *Pyrit* allows to solve field problems in a template-based workflow. Furthermore, full access to the FE core supports research and development on numerical techniques. Three examples showed how users can define, solve and post-process a field problem in an easy and general way.

VII. ACKNOWLEDGMENT

This work is supported by the joint DFG/FWF Collaborative Research Centre CREATOR (CRC – TRR361/F90) at TU Darmstadt, TU Graz and JKU Linz, the Athene Young Investigator Programme of TU Darmstadt, the German Science Foundation (DFG project 436819664), and the Graduate School Computational Engineering at TU Darmstadt. The authors thank Christian Bergfried, Daniel Leibner, Jonas Christ and Svenja Menzenbach for their valuable contributions. In particular, the authors thank Laura A. M. D’Angelo, who provided her knowledge from developing the Matlab FE tool *Niobe* and Herbert De Gerssem for the opportunity to pursue this project and for his valuable advise. Furthermore, the authors thank Michael Leigsnering for fruitful discussions on collaborative software development and for the idea of the software’s name.

REFERENCES

- Alnæs, M. et al. (2015). “The FEniCS Project Version 1.5”. In: *Archive of Numerical Software* Vol 3. DOI: 10.11588/ANS.2015.100.20553.
- Altair Flux (2022). URL: <https://www.altair.com/flux> (visited on 10/14/2022).
- Ansys Maxwell (2022). URL: <https://www.ansys.com/products/electronics/ansys-maxwell> (visited on 10/14/2022).
- Arndt, D. et al. (2022). “The deal.II Library, Version 9.4”. In: *Journal of Numerical Mathematics* 30.3, pp. 231–246. DOI: 10.1515/jnma-2022-0054. URL: <https://dealii.org/deal94-preprint.pdf>.
- Bonneel, P. et al. (Sept. 2018). “pylecan: an open-source Python object-oriented software for the multiphysic design optimization of electrical machines”. In: *2018 XIII International Conference on Electrical Machines (ICEM)*. IEEE. DOI: 10.1109/icelmach.2018.8506884.
- Comsol Multiphysics (2022). URL: <https://www.comsol.com/comsol-multiphysics> (visited on 10/14/2022).
- CST EM Studio (2022). URL: <https://www.3ds.com/products-services/simulia/products/cst-studio-suite/> (visited on 10/14/2022).
- De Gerssem, H., K. Hameyer, and T. Weiland (July 2004). “Field–circuit coupled models in electromagnetic simulation”. In: *Journal of Computational and Applied Mathematics* 168.1-2, pp. 125–133. DOI: 10.1016/j.cam.2003.05.008.
- De Gerssem, H., M. Wilke, et al. (2004). “Efficient modelling techniques for complicated boundary conditions applied to structured grids”. In: *COMPEL: The International Journal for Computation and Mathematics in Electrical and Electronic Engineering* 23.4, pp. 904–912. ISSN: 0332-1649. DOI: 10.1108/03321640410553337.
- Dular, P. et al. (1998). “A general environment for the treatment of discrete problems and its application to the finite element method”. In: *IEEE Transactions on Magnetics* 34.5, pp. 3395–3398. DOI: 10.1109/20.717799.
- Geuzaine, C. and J.-F. Remacle (May 2009). “Gmsh: A 3-D finite element mesh generator with built-in pre- and post-processing facilities”. In: *International Journal for Numerical Methods in Engineering* 79.11, pp. 1309–1331. DOI: 10.1002/nme.2579.
- Hussain, R. and V. Hinrichsen (2017). “Simulation of thermal behavior of a 320 kV HVDC cable joint with nonlinear resistive field grading under impulse voltage stress”. In: *CIGRÉ Winnipeg 2017 Colloquium*.

- JMAG* (2022). URL: <https://www.jmag-international.com/> (visited on 10/14/2022).
- Karban, P. et al. (Jan. 2013). "Numerical solution of coupled problems using code Agros2D". In: *Computing* 95.S1, pp. 381–408. DOI: 10.1007/s00607-013-0294-4.
- Meeker, D. (2022). *FEMM*. URL: <http://www.femm.info> (visited on 10/14/2022).
- Merkel, D. (2014). "Docker: lightweight linux containers for consistent development and deployment". In: *Linux journal* 2014.239, p. 2.
- openCFS* (2022). URL: <https://opencfs.org/index.html> (visited on 10/14/2022).
- Perkel, J. M. (Oct. 30, 2018). *Why Jupyter is data scientists' computational notebook of choice*. URL: <https://www.nature.com/articles/d41586-018-07196-1> (visited on 10/17/2022).
- Ruppert, M. G. et al. (2023). "Analyzing Sensitivities in HVDC Cable Joint Materials". In: *Jicable: 11th International Conference on Insulated Power Cables*.