

A group from a map and orbit equivalence.

Jérôme Los¹ and Natalia A. Viana Bedoya²

¹Aix-Marseille Université, CNRS, ECM, I2M, UMR 7373.

²Universidade Federal de São Carlos, DM-UFSCar.

Abstract

In two papers published in 1979, R. Bowen and C. Series defined a dynamical system from a Fuchsian group, acting on the hyperbolic plane \mathbb{H}^2 . The dynamics is given by a map on S^1 which is, in particular, an expanding piecewise homeomorphism of the circle. In this paper we consider a reverse question: which dynamical conditions for an expanding piecewise homeomorphism of S^1 are sufficient for the map to be a “Bowen-Series-type” map (see below) for some group G and which groups can occur? We give a partial answer to these questions.

1 Introduction

In this paper we introduce a class of *discontinuous expanding piecewise homeomorphisms of the circle*. Such a map $\Phi : S^1 \rightarrow S^1$ is given by a finite partition of the circle so that the restriction of Φ to each partition interval is an expanding homeomorphism onto its image. The class of maps we consider is motivated by two related questions:

- Can we construct a group G_Φ from such a map Φ ?
- Which groups can be obtained?

The groups that can possibly be constructed are naturally subgroups of $\text{Homeo}(S^1)$ which is well known for having many different classes of subgroups. Since the possible groups G_Φ and the map Φ act on the same space, S^1 , it is natural to compare the two actions and the best possible situation is when the two actions are “orbit equivalent”. This means that the orbits of Φ and of G_Φ are the same, modulo possibly finitely many exceptions. In such cases we say that the map Φ is a *Bowen-Series-type* map for the group G_Φ .

This program is a reverse problem of a beautiful construction initiated by R. Bowen and C. Series in the late 70’s in [B] and [BS], where they discovered a striking relationship between some groups and some dynamics. The Bowen-Series construction starts with a Fuchsian group G given by an action on \mathbb{H}^2 with specific properties and they obtained a particular map $\Phi_{BS} : S^1 \rightarrow S^1$, where S^1 is the boundary $\partial\mathbb{H}^2$. Some variations of this construction has been studied by Adler-Flato in [AF] and more recently in [AKM]. The

AMS Subject Classification (2020): 20F65, 20F67, 37E10.

maps Φ_{BS} satisfy very strong properties:

- They are piecewise Möbius maps,
- orbit equivalent to the G -action on S^1 ,
- expanding Markov maps.

The idea of the Bowen-Series construction has been revisited in [L] for hyperbolic surface groups, in the geometric group theory context i.e., the group is given combinatorially by a presentation $P = \langle X; R \rangle$ i.e., a set of generators and relations. The presentations belong to a particular class called “geometric”, meaning that the associated Cayley 2-complex is planar. The classical presentations of surface groups are geometric in this sense as well as the presentations considered in [AF]. This construction starts with a geometric presentation P and defines a map $\Phi_P : S^1 \rightarrow S^1$ that is an expanding piecewise homeomorphism and the circle is the Gromov boundary of the group G (see [Gr]). The maps Φ_P and Φ_{BS} are different i.e., non conjugated, even in the cases they can be compared i.e., for the classical presentations. But they satisfy the same two main features: the orbit equivalence and the Markov properties. The map Φ_P satisfies an additional property relating the group and the dynamics: the volume entropy of the presentation P (see [GH]) equals the topological entropy of Φ_P (see [AKM]). The construction of more maps from a geometric presentation P of a surface group has been generalized in [AJLM2] by defining a multiparameter family of maps and an entropy stability result has been obtained for all maps in this family.

The problem we consider in this paper is a converse question:

How particular are the maps obtained from a surface group presentation among piecewise homeomorphisms of the circle?

We obtain a partial answer to this general question. Here a map Φ is given, as a piecewise homeomorphism of the circle, and one goal is to find dynamical conditions on Φ that allow first to construct a group from the map and then to analyse which groups could be obtained. Each map Φ , being a piecewise homeomorphisms of the circle, is given by a finite partition of S^1 . It will soon become clear that the number of partition intervals has to be even. A point at the boundary of two partition intervals is called a *cutting point*, at such points the map is not continuous. The map is expanding means that each partition interval is mapped onto an interval that contains it compactly thus the map is surjective and not globally injective.

The conditions we found on the map Φ are explained in §2, they can be expressed roughly as:

- A Strong Expansivity condition (SE): each partition interval is mapped to an interval that contains it and intersects all but one partition interval.
- An Eventual Coincidence condition (EC): the left and right orbits of each cutting point coincide after some well defined iterate.
- The conditions (E+) and (E-) that control the left and right orbits of the cutting points before the coincidence.

Finally we do not restrict to maps Φ satisfying a Markov property, as in [BS], [AF], [L], [AJLM], which would be too restrictive. We replace it by a weaker condition which quantifies the expansivity property:

- The Constant Slope conditions (CS): the map is conjugate to a piecewise affine map with constant slope ($\lambda > 1$). Under this set of conditions our main result is:

Theorem. *Let $\Phi : S^1 \rightarrow S^1$ be an orientation preserving piecewise homeomorphism satisfying the conditions: (SE), (EC), (E+), (E-), (CS). Then there exists a discrete subgroup G_Φ of $\text{Homeo}^+(S^1)$ such that:*

1. G_Φ and Φ are orbit equivalent.
2. G_Φ is a surface group, for an orientable compact closed hyperbolic surface.

The set of maps satisfying the above conditions is not empty. Indeed if a surface group for an orientable surface of genus larger than 2 has a geometric presentation P , where all the relations have even length (for instance the classical presentations) then the map Φ_P of [L] satisfies the conditions of the Theorem. For the same set of presentations, the multiparameter family Φ_Θ defined in [AJLM2], satisfies the conditions of the Theorem for an open set of parameters (see Lemma 2.1). On the other hand the set of conditions of the Theorem is not optimal (see Remark 1).

The strategy of proof has several steps. The first one is to analyse the dynamical properties of the map Φ (see §2 and §3). Then we construct a group G_{X_Φ} , as a subgroup of $\text{Homeo}^+(S^1)$, by producing a generating set X_Φ from the map Φ (see §3). This step exhibits a surprising generating set X_Φ .

The next step is to prove that the group G_{X_Φ} , as an abstract group, is hyperbolic in the sense of M. Gromov (see [Gr] or [GdlH]). This property is obtained by showing that G_{X_Φ} acts geometrically on a hyperbolic metric space. This is a technical part (see §4 and §5). It requires to construct a hyperbolic space and a geometric action on it, from the only data we have: the map.

The hyperbolic space is obtained by a general dynamical construction inspired by one due to P. Haissinsky and K. Pilgrim [HP] (see §4). The hyperbolicity is a consequence of the expansivity, as in [HP], and the Gromov boundary of the space is S^1 . We adapt the construction and define a new space, suited to the maps Φ , specially to the condition (EC), in order to define a group action on the space.

This step is new, it defines a class of “dynamical spaces” in the context of groups. The construction of an action of the group on this metric space is also new. In both cases, the space and the action are defined only from the dynamics of the map (see §5).

At this point the group G_Φ is hyperbolic with boundary S^1 . A result of E. Freden [F] implies that the group is a discrete convergence group, as defined by F. Gehring and G.Martin [GM] and thus it satisfies the conditions of the geometrisation theorem of P. Tukia [T], D. Gabai [G] and A. Casson-D. Jungreis [CJ]. The conclusion is that G_Φ is virtually a Fuchsian group. One more step shows that, with our assumptions, G_Φ is torsion free and, by H. Zieschang [Zi], it is a surface group.

Proving that the group G_Φ and the map Φ are orbit equivalent follows a strategy similar to [BS] (see §6) and is rather simple thanks to some particular dynamical properties of the map.

In the appendix (see §7), we give a direct proof that G_Φ is a surface group, without using the geometrisation theorems of Tukia, Gabai and Casson-Jungreis. All the hard

work has, in fact, been done before: the geometric action constructed in §5 is extended to a free, co-compact action on a \mathbb{R}^2 . This also gives some interesting consequences, in relation with [AJLM2]

We obtain a partial answer to our general question (see Remark 1) and finding better conditions is a challenge for future works.

The construction of the group from the map leads to some surprises. For instance, as a by-product of our construction, we obtain:

Theorem. *If S is a closed, compact, orientable surface of genus larger than 2. Then the fundamental group $G = \pi_1(S)$, as a discrete subgroup of $\text{Homeo}^+(S^1)$, admits some presentations where the generators are piecewise affine homeomorphisms of S^1 with slopes in $\{\lambda, \lambda^{-1}\}$. The number $\lambda > 1$ is an algebraic integer and $\log(\lambda)$ is the volume entropy of the presentation. Each element $g \in G$ is piecewise affine with slopes in $\{\lambda^k : k \in \mathbb{Z}\}$. In particular, an element of length n , with respect to the generating set, admits an interval $I_g \subset S^1$ so that $g|_{I_g}$ is affine of slope λ^n .*

Some variations of our construction, from a given map, could possibly give different classes of groups, which groups could appear is an interesting question.

The condition (EC) is central in our approach, it seems to be a new dynamical condition and is interesting in its own right. The class of discontinuous maps satisfying a condition (EC) is much larger than the one studied here.

Acknowledgements: This work was partially supported by FAPESP (2016/24707-4). We thanks the hospitality of our research institutes: I2M in Marseille and DM-UFSCar in São Carlos, Brazil. We thanks the French-Uruguayan laboratory (IFUMI) in Montevideo where this work has been completed. The authors would like to thank P. Haissinsky and M. Boileau for their interest in this work and some comments on an earlier versions of the paper. We would like to thank the anonymous referee of a previous version who pointed out a gap in one argument. Closing this gap has proved to be very interesting. We would like to thank the reviewer of this version for her/his careful reading and observations, which have helped us to greatly improve this work.

2 A class of piecewise homeomorphisms on S^1

We define in this section the class of maps that will be considered throughout the paper. A map $\Phi : S^1 \rightarrow S^1$ is a *piecewise orientation preserving homeomorphism of the circle* if there is a finite partition of S^1 :

$$S^1 = \bigcup_{j=1}^M I_j, \text{ where each } I_j \text{ is half open,} \quad (1)$$

so that and $\Phi_j := \Phi|_{I_j}$ is an orientation preserving homeomorphism onto its image and each I_j is maximal. We require further that the number of partition intervals is even: $M = 2N$.

2.1 The class of maps

To state the next properties of the maps in our class, we introduce some notations. Let $\zeta, \iota, \delta, \gamma$ be permutations of $\{1, \dots, 2N\}$, such that:

- ζ is a cyclic permutation of order $2N$,
- ι is a fixed point free involution i.e., for all $j \in \{1, \dots, 2N\}$, $\iota(j) \neq j$ and $\iota^2 = \text{id}$, such that: $\iota(j) \neq \zeta^{\pm 1}(j), \forall j \in \{1, \dots, 2N\}$.
This implies that $N > 1$ and, to avoid special cases, we assume for the rest of the paper, that $N \geq 4$.
- From the permutations ζ and ι we define: $\gamma := \zeta^{-1}\iota$ and $\delta := \zeta\iota$.

Geometrically ζ is the permutation that realizes the adjacency permutation of the intervals $\{I_1, \dots, I_{2N}\}$ along a given positive (clockwise) orientation of S^1 . By convention $I_{\zeta(j)}$ is the interval that is adjacent to I_j in the positive direction.

The interval $I_{\iota(j)}$ is an interval that is not I_j and is not adjacent to I_j . The two intervals $I_{\gamma(j)}$ and $I_{\delta(j)}$ are the intervals adjacent to $I_{\iota(j)}$ (see Figure 1).

From now on we assume that all the cycles of γ (and δ see Lemma 2.2 below), in its cycle decomposition, have a length $\ell[j]$ even and larger than 4 i.e.:

$$\ell[j] \text{ is even and } k(j) = \ell[j]/2 \geq 2, \text{ for all } j \in \{1, \dots, 2N\}. \quad (2)$$

The map $\Phi : S^1 \rightarrow S^1$ satisfies the following set of conditions.

Using the permutations above, Φ satisfies the *Strong Expansivity* condition if:

$$\text{(SE)} \quad \forall j \in \{1, \dots, 2N\}, \Phi(I_j) \cap I_k = \emptyset \Leftrightarrow k = \iota(j), \text{ (see Figure 1)}.$$

This condition has some immediate consequences:

$$\text{(I)} \quad \Phi(I_j) \cap I_k = I_k, \forall k \neq \iota(j), \gamma(j), \delta(j),$$

(II) The map Φ has a fixed point in the interior of each I_j .

This is immediate from the definition of ι and (I), since $I_j \subset \Phi(I_j)$.

(III) The map is surjective, non injective and each point $z \in S^1$ has $2N - 1$ or $2N - 2$ pre-images.

To fix the notations we write each interval $I_j := [z_j, z_{\zeta(j)})$, the points $z_j \in S^1$ are called the *cutting points* of Φ . The map Φ is not continuous at each z_j . The next condition makes the map Φ really particular, it is called the *Eventual Coincidence* condition:

$$\text{(EC)} \quad \forall j \in \{1, \dots, 2N\} \text{ and } \forall n \geq k(j) - 1, \text{ where } k(j) \geq 2 \text{ is given by (2):}$$

$$\Phi^n(\Phi_{\zeta^{-1}(j)}(z_j)) = \Phi^n(\Phi_j(z_j)).$$

In other words, each cutting point has a priori two different orbits, one from the positive side and one from the negative side of the point. The condition (EC) says that after $k(j)$ iterates these two orbits coincide. By (1) each $I_j := [z_j, z_{\zeta(j)})$ is half open, the notation $\Phi_{\zeta^{-1}(j)}(z_j)$ is well defined by continuity on the left of z_j of $\Phi_{\zeta^{-1}(j)}$.

The next set of conditions on the map gives some control on the first $k(j) - 1$ iterates of the cutting points z_j , namely: For all $j \in \{1, \dots, 2N\}$ and all $0 \leq m \leq k(j) - 2$:

$$\text{(E+)} \quad \Phi^m(\Phi_j(z_j)) \in I_{\delta^{m+1}(j)},$$

$$\text{(E-)} \quad \Phi^m(\Phi_{\zeta^{-1}(j)}(z_j)) \in I_{\gamma^{m+1}(\zeta^{-1}(j))}.$$

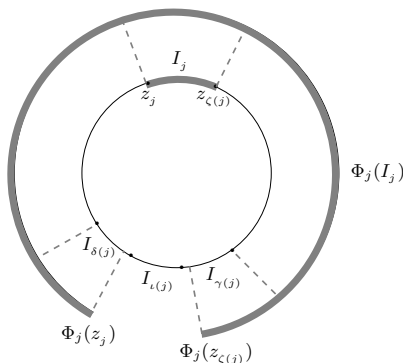

Figure 1: Condition (SE)

These two conditions are interpreted as follows:

Consider (E+), for $m = 0$ this is condition (SE) since $\Phi_j(z_j) \in I_{\delta(j)}$, (see Figure 1). Then $\Phi_j(z_j)$ is near the cutting point $z_{\delta(j)}$ in $I_{\delta(j)}$, since $\Phi(\Phi_j(z_j)) \in I_{\delta^2(j)}$ (by $m = 1$) and $I_{\delta^2(j)}$ is the interval containing $\Phi_{\delta(j)}(z_{\delta(j)})$ (by $m = 0$ for $z_{\delta(j)}$) and so on up to $m = k(j) - 2$.

The last condition quantifies the expansivity property of the map, it is called the *Constant Slope* condition:

(CS) Φ is topologically conjugate to a piecewise affine map $\tilde{\Phi}$ with constant slope $\lambda > 1$.

(II') In complement to (II): Φ has a unique expanding fixed point on each I_j .

The following result is a combination of several statements in [AJLM2] (see Theorem A and Lemma 5.1). It implies that the set of piecewise homeomorphisms of the circle satisfying the conditions (SE), (EC), (E-), (E+), (CS) is non-empty.

Lemma 2.1. *Let S be a closed compact orientable surface of negative Euler characteristic, and let $P = \langle X, R \rangle$ be a geometric presentation of the fundamental group $G = \pi_1(S)$ so that all the relations in R have even length, for instance the classical presentation. Then, in the Bowen-Series-Like family of maps $\Phi_{P,\Theta}$ defined in [AJLM2], there is an open set of parameters Θ so that the corresponding maps satisfy the conditions (SE), (EC), (E-), (E+), (CS). The parameters Θ belong to a product of $2N$ intervals, where $2N$ is the number of generators.*

Remark 1. *By the previous result, the set of piecewise orientation preserving homeomorphisms satisfying the conditions (SE), (EC), (E+), (E-), (CS) is non-empty and there is a family of such maps for each orientable surface and each geometric presentation with even length relations. For the maps Φ_P constructed in [L], the proof of these properties is a direct check. In particular the constant slope condition (CS) is obtained using the Markov property satisfied by Φ_P via a standard Perron-Frobenius argument. In the more general cases of the family $\Phi_{P,\Theta}$ defined in [AJLM2], the constant slope condition is one statement of the main theorem of that paper.*

If a presentation P of a surface group G is geometric and has some relations with odd length then the constructions in [L] and [AJLM2] apply but not those in [B] and [BS]. For these presentations, some conditions similar but different to (E+) and (E-) are satisfied. When the presentation P has some relations of length 3, a condition weaker than (SE) is satisfied (see Lemma 5.2 in [L]). In all these cases the condition (CS) is satisfied and a condition similar to (EC) is satisfied for some integers k . The condition (EC) is crucial in this paper and is not satisfied by all possible maps constructed via the general Bowen-Series-Like strategy as in [AJLM2]. In particular it is not satisfied by the original map in [BS]. The set of conditions considered in this paper is thus non optimal to obtain a complete answer to our general question.

2.2 Elementary properties of the permutations δ and γ

The combinatorics of our class of maps is mainly encoded via the permutations δ and γ . For the rest of the work we need to understand, in particular, the cycle structure of these permutations. These cycles will appear everywhere. In this paragraph we point out some elementary properties of these permutations.

Lemma 2.2. *The permutations γ and δ are conjugated, more precisely $\gamma = \iota^{-1}\delta^{-1}\iota$.*

Proof. Since δ and δ^{-1} are conjugated and $\iota^{-1}\delta^{-1}\iota = \iota(\iota\zeta^{-1})\iota = \zeta^{-1}\iota = \gamma$, then δ and γ are conjugated. \square

To simplify the notations we will sometimes use: $\bar{j} := \iota(j)$.

The two permutations γ and δ have the same cycle structure. We obtain γ from δ^{-1} by changing j to \bar{j} on its cycles. The cycle of γ that contains \bar{j} and the cycle of δ that contains j have the same length. We denote this number by $\ell[j]$.

Lemma 2.3. *The integers $\zeta^{-1}(j)$, \bar{j} and $\overline{\delta^{m-1}(j)}$ belong to the same cycle of γ of length $\ell[j]$, for all $j \in \{1, \dots, 2N\}$ and $0 < m \leq \ell[j]$.*

Proof. From the definitions of ι , γ , δ and Lemma 2.2, we have: $\gamma(\bar{j}) = \zeta^{-1}\iota(\iota(j)) = \zeta^{-1}(j)$ and $\overline{\delta^{m-1}(j)} = \iota(\delta^m\delta^{-1}(j)) = (\iota\delta^m\iota^{-1})\zeta^{-1}(j) = \gamma^{-m}(\zeta^{-1}(j))$. \square

Lemma 2.4. *If $1 \leq m \leq \ell[\bar{j}]$, then $\zeta(\gamma^m(j)) = \overline{\gamma^{m-1}(j)}$. In particular if $\ell[\bar{j}]$ is even and $k(\bar{j}) = \ell[\bar{j}]/2$ then $\zeta(\delta^{k(\bar{j})-1}\zeta(j)) = \gamma^{k(\bar{j})-1}(j)$.*

Proof. Notice that $\zeta(\gamma^m(j)) = \zeta\gamma(\gamma^{m-1}(j)) = \zeta(\zeta^{-1}\iota)(\gamma^{m-1}(j)) = \overline{\gamma^{m-1}(j)}$, and suppose that $\ell[\bar{j}]$ is even and let $k(\bar{j}) = \ell[\bar{j}]/2$. From the first part of this Lemma, to obtain $\zeta(\delta^{k(\bar{j})-1}\zeta(j)) = \gamma^{k(\bar{j})-1}(j)$, it is enough to show that $\overline{\delta^{k(\bar{j})-1}\zeta(j)} = \gamma^{k(\bar{j})}(j)$. In fact, by Lemma 2.2 and the definition of δ we have: $\gamma^{k(\bar{j})}(j) = \iota^{-1}\delta^{-k(\bar{j})}\iota(j) = \overline{\delta^{k(\bar{j})}\iota(j)} = \overline{\delta^{k(\bar{j})-1}\delta\iota(j)} = \overline{\delta^{k(\bar{j})-1}\zeta(j)}$. \square

Lemma 2.5. *$\gamma(\overline{\delta^m(j)}) = \overline{\delta^{m-1}(j)}$ and $\delta(\overline{\gamma^m(\zeta^{-1}(j))}) = \overline{\gamma^{m-1}(\zeta^{-1}(j))}$, for $m = 1, \dots, \ell[\bar{j}]$.*

Proof. In fact, by Lemma 2.4 and ι, γ, δ , we have: $\gamma(\overline{\delta^m(j)}) = \zeta^{-1}\iota(\iota\delta^m(j)) = \zeta^{-1}\delta(\delta^{m-1}(j)) = \zeta^{-1}\zeta(\overline{\delta^{m-1}(j)}) = \overline{\delta^{m-1}(j)}$, and $\delta(\gamma^m(\zeta^{-1}(j))) = \zeta\iota(\iota\gamma^m(\zeta^{-1}(j))) = \zeta\gamma(\gamma^{m-1}(\zeta^{-1}(j))) = \overline{\gamma^{m-1}(\zeta^{-1}(j))}$. \square

Lemma 2.6. *If $\ell[j]$ is even and $k(j) = \ell[j]/2$ then the relations $\alpha(j) := \gamma^{k(j)-1}(\zeta^{-1}(j))$ and $\beta(j) := \delta^{k(\zeta(j))-1}(\zeta(j))$ are permutations on $\{1, \dots, 2N\}$, with $\beta = \alpha^{-1}$.*

Proof. It is enough to show that both are injective. In fact,

$$\alpha(i) = \alpha(j) \iff \gamma^{k(i)-1}(\zeta^{-1}(i)) = \gamma^{k(j)-1}(\zeta^{-1}(j)) \iff \zeta^{-1}(i) = \gamma^{k(j)-k(i)}(\zeta^{-1}(j))$$

then both, $\zeta^{-1}(i)$ and $\zeta^{-1}(j)$, are in the same cycle of γ . Equivalently, by Lemma 2.2, $\delta^{-1}(i)$ and $\delta^{-1}(j)$ are in the same cycle of δ . But this equivalence means that i and j are in the same cycle of δ and therefore $k(i) = k(j)$. Using this in the last equality above, we obtain $\zeta^{-1}(i) = \zeta^{-1}(j)$ and $i = j$. Analogously we show that β is injective.

Finally, we show that $\beta(i) = \alpha^{-1}(i)$. In fact, since $\gamma = \iota^{-1}\delta^{-1}\iota$, we have:

$$\begin{aligned} \alpha(\beta(i)) &= \gamma^{k(\beta(i))-1}\zeta^{-1}(\beta(i)) = \gamma^{k(\beta(i))-1}\zeta^{-1}(\delta^{k(\zeta(i))-1}\zeta(i)) = \\ &= \gamma^{k(\beta(i))-1}\zeta^{-1}\iota\gamma^{-k(\zeta(i))+1}\iota^{-1}\zeta(i) = \gamma^{k(\beta(i))}\gamma^{-k(\zeta(i))}(i) \end{aligned}$$

and since, by definition of β , $\beta(i)$ and $\zeta(i)$ are in the same cycle of δ then $k(\beta(i)) = k(\zeta(i))$ and, from the last equality above: $\alpha(\beta(i)) = i$. \square

3 Construction of a group from the map Φ

In this section we construct a group from any map Φ in the class defined in §2.1, as announced in the title. The group is a subgroup of $\text{Homeo}^+(S^1)$ obtained in several steps. The first goal is to construct a finite set of homeomorphisms, as potential generators of the group. The final step is to verify that this collection satisfies some relations in $\text{Homeo}^+(S^1)$. It is notoriously difficult to check a relation, i.e., an equality in a group. Here the guidelines are the specific properties of the map Φ , in particular the conditions (EC), (E+), (E-).

The construction of the potential generating homeomorphisms has several steps. From a “toy model” construction to a family of diffeomorphisms with integers parameters. The toy model construction from Φ is a simple connect-the-dot operation. The family of diffeomorphisms is an improvement of this construction, it has the property that some particular compositions of the diffeomorphisms, given by the map, are satisfied “locally” i.e., on some intervals. These local equalities are obtained from the dynamical conditions (EC), (E+), (E-). The final step is a limit process: when the parameters grow, the local equalities become global i.e., the intervals on which an equality occurs are growing to cover all S^1 at the limit.

3.1 A toy model construction of diffeomorphisms from Φ

By condition (CS) we replace our initial piecewise homeomorphism Φ by the piecewise affine map $\tilde{\Phi}$ with constant slope $\lambda > 1$, where $\tilde{\Phi} = g^{-1} \circ \Phi \circ g$, for $g \in \text{Homeo}^+(S^1)$. The piecewise affine map $\tilde{\Phi}$ is defined by a partition: $S^1 = \bigcup_{j=1}^{2N} \tilde{I}_j$, where:

$$\tilde{I}_j = [\tilde{z}_j, \tilde{z}_{\zeta(j)}] := g^{-1}(I_j) \text{ and } \tilde{\Phi}_j := \tilde{\Phi}|_{\tilde{I}_j}, \text{ for } j \in \{1, \dots, 2N\}.$$

Lemma 3.1. *Assume $\Phi : S^1 \rightarrow S^1$ is a piecewise homeomorphism of S^1 satisfying the conditions (SE) and (CS) with slope $\lambda > 1$. For each $j \in \{1, \dots, 2N\}$, using the notations above, there is a class of diffeomorphisms $[f_j] \subset \text{Diff}^+(S^1)$ such that:*

- (1) For each $f_j \in [f_j]$, $(f_j)|_{\tilde{I}_j} = \tilde{\Phi}_j$ and $(f_j)|_{\tilde{\Phi}_{\iota(j)}(\tilde{I}_{\iota(j)})} = (\tilde{\Phi}_{\iota(j)})_{|\tilde{\Phi}_{\iota(j)}(\tilde{I}_{\iota(j)})}^{-1}$,
- (2) f_j is a hyperbolic Möbius like diffeomorphism i.e., with one attractive and one repelling fixed point and one pair of neutral points i.e., with derivative one.
- (3) $(f_j)^{-1} = f_{\iota(j)}$.

Proof. Since the intervals I_j and $\Phi(I_{\iota(j)})$ are disjoint by condition (SE), then \tilde{I}_j and $\tilde{\Phi}_{\iota(j)}(\tilde{I}_{\iota(j)})$ are disjoint and the condition (1) has no constraints.

By condition (CS) the slope of $\tilde{\Phi}$ in \tilde{I}_j and $\tilde{I}_{\iota(j)}$ is λ , then $(f_j)|_{\tilde{I}_j}$ is affine of slope λ and $(f_j)|_{\tilde{\Phi}_{\iota(j)}(\tilde{I}_{\iota(j)})}$ is affine of slope λ^{-1} . The map f_j is defined on $\tilde{I}_j \cup \tilde{\Phi}_{\iota(j)}(\tilde{I}_{\iota(j)})$, it remains to define it on the complementary intervals:

$$S^1 - (\tilde{I}_j \cup \tilde{\Phi}_{\iota(j)}(\tilde{I}_{\iota(j)})) = L_j \cup R_j, \quad (3)$$

where $L_j := [\tilde{\Phi}_{\iota(j)}(\tilde{z}_{\delta(j)}), \tilde{z}_j]$ and $R_j := [\tilde{z}_{\zeta(j)}, \tilde{\Phi}_{\iota(j)}(\tilde{z}_{\iota(j)})]$ (see Figure 2).

The existence of the diffeomorphism f_j is a “differentiable connect-the-dots” construction. The constraints are the images of the extreme points:

$$f_j(\partial\tilde{I}_j) = \partial\tilde{\Phi}_j(\tilde{I}_j) \text{ and } f_j(\partial\tilde{\Phi}_{\iota(j)}(\tilde{I}_{\iota(j)})) = \partial\tilde{I}_{\iota(j)},$$

together with the derivatives at these points which are, respectively λ and λ^{-1} . The

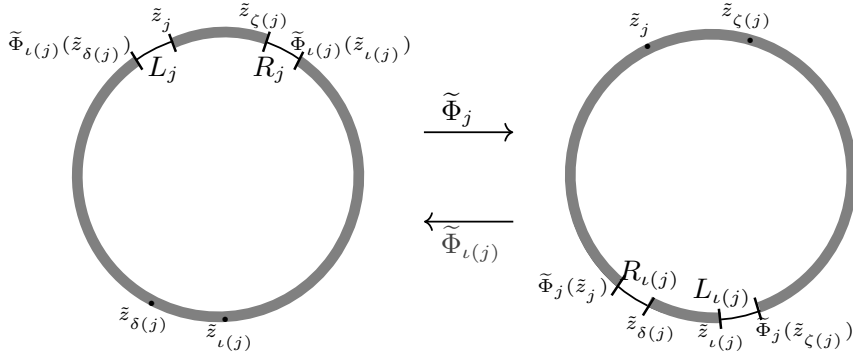

Figure 2: The connect-the-dot construction of $f_j \in \text{Diff}^+(S^1)$

connect the dot construction is simple enough and we could stop here. We give more

precisions that will be needed later. Let X and Y be two disjoint intervals of S^1 , we denote $\partial^\pm X$ the two boundary points of X , where the indices \pm refer to the orientation of the interval. Let $\text{Diff}^+(X, Y)$ be the space of orientation preserving diffeomorphisms from X to Y . Let $a, b \in \mathbb{R}^+$ and dg be the derivative of g , we define:

$$\begin{aligned} \text{Diff}_{a,b}^+(X, Y) &= \{g \in \text{Diff}^+(X, Y) : dg(\partial^- X) = a > 0, dg(\partial^+ X) = b > 0\}, \\ \text{if } a \neq b : \text{Diff}_{a,b}^{(mon)}(X, Y) &:= \{g \in \text{Diff}_{a,b}^+(X, Y) : dg \text{ is monotone}\}. \end{aligned} \quad (4)$$

We define f_j on the two intervals L_j and R_j . The image of these intervals are, by condition (1), respectively: $R_{\iota(j)}$ and $L_{\iota(j)}$.

Since f_j is required to be a diffeomorphism, the derivative df_j varies continuously from $\lambda > 1$ to $\lambda^{-1} < 1$ along R_j and from $\lambda^{-1} < 1$ to $\lambda > 1$ on L_j . In other words:

$$f_j|_{R_j} \in \text{Diff}_{\lambda, \lambda^{-1}}^+(R_j, L_{\iota(j)}) \text{ and } f_j|_{L_j} \in \text{Diff}_{\lambda^{-1}, \lambda}^+(L_j, R_{\iota(j)}).$$

Thus f_j is highly non unique. By the intermediate values theorem and $\lambda > 1$, there is at least one point with derivative one i.e., a neutral point, in each interval L_j and R_j .

Condition (2) requires the existence of exactly one neutral point N_j^+ in R_j and one neutral point N_j^- in L_j . This is the simplest situation, it is realized if the derivative varies monotonically in R_j and L_j , in other words:

$$f_j|_{R_j} \in \text{Diff}_{\lambda, \lambda^{-1}}^{(mon)}(R_j, L_{\iota(j)}) \text{ and } f_j|_{L_j} \in \text{Diff}_{\lambda^{-1}, \lambda}^{(mon)}(L_j, R_{\iota(j)}).$$

By condition (SE) and (CS), see the property (II'), the map f_j has exactly two fixed points, one expanding in \tilde{I}_j and one contracting in $\tilde{I}_{\iota(j)}$. Therefore, with the above choices, condition (2) of the Lemma is satisfied for f_j and $f_{\iota(j)}$.

Let us denote by $\{f_j\}$ the subset of $\text{Diff}^+(S^1)$ satisfying conditions (1) and (2). Fixing $f_j \in \{f_j\}$, by construction we have $f_j^{-1} \in \{f_{\iota(j)}\}$. Therefore the pair f_j, f_j^{-1} satisfies the condition (3) of Lemma 3.1. Let us denote by $[f_j]$ the subset of $\text{Diff}^+(S^1)$ satisfying (1), (2), (3). \square

3.2 Dynamical properties of Φ

From now on the map Φ satisfies all the ruling conditions of §2.1 i.e., the conditions (SE), (EC), (E+), (E-), (CS), they are crucial for the next important result.

Lemma 3.2. *Let $\Phi : S^1 \rightarrow S^1$ be a piecewise homeomorphism satisfying conditions (SE), (EC), (E+), (E-), (CS). Then there exists a maximal neighborhood V_j of the cutting point z_j , for all $j \in \{1, \dots, 2N\}$, such that $\Phi^{k(j)}|_{V_j}$ is continuous and conjugated to an affine diffeomorphism $\tilde{\Phi}^{k(j)}|_{\tilde{V}_j}$ with slope $\lambda^{k(j)}$. The number $\lambda > 1$ is given by condition (CS) and $k(j)$ is the integer of condition (EC) for the cutting point z_j . The neighborhood \tilde{V}_j of \tilde{z}_j is the image of V_j under $g^{-1} \in \text{Homeo}^+(S^1)$ that conjugates Φ to $\tilde{\Phi}$.*

Proof. As in the previous proof, we replace the piecewise homeomorphism Φ by the piecewise affine map $\tilde{\Phi}$ with constant slope $\lambda > 1$, using condition (CS) and the conjugacy given by $g \in \text{Homeo}^+(S^1)$.

Let $\tilde{z}_j^{k(j)} \in S^1$ be the point defined by condition (EC) for the cutting point \tilde{z}_j i.e.:

$$\delta_j^{k(j)} = \tilde{\Phi}^{k(j)-1}(\tilde{\Phi}_{\zeta^{-1}(j)}(\tilde{z}_j)) = \tilde{\Phi}^{k(j)-1}(\tilde{\Phi}_j(\tilde{z}_j)).$$

Suppose that $\delta_j^{k(j)} \in \tilde{I}_{a_j}$, for some $a_j \in \{1, \dots, 2N\}$.

Consider the pre-image of the point $\delta_j^{k(j)}$ from the left and the right, along the orbits of the cutting point \tilde{z}_j . Namely we consider the points:

$$\begin{aligned} \delta_{\delta^{k(j)-1}(j)} &= \tilde{\Phi}^{k(j)-2}(\tilde{\Phi}_j(\tilde{z}_j)) \in \tilde{I}_{\delta^{k(j)-1}(j)} \text{ by (E+)} , \\ \delta_{\gamma^{k(j)-1}(\zeta^{-1}(j))} &= \tilde{\Phi}^{k(j)-2}(\tilde{\Phi}_{\zeta^{-1}(j)}(\tilde{z}_j)) \in \tilde{I}_{\gamma^{k(j)-1}(\zeta^{-1}(j))} \text{ by (E-)} . \end{aligned}$$

In order to simplify the notations let us define (see Figure 3):

$$\begin{aligned} c_j &:= \gamma^{k(j)-1}(\zeta^{-1}(j)), \quad d_j := \delta^{k(j)-1}(j), \\ J_{c_j} &:= [\tilde{z}_{c_j}, \delta_{c_j}] \subset I_{c_j}, \quad J_{d_j} := [\delta_{d_j}, \tilde{z}_{\zeta(d_j)}] \subset I_{d_j}, \end{aligned} \quad (5)$$

From condition (EC) and the definitions above we obtain:

$$\tilde{\Phi}_{c_j}(J_{c_j}) \cap \tilde{\Phi}_{d_j}(J_{d_j}) = \delta_j^{k(j)} \text{ and } \tilde{\Phi}_{c_j}(J_{c_j}) \cup \tilde{\Phi}_{d_j}(J_{d_j}) \text{ is connected.}$$

Define the $(\tilde{\Phi}^{k(j)-1})$ -pre-images of J_{c_j} and J_{d_j} along the two orbits of \tilde{z}_j i.e., the left and the right orbits. These pre-images belong respectively to the intervals \tilde{I}_j and $\tilde{I}_{\zeta^{-1}(j)}$ and we obtain:

$$V_j^{c_j} = [\tilde{\Phi}^{-k(j)+1}(\tilde{z}_{c_j}), \tilde{z}_j] \subset \tilde{I}_{\zeta^{-1}(j)} \text{ and } V_j^{d_j} = [\tilde{z}_j, \tilde{\Phi}^{-k(j)+1}(\tilde{z}_{\zeta(d_j)})] \subset \tilde{I}_j. \quad (6)$$

We define a neighborhood of the cutting point \tilde{z}_j by $\tilde{V}_j := V_j^{c_j} \cup V_j^{d_j}$.

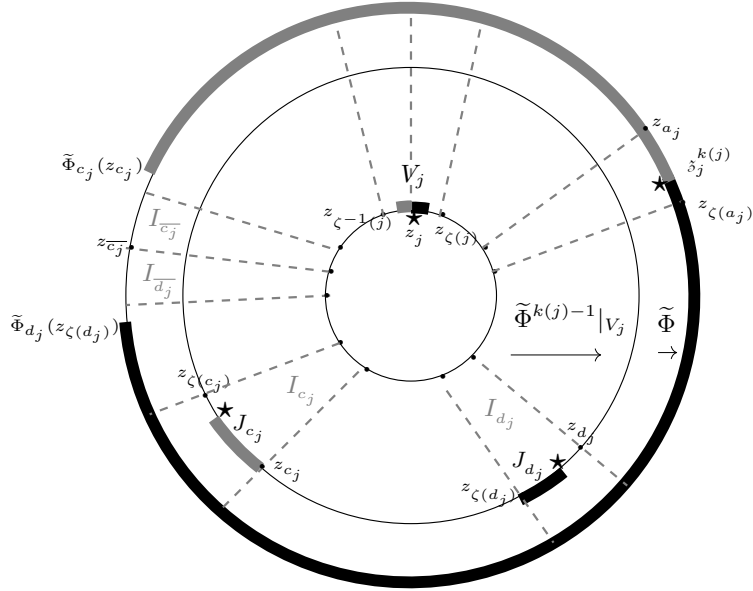

Figure 3: The neighborhood \tilde{V}_j and its image by $\tilde{\Phi}^{k(j)}$

By condition (EC), $\tilde{\Phi}^{k(j)}$ is continuous on \tilde{V}_j and:
 $\tilde{\Phi}^{k(j)}(\tilde{V}_j) = \tilde{\Phi}_{c_j}(J_{c_j}) \cup \tilde{\Phi}_{d_j}(J_{d_j}) = [\tilde{\Phi}_{c_j}(\tilde{z}_{c_j}), \tilde{\Phi}_{d_j}(\tilde{z}_{\zeta(d_j)})]$. It satisfies, by condition (SE), the following property (see Figure 3):

$$\tilde{\Phi}^{k(j)}(\tilde{V}_j) \cap \tilde{I}_k \neq \emptyset, \forall k \neq \overline{c_j}, \overline{d_j}. \quad (7)$$

By Lemma 2.4, the indices $\overline{c_j}$ and $\overline{d_j}$ in condition (7) are adjacent with: $\zeta(\overline{d_j}) = \overline{c_j}$. From Lemma 2.3, the cycles containing j and $\overline{c_j}$ are the same and thus $k(\overline{c_j}) = k(j)$.

The map $\tilde{\Phi}^{k(j)}|_{\tilde{V}_j}$ is affine of slope $\lambda^{k(j)}$. Indeed, by definition of $V_j^{c_j}$, $V_j^{d_j}$ and conditions (E \pm), the following properties are satisfied:

$\forall z \in V_j^{d_j} : \tilde{\Phi}^m(z) \in \tilde{I}_{\delta^m(j)}$ and $\forall z \in V_j^{c_j} : \tilde{\Phi}^m(z) \in \tilde{I}_{\gamma^m(\zeta^{-1}(j))}$, for $m = 1, \dots, k(j) - 1$. Then we obtain:

$$\begin{aligned} \tilde{\Phi}^{k(j)}(z) &= \tilde{\Phi}_{\delta^{k(j)-1}(j)} \circ \dots \circ \tilde{\Phi}_{\delta(j)} \circ \tilde{\Phi}_j(z), \forall z \in V_j^{d_j} \text{ and} \\ \tilde{\Phi}^{k(j)}(z) &= \tilde{\Phi}_{\gamma^{k(j)-1}(\zeta^{-1}(j))} \circ \dots \circ \tilde{\Phi}_{\gamma(\zeta^{-1}(j))} \circ \tilde{\Phi}_{\zeta^{-1}(j)}(z), \forall z \in V_j^{c_j}. \end{aligned} \quad (8)$$

Thus, $\tilde{\Phi}^{k(j)}(z)$ is affine of slope $\lambda^{k(j)}$ for $z \in V_j^{c_j} \cup V_j^{d_j} = \tilde{V}_j$, as a composition of $k(j)$ affine maps, each of slope λ , on each side. The definition of the intervals J_{d_j} and J_{c_j} in (5) implies that in the above composition, $\tilde{\Phi}_{\delta^{k(j)-1}(j)}$ and $\tilde{\Phi}_{\gamma^{k(j)-1}(\zeta^{-1}(j))}$ are affine of slope λ and these intervals are the maximal with that property for the compositions in (8). This completes the proof of the maximality property. The neighborhood V_j of the Lemma is then simply: $V_j = g(\tilde{V}_j)$, where g conjugates Φ with $\tilde{\Phi}$. \square

3.3 Affine extensions

In this subsection we extend the construction of the diffeomorphisms in the classe $[f_j]$ given by Lemma 3.1. The idea for these extensions comes from the properties (EC), (E \pm) and the expressions in (8) that are expected to become some local equalities i.e., equal on an interval.

The first step is to enlarge the intervals on which the diffeomorphisms constructed in Lemma 3.1 are affine. To that end we consider a collection of neighborhoods: $\nu_j = \nu_j(\tilde{z}_j)$ of the cutting points \tilde{z}_j for all $j \in \{1, \dots, 2N\}$. These neighborhoods are chosen small enough to satisfy: $\nu_j \subset \tilde{I}_j \cup \tilde{I}_{\zeta^{-1}(j)}$ with $\nu_j \cap \nu_{\zeta(j)} = \emptyset$ and $\nu_j \cap \nu_{\zeta^{-1}(j)} = \emptyset$.

We define the λ -affine extension $\tilde{\Phi}'_j$ of $\tilde{\Phi}_j$ as a λ -affine map on the interval:

$$I'_j := \tilde{I}_j \cup \nu_j \cup \nu_{\zeta(j)}, \text{ satisfying: } (\tilde{\Phi}'_j)|_{I'_j} \text{ is } \lambda\text{-affine and } (\tilde{\Phi}'_j)|_{\tilde{I}_j} = (\tilde{\Phi}_j)|_{\tilde{I}_j}. \quad (9)$$

Proposition 3.1. *If Φ satisfies the ruling conditions then there are small enough neighborhoods ν_j for all $j \in \{1, \dots, 2N\}$ so that the λ -affine extensions $\tilde{\Phi}'_j$ satisfy:*

$$\tilde{\Phi}'_j(\nu_j) \subset \tilde{I}_{\delta(j)} \setminus \nu_{\delta(j)} \text{ and } \tilde{\Phi}'_j(\nu_{\zeta(j)}) \subset \tilde{I}_{\gamma(j)} \setminus \nu_{\iota(j)} \text{ for all } j \in \{1, \dots, 2N\}.$$

Proof. From condition (SE): $\tilde{\Phi}_j(\tilde{z}_j) \in \tilde{I}_{\delta(j)}$ and $\tilde{\Phi}_j(\tilde{z}_{\zeta(j)}) \in \tilde{I}_{\gamma(j)}$. The λ -affine extension $\tilde{\Phi}'_j$ is continuous at \tilde{z}_j and $\tilde{z}_{\zeta(j)}$. Thus, if the neighborhoods $\nu_j, \nu_{\zeta(j)}, \nu_{\delta(j)}, \nu_{\iota(j)}$ are sufficiently small then the conditions of the Proposition are satisfied by continuity. \square

If all the neighborhoods ν_j are small enough for Proposition 3.1 to apply then the sets $S^1 \setminus (I_j^\nu \cup \tilde{\Phi}_{i(j)}^\nu(I_{i(j)}^\nu))$ and $S^1 \setminus (I_{i(j)}^\nu \cup \tilde{\Phi}_j^\nu(I_j^\nu))$ are non-empty and each one has two connected components:

$$S^1 \setminus (I_j^\nu \cup \tilde{\Phi}_{i(j)}^\nu(I_{i(j)}^\nu)) = L_j^\nu \cup R_j^\nu \text{ and } S^1 \setminus (I_{i(j)}^\nu \cup \tilde{\Phi}_j^\nu(I_j^\nu)) = L_{i(j)}^\nu \cup R_{i(j)}^\nu. \quad (10)$$

If all the neighborhoods ν_j are small enough so that the intervals in (10) contain an open interval, then we define the following family of diffeomorphisms for $j \in \{1, \dots, 2N\}$:

$[f_j^\nu] \subset \text{Diff}^+(S^1)$, “parametrised” by $\nu := \{\nu_j : j \in \{1, \dots, 2N\}\}$ such that:

$$\begin{aligned} \text{[i]} \quad & (f_j^\nu)|_{I_j^\nu} := (\tilde{\Phi}_j^\nu)|_{I_j^\nu} \text{ and } (f_j^\nu)|_{\tilde{\Phi}_{i(j)}^\nu(I_{i(j)}^\nu)} := (\tilde{\Phi}_{i(j)}^\nu)^{-1}|_{\tilde{\Phi}_{i(j)}^\nu(I_{i(j)}^\nu)}, \\ \text{[ii]} \quad & (f_j^\nu)|_{L_j^\nu} \in \text{Diff}_{\lambda^{-1}, \lambda}^{(mon)}(L_j^\nu; R_{i(j)}^\nu) \text{ and } (f_j^\nu)|_{R_j^\nu} \in \text{Diff}_{\lambda, \lambda^{-1}}^{(mon)}(R_j^\nu; L_{i(j)}^\nu), \\ \text{[iii]} \quad & (f_j^\nu)^{-1} := f_{i(j)}^\nu. \end{aligned} \quad (11)$$

The diffeomorphisms in the class $[f_j^\nu]$ are similar but different to the class $[f_j]$ of Lemma 3.1. They are affine on larger intervals and the diffeomorphisms f_j^ν and $f_{\zeta^{\pm 1}(j)}^\nu$ are affine on a common interval: $\nu_{\zeta(j)}$ or ν_j respectively.

Lemma 3.3. *Let Φ satisfy the ruling assumptions: (SE), (EC), (E+), (E-), (CS), and $\tilde{V} = \{\tilde{V}_j : j \in \{1, \dots, 2N\}\}$ be the set of neighborhoods of Lemma 3.2. Then, for all j :*

- (a) \tilde{V}_j satisfies Proposition 3.1: $\tilde{\Phi}_j^{\tilde{V}}(\tilde{V}_j) \subset \tilde{I}_{\delta(j)} \setminus \tilde{V}_{\delta(j)}$ and $\tilde{\Phi}_j^{\tilde{V}}(\tilde{V}_{\zeta(j)}) \subset \tilde{I}_{\gamma(j)} \setminus \tilde{V}_{i(j)}$, and
(b) $\left(\tilde{\Phi}_{\delta^{k(j)-1}(j)}^{\tilde{V}} \circ \dots \circ \tilde{\Phi}_{\delta(j)}^{\tilde{V}} \circ \tilde{\Phi}_j^{\tilde{V}}\right)|_{\tilde{V}_j} = \left(\tilde{\Phi}_{\gamma^{k(j)-1}(\zeta^{-1}(j))}^{\tilde{V}} \circ \dots \circ \tilde{\Phi}_{\gamma(\zeta^{-1}(j))}^{\tilde{V}} \circ \tilde{\Phi}_{\zeta^{-1}(j)}^{\tilde{V}}\right)|_{\tilde{V}_j}$,
where $k(j)$ is the integer of condition (EC) at the cutting point \tilde{z}_j .

Proof. From the proof of Lemma 3.2, the conditions (7) are satisfied for the neighborhoods \tilde{V}_j . To simplify the formulation we consider the situation where $k(j) = 3$. Conditions (7) and (SE) imply, in particular that:

$$\tilde{\Phi}^3(\tilde{V}_j) \subset \tilde{\Phi}_{\delta^2(j)}(\tilde{I}_{\delta^2(j)}) \text{ and symmetrically } \tilde{\Phi}^3(\tilde{V}_j) \subset \tilde{\Phi}_{\gamma^2(\zeta^{-1}(j))}(\tilde{I}_{\gamma^2(\zeta^{-1}(j))}). \text{ Thus:}$$

$$\tilde{\Phi}_{\delta^2(j)}^{-1}(\tilde{\Phi}^3(\tilde{V}_j)) \subset \tilde{I}_{\delta^2(j)} \text{ and } \tilde{\Phi}_{\gamma^2(\zeta^{-1}(j))}^{-1}(\tilde{\Phi}^3(\tilde{V}_j)) \subset \tilde{I}_{\gamma^2(\zeta^{-1}(j))}.$$

We focus on one side, for instance the $\delta(j)$ -side. The inclusion is in fact more restrictive: $\tilde{\Phi}_{\delta^2(j)}^{-1}(\tilde{\Phi}^3(\tilde{V}_j)) = [\alpha; \tilde{z}_{\zeta(\delta^2(j))}] \subset \tilde{I}_{\delta^2(j)}$ and α satisfies: $\alpha > \tilde{\Phi}_{\delta(j)}(\tilde{z}_{\delta(j)})$ with $\tilde{\Phi}_{\delta(j)}(\tilde{z}_{\delta(j)}) \in \tilde{I}_{\delta^2(j)}$. Indeed, by condition (E+) for the cutting point $\tilde{z}_{\delta(j)}$, we have:

$\tilde{\Phi}_{\delta^2(j)}(\tilde{\Phi}_{\delta(j)}(\tilde{z}_{\delta(j)})) \in \tilde{I}_{\gamma^2(\zeta^{-1}(j))}$ and $\tilde{\Phi}_{\delta^2(j)}(\alpha) \notin \tilde{I}_{\gamma^2(\zeta^{-1}(j))}$, by (7). This implies:

$$\tilde{\Phi}_{\delta^2(j)}^{-1}(\tilde{\Phi}^3(\tilde{V}_j)) \subset \tilde{\Phi}_{\delta(j)}(\tilde{I}_{\delta(j)}) \cap \tilde{I}_{\delta^2(j)} \text{ and thus we obtain } \tilde{\Phi}_{\delta(j)}^{-1} \circ \tilde{\Phi}_{\delta^2(j)}^{-1}(\tilde{\Phi}^3(\tilde{V}_j)) \subset \tilde{I}_{\delta(j)}.$$

The map $\tilde{\Phi}_{\delta(j)}^{-1} \circ \tilde{\Phi}_{\delta^2(j)}^{-1} \circ \tilde{\Phi}_{\tilde{V}_j}^3$ is defined from \tilde{V}_j to $\tilde{I}_{\delta(j)}$. It is an affine map of slope λ since $\tilde{\Phi}_{\delta(j)}^{-1}$ and $\tilde{\Phi}_{\delta^2(j)}^{-1}$ are affine of slope λ^{-1} and $\tilde{\Phi}_{\tilde{V}_j}^3$ is affine of slope λ^3 by Lemma 3.2.

By definition of the λ -affine extension $\tilde{\Phi}_j^\nu$ with $\nu = \tilde{V}$ in (9) and, since:

$$\tilde{\Phi}_{\delta(j)}^{-1} \circ \tilde{\Phi}_{\delta^2(j)}^{-1} \circ \tilde{\Phi}_{\tilde{V}_j \cap \tilde{I}_j}^3 = \tilde{\Phi}_j|_{\tilde{V}_j \cap \tilde{I}_j}, \text{ we obtain } \tilde{\Phi}_j^{\tilde{V}}(\tilde{V}_j) = \tilde{\Phi}_{\delta(j)}^{-1} \circ \tilde{\Phi}_{\delta^2(j)}^{-1} \circ \tilde{\Phi}^3(\tilde{V}_j) \subset \tilde{I}_{\delta(j)}, \text{ this}$$

is a part of the result (a) in the Lemma.

We apply the same arguments to the neighborhood $\tilde{V}_{\delta(j)}$ and we obtain:

$$\tilde{\Phi}_{\delta(j)}^{\tilde{V}}(\tilde{V}_{\delta(j)}) \subset \tilde{I}_{\delta^2(j)} \text{ and } \tilde{\Phi}_{\delta^2(j)}^{\tilde{V}} \circ \tilde{\Phi}_{\delta(j)}^{\tilde{V}}(\tilde{V}_{\delta(j)}) \subset \tilde{I}_{\gamma^2(\zeta^{-1}(j))}.$$

The last inclusion comes from Lemma 2.5 for $k(j) = 3$, i.e. : $\delta^3(j) = \gamma^2(\zeta^{-1}(j))$.

Hence, we obtain that: $\tilde{\Phi}_{\delta(j)}^{\tilde{V}}(\tilde{V}_{\delta(j)})$ and $\tilde{\Phi}_{\delta(j)}^{\tilde{V}} \circ \tilde{\Phi}_j^{\tilde{V}}(\tilde{V}_j)$ are two disjoint sub-intervals of $\tilde{I}_{\delta^2(j)}$ and then $\tilde{V}_{\delta(j)} \cap \tilde{\Phi}_j^{\tilde{V}}(\tilde{V}_j) = \emptyset$.

This completes the proof of condition (a) for the δ -side in the case $k(j) = 3$. For the γ -side we replace condition (E+) by (E-) and use the same arguments. The general argument, for any $k(j)$, is the same with more compositions.

The neighborhoods $\tilde{V}_j = V_j^{c_j} \cup V_j^{d_j}$ in the proof of Lemma 3.2 satisfy the equality (8). Moreover, by definition of the λ -affine extension $\tilde{\Phi}_j^{\tilde{V}}$ on the interval $I_j^{\tilde{V}}$ in (9), the two maps $\tilde{\Phi}_j^{\tilde{V}}$ and $\tilde{\Phi}_{\zeta^{-1}(j)}^{\tilde{V}}$ are λ -affine on \tilde{V}_j with:

$$\tilde{\Phi}_j^{\tilde{V}}(\tilde{V}_j) \subset \tilde{I}_{\delta(j)} \setminus \tilde{V}_{\delta(j)} \text{ and } \tilde{\Phi}_{\zeta^{-1}(j)}^{\tilde{V}}(\tilde{V}_j) \subset \tilde{I}_{\gamma(\zeta^{-1}(j))} \setminus \tilde{V}_{i(\zeta^{-1}(j))},$$

from the property (a) above. Hence, as in Lemma 3.2, both compositions in each side of (b) are affine of slope $\lambda^{k(j)}$ and by (EC) they are equal on the point $\{\tilde{z}_j\} = V_j^{c_j} \cap V_j^{d_j}$. Thus the equality (b) is satisfied in \tilde{V}_j . \square

3.4 A parametrised extension family from Φ

The goal of this paragraph is to extend further, in a parametrised way, the set of neighborhoods $\nu = \{\nu_j : j = 1, \dots, 2N\}$ used in the family f_j^ν in (11).

We first enlarge each neighborhood in the collection, from \tilde{V}_j to W_j , on which the diffeomorphisms are affine. Recall the definition of \tilde{V}_j via the left and right pre-images of the intervals: $J_{c_j} := [\tilde{z}_{c_j}, \delta_{c_j}] \subset \tilde{I}_{c_j}$ and $J_{d_j} := [\delta_{d_j}, \tilde{z}_{\zeta(d_j)}] \subset \tilde{I}_{d_j}$, given in (5).

Recall that $I_j^{\tilde{V}} = \tilde{V}_j \cup \tilde{I}_j \cup \tilde{V}_{\zeta(j)}$ (see (9) for $\nu = \tilde{V} = \{\tilde{V}_j : j \in \{1, \dots, 2N\}\}$, the set of neighborhoods of Lemma 3.2) and let us consider the intervals: $J'_{c_j} := [\partial^-(I_{c_j}^{\tilde{V}}); \delta_{c_j}]$ and $J'_{d_j} := [\delta_{d_j}; \partial^+(I_{d_j}^{\tilde{V}})]$. They satisfy:

$$\begin{aligned} \text{[i]} \quad & I_{c_j}^{\tilde{V}} \supset J'_{c_j} \supset J_{c_j} \text{ and } I_{d_j}^{\tilde{V}} \supset J'_{d_j} \supset J_{d_j}, \\ \text{[ii]} \quad & \tilde{\Phi}_{c_j}^{\tilde{V}}(J'_{c_j}) \cap \tilde{\Phi}_{d_j}^{\tilde{V}}(J'_{d_j}) = \delta_j^{k(j)} \text{ by condition (EC)}. \end{aligned} \tag{12}$$

Let $\mathscr{W}_j := \tilde{\Phi}_{c_j}^{\tilde{V}}(J'_{c_j}) \cup \tilde{\Phi}_{d_j}^{\tilde{V}}(J'_{d_j})$, then from Lemma 3.3, exactly as in (7), it satisfy:

$$\mathscr{W}_j \cap I_k^{\tilde{V}} \neq \emptyset, \text{ for all } k \neq \overline{c_j}, \overline{d_j} \text{ and } j \in \{1, \dots, 2N\}. \tag{13}$$

The neighborhood \tilde{V}_j was defined as the pre-images of the intervals J_{c_j} and J_{d_j} along the orbit of the cutting point \tilde{z}_j . We do the same for the intervals J'_{c_j} and J'_{d_j} . The various pre-images of J'_{c_j} and J'_{d_j} under $\tilde{\Phi}$ are well defined, for instance:

$$J'_{d_j} \subset \tilde{\Phi}_{\delta^{k(j)-2}}(\tilde{I}_{\delta^{k(j)-2}}) \text{ and thus } (\tilde{\Phi}_{\delta^{k(j)-2}})^{-1}(J'_{d_j}) \subset \tilde{I}_{\delta^{k(j)-2}}.$$

We consider the $\tilde{\Phi}^{k(j)-1}$ pre-images of J'_{d_j} and J'_{c_j} along the two orbits of \tilde{z}_j exactly as

in (6), and we define:

$$W_j^- := \left[\tilde{\Phi}^{-k(j)+1} \left(\partial^- (I_{c_j}^{\tilde{V}}) \right); \tilde{z}_j \right] \subset \tilde{I}_{\zeta^{-1}(j)}, \quad W_j^+ := \left[\tilde{z}_j; \tilde{\Phi}^{-k(j)+1} \left(\partial^+ (I_{d_j}^{\tilde{V}}) \right) \right] \subset \tilde{I}_j \quad (14)$$

and $W_j := W_j^- \cup W_j^+ \supset \tilde{V}_j$.

There are several λ -affine extensions replacing $I_j^{\tilde{V}}$, namely:

$$I_j^{W^{1,0}} := W_j \cup \tilde{I}_j \cup \tilde{V}_{\zeta(j)}; \quad I_j^{W^{0,1}} := \tilde{V}_j \cup \tilde{I}_j \cup W_{\zeta(j)}; \quad I_j^{W^{1,1}} := W_j \cup \tilde{I}_j \cup W_{\zeta(j)}. \quad (15)$$

We denote the various λ -affine extensions, as in (9), by $\tilde{\Phi}_j^{W^*}$, where $*$ stands for any pair in $\{(0,0), (0,1), (1,0), (1,1)\}$, and $W_j^{(0,0)} = \tilde{V}_j$ as a convention.

The enlargement operation: $\tilde{V}_j \rightarrow W_j^*$ defined above can be iterated by replacing the intervals $I_j^{\tilde{V}}$ in definition (14) by any of the intervals $I_j^{W^*}$. This iteration can be done “ p ” times on the left ($-$) and “ q ” times on the right ($+$), for p, q arbitrary positive integers. More precisely, consider the recursive definition for each $j = 1, \dots, 2N$:

$$W_j^{0,0} = \tilde{V}_j, \quad \text{and } W_j^{p,q} := \left[\tilde{\Phi}^{-k(j)+1} \left(\partial^- (W_{c_j}^{p-1,q'}) \right); \tilde{\Phi}^{-k(j)+1} \left(\partial^+ (W_{\zeta(d_j)}^{p,q-1}) \right) \right], \quad (16)$$

for $p, q > 0$ and $p' \leq p-1, q' \leq q-1$.

This iterated enlargement defines a family of neighborhoods, parametrised by the indices (p, q) (see Figure 4). We define a λ -affine extensions $\tilde{\Phi}_j^{W^*}$, for each set of neighborhoods in: $W^* = \{W_j^{p_j, q_j}, j \in \{1, \dots, 2N\}, p_j \geq 0, q_j \geq 0\}$, on the interval:

$$I_j^{p,q} := I_j^{W^{p,q}} := W_j^{p,q} \cup \tilde{I}_j \cup W_{\zeta(j)}^{p',q'}, \quad (17)$$

for $p', q' \geq 0$ free indices.

The following result is a version of Lemma 3.3 for the neighborhoods W_j^* .

Proposition 3.2. *For the intervals $I_j^{p,q}$ and the extensions $\tilde{\Phi}_j^{W^*}$ defined above, and all pair of finite integers $(p, q) \in \mathbb{N} \times \mathbb{N}$ and $j \in \{1, \dots, 2N\}$ the following properties are satisfied:*

- (a) $\tilde{\Phi}_j^{(p,q)}(W_j^{p,q}) \subset \tilde{I}_{\delta(j)} \setminus W_{\delta(j)}^{p,q}$ and $\tilde{\Phi}_j^{(p,q)}(W_{\zeta(j)}^{p,q}) \subset \tilde{I}_{\gamma(j)} \setminus W_{\zeta(j)}^{p,q}$,
- (b) $\left(\tilde{\Phi}_{\delta^{k(j)-1}(j)}^{W^*} \circ \dots \circ \tilde{\Phi}_{\delta(j)}^{W^*} \circ \tilde{\Phi}_j^{W^*} \right) |_{W_j^{p,q}} = \left(\tilde{\Phi}_{\gamma^{k(j)-1}(\zeta^{-1}(j))}^{W^*} \circ \dots \circ \tilde{\Phi}_{\gamma(\zeta^{-1}(j))}^{W^*} \circ \tilde{\Phi}_{\zeta^{-1}(j)}^{W^*} \right) |_{W_j^{p,q}}$.

Proof. For $(p, q) = (0, 0)$ the result is Lemma 3.3, whose proof is based on the property (7). We observe that the condition (13) is exactly (7) when \tilde{V}_j is replaced by $W_j = W_j^{1,1}$ as given in (16). The condition (13) can be expressed as:

$(\tilde{\Phi}^{W^*})^{k(j)}(W_j^{1,1}) \cap \tilde{I}_k \neq \emptyset$, for all $k \neq \bar{c}_j, \bar{d}_j$, in this case $*$ = (1, 1). This is the first step of an induction giving, with an abuse of notations:

$$(\tilde{\Phi}^{W^*})^{k(j)}(W_j^{p,q}) \cap \tilde{I}_k \neq \emptyset, \quad \text{for all } k \neq \bar{c}_j, \bar{d}_j, \quad \text{and all finite } (p, q). \quad (18)$$

The arguments in the proof of Lemma 3.3 are now used inductively, using (18) in place of (7) with no new difficulties. \square

3.5 Generators and relations from Φ

The family of diffeomorphisms $[f_j^{\nu}]$ defined in (11) requires the collection of neighborhoods $\{\nu_j\}$ to satisfy the conditions of Proposition 3.1. This is part (a) in Lemma 3.3 and Proposition 3.2 for the collection of neighborhoods $\{\tilde{V}_j\}$ and $\{W_j^*\}$.

Therefore the set of diffeomorphisms $\{f_j^{W^*} : j \in \{1, \dots, 2N\}\}$ obtained from the neighborhoods $\{W_j^*\}$ is well defined. In the previous notation, the set of “parameters” is hidden in the symbol $*$, it represents $* = \{(p_j, q_j) \in \mathbb{N} \times \mathbb{N} : j \in \{1, \dots, 2N\}\}$.

Each diffeomorphism $f_j^{W^*}$ is affine of slope λ on the interval $I_j^{p_j, q_{\zeta(j)}}$, defined in (17), and is affine of slope λ^{-1} on the interval $\tilde{\Phi}_{\iota(j)}^{W^*}(I_{\iota(j)}^{p_{\iota(j)}, q_{\delta(j)}})$. The complementary intervals, called the *variation intervals*, are defined by (10), for $j = 1, \dots, 2N$:

$$S^1 \setminus \{I_j^{p_j, q_{\zeta(j)}} \cup \tilde{\Phi}_{\iota(j)}^{W^*}(I_{\iota(j)}^{p_{\iota(j)}, q_{\delta(j)}})\} = L_j^{q_{\delta(j)}, p_j} \cup R_j^{q_{\zeta(j)}, p_{\iota(j)}}. \quad (19)$$

The first goal in this section is to study how the various parameters (p_j, q_j) are related from one variation interval to another. This is obtained in Lemma 3.4 bellow. It is a key step, it defines an induction on the variation intervals, via an equality among some of the R_j^* or L_j^* , for specific choices of the indices (p, q) .

Lemma 3.4. *With the above notations, the following equalities, among variation intervals around the cutting point \tilde{z}_j are satisfied, for $a, b, m, n \geq 1$:*

$$(a) R_{\zeta^{-1}(j)}^{a,b} = (\tilde{\Phi}_j^{W^*})^{-1} \circ (\tilde{\Phi}_{\delta(j)}^{W^*})^{-1} \circ \dots \circ (\tilde{\Phi}_{\delta^{k(j)-2}(j)}^{W^*})^{-1} \left[R_{\delta^{k(j)-1}(j)}^{a-1, b-1} \right],$$

$$(b) L_j^{m,n} = (\tilde{\Phi}_{\zeta^{-1}(j)}^{W^*})^{-1} \circ (\tilde{\Phi}_{\gamma(\zeta^{-1}(j))}^{W^*})^{-1} \circ \dots \circ (\tilde{\Phi}_{\gamma^{k(j)-2}(\zeta^{-1}(j))}^{W^*})^{-1} \left[L_{\gamma^{k(j)-1}(\zeta^{-1}(j))}^{m-1, n-1} \right].$$

The maps $\beta : \zeta^{-1}(j) \rightarrow \delta^{k(j)-1}(j)$ and $\alpha : j \rightarrow \gamma^{k(j)-1}(\zeta^{-1}(j))$ that appear in (a) and (b) are the permutations of Lemma 2.6.

Proof. As in the proof of Lemma 3.3, we focus on the case $k(j) = 3$ and on one of the two symmetric equalities. For simplicity we use the parameters (p, q) only when it is necessary for the formulation, otherwise the indices are replaced by a “*”, the important indices will be bolded, Figure 4 should help.

By definition (see (19)), the variation interval $R_{\zeta^{-1}(j)}^{\mathbf{a}, \mathbf{b}}$ in equality (a) is the interval between $W_j^{p, \mathbf{a}}$ and $\Phi_{\iota(\zeta^{-1}(j))}^{W^*}[W_{\iota(\zeta^{-1}(j))}^{\mathbf{b}, q}]$, see Figure 4, thus:

$$R_{\zeta^{-1}(j)}^{\mathbf{a}, \mathbf{b}} = [\partial^+(W_j^{p, \mathbf{a}}), \partial^-(\Phi_{\iota(\zeta^{-1}(j))}^{W^*}[W_{\iota(\zeta^{-1}(j))}^{\mathbf{b}, q}])]. \quad (20)$$

These three intervals, by definition, are contained in $I_j^{p, *}$ and belong to the domain of definition of $\Phi_j^{p, *}$. The image of $W_j^{p, \mathbf{a}}$ under $\Phi_j^{p, *}$ is contained in $\tilde{I}_{\delta(j)}$ by Proposition 3.2-(a) and thus, in the domain of definition of $\Phi_{\delta(j)}^{W^*}$ for any parameters (p_i, q_i) . From the recursive definition of $W_j^{p, \mathbf{a}}$ in (16) we obtain $\Phi_{\delta(j)}^{W^*} \circ \Phi_j^{p, *}[W_j^{p, \mathbf{a}}] \subset I_{\delta^2(j)}^{*, \mathbf{a}-1}$ and, in addition:

$$\partial^+(\Phi_{\delta(j)}^{W^*} \circ \Phi_j^{p, *}[W_j^{p, \mathbf{a}}]) = \partial^+(I_{\delta^2(j)}^{*, \mathbf{a}-1}). \quad (21)$$

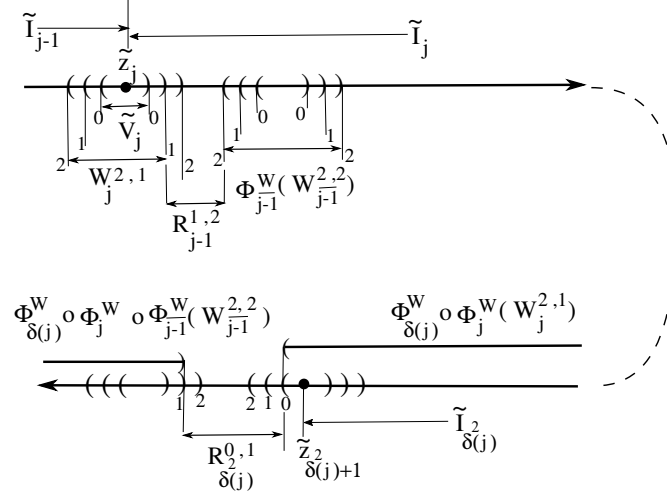

Figure 4: Variation interval equalities for $k(j) = 3$, with $\iota(j) = \bar{j}$ and $\zeta^{\pm 1}(j) = j \pm 1$

The image by the same map of the other interval: $\Phi_{\delta(j)}^{W^*} \circ \Phi_j^{p,*} \left[\Phi_{\iota(\zeta^{-1}(j))}^{W^*} [W_{\iota(\zeta^{-1}(j))}^{\mathbf{b},q}] \right]$ is one side of the equality (b) in Proposition 3.2 for $W_{\iota(\zeta^{-1}(j))}^{\mathbf{b},q}$. It gives:

$$\Phi_{\delta(j)}^{W^*} \circ \Phi_j^{p,*} \circ \Phi_{\iota(\zeta^{-1}(j))}^{W^*} [W_{\iota(\zeta^{-1}(j))}^{\mathbf{b},q}] = \Phi_{\iota(\delta^2(j))}^{W^*} \circ \Phi_{\gamma^2(\zeta^{-1}(j))}^{W^*} \circ \Phi_{\gamma(\zeta^{-1}(j))}^{W^*} [W_{\iota(\zeta^{-1}(j))}^{\mathbf{b},q}].$$

From (16) applied to $W_{\iota(\zeta^{-1}(j))}^{\mathbf{b},q}$ we have: $\Phi_{\gamma^2(\zeta^{-1}(j))}^{W^*} \circ \Phi_{\gamma(\zeta^{-1}(j))}^{W^*} [W_{\iota(\zeta^{-1}(j))}^{\mathbf{b},q}] \subset I_{\iota(\delta^2(j))}^{\mathbf{b}-1,q}$ and:

$$\partial^- \left(\Phi_{\gamma^2(\zeta^{-1}(j))}^{W^*} \circ \Phi_{\gamma(\zeta^{-1}(j))}^{W^*} [W_{\iota(\zeta^{-1}(j))}^{\mathbf{b},q}] \right) = \partial^- \left(I_{\iota(\delta^2(j))}^{\mathbf{b}-1,q} \right).$$

Applying $\Phi_{\iota(\delta^2(j))}^{W^*}$ on both sides of this equality gives:

$$\partial^- \left(\Phi_{\iota(\delta^2(j))}^{W^*} \circ \Phi_{\gamma^2(\zeta^{-1}(j))}^{W^*} \circ \Phi_{\gamma(\zeta^{-1}(j))}^{W^*} [W_{\iota(\zeta^{-1}(j))}^{\mathbf{b},q}] \right) = \partial^- \left(\Phi_{\iota(\delta^2(j))}^{W^*} [I_{\iota(\delta^2(j))}^{\mathbf{b}-1,q}] \right). \quad (22)$$

Hence, from (20), (21) and (22) we obtain:

$$\Phi_{\delta(j)}^{W^*} \circ \Phi_j^{p,*} (R_{\zeta^{-1}(j)}^{\mathbf{a},\mathbf{b}}) = [\partial^+ \left(I_{\delta^2(j)}^{\mathbf{a},\mathbf{b}-1} \right), \partial^- \left(\Phi_{\iota(\delta^2(j))}^{W^*} [I_{\iota(\delta^2(j))}^{\mathbf{b}-1,q}] \right)] = R_{\delta^2(j)}^{\mathbf{a}-1,\mathbf{b}-1},$$

which is another formulation of the equality (a) in the case $k(j) = 3$.

The equality (b) of the Lemma is obtained exactly by the same arguments on the other side of the neighborhood W_j^* . The general case, for any $k(j)$, is obtained with the same arguments using $k(j) - 1$ and $k(j)$ compositions instead of 2 and 3 as above. \square

Lemma 3.4 gives a pairing between the variation intervals: $R_{\zeta^{-1}(j)}^{p,q}$ and $R_{\beta(\zeta^{-1}(j))}^{p-1,q-1}$ and between: $L_j^{p,q}$ and $L_{\alpha(j)}^{p-1,q-1}$ around the neighborhood W_j^* . The combinatorics of the permutations α and β of Lemma 2.6 is important for the next results and allows an induction process on each variation interval.

Lemma 3.5. For each $j \in \{1, \dots, 2N\}$, let $r := r_\alpha(j) \geq 1$ be the length of the cycle of $\alpha(j)$ and let $r' := r_\beta(\zeta^{-1}(j)) \geq 1$ be the length of the cycle of $\beta(\zeta^{-1}(j))$.

There are two integers $K(r), K(r') \geq k(j) - 1$ such that, for all p, q :

$$(a) \quad \tilde{\Phi}^{-K(r)}(L_j^{p,q}) = L_j^{p+r, q+r} \quad \text{and} \quad |L_j^{p+r, q+r}| = \lambda^{-K(r)} \cdot |L_j^{p,q}|,$$

$$(b) \quad \tilde{\Phi}^{-K(r')}(R_{\zeta^{-1}(j)}^{p,q}) = R_{\zeta^{-1}(j)}^{p+r', q+r'} \quad \text{and} \quad |R_{\zeta^{-1}(j)}^{p+r', q+r'}| = \lambda^{-K(r')} \cdot |R_{\zeta^{-1}(j)}^{p,q}|,$$

where $|\cdot|$ is the length of the intervals for the metric on S^1 for which the map $\tilde{\Phi}$ is affine.

Proof. The two statements (a) and (b) are symmetric, let us focus on the case (a).

We start with the simple situation when the permutation α has a fixed point: $\alpha(j) = j$.

In this case, Lemma 3.4-(b) gives:

$$L_j^{p,q} = (\tilde{\Phi}_{\zeta^{-1}(j)}^{W*})^{-1} \circ (\tilde{\Phi}_{\gamma(\zeta^{-1}(j))}^{W*})^{-1} \circ \dots \circ (\tilde{\Phi}_{\gamma^{k(j)-2}(\zeta^{-1}(j))}^{W*})^{-1} [L_j^{p-1, q-1}].$$

From the definition of the variation intervals in (19) we obtain : $L_j^{p,q} \subset \tilde{I}_{\zeta^{-1}(j)}^{p,q}$ for all parameters (p, q) and thus $\tilde{\Phi}_{\zeta^{-1}(j)}^{W*}(L_j^{p,q}) = \tilde{\Phi}(L_j^{p,q})$. Proposition 3.2-(a) gives, in a similar way: $\tilde{\Phi}_{\zeta^{-1}(j)}^{W*}(L_j^{p,q}) \subset \tilde{I}_{\gamma(\zeta^{-1}(j))}^{p,q}$ and thus: $\tilde{\Phi}_{\gamma(\zeta^{-1}(j))}^{W*} \circ \tilde{\Phi}_{\zeta^{-1}(j)}^{W*}(L_j^{p,q}) = \tilde{\Phi}^2(L_j^{p,q})$. By induction, using the same argument, we obtain:

$$\tilde{\Phi}_{\gamma^{k(j)-2}(\zeta^{-1}(j))}^{W*} \circ \dots \circ \tilde{\Phi}_{\zeta^{-1}(j)}^{W*}(L_j^{p,q}) = \tilde{\Phi}^{k(j)-1}(L_j^{p,q})$$

and thus, from the equality in Lemma 3.4-(b), we obtain :

$$L_j^{p,q} = (\tilde{\Phi}^{k(j)-1})^{-1}(L_j^{p-1, q-1}) \subset L_j^{p-1, q-1}.$$

This is the first part of property (a) when $\alpha(j) = j$ i.e., when $r = 1$. The second statement in (a) in this case is immediate: $|L_j^{p,q}| = \lambda^{-K(1)} \cdot |L_j^{p-1, q-1}|$, with $K(1) = k(j) - 1$, since $\tilde{\Phi}$ is affine of slope λ for the metric $|\cdot|$.

In the general case, $\alpha(j)$ has a cycle of length $1 \leq r \leq 2N$, i.e., $\alpha^r(j) = j$ and r is minimal for that property. Lemma 3.4-(b) defines a sequence of maps :

$$L_j^{p,q} \rightarrow L_{\alpha(j)}^{p-1, q-1} \dots \rightarrow L_{\alpha^r(j)=j}^{p-r, q-r},$$

where each arrow is a composition of $k(\alpha^m(j)) - 1$ affine maps, for $0 \leq m \leq r - 1$.

From the above arguments, each map in this composition is $(\tilde{\Phi})^{-1}$. This gives the first statement in (a) for the integer: $K(r) = \sum_{m=0}^{r-1} (k(\alpha^m(j)) - 1) \geq k(j) - 1$.

The statement (b) is the same by exchanging the permutations α and β . \square

Corollary 3.1. For every $j \in \{1, \dots, 2N\}$ and all (p, q) , there is a unique expanding periodic point $l_j^0 \in L_j^{p,q}$ of period $K(r_\alpha(j))$ and a unique periodic point $r_{\zeta^{-1}(j)}^0 \in R_{\zeta^{-1}(j)}^{p,q}$ of period $K(r_\beta(\zeta^{-1}(j)))$ of the map $\tilde{\Phi}$.

Proof. The proof is direct from the Lemma. Indeed, $\tilde{\Phi}^{K(r_\alpha(j))}$ has a unique expanding fixed point l_j^0 in $L_j^{p,q}$ for all p, q . This point is periodic of period $K(r_\alpha(j))$ under $\tilde{\Phi}$ by the minimality r as the length of the cycle $\alpha(j)$. The integer $K(r_\alpha(j))$ is the first iterate of return in $L_j^{p,q}$. The arguments are the same for the intervals $R_{\zeta^{-1}(j)}^{p,q}$. \square

Remark 2. Existence and uniqueness of periodic orbits is invariant under conjugacy and thus the original map Φ has periodic orbits as above.

The other observation comes from the combinatorics of the various permutations: $\delta, \gamma, \alpha, \beta$

as discussed in section 2.2. We observe, in particular, that if $\alpha(j)$ has a cycle of length r then the cycle of $\alpha(\iota(j))$ has also length r , and the corresponding periodic orbits above are in bijection.

Before going further, let us make some observations and fix some notations: set $W_j^\infty := [l_j^0, r_{\zeta^{-1}(j)}^0]$ and $I_j^\infty := [l_j^0, r_j^0]$, notice that:

$$\forall p, q \geq 1, W_j^{p,q} \subset W_j^\infty \text{ and } I_j^{p,q} \subset I_j^\infty. \quad (23)$$

Definition 1. For all $j \in \{1, \dots, 2N\}$, let $\varphi_j^\infty \in \text{Homeo}^+(S^1)$ be defined as:

- $\varphi_j^\infty : I_j^\infty \rightarrow [r_{\iota(j)}^0, l_{\iota(j)}^0]$ is affine of slope λ ,
- $\varphi_j^\infty : [r_j^0, l_j^0] \rightarrow I_{\iota(j)}^\infty$ is affine of slope λ^{-1} ,

where each interval $[x, y]$ is from x to y along S^1 following the positive clockwise orientation. The points r_j^0, l_j^0 are called the breaking points of φ_j^∞ .

The maps φ_j^∞ are indeed homeomorphisms, they are continuous but not differentiable at the breaking points, where the left and right derivatives are in $\{\lambda, \lambda^{-1}\}$. From the definition, the following properties are immediate:

$$\varphi_{\iota(j)}^\infty = (\varphi_j^\infty)^{-1}, \quad (24)$$

$$\text{for all } p, q \geq 1, \varphi_j^\infty|_{I_j^{p,q}} = \tilde{\Phi}_j^{p,q} \text{ and } \varphi_j^\infty(W_j^{p,q}) = \tilde{\Phi}_j^{p,q}(W_j^{p,q}). \quad (25)$$

Lemma 3.6. With the previous notations, for all $j \in \{1, \dots, 2N\}$ and all $f_j^{p,q} \in [f_j^{W^{p,q}}]$, the following limit exists:

$$\lim_{p,q \rightarrow \infty} f_j^{p,q} = \varphi_j^\infty$$

for the topology of the uniform convergence in $\text{Homeo}^+(S^1)$.

Proof. In order to simplify the notations and avoid confusion on the indices, we assume that all the indices (p_j, q_j) are equal to a single index p . For each integer $p \geq 1$, the observation (25) implies that the homeomorphisms $f_j^{p,p}$ and φ_j^∞ are different only on the compact sets $L_j^{p,p}$ and $R_j^{p,p}$. The image of these compact sets being $R_{\iota(j)}^{p,p}$ and $L_{\iota(j)}^{p,p}$. Each of these compact intervals converge, when p tends to infinity, in the metric topology of S^1 , to a periodic point, namely to $l_j^0, r_j^0, r_{\iota(j)}^0, l_{\iota(j)}^0$, at an exponential rate by Lemma 3.5. Thus, for the uniform convergence topology on $\text{Homeo}^+(S^1)$, the limit exists and is equal to φ_j^∞ . \square

The goal now is to study some properties of the limit homeomorphisms. The next result is central for our global goal: define a group from the map Φ .

Lemma 3.7. For each cutting point \tilde{z}_j of $\tilde{\Phi}$, there is a partition of S^1 into $2k(j)$ intervals:

$$S^1 = A_0^\infty \bigcup A_{k(j)}^\infty \bigcup_{m=1}^{k(j)-1} A_m^{\infty, \pm}, \text{ with } A_0^\infty = A_0^{\infty, \pm} \text{ and } A_{k(j)}^\infty = A_{k(j)}^{\infty, \pm},$$

on which the two compositions:

$$\Psi_j^+ := \varphi_{\delta^{k(j)-1}(j)}^\infty \circ \cdots \circ \varphi_{\delta(j)}^\infty \circ \varphi_j^\infty \text{ and } \Psi_j^- := \varphi_{\gamma^{k(j)-1}(\zeta^{-1}(j))}^\infty \circ \cdots \circ \varphi_{\gamma(\zeta^{-1}(j))}^\infty \circ \varphi_{\zeta^{-1}(j)}^\infty,$$

satisfy the following properties:

- (a) $(\Psi_j^+)|_{A_m^{\infty, \pm}} = (\Psi_j^-)|_{A_m^{\infty, \pm}}$, are affine maps of slope $\lambda^{k(j)-2m}$ for each $m \in \{0, \dots, k(j)\}$.
- (b) Two adjacent intervals $A_m^{\infty, \pm}$ along S^1 intersect either at a breaking point or a $\tilde{\Phi}$ -orbit of a breaking point.

Proof. To start the proof let us simplify a little bit the notations. Consider a single integer $p \geq 1$ and the neighborhoods $W_i^p := W_i^{p,p}$ for i in the cycle of $\delta(j)$. We denote $\bar{j} = \iota(j)$ and $j \pm 1$ for $\zeta^{\pm 1}(j)$ we also denote Φ_j^p instead of $\tilde{\Phi}_j^{W^{p,p}}$.

By Proposition 3.2-(a), the following intervals are disjoint and ordered along S^1 (see Figure 5 in the case $k(j) = 3$):

$$\begin{aligned} [+] \quad & A_0^p := W_j^p, \\ & A_1^{p,+} := \Phi_{j-1}^p(W_{j-1}^p), \\ & \vdots \\ & A_{k(j)-1}^{p,+} := \Phi_{j-1}^p \circ \Phi_{\gamma(j-1)}^p \circ \cdots \circ \Phi_{\gamma^{k(j)-2}(j-1)}^p(W_{\gamma^{k(j)-2}(j-1)}^p), \\ & A_{k(j)}^p := \Phi_{j-1}^p \circ \cdots \circ \Phi_{\gamma^{k(j)-1}(j-1)}^p(W_{\gamma^{k(j)-1}(j-1)}^p), \\ [-] \quad & A_{k(j)-1}^{p,-} := \Phi_{\bar{j}}^p \circ \Phi_{\delta(j)}^p \circ \cdots \circ \Phi_{\delta^{k(j)-2}(j)}^p(W_{\delta^{k(j)-1}(j)}^p), \\ & \vdots \\ & A_1^{p,-} := \Phi_{\bar{j}}^p(W_{\delta(j)}^p). \end{aligned} \tag{26}$$

These intervals $A_m^{p,\pm}$ are disjoint on S^1 and are separated by either some variation intervals or some images of variation intervals. More precisely, we obtain the following intervals, ordered along S^1 after A_0 , with $R_i^p := R_i^{p,p}$ and $L_i^p := L_i^{p,p}$ (see Figure 5):

$$\begin{aligned} [+] \quad & D_1^{p,+} := R_{j-1}^p, \\ & D_2^{p,+} := \Phi_{j-1}^p(R_{\gamma(j-1)}^p), \\ & \vdots \\ & D_{k(j)}^{p,+} := \Phi_{j-1}^p \circ \Phi_{\gamma(j-1)}^p \circ \cdots \circ \Phi_{\gamma^{k(j)-2}(j-1)}^p(R_{\gamma^{k(j)-1}(j-1)}^p), \\ [-] \quad & D_{k(j)}^{p,-} := \Phi_{\bar{j}}^p \circ \Phi_{\delta(j)}^p \circ \cdots \circ \Phi_{\delta^{k(j)-2}(j)}^p(L_{\delta^{k(j)-1}(j)}^p), \\ & \vdots \\ & D_2^{p,-} := \Phi_{\bar{j}}^p(L_{\delta(j)}^p), \\ & D_1^{p,-} := L_j^p. \end{aligned} \tag{27}$$

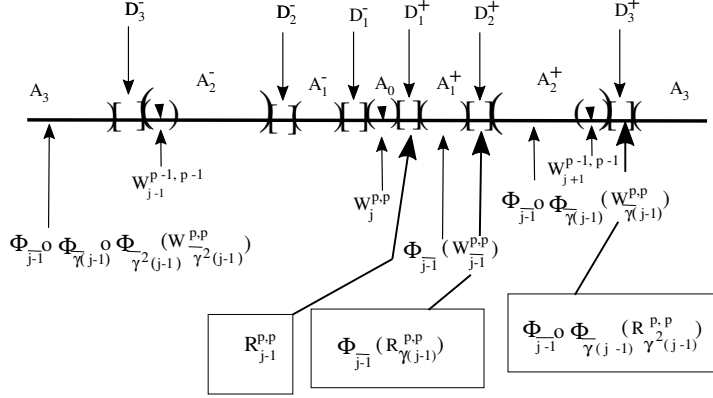

Figure 5: The partition (28) in the proof of Lemma 3.7.

The proof of the Lemma has two steps at this point:

(A) To prove that $(\Psi_j^+)|_{A_m^{p,\pm}} = (\Psi_j^-)|_{A_m^{p,\pm}}$, are affine maps of slope $\lambda^{k(j)-2m}$ for each $m \in \{0, \dots, k(j)\}$ and all $p \geq 1$.

(B) To take the limit when $p \rightarrow \infty$.

Step (A) is obtained as a consequence of the equality (b) in Proposition 3.2, applied to each W_i^p for i in the cycle of $\delta(j)$.

• Let us start by the simplest situation: $A_0^p = W_j^p$. In this case the equality (b) of Proposition 3.2 gives: $(\Phi_{\delta^{k(j)-1}(j)}^p \circ \dots \circ \Phi_{\delta(j)}^p \circ \Phi_j^p)|_{W_j^p} = (\Phi_{\gamma^{k(j)-1}(j-1)}^p \circ \dots \circ \Phi_{\gamma(j-1)}^p \circ \Phi_{j-1}^p)|_{W_j^p}$.

This map is affine of slope $\lambda^{k(j)}$ since it is a composition of $k(j)$ affine maps each of slope λ . By the observation (25): $(\varphi_i^\infty)|_{W_i^p} = (\Phi_i^p)|_{W_i^p}$ for all i and all p . We replace, in the equality above, each Φ_i^p by φ_i^∞ and we obtain the identity: $(\Psi_j^+)|_{A_0^p} = (\Psi_j^-)|_{A_0^p}$ which is the property (A) for $m = 0$.

• The next simplest case is for the interval $A_{k(j)}^p$. The equality (b) of Proposition 3.2 in this case gives:

$$A_{k(j)}^p = \Phi_{j-1}^p \circ \dots \circ \Phi_{\gamma^{k(j)-1}(j-1)}^p \left(\frac{W_{\gamma^{k(j)-1}(j-1)}^p}{\gamma^{k(j)-1}(j-1)} \right) = \Phi_j^p \circ \dots \circ \Phi_{\delta^{k(j)-1}(j)}^p \left(\frac{W_{\gamma^{k(j)-1}(j-1)}^p}{\gamma^{k(j)-1}(j-1)} \right).$$

We observe that on this interval, each homeomorphism in both compositions in Ψ_j^+ and Ψ_j^- are affine of slope λ^{-1} and we check that $\Psi_j^+(A_{k(j)}^p) = \frac{W_{\gamma^{k(j)-1}(j-1)}^p}{\gamma^{k(j)-1}(j-1)}$ and

$\Psi_j^-(A_{k(j)}^p) = \frac{W_{\gamma^{k(j)-1}(j-1)}^p}{\gamma^{k(j)-1}(j-1)}$ since at each step in both compositions we compose a map with its inverse. We obtain the equality: $(\Psi_j^+)|_{A_{k(j)}^p} = (\Psi_j^-)|_{A_{k(j)}^p}$ and the map is affine

of slope $\lambda^{-k(j)}$, which is the case $m = k(j)$ in (A).

• For the other intervals $A_m^{p,\pm}$ for $m \in \{1, \dots, k(j) - 1\}$ the proofs are essentially the same. Each interval $A_m^{p,\pm}$ is a composition of m maps applied to an interval W_i^p for i in the cycle of $\delta(j)$. The equality (b) in Proposition 3.2 for W_i^p is an equality for a compo-

sition of $k(j)$ affine maps. We apply each composition Ψ_j^+ and Ψ_j^- on both sides of this equality. And we observe that, among the $k(j)$ homeomorphisms of each composition, m of them are affine of slope λ^{-1} and $k(j) - m$ are affine of slope λ on the particular interval.

Let us give some details for the interval $A_1^{p,+} = \Phi_{j-1}^p(W_{j-1}^p)$. The equality (b) of Proposition 3.2 gives:

$$(\Phi_{\delta^{k(j)-2}(j)}^p \circ \cdots \circ \Phi_j^p \circ \Phi_{j-1}^p)|_{W_{j-1}^p} = (\Phi_{\delta^{k(j)-1}(j)}^p \circ \Phi_{\gamma^{k(j)-1}(j-1)}^p \circ \cdots \circ \Phi_{\gamma^{(j-1)}}^p)|_{W_{j-1}^p}.$$

We apply now the two compositions Ψ_j^+ and Ψ_j^- on both sides of this equality. After a little computation we obtain, using the previous arguments: $\Psi_j^+(A_1^{p,+}) = \Psi_j^-(A_1^{p,+}) = \Phi_{\gamma^{k(j)-1}(j-1)}^p \circ \cdots \circ \Phi_{\gamma^{(j-1)}}^p(W_{j-1}^p)$ which is an affine map of slope $\lambda^{k(j)-2}$. This is the case (A) for $m = 1$.

Let us now turn to the step (B) above and study the limit $p \rightarrow \infty$. The collection of intervals given in (26) and (27) defines the following partition of S^1 :

$$S^1 = A_0^p \bigcup A_{k(j)}^p \bigcup_{m=1}^{k(j)-1} A_m^{p,\pm} \bigcup_{m=1}^{k(j)} D_m^{p,\pm} \quad (28)$$

From Lemma 3.5 and Corollary 3.1, each variation interval converges to a periodic point of $\tilde{\Phi}$ when $p \rightarrow \infty$: $R_i^p \rightarrow r_i^0$ and $L_i^p \rightarrow l_i^0$. These periodic points are also, by definition, the breaking points of the homeomorphisms φ_i^∞ . From the definition of the intervals $D_m^{p,\pm}$ in (27) we obtain the following limit points:

$$\begin{aligned} [+] \quad & D_1^{p,+} \rightarrow r_{j-1}^0, \quad D_2^{p,+} \rightarrow \tilde{\Phi}\left(r_{\gamma^{(j-1)}}^0\right), \dots, \quad D_{k(j)}^{p,+} \rightarrow \tilde{\Phi}^{k(j)-1}\left(r_{\gamma^{k(j)-1}(j-1)}^0\right), \\ [-] \quad & D_{k(j)}^{p,-} \rightarrow \tilde{\Phi}^{k(j)-1}\left(l_{\delta^{k(j)-1}(j)}^0\right), \dots, \quad D_2^{p,-} \rightarrow \tilde{\Phi}\left(l_{\delta^{(j)}}^0\right), \quad D_1^{p,-} \rightarrow l_j^0. \end{aligned} \quad (29)$$

The definition of the intervals $A_m^{p,\pm}$ in (26) gives, by taking the limit $p \rightarrow \infty$, that each interval $W_i^p \rightarrow W_i^\infty$ as defined in (23) for the metric convergence on S^1 . Lemma 3.6 implies that on each interval W_i^p the image interval $\tilde{\Phi}_i^p(W_i^p)$ converges to $\varphi_i^\infty(W_i^\infty)$. Putting these convergences together we obtain finally that each interval $A_m^{p,\pm}$ converges to $A_m^{\infty,\pm}$ and is the limit of the corresponding compositions of m homeomorphisms φ_i^∞ . The partition (28) thus defines a limit partition when $p \rightarrow \infty$:

$$S^1 = A_0^\infty \bigcup A_{k(j)}^\infty \bigcup_{m=1}^{k(j)-1} A_m^{\infty,\pm}. \quad (30)$$

- Two adjacent intervals of that partition intersect on a limit point given by (29), i.e., on a point which is either a breaking point of φ_i^∞ or a $\tilde{\Phi}$ -orbit of a breaking point. This is statement (b) of the Lemma.
- To complete the proof of the Lemma we have to check the equality:

$(\Psi_j^+)|_{A_m^{\infty,\pm}} = (\Psi_j^-)|_{A_m^{\infty,\pm}}$, and that each composition is an affine map of slope $\lambda^{k(j)-2m}$, for each $m \in \{0, \dots, k(j)\}$ and each j . These properties are obtained by taking the limit $p \rightarrow \infty$ in the equalities in (A) above. \square

The limit homeomorphisms of Lemma 3.6 together with the partition and the properties of Lemma 3.7 are the main steps in our goal to construct a group from our initial map Φ . Observe that the limit homeomorphisms are defined only with the dynamical properties of the map Φ .

Theorem 1. *Let Φ be a piecewise homeomorphism of S^1 satisfying the ruling assumptions: (SE), (EC), (E+), (E-), (CS) and let $\varphi_i^\infty \in \text{Homeo}^+(S^1)$, $i \in \{1, \dots, 2N\}$ be the set of homeomorphisms of Definition 1, then each cutting point z_j of Φ defines an equality in $\text{Homeo}^+(S^1)$, called a cutting point relation:*

$$(CPj) \quad \varphi_{\delta^{k(j)-1}(j)}^\infty \circ \dots \circ \varphi_{\delta(j)}^\infty \circ \varphi_j^\infty = \varphi_{\gamma^{k(j)-1}(\zeta^{-1}(j))}^\infty \circ \dots \circ \varphi_{\gamma(\zeta^{-1}(j))}^\infty \circ \varphi_{\zeta^{-1}(j)}^\infty.$$

Proof. From Lemma 3.7 there is a partition of S^1 for each index $j \in \{1, \dots, 2N\}$ so that the equality (CPj) is satisfied on each partition interval $A_m^{\infty,\pm}$ for $m \in \{0, \dots, k(j)\}$ since $(\Psi_j^+)|_{A_m^{\infty,\pm}} = (\Psi_j^-)|_{A_m^{\infty,\pm}}$. Each composition is affine of slope $\lambda^{k(j)-2m}$ on each such interval $A_m^{\infty,\pm}$. The intersection of two consecutive intervals is a breaking point of some φ_j^∞ or an image of a breaking point. At these points the two compositions are not differentiable, they are affine of slope $\lambda^{k(j)-2m}$ on one side and of slope $\lambda^{k(j)-2(m\pm 1)}$ on the other side. By continuity the two compositions are equal at each such extremes point of the partition intervals. Thus the equality (CPj) is satisfied on S^1 , this is a relation on $\text{Homeo}^+(S^1)$. \square

Observe that for two indices j and j' in the same cycle of the permutation δ , the two relations (CPj) and (CPj') differ by a cyclic permutation of the indices along the cycle of δ . These two relations are conjugated in $\text{Homeo}^+(S^1)$. This means that the number of non conjugated cutting point relations is the number of cycle of the permutation δ .

At this point we have all the tools to define a group from our map Φ .

Definition 2. *Let Φ be a piecewise homeomorphism of S^1 satisfying the ruling assumptions (SE), (EC), (E+), (E-), (CS). Let G_{X_Φ} be the subgroup of $\text{Homeo}^+(S^1)$ generated by the set of diffeomorphisms: $X_\Phi = \{\varphi_j^\infty : j \in \{1, \dots, 2N\}\}$ of Definition 1. These generators verify, in particular, all the cutting point relations (CPj) of Theorem 1.*

The set of generators X_Φ is well defined from the map Φ and the limit process of Lemma 3.6 remove all the choices that was done in the first steps of the construction, i.e., for the diffeomorphisms f_j^{W*} . The goal for the rest of the paper is to study the group G_{X_Φ} , using the dynamics of the map Φ .

4 Some metric spaces associated to Φ

The group G_{X_Φ} of Definition 2 is obtained from the map Φ . The classical strategy to study the geometry of such groups is via a *geometric action* on a well chosen metric

space. Unfortunately no “natural” metric space is given here so we have to construct one from the given data i.e., the dynamics of the map Φ .

This is the goal of this section: define a metric space suited to the class of the maps Φ of section §2.

The construction of an action will be given in the next section and, as for the metric space, it is not given a priori so it will be constructed from the available data, the map Φ . In the following we will not distinguish between the maps Φ and $\tilde{\Phi}$ as well as between the partition intervals I_j and \tilde{I}_j .

4.1 A first space: Γ_{Φ}^0

The first space we consider is directly inspired by a construction due to P. Haissinsky and K. Pilgrim [HP] (see also [H18]) in the context of coarse expanding conformal maps. In these papers, the authors use the dynamics of a map F on a compact metric space Y . They construct a graph out of a sequence of coverings of the space Y by open sets obtained from one covering by the sequence of pre-image coverings. They prove that if the map is “expanding”, in a topological sense, then the resulting space is Gromov hyperbolic with boundary the space Y .

We use the same idea where the space is S^1 and the dynamics is given by Φ . We replace their coverings by our partition and their sequence of pre-image coverings by the sequence of pre-image partitions. In order to fit with this description we use a partition by closed intervals, so that adjacent intervals do intersect in the simplest possible way i.e., points. With our previous description we consider the initial partition: $S^1 = \bigcup_{j=1}^{2^N} I_j$, with $I_j = [z_j, z_{\zeta(j)}]$, keeping the same notation for simplicity. Thus, each interval I_j intersects the two adjacent intervals $I_{\zeta^{\pm 1}(j)}$ exactly at cutting points.

Definition 3. We define a graph Γ_{Φ}^0 by an iterative process (see Figure 6):

- *Level 0:* A base vertex v_0 is defined.
 - *Level 1:*
 - (a) Each interval I_j of the partition defines a vertex v_j .
 - (b) v_0 is connected to v_j by an edge.
 - (c) v_j is connected to v_k if $I_j \neq I_k$ and $I_j \cap I_k \neq \emptyset$.
 - *Level 2:*
 - (a) A vertex v_{j_1, j_2} is defined for each non-empty connected component (that is not a point) $I_{j_1, j_2} := I_{j_1} \cap \Phi^{-1}(I_{j_2})$. This notation is unambiguous since $\Phi^{-1}(I_{j_2})$ has at most one connected component in I_{j_1} .
 - (b) v_{j_1} is connected to v_{j_1, j_2} by an edge.
 - (c) v_{j_1, j_2} is connected to $v_{j'_1, j'_2}$ if $I_{j_1, j_2} \neq I_{j'_1, j'_2}$ and $I_{j_1, j_2} \cap I_{j'_1, j'_2} \neq \emptyset$.
 - *Level k:*
 - (a) We repeat level 2 by iteration i.e., we consider a sequence of intervals $\{I_{j_1}; I_{j_1, j_2}; \dots; I_{j_1, j_2, \dots, j_k}; \dots\}$ such that:
$$I_{j_1, j_2, \dots, j_k} := I_{j_1, j_2, \dots, j_{k-1}} \cap \Phi^{-k+1}(I_{j_k}) \neq \emptyset.$$
- Notice that if the sequence j_1, j_2, \dots, j_k defines an interval of level k , then $j_{i+1} \neq \bar{j}_i$, for $1 \leq i \leq k-1$, from condition (SE).

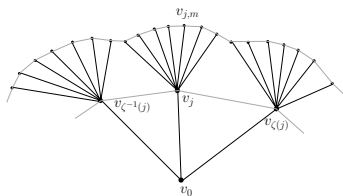

Figure 6: The first levels of the graph Γ_{Φ}^0

(b) A vertex v_{j_1, j_2, \dots, j_k} is defined by the interval I_{j_1, j_2, \dots, j_k} ,

(c) v_{j_1, j_2, \dots, j_k} is connected to $v_{j_1, j_2, \dots, j_{k-1}}$ by an edge,

(d) v_{j_1, j_2, \dots, j_k} is connected to $v_{j'_1, j'_2, \dots, j'_k}$ if:

$$I_{j'_1, j'_2, \dots, j'_k} \neq I_{j_1, j_2, \dots, j_k} \text{ and } I_{j_1, j_2, \dots, j_k} \cap I_{j'_1, j'_2, \dots, j'_k} \neq \emptyset$$

Lemma 4.1. *If Φ is a piecewise homeomorphism of S^1 satisfying the condition (SE) and (CS) then the graph Γ_{Φ}^0 , endowed with the combinatorial metric (each edge has length one), is Gromov hyperbolic with boundary S^1 .*

Proof. We adapt word for word the proof in [HP]. Indeed, the essential ingredients for the proof in [HP] are the facts that each vertex is associated to a connected component of the pre-image cover with two properties:

- Each component has a uniformly bounded number of pre-images.

In our case, each interval has at most $2N - 1$ pre-images.

- The size of each connected component goes to zero when the level goes to infinity.

In our case, the size of the intervals I_{j_1, j_2, \dots, j_k} in the sequence of pre-images goes to zero when k goes to infinity by the expansivity properties (SE) and (CS).

In fact a much weaker expansivity property than our conditions (SE) and (CS) would be enough to conclude that the graph is hyperbolic. Observe that the distance of any vertex to the base vertex is simply the level k and the edge connecting v_{j_1, j_2, \dots, j_k} to $v_{j'_1, j'_2, \dots, j'_k}$, if any, belongs to the sphere of radius k centered at the base vertex. By this observation and our definition of the edges, each sphere of radius k centered at the based vertex is homeomorphic to S^1 . Therefore the limit space when k goes to infinity is homeomorphic to S^1 and the Gromov boundary $\partial\Gamma_{\Phi}^0$ is homeomorphic to S^1 . \square

4.2 The dynamical graph Γ_{Φ}

Consider the tree T_{Φ} obtained from Γ_{Φ}^0 by removing the edges on the spheres. We define on T_{Φ} an equivalence relation that identifies some vertices on some of the spheres using the specific properties (EC), (E+), (E-) of the map Φ .

For T_{Φ} we use the same definitions for the intervals and vertices of Level 0, Level 1: a), b), Level 2: a), b) and Level k : a), b), c) as in Γ_{Φ}^0 .

The equivalence relation we define below is inductive, due to the dynamical origin of the space we construct. This is not a standard approach in group theory.

Labeling the edges: The edge connecting the two vertices: $(v_{j_1, j_2, \dots, j_{k-1}}, v_{j_1, j_2, \dots, j_k})$ is labelled by a symbol Ψ_{j_k} and the reverse edge, i.e., the same edge but read from

v_{j_1, j_2, \dots, j_k} , is labelled $\Psi_{j_k}^-$.

Definition 4. The dynamical graph is defined by $\Gamma_\Phi := T_\Phi / \sim_\Phi$, where \sim_Φ is the following relation:

(V) Two vertices of the same level $k > 1$ in T_Φ : v_{j_1, j_2, \dots, j_k} and v_{l_1, l_2, \dots, l_k} are identified if

(a) There is a level $0 \leq r < k - 1$ such that:

- (a1) $I_{j_1, \dots, j_i} = I_{l_1, \dots, l_i}$ as intervals in S^1 , for $i = 1, \dots, r$ (if $r = 0$ the vertex is v_0).
- (a2) For all $1 \leq p < k - r$, the intervals $I_{j_1, \dots, j_r, j_{r+1}, \dots, j_{r+p}}$ and $I_{l_1, \dots, l_r, l_{r+1}, \dots, l_{r+p}}$ are adjacent in the cyclic ordering of S^1 .

(b) At level k : the intervals I_{j_1, \dots, j_k} and I_{l_1, \dots, l_k} are adjacent along S^1 and:

- (b1) $\Phi^m(I_{j_1, \dots, j_k}) \cap \Phi^m(I_{l_1, \dots, l_k}) = \emptyset$, for all $r < m < k$,
- (b2) $\Phi^k(I_{j_1, \dots, j_k}) \cap \Phi^k(I_{l_1, \dots, l_k}) = \text{one point}$ and
 $\Phi^k(I_{j_1, \dots, j_k}) \cup \Phi^k(I_{l_1, \dots, l_k}) = \text{a non degenerate interval}$.

(E) Two edges, connecting vertices from a level m to level $m + 1$, with the same label and starting from an identified vertex at level m are identified to an edge labeled with the common label.

We have to verify this dynamical graph is well defined for our class of maps and to find an interpretation to the vertices and edges of the graph.

Lemma 4.2. If Φ is a piecewise homeomorphism of S^1 satisfying the conditions (SE), (EC), (E+), (E-), (CS) then the dynamical graph Γ_Φ is well defined.

In addition every vertex $w \neq v_0$ in Γ_Φ , in a level $k \geq 1$, is associated to an interval of S^1 of the following types:

- (i) $I_w = I_{j_1, \dots, j_k}$, or
- (ii) $I_w = I_{j_1^1, \dots, j_k^1} \cup I_{j_1^2, \dots, j_k^2} \cdots \cup I_{j_1^n, \dots, j_k^n}$, for some integer $n = n(k, \Phi)$. The intervals $I_{j_1^i, \dots, j_k^i}$ belong to the same level k and are pairwise adjacent along S^1 .

Proof. • If a vertex $v \in T_\Phi$, at a level $k > 0$, is so that no identification occur for v then it is associated to an interval of level k , say I_{j_1, \dots, j_k} . We define $I_v := I_{j_1, \dots, j_k}$ and we say that I_v is an interval of type (i).

• If two vertices v_{j_1, \dots, j_k} and v_{l_1, \dots, l_k} of T_Φ satisfy the conditions (a) and (b) of (V) let us study the relation \sim_Φ .

- Assume first that $r = 0$ in (a1). By condition (a2), the two intervals I_{j_1} and I_{l_1} are adjacent, so they have a cutting point z in common and the $k - 1$ first intervals in the sequence, up to $I_{j_1, \dots, j_{k-1}}$ and $I_{l_1, \dots, l_{k-1}}$ are adjacent. By conditions (E+), (E-), this property is satisfied for our map Φ on the intervals containing the cutting point z on one side.

By condition (b), the intervals I_{j_1, \dots, j_k} and I_{l_1, \dots, l_k} are adjacent. As above, this property is satisfied by some intervals for Φ and, by conditions (E+), (E-), the Φ^m images of these intervals are disjoint for $m < k - 1$, so condition (b1) is satisfied.

By condition (b2), the Φ^k -images of I_{j_1, \dots, j_k} and I_{l_1, \dots, l_k} have one point in common. For

the map Φ this point has to be the Φ^k image of the cutting point z given above. By the eventual coincidence condition (EC) on Φ , there is indeed an integer: $k(z)$ for each cutting point, so that the two orbits of z coincide after $k(z)$ iterates. The conditions (b1) and (b2) are satisfied for this iterate $k(z)$ and such a condition is satisfied for each cutting point and therefore for each pair of adjacent intervals. The second condition in (b2) is satisfied since Φ is orientation preserving.

- When $r > 0$ in (a), then the pair of adjacent intervals $I_{j_1, \dots, j_r, j_{r+1}}$ and $I_{j_1, \dots, j_r, l_{r+1}}$ given by condition (a2) are so that the Φ^r -image of these intervals are adjacent at level 1. Thus they have a cutting point in common and the arguments above apply: there is an integer k for which conditions (b1) and (b2) are satisfied. In addition, if we denote by \tilde{v} the vertex obtained by the identification \sim_Φ from v_{j_1, \dots, j_k} and v_{l_1, \dots, l_k} , then we define $I_{\tilde{v}} := I_{j_1, \dots, j_k} \cup I_{l_1, \dots, l_k}$, which is an interval since I_{j_1, \dots, j_k} and I_{l_1, \dots, l_k} are adjacent along S^1 , and we say that $I_{\tilde{v}}$ is an *interval of type (ii)*.

The identification in Definition 4-(V) is well defined and occurs at each level after some minimal level: $k_0 = \min\{k(j) | j = 1, \dots, 2N\}$, where the $k(j)$'s are the integers of condition (EC).

• Let us consider (\mathcal{E}) in Definition 4. This is an inductive operation from a level $k+1$ if some identification occurred at level k . If an identification (V) occurred at level k defining a vertex \tilde{v} then, by condition (b), there is a point $\tilde{z} = \Phi^k(I_{j_1, \dots, j_k}) \cap \Phi^k(I_{l_1, \dots, l_k})$. Two cases can arise:

- (1) $\tilde{z} = \Phi^k(I_{j_1, \dots, j_k}) \cap \Phi^k(I_{l_1, \dots, l_k})$ is a cutting point z ,
- (2) $\tilde{z} = \Phi^k(I_{j_1, \dots, j_k}) \cap \Phi^k(I_{l_1, \dots, l_k})$ belongs to the interior of an interval, say I_{a_1} .

In case (1), all edges starting from the identified vertex \tilde{v} have different label and the identification (\mathcal{E}) does not happen.

In case (2), there is a sub-interval I_{j_1, \dots, j_k, a_1} of I_{j_1, \dots, j_k} and an edge labeled Ψ_{a_1} connecting v_{j_1, \dots, j_k} to v_{j_1, \dots, j_k, a_1} and an edge, labeled Ψ_{a_1} , connecting v_{l_1, \dots, l_k} to v_{l_1, \dots, l_k, a_1} in T_Φ . The identification of the two vertices: v_{j_1, \dots, j_k} and v_{l_1, \dots, l_k} by \sim_Φ at level k implies that two edges labelled Ψ_{a_1} start from the new vertex \tilde{v} . The identification in Definition 4-(\mathcal{E}) identifies these two edges to a single edge, labelled Ψ_{a_1} , connecting \tilde{v} to \tilde{v}^1 at level $k+1$. This identification is well defined at level $k+1$.

In addition the two intervals I_{j_1, \dots, j_k, a_1} and I_{l_1, \dots, l_k, a_1} are adjacent on S^1 and we associate to the vertex \tilde{v}^1 the interval: $I_{\tilde{v}^1} = I_{j_1, \dots, j_k, a_1} \cup I_{l_1, \dots, l_k, a_1}$, this is an interval of type (ii).

The identification of type (\mathcal{E}) is then applied inductively on each level following $k+1$. At level $k+2$, if the image $\Phi(\tilde{z})$ is a cutting point then, as in case (1), the identification of type (\mathcal{E}) stops i.e., the edges starting from \tilde{v}^1 have different label and there is no identification of the type (\mathcal{E}). If $\Phi(\tilde{z})$ belongs to the interior of an interval I_{a_2} then, as in case (2), two edges with label Ψ_{a_2} start at \tilde{v}^1 and a new identification of type (\mathcal{E}) occurs. The inductive identification of type (\mathcal{E}), starting at \tilde{v} , depends on the orbit $\Phi^m(\tilde{z})$:

- If, for some $m \geq 0$, $\Phi^m(\tilde{z})$ is a cutting point then the identification starting at level k at \tilde{v} stops at level $k+m$, as in case (1).

- If $\Phi^m(\tilde{z})$ is not a cutting point for all $m \geq 0$ then the identification of type (\mathcal{E}) starting at \tilde{v} does not stop and is well defined for each level $k+m$. At each level of this inductive identification, a new vertex is defined and is associated to an interval which is the union

of the adjacent intervals associated to the identified vertices in T_Φ . At each such level the new vertex is of type (ii) .

Finally, we have to check if an identification of type (V) and one of type (\mathcal{E}) could possibly interact i.e., occur at the same level.

Let us observe that the neighborhood: $\tilde{V}_j = V_j^{c_j} \cup V_j^{d_j}$ in the proof of Lemma 3.2 is in fact an interval of the form: $I_w := I_{j_1, \dots, j_{k(j)}} \cup I_{l_1, \dots, l_{k(j)}}$ i.e., of type (ii) by (V) , at level $k(j)$.

It turns out that the identifications of type (ii) by (V) and the identifications of type (ii) by (\mathcal{E}) , can indeed interact. This happens in the following situations:

An identification of type (ii) by (\mathcal{E}) occurs if $\zeta = \Phi^{k(j)}(z_j) \in \text{int}(I_a)$ for some a . Assume that $\zeta = \Phi^{k(j)}(z_j) \in V_a \cap I_a$, where V_a is the neighborhood of the cutting point z_a described above. An identification of type (ii) by (\mathcal{E}) occurs at level $k(j) + 1$ and, by condition $(E+)$: $\Phi^m(\zeta) \in I_{\delta^m(a)}$ for $m \leq k(a) - 1$. This implies that $\Phi^m(\zeta)$ is not a cutting point for all $m \leq k(a) - 1$. By the condition (2) above, an identification of type (ii) by (\mathcal{E}) occurs for each level from $k(j) + 1$ up to $k(j) + k(a) - 1$. At level $k(j) + k(a)$ an identification of type (ii) by (\mathcal{E}) and one of type (ii) by (V) occur at the same level, and three vertices of the tree T_Φ will be identified. These vertices are related with three intervals that are pairwise adjacent along S^1 , say:

$$I_{j_1, \dots, j_{k(j)}, a', a'_2, \dots, a'_{k(a)}}, I_{j_1, \dots, j_{k(j)}, a, a_2, \dots, a_{k(a)}}, I_{l_1, \dots, l_{k(j)}, a, a_2, \dots, a_{k(a)}}, \text{ where } a' = \zeta^{-1}(a).$$

We associate the vertex obtained from the identifications of the three vertices with the union of these three intervals, this is an interval of type (ii) .

For the next levels, the two cases (1) or (2) above can occur, depending on the orbits of each cutting point i.e., z_j and z_a .

The phenomenon described above, where two identifications of different type arise for the same vertex, can possibly occur at any level large enough. The intervals associated to vertices in T_Φ that are involved are pairwise adjacent, as above, and the union of these intervals is an interval. The number n_m of these intervals depends on the map Φ via the orbits of the cutting points and the level m .

Hence, the dynamical graph Γ_Φ is well defined from the map Φ . \square

Remark 3. Notice that a vertex obtained by an identification of type (V) has two incoming edges i.e., from level $k - 1$ to level k . A vertex obtained by an identification of type (\mathcal{E}) has only one incoming edge, as the vertices of type (i) . If necessary, we will mark the difference by denoting the corresponding vertices or intervals of type $(ii-V)$ or type $(ii-\mathcal{E})$.

It is interesting to observe that the identification of type (\mathcal{E}) is essentially a Stallings folding [Sta].

Proposition 4.1. If Φ and Φ' are two piecewise homeomorphisms of S^1 with the same combinatorics i.e., the same permutations ζ and ι , the same properties (SE) , (EC) , $(E+)$, $(E-)$, (CS) with the same slope λ , then the graphs Γ_Φ and $\Gamma_{\Phi'}$ are homeomorphic.

Proof. Since the combinatorics are the same, all the combinatorial data used in the constructions: $k(j)$, γ and δ are the same for Φ and Φ' . The identification of type $(ii-V)$

defines vertices with two incoming edges, and $2N - 2$ outgoing edges, by condition (7) in the proof of Lemma 3.2. The vertices of types (i) and (ii- \mathcal{E}) have one incoming edge and $2N - 1$ outgoing edges by condition (SE). The sequence of identifications that occur for the two maps can be quite different (see (1) and (2) in the proof of Lemma 4.2) but each resulting vertex has the same structure. Therefore the two graphs are homeomorphic. \square

Example. To illustrate the possible types of identification, as mentioned in the proof of Lemma 4.2 and Proposition 4.1, let us consider the following example: for $\zeta = (12\bar{1}\bar{2}56\bar{5}\bar{6})$ we have $\delta = (1\bar{2}\bar{1}25\bar{6}\bar{5}6)$ and $k(j) = 4$ for all j . If $j = 1$ and \mathfrak{z} denotes the point given by condition (EC), then:

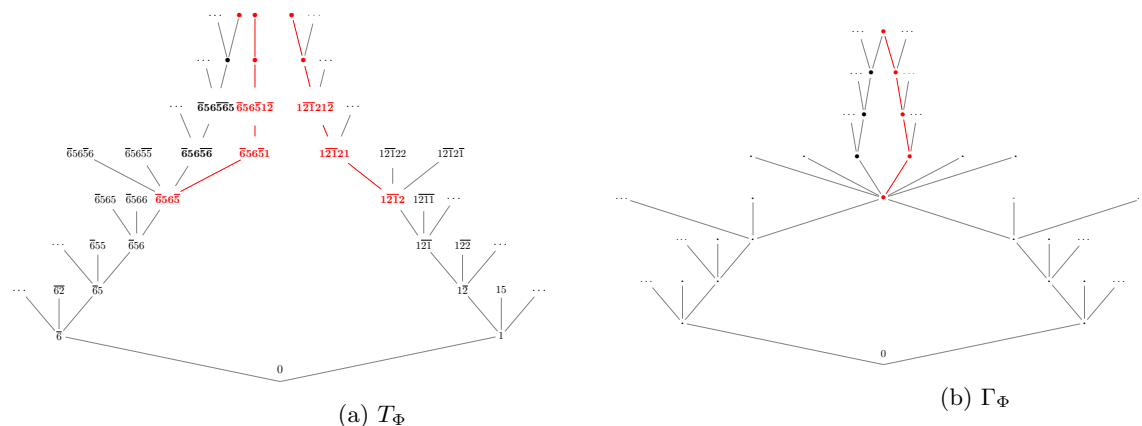

Figure 7: for $\mathfrak{z} \in \tilde{I}_1 \cap \tilde{V}_1$

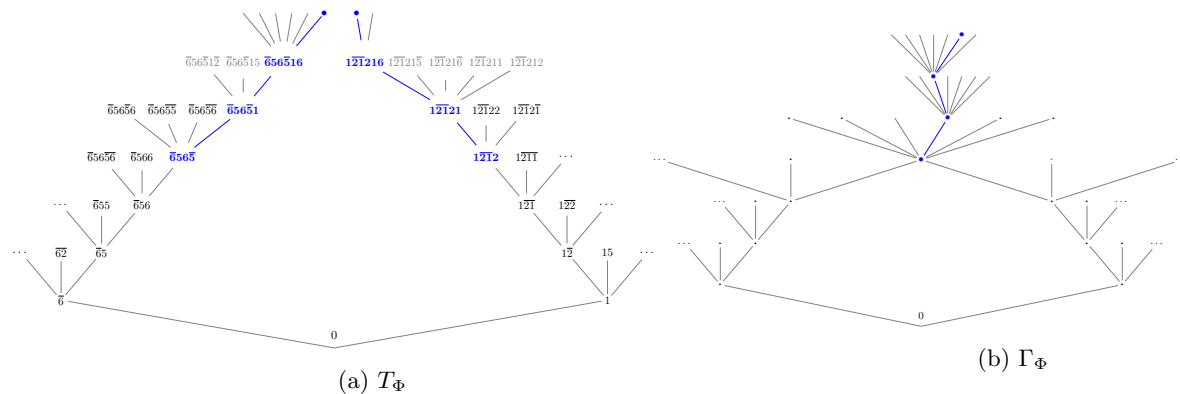

Figure 8: for $\mathfrak{z} \in \tilde{I}_1 \setminus \{\tilde{V}_1 \cup \tilde{V}_2\}$, $\Phi(\mathfrak{z}) \in \tilde{I}_6$ and $\Phi^2(\mathfrak{z}) \in \tilde{I}_6$

Lemma 4.3. Let $\Phi : S^1 \rightarrow S^1$ satisfying the conditions (SE), (EC), (E+), (E-), (CS) then there exists $\Phi' : S^1 \rightarrow S^1$ with the same combinatorics as Φ so that the identifications of type (ii) in Lemma 4.2 are all 2 to 1.

Proof. The idea is to change the map Φ by changing the cutting points while preserving the combinatorics. We replace Φ by the affine map $\tilde{\Phi}$ via the conjugacy of condition (CS), the combinatorics are evidently the same. Consider the neighborhood \tilde{V}_j of Lemma 3.2 and the λ -affine extension $\tilde{\Phi}_j^{\tilde{V}}$ of Lemma 3.3, from which we obtain:

$\tilde{\Phi}_j^{\tilde{V}}(V_j) \subset \tilde{I}_{\delta(j)} \setminus \tilde{V}_{\delta(j)}$. Conditions (E \pm), together with the definition of V_j give:

$$\tilde{\Phi}^m(\tilde{\Phi}_j^{\tilde{V}}(\tilde{V}_j)) \in \tilde{I}_{\delta^{m+1}(j)} \text{ and } \tilde{\Phi}^m(\tilde{\Phi}_{\zeta^{-1}}^{\tilde{V}}(\tilde{V}_j)) \in \tilde{I}_{\gamma^{m+1}(\zeta^{-1})}, \text{ for } 0 \leq m \leq k(j) - 2. \quad (31)$$

The condition (EC) gives $\tilde{z} = \tilde{\Phi}^{k(j)}(\tilde{z}_j) \in \tilde{I}_\alpha$, for some $\alpha \in \{1, \dots, 2N\}$. Consider the fixed point $p^\alpha \in \tilde{I}_\alpha$ of $\tilde{\Phi}_\alpha$, given by condition (SE) and (CS). The definition of the involution ι and condition (SE) implies that the fixed point p^α belongs to the subinterval $I_{\alpha,\alpha}$ which is disjoint from $I_{\alpha,\delta(\alpha)} \cup I_{\alpha,\gamma(\alpha)}$. By definition of the intervals V_j in Lemma 3.2, we obtain: $p^\alpha \notin V_\alpha \cup V_{\zeta(\alpha)}$.

If $\tilde{z} = p^\alpha$ then we do not change the cutting point z_j .

If $\tilde{z} \neq p^\alpha$ then either $p^\alpha \in \tilde{\Phi}^{k(j)}(V_j^+)$ for $V_j^+ := \tilde{V}_j \cap \tilde{I}_j$ or $p^\alpha \in \tilde{\Phi}^{k(j)}(V_j^-)$ for $V_j^- := \tilde{V}_j \cap \tilde{I}_{\zeta^{-1}(j)}$. Assume, for instance, that $p^\alpha \in \tilde{\Phi}^{k(j)}(V_j^+)$ and let $p_j^\alpha = \tilde{\Phi}^{-k(j)}(p^\alpha) \in V_j^+ \subset \tilde{I}_j$, the other case is symmetric. The goal is to transform the map $\tilde{\Phi}$ to Φ' so that p_j^α is the new cutting point. Since $p_j^\alpha \in V_j^+ \subset \tilde{I}_j$ we define $\Phi'_j = \tilde{\Phi}_j$ on the interval $[p_j^\alpha, \tilde{z}_{\zeta(j)}]$. We define the map $\Phi'_{\zeta^{-1}(j)}$ by the λ -affine extension of $\tilde{\Phi}_{\zeta^{-1}(j)}$, i.e., from the interval $[\tilde{z}_{\zeta^{-1}(j)}, \tilde{z}_j]$ to $[\tilde{z}_{\zeta^{-1}(j)}, p_j^\alpha]$ as in (9). We apply the same construction for each cutting point. The permutations ζ and ι as well as all the $k(j)$ are the same for Φ' as for Φ . The properties in (31), coming from Lemma 3.3(a) and (E \pm) for Φ , imply that the conditions (E \pm) are satisfied by Φ' . The condition (EC) is satisfied by Φ' from the equality (b) in Lemma 3.3. Condition (CS), with slope λ is satisfied by Φ' by construction since Φ' is affine with the same slope. The two maps Φ and Φ' have thus the same combinatorics.

The choice of the new cutting point p_j^α of Φ' implies that $z' = \Phi'^{k(j)}(p_j^\alpha) = p^\alpha$ which is fixed by Φ' since $\Phi' = \tilde{\Phi}$ outside the set $\bigcup V_j$ and we observed that $p^\alpha \notin V_\alpha \cup V_{\zeta(\alpha)}$. Therefore we obtain: $\Phi'^m(z') = p^\alpha$ for all $m \geq 0$ and thus this orbit is always outside the set $\bigcup V_j$. By the proof of Lemma 4.2, the identifications of type (ii- \mathcal{E}) occur at all levels after level $k(j)$ and do not interact with identifications of type (ii- \mathcal{V}). Therefore the identifications of type (ii) in Lemma 4.2 are all with two intervals, i.e., are 2 to 1. \square

Remark 4. *All the cutting points of the new map Φ' are pre-periodic and thus the map satisfies a Markov property.*

This remark is immediate from a dynamical system point of view, it has an important consequence for our class of maps:

Lemma 4.4. *If Φ satisfies the conditions (SE), (E+), (E-), (EC) and (CS) with slope $\lambda > 1$ then λ is an algebraic integer.*

Proof. By Lemma 4.3 the two maps Φ and Φ' have the same combinatorics, in particular they have the same slope $\lambda > 1$. It is classical in one dimensional dynamics that

a piecewise affine map f with constant slope $\lambda > 1$ has positive topological entropy $h(f) = \log(\lambda)$. From the Remark 4, the map Φ' satisfies a Markov property and thus it is also classical that its topological entropy is the logarithm of an algebraic integer (see for instance [ALM] for the classical facts). \square

Lemma 4.5. *The two graphs $\Gamma_{\Phi'}$ and $\Gamma_{\Phi'}^0$, endowed with the combinatorial metric (every edge has length one), are quasi-isometric.*

Proof. Let us denote by $d_{\Gamma_{\Phi'}^0}$ and $d_{\Gamma_{\Phi'}}$ the combinatorial distances in $\Gamma_{\Phi'}^0$ and $\Gamma_{\Phi'}$. The two sets of vertices $V(\Gamma_{\Phi'}^0)$ and $V(\Gamma_{\Phi'})$ are related by a map:

$\mathcal{V} : V(\Gamma_{\Phi'}^0) \rightarrow V(\Gamma_{\Phi'})$ which is induced by the relation \sim_{Φ} of Definition 4 and is at most 2 to 1 by Lemma 4.3. Each vertex $v \in V(\Gamma_{\Phi'}^0) \setminus \{v_0\}$ is associated with an interval $I_v := I_{j_1, \dots, j_k}$ and thus with a vertex of the tree $T_{\Phi'}$. Two vertices of $\Gamma_{\Phi'}^0$, with the same \mathcal{V} -image correspond to adjacent intervals at the same level k , they are at distance one in $\Gamma_{\Phi'}^0$.

Two vertices connected by an edge on a sphere S_p^0 of radius p centered at the base vertex v_0 in $\Gamma_{\Phi'}^0$ are mapped either to a single vertex in the sphere S_p of radius p , centered at v_0 in $\Gamma_{\Phi'}$ or to two distinct vertices on the same sphere. These two vertices are connected in $\Gamma_{\Phi'}$ by a path of length at most $k(j)$, for some $j \in \{1, \dots, 2N\}$, where $k(j)$ is the integer in the condition (EC). We define $K_{\Phi'} := \max\{k(j) | j = 1, \dots, 2N\}$ then we obtain:

$$d_{\Gamma_{\Phi'}}(\mathcal{V}(v_\alpha^0), \mathcal{V}(v_\beta^0)) \leq K_{\Phi'} \cdot d_{\Gamma_{\Phi'}^0}(v_\alpha^0, v_\beta^0) + C,$$

for any pair of vertices (v_α^0, v_β^0) in $V(\Gamma_{\Phi'}^0) \times V(\Gamma_{\Phi'}^0)$.

Indeed a minimal length path between v_α^0 and v_β^0 is a concatenation of some paths along the spheres centered at v_0 and some paths along rays starting at v_0 . The length of the paths along the rays are preserved by the map \mathcal{V} and the length of the paths along the spheres are at most expanded by a factor bounded by $K_{\Phi'}$. On the other direction, the same observation and the fact that \mathcal{V} could identify at most two vertices implies:

$$d_{\Gamma_{\Phi'}}(\mathcal{V}(v_\alpha^0), \mathcal{V}(v_\beta^0)) \geq \frac{1}{K_{\Phi'}} d_{\Gamma_{\Phi'}^0}(v_\alpha^0, v_\beta^0) - C.$$

\square

Corollary 4.1. *The dynamical graph Γ_{Φ} , with the combinatorial distance, is hyperbolic with boundary homeomorphic to S^1 .*

Proof. A metric space quasi-isometric to a Gromov hyperbolic space is Gromov hyperbolic with the same boundary [GdlH]. By Lemmas 4.1 and 4.5 the graph $\Gamma_{\Phi'}$ is hyperbolic with boundary S^1 . By Proposition 4.1 the same property is satisfied by Γ_{Φ} . \square

5 An action of $G_{X_{\Phi}}$ on Γ_{Φ}

The group $G_{X_{\Phi}}$ of Definition 2, as a subgroups of $\text{Homeo}^+(S^1)$, is the main object of study for the rest of the paper. From Theorem 1, some relations are satisfied among the generators defined in §3, the cutting point relations, but we do not know if this is the whole set of relations. The classical method to study such groups is via a geometric

action on a metric space. The graph Γ_Φ of the previous section has been defined for that purpose. It is a hyperbolic metric space that reflects the dynamics of the map Φ but an action of G_{X_Φ} on Γ_Φ has to be defined, via the data we have i.e., the dynamics of the map Φ .

Recall that a *geometric action* of a group on a metric space is a morphism, acting by isometries that is co-compact and properly discontinuous.

By Lemma 4.2, each vertex $v \in V(\Gamma_\Phi)$ is identified with an interval $I_v \subset S^1$ and each $g \in G_{X_\Phi}$ is, in particular, a homeomorphism of S^1 . We need to understand, for each $g \in G_{X_\Phi}$ how the interval $g(I_v)$ is related to some I_w for $w \in V(\Gamma_\Phi)$.

An ideal situation would be that for “all v and all g there is w so that $g(I_v) = I_w$ ”, we will see immediately that this ideal situation does not happen for all vertices (see Lemma 5.1). The idea for defining an action is to weaken this ideal situation and to find an interval I_w so that $g(I_v)$ and I_w are “close enough” i.e., to admit a controlled error. In the previous section, we simplified the notations by not making distinctions between Φ and $\tilde{\Phi}$ or \tilde{I}_j and I_j . We keep this simplification here and simplify also the notation for the generators, we write φ_j for φ_j^∞ .

5.1 A preliminary step

Let us describe how the generators $\varphi_j \in X_\Phi$ of the group do act on the partition intervals I_m for all $m \in \{1, \dots, 2N\}$ i.e., on the intervals associated to vertices of level 1 in Γ_Φ .

Lemma 5.1. *If Φ is a piecewise homeomorphism of S^1 satisfying the conditions (SE), (E-), (E+), (EC) and (CS), let $\varphi_j \in X_\Phi$ be a generator of the group G_{X_Φ} given by Theorem 1. If I_m is a partition interval, $m \in \{1, \dots, 2N\}$ then $\varphi_j(I_m)$ satisfies one of the following conditions:*

- (a) *If $m = j$ then: $\varphi_j(I_j) \cap I_k \neq \emptyset$ for all $k \neq \iota(j)$.*
- (b) *If $m \notin \{j, \zeta^{\pm 1}(j)\}$ then: $\varphi_j(I_m) = I_{\iota(j), m}$.*
- (c) *$\varphi_j(I_{\zeta(j)}) = I_{\iota(j), \zeta(j)} \cup L_{\iota(j)}$ and $\varphi_j(I_{\zeta^{-1}(j)}) = I_{\iota(j), \zeta^{-1}(j)} \cup R_{\iota(j)}$, where $L_{\iota(j)}$ and $R_{\iota(j)}$ are defined in (3), they satisfy:
 $L_{\iota(j)} \subsetneq I_{\gamma(j), \gamma^2(j), \dots, \gamma^{k(\zeta(j))-1}(j)}$, and $R_{\iota(j)} \subsetneq I_{\delta(j), \delta^2(j), \dots, \delta^{k(j)-1}(j)}$,
where $k(\zeta(j))$ and $k(j)$ are the integers of condition (EC).*

Proof. The proof is a case by case study.

(a) This is simply condition (SE) on the map Φ .

(b) By definition of the generators φ_j in Theorem 1, they satisfy:

$$(\varphi_j)|_{\tilde{\Phi}_{\iota(j)}(I_{\iota(j)})} = (\tilde{\Phi}_{\iota(j)})_{|\tilde{\Phi}_{\iota(j)}(I_{\iota(j)})}^{-1}. \text{ Condition (SE) implies that: } \tilde{\Phi}_{\iota(j)}(I_{\iota(j)}) \cap I_m = I_m,$$

for all $m \neq j, \zeta^{\pm 1}(j)$. Therefore we obtain: $I_{\iota(j)} \cap \tilde{\Phi}_{|\iota(j)}^{-1}(I_m) = \tilde{\Phi}_{|\iota(j)}^{-1}(I_m)$ which reads:

$$I_{\iota(j), m} = \varphi_j(I_m) \text{ (see Figure 9).}$$

(c) The two situations are symmetric, we restrict to one of them, for instance to $\varphi_j(I_{\zeta(j)})$.

By condition (SE), applied to I_j and $I_{\iota(j)}$, we have:

$$(i) \varphi_j(I_j) \cap I_{\gamma(j)} \subsetneq I_{\gamma(j)}, \text{ and (ii) } \varphi_{\iota(j)}(I_{\iota(j)}) \cap I_{\zeta(j)} \subsetneq I_{\zeta(j)}.$$

By (i) and the continuity of φ_j we have $L_{\iota(j)} = \varphi_j(I_{\zeta(j)}) \cap I_{\gamma(j)} \neq \emptyset$, and by (ii) we have $\varphi_j(I_{\zeta(j)}) \cap I_{\iota(j)} \neq \emptyset$. On the other hand, by definition of the generators φ_j and Lemma

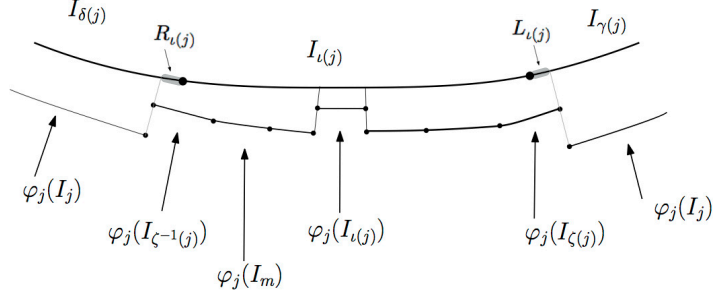

Figure 9: Image of the intervals I_m under φ_j

3.1 we have:

$$\varphi_j(I_{\zeta(j)}) \cap I_{\iota(j)} = \tilde{\Phi}_{|I_{\iota(j)}}^{-1}(I_{\zeta(j)}) \cap I_{\iota(j)} = I_{\iota(j), \zeta(j)}.$$

Thus, we obtain $\varphi_j(I_{\zeta(j)}) = I_{\iota(j), \zeta(j)} \cup L_{\iota(j)}$ (see Figure 9).

To complete the proof we verify the properties of the interval $L_{\iota(j)}$ (resp. $R_{\iota(j)}$). With the notations of the cutting points, this interval is:

$$L_{\iota(j)} = [\varphi_j(z_{\zeta(j)}), z_{\iota(j)}] \text{ (see Figure 9).}$$

By condition (E+) at $z_{\zeta(j)}$ we have: $\forall i, 0 \leq i \leq k(\zeta(j)) - 2 : \tilde{\Phi}^i(\tilde{\Phi}_j(z_{\zeta(j)})) \in I_{\gamma^{i+1}(j)}$. For $i = 0$: $\tilde{\Phi}_j(z_{\zeta(j)}) = \varphi_j(z_{\zeta(j)}) \in I_{\gamma(j)}$, and for $i = 1$: $\tilde{\Phi}(\tilde{\Phi}_j(z_{\zeta(j)})) \in I_{\gamma^2(j)}$, this last condition means that the $\tilde{\Phi}$ image of the point $\varphi_j(z_{\zeta(j)}) \in I_{\gamma(j)}$ belongs to the same partition interval as the $\tilde{\Phi}$ image of the cutting point $z_{\iota(j)}$. Therefore the point $\varphi_j(z_{\zeta(j)})$ belongs to the interior of the last sub-interval of level 2, with respect to the cyclic ordering of S^1 , of the partition interval $I_{\gamma(j)}$ which is $I_{\gamma(j), \gamma^2(j)}$. This implies that: $L_{\iota(j)} \subsetneq I_{\gamma(j), \gamma^2(j)}$ which is part of the statement. At this stage we only use the first iterate ($i = 1$) in conditions (E+). The proof of (c) is completed by applying the same arguments for all iterates: $i \leq k(\zeta(j)) - 2$ in condition (E+), we obtain:

$$L_{\iota(j)} \subsetneq I_{\gamma(j), \gamma^2(j), \dots, \gamma^{k(\zeta(j))-1}(j)}.$$

This completes the proof of statement (c) in this case. The symmetric situation in case (c), is obtained by replacing ζ by ζ^{-1} , γ by δ and condition (E+) by (E-). \square

5.2 Additional properties of Γ_{Φ}

From the proof of Lemma 5.1, the intervals of level $m \leq k(j) - 2$ in the tree T_{Φ} that are extreme in the interval I_j , i.e., contain a cutting point, are of the form:

$$I_{j, \delta(j), \dots, \delta^m(j)} \text{ and } I_{j, \gamma(j), \dots, \gamma^m(j)}. \quad (32)$$

The intervals of type (ii) and level $k(j)$ in the proof of Lemma 4.2 are thus of the form:

$$I_{\tilde{v}_j} := I_{j, \delta(j), \dots, \delta^{k(j)-1}(j)} \cup I_{\zeta^{-1}(j), \gamma(\zeta^{-1}(j)), \dots, \gamma^{k(j)-1}(\zeta^{-1}(j))}, \quad (33)$$

where the first interval is extreme of level $k(j)$ on the (+) side of \tilde{z}_j and the second is extreme on the (-) side of the same cutting point. This interval is of type (ii-V). It contains sub-intervals of level $k(j) + 1$ and possibly one with the cutting point z_j in its

interior, as in case 2) in the proof of Lemma 4.2:

$$I_{\tilde{v}_j, \alpha} := I_{\zeta^{-1}(j), \gamma(\zeta^{-1}(j)), \dots, \gamma^{k(j)-1}(\zeta^{-1}(j)), \alpha} \cup I_{j, \delta(j), \dots, \delta^{k(j)-1}(j), \alpha},$$

where α satisfies (7), this interval is of type $(ii-\mathcal{E})$.

More generally, from Definition 4 of the equivalence relation \sim_{Φ} , an interval of type $(ii-\mathcal{V})$ is of the form:

$$I_{\tilde{v}_{\ell, j}} := I_{\ell, \zeta^{-1}(j), \gamma(\zeta^{-1}(j)), \dots, \gamma^{k(j)-1}(\zeta^{-1}(j))} \cup I_{\ell, j, \delta(j), \dots, \delta^{k(j)-1}(j)}, \quad (34)$$

where ℓ is a finite sequence (possibly empty) in $\{1, \dots, 2N\}$. The vertices, associated to these intervals by Lemma 4.2, are denoted: \tilde{v}_j , $\tilde{v}_{j, \alpha}$ and $\tilde{v}_{\ell, j}$, respectively.

The next result induces an additional structure of the graph Γ_{Φ} around each vertex.

Proposition 5.1. *If the map Φ satisfies the ruling conditions: (SE), (EC), (E+), (E-), (CS) then the set of edges that are incident to a vertex $v \in V(\Gamma_{\Phi})$ admits a natural cyclic ordering induced by the cyclic ordering of the partition intervals I_j along S^1 . In addition each vertex has valency $2N$.*

Proof. By definition of Γ_{Φ} , the cyclic ordering of the intervals I_j along S^1 defines a cyclic ordering of the vertices of level 1 and thus a cyclic ordering on the edges incident at v_0 . By Proposition 4.1 the structure of Γ_{Φ} depends only on the combinatorics of the map Φ . To simplify the arguments we assume that the identification of type (ii) are all 2 to 1, as in Lemma 4.3.

If $v = v_{j_1, \dots, j_t} \in V(\Gamma_{\Phi})$ is a vertex of type (i) or $(ii-\mathcal{E})$ and level $t \geq 1$: Then it is connected to one vertex of level $t - 1$, i.e., to $v = v_{j_1, \dots, j_{t-1}}$, and to $2N - 1$ vertices of level $t + 1$, by condition (SE). At level $t + 1$, these vertices w_i are ordered by the ordering of the sub-intervals I_{w_i} along the interval I_v , as sub-intervals of S^1 . Recall that the ordering along S^1 is expressed by the permutation ζ (see § 2.1). By condition (SE) these vertices at level $t + 1$ are:

$$v_{j_1, \dots, j_t, \zeta(\bar{j}_t)}, v_{j_1, \dots, j_t, \zeta^2(\bar{j}_t)}, \dots, v_{j_1, \dots, j_t, \zeta^{2N-1}(\bar{j}_t)}.$$

The edges arriving at these vertices, from v , are labelled respectively:

$$\Psi_{\zeta(\bar{j}_t)}, \dots, \Psi_{\zeta^{2N-1}(\bar{j}_t)}.$$

The vertex at level $t - 1$ is $v_{j_1, \dots, j_{t-1}}$ and the reverse edge, i.e., from v to it, is labelled $\Psi_{\bar{j}_t}$. Therefore, the vertices of type (i) or $(ii-\mathcal{E})$ admit a cyclic ordering of the edges induced by the permutation ζ .

If v is a vertex of type $(ii-\mathcal{V})$:

Then, there is $j \in \{1, \dots, 2N\}$ and a finite sequence ℓ in $\{1, \dots, 2N\}$ so that v is identified with an interval $I_{\tilde{v}_{\ell, j}}$ as in (34).

From the equivalence relation \sim_{Φ} , the vertex v has two incoming edges and they are adjacent by Lemma 2.4. These two edges are labelled, reading from v , as:

$$\Psi_{\overline{\delta^{k(j)-1}(j)}} \text{ and } \Psi_{\overline{\gamma^{k(j)-1}(\zeta^{-1}(j))}}.$$

And there are $2N - 2$ out-going edges, ordered by the ordering along S^1 . By condition (7) in the proof of Lemma 3.2, they are labelled as:

$$\Psi_{\overline{\zeta(\gamma^{k(j)-1}(\zeta^{-1}(j)))}}, \dots, \Psi_{\overline{\zeta^{2N-2}(\gamma^{k(j)-1}(\zeta^{-1}(j)))}}.$$

In all cases, i.e., for the vertices of type (i) , $(ii-\mathcal{E})$ or $(ii-\mathcal{V})$, $2N$ edges are incident at v and they are cyclically ordered by the permutation ζ and thus by the ordering of the intervals along S^1 . \square

Corollary 5.1. *To each pair of adjacent edges, for the natural cyclic ordering of Proposition 5.1, at any vertex v , there is exactly one “cutting point” relation of Theorem 1 defined by this pair.*

Proof. By the proof of Theorem 1, each “cutting point” relation is associated to a cycle of the permutation δ or γ . From the proof of Lemma 5.1, a cycle of the permutation δ or γ is also associated to the iteration of Φ via conditions (E+), (E-). In term of the edges in Γ_Φ , the cycle defines the following loop, given by the sequence of labeled edges:

$$\Psi_{\zeta^{-1}(j)}, \Psi_{\gamma(\zeta^{-1}(j))}, \dots, \Psi_{\gamma^{k(j)-1}(\zeta^{-1}(j))}, \Psi_{\overline{\delta^{k(j)-1}(j)}}, \dots, \Psi_{\overline{\delta(j)}}, \Psi_{\overline{j}},$$

for each $j = 1, \dots, 2N$, see Figure 10. The two edges labeled $\Psi_{\zeta^{-1}(j)}$ and Ψ_j are adjacent by definition of ζ . Moreover, since the cycles of the permutations are disjoint, each pair of consecutive edges is associated to exactly one “cutting point” relation. \square

Remark 5. *Any vertex $v \in V(\Gamma_\Phi)$ is contained in a compact set \mathcal{C}_v defined by the union of the loops associated to the pairs of consecutive edges in Corollary 5.1 (see Figure 10 for \mathcal{C}_{v_0}). The set \mathcal{C}_{v_0} is based at v_0 and the vertices at local maximal distance from v_0 are vertices of type $(ii-\mathcal{V})$, that we will call the extreme vertices of \mathcal{C}_{v_0} . The other vertices are of type (i) according to Lemma 4.2. Indeed, the extreme vertices above are the first one, starting from v_0 , for which any identification of Definition 4 can occur.*

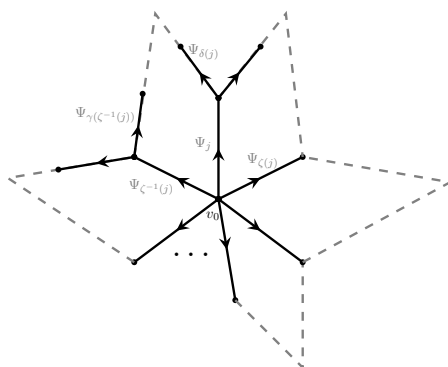

Figure 10: The compact set \mathcal{C}_{v_0} in Γ_Φ

5.3 How the generators do act on the vertices of \mathcal{C}_{v_0} ?

In this part we study the action of each generator φ_j on the set of intervals corresponding to the vertices of the compact set \mathcal{C}_{v_0} . Lemma 5.1 is the first step and most of the arguments are exactly like in its proof. Observe that \mathcal{C}_{v_0} is contained in the ball of Γ_Φ : $\text{Ball}(v_0, K_\Phi)$ where the radius $K_\Phi = \max\{k(j) : j \in \{1, \dots, 2N\}\}$ was defined in the proof of Lemma 4.5.

Proposition 5.2. *With the above definitions and notations, the image under φ_j of the intervals I_v of type (i), associated to the vertices in \mathcal{C}_{v_0} by Lemma 4.2, are given by the following cases:*

- 1) *If the cutting point z_j is a boundary point of I_v then, for $0 \leq m \leq k(j) - 2$:*
 - (a) *if $I_v = I_{j, \delta(j), \delta^2(j), \dots, \delta^m(j)}$ then $\varphi_j(I_v) \subset I_{\delta(j), \dots, \delta^m(j)}$ with $\varphi_j(I_v) \cap I_{\delta(j), \dots, \delta^m(j), \alpha} \neq \emptyset$, for all possible such $\alpha \in \{1, \dots, 2N\}$, i.e., all except one,*
 - (b) *if $I_v = I_{\zeta^{-1}(j), \dots, \gamma^m(\zeta^{-1}(j))}$ then $\varphi_j(I_v) = I_{\iota(j), \zeta^{-1}(j), \dots, \gamma^m(\zeta^{-1}(j))} \cup R_{\iota(j)}$, where $R_{\iota(j)}$ satisfies the properties (c) in Lemma 5.1.*
- 2) *If $z_{\zeta(j)}$ is a boundary point of I_v then, for $0 \leq m \leq k(\zeta(j)) - 2$:*
 - (a) *if $I_v = I_{j, \gamma(j), \delta^2(j), \dots, \gamma^m(j)}$ then $\varphi_j(I_v) \subset I_{\gamma(j), \dots, \gamma^m(j)}$ with $\varphi_j(I_v) \cap I_{\gamma(j), \dots, \gamma^m(j), \alpha} \neq \emptyset$, for all possible such $\alpha \in \{1, \dots, 2N\}$, i.e., all except one,*
 - (b) *if $I_v = I_{\zeta(j), \delta(\zeta(j)), \dots, \delta^m(\zeta(j))}$ then $\varphi_j(I_v) = I_{\iota(j), \zeta(j), \dots, \delta^m(\zeta(j))} \cup L_{\iota(j)}$, where $L_{\iota(j)}$ satisfies the properties (c) in Lemma 5.1.*
- 3) *If I_v is of type (i) and does not contain z_j or $z_{\zeta(j)}$ as a boundary point then it has the form: $I_v = I_{j_1, \dots, j_r}$ for $j_1 \neq j$ and $\varphi_j(I_v) = I_{\iota(j), j_1, \dots, j_r}$.*

Proof. Let $v \in V(\Gamma_\Phi) \cap \mathcal{C}_{v_0}$.

1) If the cutting point z_j belongs to the boundary of I_v and v is a vertex of type (i) according to Lemma 4.2 then it is given by (32). Let us consider this set of intervals.

(a) If $I_v = I_{j, \delta(j), \delta^2(j), \dots, \delta^m(j)}$.

For $m = 1$, the argument in the proof of Lemma 5.1-(a) implies: $\varphi_j(I_{j, \delta(j)}) \subset I_{\delta(j)}$ and $\varphi_j(I_{j, \delta(j)}) \cap I_{\delta(j), \alpha} \neq \emptyset$ for all such possible α .

The same argument applies for all $1 \leq m \leq k(j) - 2$ and we obtain the statement (1-a) in this case.

(b) If $I_v = I_{\zeta^{-1}(j), \gamma(\zeta^{-1}(j)), \dots, \gamma^m(\zeta^{-1}(j))}$, the arguments in the proof of Lemma 5.1-(c) apply and we obtain, for all $1 \leq m \leq k(j) - 2$:

$\varphi_j(I_{\zeta^{-1}(j), \gamma(\zeta^{-1}(j)), \gamma^2(\zeta^{-1}(j)), \dots, \gamma^m(\zeta^{-1}(j))}) = I_{\iota(j), \zeta^{-1}(j), \gamma(\zeta^{-1}(j)), \dots, \gamma^m(\zeta^{-1}(j))} \cup R_{\iota(j)}$,
where $R_{\iota(j)} \subsetneq I_{\delta(j), \delta^2(j), \dots, \delta^{k(j)-1}(j)}$ by Lemma 5.1-(c).

2) If z_j is replaced by $z_{\zeta(j)}$ then $\delta(j)$ is replaced by $\gamma(j)$, the condition (E+) is replaced by (E-) and the same arguments apply, by symmetry.

3) If the interval I_v of type (i), level $r > 1$ and does not contain the cutting points $z_{\zeta(j)}$ or z_j then it has the form I_{j_1, \dots, j_r} with $j_1 \neq j$ and if $j_1 = \zeta^{\pm 1}(j)$ then $j_2 \neq \gamma(j)$ or $\delta(\zeta^{-1}(j))$. In these cases, the arguments in Lemma 5.1-(b) apply and $\varphi_j(I_{j_1, \dots, j_r}) = I_{\iota(j), j_1, \dots, j_r}$. \square

For the next result we consider the intervals of type (ii) of Lemma 4.2. They are the ‘‘extreme vertices’’ of \mathcal{C}_{v_0} in Remark 5 (see Figure 10). At level $k(j)$, around z_j , they are given by the intervals $I_{\tilde{v}_j}$ in (33).

Proposition 5.3. *With the above definitions and notations the image, under φ_j , of the intervals $I_{\tilde{v}_m}$ of type (ii) associated to the vertices in \mathcal{C}_{v_0} are given by the following cases:*

- 1) $\varphi_j(I_{\tilde{v}_j}) \subset I_{\delta(j), \delta^2(j), \dots, \delta^{k(j)-1}(j)}$ (resp. $\varphi_j(I_{\tilde{v}_{\zeta(j)}}) \subset I_{\gamma(j), \gamma^2(j), \dots, \gamma^{k(\zeta(j))-1}(j)}$) and it intersects all sub intervals of level $k(j)$ (resp. $k(\zeta(j))$), except one.

2) $\varphi_j(I_{\tilde{v}_l}) = I_{\iota(j), \tilde{v}_l}$, with the notation (34) for $l \notin \{j, \zeta(j)\}$.

Proof. 1) From the definition of the neighborhood V_j in Lemma 3.2, we observe that the interval $I_{\tilde{v}_j}$ of (33) satisfies : $V_j = I_{\tilde{v}_j}$.

The generators φ_j given by Theorem 1, together with Lemma 3.3 gives:

$$\varphi_j(I_{\tilde{v}_j}) \subset I_{\delta(j)} \setminus I_{\tilde{v}_{\delta(j)}}.$$

From the construction of the neighborhood V_j in Lemma 3.2 we obtain:

$\Phi^m(\varphi_j(I_{\tilde{v}_j})) \subset I_{\delta^{m+1}(j)}$ for all $m = 0, \dots, k(j)-2$, and thus : $\varphi_j(I_{\tilde{v}_j}) \subset I_{\delta(j), \delta^2(j), \dots, \delta^{k(j)-1}(j)}$.

For the next iterate of Φ , the condition (7) implies:

$$\Phi^{k(j)-1}(\varphi_j(I_{\tilde{v}_j})) \cap I_m \neq \emptyset \text{ for all } m \neq \overline{\gamma^{k(j)-1}(\zeta^{-1}(j))}, \overline{\delta^{k(j)-1}(j)}.$$

We observe that $I_{\tilde{v}_{\delta(j)}} \cap I_{\delta(j)}$ is a subinterval of $I_{\delta(j), \delta^2(j), \dots, \delta^{k(j)}(j)}$ of level $k(j)$ and by Lemma 3.3-(a) we have: $\varphi_j(I_{\tilde{v}_j}) \cap I_{\tilde{v}_{\delta(j)}} = \emptyset$. Therefore $\varphi_j(I_{\tilde{v}_j})$ intersects all subintervals of level $k(j)$ of $I_{\delta(j), \delta^2(j), \dots, \delta^{k(j)-1}(j)}$, except one, i.e., $I_{\tilde{v}_{\delta(j)}} \cap I_{\delta(j)}$.

If $I_{\tilde{v}_j}$ is replaced by $I_{\tilde{v}_{\zeta(j)}}$ then the same arguments apply by replacing $\delta(j)$ with $\gamma(j)$.

2) For $I_{\tilde{v}_l} = I_{\zeta^{-1}(l), \gamma(\zeta^{-1}(l)), \dots, \gamma^{k(l)-1}(\zeta^{-1}(l))} \cup I_{l, \delta(l), \dots, \delta^{k(l)-1}(l)}$, we have

$$\varphi_j(I_{\zeta^{-1}(l), \gamma(\zeta^{-1}(l)), \dots, \gamma^{k(l)-1}(\zeta^{-1}(l))}) = I_{\iota(j), \zeta^{-1}(l), \gamma(\zeta^{-1}(l)), \dots, \gamma^{k(l)-1}(\zeta^{-1}(l))}$$

and $\varphi_j(I_{l, \delta(l), \dots, \delta^{k(l)-1}(l)}) = I_{\iota(j), l, \delta(l), \dots, \delta^{k(l)-1}(l)}$ because $I_{\tilde{v}_l} \subset \Phi_{\iota(j)}(I_{\iota(j)})$ and $l \notin \{j, \zeta(j)\}$,

this is the same argument as in case (3) of Proposition 5.2. Then:

$\varphi_j(I_{\tilde{v}_l}) = I_{\iota(j), \zeta^{-1}(l), \gamma(\zeta^{-1}(l)), \dots, \gamma^{k(l)-1}(\zeta^{-1}(l))} \cup I_{\iota(j), l, \delta(l), \dots, \delta^{k(l)-1}(l)} = I_{\iota(j), \tilde{v}_l}$, with the notation (34). \square

5.4 The action

We define here a map $\mathcal{A}_g : \Gamma_\Phi \rightarrow \Gamma_\Phi$ for all $g \in G_{X_\Phi}$, Lemma 5.1 and the Propositions 5.2 and 5.3 are guide lines to this aim. From Lemma 4.2, each vertex $v \neq v_0$ of Γ_Φ is identified with an interval I_v of S^1 , and each $g \in G_{X_\Phi}$ maps I_v to $g(I_v)$, another interval of S^1 . We have to understand how each interval $g(I_v)$ is related to some interval I_w , for a vertex w of Γ_Φ . Lemma 5.1 implies, in particular, that we cannot expect: “ $g(I_v) = I_w$ ” for all intervals I_v . But it shows that if we allow a “small” error then we can associate to $g(I_v)$ an interval I_w . This is one way to interpret Lemma 5.1 case (c), and its consequences in Proposition 5.2 cases (1-b) and (2-b).

Definition 5. Let G_{X_Φ} be the group of Definition 2, and let Γ_Φ be the dynamical graph of Definition 4 with vertex set $V(\Gamma_\Phi)$. For each $v \in V(\Gamma_\Phi)$, let I_v be the interval associated to v by Lemma 4.2. For each generator $\varphi_j \in X_\Phi$, $j = 1, \dots, 2N$, let:

$\mathcal{A}_{\varphi_j} : V(\Gamma_\Phi) \rightarrow V(\Gamma_\Phi)$ be a map defined as follows:

- (1) If $v \neq v_0$ and $\varphi_j(I_v)$ intersects all partition intervals I_k of level one except one, then: $\mathcal{A}_{\varphi_j}(v) := v_0$
- (2) If $v \neq v_0$ and there exists $w \in V(\Gamma_\Phi)$ such that $\varphi_j(I_v) \subseteq I_w$ and $\varphi_j(I_v)$ intersects all subintervals $I_{w'} \subset I_w$ of level one more than w , except possibly one, then: $\mathcal{A}_{\varphi_j}(v) := w$

- (3) (i) If $v \neq v_0$ and there exists $w \in V(\Gamma_\Phi)$ a vertex of type (i) or (ii- \mathcal{E}) in Lemma 4.2 such that $I_w \subset \varphi_j(I_v)$ and no other $I_{w'}$, for w' of the same level as w is contained in $\varphi_j(I_v)$ then: $\mathcal{A}_{\varphi_j}(v) := w$
(ii) If $v \neq v_0$ and there exists $w \in V(\Gamma_\Phi)$ a vertex of type (ii- \mathcal{V}) in Lemma 4.2 such that $I_w \subset \varphi_j(I_v)$ and $\varphi_j(I_v)$ does not contain $I_{w'}$ for w' of level one less than w then: $\mathcal{A}_{\varphi_j}(v) := w$
(4) $\mathcal{A}_{\varphi_j}(v_0) := v_{\iota(j)}$

If $g = \varphi_{n_1} \circ \dots \circ \varphi_{n_k}$ we define $\mathcal{A}_g := \mathcal{A}_{\varphi_{n_1}} \circ \dots \circ \mathcal{A}_{\varphi_{n_k}}$.

The goal of this subsection is to show that the map \mathcal{A}_g is well defined and can be extended to a map on the graph Γ_Φ . In particular we need to check that the map \mathcal{A}_g does not depend on the expression, in the generators, of the element g .

The next subsection will be about proving that this map defines a geometric action. These are the main technical parts of the proof.

The definition of the map \mathcal{A}_g is new and not standard. As a warm up, let us check it is well defined for each generator φ_j on the vertices of level 1. For this we compute $\varphi_j(I_m)$ for j and $m \in \{1, \dots, 2N\}$. Lemma 5.1 gives all the possibilities:

- If $m = j$ then, case (a) in Lemma 5.1 and case (1) of Definition 5 gives: $\mathcal{A}_{\varphi_j}(v_j) = v_0$.
- If $m \neq j, \zeta^{\pm 1}(j)$ then, case (b) of Lemma 5.1 and case (2) of Definition 5 gives:

$$\mathcal{A}_{\varphi_j}(v_m) = v_{\iota(j), m}.$$

- If $m = \zeta^{\pm 1}(j)$ then, case (c) of Lemma 5.1 and case (3-i) of Definition 5 gives:

$$\mathcal{A}_{\varphi_j}(v_m) = v_{\iota(j), m}.$$

With case (4) in Definition 5, we obtain, for each generator φ_j , that \mathcal{A}_{φ_j} maps the ball of radius one centered at v_0 in Γ_Φ , to the ball of radius one centered at $v_{\iota(j)}$.

Proposition 5.4. *The map \mathcal{A}_{φ_j} of Definition 5 is well defined for all the vertices in the compact set \mathcal{C}_{v_0} of Remark 5, for all $j \in \{1, \dots, 2N\}$.*

Proof. We already checked that \mathcal{A}_{φ_j} is well defined for the vertices of level ≤ 1 . Let us verify this property for all the vertices in \mathcal{C}_{v_0} .

1) If v is a vertex of type (i) in \mathcal{C}_{v_0} , the image of the corresponding interval by φ_j is given by Proposition 5.2. For these cases either $v = v_{j_1, \gamma(j_1), \dots, \gamma^n(j_1)}$ or $v = v_{j_1, \delta(j_1), \dots, \delta^n(j_1)}$, for some j_1 and $n \leq k(j_1) - 2$.

(a) If $j_1 \neq j, \zeta^{\pm 1}(j)$, Proposition 5.2 case (3) gives: $\varphi_j(I_{j_1, j_2, \dots, j_n}) = I_{\iota(j), j_1, j_2, \dots, j_n}$ and by Definition 5 case (2):

$$\text{either } \mathcal{A}_{\varphi_j}(v) = v_{\iota(j), j_1, \gamma(j_1), \dots, \gamma^n(j_1)} \text{ or } \mathcal{A}_{\varphi_j}(v) = v_{\iota(j), j_1, \delta(j_1), \dots, \delta^n(j_1)}.$$

(b) If $j_1 = j$, then Proposition 5.2 case (2-a) gives: $\varphi_j(I_{j, \gamma(j), \dots, \gamma^n(j)}) \subset I_{\gamma(j), \dots, \gamma^n(j)}$, (resp. by case (1-a): $\varphi_j(I_{j, \delta(j), \dots, \delta^n(j)}) \subset I_{\delta(j), \dots, \delta^n(j)}$). In addition $\varphi_j(I_v)$ intersects all subintervals of level $n + 1$. By Definition 5 case (2) we obtain:

$$\text{either } \mathcal{A}_{\varphi_j}(v) = v_{\gamma(j), \dots, \gamma^n(j)} \text{ or } \mathcal{A}_{\varphi_j}(v) = v_{\delta(j), \dots, \delta^n(j)}.$$

(c) If $j_1 = \zeta^{\pm 1}(j)$, for instance $j_1 = \zeta^{-1}(j)$, Proposition 5.2 case (1-b) gives:

$$\varphi_j(I_v) = I_{\iota(j), \zeta^{-1}(j), \gamma(\zeta^{-1}(j)), \dots, \gamma^n(\zeta^{-1}(j))} \cup R_{\iota(j)}, \text{ with } R_{\iota(j)} \subset I_{\delta(j), \dots, \delta^{k(j)-1}(j)},$$

and there are two different situations:

- (i) If $n < k(j) - 2$, then $I_{\iota(j), \zeta^{-1}(j), \gamma(\zeta^{-1}(j)), \dots, \gamma^n(\zeta^{-1}(j))}$ is an interval of type (i) and level $n + 2 \leq k(j) - 1$ and $R_{\iota(j)}$ is contained in an interval of level $k(j) - 1$. Definition 5 case (3-i) gives:

$$\mathcal{A}_{\varphi_j}(v) = v_{\iota(j), \zeta^{-1}(j), \gamma(\zeta^{-1}(j)), \dots, \gamma^n(\zeta^{-1}(j))}.$$

- (ii) If $n = k(j) - 2$, then $I_{\iota(j), \zeta^{-1}(j), \gamma(\zeta^{-1}(j)), \dots, \gamma^{k(j)-2}(\zeta^{-1}(j))}$ is an interval of level $k(j)$ and $R_{\iota(j)}$ is contained in an interval of level $k(j) - 1$ and thus does not contain an interval of level $k(j) - 1$. Recall that the interval of type (ii) containing the cutting point $z_{\delta(j)}$ is given by (33): $I_{\tilde{v}_{\delta(j)}} = I_{\iota(j), \zeta^{-1}(j), \gamma(\zeta^{-1}(j)), \dots, \gamma^{k(j)-2}(\zeta^{-1}(j))} \cup I_{\delta(j), \dots, \delta^{k(j)}(j)}$.

By Lemma 3.3 it satisfies: $\varphi_j(I_{\tilde{v}_j}) \cap I_{\tilde{v}_{\delta(j)}} = \emptyset$, which implies:

$R_{\iota(j)} \cap I_{\tilde{v}_{\delta(j)}} = I_{\delta(j), \dots, \delta^{k(j)}(j)}$, these equalities together give:

$$\varphi_j(I_v) = I_{\tilde{v}_{\delta(j)}} \cup [R_{\iota(j)} \setminus I_{\delta(j), \dots, \delta^{k(j)}(j)}].$$

Therefore $\varphi_j(I_v)$ contains the interval of type (ii) $I_{\tilde{v}_{\delta(j)}}$ of level $k(j)$ and does not contain any interval of level $k(j) - 1$. Thus, by Definition 5 case (3-ii) we obtain:

$$\mathcal{A}_{\varphi_j}(v) = v_{\tilde{v}_{\delta(j)}}.$$

- 2) If v is a vertex of type (ii), the image of the corresponding interval under φ_j is given by Proposition 5.3, which gives:

- (a) $\mathcal{A}_{\varphi_j}(\tilde{v}_j) = v_{\delta(j), \delta^2(j), \dots, \delta^{k(j)-1}(j)}$ and $\mathcal{A}_{\varphi_j}(\tilde{v}_{\zeta(j)}) = v_{\gamma(j), \gamma^2(j), \dots, \gamma^{k(\zeta(j))-1}(j)}$, by Proposition 5.3 case (1) and Definition 5 case (2).
(b) $\mathcal{A}_{\varphi_j}(\tilde{v}_n) = \tilde{v}_{\iota(j), n}$, for $n \notin \{j, \zeta(j)\}$, by Proposition 5.3 case (3), Definition 5 case (2).

This completes the case by case proof for all the vertices in \mathcal{C}_{v_0} . \square

Remark 6. *The vertices studied in Proposition 5.4 are associated to intervals containing a cutting point, either in its boundary or in its interior. There are many other intervals, they are of the form I_{j_1, j_2, \dots, j_r} where $j_2 \notin \{\gamma(j_1), \delta(j_1)\}$ or $j_2 \in \{\gamma(j_1), \delta(j_1)\}$ and $j_3 \notin \{\gamma^2(j_1), \delta^2(j_1)\}$ and so on. Suppose that v_{j_1, j_2, \dots, j_r} is a vertex associated to such an interval then:*

- (1) If $j_1 = j$: then $\mathcal{A}_{\varphi_j}(v_{j, j_2, \dots, j_r}) = v_{j_2, \dots, j_r}$, by the definition of I_{j_1, j_2, \dots, j_r} and Definition 5 case (2).
(2) If $j_1 \neq j$: then $\mathcal{A}_{\varphi_j}(v_{j_1, j_2, \dots, j_r}) = v_{\iota(j), j_1, j_2, \dots, j_r}$, by the definition of I_{j_1, j_2, \dots, j_r} , and Definition 5 case (2).

The following result is a co-compactness property for the maps \mathcal{A} .

Proposition 5.5. *For any vertex $v \in V(\Gamma_{\Phi}) \setminus \{v_0\}$ of level n , there exists a group element $g \in G_{X_{\Phi}}$ of length $l \leq n$ so that: $\mathcal{A}_g(v) \in \mathcal{C}_{v_0}$.*

Proof. Assume that v is of type (i) and let $I_v = I_{j_1, j_2, \dots, j_n}$. If I_v does not contain a cutting point z_{j_1} or $z_{\zeta(j_1)}$ on its boundary, then by Remark 6 case (1), we have: $I_v \subset \text{int}(I_{j_1})$ and $\varphi_{j_1}(I_v) = I_{j_2, \dots, j_n}$ is an interval of type (i) and level $n - 1$ and thus: $\mathcal{A}_{\varphi_{j_1}}(v) = v_{j_2, \dots, j_n}$.

If $I_v = I_{j_1, j_2, \dots, j_n}$ is of type (i) and contains z_{j_1} or $z_{\zeta(j_1)}$ on its boundary then $\varphi_{j_1}(I_v) \subset I_{j_2, \dots, j_n}$ and intersects all subintervals of level n , as in Proposition 5.2 case (1-a) and thus: $\mathcal{A}_{\varphi_{j_1}}(v) = v_{j_2, \dots, j_n}$ is a vertex of level $n - 1$.

If $I_v = I_{j_1, j_2, \dots, j_n}$ is of type (ii) and does not contain z_{j_1} or $z_{\zeta(j_1)}$ then, as above we obtain: $\mathcal{A}_{\varphi_{j_1}}(v) = v_{j_2, \dots, j_n}$ is a vertex of level $n - 1$.

If $I_v = I_{j_1, j_2, \dots, j_n}$ is of type (ii) and contains z_{j_1} or $z_{\zeta(j_1)}$ on its interior then, as in Proposition 5.3 case (1), $\varphi_{j_1}(I_v) \subset I_{j_2, \dots, j_n}$ and intersects all subintervals of level n maybe except one and thus $\mathcal{A}_{\varphi_{j_1}}(v) = v_{j_2, \dots, j_n}$ is a vertex of level $n - 1$.

In all cases, there is a generator φ_{j_1} so that $\mathcal{A}_{\varphi_{j_1}}(v)$ is a vertex of level $n - 1$. By iterating this argument, we obtain a finite sequence of generators: $\varphi_{j_1}, \varphi_{j_2}, \dots, \varphi_{j_m}$ with $m \leq n - 1$ so that: $\mathcal{A}_{\varphi_{j_m} \circ \dots \circ \varphi_{j_1}}(v) \in \mathcal{C}_{v_0}$. \square

Let us extend the map \mathcal{A}_{φ_j} , defined on the vertices of Γ_Φ , to a map on the graph. We denote by $e := (v, w)$ the edge connecting the vertices v and w in Γ_Φ .

Proposition 5.6. *The map \mathcal{A}_{φ_j} is well defined on the vertex set $V(\Gamma_\Phi)$. It extends to a well defined map on the set of edges as: $\mathcal{A}_{\varphi_j}(v, w) := (\mathcal{A}_{\varphi_j}(v), \mathcal{A}_{\varphi_j}(w))$ and is a bijective isometry, for all $j = 1, \dots, 2N$.*

Proof. Each map \mathcal{A}_{φ_j} is well defined on \mathcal{C}_{v_0} by Proposition 5.4. By Remark 6 and Proposition 5.5 the maps are well defined on $V(\Gamma_\Phi)$. It is enough to prove the result for the compact set \mathcal{C}_{v_0} .

Let (v, w) be an edge in \mathcal{C}_{v_0} , we can assume v is $v_{j_1, \gamma(j_1), \dots, \gamma^n(j_1)}$, (resp. $v = v_{j_1, \delta(j_1), \dots, \delta^n(j_1)}$), and $w = v_{j_1, \gamma(j_1), \dots, \gamma^{n+1}(j_1)}$, (resp. $w = v_{j_1, \delta(j_1), \dots, \delta^{n+1}(j_1)}$), for some $n \leq k(j_1) - 2$.

1) If $n < k(j_1) - 2$ then the two vertices are of type (i) and we compute the image of each vertex by Proposition 5.4, this gives the following cases:

(a) If $j_1 \neq j$, then by Proposition 5.4 case (1-a) and (1-c)-(i)), the image of each vertex gives:

$$(\mathcal{A}_{\varphi_j}(v), \mathcal{A}_{\varphi_j}(w)) \text{ is an edge in } \mathcal{C}_{v_{i(j)}}.$$

(b) If $j_1 = j$, then by Proposition 5.4, case (1-b), the image of each vertex gives:

$$(\mathcal{A}_{\varphi_j}(v), \mathcal{A}_{\varphi_j}(w)) \text{ is an edge of } \mathcal{C}_{v_{i(j)}} \cap \mathcal{C}_{v_0}.$$

2) If $n = k(j_1) - 2$ then v is of type (i) and w of type (ii).

(a) If $j_1 \notin \{\zeta^{\pm 1}(j), j\}$ then, by Proposition 5.4, (1-a) for v and case (2-b) for w we obtain:

$$(\mathcal{A}_{\varphi_j}(v), \mathcal{A}_{\varphi_j}(w)) \text{ is an edge of } \mathcal{C}_{v_{i(j)}}.$$

(b) If $j_1 = j$, then by Proposition 5.4, case (1-b) for v and case (2-a) for w we obtain:

$$(\mathcal{A}_{\varphi_j}(v), \mathcal{A}_{\varphi_j}(w)) \text{ is an edge of } \mathcal{C}_{v_{i(j)}} \cap \mathcal{C}_{v_0}.$$

(c) If $j_1 = \zeta^{\pm 1}(j)$, then by Proposition 5.4 case (1-c-ii) the image of v is of type (ii) and by Proposition 5.4, case (2-a) the image of w is of type (i). In these cases, we obtain:

$$(\mathcal{A}_{\varphi_j}(v), \mathcal{A}_{\varphi_j}(w)) \text{ is an edge of } \mathcal{C}_{v_{i(j)}} \cap \mathcal{C}_{v_0}.$$

For all the edges in \mathcal{C}_{v_0} , the map \mathcal{A}_{φ_j} is well defined by $\mathcal{A}_{\varphi_j}(v, w) := (\mathcal{A}_{\varphi_j}(v), \mathcal{A}_{\varphi_j}(w))$. In particular no two edges are mapped to the same one. Therefore each \mathcal{A}_{φ_j} is a bijective isometry, when restricted to \mathcal{C}_{v_0} , for the combinatorial metric on Γ_Φ . In addition, the map \mathcal{A}_{φ_j} increases or decreases by one the level of both vertices. The proof for the other compact sets \mathcal{C}_v is the same and thus the map is well defined on Γ_Φ . \square

Proposition 5.7. *For every vertex v of Γ_Φ , $\mathcal{A}_{\varphi_j}(\mathcal{C}_v) = \mathcal{C}_{\mathcal{A}_{\varphi_j}(v)}$ and \mathcal{A}_{φ_j} preserves the natural cyclic ordering of the edges given by Proposition 5.1.*

Proof. From the proof of Proposition 5.6 we obtain: $\mathcal{A}_{\varphi_j}(\mathcal{C}_{v_0}) = \mathcal{C}_{v_{\iota(j)}}$ and, by Definition 5 case (4) $\mathcal{A}_{\varphi_j}(v_0) = v_{\iota(j)}$. This is the statement for $v = v_0$. For the other vertices the proof is the same.

The cyclic ordering of Proposition 5.1 for the edges in Γ_Φ reflects the cyclic ordering of the intervals along the circle, it is given by the cyclic permutation ζ .

Let us consider (v_0, v_k) and $(v_0, v_{\zeta(k)})$ two consecutive edges around v_0 . By Proposition 5.6, the image under \mathcal{A}_{φ_j} depends on the value of k .

If $k \neq j$ then $\mathcal{A}_{\varphi_j}(v_0, v_k) = (\mathcal{A}_{\varphi_j}(v_0), \mathcal{A}_{\varphi_j}(v_k)) = (v_{\iota(j)}, v_{\iota(j),k})$, and $\mathcal{A}_{\varphi_j}(v_0, v_{\zeta(k)}) = (v_{\iota(j)}, v_{\iota(j),\zeta(k)})$, these two edges are consecutive at the vertex $v_{\iota(j)}$.

If $k = j$ then the image of the two edges are $\mathcal{A}_{\varphi_j}(v_0, v_j) = (v_{\iota(j)}, v_0)$ and $\mathcal{A}_{\varphi_j}(v_0, v_{\zeta(j)}) = (v_{\iota(j)}, v_{\iota(j),\zeta(j)})$, these two edges are consecutive around $v_{\iota(j)}$.

Hence \mathcal{A}_{φ_j} preserves the cyclic ordering of the edges around v_0 .

The proof for the other vertices is the same. From Proposition 5.4, Remark 6, Proposition 5.5 and since each generator φ_j is orientation preserving, the natural cyclic ordering at each vertex is preserved by the action. By composition, the same is true for each element in G_{X_Φ} . \square

5.5 G_{X_Φ} is a surface group

The length of an element $g \in G_{X_\Phi}$ is, as usual, the length of the shortest word expressing it in the generating set X_Φ .

Proposition 5.8. *Each element $g \in G_{X_\Phi}$ of length n admits a non trivial interval J_g so that $g|_{J_g}$ is affine with slope λ^n . In addition, if g has more than one expression of length n , then two expressions differ by some Cutting Point relations (CPj) of Theorem 1 for some $j \in \{1, \dots, 2N\}$.*

Proof. Let us consider the collection of integers given by (EC): $\{k(j) : j \in \{1, \dots, 2N\}\}$, with K_0 and K_Φ the minimal and maximal values of this set.

We start the proof for the elements $g \in G_{X_\Phi}$ of length $n \leq K_\Phi$, i.e., with an expression: $g = \varphi_{j_n} \circ \dots \circ \varphi_{j_1}$, satisfying, at least: $\varphi_{j_{i+1}} \neq \varphi_{\bar{j}_i}$, for $i = 1, \dots, n-1$.

(I) If $n = 2 < K_0$: by condition (SE), the map Φ_{j_1} can be followed by any Φ_k , with $k \neq \bar{j}_1$, for an iterate of length 2. This implies, from the definition of the generators in Definition 2, that for each $j_2 \neq \bar{j}_1$, the element $g = \varphi_{j_2} \circ \varphi_{j_1}$ admits $J_g := I_{j_1, j_2}$ as an interval where $g|_{J_g}$ is affine with slope λ^2 . This is the maximal possible slope for an element of length 2 in the group G_{X_Φ} . Since we are in a group, there cannot be more elements of length 2, starting with φ_{j_1} .

(II) For $2 < n < K_0$: we replace, in the above arguments, condition (SE) by the conditions (E-) and (E+) and we obtain that for all $n < K_0$ the element $g = \varphi_{j_n} \circ \dots \circ \varphi_{j_1}$ is of length n with the only restriction that $\varphi_{j_{i+1}} \neq \varphi_{\bar{j}_i}$, for all $i = 1, \dots, n-1$.

On the graph Γ_Φ , all the vertices v in the interior of the ball $\text{Ball}(v_0, K_0)$ are of type

(i) and, on the corresponding interval $I_v = I_{j_1, \dots, j_n}$, the map $g|_{I_{j_1, \dots, j_n}}$ is affine with slope λ^n , this is the maximal possible slope for an element of length n and we choose $J_g := I_{j_1, \dots, j_n}$.

(III) If $n = K_0$: let us consider an integer $j \in \{1, \dots, 2N\}$ so that $k(j) = K_0$. The element: $g = \varphi_{\delta^{k(j)-1}(j)} \circ \dots \circ \varphi_{\delta(j)} \circ \varphi_j$ has, at least, two expressions by Theorem 1. This element admits an interval V_j , given by Lemma 3.2, on which $g|_{V_j}$ is affine with slope λ^n . By definition of the generators in Theorem 1, the interval V_j might not be maximal with the property that the element is affine of slope λ^n . This interval is also denoted by $I_{\tilde{v}_j}$ in (33), and it is of type (ii) by Lemma 4.2. We choose in this case $J_g := I_{\tilde{v}_j}$.

By condition (7) in the proof of Lemma 3.2, the two expressions of g above can be followed by any φ_α for $\alpha \notin \{\overline{\gamma^{k(j)-1}(\zeta^{-1}(j))}, \overline{\delta^{k(j)-1}(j)}\}$.

The two expressions of g , given by the cutting point relation (CPj), have length n and have $2N - 2$ possible successors, i.e., elements of length $n + 1$ with the same beginning, by condition (7). The element g cannot have more than two expressions, by a counting argument as in (I), this also proves that in cases (I) and (II) (when $n < K_0$) the expression is unique. The elements g of length less than K_0 are covered by one of the above cases (II) or (III). In all the cases the interval J_g is chosen either as I_{j_1, \dots, j_n} , of type (i) or $I_{\tilde{v}_j}$, of type (ii). In addition, the element g has either exactly one expression of length n (case type (i)) or exactly two (case type (ii)).

(IV) If $n > K_0$: For an element $g = \varphi_{j_n} \circ \dots \circ \varphi_{j_1}$ of length $n > K_0$, the initial part of this expression of length K_0 , i.e., $g_1 = \varphi_{j_{K_0}} \circ \dots \circ \varphi_{j_1}$ is covered by the previous arguments. Thus there is an interval J_{g_1} so that $g_1|_{J_{g_1}}$ is affine with slope λ^{K_0} and two cases can occur: either J_{g_1} is of type (i) (resp. (ii- \mathcal{E})) or of type (ii- \mathcal{V}).

If J_{g_1} is of type (i) then, by the arguments in (II) above, g_1 has exactly $2N - 1$ possible continuations of length $K_0 + 1$ and $g_2 = \varphi_{j_{K_0+1}} \circ \varphi_{j_{K_0}} \circ \dots \circ \varphi_{j_1}$ is one of these continuations. The same argument applies to g_2 and we obtain an interval $J_{g_2} \subset J_{g_1}$.

If J_{g_1} is of type (ii- \mathcal{V}) then, by the argument in case (III), g_1 has exactly $2N - 2$ possible continuations of length $K_0 + 1$ and $g_2 = \varphi_{j_{K_0+1}} \circ \varphi_{j_{K_0}} \circ \dots \circ \varphi_{j_1}$ is one of these continuations. Again the same argument applies to g_2 . In all these cases we obtain an interval J_{g_2} so that $g_2|_{J_{g_2}}$ is affine with slope $\lambda^{K_\Phi+1}$. We complete this argument by induction.

At this point it remains to check the following:

Claim. If two expressions of length n define the same element in G_{X_Φ} then they differ by some cutting point relations

Proof of the claim: Notice that one property of the cutting point relations (CPj) has not been used yet:

- A cutting point relation, as a cyclic word in the generators, is such that for each consecutive letters $\dots \varphi_j \circ \varphi_k \dots$, the indices $(j, \iota(k))$ are adjacent, according to the permutation ζ , i.e., the intervals I_j and $I_{\iota(k)}$ are adjacent along S^1 .

- In addition, all the adjacent pairs $(j, \iota(k))$ appear in the set of all cutting point relations.

Suppose that two expressions of length n : $A = \varphi_{j_n} \circ \dots \circ \varphi_{j_1}$ and $B = \varphi_{k_n} \circ \dots \circ \varphi_{k_1}$

are equal in the group. If this equality represents a relation and is not a cutting point relation then, in the cyclic word AB^{-1} , some consecutive letters $\varphi_a \circ \varphi_b$ are so that $(a, \iota(b))$ are not adjacent. Let us assume, for instance, that the first indices j_1 and k_1 in A and B are not adjacent. This implies that the two intervals I_{j_1} and I_{k_1} are not adjacent along S^1 . Let $I_{j_1, \dots, j_n} \subset I_{j_1}$ (resp. $I_{k_1, \dots, k_n} \subset I_{k_1}$) be the interval as above on which the element A (resp. B) is affine of maximal slope λ^n . From the definition of the generators in Theorem 1, the maximal interval on which A is affine of maximal slope is larger than $I_{j_1, \dots, j_n} \subset I_{j_1}$ but intersects, at most, a small subinterval of an adjacent interval $I_{\zeta^{\pm 1}(j_1)}$. Since I_{j_1} and I_{k_1} are not adjacent then the maximal intervals on which A and B are affine of maximal slope λ^n are disjoint. Thus A and B cannot be equal, as homeomorphisms and thus in the group G_{X_Φ} .

If AB^{-1} is not a single relation and is not composed of cutting point relations. Then, as above, some non adjacent generators are consecutive in A or B . This non adjacent pair occurs at some position $r < n$ in A or B . In this case the intervals I_{j_1, \dots, j_r} and I_{k_1, \dots, k_r} might be adjacent but not at the next levels. Indeed, if the next generator in one of the composition (for instance in A) is not adjacent to the previous one, then the next interval $I_{j_1, \dots, j_{r+1}} \subset I_{j_1, \dots, j_r}$ is not an extreme interval in I_{j_1, \dots, j_r} . Therefore, as above, the two intervals $I_{j_1, \dots, j_n} \subset I_{j_1, \dots, j_{r+1}}$ and $I_{k_1, \dots, k_n} \subset I_{k_1, \dots, k_{r+1}}$ are not adjacent and the two compositions cannot be equal in the group.

This completes the proof of the Proposition. \square

By combining the various results above we obtain:

Lemma 5.2. *For all $g \in G_{X_\Phi}$, $\mathcal{A}_g : \Gamma_\Phi \rightarrow \Gamma_\Phi$ is a well defined morphism and the map $\mathcal{A} : G_{X_\Phi} \rightarrow \text{Aut}(\Gamma_\Phi)$ defined by $\mathcal{A}(g) := \mathcal{A}_g$ is a geometric action of G_{X_Φ} on Γ_Φ .*

Proof. Each map \mathcal{A}_{φ_j} is a bijective isometry on the compact sets \mathcal{C}_v by Proposition 5.6 and $\mathcal{A}_{\varphi_j}(\mathcal{C}_v) = \mathcal{C}_{\mathcal{A}_{\varphi_j}(v)}$ for any \mathcal{C}_v by Proposition 5.7. Therefore any composition: $\mathcal{A}_{\varphi_{j_n}} \circ \dots \circ \mathcal{A}_{\varphi_{j_1}}$ is an isometry. By definition, $\mathcal{A}_{\varphi_{j_n}} \circ \dots \circ \mathcal{A}_{\varphi_{j_1}} = \mathcal{A}_{\varphi_{j_n} \circ \dots \circ \varphi_{j_1}}$ we have to check this map does not depend on the expression of the group element $g = \varphi_{j_n} \circ \dots \circ \varphi_{j_1}$, i.e., the map is a well defined morphism.

By Proposition 5.8, the set of relations in G_{X_Φ} for the generating set X_Φ are:

- 1) The trivial relations: $\varphi_j \circ \varphi_{\iota(j)} = \text{Id}$, or
- 2) the cutting point relations (CPj) of Theorem 1, for $j = 1, \dots, 2N$.

We verify that the map \mathcal{A} respects these relations and, by Proposition 5.5, it is sufficient to check it on the compact set \mathcal{C}_{v_0} .

1) For the trivial relations: by Definition 5 we have $\mathcal{A}_{\varphi_j}(v_0) = v_{\iota(j)}$ and $\mathcal{A}_{\varphi_{\iota(j)}}(v_{\iota(j)}) = v_0$. For the other vertices $v \neq v_0$ in \mathcal{C}_{v_0} we have either $v = v_{j_1, \gamma(j_1), \dots, \gamma^n(j_1)}$ or $v = v_{j_1, \delta(j_1), \dots, \delta^n(j_1)}$, for $n \leq k(j_1) - 1$. The proof follows from the case by case study in the proofs of Proposition 5.4 and Proposition 5.6, we obtain: $\mathcal{A}_{\varphi_{\iota(j)}} \circ \mathcal{A}_{\varphi_j} = \text{Id}$ is the identity on \mathcal{C}_{v_0} and thus on Γ_Φ .

2) For the cutting point relations CPj : They are related to several properties of the map Φ and the space Γ_Φ . Each CPj is given by a cutting point of the map and to the equivalence relation of Definition 4 via the notion of vertices and intervals of type

(ii- \mathcal{V}) according to Lemma 4.2. The cutting point relations are also associated with the “loops”, based at any vertex v by Corollary 5.1. Recall that the compact sets \mathcal{C}_v are defined in Remark 5 as the union of all the loops, based at v . By Proposition 5.7, $\mathcal{A}_{\varphi_j}(\mathcal{C}_v) = \mathcal{C}_{\mathcal{A}_{\varphi_j}(v)}$ and \mathcal{A}_{φ_j} is a bijective isometry by Proposition 5.6. This implies, in particular, that each loop, based at v is mapped to a loop, based at $\mathcal{A}_{\varphi_j}(v)$, for all j and all v . Thus the map \mathcal{A} respects all the cutting point relations.

By the Propositions 5.5 and 5.7, the map \mathcal{A} is co-compact and thus \mathcal{A} is a well defined, co-compact isometric morphism.

It remains to check that \mathcal{A} is properly discontinuous. The graph Γ_Φ is locally compact so a compact set in Γ_Φ is contained in a ball of finite radius. If C_1 and C_2 are two compact sets in Γ_Φ we can assume that C_1 is contained in a ball of radius R centered at v_0 . By Proposition 5.5 there are elements $g \in G_{X_\Phi}$ so that $\mathcal{A}_g(C_2) \cap C_1 \neq \emptyset$. These elements have a length, with respect to the generating set X_Φ . This length is bounded, essentially at most twice the distance in Γ_Φ , between C_1 and C_2 , as in the proof of Proposition 5.5. Thus the set $\{g \in G_{X_\Phi} : \mathcal{A}_g(C_2) \cap C_1 \neq \emptyset\}$ is finite and the action is properly discontinuous. Therefore the map \mathcal{A} is a geometric action. \square

As a consequence of the above properties we obtain the following result:

Theorem 2. *Let Φ be a piecewise orientation preserving homeomorphism on the circle satisfying the conditions: (SE), (E+), (E-), (EC), (CS). Let $G_\Phi := G_{X_\Phi}$ be the sub-group of $\text{Homeo}^+(S^1)$ given in Definition 2 then:*

- (1) *The group G_Φ is discrete.*
- (2) *The group G_Φ is a Gromov-hyperbolic group with boundary S^1 .*
- (3) *The group G_Φ is a surface group, for an orientable surface.*

Proof. (1) The group acts geometrically on a discrete metric space by Lemma 5.2 so it is a discrete group. Recall that the graph Γ_Φ and the action of Definition 5 depends only on the map Φ .

(2) By Lemma 5.2 and Corollary 4.1 the group acts geometrically on a Gromov hyperbolic space with boundary S^1 . Therefore the group is Gromov hyperbolic with boundary S^1 by the Milnor-Swartz Lemma (see for instance §3 in [GdlH]).

(3) The group is a convergence group by a result of E. Freden [F]. Therefore the conditions of [G], [T] and [CJ] are satisfied and the group G_Φ is virtually a surface group.

In order to complete the proof of the Theorem it suffices to check:

Claim. The group G_Φ is torsion free.

Proof of the Claim. We already observed that each $g \in G_\Phi$ has bounded expansion and contraction factors by Proposition 5.8. This implies, in particular, that each element $g \in G_\Phi$ admits an interval I_v on which g is affine of slope λ^n , where n is the length of the element. This property implies that $g^m \neq id$ for all $g \in G_\Phi$ and all m .

By [Zi] a virtual surface group which is torsion free is a surface group, this completes the proof. \square

Theorem 2 admits several interesting consequences. The first one is direct from several statements in the paper.

Corollary 5.2. *If S is any compact, closed, orientable hyperbolic surface then the group $G = \pi_1(S)$, as a subgroup of $\text{Homeo}^+(S^1)$, admits a set of generators X and the circle S^1 admits a metric ρ so that each element $g \in G$ is piecewise affine, with respect to ρ , with slopes in the set $\{\lambda^k, k \in \mathbb{Z}\}$, where λ is an algebraic integer. In addition, every element of length n , with respect to X , admits an interval $U_g \subset S^1$ so that $g|_{U_g}$ is affine of slope λ^n .*

This statement is direct from Theorem 2, Lemma 2.1, Definition 2, Proposition 5.8 and Lemma 4.4. This is a surprising result at several levels, for instance within the world of hyperbolic groups. Indeed the Gromov boundary of a hyperbolic group admits many classes of metrics. The metric obtained here is very particular since it reflects the growth property of the group presentation (see Corollary 7.2 in §7). The presentation with piecewise affine elements is also surprising.

We will see other consequences in the Appendix in §7.

6 Orbit equivalence

In this section we complete the proof of the main theorem: the group and the map are orbit equivalent. Let us recall the definition of orbit equivalence, as given in [BS].

Definition 6. *A map $\Phi : S^1 \rightarrow S^1$ and a group G acting on S^1 are orbit equivalent if, except for a finite number of pairs of points $(x, y) \in S^1 \times S^1$:
 $\exists g \in G$ so that $y = g(x)$ if and only if $\exists (m, n) \in \mathbb{N} \times \mathbb{N}$ so that $\Phi^n(x) = \Phi^m(y)$.*

The following result is the first statement of the main Theorem.

Theorem 3. *If $\Phi : S^1 \rightarrow S^1$ is an orientation preserving piecewise homeomorphism satisfying the conditions (SE), (EC), (E \pm) and (CS), then the group G_{X_Φ} of Theorem 2 and the map $\tilde{\Phi}$, conjugated to Φ by (CS), are orbit equivalent.*

Proof. The proof uses the piecewise affine map $\tilde{\Phi}$ conjugate to Φ by condition (CS) via some $g \in \text{Homeo}(S^1)$. The orbit equivalence is preserved by conjugacy and the above statement is valid for the map Φ and the group obtained from G_Φ by conjugacy via the same g .

One direction of the orbit equivalence is direct from the definition of the map and the group.

- If $\tilde{\Phi}^n(x) = \tilde{\Phi}^m(y)$ then there are two sequences of integers $\{j_1, \dots, j_n\}$ and $\{l_1, \dots, l_m\}$ such that: $\varphi_{j_n} \circ \dots \circ \varphi_{j_1}(x) = \varphi_{l_m} \circ \dots \circ \varphi_{l_1}(y)$.

This implies that $y = g(x)$ for $g = (\varphi_{l_m} \circ \dots \circ \varphi_{l_1})^{-1} \circ \varphi_{j_n} \circ \dots \circ \varphi_{j_1} \in G_\Phi$.

- For the other direction we assume $y = g(x)$ and, since $X_\Phi = \{\varphi_1, \dots, \varphi_{2N}\}$ is generating G_{X_Φ} , it is sufficient to restrict to $g = \varphi_j \in X_\Phi$.

Recall that each generator $\varphi_j \in X_\Phi$ of Definition 1 and Definition 2 is piecewise affine with two special points, the breaking points $\{l_j^0, r_j^0\}$ that are periodic under $\tilde{\Phi}$. By construction, each interval of the partition satisfies:

$\tilde{I}_j = [\tilde{z}_j, \tilde{z}_{\zeta(j)}] \subset (l_j^0, r_j^0)$, and each generator satisfies:

$$\varphi_{\iota(j)}(l_{\iota(j)}^0) = r_j^0 \text{ and } \varphi_{\iota(j)}(r_{\iota(j)}^0) = l_j^0.$$

Let us assume x is not a breaking point for φ_j thus:

φ_j is either expanding or contracting at x , i.e., with slope λ or λ^{-1} .

In the second case $x = \varphi_j^{-1}(y)$ and φ_j^{-1} is expanding at y . By this symmetry, we assume that φ_j is expanding at x and thus $x \in (l_j^0, r_j^0)$. Two cases can arise:

$$(a) \ x \in \tilde{I}_j \quad \text{or} \quad (b) \ x \in (l_j^0, r_j^0) \setminus \tilde{I}_j.$$

In case (a): $\varphi_j(x) = \tilde{\Phi}(x)$, thus $y = \tilde{\Phi}(x)$ and (x, y) are in the same $\tilde{\Phi}$ -orbit.

In case (b): there is another symmetry:

$$x \in (l_j^0, \tilde{z}_j) \text{ or } x \in (\tilde{z}_{\zeta(j)}, r_j^0), \text{ we assume that } x \in (l_j^0, \tilde{z}_j).$$

By Corollary 3.1 and Definition 1, the breaking point satisfies: $l_j^0 \in (\varphi_{\iota(j)}(\tilde{z}_{\delta(j)}), \tilde{z}_j) = L_j$. We observe that the point $x \in L_j^{p,q}$ for some parameters (p, q) defined in §3.5. By Lemma 5.1, condition (c), we obtain :

$$l_j^0 \in L_j \subset I_{\zeta^{-1}(j), \gamma(\zeta^{-1}(j)), \dots, \gamma^{k(j)-2}(\zeta^{-1}(j))} \text{ and, by symmetry, } r_j^0 \in R_j.$$

The definition of these intervals implies:

$\forall u \in I_{\zeta^{-1}(j), \gamma(\zeta^{-1}(j)), \dots, \gamma^{k(j)-2}(\zeta^{-1}(j))} : \tilde{\Phi}^i(u) \in \tilde{I}_{\gamma^i(\zeta^{-1}(j))}, \forall i \in \{0, \dots, k(j) - 2\}$, and thus condition (b) implies:

$$\tilde{\Phi}^i(x) \in \tilde{I}_{\gamma^i(\zeta^{-1}(j))}, \forall i \in \{0, \dots, k(j) - 2\}.$$

With the same argument we obtain:

$y = \varphi_j(x) \in (r_{\iota(j)}^0, \varphi_j(\tilde{z}_j)) \subset R_{\iota(j)}$ with $R_{\iota(j)} \subset I_{\delta(j), \dots, \delta^{k(j)-1}(j)}$, and thus:

$\tilde{\Phi}^i(y) \in \tilde{I}_{\delta^{i+1}(j)}, \forall i \in \{0, \dots, k(j) - 2\}$. Hence, the $\tilde{\Phi}$ orbits of x and y satisfy:

$$\begin{aligned} \tilde{\Phi}^{k(j)-1}(y) &= \varphi_{\delta^{k(j)-1}(j)} \circ \dots \circ \varphi_{\delta(j)}(y), \text{ and} \\ \tilde{\Phi}^{k(j)-1}(x) &= \varphi_{\gamma^{k(j)-2}(\zeta^{-1}(j))} \circ \dots \circ \varphi_{\gamma(\zeta^{-1}(j))} \circ \varphi_{\zeta^{-1}(j)}(x). \end{aligned} \tag{35}$$

Recall that each cutting point z_j defines a relation (CP_j) in the group $G_{X_{\tilde{\Phi}}}$:

$$\varphi_{\delta^{k(j)-1}(j)} \circ \dots \circ \varphi_{\delta(j)} \circ \varphi_j = \varphi_{\gamma^{k(j)-1}(\zeta^{-1}(j))} \circ \dots \circ \varphi_{\gamma(\zeta^{-1}(j))} \circ \varphi_{\zeta^{-1}(j)}.$$

If the relation (CP_j) is applied to the point x we obtain:

$$\tilde{\Phi}^{k(j)-1}(\varphi_j(x)) = \varphi_{\gamma^{k(j)-1}(\zeta^{-1}(j))}[\tilde{\Phi}^{k(j)-1}(x)]. \tag{36}$$

Indeed, by replacing $y = \varphi_j(x)$ in the left hand side of the relation we obtain the first equality in (35) which is the left hand side of (36). The right hand side of (36) is obtained by replacing, in the right hand side of the relation, the second equality in (35). Let us denote:

$$j_1 := \gamma^{k(j)-1}(\zeta^{-1}(j)) \in \{1, \dots, 2N\}, \quad x_1 := \tilde{\Phi}^{k(j)-1}(x) \text{ and } y_1 := \varphi_{j_1}(x_1).$$

Observe that the index $j_1 = \alpha(j)$, as defined in Lemma 2.6.

The equality (36) implies that an alternative, similar to (a) or (b) above, applies again, more precisely:

$$(a_1) \ x_1 \in \tilde{I}_{j_1} \quad \text{or} \quad (b_1) \ x_1 \notin \tilde{I}_{j_1}.$$

In case (a_1) : the equality (36) gives:

$$\tilde{\Phi}^{k(j)-1}(y) = \tilde{\Phi}[\tilde{\Phi}^{k(j)-1}(x)] = \tilde{\Phi}^{k(j)}(x),$$

and the orbit equivalence is proved in this case.

In case (b_1) : By the observation above $x \in L_j^{p,q}$ then, by Lemma 3.4 and the proof of Lemma 3.5, we obtain that $x_1 \in L_{j_1}^{p-1, q-1}$ and, in particular $x_1 \in (l_{j_1}^0, \tilde{z}_{j_1})$.

This alternative (b_1) is thus exactly the same at the point x_1 than (b) was at the point x . This implies, in particular that: $x_1 \in \tilde{I}_{\zeta^{-1}(j_1)}$ and, more precisely:

$$x_1 \in I_{\zeta^{-1}(j_1), \gamma(\zeta^{-1}(j_1)), \dots, \gamma^{k(j_1)-2}(\zeta^{-1}(j_1))} \text{ and } y_1 = \varphi_{j_1}(x_1) \in I_{\delta(j_1), \dots, \delta^{k(j_1)-1}},$$

by the same arguments as for the points x and y .

Therefore we obtain:

- a sequence of integers: $\{j = j_0, j_1, \dots, j_n, \dots\}$ where each $j_m \in \{1, \dots, 2N\}$,
- a sequence of points: $x_n := \tilde{\Phi}^{k(j_{n-1})-1}(x_{n-1})$ and $y_n := \varphi_{j_n}(x_n)$, with the following alternative:

$$(a_n) \quad x_n \in \tilde{I}_{j_n} \quad \text{or} \quad (b_n) \quad x_n \notin \tilde{I}_{j_n}.$$

Lemma 6.1. *With the above notations, if $x \in (l_j^0, \tilde{z}_j)$ and $y = \varphi_j(x)$, then there is an integer $n_0 \geq 1$ and $K(n_0) \geq k(j) - 1$ so that $x_{n_0} \in \tilde{I}_{j_{n_0}}$ and $\tilde{\Phi}^{K(n_0)}(y) = \tilde{\Phi}^{K(n_0)+1}(x)$.*

Proof. Recall that S^1 has a well defined metric $|\cdot|$ for which $\tilde{\Phi}$ is affine. Since $x \in (l_j^0, \tilde{z}_j)$, we define $\rho_{x,j} = |(l_j^0, x)| > 0$. By Corollary 3.1, the breaking point l_j^0 is an expanding periodic point of period $K(r_\alpha(j)) \geq k(j) - 1$.

- If the alternative (a_1) is satisfied then $n_0 = 1$ and $K(n_0) = k(j) - 1$, i.e.,

$\tilde{\Phi}^{k(j)-1}(y) = \tilde{\Phi}^{k(j)}(x)$ and the points x, y are in the same $\tilde{\Phi}$ -orbit.

- If (b_1) is satisfied then $x_1 = \tilde{\Phi}^{k(j)-1}(x) \in (l_{j_1}^0, \tilde{z}_{j_1})$. The breaking point $l_{j_1}^0$ belongs to the same $\tilde{\Phi}$ -orbit as l_j^0 and we obtain: $\rho_{x_1, j_1} = |(l_{j_1}^0, x_1)| = \lambda^{k(j)-1} \cdot \rho_{x,j}$, since $\tilde{\Phi}$ is affine.

Let $M = \max_{i=1, \dots, 2N} |(l_i^0, \tilde{z}_i)|$, since the periodic point $l_{j_1}^0$ is expanding and $x_n = \tilde{\Phi}^{k(j_{n-1})-1}(x_{n-1})$ then there is $n_1 \geq 1$ so that : $\rho_{x_{n_1}, j_{n_1}} = \lambda^{K(n_1)} \cdot \rho_{x,j} > M$, where $K(n) = \sum_{i=0}^n (k(j_i) - 1)$. Therefore there is $n_0 \leq n_1$ so that $x_{n_0} \in \tilde{I}_{j_{n_0}}$. This is the first statement of the Lemma and thus the alternative (a_{n_0}) is satisfied which implies : $\tilde{\Phi}^{K(n_0)}(y) = \tilde{\Phi}^{K(n_0)+1}(x)$, thus x and y belong to the same $\tilde{\Phi}$ -orbit. □

This completes the proof of Theorem 3 and of the main Theorem. □

7 Appendix

In this Appendix we give a direct proof of:

Theorem. *The group G_Φ of Definition 2 is a surface group.*

This result has been obtained in Theorem 2 of section 5, by using the very strong geometrisation theorem of Tukia [T], Gabai [G] and Casson-Jungreis [CJ]. The proofs of this geometrisation theorem, in one way or another, rely on extending the group action on the circle to an action on a disc. Our approach is not an exception to this general strategy. Here we already have an important ingredient: a geometric action given by Definition 5 on the hyperbolic metric graph Γ_Φ of Definition 4. We need to prove that Γ_Φ can be embedded in a plane and the action can be extended to a planar action.

We define a 2-complex $\Gamma_\Phi^{(2)}$, in analogy with the Cayley 2-complex:

- For each closed path in Γ_Φ , associated to a cutting point relation (CPj) by Corollary 5.1 (see Figure 10), we define a two disc Δ_{z_j} whose boundary is a polygon with $2 \cdot k(j)$ sides, where $k(j)$ is given by condition (EC) at z_j .
- We glue “isometrically” a disc Δ_{z_j} along a closed path in Γ_Φ , as above, associated to (CPj). Isometrically means that each side of Δ_{z_j} has length one and is glued along the corresponding edge in Γ_Φ , also of length one. We denote $\Gamma_\Phi^{(2)}$ the 2-complex obtained by gluing all possible such discs. The graph Γ_Φ is naturally the 1-skeleton of $\Gamma_\Phi^{(2)}$.

Lemma 7.1. *The 2-complex $\Gamma_\Phi^{(2)}$ is homeomorphic to \mathbb{R}^2 .*

The action \mathcal{A}_g , $g \in G_\Phi$ extends to a free, co-compact, properly discontinuous action $\widetilde{\mathcal{A}}_g$ of G_Φ on $\Gamma_\Phi^{(2)}$.

Proof. By the Propositions 5.6 and 5.7, the action \mathcal{A}_g maps the link at a vertex $v \in V(\Gamma_\Phi)$ to the link at $w = \mathcal{A}_g(v)$ and this action preserves the cyclic ordering of Proposition 5.1. This implies, in particular, that adjacent edges at v are mapped to adjacent edges at w . Recall that adjacent edges define a relation (CPj) by Corollary 5.1 for some $j \in \{1, \dots, 2N\}$. Therefore a closed path Π^0 , based at v in Γ_Φ associated to a relation (CPj) is mapped to a closed path $\widetilde{\Pi}^0$, based at w , associated to (CPj). We extend the action \mathcal{A}_g on Γ_Φ to an action $\widetilde{\mathcal{A}}_g$ on $\Gamma_\Phi^{(2)}$ by declaring that if $\mathcal{A}_g(\Pi^0) = \widetilde{\Pi}^0$ then the disc Δ_{z_j} based at v is mapped by $\widetilde{\mathcal{A}}_g$ to the disc $\widetilde{\Delta}_{z_j}$ based at w .

The set of 2-cells Δ_{z_j} for all $j \in \{1, \dots, 2N\}$, glued along each pair of adjacent edges at v in $\Gamma_\Phi^{(2)}$, defines a neighborhood of v in $\Gamma_\Phi^{(2)}$. This neighborhood is a 2-disc. Indeed, by the natural cyclic ordering of the edges at v , exactly two 2-cells are glued along an edge. Observe that the boundary of this neighborhood is a subset of the graph Γ_Φ which is precisely the boundary of the compact set \mathcal{C}_v of Remark 5. This 2-disc is embedded in \mathbb{R}^2 and this property is true for each vertex. Thus $\Gamma_\Phi^{(2)}$ is homeomorphic to \mathbb{R}^2 , since each point has a neighborhood homeomorphic to a 2-disc and $\Gamma_\Phi^{(2)}$ is contractible since any basic loop in Γ_Φ bounds a unique disc in $\Gamma_\Phi^{(2)}$.

The extended action $\widetilde{\mathcal{A}}_g$ defined above is co-compact, free, and properly discontinuous, exactly as the action \mathcal{A}_g is on Γ_Φ . \square

Proof of the Theorem. The quotient of $\Gamma_\Phi^{(2)}$ by the action $\widetilde{\mathcal{A}}_g$ is a compact surface since $\Gamma_\Phi^{(2)}$ is homeomorphic to \mathbb{R}^2 and the action is co-compact and free. \square

As a consequence we obtain:

Corollary 7.1. *The group G_{X_Φ} of Definition 2 admits a presentation P where the generating set is X_Φ and the set of relations are the cutting point relations (CPj). Then the Cayley 2-complex of this presentation is homeomorphic to \mathbb{R}^2 .*

Proof. The group is defined as generated by X_Φ in Definition 2 and, from Proposition 5.8, the set of relations is the set (CPj). From the proof of Lemma 7.1 the 2-complex $\Gamma_\Phi^{(2)}$ is identified with the Cayley 2-complex of the presentation P . Indeed, each vertex

in Γ_Φ is associated to a group element, each edge is associated to a generator and each 2-disc in $\Gamma_\Phi^{(2)}$ is bounded by a loop associated to a relation. \square

A presentation of a surface group $G = \pi_1(S)$ is called *geometric* in [L] (see also [AJLM2]) if the Cayley 2-complex is planar. From the main Theorem 2 and Corollary 7.1, this is the case for the group G_Φ and the presentation P . Recall that the volume entropy $h_{vol}(G, P)$ of a group G with presentation P is the logarithm of the exponential growth rate of the number of elements of length n with respect to the presentation P (see [GH]). As another consequence of this work we obtain:

Corollary 7.2. *If $\Phi : S^1 \rightarrow S^1$ is an orientation preserving piecewise homeomorphism satisfying the conditions (SE), (EC), (E+), (E-) and (CS) of constant $\lambda > 1$ then λ is an algebraic integer and $\log(\lambda) = h_{vol}(G_\Phi, P)$, for the group G_Φ and the presentation P given by Theorem 1. The quantity $\log(\lambda)$ is also the topological entropy of the map Φ .*

This result is an immediate consequence of Theorem 2 together with the main result in [AJLM2] since the presentation P is geometric by Corollary 7.1. The fact that $\lambda > 1$ is an algebraic integer has already been obtained directly before, in Lemma 4.4, in this Lemma it was also noticed that $\log(\lambda)$ is the topological entropy of the map Φ .

The two Corollaries 7.2 and 5.2 together give the second Theorem of the introduction.

References

- [AKU] A. Abrams, S. Katok, I. Ugarcovici. Flexibility of measure-theoretic entropy of boundary maps associated to Fuchsian groups. Erg. Theo. Dyn. Syst. 42, (2022), 389-401.
- [AKM] R. Adler, A. G. Konheim, M. H. McAndrew. Topological entropy. Trans. Amer. Math. Soc. 114, 309-319, (1965).
- [AF] R. Adler, L. Flatto. Geodesic flows, interval maps, and symbolic dynamics. Bull. Amer. Math. Soc. 25 (1991) No. 2, 229-334.
- [AJLM] L. Alsedà, D. Juher, J. Los, F. Manosas, Volume entropy for minimal presentations of surface groups in all ranks. Geom. Dedicata 180: 293-322 (2016).
- [AJLM2] L. Alsedà, D. Juher, J. Los, F. Manosas, Entropy stability and Milnor-Thurston invariants for Bowen-Series-like maps. Preprint 2023.
- [ALM] L. Alsedà, J. Llibre, M. Misiurewicz. Combinatorial dynamics and entropy in dimension one, vol5 of Advanced Series in Non Linear dynamics. World Scientific Publishing Co., Inc., River Edge, NJ, second edition, 2000.
- [B] R. Bowen, Hausdorff dimension of quasi-circles. Publications Mathématiques de L'I.H.É.S. Tome 50, 11-26 (1979)

- [BS] R. Bowen, C. Series, Markov maps associated with fuchsian groups. *Publications Mathématiques de L'I.H.É.S.* Tome **50**, 153-170 (1979)
- [CJ] A. Casson and D. Jungreis, Convergence groups and Seifert fibered 3-manifolds. *Invent. Math.* 118, no. 3, 441-456 (1994)
- [F] E. Freden, Negatively curved groups have the convergence property I. *Ann. Aca. Sci. Fen. Series A.* 20, 333-348 (1995)
- [G] D. Gabai, Convergence groups are Fuchsian groups. *Ann. of Math. (2)* 136, no. 3, 447-510 (1992)
- [Gr] M. Gromov, *Hyperbolic Groups, Essays in group theory.* Math. Sci. Res. Inst. Publ., 8, 75-263, Springer, New York (1987)
- [GdlH] E. Ghys and P. de la Harpe, *Sur les groupes hyperboliques d'après Mikhael Gromov (Bern, 1988)*, 1-25. *Progr. Math.*, 83, Birkhäuser Boston, Boston, MA (1990)
- [GM] F. W. Gehring and G. J. Martin, Discrete convergence groups. *Complex analysis, I (College Park, Md., 1985-86)*, 158-167, *Lecture Notes in Math.*, 1275, Springer, Berlin (1987)
- [GH] R. Grigorchuk, P. De la Harpe. On problems related to growth, entropy, and spectrum in group theory. *J. Dyna. Control Systems*, 3 (1), 51-89, (1997).
- [H18] P. Haïssinsky, Some topological characterization of rational maps and Kleinian groups. *Dynamical Systems Banach Center Publication*, Vol 115 (2018)
- [HP] P. Haïssinsky and K. Pilgrim, Coarse expanding conformal dynamics. *Astérisque*, 325 (2009)
- [L] J. Los, Volume entropy for surface groups via Bowen-Series-like maps. *Journal of Topology* **7**, 120-154 (2014)
- [N] J. Nielsen, *Abbildungsklassen endlicher ordnung*, *Acta. Math.* 75 (1942), 23-115.
- [Sta] J. R. Stallings, Topology of finite graphs. *Invent. Math.* 71, pp 551-565 (1983)
- [T] P. Tukia, Homeomorphic conjugates of Fuchsian groups. *Journal Für die reine angew. Math.* **391**, 1-54 (1988)
Annals of Mathematics, 115 (1), 201-242, (1982)
- [Zi] H. Zieschang, On extension of fundamental group of surfaces and related groups. *Bull of the A.M.S.*, 77, 6, pp 1116-1119 (1971)

Jérôme Los
I2M (Institut Mathématique de Marseille), Aix-Marseille Université,
CNRS UMR 7373, 3 Place Victor Hugo, 13003 Marseille, France
jerome.los@univ-amu.fr

Natalia A. Viana Bedoya
Departamento de Matemática, Universidade Federal de São Carlos
Rod. Washington Luis, Km. 235. C.P 676 - 13565-905 São Carlos, SP - Brasil
nvbedoya@ufscar.br