

n -KNOTS IN $S^n \times S^2$ AND CONTRACTIBLE $(n+3)$ -MANIFOLDS

GEUNYOUNG KIM

ABSTRACT. In 1961, Mazur [5] constructed a contractible, compact, smooth 4-manifold with boundary which is not homeomorphic to the standard 4-ball, using a 0-handle, a 1-handle and a 2-handle. In this paper, for any integer $n \geq 2$, we construct a contractible, compact, smooth $(n+3)$ -manifold with boundary which is not homeomorphic to the standard $(n+3)$ -ball, using a 0-handle, an n -handle and an $(n+1)$ -handle. The key step is the construction of an interesting knotted n -sphere in $S^n \times S^2$ generalizing the Mazur pattern.

1. INTRODUCTION

In this paper, we prove the following two main theorems.

Theorem 1.1. *For any integer $n \geq 2$, there exists a contractible, compact, smooth $(n+3)$ -manifold with boundary admitting a handle decomposition with a 0-handle, an n -handle and an $(n+1)$ -handle which is not homeomorphic to the standard $(n+3)$ -ball B^{n+3} .*

In order to prove Theorem 1.1, given $n \geq 2$, we first construct an interesting n -knot K^n in $S^n \times S^2$ (Definition 3.1) which is homotopic but not isotopic to $S^n \times \{y_0\}$, where $y_0 \in S^2$ (Proposition 3.2 and Corollary 3.7). Secondly we construct a contractible, compact, smooth $(n+3)$ -manifold X_{K^n} (Definition 3.8) from $S^n \times B^3$ (0-handle \cup n -handle) by attaching a single $(n+3)$ -dimensional $(n+1)$ -handle along the n -knot K^n in $S^n \times S^2 = \partial(S^n \times B^3)$. Finally we prove that X_{K^n} is contractible by showing that $X_{K^n} \times B^1$ is diffeomorphic to B^{n+4} (Proposition 3.10) and prove that X_{K^n} is not homeomorphic to B^{n+3} by showing that ∂X_{K^n} is a non-simply connected homology $(n+2)$ -sphere (Corollary 3.13).

Theorem 1.2. *For any integer $n \geq 2$, there exists an involution of S^{n+3} whose fixed point set is a non-simply connected homology $(n+2)$ -sphere.*

In order to prove Theorem 1.2, given $n \geq 2$, we first show that the double $DX_{K^n} = X_{K^n} \cup_{id} \overline{X_{K^n}}$ of X_{K^n} is diffeomorphic to S^{n+3} , where $id : \partial X_{K^n} \rightarrow \partial X_{K^n}$ is an identity map (Lemma 3.16). We then define an involution $\phi : S^{n+3} \rightarrow S^{n+3}$ switching copies of X_{K^n} and fixing the non-simply connected homology $(n+2)$ -sphere ∂X_{K^n} .

Remark 1.3. Here we discuss the relationship between our results and earlier results.

- (1) In [5] Mazur proved Theorem 1.1 and Theorem 1.2 when $n = 1$. We can consider Mazur's 1-knot in $S^1 \times S^2$ as the result of surgery of three parallel copies of $S^1 \times \{y_0\} \subset S^1 \times S^2$ along two 2-dimensional 1-handles whose cores are trivial and with some twistings (See J_1 for Mazur's 1-knot and J_2 for another interesting 1-knot in Remark 2.6). However, we cannot generalize

Mazur's 1-knot to an n -knot in $S^n \times S^2$ obtained from three parallel copies of $S^n \times \{y_0\} \subset S^n \times S^2$ by surgery along two $(n+1)$ -dimensional 1-handles whose cores are trivial when $n \geq 2$ because the resulting n -knot is always isotopic to $S^n \times \{y_0\} \subset S^n \times S^2$. In Definition 3.1, we resolve this issue and find interesting $(n+1)$ -dimensional 1-handles whose cores are non-trivial but very simple so that we construct the n -knot K^n in $S^n \times S^2$.

- (2) In [6] Sato proved Theorem 1.1 and Theorem 1.2 when $n = 2$. Sato constructed a 2-knot F in $S^2 \times S^2$ which is homotopic but not isotopic to $S^2 \times \{y_0\}$ by surgery along a simple closed curve in the complement of the 5-twist spun trefoil in S^4 in [7]. However, Sato's construction is not very explicit so it is difficult to visualize the 2-knot F . In particular, we do not know the geometric intersection number $|F \cap \{x_0\} \times S^2|$ directly and it is hard to see why $F \times \{0\} \subset S^2 \times S^2 \times B^1$ is isotopic to $S^2 \times \{y_0\} \times \{0\} \subset S^2 \times S^2 \times B^1$. Our construction of K^n resolves these issues.
- (3) In [4], Kervaire proved the existence of contractible, compact, smooth $(n+3)$ -manifolds which are not homeomorphic to B^{n+3} , where $n \geq 2$. However, the proof does not tell us much about the handle decomposition or give us a proof of Theorem 1.2.

Remark 1.4. Here we note some nice properties of our n -knot K^n in $S^n \times S^2$, and highlight some ways in which our construction is an improvement on the techniques used in the results described above.

- (1) The construction of K^n is very explicit and visualized for every $n \geq 2$ (Definition 3.1). We may construct infinitely many interesting n -knots in $S^n \times S^2$ by modifying the cores of $(n+1)$ -dimensional 1-handles. For example, the cores used to construct K^n come from the case when $m_1 = 1, m_2 = -1$, and $m_3 = \dots = m_{2i} = 0$ in the left-hand side of Figure 3. We may then construct infinitely many contractible, compact, smooth $(n+3)$ -manifolds which are not homeomorphic to B^{n+3} .
- (2) K^n is the simplest example of this construction in the sense that the geometric intersection number $|K^n \cap (\{x_0\} \times S^2)| = 3$ and the algebraic intersection number $K^n \cdot (\{x_0\} \times S^2) = 1$, where $x_0 \in S^n$ (Proposition 3.2). Furthermore it is impossible to have $|F \cap \{x_0\} \times S^2| < 3$ for any n -knot F isotopic to K^n (Corollary 3.15).
- (3) A homotopy between $K^n \subset S^n \times S^2$ and $S^n \times \{y_0\} \subset S^n \times S^2$ is visualized (Proposition 3.2).
- (4) An isotopy between $K^n \times \{0\} \subset S^n \times S^2 \times B^1$ and $S^n \times \{y_0\} \times \{0\} \subset S^n \times S^2 \times B^1$ is visualized (Proposition 3.3). This isotopy is essential to proving that $X_{K^n} \times B^1$ is diffeomorphic to B^{n+4} (Proposition 3.10).
- (5) The construction of K^n gives an explicit handle decomposition of $S^n \times S^2 \setminus \text{int}(\nu(K^n))$ (Remark 3.5) so we can easily find the fundamental group $\pi_1(S^n \times S^2 \setminus \text{int}(\nu(K^n)))$ (Proposition 3.6).
- (6) The construction of K^n gives an explicit handle decomposition of the non-simply connected homology $(n+2)$ -sphere ∂X_{K^n} (Remark 3.11) so we can easily show that $\pi_1(X_{K^n}) \cong \pi_1(S^n \times S^2 \setminus \text{int}(\nu(K^n)))$ (Proposition 3.12).

Organization. In section 2 we set up some standard notation and interpret Mazur's 1-knot in $S^1 \times S^2$ from the point of view of surgery as motivation for our construction of the n -knot K^n in $S^n \times S^2$. In section 3 we construct our n -knot K^n in

$S^n \times S^2$ and the contractible $(n + 3)$ -manifold X_{K^n} , and then prove Theorem 1.1 and Theorem 1.2.

Conventions. In this paper, we work in the smooth category. \mathbb{R}^n, S^n, B^n and $\{0\} \subset B^n \subset \mathbb{R}^n$ stand for the real n -space, the standard n -sphere, the standard n -ball and the origin of B^n or \mathbb{R}^n .

Acknowledgements. This work was supported in part by National Science Foundation grant DMS-2005554 “Smooth 4-Manifolds: 2-, 3-, 5- and 6-Dimensional Perspectives”.

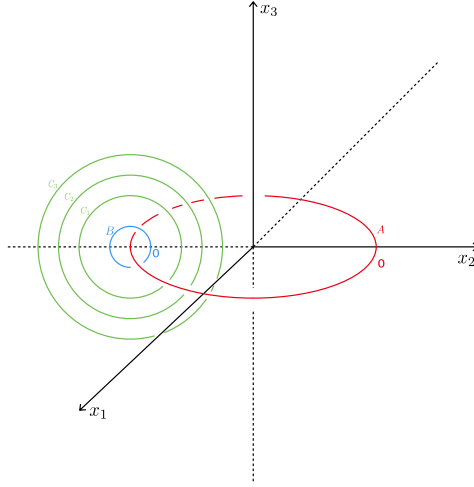

FIGURE 1. Standard handle decomposition of $S^n \times S^2$ and three parallel copies of $S^n \times \{y_0\}$. A is the attaching sphere of the 2-handle with 0-framing, B is the attaching sphere of n -handle with 0-framing, and C_t is the equator of $S^n \times \{y_t\}$.

2. PRELIMINARIES

We begin by explicitly describing the standard handle decomposition of $S^n \times S^2$ and the associated attaching maps.

Remark 2.1 (Standard handle decomposition of $S^n \times S^2$). Decompose $S^n = B_-^n \cup B_+^n$ into two n -dimensional balls and $S^2 = B_-^2 \cup B_+^2$ into two 2-dimensional balls. Then $S^n \times S^2 = (B_-^n \cup B_+^n) \times (B_-^2 \cup B_+^2) = (B_-^n \times B_-^2) \cup (B_-^n \times B_+^2) \cup (B_+^n \times B_-^2) \cup (B_+^n \times B_+^2)$ has a handle decomposition with a single 0-handle, a single 2-handle, a single n -handle, and a single $(n + 2)$ -handle. We can easily see the attaching sphere of the 2-handle (trivial 1-knot) and the attaching sphere of the n -handle (trivial $(n - 1)$ -knot) on the boundary of the 0-handle i.e., $(\{0\} \times S^1) \cup (S^{n-1} \times \{0\}) \subset \partial(B_-^n \times B_-^2) \cong \partial B^{n+2} = S^{n+1}$. For future reference, we parameterize the trivial 1-knot and the trivial $(n - 1)$ -knot in $\mathbb{R}^{n+1} \subset \mathbb{R}^{n+1} \cup \{\infty\} \cong S^{n+1}$. The trivial 1-knot $\{0\} \times S^1$ corresponds to $A := \{(x_1, \dots, x_{n+1}) \in \mathbb{R}^{n+1} \mid x_1^2 + x_2^2 = 1, x_i = 0 \text{ for } i > 2\}$ and the trivial $(n - 1)$ -knot $S^{n-1} \times \{0\}$ corresponds to $B := \{(x_1, \dots, x_{n+1}) \in \mathbb{R}^{n+1} \mid x_1 = 0, (x_2 + 1)^2 + \sum_{i=3}^{n+1} x_i^2 = (\frac{1}{5})^2\}$. An $(\mathbb{R}^3 \times \{0\})$ -slice $(A \cup B) \cap (\mathbb{R}^3 \times \{0\})$

of $A \cup B$ is the Hopf link in Figure 1, where $\mathbb{R}^3 \times \{0\} \subset \mathbb{R}^3 \times \mathbb{R}^{n-2} \cong \mathbb{R}^{n+1}$. Again, $S^n \times S^2$ can be recovered from B^{n+2} by attaching a single 2-handle to $S^{n+1} \cong \mathbb{R}^{n+1} \cup \{\infty\}$ along A with 0-framing (product framing), a single n -handle with 0-framing (product framing), and a single $(n+2)$ -handle (we don't draw the $(n+2)$ -handle). The 0 in Figure 1 is shorthand for the obvious product framing. For example, Figure 1 is a Kirby diagram of $S^2 \times S^2$ when $n = 2$. A parallel copy $C_t := \{(x_1, \dots, x_{n+1}) \in \mathbb{R}^{n+1} \mid x_1 = 0, (x_2 + 1)^2 + \sum_{i=3}^{n+1} x_i^2 = (\frac{t}{4})^2\}$ of B bounds a properly embedded trivial n -ball D_t^- in B^{n+2} (C_t bounds a trivial n -ball in S^{n+1} and push the interior of the n -ball into the interior of B^{n+2}) and a copy of the core of the n -handle D_t^+ so $C_t = D_t^- \cap D_t^+$ represents the equator of $S^n \times \{y_t\}$ and $D_t := D_t^- \cup D_t^+$ represents $S^n \times \{y_t\}$. From now on, we use red, blue and green for A, B , and C_t , respectively.

Next we establish terminology for handles embedded in an ambient manifold and attached to a submanifold.

Definition 2.2. Let $n \geq 1$. Let $N^n \subset M^{n+2}$ be a n -dimensional submanifold of $(n+2)$ -dimensional manifold M . An $(n+1)$ -dimensional submanifold $h \subset M$ is called a *1-handle attached to N* if there exists an embedding $e : B^1 \times B^n \hookrightarrow M$ such that $h = e(B^1 \times B^n)$ and $h \cap N = e(\partial B^1 \times B^n)$. We call $C_h := e(B^1 \times \{0\})$ the *core* of h and $N_h := (N \setminus \text{int}(e(\partial B^1 \times B^n))) \cup e(B^1 \times \partial B^n) \subset M$ the *result of surgery* of N along h in M . Here, N_h is assumed to be oriented so that the orientation of $N \setminus \text{int}(e(\partial B^1 \times B^n))$ extends to the orientation of N_h .

Boyle proved the following when $n = 2$ and $M = S^4$. See [1] for more details.

Proposition 2.3. Let $n \geq 2$. Let h and h' be 1-handles attached to $N^n \subset M^{n+2}$ with the same core C . Then there exists an ambient isotopy of M taking h to h' fixing N setwise. Furthermore, the results of surgery N_h and $N_{h'}$ are isotopic.

Proof. Following [1], the difference between two such 1-handles with the same core gives a map $\theta : B^1 \rightarrow G_{n+1,n}$; the Grassmannian manifold of oriented n -planes in \mathbb{R}^{n+1} , with $\theta(-1) = \theta(1)$. Since $n \geq 2$ and $G_{n+1,n} \cong S^n$, we have $\pi_1(G_{n+1,n}) = 0$, so there exists an isotopy of M taking h to h' fixing N setwise. From this we see that the results of surgery N_h and $N_{h'}$ are isotopic. \square

Corollary 2.4. Let $n \geq 2$. Let h and h' be 1-handles attached to $N^n \subset M^{n+2}$ with cores C_h and $C_{h'}$, respectively. If C_h and $C_{h'}$ are isotopic through arcs such that the boundary of each arc is in N and the interior of each arc doesn't intersect with N , then there exists an ambient isotopy of M taking h to h' fixing N setwise. In particular, the results of surgery N_h and $N_{h'}$ are isotopic.

Proof. By the tubular neighborhood theorem and Proposition 2.3, the isotopy taking C_h to $C_{h'}$ through arcs such that the boundary of each arc is in N and the interior of each arc doesn't intersect with N can extend to an ambient isotopy of M taking h to h' fixing N setwise. From this we see that the results of surgery N_h and $N_{h'}$ are isotopic. \square

Remark 2.5.

- (1) Corollary 2.4 is not true when $n = 1$ because $\pi_1(G_{n+1,n}) \cong \mathbb{Z}$. Therefore different framings of a core may give non-isotopic 1-handles; see Remark 2.6.(4).

- (2) When $n \geq 2$, a homotopy between arcs implies an isotopy between arcs and there is a unique framing of a core, so $(n + 1)$ -dimensional 1-handles are less complicated than 2-dimensional 1-handles.

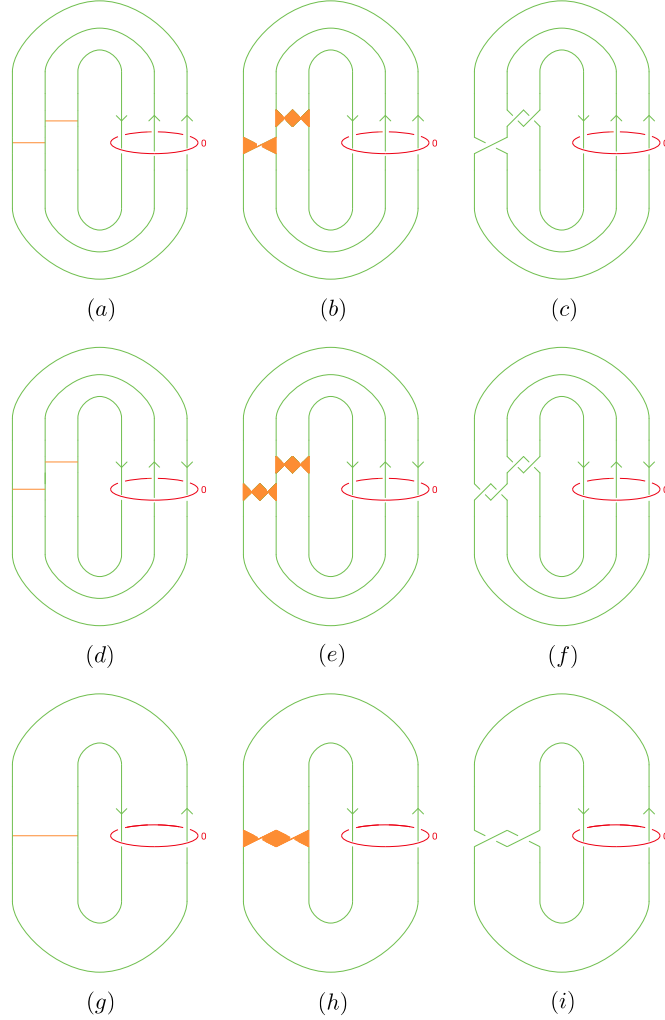

FIGURE 2. First column (a), (d), (g): parallel copies of $S^1 \times \{y_0\}$ in $S^1 \times S^2$ with trivial cores of 2-dimensional 1-handles. Second column (b), (e), (h): 2-dimensional 1-handles determined by the cores and framings (or twistings). Third column (c), (f), (i): results of surgery J_1, J_2 , and J_3 . First row: a process of obtaining J_1 by surgery. Second row: a process of obtaining J_2 by surgery. Third row: a process of obtaining J_3 by surgery.

We now analyze Mazur's knot J_1 and some other interesting knots J_2 and J_3 in $S^1 \times S^2$ from the point of view of surgery along 1-handles. Figure 2 illustrates these examples. In this figure we consider $S^1 \times S^2$ as the boundary of $S^2 \times B^2$, where

$S^2 \times B^2$ is obtained from B^4 by attaching a 2-handle along the unknot with the 0-framing (product framing). Observe the following features of the knots constructed in Figure 2:

Remark 2.6.

- (1) J_1 is homotopic but not isotopic to $S^1 \times \{y_0\}$ in $S^1 \times S^2$; see Figure 2.(c).
- (2) J_2 is homotopic but not isotopic to $S^1 \times \{y_0\}$ in $S^1 \times S^2$; see Figure 2.(f).
- (3) J_3 is homotopic but not isotopic to the unknot in $S^1 \times S^2$; see Figure 2.(i).
- (4) J_1, J_2 and J_3 are obtained from parallel copies of $S^1 \times \{y_0\}$ by surgery along 2-dimensional 1-handles in the figure. Here, we can see that handles are attached so that the results of surgery are oriented and depend on the cores and framings (or twistings) of the cores. (See the second column in Figure 2, and note that we may obtain different knots by twisting the bands more.)
- (5) In the next section we will construct an n -knot in $S^n \times S^2$ from three parallel copies of $S^n \times \{y_0\}$ by surgery along two interesting $(n + 1)$ -dimensional 1-handles.

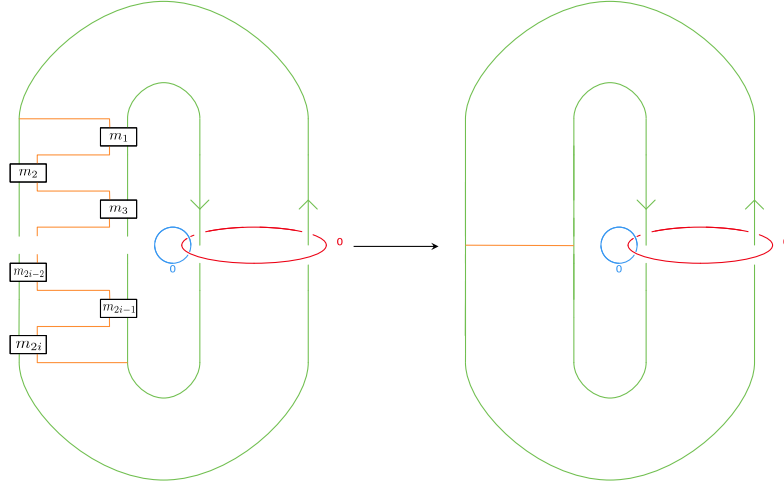

FIGURE 3. An isotopy between cores. An integer m in the box indicates m -full positive twist. C_i is the equator of D_i . Left: any arc attached to $C_1 \cup C_2$ is isotopic to the orange arc for some values of m_1, \dots, m_{2i} . Right: the trivial arc attached to $C_1 \cup C_2$.

A natural question related to the construction of J_3 is whether one can construct an n -knot in $S^n \times S^2$ which is homotopic but not isotopic to the unknot from two parallel copies of $S^n \times \{y_0\}$ by surgery along a single $(n + 1)$ -dimensional 1-handle. However, the following theorem shows that this does not work for $n \geq 2$.

Theorem 2.7. *Fix $n \geq 2$. Let $N = (S^n \times \{y_1\}) \cup \overline{(S^n \times \{y_2\})} \subset S^n \times S^2$ with opposite orientations, where $y_1 \neq y_2 \in S^2$. Let $h := e(B^1 \times B^n)$ be a 1-handle attached to N for some embedding $e : B^1 \times B^n \hookrightarrow S^n \times S^2$ such that $(S^n \times \{y_1\}) \cap h = e(\{-1\} \times B^n)$ and $\overline{(S^n \times \{y_2\})} \cap h = e(\{1\} \times B^n)$. Then the result of surgery N_h is isotopic to the unknot, i.e., N_h bounds an $(n + 1)$ -ball in $S^n \times S^2$.*

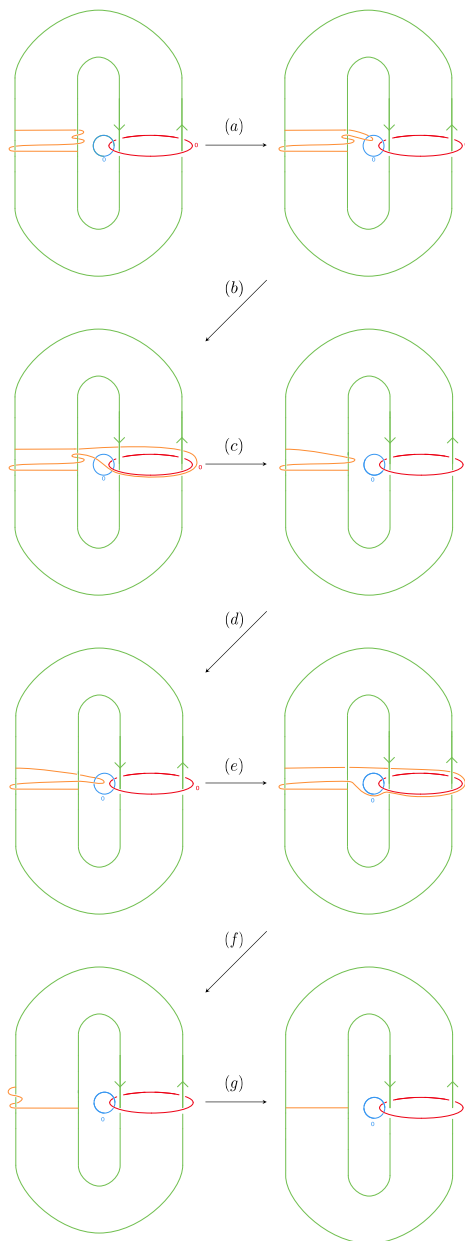

FIGURE 4. An isotopy between cores when $m_1 = 2$ and $m_2 = -1$.
 (a), (d): isotopies pushing the orange arc into B^{n+2} and pulling back. (b), (e): isotopies sliding the orange arc over 2-handle.
 (c), (f), (g): obvious isotopies.

Proof. Consider the standard handle decomposition of $S^n \times S^2$ described in Remark 2.1 and Figure 1. Let $D_1 = S^n \times \{y_1\}$ and $D_2 = S^n \times \{y_2\}$. Now consider a 1-handle h attached to $D_1 \cup D_2$. By Corollary 2.4, it suffices to consider the core

of the 1-handle h . The core of the 1-handle can be isotoped into $\mathbb{R}^3 \times \{0\} \subset \mathbb{R}^3 \times \mathbb{R}^{n-2} \subset \mathbb{R}^{n+1} \cup \{\infty\}$ and furthermore isotoped into the orange arc for some integers m_1, \dots, m_{2i} in the left-hand side of Figure 3 because a homotopy between arcs implies an isotopy of arcs in $S^n \times S^2$. We will show that the orange arc in the left-hand side of Figure 3 can be isotoped into the trivial arc in the right-hand side of Figure 3. Figure 4 illustrates how to isotope the orange arc into the trivial when $m_1 = 2$ and $m_2 = -1$. Repeating the process illustrated in this example shows how to do the general case. Therefore the result of surgery N_h along h is isotopic to the result of surgery along the trivial 1-handle which is the unknot in $S^n \times S^2$ by Corollary 2.4. \square

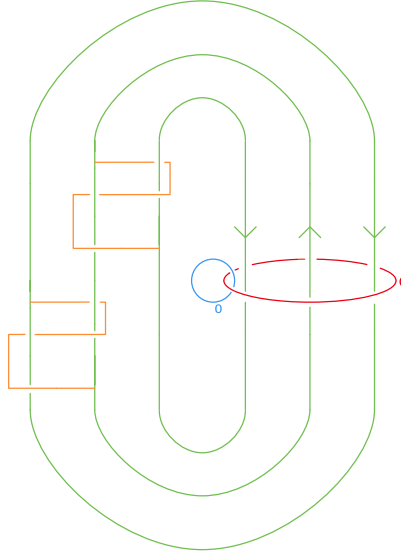

FIGURE 5. K^n is the result of surgery of $(S^n \times \{y_1\}) \cup \overline{(S^n \times \{y_2\})} \cup (S^n \times \{y_3\})$ along two 1-handles h_{12} and h_{23} with orange cores.

3. MAIN THEOREMS

Definition 3.1. Let $n \geq 2$. Let $N = (S^n \times \{y_1\}) \cup \overline{(S^n \times \{y_2\})} \cup (S^n \times \{y_3\}) \subset S^n \times S^2$, where $y_1, y_2, y_3 \in S^2$ are three distinct points. Let h_{12} be the 1-handle attached to $(S^n \times \{y_1\}) \cup \overline{(S^n \times \{y_2\})}$ whose core is in Figure 5. Let h_{23} be the 1-handle attached to $\overline{(S^n \times \{y_2\})} \cup (S^n \times \{y_3\})$ whose core is in Figure 5. We define an n -knot K^n in $S^n \times S^2$ to be the result of surgery of N along $h_{12} \cup h_{23}$.

We now see some properties of K^n .

Proposition 3.2. K^n is homotopic to $S^n \times \{y_0\}$ in $S^n \times S^2$, the geometric intersection number $|K^n \cap (\{x_0\} \times S^2)| = 3$, and the algebraic intersection number $K^n \cdot (\{x_0\} \times S^2) = 1$, where $x_0 \in S^n$.

Proof. There exists an isotopy between the union of the two cores in Figure 5 and the union of the two trivial cores in Figure 6 such that at one moment of the isotopy

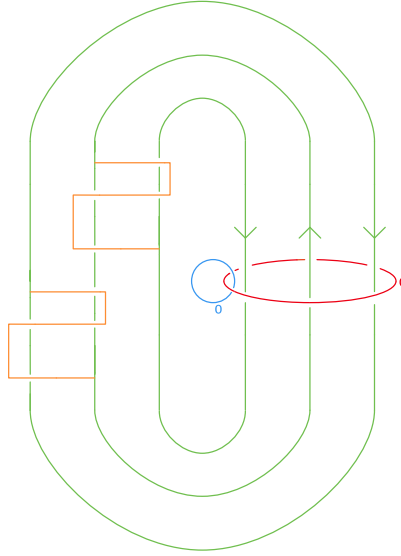

FIGURE 6. Isotoped cores (trivial cores) in $S^n \times S^2$ or $S^n \times S^2 \times B^1$. The isotopy looks like crossing changes in the $(\mathbb{R}^3 \times \{0\})$ -slice.

the arcs intersect the green spheres at four points (like crossing changes). The result of the surgery along the two 1-handles with the trivial cores in Figure 6 is isotopic to $S^n \times \{y_0\}$, so K^n is homotopic to $S^n \times \{y_0\}$. Clearly, $|K^n \cap (\{x_0\} \times S^2)| = 3$, and the algebraic intersection number $K^n \cdot (\{x_0\} \times S^2) = 1$ from the construction. \square

Proposition 3.3. $K^n \times \{0\}$ in $S^n \times S^2 \times B^1$ is isotopic to $S^n \times \{y_0\} \times \{0\}$.

Proof. We can isotope each core of the 1-handles in Figure 5 to the trivial core in Figure 6 using the extra B^1 factor without intersections between arcs and green spheres. By Corollary 2.4, $K^n \times \{0\}$ is isotopic to $S^n \times \{y_0\} \times \{0\}$, which is isotopic to the result of the surgery along the trivial cores in Figure 6. \square

Remark 3.4 (A handle decomposition of K^n). K^n is obtained from three parallel copies of $S^n \times \{y_0\}$ by surgery along two $(n + 1)$ -dimensional 1-handles in Figure 5. Here, the green equator of each parallel copy bounds a properly embedded trivial n -ball (n -dimensional 0-handle) in B^{n+2} and a copy of the core (n -dimensional n -handle) of the $(n + 2)$ -dimensional n -handle of $S^n \times S^2$. Surgery along a 1-handle $B^1 \times B^n$ removes $(\{-1\} \times B^n) \cup (\{1\} \times B^n)$ and glues $B^1 \times S^{n-1}$ so $B^1 \times S^{n-1} = B^1 \times (B_-^n \cup B_+^n) = (B^1 \times B_-^{n-1}) \cup (B^1 \times B_+^{n-1})$ consists of an n -dimensional 1-handle (yellow) and an $(n - 1)$ -handle (purple) in Figure 7. Therefore, K^n has a handle decomposition with three 0-handles, two 1-handles, two $(n - 1)$ -handles and three n -handles. For example, Figure 7 is a banded unlink diagram for K^2 in $S^2 \times S^2$ when $n = 2$. See [3] for more details of banded unlink diagrams.

Remark 3.5 (A handle decomposition of $S^n \times S^2 \setminus \text{int}(\nu(K^n))$). Each i -handle of K^n determines an $(i + 1)$ -handle for $S^n \times S^2 \setminus \text{int}(\nu(K^n))$ when the codimension is 2. (See chapter 6.2 in [2].) We note that the number of $(n + 1)$ -handles for

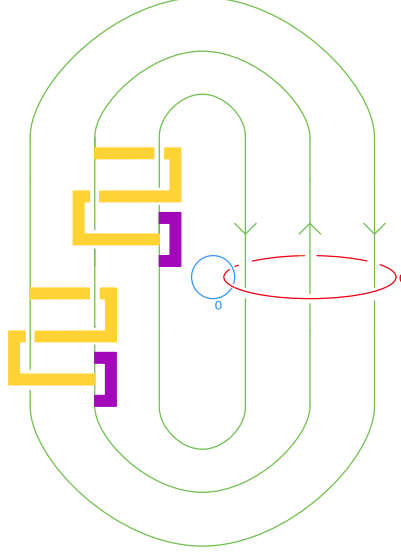

FIGURE 7. A handle decomposition of K^n in the handle decomposition of $S^n \times S^2$ consists of three n -dimensional 0-handle, two 1-handles (yellow), two $(n-1)$ -handles (purple), and three n -handles (not drawn).

the complement induced by the n -handles for K^n is one less than the number of n -handles and a dotted $(n-1)$ -sphere means carving a properly embedded trivial n -ball in B^{n+2} whose boundary is a dotted $(n-1)$ -sphere, which is equivalent to attaching a 1-handle. Therefore, the handle decomposition of K^n in Remark 3.4 gives the handle decomposition of $S^n \times S^2 \setminus \text{int}(\nu(K^n))$ in Figure 8.

Proposition 3.6. $\pi_1(S^n \times S^2 \setminus \text{int}(\nu(K^n)))$ is non-trivial.

Proof. Consider the handle decomposition of the complement $S^n \times S^2 \setminus \text{int}(\nu(K^n))$ of K^n in $S^n \times S^2$ in Figure 8. A black dotted $(n-1)$ -sphere and a red 1-sphere represent a 1-handle and a 2-handle, respectively, so the fundamental group $\pi_1(S^n \times S^2 \setminus \text{int}(\nu(K^n)))$ has the following presentation:

$$\langle x_1, x_2, x_3 | x_1 x_2 x_1 x_2^{-1} x_1^{-1} x_2^{-1} = 1, x_2^{-1} x_3^{-1} x_2^{-1} x_3 x_2 x_3 = 1, x_1^{-1} x_2 x_3^{-1} = 1 \rangle.$$

Delete x_3 by using the third relation $x_3 = x_1^{-1} x_2 \Leftrightarrow x^{-1} x_2 x_3^{-1} = 1$:

$$\langle x_1, x_2 | x_1 x_2 x_1 x_2^{-1} x_1^{-1} x_2^{-1} = 1, x_2^{-2} x_1 x_2^{-1} x_1^{-1} x_2^2 x_1^{-1} x_2 = 1 \rangle.$$

Simplify the second relation by multiplying both sides by x_2 on the left and x_2^{-1} on the right:

$$\langle x_1, x_2 | x_1 x_2 x_1 x_2^{-1} x_1^{-1} x_2^{-1} = 1, x_2^{-1} x_1 x_2^{-1} x_1^{-1} x_2^2 x_1^{-1} = 1 \rangle.$$

Use the substitution $x_1 = ab^{-1}$ and $x_2 = b^2 a^{-1}$, in other words let $a = x_1 x_2 x_1$ and $b = x_2 x_1$:

$$\langle a, b | a^2 b^{-3} = 1, ab^{-2} ab^{-1} ab^{-1} a^{-1} b^2 a^{-1} b^2 a^{-1} b a^{-1} = 1 \rangle.$$

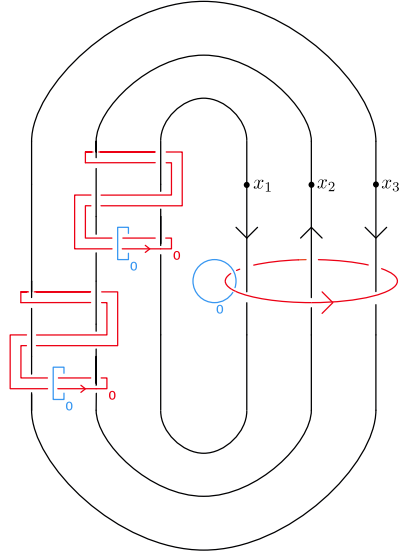

FIGURE 8. A handle decomposition of $S^n \times S^2 \setminus \text{int}(\nu(K^n))$ consists of a single $(n + 2)$ -dimensional 0-handle, three 1-handles (black dotted $(n - 1)$ -spheres), three 2-handles (red 1-spheres), three n -handles (blue $(n - 1)$ -spheres) and two $(n + 1)$ -handles (not drawn).

Simplify the second relation by multiplying both sides by a^{-1} on the left and a on the right :

$$\langle a, b | a^2 b^{-3} = 1, b^{-2} a b^{-1} a b^{-1} a^{-1} b^2 a^{-1} b^2 a^{-1} b = 1 \rangle.$$

Simplify the second relation by multiplying both sides by b on the left and b^{-1} on the right:

$$\langle a, b | a^2 b^{-3} = 1, b^{-1} a b^{-1} a b^{-1} a^{-1} b^2 a^{-1} b^2 a^{-1} = 1 \rangle.$$

Include the relation $a^2 = b^3 = 1$:

$$\langle a, b | a^2 = b^3 = 1, b^{-1} a b^{-1} a b^{-1} a^{-1} b^2 a^{-1} b^2 a^{-1} = 1 \rangle.$$

Multiply both sides by a on the right in the second relation:

$$\langle a, b | a^2 = b^3 = 1, b^{-1} a b^{-1} a b^{-1} a^{-1} b^2 a^{-1} b^2 = a \rangle.$$

Multiply both sides by b on the right and use $b^3 = 1$ in the second relation:

$$\langle a, b | a^2 = b^3 = 1, b^{-1} a b^{-1} a b^{-1} a^{-1} b^2 a^{-1} = ab \rangle.$$

Multiply both sides by a on the right in the second relation:

$$\langle a, b | a^2 = b^3 = 1, b^{-1} a b^{-1} a b^{-1} a^{-1} b^2 = aba \rangle.$$

Multiply both sides by b on the right and use $b^3 = 1$ in the second relation:

$$\langle a, b | a^2 = b^3 = 1, b^{-1} a b^{-1} a b^{-1} a^{-1} = abab \rangle.$$

Multiply both sides by a on the right in the second relation:

$$\langle a, b | a^2 = b^3 = 1, b^{-1} a b^{-1} a b^{-1} = ababa \rangle.$$

Multiply both sides by b on the right in the second relation:

$$\langle a, b | a^2 = b^3 = 1, b^{-1}ab^{-1}a = ababab \rangle.$$

Multiply both sides by a on the right and use $a^2 = 1$ in the second relation:

$$\langle a, b | a^2 = b^3 = 1, b^{-1}ab^{-1} = abababa \rangle.$$

Multiply both sides by b on the right in the second relation:

$$\langle a, b | a^2 = b^3 = 1, b^{-1}a = abababab \rangle.$$

Multiply both sides by a on the right and use $a^2 = 1$ in the second relation:

$$\langle a, b | a^2 = b^3 = 1, b^{-1} = ababababa \rangle.$$

Multiply both sides by b on the right in the second relation:

$$\langle a, b | a^2 = b^3 = 1, 1 = ababababab \rangle.$$

Simplify the relations and get the following presentation:

$$\langle a, b | a^2 = b^3 = (ab)^5 = 1 \rangle,$$

which is isomorphic to the alternating group A_5 of degree 5. Therefore, $\pi_1(S^n \times S^2 \setminus \text{int}(\nu(K^n)))$ is non-trivial. \square

Corollary 3.7. K^n is not isotopic to $S^n \times \{y_0\}$ in $S^n \times S^2$.

Proof. Suppose that K^n is isotopic to $S^n \times \{y_0\}$. Then $S^n \times S^2 \setminus \text{int}(\nu(K^n))$ is diffeomorphic to $B^n \times S^2$, so $\pi_1(S^n \times S^2 \setminus \text{int}(\nu(K^n)))$ is trivial, which is a contradiction to Proposition 3.6. \square

We now construct a contractible $(n+3)$ -manifold by using the n -knot K^n .

Definition 3.8. Let K^n be the n -knot in $S^n \times S^2$ in Definition 3.1. Let $\phi : S^n \times B^2 \hookrightarrow S^n \times S^2 = \partial(S^n \times B^3)$ be an embedding such that $\phi(S^n \times \{0\}) = K^n$. We define $X_{K^n} := S^n \times B^3 \cup_{\phi} B^{n+1} \times B^2$ to be the $(n+3)$ -manifold obtained from $S^n \times B^3$ by attaching a single $(n+1)$ -handle along ϕ .

Remark 3.9. There is a unique framing of the attaching sphere $\phi(S^n \times \{0\}) = K^n$ because $\pi_n(SO(2))$ is trivial when $n \geq 2$. Therefore X_{K^n} is uniquely determined by the isotopy class of K^n .

Proposition 3.10. $X_{K^n} \times B^1$ is diffeomorphic to B^{n+4} .

Proof. Let $\phi : S^n \times B^2 \hookrightarrow S^n \times S^2$ be the embedding such that $\phi(S^n \times \{0\}) = K^n$ in Definition 3.1 and $\Phi : S^n \times B^2 \times B^1 \hookrightarrow S^n \times S^2 \times B^1$ be an embedding defined by $\Phi(x, y, t) = (\phi(x, y), t)$. Then $X_{K^n} \times B^1 = (S^n \times B^3 \cup_{\phi} B^{n+1} \times B^2) \times B^1 \cong S^n \times B^3 \times B^1 \cup_{\Phi} B^{n+1} \times B^2 \times B^1$. By Proposition 3.3, $\Phi(S^n \times \{0\} \times \{0\}) = K^n \times \{0\}$ is isotopic to $S^n \times \{y_0\} \times \{0\}$ in $S^n \times S^2 \times B^1 \subset \partial(S^n \times B^3 \times B^1)$ so the attaching sphere of the $(n+1)$ -handle intersects the belt sphere of the n -handle geometrically once and $S^n \times B^3 \times B^1 \cup_{\Phi} B^{n+1} \times B^2 \times B^1 \cong B^{n+4}$. Therefore $X_{K^n} \times B^1 \cong B^{n+4}$. \square

Remark 3.11 (A handle decomposition of ∂X_{K^n}). ∂X_{K^n} is obtained from $S^n \times S^2$ by surgery along K^n , i.e., $\partial X_{K^n} = (S^n \times S^2 \setminus \text{int}(\nu(K^n))) \cup_{\phi|_{S^n \times S^1}} B^{n+1} \times S^1$, where $\phi(S^n \times B^2) = \nu(K^n)$. We can consider $B^{n+1} \times S^1$ as the union of an $(n+2)$ -dimensional $(n+1)$ -handle and an $(n+2)$ -handle. Therefore a handle decomposition of X_{K^n} is obtained from the handle decomposition of $S^n \times S^2 \setminus \text{int}(\nu(K^n))$ in Remark 3.5 by attaching an $(n+1)$ -handle and an $(n+2)$ -handle. Therefore ∂X_{K^n} admits

a handle decomposition with a 0-handle, three 1-handles, three 2-handles, three n -handles, three $(n+1)$ -handles and an $(n+2)$ -handle.

Proposition 3.12. $\pi_1(\partial X_{K^n}) \cong \pi_1(S^n \times S^2 \setminus \text{int}(\nu(K^n)))$.

Proof. In Remark 3.11, $B^{n+1} \times S^1$ is the union of an $(n+1)$ -handle and an $(n+2)$ -handle, which does not affect the fundamental group of ∂X_{K^n} . Therefore $\pi_1(\partial X_{K^n}) \cong \pi_1(S^n \times S^2 \setminus \text{int}(\nu(K^n)))$. \square

Corollary 3.13. ∂X_{K^n} is a non-simply connected homology $(n+2)$ -sphere.

Proof. Clearly, ∂X_{K^n} is a homology $(n+2)$ -sphere because X_{K^n} is a contractible manifold. Also, $\pi_1(\partial X_{K^n}) \cong \pi_1(S^n \times S^2 \setminus \text{int}(\nu(K^n)))$ is non-trivial by Proposition 3.6 and 3.12. \square

Corollary 3.14. X_{K^n} is contractible but not homeomorphic to B^{n+3} .

Proof. X_{K^n} is contractible by Proposition 3.10 but not homeomorphic to B^{n+3} by Corollary 3.13. \square

Corollary 3.15. There exists no n -knot F in $S^n \times S^2$ such that F is isotopic to K^n and $|F \cap (\{x_0\} \times S^2)| < 3$.

Proof. Suppose that there is an n -knot F in $S^n \times S^2$ such that F is isotopic to K^n and $|F \cap (\{x_0\} \times S^2)| = 1$. Since K^n and F are isotopic, X_{K^n} is diffeomorphic to X_F which is obtained from $S^n \times B^3$ by attaching a single $(n+1)$ -handle along F . Since $|F \cap (\{x_0\} \times S^2)| = 1$, X_{K^n} is diffeomorphic to $B^{n+3} \cong X_F$, which is a contradiction to Corollary 3.14. Suppose that there is an n -knot F in $S^n \times S^2$ such that F is isotopic to K^n and $|F \cap (\{x_0\} \times S^2)| = 2$. Then, the algebraic intersection number $F \cdot (\{x_0\} \times S^2)$ is 0 or ± 2 , so $K^n \cdot (\{x_0\} \times S^2)$ is 0 or ± 2 . This is a contradiction to $K^n \cdot (\{x_0\} \times S^2) = 1$. Therefore there exists no n -knot F in $S^n \times S^2$ such that F is isotopic to K^n and $|F \cap (\{x_0\} \times S^2)| < 3$. \square

We now prove our main theorems.

Theorem 1.1. *For any integer $n \geq 2$, there exists a contractible, compact, smooth $(n+3)$ -manifold with boundary admitting a handle decomposition with a 0-handle, an n -handle and an $(n+1)$ -handle which is not homeomorphic to the standard $(n+3)$ -ball B^{n+3} .*

Proof. Let X_{K^n} be the $(n+3)$ -manifold in Definition 3.1. X_{K^n} admits a handle decomposition with a 0-handle, an n -handle and an $(n+1)$ -handle by Definition 3.1. X_{K^n} is contractible but not homeomorphic to B^{n+3} by Corollary 3.14. \square

Lemma 3.16. The double $DX_{K^n} = X_{K^n} \cup_{id} \overline{X_{K^n}}$ of X_{K^n} is diffeomorphic to S^{n+3} , where $id : \partial X_{K^n} \rightarrow \partial X_{K^n}$ is an identity map.

Proof. $DX_{K^n} = X_{K^n} \cup_{id} \overline{X_{K^n}} \cong \partial(X_{K^n} \times B^1) \cong \partial(B^{n+4}) = S^{n+3}$ by Proposition 3.10. \square

Theorem 1.2. *For any integer $n \geq 2$, there exists an involution of S^{n+3} whose fixed point set is a non-simply connected homology $(n+2)$ -sphere.*

Proof. By Lemma 3.16, $S^{n+3} \cong X_{K^n} \cup_{id} \overline{X_{K^n}}$. Define an involution $\phi : S^{n+3} \rightarrow S^{n+3}$ switching copies of X_{K^n} and fixing ∂X_{K^n} . \square

REFERENCES

- [1] Jeffrey Boyle. Classifying 1-handles attached to knotted surfaces. *Transactions of the American Mathematical Society*, 306(2):475–487, 1988.
- [2] R.E. Gompf and A. Stipsicz. *4-Manifolds and Kirby Calculus*. Graduate studies in mathematics. American Mathematical Society, 1999.
- [3] Mark C Hughes, Seungwon Kim, and Maggie Miller. Isotopies of surfaces in 4-manifolds via banded unlink diagrams. *Geometry & Topology*, 24(3):1519–1569, 2020.
- [4] Michel A Kervaire. Smooth homology spheres and their fundamental groups. *Transactions of the American Mathematical Society*, 144:67–72, 1969.
- [5] Barry Mazur. A note on some contractible 4-manifolds. *Annals of Mathematics*, pages 221–228, 1961.
- [6] Yoshihisa Sato. 2-knots in $S^2 \times S^2$, and homology 4-spheres. *Osaka Journal of Mathematics*, 28(2):243–253, 1991.
- [7] Yoshihisa Sato. Locally flat 2-knots in $S^2 \times S^2$ with the same fundamental group. *Transactions of the American Mathematical Society*, 323(2):911–920, 1991.

DEPARTMENT OF MATHEMATICS, UNIVERSITY OF GEORGIA, ATHENS, GA 30602
Email address: g.kim@uga.edu