

# CYCLIC OBJECTS FROM SURFACES

IVAN BARTULOVIĆ

ABSTRACT. In this paper, we endow the family of closed oriented genus  $g$  surfaces, starting with torus, with a structure of a (co)cyclic object in the category of 3-dimensional cobordisms. As a corollary, any 3-dimensional TQFT induces a (co)cyclic module, which we compute algebraically for the Reshetikhin-Turaev TQFT.

*Keywords.* Cyclic objects, cobordisms, topological quantum field theories (TQFTs).

2020 *Mathematics Subject Classification.* 18N50, 57K16.

## CONTENTS

1. Introduction	1
2. Cyclic objects	2
3. 3-cobordisms	4
4. Cyclic objects from surfaces	8
5. Preliminaries on monoidal categories and Hopf algebras	19
6. Cyclic modules from (co)algebras	25
7. Cyclic modules from TQFTs	30
8. Related work	42
9. Appendix	44
References	46

## 1. INTRODUCTION

In this paper, we study cyclic objects and their interplay with topological field theories. A (co)cyclic object in a category is, roughly speaking, a (co)simplicial object with compatible actions of the cyclic groups. Cyclic homology of algebras was independently introduced by Connes [10] and Tsygan [30]. To any algebra is associated a cocyclic vector space, that is, a cocyclic object in the category of vector spaces. This construction was generalized to braided setting by Akrami and Majid [1], who associate a cocyclic vector space to any ribbon algebra in a braided monoidal category.

On the other hand, compact surfaces are relatively well-understood 2-manifolds which appear in many areas of mathematics. In particular, closed oriented surfaces are objects of a symmetric monoidal category of 3-dimensional cobordisms. A morphism between two surfaces is given by a homeomorphism class of 3-cobordisms between the given surfaces. The category of 3-cobordisms is of great interest in quantum topology. Introduced by Atiyah [3], a 3-dimensional topological quantum field theory (or shortly, TQFT) is a strong symmetric monoidal functor from the category of 3-cobordisms to vector spaces. A fundamental construction of a 3-dimensional TQFT in this sense is the Reshetikhin-Turaev TQFT [28, 31].

The main result of this paper is that the family of closed oriented surfaces has a structure of a (co)cyclic object in the category of 3-dimensional cobordisms (see Theorem 4.1). As a corollary, any 3-dimensional TQFT induces a (co)cyclic vector space. We calculate this (co)cyclic vector space for the Reshetikhin-Turaev TQFT (see Theorem 7.1). In a certain sense, the (co)cyclic objects obtained from closed oriented surfaces universally calculate the cyclic (co)homology of (co)cyclic modules (à la Akrami-Majid [1] and its variants) associated to the coend (which is a braided Hopf algebra) of anomaly free modular categories. Finally, we discuss some potentially related work in the setting of category of connected cobordisms, which first appeared in [17] and is different from the cobordism category used throughout the paper. For instance, it is a non-symmetric braided category. In this setting, we outline a construction of the so called para(co)cyclic objects associated to the one-holed torus (see sections **8B** and **8C**). By composition, the braided monoidal functor  $J_3$  from [7] universally induces para(co)cyclic objects associated to the end of unimodular ribbon factorizable categories.

The paper is organized as follows. In Section 2, we recall the notion of a (co)cyclic object in a category. In Section 3, we recall some facts about 3-cobordisms and their presentation via special ribbon graphs. In Section 4, we construct (co)cyclic objects in the category of 3-dimensional cobordisms. In Section 5, we review ribbon categories and their graphical calculus, braided Hopf algebras, and related concepts. Section 6 is dedicated to (co)cyclic modules from categorical (co)algebras. In Section 7 we relate, via the Reshetikhin-Turaev TQFT, the (co)cyclic objects from surfaces with (co)cyclic modules associated to the coend of an anomaly free modular category. In Section 8, we discuss paracyclic objects in the category of connected cobordisms. In Appendix, we recall some known facts about (co)ends of a braided pivotal category, thought as universal (co)modules.

Unless otherwise stated, by  $\mathbb{k}$  we denote any commutative ring. The class of objects in a category  $\mathcal{C}$  is denoted by  $\text{Ob}(\mathcal{C})$ .

**Acknowledgments.** Most of the content of this paper is part of my PhD thesis. I would like to thank my supervisor Alexis Virelizier for his comments and advice. I would also like to thank Ulrich Krähmer, Christoph Schweigert, and Kenichi Shimizu for discussions and comments. Finally, I am grateful to the Laboratoire Paul Painlevé of the University of Lille and the Institut für Geometrie of the TU Dresden for their hospitality. This work was supported by the Labex CEMPI (ANR-11-LABX-0007-01), by the Région Hauts-de-France, and by the FNS-ANR OChoTop grant (ANR-18-CE93-0002-01).

## 2. CYCLIC OBJECTS

In this section we recall the notions of (co)simplicial and (co)cyclic objects in a category.

**2A. The simplicial category.** The *simplicial category*  $\Delta$  is defined as follows. The objects of  $\Delta$  are the non-negative integers. For  $n \in \mathbb{N}$ , denote  $[n] = \{0, \dots, n\}$ . A morphism  $n \rightarrow m$  in  $\Delta$  is an increasing map between sets  $[n]$  and  $[m]$ . For  $n \in \mathbb{N}^*$  and  $0 \leq i \leq n$ , the  $i$ -th *coface*  $\delta_i^n: n-1 \rightarrow n$  is the unique increasing injection from  $[n-1]$  into  $[n]$  which misses  $i$ . For  $n \in \mathbb{N}$  and  $0 \leq j \leq n$ , the  $j$ -th *codegeneracy*  $\sigma_j^n: n+1 \rightarrow n$  is the unique increasing surjection from  $[n+1]$  onto  $[n]$  which sends both  $j$  and  $j+1$  to  $j$ .

It is well known (see [24, Lemma 5.1]) that morphisms in  $\Delta$  are generated by cofaces  $\{\delta_i^n\}_{n \in \mathbb{N}^*, 0 \leq i \leq n}$  and codegeneracies  $\{\sigma_j^n\}_{n \in \mathbb{N}, 0 \leq j \leq n}$  subject to the *simplicial relations*:

$$\delta_j^{n+1} \delta_i^n = \delta_i^{n+1} \delta_{j-1}^n \quad \text{for all } 0 \leq i < j \leq n+1, \quad (1)$$

$$\sigma_j^n \sigma_i^{n+1} = \sigma_i^n \sigma_{j+1}^{n+1} \quad \text{for all } 0 \leq i \leq j \leq n, \quad (2)$$

$$\sigma_j^n \delta_i^{n+1} = \begin{cases} \delta_i^n \sigma_{j-1}^{n-1} & \text{for all } 0 \leq i < j \leq n, \\ \text{id}_n & \text{for all } 0 \leq i = j \leq n \text{ or } 1 \leq i = j + 1 \leq n + 1, \\ \delta_{i-1}^n \sigma_j^{n-1} & \text{for all } 1 \leq j + 1 < i \leq n + 1. \end{cases} \quad (3)$$

In the opposite category  $\Delta^{\text{op}}$ , every coface  $\delta_i^n$  and every codegeneracy  $\sigma_j^n$  are respectively denoted by

$$d_i^n: n \rightarrow n - 1 \quad \text{and} \quad s_j^n: n \rightarrow n + 1.$$

The morphisms  $\{d_i^n\}_{n \in \mathbb{N}^*, 0 \leq i \leq n}$  are called *faces* and the morphisms  $\{s_j^n\}_{n \in \mathbb{N}, 0 \leq j \leq n}$  are called *degeneracies*.

**2B. The cyclic category.** The *cyclic category*  $\Delta C$  is defined as follows. The objects of  $\Delta C$  are the non-negative integers. The morphisms in this category are generated by morphisms  $\{\delta_i^n\}_{n \in \mathbb{N}^*, 0 \leq i \leq n}$ , called *cofaces*, morphisms  $\{\sigma_j^n\}_{n \in \mathbb{N}, 0 \leq j \leq n}$ , called *codegeneracies*, and isomorphisms  $\{\tau_n: n \rightarrow n\}_{n \in \mathbb{N}}$ , called *cocyclic operators*, satisfying the simplicial relations and additionally:

$$\tau_n \delta_i^n = \delta_{i-1}^n \tau_{n-1} \quad \text{for all } 1 \leq i \leq n, \quad (4)$$

$$\tau_n \delta_0^n = \delta_n^n \quad \text{for all } n \geq 1, \quad (5)$$

$$\tau_n \sigma_i^n = \sigma_{i-1}^n \tau_{n+1} \quad \text{for all } 1 \leq i \leq n, \quad (6)$$

$$\tau_n \sigma_0^n = \sigma_n^n \tau_{n+1}^2 \quad \text{for all } n \geq 0 \quad \text{and} \quad (7)$$

$$\tau_n^{n+1} = \text{id}_n \quad \text{for all } n \in \mathbb{N}. \quad (8)$$

Note that  $\tau_0 = \text{id}_0$ . In the opposite category  $\Delta C^{\text{op}}$ , every coface  $\delta_i^n$ , every codegeneracy  $\sigma_j^n$ , and every cocyclic operator  $\tau_n$  are respectively denoted by

$$d_i^n: n \rightarrow n - 1, \quad s_j^n: n \rightarrow n + 1, \quad \text{and} \quad t_n: n \rightarrow n.$$

The morphisms  $\{d_i^n\}_{n \in \mathbb{N}^*, 0 \leq i \leq n}$  are called *faces*, the morphisms  $\{s_j^n\}_{n \in \mathbb{N}, 0 \leq j \leq n}$  are called *degeneracies*, and the morphisms  $\{t_n\}_{n \in \mathbb{N}}$  are called *cyclic operators*.

**2C. (Co)simplicial and (co)cyclic objects in a category.** Let  $\mathcal{C}$  be any category. A *simplicial object* in  $\mathcal{C}$  is a functor  $\Delta^{\text{op}} \rightarrow \mathcal{C}$  and a *cyclic object* in  $\mathcal{C}$  is a functor  $\Delta C^{\text{op}} \rightarrow \mathcal{C}$ . Dually, a *cosimplicial object* in  $\mathcal{C}$  is a functor  $\Delta \rightarrow \mathcal{C}$  and a *cocyclic object* in  $\mathcal{C}$  is a functor  $\Delta C \rightarrow \mathcal{C}$ . A (co)simplicial/(co)cyclic object in the category of  $\mathbb{k}$ -modules is called a (co)simplicial/(co)cyclic  $\mathbb{k}$ -module. A *morphism* between two (co)simplicial/(co)cyclic objects is a natural transformation between them. For shortness, one often denotes the image of a morphism  $f$  under a (co)simplicial/(co)cyclic object in  $\mathcal{C}$  by the same letter  $f$ .

Since the categories  $\Delta$  and  $\Delta C$  are defined by generators and relations, a (co)simplicial/(co)cyclic object in a category is entirely determined by the images of the generators satisfying the corresponding relations. For example, a cocyclic object  $X$  in  $\mathcal{C}$  may be explicitly described as a family  $X^\bullet = \{X^n\}_{n \in \mathbb{N}}$  of objects in  $\mathcal{C}$ , equipped with morphisms  $\{\delta_i^n: X^{n-1} \rightarrow X^n\}_{n \in \mathbb{N}^*, 0 \leq i \leq n}$ , called *cofaces*, morphisms  $\{\sigma_j^n: X^{n+1} \rightarrow X^n\}_{n \in \mathbb{N}, 0 \leq j \leq n}$ , called *codegeneracies*, and isomorphisms  $\{\tau_n: X^n \rightarrow X^n\}_{n \in \mathbb{N}}$ , called *cocyclic operators*, which satisfy (1)-(8). Note that  $\tau_0 = \text{id}_{X^0}$ . A morphism  $\alpha^\bullet: X^\bullet \rightarrow Y^\bullet$  between cocyclic objects  $X^\bullet$  and  $Y^\bullet$  in  $\mathcal{C}$  is then described by a family  $\alpha^\bullet = \{\alpha^n: X^n \rightarrow Y^n\}_{n \in \mathbb{N}}$  of morphisms in  $\mathcal{C}$  such that

$$\delta_i^n \alpha^{n-1} = \alpha^n \delta_i^n \quad \text{for all } n \in \mathbb{N}^* \text{ and } 0 \leq i \leq n, \quad (9)$$

$$\sigma_j^n \alpha^{n+1} = \alpha^n \sigma_j^n \quad \text{for all } n \in \mathbb{N} \text{ and } 0 \leq j \leq n, \quad (10)$$

$$\alpha^n \tau_n = \tau_n \alpha^n \quad \text{for all } n \in \mathbb{N}. \quad (11)$$

Similarly as above, a cyclic object  $X$  in  $\mathcal{C}$  may be seen as a family  $X_\bullet = \{X_n\}_{n \in \mathbb{N}}$  of objects in  $\mathcal{C}$  equipped with morphisms  $\{d_i^n: X_n \rightarrow X_{n-1}\}_{n \in \mathbb{N}^*, 0 \leq i \leq n}$ , called *faces*, morphisms  $\{s_j^n: X_n \rightarrow X_{n+1}\}_{n \in \mathbb{N}, 0 \leq j \leq n}$ , called *degeneracies*, and isomorphisms  $\{t_n: X_n \rightarrow X_n\}_{n \in \mathbb{N}}$ , called *cyclic operators*, which satisfy the corresponding relations in  $\Delta C^{\text{op}}$ . Also, a morphism  $\alpha_\bullet: X_\bullet \rightarrow Y_\bullet$  between two cyclic objects  $X_\bullet$  and  $Y_\bullet$  in  $\mathcal{C}$  is described by a family  $\alpha_\bullet = \{\alpha_n: X_n \rightarrow Y_n\}_{n \in \mathbb{N}}$  of morphisms in  $\mathcal{C}$  commuting with faces, degeneracies and cyclic operators of  $X_\bullet$  and  $Y_\bullet$ .

**2D. Cyclic duality.** It is well-known that cyclic category is isomorphic to its opposite category. The isomorphism established by Connes in [9] is called *cyclic duality*. In its version due to Loday [22, Proposition 6.1.11], the cyclic duality  $L: \Delta C^{\text{op}} \rightarrow \Delta C$  is identity on objects and it is defined on morphisms as follows. For  $n \in \mathbb{N}^*$  and  $0 \leq i \leq n$ ,

$$L(d_i^n) = \begin{cases} \sigma_i^{n-1} & \text{if } 0 \leq i \leq n-1, \\ \sigma_0^{n-1} \tau_n^{-1} & \text{if } i = n, \end{cases}$$

and for  $n \in \mathbb{N}$  and  $0 \leq j \leq n$ ,

$$L(s_j^n) = \delta_{j+1}^{n+1} \quad \text{and} \quad L(t_n) = \tau_n^{-1}.$$

Given a category  $\mathcal{C}$ , the cyclic duality transforms any cocyclic object  $X: \Delta C \rightarrow \mathcal{C}$  in  $\mathcal{C}$  into the cyclic object  $XL: \Delta C^{\text{op}} \rightarrow \mathcal{C}$ . Similarly, the opposite functor  $L^{\text{op}}$  turns any cyclic object  $Y: \Delta C^{\text{op}} \rightarrow \mathcal{C}$  in  $\mathcal{C}$  into the cocyclic object  $YL^{\text{op}}: \Delta C \rightarrow \mathcal{C}$ .

**2E. Reindexing involution automorphism.** Following Loday [22, Section 6.1.14], we recall the *reindexing involution automorphism*  $\Phi$  of the cyclic category. It is identity on objects and it is defined on morphisms as follows. For  $n \in \mathbb{N}^*$  and  $0 \leq i \leq n$ ,

$$\Phi(\delta_i^n) = \delta_{n-i}^n,$$

and for  $n \in \mathbb{N}$  and  $0 \leq j \leq n$ ,

$$\Phi(\sigma_j^n) = \sigma_{n-j}^n \quad \text{and} \quad \Phi(\tau_n) = \tau_n^{-1}.$$

### 3. 3-COBORDISMS

In this section we recall some facts about the category  $\mathbf{Cob}_3$  of 3-dimensional cobordisms (or shortly, 3-cobordisms) and their surgery presentations via ribbon graphs. We denote by  $D^n$  the closed unit ball in  $\mathbb{R}^n$ . The  $n$ -dimensional sphere is denoted by  $S^n$ .

**3A. 3-cobordisms.** A 3-cobordism is a quadruple  $(M, h, \Sigma_0, \Sigma_1)$ , where  $M$  is a compact oriented 3-manifold,  $\Sigma_0$  and  $\Sigma_1$  are two closed oriented surfaces, and  $h$  is an orientation preserving homeomorphism  $h: (-\Sigma_0) \sqcup \Sigma_1 \rightarrow \partial M$ . The surface  $\Sigma_0$  is called the *bottom base* and the surface  $\Sigma_1$  is called the *top base* of the cobordism  $M$ . Two cobordisms  $(M, h, \Sigma_0, \Sigma_1)$  and  $(M', h', \Sigma_0, \Sigma_1)$  are *homeomorphic*, if there is an orientation preserving homeomorphism  $g: M \rightarrow M'$  such that  $h = h'g|_{\partial M}$ . When clear, we will denote a cobordism  $(M, h, \Sigma_0, \Sigma_1)$  only by  $M$ .

The composition of two cobordisms  $(M_0, h_0, \Sigma_0, \Sigma_1)$  and  $(M_1, h_1, \Sigma_1, \Sigma_2)$  is the cobordism  $(M, h, \Sigma_0, \Sigma_2)$ , where  $M$  is obtained by gluing  $M_0$  to  $M_1$  along  $h_1 h_0^{-1}: h_0(\Sigma_1) \rightarrow h_1(\Sigma_1)$  and the homeomorphism  $h$  is given by

$$h = h_0|_{\Sigma_0} \sqcup h_1|_{\Sigma_2}: (-\Sigma_0) \sqcup \Sigma_2 \rightarrow \partial M.$$

We say that cobordism  $M$  is obtained by gluing cobordisms  $M_0$  and  $M_1$  along  $\Sigma_1$ .

**3B. The category  $\mathbf{Cob}_3$ .** The category  $\mathbf{Cob}_3$  of 3-cobordisms is defined as follows. The objects are closed oriented surfaces. A morphism  $f: \Sigma_0 \rightarrow \Sigma_1$  in  $\mathbf{Cob}_3$  is a homeomorphism class of cobordisms between  $\Sigma_0$  and  $\Sigma_1$ . In  $\mathbf{Cob}_3$ , the identity of a closed oriented surface  $\Sigma$  is represented by *identity cobordism*  $(C_\Sigma, e, \Sigma, \Sigma)$ , where  $C_\Sigma = \Sigma \times [0, 1]$  is a cylinder over  $\Sigma$  together with product orientation, and  $e: (-\Sigma) \sqcup \Sigma \rightarrow \partial C_\Sigma$  is the homeomorphism with  $e|_{-\Sigma}(x, 0) = (x, 0)$  and  $e|_\Sigma(x, 1) = (x, 1)$ . The composition of morphisms  $\Sigma_0 \rightarrow \Sigma_1$  and  $\Sigma_1 \rightarrow \Sigma_2$  in  $\mathbf{Cob}_3$ , represented respectively by cobordisms  $M$  and  $N$ , is represented by cobordism obtained by gluing cobordisms  $M$  and  $N$  along  $\Sigma_1$ . The category  $\mathbf{Cob}_3$  is symmetric monoidal (see Section 5B). The monoidal product is given by disjoint union and the monoidal unit is the empty surface. For more details, see [32].

**3C. Surgery presentation of closed 3-manifolds.** Let  $L$  be an  $n$ -component framed link in the 3-sphere  $S^3$ . Pick a closed tubular neighborhood  $N_L$  of  $L$ . Since  $N_L$  is homeomorphic to  $\sqcup_{i=1}^n S^1 \times D^2$ , the boundary of the 3-manifold  $S^3 \setminus \text{Int}(N_L)$  is homeomorphic to the disjoint union of  $n$ -tori  $S^1 \times S^1$ . The *Dehn surgery on  $S^3$  along  $L$*  is the closed manifold

$$S_L^3 = (S^3 \setminus N_L) \bigcup_{\phi} (\sqcup_{i=1}^n D^2 \times S^1),$$

where  $\phi: \partial(S^3 \setminus \text{Int}(N_L)) \rightarrow \sqcup_{i=1}^n S^1 \times S^1$  is a homeomorphism exchanging meridians and parallels. Any connected, oriented, closed 3-manifold  $M$  is, according to the Lickorish's theorem [21, Chapter 12], homeomorphic to  $S_L^3$  for some framed link  $L \subset S^3$ .

**3D. Ribbon graphs.** A *circle* is a 1-manifold homeomorphic to  $S^1$ . An *arc* is a 1-manifold homeomorphic to the closed interval  $[0, 1]$ . The boundary points of an arc are called its *endpoints*. A *rectangle* is a 2-manifold with corners homeomorphic to  $[0, 1] \times [0, 1]$ . The four corner points of a rectangle split its boundary into four arcs called the *sides*. A *coupon* is an oriented rectangle with a distinguished side called the *bottom base*, the opposite side being the *top base*.

A *plexus* is a topological space obtained from a disjoint union of a finite number of oriented circles, oriented arcs, and coupons by gluing some endpoints of the arcs to the bases of the coupons. It is required that different endpoints of the arcs are never glued to the same point of a (base of a) coupon. The endpoints of the arcs that are not glued to coupons are called *free ends*. The set of free ends of a plexus  $\gamma$  is denoted by  $\partial\gamma$ .

Given non-negative integers  $g$  and  $h$ , a *ribbon  $(g, h)$ -graph*  $\Gamma$  is a plexus  $\Gamma$  embedded in  $\mathbb{R}^2 \times [0, 1]$  and equipped with a framing such that

$$\partial\Gamma = \Gamma \cap \partial(\mathbb{R}^2 \times [0, 1]) = \{(1, 0, 0), \dots, (g, 0, 0)\} \cup \{(1, 0, 1), \dots, (h, 0, 1)\}$$

and such that the arcs of  $\Gamma$  are transverse to  $\partial(\mathbb{R}^2 \times [0, 1])$  at all points of  $\partial\Gamma$ . The free end  $(i, 0, 0)$  is called the  *$i$ -th input* and the free end  $(j, 0, 1)$  is called the  *$j$ -th output* of  $\Gamma$ . For example, ribbon graphs without free ends and without coupons are nothing but framed oriented links in  $\mathbb{R}^2 \times (0, 1) \cong \mathbb{R}^3$ .

We represent ribbon graphs by plane diagrams with blackboard framing. We require that for each coupon, its orientation is that of the plane, its bases are horizontal, and its bottom base is below its top base. By Reidemeister theorem, two diagrams represent isotopic ribbon graphs if and only if they are related by a finite sequence of plane isotopies, ribbon Reidemeister moves **R1-R3**

$\text{R1}$

$\text{R2}$

$\text{R3}$

and the following move:

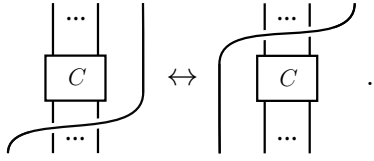

**3E. Standard ribbon graphs and surfaces.** For  $g \geq 0$ , consider the ribbon graph

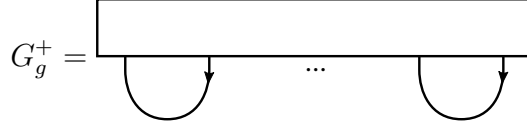

consisting of one coupon and  $g$  unknotted untwisted cups oriented from right to left successively attached to the bottom base of the coupon. We fix a closed regular neighborhood  $H_g^+ \subset \mathbb{R}^2 \times [0, 1]$  of  $G_g^+$ . This is a handlebody of genus  $g$  and is provided with the right-handed orientation. Consider also the ribbon graph

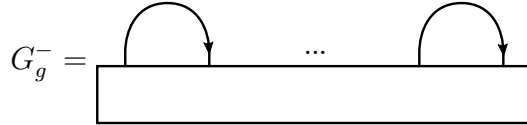

consisting of one coupon and  $g$  unknotted untwisted caps oriented from left to right successively attached to the top base of the coupon. We fix a closed regular neighborhood  $H_g^- \subset \mathbb{R}^2 \times [0, 1]$  of  $G_g^-$ . This is a handlebody of genus  $g$  and is provided with the right-handed orientation. We choose the neighborhoods  $H_g^+$  and  $H_g^-$  so that the mirror reflection of  $\mathbb{R}^3$  with respect to the line  $\mathbb{R}^2 \times \{\frac{1}{2}\}$  induces an orientation preserving homeomorphism between  $-(H_g^-)$  and  $H_g^+$ , where  $-(H_g^-)$  is  $H_g^-$  with opposite orientation.

The boundary  $S_g$  of  $H_g^+$  is a closed connected oriented surface of genus  $g$  called the *standard surface of genus  $g$* . The orientation of  $S_g$  is induced by that of  $H_g^+$ . (We use the “outward vector first” convention for the induced orientation of the boundary.) The above mirror reflection induces a canonical orientation preserving homeomorphism between  $\partial(H_g^-)$  and  $-S_g$ .

**3F. Special ribbon graphs and 3-cobordisms.** Let  $g$  and  $h$  be non-negative integers. A *special ribbon  $(g, h)$ -graph* is a ribbon  $(2g, 2h)$ -graph  $\Gamma$  with no coupons such that:

- for all  $1 \leq i \leq g$ , the  $(2i - 1)$ -th and  $2i$ -th inputs of  $\Gamma$  are connected by an arc oriented from the  $(2i - 1)$ -th input to the  $2i$ -th input,
- for all  $1 \leq j \leq h$ , the  $(2j - 1)$ -th and  $2j$ -th outputs of  $\Gamma$  are connected by an arc oriented from the  $2j$ -th output to the  $(2j - 1)$ -th output.

Any special ribbon  $(g, h)$ -graph  $\Gamma$  gives rise to a connected 3-cobordism  $M_\Gamma$  between the standard surfaces  $S_g$  and  $S_h$  (see Section **3E**). It is defined as follows. Attach coupons

$$Q^- = [0, 2g + 1] \times \{0\} \times [-1, 0] \quad \text{and} \quad Q^+ = [0, 2h + 1] \times \{0\} \times [1, 2]$$

to the bottom and the top of  $\Gamma$ , respectively. The result is a ribbon graph without free ends  $\tilde{\Gamma}$  in  $\mathbb{R}^3 \cong \mathbb{R}^2 \times (0, 1)$  with no free ends, two coupons  $Q^\pm$ , and finitely many circle components which form a framed link  $L$  in  $S^3$ . The arcs connecting the inputs of  $\Gamma$  become caps attached on the top base of  $Q^-$ , so there is an embedding  $f^-: G_g^- \rightarrow \tilde{\Gamma}$  mapping the coupon of  $G_g^-$  to  $Q^-$  and mapping the caps attached to  $G_g^-$  to those attached to  $Q^-$ . Similarly, the arcs connecting the outputs of  $\Gamma$  become cups attached on the bottom base of  $Q^+$ , so there is an embedding  $f^+: G_h^+ \rightarrow \tilde{\Gamma}$  mapping the coupon of  $G_h^+$  to  $Q^+$  and mapping the cups attached to  $G_h^+$  to those attached to  $Q^+$ . Consider a tubular neighborhood  $N_L$  of  $L$

and embeddings  $\tilde{f}^-: H_g^- \rightarrow S^3 \setminus N_L$  and  $\tilde{f}^+: H_h^+ \rightarrow S^3 \setminus N_L$  respectively extending  $f^-$  and  $f^+$ . Let  $S_L^3$  be the Dehn surgery of  $S^3$  along  $L$  (see Section **3C**). The manifold

$$S_\Gamma^3 = S_L^3 \setminus \left( \tilde{f}^-(\text{Int}(H_g^-)) \cup \tilde{f}^+(\text{Int}(H_h^+)) \right)$$

is a connected oriented compact 3-manifold. By Section **3E**, its boundary  $\tilde{f}^-(\partial(H_g^-)) \sqcup \tilde{f}^+(\partial(H_h^+))$  is canonically homeomorphic to  $(-S_g) \sqcup S_h$ . This gives rise to a connected 3-cobordism  $M_\Gamma: S_g \rightarrow S_h$ .

For example, by [31, Chapter IV, Lemma 2.6.], the identity cobordism of the standard surface  $S_g$  (see Section **3B**) is represented by the following special ribbon  $(g, g)$ -graph

$$I_g = \begin{array}{c} \text{Diagram 1} \\ \text{1} \end{array} \quad \dots \quad \begin{array}{c} \text{Diagram g} \\ \text{g} \end{array} . \tag{12}$$

The following lemma gives a presentation of the composition of 3-cobordisms between standard surfaces.

**Lemma 3.1** ([31, Section IV.2.3]). *If  $\Gamma$  is a special ribbon  $(g, h)$ -graph and  $\Gamma'$  is a special ribbon  $(h, k)$ -graph, then the composition of 3-cobordisms  $M_\Gamma: S_g \rightarrow S_h$  and  $M_{\Gamma'}: S_h \rightarrow S_k$  is then the 3-cobordism  $M_{\Gamma' \circ \Gamma}: S_g \rightarrow S_k$ , where  $\Gamma' \circ \Gamma$  is the special ribbon  $(g, k)$ -graph obtained by stacking  $\Gamma'$  over  $\Gamma$ .*

Note that the connectedness of top base of  $M_\Gamma$  and bottom base of  $M_{\Gamma'}$  is here important. For the general case of 3-cobordisms with non-connected bases, which we do not need in what follows, see [31, Section IV.2.8].

**3G. Extended Kirby calculus.** Recall from Section **3C** that any closed oriented 3-manifold can be obtained by surgery of  $S^3$  along a framed link. Kirby proved [20] that two framed links represent the same 3-manifold (up to an orientation preserving homeomorphism) if and only if they are related by a finite sequence of isotopies and of the *Kirby moves* **K1** and **K2**. The move **K1** consists in adding an unknot with framing number (which is the self-linking number) 1 or  $-1$ :

$$L \sqcup \text{Unknot} \longleftrightarrow L \longleftrightarrow L \sqcup \text{Unknot} .$$

The move **K2** consists in sliding a component over another component. More precisely, given two distinct components  $L_i$  and  $L_j$  of a framed link, this move replaces  $L_i$  by the connected sum  $L_i \# L'_j$  of  $L_i$  with a copy  $L'_j$  of  $L_j$  obtained by slightly pushing  $L_j$  along its framing. For example, sliding an unknot with framing number 0 over an unknot with framing number 1 can be depicted as:

$$\begin{array}{ccc} \text{Diagram 1} & \longrightarrow & \text{Diagram 2} \\ L_i & & L_i \end{array}$$

It follows from Reidemeister and Kirby theorems that the Kirby calculus extends to the representation of 3-cobordisms by special ribbon graphs (see [31, Chapter I, Lemma 3.4]). More explicitly, special ribbon graphs represent the same 3-cobordism (up to an orientation preserving homeomorphism) if and only if they are related by a finite sequence of isotopies

and of the following moves: the move **K1**, the generalized Kirby move **K2'**, the move **OR**, the move **COUPON**, and the move **TWIST**. The move **K2'** consists in sliding an arc or circle component of a special ribbon graph over a distinct circle component. The move **OR** consists in reversing the orientation of a circle component. The **COUPON** move consists in changing the type of a crossing of a component passing over (or under) all its outputs

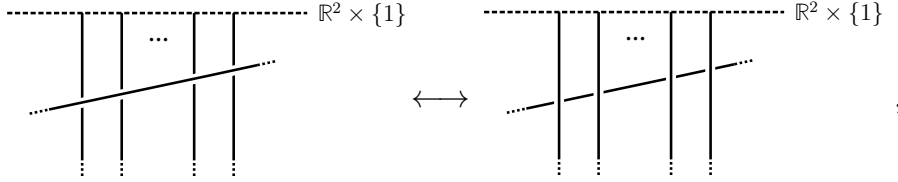

or all its inputs

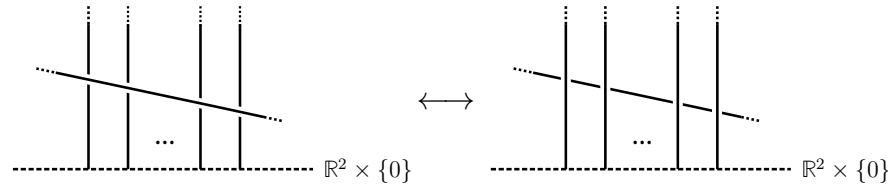

The move **TWIST** consists in a simultaneous twist of the output components

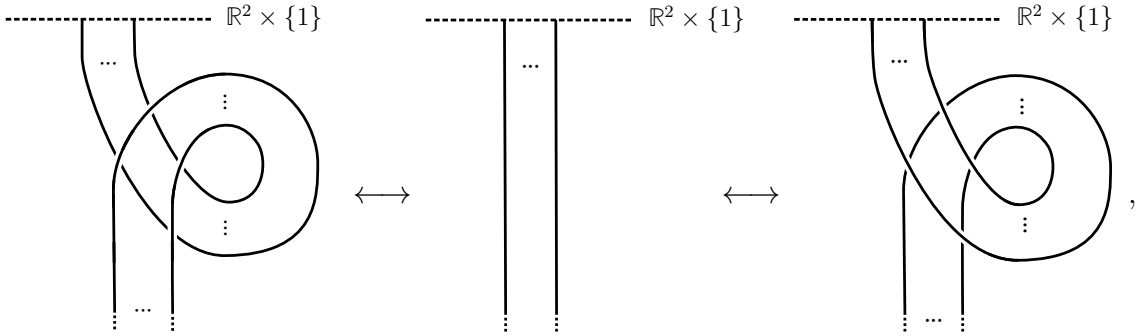

or the input components

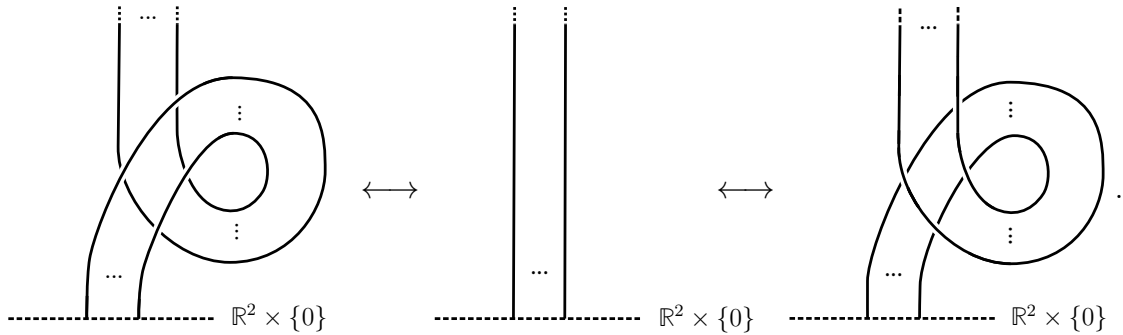

#### 4. CYCLIC OBJECTS FROM SURFACES

The first main result of this paper is that closed oriented surfaces can be organized in a (co)cyclic object in the category  $\mathbf{Cob}_3$  of 3-dimensional cobordisms:

**Theorem 4.1.** *For  $g \geq 1$ , consider a closed oriented surface  $\Sigma_g$  of genus  $g$ . Then the family  $\{\Sigma_g\}_{g \geq 1}$  has a structure of a cocyclic object  $X^\bullet$  in  $\mathbf{Cob}_3$  and a structure of a cyclic object  $X_\bullet$  in  $\mathbf{Cob}_3$ .*

We construct (co)cyclic objects in  $\mathbf{Cob}_3$  by means of surgery presentation of 3-cobordisms developed in [28, 31] and reviewed in the Section 3. We prove Theorem 4.1 in sections **4A**–**4C**. First, in Section **4A** we construct the functor  $Y^\bullet: \Delta C \rightarrow \mathbf{Cob}_3$ . Next, in Section **4B**,



we construct the functor  $Y_\bullet: \Delta C^{\text{op}} \rightarrow \mathbf{Cob}_3$ . Cobordisms in both of these constructions have standard surfaces (see Section 3E) as bases. Finally, in Section 4C we pass from  $Y^\bullet$  and  $Y_\bullet$  to arbitrary  $X^\bullet$  and  $X_\bullet$ , as stated in Theorem 4.1.

The category  $\mathbf{Cob}_3$  is of great interest in quantum topology. For instance, a 3-dimensional TQFT is a symmetric monoidal functor from  $\mathbf{Cob}_3$  to  $\text{Mod}_{\mathbb{k}}$ . By composition, we have the following:

**Corollary 4.2.** *If  $Z$  is a 3-dimensional TQFT, then  $Z \circ X^\bullet$  is a cocyclic  $\mathbb{k}$ -module and  $Z \circ X_\bullet$  is a cyclic  $\mathbb{k}$ -module.*

A fundamental construction of a 3-dimensional TQFT is the Reshetikhin-Turaev TQFT  $\text{RT}_{\mathcal{B}}: \mathbf{Cob}_3 \rightarrow \text{Mod}_{\mathbb{k}}$  associated to an anomaly free modular category  $\mathcal{B}$ . We postpone calculations of  $\text{RT}_{\mathcal{B}} \circ X^\bullet$  and  $\text{RT}_{\mathcal{B}} \circ X_\bullet$  to Section 7. Some algebraic preparations for it are given in sections 5 and 6.

**4A. The construction  $Y^\bullet$ .** Recall the standard surface  $S_g$  (see Section 3E) of genus  $g$ . For any  $n \in \mathbb{N}$ , set  $Y^n = S_{n+1}$ . For  $n \in \mathbb{N}^*$  and  $0 \leq i \leq n$ , the faces  $Y^\bullet(\delta_i^n): S_n \rightarrow S_{n+1}$  are defined as follows. The morphism  $Y^\bullet(\delta_0^n): S_n \rightarrow S_{n+1}$  is the cobordism class presented by the special ribbon graph  $G_{Y^\bullet(\delta_0^n)}$ :

$$G_{Y^\bullet(\delta_0^n)} = \begin{array}{c} \text{[Diagram 1]} \quad \dots \quad \text{[Diagram } n \text{]} \\ \text{1} \quad \dots \quad \text{n} \end{array} .$$

For  $1 \leq i \leq n-1$ , the morphism  $Y^\bullet(\delta_i^n): S_n \rightarrow S_{n+1}$  is defined as the cobordism class presented by the special ribbon graph  $G_{Y^\bullet(\delta_i^n)}$ :

$$G_{Y^\bullet(\delta_i^n)} = \begin{array}{c} \text{[Diagram 1]} \quad \dots \quad \text{[Diagram } i \text{]} \quad \dots \quad \text{[Diagram } n \text{]} \\ \text{1} \quad \dots \quad \text{i} \quad \dots \quad \text{n} \end{array} .$$

Finally, the morphism  $Y^\bullet(\delta_n^n): S_n \rightarrow S_{n+1}$  is defined as the cobordism class presented by the special ribbon graph  $G_{Y^\bullet(\delta_n^n)}$ :

$$G_{Y^\bullet(\delta_n^n)} = \begin{array}{c} \text{[Diagram 1]} \quad \dots \quad \text{[Diagram } n \text{]} \\ \text{1} \quad \dots \quad \text{n} \end{array} .$$

For  $n \in \mathbb{N}$  and  $0 \leq j \leq n$ , the degeneracy  $Y^\bullet(\sigma_j^n): S_{n+2} \rightarrow S_{n+1}$  is the cobordism class presented by the special ribbon graph  $G_{Y^\bullet(\sigma_j^n)}$ :

$$G_{Y^\bullet(\sigma_j^n)} = \begin{array}{c} \text{[Diagram 0]} \quad \dots \quad \text{[Diagram } j \text{]} \quad \text{[Diagram } j+1 \text{]} \quad \dots \quad \text{[Diagram } n+1 \text{]} \\ \text{0} \quad \dots \quad \text{j} \quad \text{j+1} \quad \dots \quad \text{n+1} \end{array} .$$

The morphism  $Y^\bullet(\tau_0): S_1 \rightarrow S_1$  is the identity map  $\text{id}_{S_1}$ , which is represented by the special ribbon graph  $I_1$  depicted in (12). For  $n \in \mathbb{N}^*$ , the cocyclic operator  $Y^\bullet(\tau_n): S_{n+1} \rightarrow S_{n+1}$

is the cobordism class presented by the special ribbon graph  $G_{Y^\bullet(\tau_n)}$ :

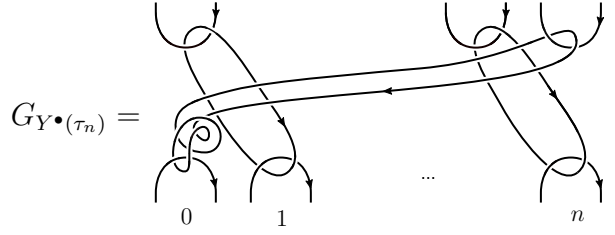

**Lemma 4.3.** *The family  $Y^\bullet = \{S_{n+1}\}_{n \in \mathbb{N}}$ , equipped with the cofaces  $\{Y^\bullet(\delta_i^n)\}_{n \in \mathbb{N}^*, 0 \leq i \leq n}$ , the codegeneracies  $\{Y^\bullet(\sigma_j^n)\}_{n \in \mathbb{N}, 0 \leq j \leq n}$ , and the cocyclic operators  $\{Y^\bullet(\tau_n)\}_{n \in \mathbb{N}}$  is a cocyclic object in  $\mathbf{Cob}_3$ .*

To prove the Lemma 4.3, we intensively use some well-known consequences of the Kirby calculus from Section 3G, which we recollect in the following lemma:

**Lemma 4.4.** *One has the following moves on special ribbon graphs:*

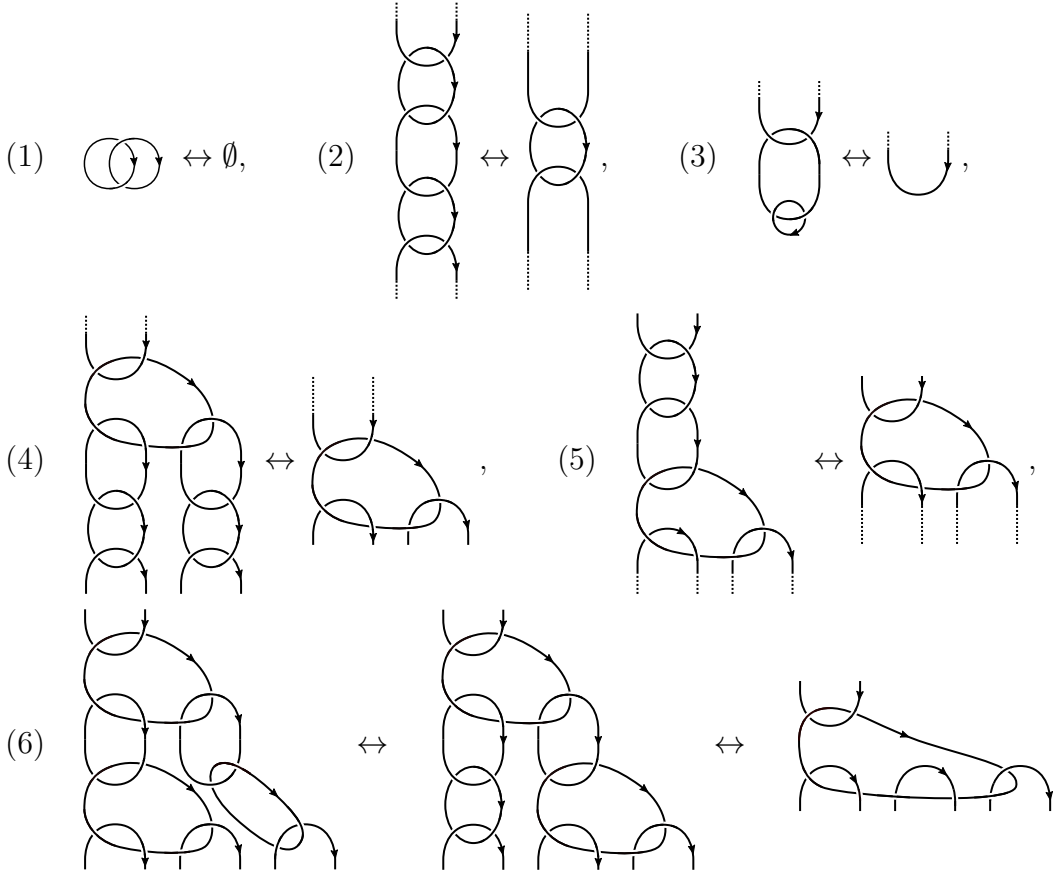

*Proof of Lemma 4.3.* In the proof, we shorten the notation by writing  $\delta_i^n$ ,  $\sigma_j^n$ , and  $\tau_n$  instead of  $Y^\bullet(\delta_i^n)$ ,  $Y^\bullet(\sigma_j^n)$ , and  $Y^\bullet(\tau_n)$ . Let us verify the relation (1). For  $1 \leq i < j \leq n$  we have:

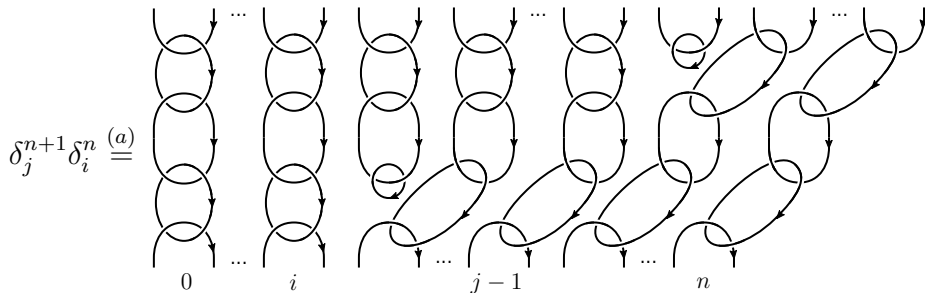

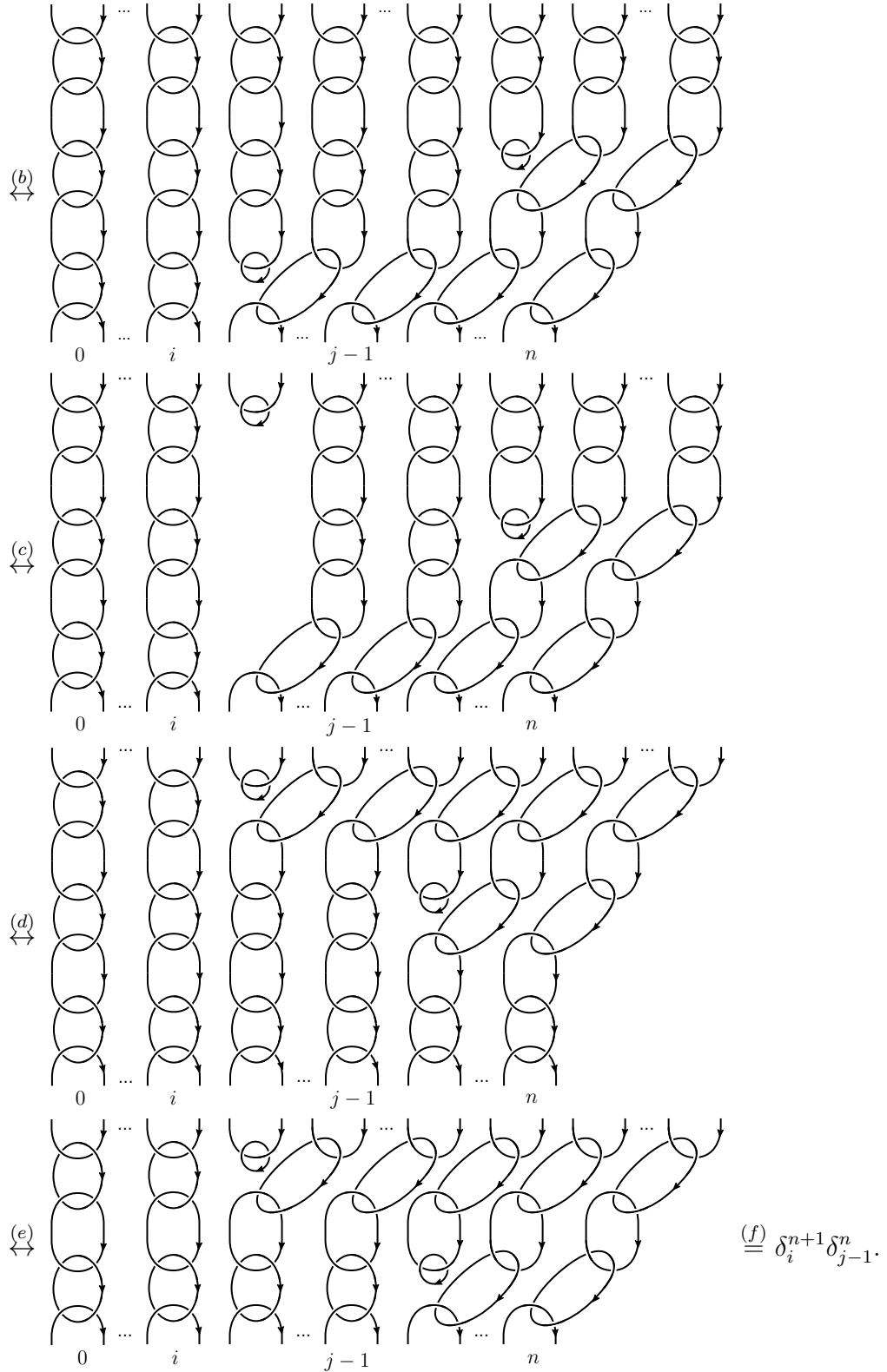

Here (a) and (f) follow from definitions and Lemma 3.1, (b) and (e) follow from Lemma 3.1 and the fact that the graph from equation (12) represents the identity cobordism, (c) from Lemma 4.4 (3), and (d) by isotopy. The remaining cases are verified in a similar way.

Let us verify the relation (2).

(1) Suppose that  $0 \leq i < j \leq n$ . We have:

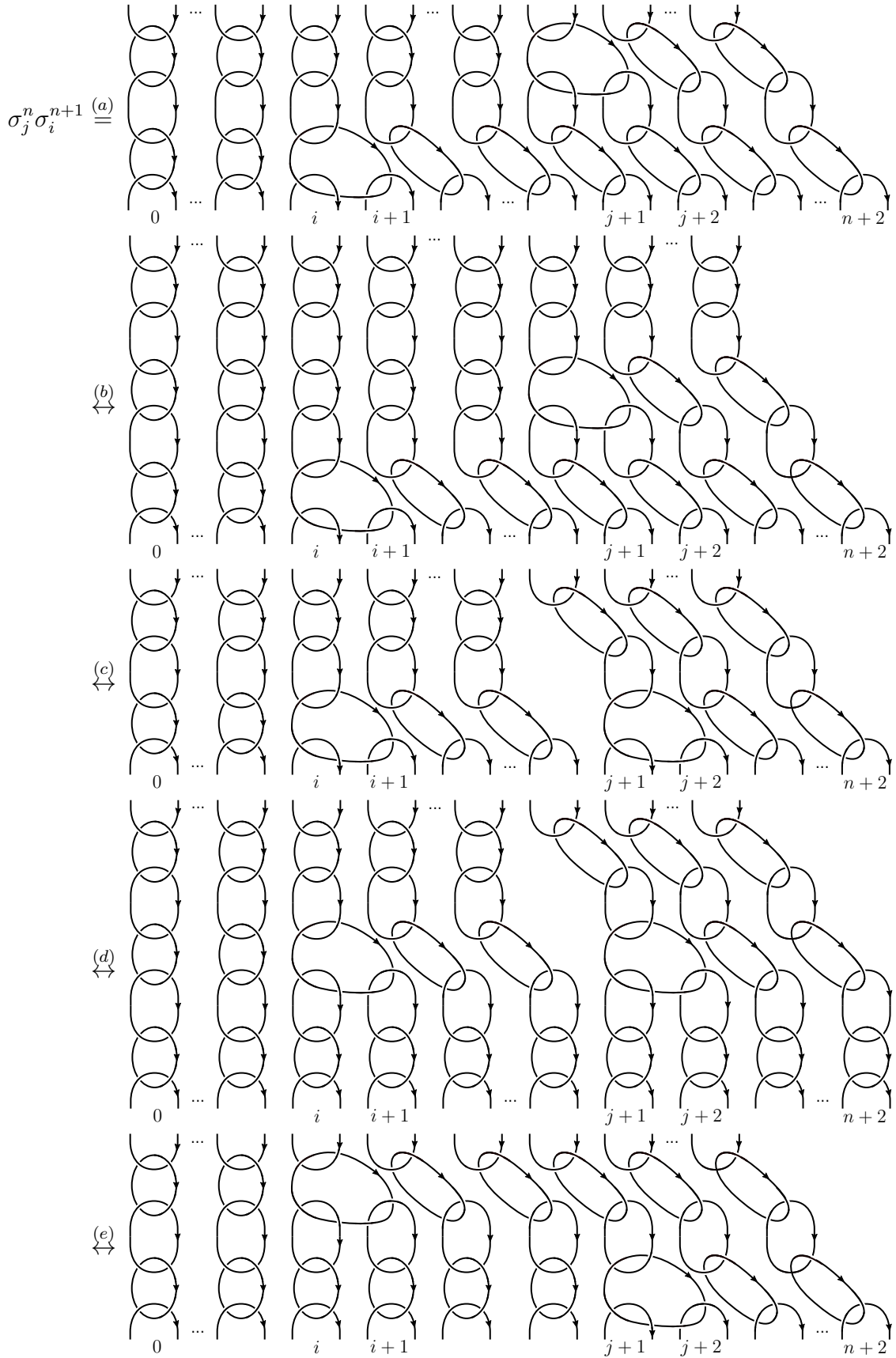

which equals to  $\sigma_i^n \sigma_{j+1}^{n+1}$ . Here (a) follows from definitions and Lemma 3.1, (b) and (d) follow from Lemma 3.1 and the fact that the graph from equation (12) represents the identity cobordism, (c) from Lemma 4.4 (4), (e) follows by applying the parts (2), (4) and (5) of Lemma 4.4 and isotopy.

- (2) Suppose that  $0 \leq i = j \leq n$ . By definition and Lemma 3.1, the composition  $\sigma_i^n \sigma_i^{n+1}$  is presented by

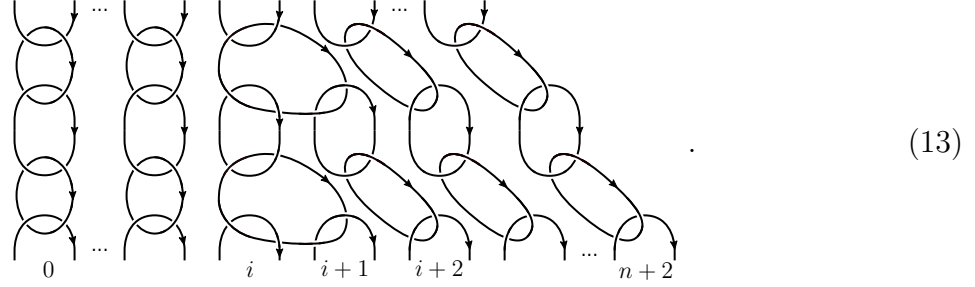

On the other hand, the composition  $\sigma_i^n \sigma_{i+1}^{n+1}$  is presented by

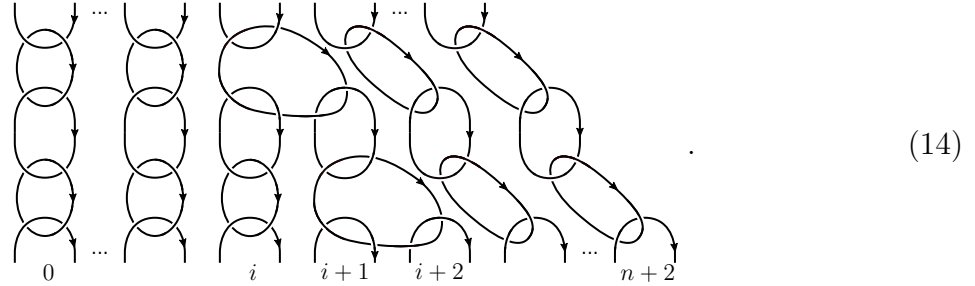

By Lemma 4.4(6), both special graphs from (13) and (14) are equivalent to the special graph

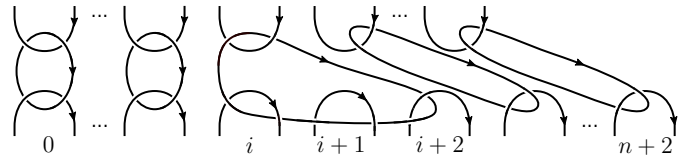

Consequently, the cobordisms  $\sigma_i^n \sigma_i^{n+1}$  and  $\sigma_i^n \sigma_{i+1}^{n+1}$  are in the same class, that is, they are equal in  $\mathbf{Cob}_3$ .

Let us now verify the relation (3).  
Suppose that  $1 \leq i = j \leq n - 1$ . We have

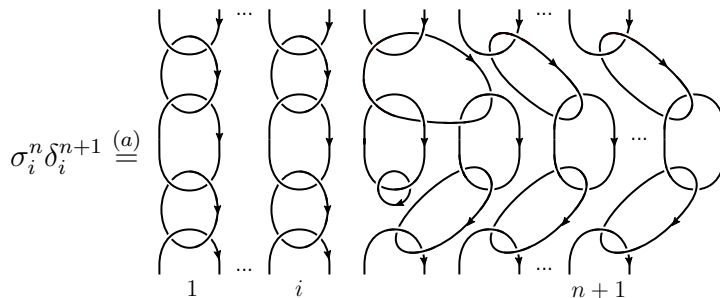

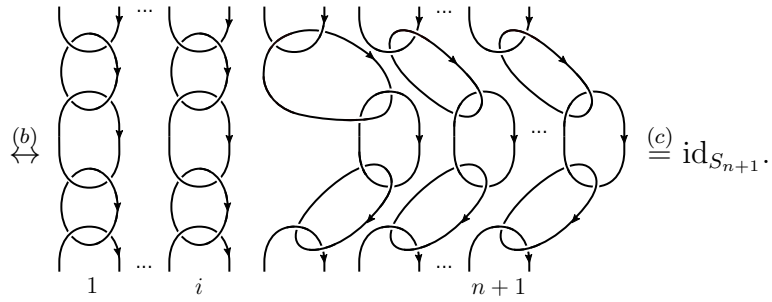

Here (a) follows from definition and Lemma 3.1, (b) from Lemma 4.4 (3), and (c) by isotopy, Lemma 3.1, and presentation of identity cobordism which is given in equation (12). The cases when  $i = 0$  or  $i = n$  are proven similarly.

Suppose now that  $0 \leq i < j \leq n$ . In the case when  $i \neq 0$ , we have

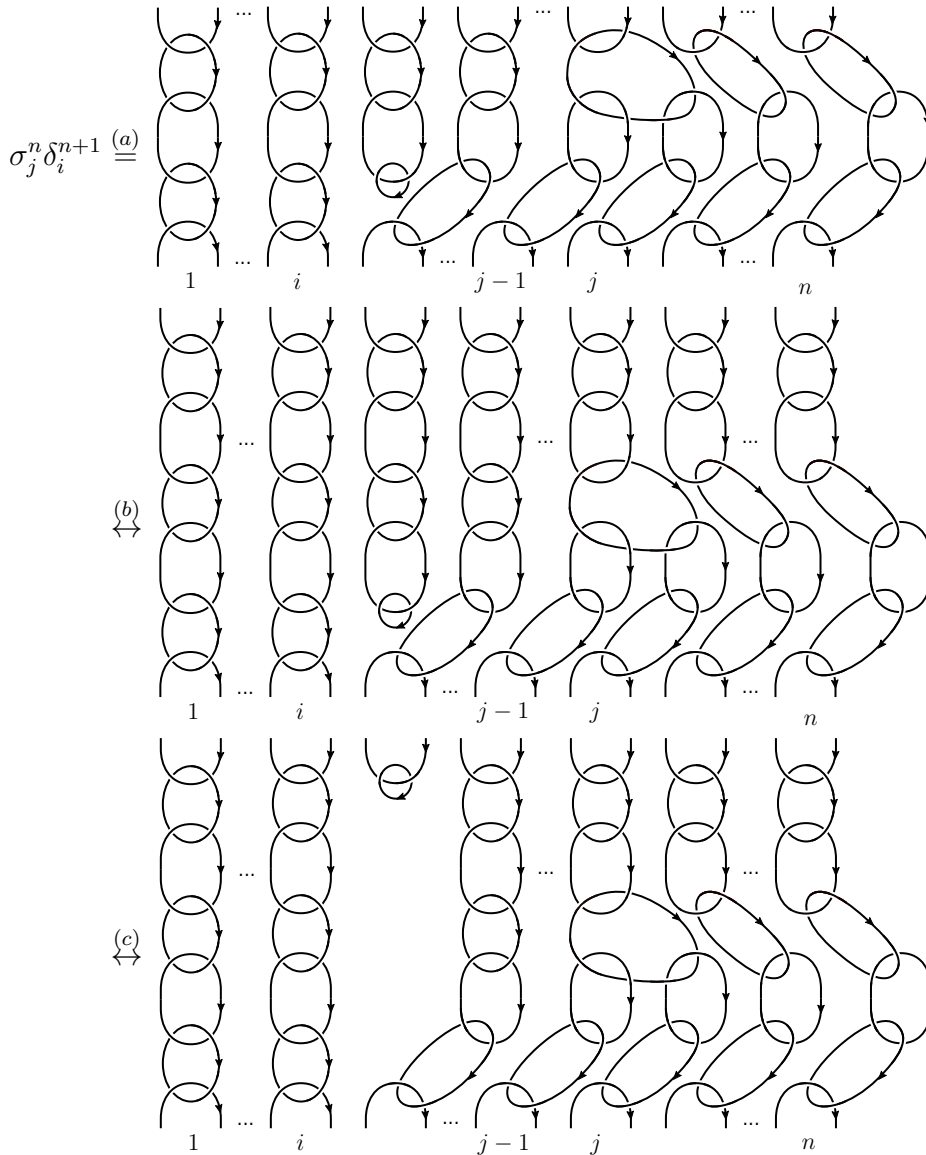

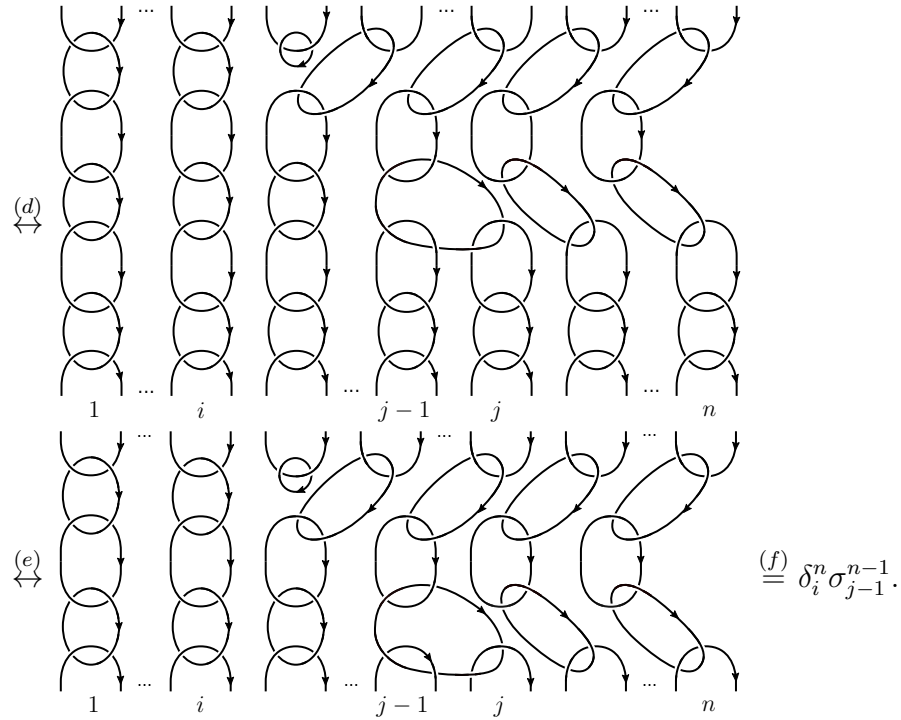

Here (a) and (f) follow from definitions and Lemma 3.1, (b) and (e) follow from Lemma 3.1 and the fact that the graph from equation (12) represents the identity cobordism, (c) follows by applying twice the move from Lemma 4.4 (3), and (d) by isotopy. The case when  $i = 0$  is proven similarly.

The case when  $1 \leq i = j+1 \leq n+1$  is verified in a similar way as the case  $0 \leq i = j \leq n$ . Also, the case when  $1 \leq j+1 < i \leq n+1$  is verified in a similar way as the case  $0 \leq i < j \leq n$ .

It remains to show that relations (4), (6) and (8) hold. Indeed, according to [22, Section 6.1.1], these relations imply relations (5) and (7). Let us verify the relation (4). In the case when  $n \geq 3$  and  $2 \leq i \leq n-1$ , we have

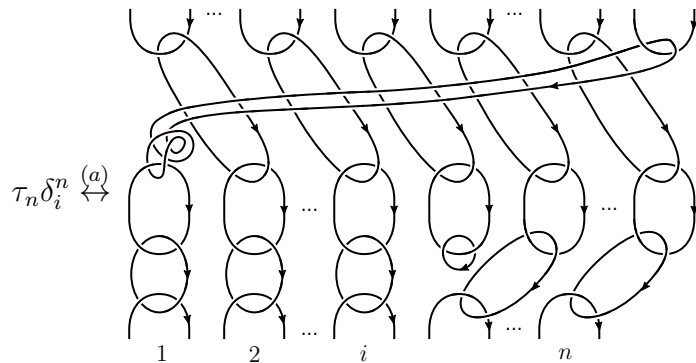

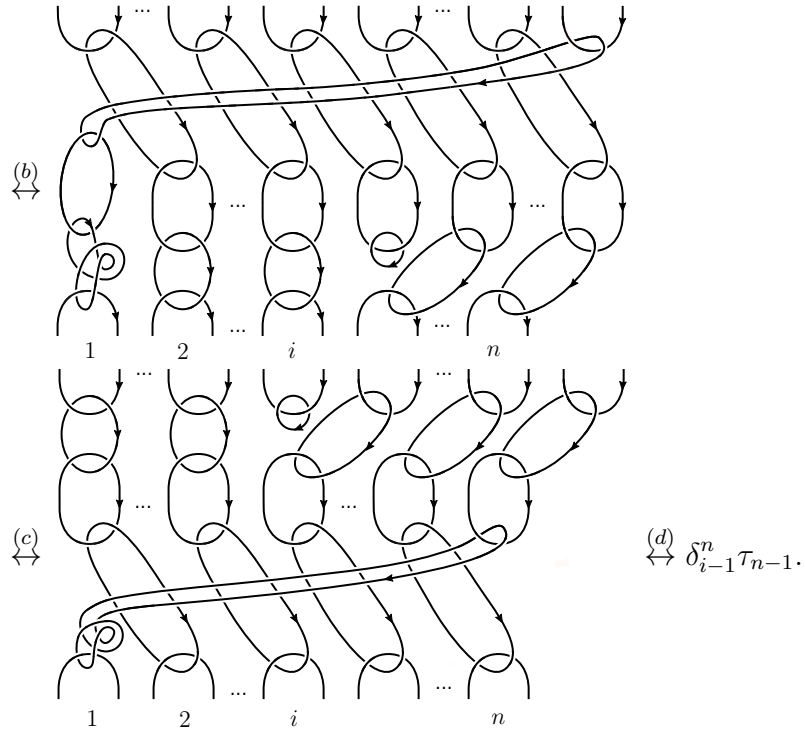

Here (a) and (d) follow from definitions and Lemma 3.1, (b) by isotopy, (c) follows from Lemma 4.4 (3) and by isotopy. The remaining cases are proven similarly.

We further show the relation (6). Assume that  $1 \leq j \leq n$ . We have:

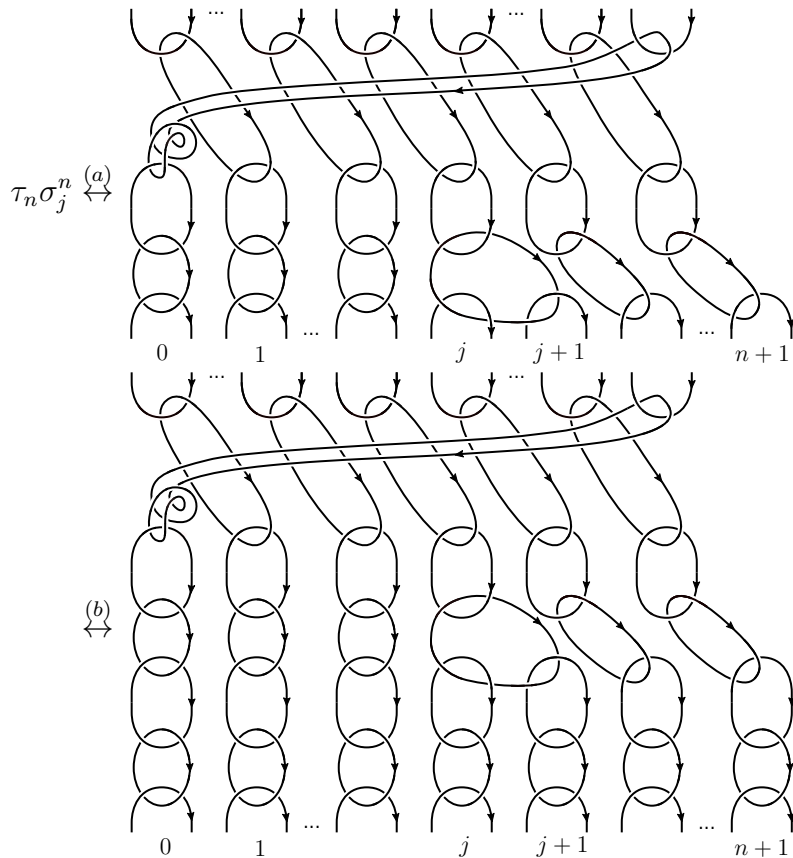



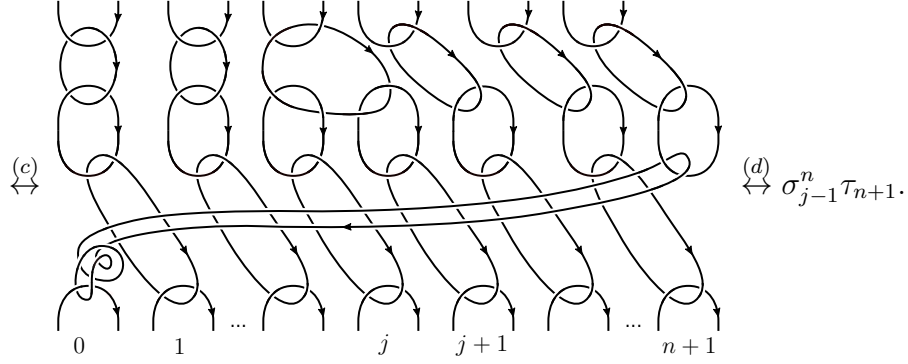

Here (a) and (d) follow from the definition and Lemma 3.1, (b) follows from Lemma 3.1 and the fact that the graph from equation (12) represents the identity cobordism, (c) follows by applying the parts (2) and (5) of Lemma 4.4 and isotopy.

Finally, we check the relation (8) in the case  $n = 1$ . The general case is proven by the similar reasoning. We have:

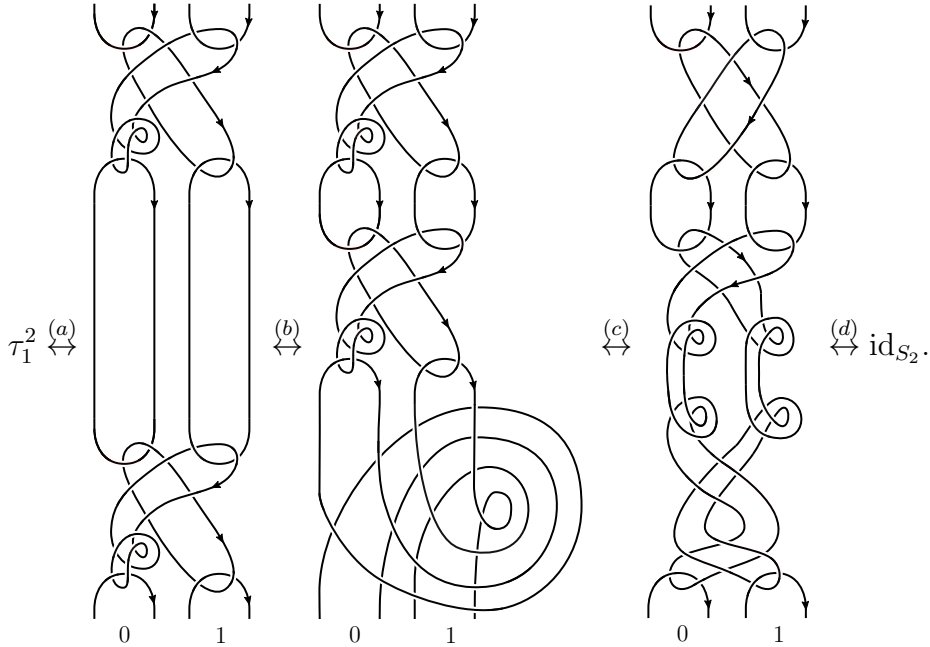

Here (a) follows from definition and Lemma 3.1, (b) follows by the **TWIST** move, (c) follows by isotopy, (d) follows by isotopy, Lemma 3.1, and presentation of the identity cobordism, as depicted in (12). This finishes the proof of Lemma 4.3.  $\square$

**4B. The construction  $Y_\bullet$ .** Recall the standard surface  $S_g$  (see Section 3E) of genus  $g$ . For  $n \in \mathbb{N}$ , set  $Y_n = S_{n+1}$ . For  $n \in \mathbb{N}^*$  and  $0 \leq i \leq n$ , the face  $Y_\bullet(d_i^n): S_{n+1} \rightarrow S_n$  is the cobordism class presented by the special ribbon graph  $G_{Y_\bullet(d_i^n)}$ :

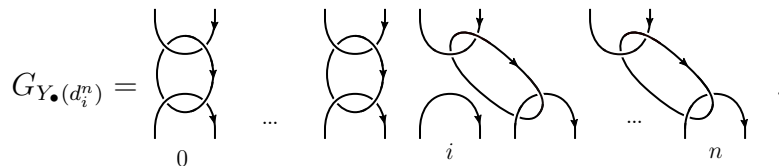

Let  $n \in \mathbb{N}$  and  $0 \leq j \leq n$ . The morphism  $Y_{\bullet}(s_j^n): S_{n+1} \rightarrow S_{n+2}$  is the cobordism class presented by the special ribbon graph  $G_{Y_{\bullet}(s_j^n)}$ :

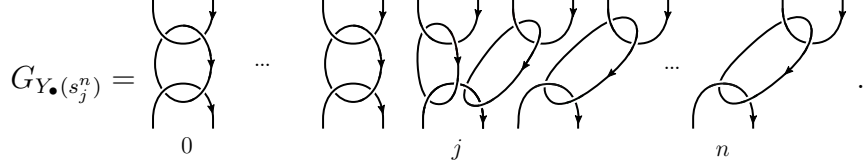

The morphism  $Y_{\bullet}(t_0): S_1 \rightarrow S_1$  equals the identity map  $\text{id}_{S_1}$ , which is represented by the graph  $I_1$  depicted in (12). For  $n \in \mathbb{N}^*$ , the morphism  $Y_{\bullet}(t_n): S_{n+1} \rightarrow S_{n+1}$  is the cobordism class presented by the special ribbon graph  $G_{Y_{\bullet}(t_n)}$ :

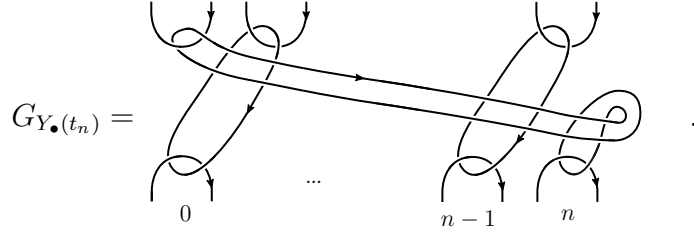

The proof of Theorem 4.1 in this case is similar to the proof of its version with  $X^{\bullet}$ , which is detailed in Section 4A. Namely, we have the following lemma:

**Lemma 4.5.** *The family  $Y_{\bullet} = \{S_{n+1}\}_{n \in \mathbb{N}}$ , equipped with the faces  $\{Y_{\bullet}(d_i^n)\}_{n \in \mathbb{N}^*, 0 \leq i \leq n}$ , the degeneracies  $\{Y_{\bullet}(s_j^n)\}_{n \in \mathbb{N}, 0 \leq j \leq n}$ , and the cyclic operators  $\{Y_{\bullet}(t_n)\}_{n \in \mathbb{N}}$  is a cyclic object in  $\mathbf{Cob}_3$ .*

To prove Lemma 4.5, one uses the following result, which is analogous to Lemma 4.4:

**Lemma 4.6.** *One has the following moves on special ribbon graphs:*

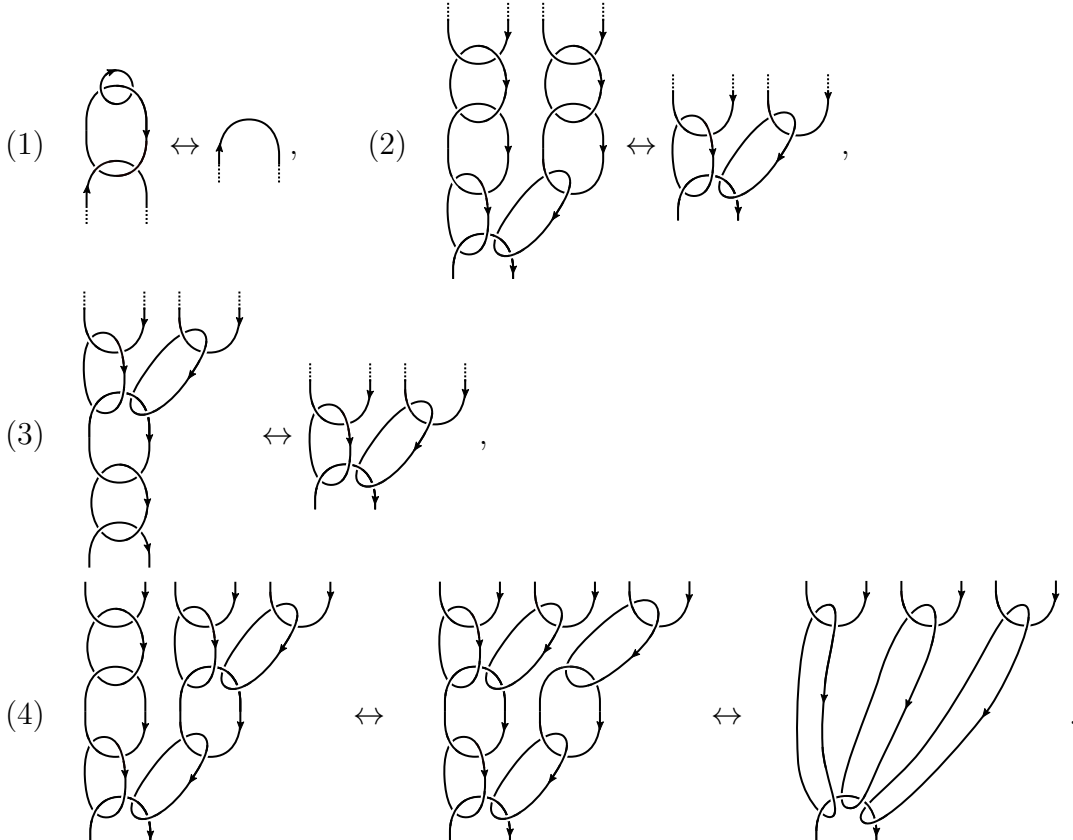

**4C. Passing to  $X^\bullet$  and  $X_\bullet$ .** Let  $\{\Sigma_{n+1}\}_{n \geq 0}$  be any family of closed oriented surfaces. By the classification theorem, for each  $n$  there exists an orientation preserving homeomorphism  $f_n: \Sigma_{n+1} \rightarrow S_{n+1}$ . Denote by  $\text{Cyl}(f_n): \Sigma_{n+1} \rightarrow S_{n+1}$  the associated morphism in  $\mathbf{Cob}_3$ , given by the quadruple

$$\text{Cyl}(f_n) = (C_{S_{n+1}} = S_{n+1} \times [0, 1], h_n: (-\Sigma_{n+1}) \sqcup S_{n+1} \rightarrow \partial(C_{S_{n+1}}), \Sigma_{n+1}, S_{n+1}),$$

where  $h_n(x) = (f_n(x), 0)$ , if  $x \in \Sigma_{n+1}$  and  $h_n(x) = (x, 1)$ , if  $x \in S_{n+1}$ . It follows from [31, Chapter IV, Section 5.1.], that the cobordism  $\text{Cyl}(f_n)$  is determined up to isotopy.

We pass from  $Y^\bullet$  to the cocyclic object  $X^\bullet$  in  $\mathbf{Cob}_3$  as follows. For any  $n \in \mathbb{N}$ , define  $X^n = \Sigma_{n+1}$ . Next, the cofaces  $\{X^\bullet(\delta_i^n): \Sigma_n \rightarrow \Sigma_{n+1}\}_{n \in \mathbb{N}^*, 0 \leq i \leq n}$ , the codegeneracies  $\{X^\bullet(\sigma_j^n): \Sigma_{n+2} \rightarrow \Sigma_{n+1}\}_{n \in \mathbb{N}, 0 \leq j \leq n}$ , and the cocyclic operators  $\{X^\bullet(\tau_n): \Sigma_{n+1} \rightarrow \Sigma_{n+1}\}_{n \in \mathbb{N}}$  are defined by formulas

$$\begin{aligned} X^\bullet(\delta_i^n) &= (\text{Cyl}(f_n))^{-1} Y^\bullet(\delta_i^n) \text{Cyl}(f_{n-1}), \\ X^\bullet(\sigma_j^n) &= (\text{Cyl}(f_n))^{-1} Y^\bullet(\sigma_j^n) \text{Cyl}(f_{n+1}), \\ X^\bullet(\tau_n) &= (\text{Cyl}(f_n))^{-1} Y^\bullet(\tau_n) \text{Cyl}(f_n). \end{aligned}$$

It follows from definitions that the family of cylinders  $\{\text{Cyl}(f_n): \Sigma_{n+1} \rightarrow S_{n+1}\}_{n \in \mathbb{N}}$  is a natural isomorphism between cocyclic objects  $X^\bullet$  and  $Y^\bullet$  in  $\mathbf{Cob}_3$ . One similarly passes from  $Y_\bullet$  to a cyclic object  $X_\bullet$  in  $\mathbf{Cob}_3$ .  $\square$

## 5. PRELIMINARIES ON MONOIDAL CATEGORIES AND HOPF ALGEBRAS

In this section we recall some algebraic preliminaries on ribbon categories and their graphical calculus as well as categorical Hopf algebras and related concepts. For more details, see [32].

**5A. Conventions.** In what follows, we suppress in our formulas the associativity and unitality constraints of the monoidal category. We denote by  $\otimes$  and  $\mathbb{1}$  the monoidal product and unit object of a monoidal category. For any objects  $X_1, \dots, X_n$  of a monoidal category with  $n \geq 2$ , we set

$$X_1 \otimes X_2 \otimes \dots \otimes X_n = (\dots((X_1 \otimes X_2) \otimes X_3) \otimes \dots \otimes X_{n-1}) \otimes X_n$$

and similarly for morphisms. A monoidal category is  $\mathbb{k}$ -linear, if its Hom sets have a structure of a  $\mathbb{k}$ -module such that the composition and monoidal product of morphisms are  $\mathbb{k}$ -bilinear. For shortness, we often use the term monoidal  $\mathbb{k}$ -category.

**5B. Braided categories.** A *braiding* of a monoidal category  $(\mathcal{B}, \otimes, \mathbb{1})$  is a family  $\tau = \{\tau_{X,Y}: X \otimes Y \rightarrow Y \otimes X\}_{X,Y \in \text{Ob}(\mathcal{B})}$  of natural isomorphisms such that

$$\begin{aligned} \tau_{X,Y \otimes Z} &= (\text{id}_Y \otimes \tau_{X,Z})(\tau_{X,Y} \otimes \text{id}_Z) \text{ and} \\ \tau_{X \otimes Y,Z} &= (\tau_{X,Z} \otimes \text{id}_Y)(\text{id}_X \otimes \tau_{Y,Z}) \end{aligned}$$

for all  $X, Y, Z \in \text{Ob}(\mathcal{B})$ . Note that the above axioms imply that  $\tau_{X,\mathbb{1}} = \tau_{\mathbb{1},X} = \text{id}_X$  for any  $X \in \text{Ob}(\mathcal{B})$ . A *braided category* is a monoidal category endowed with a braiding. A braiding  $\tau$  of  $\mathcal{B}$  is *symmetric* if for all  $X, Y \in \text{Ob}(\mathcal{B})$ ,

$$\tau_{Y,X} \tau_{X,Y} = \text{id}_{X \otimes Y}.$$

A *symmetric category* is a monoidal category endowed with a symmetric braiding. For example, the category of left  $\mathbb{k}$ -modules is symmetric.

**5C. Braided categories with a twist.** A *twist* for a braided monoidal category  $\mathcal{B}$  is a natural isomorphism  $\theta = \{\theta_X: X \rightarrow X\}_{X \in \text{Ob}(\mathcal{B})}$  such that for all  $X, Y \in \text{Ob}(\mathcal{B})$ ,

$$\theta_{X \otimes Y} = \tau_{Y, X} \tau_{X, Y} (\theta_X \otimes \theta_Y). \quad (15)$$

Note that this implies  $\theta_{\mathbb{1}} = \text{id}_{\mathbb{1}}$ . By a *braided category with a twist*, we mean a braided category endowed with a twist. For example, the family  $\{\text{id}_X: X \rightarrow X\}_{X \in \text{Ob}(\mathcal{B})}$  is a twist for  $\mathcal{B}$  if and only if  $\mathcal{B}$  is symmetric. Also, any ribbon category (see Section 5F) has a canonical twist.

**5D. Graphical calculus.** In this paper, we use the *Penrose graphical calculus*, which allows us to avoid lengthy algebraic computations by using simple topological arguments. The diagrams read from bottom to top. In a monoidal category  $\mathcal{B}$ , the diagrams are made of arcs colored by objects of  $\mathcal{B}$  and of boxes, colored by morphisms of  $\mathcal{B}$ . Arcs colored by  $\mathbb{1}$  may be omitted in the pictures. The identity morphism of an object  $X$ , a morphism  $f: X \rightarrow Y$  in  $\mathcal{B}$ , and its composition with a morphism  $g: Y \rightarrow Z$  in  $\mathcal{B}$  are represented respectively as

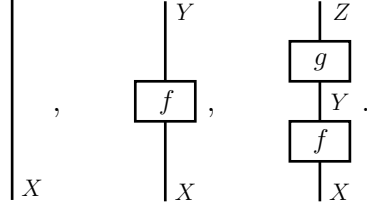

The tensor product of two morphisms  $f: X \rightarrow Y$  and  $g: U \rightarrow V$  is represented by placing a picture of  $f$  to the left of the picture of  $g$ :

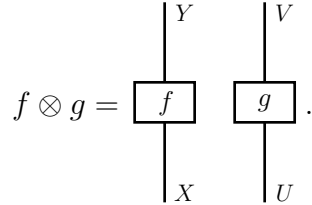

Any diagram represents a morphism. The latter depends only on the isotopy class of the diagram representing it. For example, the *level-exchange property*

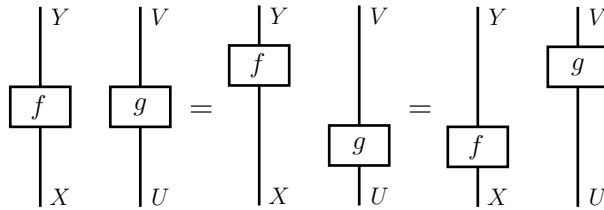

reflects the formula

$$f \otimes g = (f \otimes \text{id}_V)(\text{id}_X \otimes g) = (\text{id}_Y \otimes g)(f \otimes \text{id}_U).$$

When  $\mathcal{B}$  is braided with a braiding  $\tau$ , we depict

$$\tau_{X, Y} = \begin{array}{c} Y \quad X \\ \diagdown \quad \diagup \\ X \quad Y \end{array} \quad \text{and} \quad \tau_{X, Y}^{-1} = \begin{array}{c} X \quad Y \\ \diagup \quad \diagdown \\ Y \quad X \end{array}.$$

When  $\mathcal{B}$  is a braided category with a twist  $\theta = \{\theta_X: X \rightarrow X\}_{X \in \text{Ob}(\mathcal{B})}$ , we depict

$$\theta_X = \begin{array}{c} \text{---} \\ | \\ \text{---} \\ \text{---} \\ | \\ X \end{array} \quad \text{and} \quad (\theta_X)^{-1} = \begin{array}{c} \text{---} \\ | \\ \text{---} \\ \text{---} \\ | \\ X \end{array}.$$

For example, the defining condition (15) for the twist says that for all  $X, Y \in \text{Ob}(\mathcal{B})$ ,

$$\begin{array}{c} \text{---} \\ | \\ \text{---} \\ \text{---} \\ | \\ X \otimes Y \end{array} = \begin{array}{c} \text{---} \\ | \\ \text{---} \\ \text{---} \\ | \\ X \end{array} \begin{array}{c} \text{---} \\ | \\ \text{---} \\ \text{---} \\ | \\ Y \end{array}.$$

We warn the reader that this notation should not be confused with notation of a left twist in a ribbon category (see Section 5F). We made this choice of notation since any ribbon category is a particularly important example of a braided category with a twist.

**5E. Pivotal categories.** A *pivotal category* is a monoidal category  $\mathcal{C}$  such that to any object  $X$  of  $\mathcal{C}$  is associated a dual object  $X^* \in \text{Ob}(\mathcal{C})$  and four morphisms

$$\begin{aligned} \text{ev}_X: X^* \otimes X &\rightarrow \mathbb{1}, & \text{coev}_X: \mathbb{1} &\rightarrow X \otimes X^*, \\ \widetilde{\text{ev}}_X: X \otimes X^* &\rightarrow \mathbb{1}, & \widetilde{\text{coev}}_X: \mathbb{1} &\rightarrow X^* \otimes X, \end{aligned}$$

satisfying several conditions and such that the so called left and right duality functors coincide as monoidal functors. The latter implies in particular that the dual morphism  $f^*: Y^* \rightarrow X^*$  of a morphism  $f: X \rightarrow Y$  in  $\mathcal{C}$  is computed by

$$\begin{aligned} f^* &= (\text{id}_{X^*} \otimes \widetilde{\text{ev}}_Y)(\text{id}_{X^*} \otimes f \otimes \text{id}_{Y^*})(\widetilde{\text{coev}}_X \otimes \text{id}_{Y^*}) = \\ &= (\text{ev}_Y \otimes \text{id}_{X^*})(\text{id}_{Y^*} \otimes f \otimes \text{id}_{X^*})(\text{id}_{Y^*} \otimes \text{coev}_X). \end{aligned}$$

The graphical calculus for monoidal categories from Section 5D is extended to pivotal categories by orienting arcs. If an arc colored by  $X$  is oriented upwards, the represented object in source/target of corresponding morphism is  $X^*$ . For example,  $\text{id}_X, \text{id}_{X^*}$ , and a morphism  $f: X \otimes Y^* \otimes Z \rightarrow U \otimes V^*$  are depicted by

$$\text{id}_X = \begin{array}{c} \downarrow \\ | \\ X \end{array}, \quad \text{id}_{X^*} = \begin{array}{c} \uparrow \\ | \\ X \end{array} = \begin{array}{c} \downarrow \\ | \\ X^* \end{array}, \quad f = \begin{array}{c} \downarrow U \quad \uparrow V \\ \boxed{f} \\ \downarrow X \quad \uparrow Y \quad \downarrow Z \end{array}.$$

The morphisms  $\text{ev}_X, \widetilde{\text{ev}}_X, \text{coev}_X$ , and  $\widetilde{\text{coev}}_X$  are respectively depicted by

$$\begin{array}{c} \curvearrowright \\ \text{---} \\ X \end{array}, \quad \begin{array}{c} \curvearrowleft \\ \text{---} \\ X \end{array}, \quad \begin{array}{c} \text{---} \\ \curvearrowright \\ X \end{array}, \quad \begin{array}{c} \text{---} \\ \curvearrowleft \\ X \end{array}.$$

**5F. Ribbon categories.** Let  $\mathcal{B}$  be a braided pivotal category. The *left twist* of an object  $X$  of  $\mathcal{B}$  is defined by

$$\theta_X^l = \begin{array}{c} \text{---} \\ | \\ \text{---} \\ \text{---} \\ | \\ X \end{array} = (\text{id}_X \otimes \widetilde{\text{ev}}_X)(\tau_{X,X} \otimes \text{id}_{X^*})(\text{id}_X \otimes \text{coev}_X): X \rightarrow X,$$

while the *right twist* of  $X$  is defined by

$$\theta_X^r = \begin{array}{c} \text{---} \\ | \\ \text{---} \\ \text{---} \\ | \\ X \end{array} = (\text{ev}_X \otimes \text{id}_X)(\text{id}_{X^*} \otimes \tau_{X,X})(\widetilde{\text{coev}}_X \otimes \text{id}_X): X \rightarrow X.$$

The left and the right twist are natural isomorphisms with inverses

$$(\theta_X^l)^{-1} = \begin{array}{c} \text{---} \\ \diagdown \\ \text{---} \\ \downarrow \\ X \end{array} \quad \text{and} \quad (\theta_X^r)^{-1} = \begin{array}{c} \text{---} \\ \diagup \\ \text{---} \\ \downarrow \\ X \end{array} .$$

A *ribbon category* is a braided pivotal category  $\mathcal{B}$  such that  $\theta_X^l = \theta_X^r$  for all  $X \in \text{Ob}(\mathcal{B})$ . In this case, the family  $\theta = \{\theta_X = \theta_X^l = \theta_X^r : X \rightarrow X\}_{X \in \text{Ob}(\mathcal{B})}$  is a twist in the sense of Section 5C and is called the *twist* of  $\mathcal{B}$ .

**5G. Colored ribbon graphs.** Let  $\mathcal{B}$  be a ribbon category. A ribbon graph  $\Gamma$  (recall Section 3D) is  $\mathcal{B}$ -*colored* if each arc and circle of  $\Gamma$  is endowed with an object of  $\mathcal{B}$  and each coupon of  $\Gamma$  is endowed with a morphism in  $\mathcal{B}$  from the object determined by its bottom base (as in Section 5D) to the object determined by its top base. By [31, Theorem 2.5], any  $\mathcal{B}$ -colored ribbon graph determines a morphism in  $\mathcal{B}$ . The colors of  $\mathcal{B}$ -colored ribbon graphs are shown on their diagrams. For example, given objects  $X, Y, Z, T \in \text{Ob}(\mathcal{B})$  and a morphism  $f : Y^* \otimes X \rightarrow Z$  in  $\mathcal{B}$ , the diagram

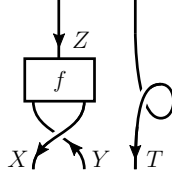

represents a  $\mathcal{B}$ -colored ribbon (3,2)-graph whose associated morphism in  $\mathcal{B}$  is

$$(f \circ \tau_{X, Y^*}) \otimes \theta_T : X \otimes Y^* \otimes T \rightarrow Z \otimes T.$$

Here,  $\tau$  and  $\theta$  are the braiding and the twist of  $\mathcal{B}$ .

**5H. Categorical traces and dimensions.** Let  $\mathcal{C}$  be a pivotal category. The *left trace*  $\text{tr}_l(f)$  and the *right trace*  $\text{tr}_r(f)$  of a morphism  $f : X \rightarrow X$  in  $\mathcal{C}$ , are respectively defined as

$$\begin{aligned} \text{tr}_l(f) &= \text{ev}_X(\text{id}_{X^*} \otimes f) \widetilde{\text{coev}}_X \in \text{End}(\mathbb{1}) \quad \text{and} \\ \text{tr}_r(f) &= \widetilde{\text{ev}}_X(f \otimes \text{id}_{X^*}) \text{coev}_X \in \text{End}(\mathbb{1}). \end{aligned}$$

The left dimension  $\text{dim}_l(X)$  and the right dimension  $\text{dim}_r(X)$  of an object  $X$  of  $\mathcal{C}$  are respectively defined as

$$\text{dim}_l(X) = \text{tr}_l(\text{id}_X) \quad \text{and} \quad \text{dim}_r(X) = \text{tr}_r(\text{id}_X).$$

**5I. Spherical categories.** A *spherical category* is a pivotal category  $\mathcal{C}$  such that left and right trace of any endomorphism in  $\mathcal{C}$  coincide. In particular,  $\text{dim}_l(X) = \text{dim}_r(X)$  holds for all  $X \in \text{Ob}(\mathcal{C})$ . In a spherical category, we omit  $l$  and  $r$  from the notation for trace and dimension. Any ribbon category is spherical (see [32, Corollary 3.4.]).

**5J. (Pre)fusion categories.** An object  $X$  of a  $\mathbb{k}$ -linear category  $\mathcal{C}$  is *simple* if the  $\mathbb{k}$ -module  $\text{End}_{\mathcal{C}}(X)$  is free of rank 1. In that case, the map  $\mathbb{k} \rightarrow \text{End}_{\mathcal{C}}(X)$ ,  $k \mapsto k \text{id}_X$  is an isomorphism of  $\mathbb{k}$ -algebras.

A *prefusion  $\mathbb{k}$ -category* is a monoidal  $\mathbb{k}$ -linear category  $\mathcal{C}$  such that there is a set  $I$  of simple objects of  $\mathcal{C}$  satisfying the following conditions:

- (a) For any distinct elements  $i, j$  of  $I$ ,  $\text{Hom}_{\mathcal{C}}(i, j) = 0$ ;
- (b) The unit object  $\mathbb{1}$  of  $\mathcal{C}$  is an element of  $I$ ;
- (c) Any object of  $\mathcal{C}$  is a finite direct sum of elements of  $I$ .

The set  $I$  is called a *representative set of simple objects* of  $\mathcal{C}$ . A *fusion  $\mathbb{k}$ -category* is a rigid prefusion  $\mathbb{k}$ -category such that the set of isomorphism classes of simple objects is finite.

**5K. Dimension of a fusion category.** Let  $\mathcal{C}$  be a pivotal fusion  $\mathbb{k}$ -category. We identify  $\mathbb{k}$  and  $\text{End}_{\mathcal{C}}(\mathbb{1})$  via the  $\mathbb{k}$ -linear isomorphism  $k \mapsto k\text{id}_{\mathbb{1}}$ . Pick a representative set  $I$  of simple objects of  $\mathcal{C}$ . The *dimension of the category*  $\mathcal{C}$  is an element of  $\text{End}_{\mathcal{C}}(\mathbb{1}) \cong \mathbb{k}$  defined by

$$\dim(\mathcal{C}) = \sum_{i \in I} \dim_l(i) \dim_r(i).$$

The dimension of  $\mathcal{C}$  does not depend on the choice of  $I$  since isomorphic objects of  $\mathcal{C}$  have the same left/right dimensions. Note that if  $\mathcal{C}$  is spherical, then

$$\dim(\mathcal{C}) = \sum_{i \in I} (\dim(i))^2.$$

**5L. Modular categories.** Let  $\mathcal{C}$  be a ribbon fusion  $\mathbb{k}$ -category. Pick a representative set  $I$  of simple objects of  $\mathcal{C}$ . The scalars

$$\Delta_{\pm} = \sum_{i \in I} \dim(i) \text{tr}(\theta_i^{\pm 1}) \in \text{End}_{\mathcal{C}}(\mathbb{1}) \cong \mathbb{k},$$

where  $\theta$  is the twist of  $\mathcal{C}$ , do not depend on the choice of  $I$ . The *S-matrix*  $[S_{i,j}]_{i,j \in I}$  of  $\mathcal{C}$  is defined by

$$S_{i,j} = \text{tr}(\tau_{i,j} \tau_{j,i}) \in \text{End}_{\mathcal{C}}(\mathbb{1}) \cong \mathbb{k}.$$

Note that the invertibility of  $S$  does not depend on the choice of  $I$ .

A *modular  $\mathbb{k}$ -category* is a ribbon fusion  $\mathbb{k}$ -category whose  $S$ -matrix is invertible. The scalars  $\Delta_+$ ,  $\Delta_-$ , and  $\dim(\mathcal{C})$  associated with a modular  $\mathbb{k}$ -category  $\mathcal{C}$  are invertible in  $\mathbb{k}$  and are related by  $\dim(\mathcal{C}) = \Delta_- \Delta_+$  (see [31, p. 89]). A modular  $\mathbb{k}$ -category is *anomaly free* if  $\Delta_+ = \Delta_-$ .

**5M. Categorical algebras.** An *algebra* in a monoidal category  $\mathcal{C}$  is a triple  $(A, m, u)$ , where  $A$  is an object of  $\mathcal{C}$ ,  $m: A \otimes A \rightarrow A$  and  $u: \mathbb{1} \rightarrow A$  are morphisms in  $\mathcal{C}$ , called *multiplication* and *unit* respectively, which satisfy

$$m(m \otimes \text{id}_A) = m(\text{id}_A \otimes m) \quad \text{and} \quad m(u \otimes \text{id}_A) = \text{id}_A = m(\text{id}_A \otimes u).$$

The multiplication and the unit are depicted by

$$\begin{array}{c} | \\ \cup \\ \hline A \end{array} \quad \text{and} \quad \begin{array}{c} | \\ \circ \\ \hline A \end{array}.$$

An *algebra morphism* between two algebras  $(A, m_A, u_A)$  and  $(B, m_B, u_B)$  in a monoidal category  $\mathcal{C}$  is a morphism  $f: A \rightarrow B$  in  $\mathcal{C}$  such that  $f m_A = m_B(f \otimes f)$  and  $f u_A = u_B$ .

**5N. Categorical coalgebras.** A *coalgebra* in a monoidal category  $\mathcal{C}$  is a triple  $(C, \Delta, \varepsilon)$ , where  $C$  is an object of  $\mathcal{C}$ ,  $\Delta: C \rightarrow C \otimes C$  and  $\varepsilon: C \rightarrow \mathbb{1}$  are morphisms in  $\mathcal{C}$ , called *comultiplication* and *counit* respectively, which satisfy

$$(\Delta \otimes \text{id}_C) \Delta = (\text{id}_C \otimes \Delta) \Delta \quad \text{and} \quad (\text{id}_C \otimes \varepsilon) \Delta = \text{id}_C = (\varepsilon \otimes \text{id}_C) \Delta.$$

The comultiplication and the counit are depicted by

$$\begin{array}{c} \cup \\ | \\ \hline C \end{array} \quad \text{and} \quad \begin{array}{c} \circ \\ | \\ \hline C \end{array}.$$

A *coalgebra morphism* between two coalgebras  $(C, \Delta_C, \varepsilon_C)$  and  $(D, \Delta_D, \varepsilon_D)$  in a monoidal category  $\mathcal{C}$  is a morphism  $f: C \rightarrow D$  in  $\mathcal{C}$  such that  $\Delta_D f = (f \otimes f) \Delta_C$  and  $\varepsilon_D f = \varepsilon_C$ .

**5O. Categorical bialgebras.** A *bialgebra* in a braided monoidal category  $\mathcal{B}$  is a quintuple  $(A, m, u, \Delta, \varepsilon)$  such that  $(A, m, u)$  is an algebra in  $\mathcal{B}$ ,  $(A, \Delta, \varepsilon)$  is a coalgebra in  $\mathcal{B}$ , and such that the following additional relations hold:

$$\Delta m = (m \otimes m)(\text{id}_A \otimes \tau_{A,A} \otimes \text{id}_A)(\Delta \otimes \Delta), \quad \varepsilon m = \varepsilon \otimes \varepsilon, \quad \Delta u = u \otimes u, \quad \text{and} \quad \varepsilon u = \text{id}_{\mathbb{1}}.$$

A *bialgebra morphism* between two bialgebras  $A$  and  $B$  in a braided monoidal category  $\mathcal{B}$  is a morphism  $A \rightarrow B$  in  $\mathcal{B}$ , which is both an algebra and a coalgebra morphism.

**5P. Categorical Hopf algebras.** A *Hopf algebra* in a braided monoidal category  $\mathcal{B}$  is a sextuple  $(A, m, u, \Delta, \varepsilon, S)$ , where  $(A, m, u, \Delta, \varepsilon)$  is a bialgebra in  $\mathcal{B}$  and  $S: A \rightarrow A$  is an isomorphism in  $\mathcal{B}$ , called the *antipode*, which satisfies the equation

$$m(S \otimes \text{id}_A)\Delta = u\varepsilon = m(\text{id}_A \otimes S)\Delta.$$

The antipode and its inverse are depicted by

$$\begin{array}{c} | \\ \oplus \\ | \\ A \end{array} \quad \text{and} \quad \begin{array}{c} | \\ \ominus \\ | \\ A \end{array} .$$

A *Hopf algebra morphism* between two Hopf algebras is a bialgebra morphism between them.

**5Q. Integrals and cointegrals.** Consider a bialgebra  $(A, m, \Delta, u, \varepsilon)$  in a braided category  $\mathcal{B}$ . A *left* (respectively *right*) *integral* of  $A$  is a morphism  $\Lambda: \mathbb{1} \rightarrow A$  in  $\mathcal{B}$  such that

$$m(\text{id}_A \otimes \Lambda) = \Lambda\varepsilon, \quad \text{respectively} \quad m(\Lambda \otimes \text{id}_A) = \Lambda\varepsilon.$$

A *left* (respectively *right*) *cointegral* of  $A$  is a morphism  $\lambda: A \rightarrow \mathbb{1}$  in  $\mathcal{B}$  such that

$$(\text{id}_A \otimes \lambda)\Delta = u\lambda, \quad \text{respectively} \quad (\lambda \otimes \text{id}_A)\Delta = u\lambda.$$

**5R. Bialgebra pairings.** Let  $(A, m, u, \Delta, \varepsilon)$  be a bialgebra in a braided category  $\mathcal{B}$ . A *bialgebra pairing* for  $A$  is a morphism  $\omega: A \otimes A \rightarrow \mathbb{1}$  in  $\mathcal{B}$  such that:

$$\begin{aligned} \omega(m \otimes \text{id}_A) &= \omega(\text{id}_A \otimes \omega \otimes \text{id}_A)(\text{id}_{A \otimes A} \otimes \Delta), & \omega(u \otimes \text{id}_A) &= \varepsilon, \\ \omega(\text{id}_A \otimes m) &= \omega(\text{id}_A \otimes \omega \otimes \text{id}_A)(\Delta \otimes \text{id}_{A \otimes A}), & \omega(\text{id}_A \otimes u) &= \varepsilon. \end{aligned}$$

A bialgebra pairing  $\omega$  for  $A$  is *non-degenerate* if there exists a morphism  $\Omega: \mathbb{1} \rightarrow A \otimes A$  in  $\mathcal{B}$  such that

$$(\omega \otimes \text{id}_A)(\text{id}_A \otimes \Omega) = \text{id}_A \quad \text{and} \quad (\text{id}_A \otimes \omega)(\Omega \otimes \text{id}_A) = \text{id}_A.$$

The morphism  $\Omega$  is called the *inverse* of the pairing  $\omega$ . If  $A$  is Hopf algebra, the pairing  $\omega$  for the underlying bialgebra is called a *Hopf pairing*.

**5S. Coend of a category.** Let  $\mathcal{B}$  be a pivotal category. Let  $F_{\mathcal{B}}: \mathcal{B}^{\text{op}} \times \mathcal{B} \rightarrow \mathcal{B}$  be the functor defined by  $F_{\mathcal{B}}(X, Y) = X^* \otimes Y$ . A *dinatural transformation* from  $F_{\mathcal{B}}$  to an object  $D$  of  $\mathcal{B}$  is a function  $d$  that assigns to any object  $X$  of  $\mathcal{B}$  a morphism  $d_X: X^* \otimes X \rightarrow D$  such that for all morphisms  $f: X \rightarrow Y$  in  $\mathcal{B}$ ,

$$d_X(f^* \otimes \text{id}_X) = d_Y(\text{id}_{Y^*} \otimes f).$$

The *coend* of  $\mathcal{B}$ , if it exists, is a pair  $(\mathbb{F}, i)$  where  $\mathbb{F}$  is an object of  $\mathcal{B}$  and  $i$  is a dinatural transformation from  $F_{\mathcal{B}}$  to  $\mathbb{F}$ , which is universal among all dinatural transformations. More precisely, for any dinatural transformation  $d$  from  $F_{\mathcal{B}}$  to  $D$ , there exists a unique morphism  $\varphi: \mathbb{F} \rightarrow D$  in  $\mathcal{B}$  such that  $d_X = \varphi i_X$  for all  $X \in \text{Ob}(\mathcal{B})$ . A coend  $(\mathbb{F}, i)$  of a



category  $\mathcal{B}$ , if it exists, is unique up to a unique isomorphism commuting with the dinatural transformation. We depict the dinatural transformation  $i = \{i_X : X^* \otimes X \rightarrow \mathbb{F}\}_{X \in \text{Ob}(\mathcal{B})}$  as

$$i_X = \begin{array}{c} \downarrow \mathbb{F} \\ \text{---} \cdot \\ \uparrow X \end{array}.$$

An important factorization property is given in the following lemma.

**Lemma 5.1** (Fubini theorem for coends, [25]). *Let  $(\mathbb{F}, i)$  be a coend of a braided pivotal category  $\mathcal{B}$ . If  $d = \{d_{X_1, \dots, X_n} : X_1^* \otimes X_1 \otimes \dots \otimes X_n^* \otimes X_n \rightarrow D\}_{X_1, \dots, X_n \in \text{Ob}(\mathcal{B})}$  is a family of morphisms in  $\mathcal{B}$ , which is dinatural in each  $X_i$  for  $1 \leq i \leq n$ , then there exists a unique morphism  $\varphi : \mathbb{F}^{\otimes n} \rightarrow D$  in  $\mathcal{B}$  such that*

$$d_{X_1, \dots, X_n} = \varphi(i_{X_1} \otimes \dots \otimes i_{X_n})$$

for all  $X_1, \dots, X_n \in \text{Ob}(\mathcal{B})$ .

According to [23, 26], coend of a braided pivotal category  $\mathcal{B}$  is a Hopf algebra in  $\mathcal{B}$  endowed with a canonical Hopf pairing. Its unit is  $u = (\text{id}_{\mathbb{1}} \otimes i_{\mathbb{1}})(\text{coev}_{\mathbb{1}} \otimes \text{id}_{\mathbb{1}}) : \mathbb{1} \rightarrow \mathbb{F}$ . Multiplication  $m : \mathbb{F} \otimes \mathbb{F} \rightarrow \mathbb{F}$  and canonical pairing  $\omega : \mathbb{F} \otimes \mathbb{F} \rightarrow \mathbb{1}$  are unique morphisms such that for all  $X, Y \in \text{Ob}(\mathcal{B})$ ,

$$\begin{array}{c} \downarrow \mathbb{F} \\ \boxed{m} \\ \downarrow \mathbb{F} \quad \downarrow \mathbb{F} \\ \text{---} X \quad \text{---} Y \end{array} = \begin{array}{c} \downarrow \mathbb{F} \\ \text{---} \text{---} \\ \downarrow \mathbb{F} \quad \downarrow \mathbb{F} \\ \text{---} X \quad \text{---} Y \end{array} \begin{array}{c} \boxed{\text{id}_{Y \otimes X}} \\ \boxed{\text{id}_{Y \otimes X}} \end{array}, \quad \begin{array}{c} \boxed{\omega} \\ \downarrow \mathbb{F} \quad \downarrow \mathbb{F} \\ \text{---} X \quad \text{---} Y \end{array} = \begin{array}{c} \text{---} \text{---} \\ \downarrow \mathbb{F} \quad \downarrow \mathbb{F} \\ \text{---} X \quad \text{---} Y \end{array}.$$

Its comultiplication  $\Delta : \mathbb{F} \rightarrow \mathbb{F} \otimes \mathbb{F}$ , counit  $\varepsilon : \mathbb{F} \rightarrow \mathbb{1}$ , and antipode  $S : \mathbb{F} \rightarrow \mathbb{F}$  are unique morphisms such that for all  $X \in \text{Ob}(\mathcal{B})$ ,

$$\begin{array}{c} \downarrow \mathbb{F} \\ \boxed{\Delta} \\ \downarrow \mathbb{F} \\ \text{---} X \end{array} = \begin{array}{c} \downarrow \mathbb{F} \\ \text{---} \text{---} \\ \downarrow \mathbb{F} \quad \downarrow \mathbb{F} \\ \text{---} X \quad \text{---} X \end{array}, \quad \begin{array}{c} \boxed{\varepsilon} \\ \downarrow \mathbb{F} \\ \text{---} X \end{array} = \begin{array}{c} \text{---} \\ \downarrow \mathbb{F} \\ \text{---} X \end{array}, \quad \begin{array}{c} \downarrow \mathbb{F} \\ \boxed{S} \\ \downarrow \mathbb{F} \\ \text{---} X \end{array} = \begin{array}{c} \downarrow \mathbb{F} \\ \text{---} \text{---} \\ \downarrow \mathbb{F} \\ \text{---} X \end{array}.$$

Two useful properties of antipode of coend  $\mathbb{F}$  are

$$S^2 = \theta_{\mathbb{F}}^r \quad \text{and} \quad (16)$$

$$\omega(S \otimes \text{id}_{\mathbb{F}}) = \omega(\text{id}_{\mathbb{F}} \otimes S). \quad (17)$$

Also, we have by definitions of  $\omega$  and  $S$  that  $X, Y \in \text{Ob}(\mathcal{B})$ ,

$$\begin{array}{c} \boxed{\omega} \\ \oplus \downarrow \mathbb{F} \quad \downarrow \mathbb{F} \\ \text{---} X \quad \text{---} Y \end{array} = \begin{array}{c} \boxed{\omega} \\ \downarrow \mathbb{F} \quad \oplus \downarrow \mathbb{F} \\ \text{---} X \quad \text{---} Y \end{array} = \begin{array}{c} \text{---} \text{---} \\ \downarrow \mathbb{F} \quad \downarrow \mathbb{F} \\ \text{---} X \quad \text{---} Y \end{array}.$$

## 6. CYCLIC MODULES FROM (CO)ALGEBRAS

Let  $\mathcal{B}$  be a braided  $\mathbb{k}$ -linear category with a twist. In this section, we first review some (co)cyclic  $\mathbb{k}$ -modules from coalgebras and algebras in  $\mathcal{B}$ . Proofs can be found in [5], where these were merely (co)cyclic sets, since one dropped the hypothesis of  $\mathbb{k}$ -linearity of  $\mathcal{B}$ . Next, we outline some basic computations of cyclic (co)homology of some introduced

(co)cyclic  $\mathbb{k}$ -modules. Finally, in Section **6F**, we explicit (co)faces, (co)degeneracies, and (co)cyclic operators of (co)cyclic  $\mathbb{k}$ -vector spaces associated to the coend of the representation category of a finite dimensional ribbon Hopf algebra. For more details on Hochschild and cyclic (co)homology of (co)cyclic  $\mathbb{k}$ -modules, see [35, Section 9.6].

**6A. Cocyclic modules from coalgebras.** Any coalgebra  $C$  in  $\mathcal{B}$  gives rise to a cocyclic  $\mathbb{k}$ -module  $C^\bullet$  as follows. For any  $n \in \mathbb{N}$ , define  $C^n = \text{Hom}_{\mathcal{B}}(C^{\otimes n+1}, \mathbb{1})$ . Next, define the cofaces  $\{\delta_i^n: C^{n-1} \rightarrow C^n\}_{n \in \mathbb{N}^*, 0 \leq i \leq n}$ , the codegeneracies  $\{\sigma_j^n: C^{n+1} \rightarrow C^n\}_{n \in \mathbb{N}, 0 \leq j \leq n}$ , and the cocyclic operators  $\{\tau_n: C^n \rightarrow C^n\}_{n \in \mathbb{N}}$  by setting

$$\delta_i^n(f) = \begin{array}{c} \boxed{f} \\ \vdots \quad \circ \quad \vdots \\ \dots \quad i \quad \dots \\ 0 \quad \quad \quad n \end{array}, \quad \sigma_j^n(f) = \begin{array}{c} \boxed{f} \\ \text{---} \cup \text{---} \\ \vdots \quad \quad \quad \vdots \\ \dots \quad j \quad \dots \\ 0 \quad \quad \quad n \end{array}, \quad \tau_n(f) = \begin{array}{c} \boxed{f} \\ \text{---} \cup \text{---} \\ \vdots \quad \quad \quad \vdots \\ \dots \quad \quad \quad \dots \\ 0 \quad \quad \quad n-1 \quad n \end{array}.$$

An integer  $k$  below an arc denotes the  $k$ -th tensorand of a tensor power of  $C$ . This construction is functorial in  $C$ , that is, a morphism between coalgebras in  $\mathcal{B}$  induces the morphism of corresponding cocyclic  $\mathbb{k}$ -modules.

**6B. Cyclic modules from algebras.** Any algebra  $A$  in  $\mathcal{B}$  gives rise to a cyclic  $\mathbb{k}$ -module  $A_\bullet$  as follows. For any  $n \in \mathbb{N}$ , define  $A_n = \text{Hom}_{\mathcal{B}}(A^{\otimes n+1}, \mathbb{1})$ . Next, define the faces  $\{d_i^n: A_n \rightarrow A_{n-1}\}_{n \in \mathbb{N}^*, 0 \leq i \leq n}$ , the degeneracies  $\{s_j^n: A_n \rightarrow A_{n+1}\}_{n \in \mathbb{N}, 0 \leq j \leq n}$ , and cyclic operators  $\{t_n: A_n \rightarrow A_n\}_{n \in \mathbb{N}}$  by setting

$$d_0^n(f) = \begin{array}{c} \boxed{f} \\ \circ \quad \vdots \\ 0 \quad n-1 \end{array}, \quad d_i^n(f) = \begin{array}{c} \boxed{f} \\ \vdots \quad \circ \quad \vdots \\ \dots \quad i-1 \quad i \quad n-1 \end{array}, \quad d_n^n(f) = \begin{array}{c} \boxed{f} \\ \vdots \quad \circ \\ 0 \quad n-1 \end{array},$$

$$s_j^n(f) = \begin{array}{c} \boxed{f} \\ \text{---} \cup \text{---} \\ \vdots \quad \quad \quad \vdots \\ \dots \quad j \quad j+1 \quad n+1 \end{array}, \quad t_n(f) = \begin{array}{c} \boxed{f} \\ \text{---} \cup \text{---} \\ \rho \quad \vdots \quad \quad \quad \vdots \\ 0 \quad 1 \quad \dots \quad n \end{array}.$$

This construction is functorial in  $A$ , that is, a morphism between algebras in  $\mathcal{B}$  induces, in a functorial way, the morphism of corresponding cyclic  $\mathbb{k}$ -modules.

**6C. Cyclic duals.** The cyclic duality  $L$  from Section **2D** transforms the cocyclic  $\mathbb{k}$ -module  $C^\bullet$  from Section **6A** into the cyclic  $\mathbb{k}$ -module  $C^\bullet \circ L$ . For any  $n \in \mathbb{N}$ ,  $C^\bullet \circ L(n) = C^n = \text{Hom}_{\mathcal{B}}(C^{\otimes n+1}, \mathbb{1})$ . The faces  $\{\tilde{d}_i^n\}_{n \in \mathbb{N}^*, 0 \leq i \leq n}$ , the degeneracies  $\{\tilde{s}_j^n\}_{n \in \mathbb{N}, 0 \leq j \leq n}$ , and the cyclic operators  $\{\tilde{t}_n\}_{n \in \mathbb{N}}$  are computed by formulas

$$\tilde{d}_i^n(f) = \begin{array}{c} \boxed{f} \\ \text{---} \cup \text{---} \\ \vdots \quad \quad \quad \vdots \\ \dots \quad i+1 \quad \dots \\ 1 \quad \quad \quad n \end{array}, \quad \tilde{d}_n^n(f) = \begin{array}{c} \boxed{f} \\ \text{---} \cup \text{---} \\ \rho \quad \vdots \quad \quad \quad \vdots \\ 1 \quad \dots \quad n \end{array},$$

$$\tilde{s}_j^n(f) = \begin{array}{c} \boxed{f} \\ \vdots \quad \circ \quad \vdots \\ \dots \quad j+1 \quad \dots \\ 0 \quad \quad \quad n+1 \end{array}, \quad \tilde{t}_n(f) = \begin{array}{c} \boxed{f} \\ \text{---} \cup \text{---} \\ \rho \quad \vdots \quad \quad \quad \vdots \\ 0 \quad 1 \quad \dots \quad n \end{array}.$$

Similarly, the functor  $L^{\text{op}}$  transforms the cyclic  $\mathbb{k}$ -module  $A_\bullet$  from Section **6B** into the cocyclic  $\mathbb{k}$ -module  $A_\bullet \circ L^{\text{op}}$ . By definitions,  $A_\bullet \circ L^{\text{op}}(n) = A_n = \text{Hom}_{\mathcal{B}}(A^{\otimes n+1}, \mathbb{1})$  for

all  $n \in \mathbb{N}$ . The cofaces  $\{\tilde{\delta}_i^n\}_{n \in \mathbb{N}^*, 0 \leq i \leq n}$ , the codegeneracies  $\{\tilde{\sigma}_j^n\}_{n \in \mathbb{N}, 0 \leq j \leq n}$ , and the cocyclic operators  $\{\tilde{\tau}_n\}_{n \in \mathbb{N}}$  are computed by formulas

$$\begin{aligned} \tilde{\delta}_i^n(f) &= \begin{array}{c} \boxed{f} \\ \vdots \\ \text{---} \text{---} \text{---} \text{---} \\ \vdots \\ 0 \quad i \quad i+1 \quad n \end{array}, & \tilde{\delta}_n^n(f) &= \begin{array}{c} \boxed{f} \\ \vdots \\ \text{---} \text{---} \text{---} \text{---} \\ \vdots \\ 0 \quad \dots \quad n-1 \quad n \end{array}, \\ \tilde{\sigma}_j^n(f) &= \begin{array}{c} \boxed{f} \\ \vdots \\ \text{---} \text{---} \text{---} \text{---} \\ \vdots \\ 0 \quad \dots \quad j \quad j+1 \quad n \end{array}, & \tilde{\tau}_n(f) &= \begin{array}{c} \boxed{f} \\ \vdots \\ \text{---} \text{---} \text{---} \text{---} \\ \vdots \\ 0 \quad \dots \quad n-1 \quad n \end{array}. \end{aligned}$$

Note that the construction  $A_\bullet \circ L^{\text{op}}$  is a particular case of the work of Akrami and Majid [1] (since any algebra in a braided category with a twist is a ribbon algebra in the sense of [1]).

**6D. On the (co)homology of  $C^\bullet$  and  $C_\bullet$ .** Let  $\mathbb{k}$  be a commutative ring,  $\mathcal{B}$  a braided  $\mathbb{k}$ -category with a twist and  $C$  any coalgebra in  $\mathcal{B}$ . Let  $\alpha: \mathbb{1} \rightarrow C$  be a morphism such that  $\varepsilon\alpha = \text{id}_{\mathbb{1}}$ . For example, if  $C$  is a bialgebra in  $\mathcal{B}$ , then we can take  $\alpha$  to be the unit of  $C$ . By expanding and writing in the categorical setting [19, Remark 1.], we obtain that Hochschild (co)homology of underlying (co)simplicial modules of  $C^\bullet$  and  $C_\bullet$  appears only in degree zero. Indeed, the  $n$ -th Hochschild cohomology  $HH^n(C^\bullet)$  of  $C^\bullet$  is the  $n$ -th cohomology of the cochain complex

$$\text{Hom}_{\mathcal{B}}(C, \mathbb{1}) \xrightarrow{\beta_1} \text{Hom}_{\mathcal{B}}(C^{\otimes 2}, \mathbb{1}) \xrightarrow{\beta_2} \text{Hom}_{\mathcal{B}}(C^{\otimes 3}, \mathbb{1}) \xrightarrow{\beta_3} \dots$$

where  $\beta_n = \sum_{i=0}^n (-1)^i \delta_i^n$ . Then the family  $\{h_n: \text{Hom}_{\mathcal{B}}(C^{\otimes n+1}, \mathbb{1}) \rightarrow \text{Hom}_{\mathcal{B}}(C^{\otimes n}, \mathbb{1})\}_{n \in \mathbb{N}^*}$ , defined by setting for any  $f \in \text{Hom}_{\mathcal{B}}(C^{\otimes n+1}, \mathbb{1})$ ,

$$h_n(f) = \begin{array}{c} \boxed{f} \\ \vdots \\ \boxed{\alpha} \text{---} \text{---} \text{---} \text{---} \\ \vdots \\ 1 \quad \dots \quad n \end{array},$$

satisfies the equalities

$$\begin{aligned} \beta_n h_n + h_{n+1} \beta_{n+1} &= \text{id}_{\text{Hom}_{\mathcal{B}}(C^{\otimes n+1}, \mathbb{1})} \quad \text{for } n \geq 1 \quad \text{and} \\ h_1 \beta_1 + \text{Hom}_{\mathcal{B}}(\alpha\varepsilon, \mathbb{1}) &= \text{id}_{\text{Hom}_{\mathcal{B}}(C, \mathbb{1})}. \end{aligned}$$

As a corollary,  $HH^0(C^\bullet) = \ker(\beta_1)$  and  $HH^n(C^\bullet) = 0$  for  $n > 0$ . From the cohomological form of the Connes' long exact sequence [35, Proposition 9.6.11] and the fact that Hochschild and cyclic (co)homology always agree in degree 0, we easily obtain that  $HC^n(C^\bullet) \cong \ker(\beta_1)$  for even  $n$  and  $HC^n(C^\bullet) \cong 0$  for odd  $n$ . A similar statement can be derived for Hochschild and cyclic homologies of  $C_\bullet$ . This calculation shows that in a sense,  $C^\bullet$  and  $C_\bullet$  are not interesting from the homological point of view. Therefore, we focus on their cyclic duals in sections that follow.

**6E. Internal characters.** Let  $\mathcal{B}$  be a ribbon  $\mathbb{k}$ -category with a coend  $(\mathbb{F}, i)$ . For any object  $X \in \text{Ob}(\mathcal{B})$ , the morphism  $\chi_X = i_X \widetilde{\text{coev}}_X: \mathbb{1} \rightarrow \mathbb{F}$ , also known as internal character [14, 29], enjoys the following trace-like property:

$$\begin{array}{c} \text{Cup} \downarrow \chi_X \quad \stackrel{(a)}{=} \quad \text{Cup with twist} \downarrow \chi_X \quad \stackrel{(b)}{=} \quad \text{Cup with twist} \downarrow \chi_X \end{array} \quad (18)$$

Here (a) follows by definition of comultiplication of  $\mathbb{F}$ , naturality and definition of twists, braidings and the isotopy invariance of graphical calculus. Note that a pictorial proof of this fact is given in [6, page 22]. The equality (b) is obtained by composing both sides of (a) with  $\tau_{\mathbb{F}, \mathbb{F}}^{-1}(\text{id}_{\mathbb{F}} \otimes \theta_{\mathbb{F}}^{-1})$ .

Next, the morphism  $\psi_X = \omega(\chi_X \otimes \text{id}_{\mathbb{F}})$  satisfies

$$\begin{array}{c} \text{Cup} \downarrow \psi_X \quad = \quad \text{Cup with twist} \downarrow \psi_X \end{array} \quad (19)$$

Indeed, we have

Here (a) and (d) follow by the axioms of Hopf pairing  $\omega$ , (b) from the equation (18), (c) by equations (16), (17), naturality of braiding and isotopy.

In the case when  $\mathcal{B}$  is a ribbon fusion category with the representative set  $I$  of simple objects of  $\mathcal{B}$ , the family  $\{\chi_i\}_{i \in I}$  is a basis for  $\text{Hom}_{\mathcal{B}}(\mathbb{1}, \mathbb{F})$ . Next, if the pairing  $\omega$  is non-degenerate,  $\text{Hom}_{\mathcal{B}}(\mathbb{1}, \mathbb{F})$  is isomorphic to  $\text{Hom}_{\mathcal{B}}(\mathbb{F}, \mathbb{1})$  as  $\mathbb{k}$ -module. Combining this with the equation (19), we get that  $HC^0(\mathbb{F}_{\bullet} \circ L^{\text{op}}) = HH^0(\mathbb{F}_{\bullet} \circ L^{\text{op}}) = \text{Hom}_{\mathcal{B}}(\mathbb{F}, \mathbb{1})$ .

**Remark 6.1.** Let  $\mathbb{k}$  be an algebraically closed field and  $\mathcal{B}$  a finite tensor  $\mathbb{k}$ -category in the sense of [13] with the representative set  $I$  of simple objects. In particular,  $I$  is finite. By [29, Theorem 4.1.], the characters  $\{\chi_i\}_{i \in I}$  form a linearly independent set in  $\text{Hom}_{\mathcal{B}}(\mathbb{1}, \mathbb{F})$ . Under additional unimodularity hypothesis, it is also shown that  $\{\chi_i\}_{i \in I}$  is a basis for  $\text{Hom}_{\mathcal{B}}(\mathbb{1}, \mathbb{F})$  if and only if  $\mathcal{B}$  is semisimple. Note that Shimizu works with ends and not coends (see Appendix). However, these theories are essentially the same (see [29, Remark 3.12.]).

**6F. The coend of the representation category of a Hopf algebra.** Let  $\mathbb{k}$  be a field and  $H$  a finite dimensional ribbon Hopf algebra over  $\mathbb{k}$ . For the comultiplication, we will use the usual Sweedler notation, that is, one writes  $\Delta(h) = h_{(1)} \otimes h_{(2)}$  for any  $h \in H$ . Denote by  $R$  and  $\theta$  the  $R$ -matrix and the twist element of  $H$ . To recall these notions and their properties one may consult [34, sections 4.2-4.6], which we closely follow. We write

$$R = \sum_i a_i \otimes b_i \in H \otimes H \quad \text{and} \quad R^{-1} = \sum_i \alpha_i \otimes \beta_i \in H \otimes H.$$

The category  $\text{rep}_H$  is a ribbon category. Let  $\mathbb{F}$  be the coend of the category  $\text{rep}_H$ . As a vector space, it is equal to  $H^*$  and as a left  $H$ -module, it is given by the coadjoint action, that is, for all  $h \in H$  and  $f \in H^*$ ,

$$h \triangleright f = f(S(h_{(1)})h_{(2)}).$$

For  $n \in \mathbb{N}^*$ , consider the evaluation  $\text{ev}: H^{\otimes n} \rightarrow \text{Hom}_{\mathbb{k}}(H^{*\otimes n}, \mathbb{k})$  defined by setting for all  $X \in H^{\otimes n}$  and  $f \in H^{*\otimes n}$ ,

$$\text{ev}(X)(f) = \langle f, X \rangle.$$

Following [34, Lemma 4.5(d)], this evaluation induces an isomorphism between  $\mathbb{k}$ -vector spaces  $\text{Hom}_{\text{rep}_H}(\mathbb{F}^{\otimes n}, \mathbb{k})$  and

$$V_n(H) = \{X \in H^{\otimes n} \mid X \triangleleft h = \varepsilon(h)X \text{ for any } h \in H\}.$$

Here the right  $H$ -action  $\triangleleft$  on  $H^{\otimes n}$  is defined by setting for any  $h \in H$  and any elementary tensor  $X = x_1 \otimes \cdots \otimes x_n \in H^{\otimes n}$ ,

$$X \triangleleft h = S(h_{(1)})x_1h_{(2)} \otimes S(h_{(3)})x_2h_{(4)} \otimes \cdots \otimes S(h_{(2n-1)})x_nh_{(2n)}.$$

Remark that the vector space  $V_n(H)$  is equal to the 0-th classical Hochschild homology  $HH_0(H, H^{\otimes n})$  of  $H$  with coefficients in  $H^{\otimes n}$ , where  $H^{\otimes n}$  is the bimodule over  $H$  (the left action is given by trivial action via counit).

Under the above isomorphism between  $\text{Hom}_{\text{rep}_H}(\mathbb{F}^{\otimes n}, \mathbb{k})$  and  $V_n(H)$ , the cyclic  $\mathbb{k}$ -vector space  $\mathbb{F}^\bullet \circ L$  is identified with the cyclic  $\mathbb{k}$ -vector space  $\mathbf{W}_\bullet$  which is defined as follows. For any  $n \in \mathbb{N}$ , set  $\mathbf{W}_n = V_{n+1}(H)$ . The faces  $\{d_i^n: V_{n+1}(H) \rightarrow V_n(H)\}_{n \in \mathbb{N}^*, 0 \leq i \leq n}$  are given by setting for any elementary tensor  $h_1 \otimes \cdots \otimes h_{n+1} \in V_{n+1}(H)$ ,

$$\begin{aligned} d_i^n(h_1 \otimes \cdots \otimes h_{n+1}) &= h_1 \otimes h_2 \otimes \cdots \otimes h_{i+1}h_{i+2} \otimes \cdots \otimes h_{n+1} \quad \text{and} \\ d_n^n(h_1 \otimes \cdots \otimes h_{n+1}) &= \sum_i (h_{n+1} \triangleleft a_i\theta)(h_1 \triangleleft (b_i)_{(1)}) \otimes h_2 \triangleleft (b_i)_{(2)} \otimes \cdots \otimes h_n \triangleleft (b_i)_{(n)}. \end{aligned}$$

The degeneracies  $\{s_j^n: V_{n+1}(H) \rightarrow V_{n+2}(H)\}_{n \in \mathbb{N}, 0 \leq j \leq n}$  are given by setting for any elementary tensor  $h_1 \otimes \cdots \otimes h_{n+1} \in V_{n+1}(H)$ ,

$$s_j(h_1 \otimes \cdots \otimes h_{n+1}) = h_1 \otimes \cdots \otimes h_{j+1} \otimes 1_H \otimes h_{j+2} \otimes \cdots \otimes h_{n+1}.$$

The cyclic operators  $\{t_n: V_{n+1}(H) \rightarrow V_{n+1}(H)\}_{n \in \mathbb{N}}$  are given by setting for any elementary tensor  $h_1 \otimes \cdots \otimes h_{n+1} \in V_{n+1}(H)$ ,

$$t_n(h_1 \otimes \cdots \otimes h_{n+1}) = \sum_i h_{n+1} \triangleleft a_i\theta \otimes h_1 \triangleleft (b_i)_{(1)} \otimes \cdots \otimes h_n \triangleleft (b_i)_{(n)}.$$

Similarly, the cocyclic  $\mathbb{k}$ -vector space  $\mathbb{F}_\bullet \circ L^{\text{op}}$  is identified with the cocyclic  $\mathbb{k}$ -vector space  $\mathbf{W}^\bullet$  which is defined as follows. For any  $n \in \mathbb{N}$ , set  $\mathbf{W}^n = V_{n+1}(H)$ . The cofaces  $\{\delta_i^n: V_n(H) \rightarrow V_{n+1}(H)\}_{n \in \mathbb{N}^*, 0 \leq i \leq n}$  are given by setting for any elementary tensor  $h_1 \otimes \cdots \otimes h_n \in V_n(H)$ ,

$$\begin{aligned} \delta_i^n(h_1 \otimes \cdots \otimes h_n) &= h_1 \otimes h_2 \otimes \cdots \otimes \Delta^{\text{Bd}}(h_{i+1}) \otimes \cdots \otimes h_n \quad \text{and} \\ \delta_n^n(h_1 \otimes \cdots \otimes h_n) &= \sum_i (h_1)_{(2)}^{\text{Bd}} \triangleleft (\beta_i)_{(1)} \otimes h_2 \triangleleft (\beta_i)_{(2)} \otimes \cdots \otimes h_n \triangleleft (\beta_i)_{(n)} \otimes (h_1)_{(1)}^{\text{Bd}} \triangleleft (\alpha_i\theta^{-1}), \end{aligned}$$

where  $\Delta^{\text{Bd}}$  is a comultiplication on the braided Hopf algebra  $H^{\text{Bd}}$  (see [34, Lemma 4.4]) associated to  $H$ . As algebras  $H^{\text{Bd}} = H$ , but the comultiplication and antipode in  $H^{\text{Bd}}$  are different. Explicitly, for each  $h \in H$ ,

$$\Delta^{\text{Bd}}(h) = h_{(2)}a_i \otimes S((b_i)_{(1)})h_{(1)}(b_i)_{(2)}.$$

The codegeneracies  $\{\sigma_j^n: V_{n+2}(H) \rightarrow V_{n+1}(H)\}_{n \in \mathbb{N}, 0 \leq j \leq n}$  are given by setting for any elementary tensor  $h_1 \otimes \cdots \otimes h_{n+2} \in V_{n+2}(H)$ ,

$$\sigma_j(h_1 \otimes \cdots \otimes h_{n+2}) = h_1 \otimes \cdots \otimes h_{j+1} \otimes \varepsilon(h_{j+2}) \otimes \cdots \otimes h_{n+2}.$$

The cocyclic operators  $\{\tau_n: V_{n+1}(H) \rightarrow V_{n+1}(H)\}_{n \in \mathbb{N}}$  are given by setting for any elementary tensor  $h_1 \otimes \cdots \otimes h_{n+1} \in V_{n+1}(H)$ ,

$$\tau_n(h_1 \otimes \cdots \otimes h_{n+1}) = \sum_i h_2 \triangleleft (\beta_i)_{(1)} \otimes \cdots \otimes h_{n+1} \triangleleft (\beta_i)_{(n)} \otimes h_1 \triangleleft (\alpha_i \theta^{-1}).$$

## 7. CYCLIC MODULES FROM TQFTS

In Theorem 4.1 says that there exist (co)cyclic objects in the category of 3-cobordisms. By composition, any 3-dimensional TQFT induces a (co)cyclic  $\mathbb{k}$ -module. In this section we compute it for the Reshetikhin-Turaev TQFT  $\text{RT}_{\mathcal{B}}: \mathbf{Cob}_3 \rightarrow \text{Mod}_{\mathbb{k}}$  associated to an anomaly free modular category  $\mathcal{B}$ . Note that the coend  $\mathbb{F}$  of  $\mathcal{B}$  exists and is a Hopf algebra in  $\mathcal{B}$ . Recall the cocyclic  $\mathbb{k}$ -module  $\mathbb{F}^\bullet$  and the cyclic  $\mathbb{k}$ -module  $\mathbb{F}_\bullet$  (see Section 6) associated to  $\mathbb{F}$ , as well as the reindexing involution  $\Phi: \Delta C \rightarrow \Delta C$  (see Section 2E). The second main result of this paper is the following:

**Theorem 7.1.** *The cocyclic  $\mathbb{k}$ -modules  $\text{RT}_{\mathcal{B}} \circ X^\bullet$  and  $\mathbb{F}^\bullet \circ \Phi$  are isomorphic. The cyclic  $\mathbb{k}$ -modules  $\text{RT}_{\mathcal{B}} \circ X_\bullet$  and  $\mathbb{F}_\bullet \circ \Phi^{\text{op}}$  are isomorphic.*

We note that the  $n$ -th Hochschild cohomology of  $\mathbb{F}^\bullet \circ \Phi$  and  $\mathbb{F}^\bullet$  are equal. Indeed, the Hochschild differentials of the associated cochain complexes are equal. The cohomological form of the Connes' long exact sequence [35, Proposition 9.6.11] then implies that this is also the case for their cyclic cohomology. The proof of Theorem 7.1 is given in sections 7A–7E.

The cyclic duality  $L: \Delta C^{\text{op}} \rightarrow \Delta C$  and reindexing involution automorphism  $\Phi$  transform the cocyclic object  $X^\bullet$  in  $\mathbf{Cob}_3$  into a cyclic object  $X^\bullet \circ \Phi \circ L$  in  $\mathbf{Cob}_3$ . Similarly, the functors  $L^{\text{op}}: \Delta C \rightarrow \Delta C^{\text{op}}$  and  $\Phi^{\text{op}}$  transform the cyclic object  $X_\bullet$  in  $\mathbf{Cob}_3$  into a cocyclic object  $X_\bullet \circ \Phi^{\text{op}} \circ L^{\text{op}}$  in  $\mathbf{Cob}_3$ . By Theorem 7.1 and the fact that  $\Phi$  is involutive, we obtain the following:

**Corollary 7.2.** *The cyclic  $\mathbb{k}$ -modules  $\text{RT}_{\mathcal{B}} \circ X^\bullet \circ \Phi \circ L$  and  $\mathbb{F}^\bullet \circ L$  are isomorphic. The cocyclic  $\mathbb{k}$ -modules  $\text{RT}_{\mathcal{B}} \circ X_\bullet \circ \Phi^{\text{op}} \circ L^{\text{op}}$  and  $\mathbb{F}_\bullet \circ L^{\text{op}}$  are isomorphic.*

Recall that the cyclic  $\mathbb{k}$ -module  $\mathbb{F}^\bullet \circ L$  and the cocyclic  $\mathbb{k}$ -module  $\mathbb{F}_\bullet \circ L^{\text{op}}$  (see Section 6C) are cyclic duals of  $\mathbb{F}^\bullet$  and the cyclic  $\mathbb{k}$ -module  $\mathbb{F}_\bullet$ .

Another fundamental construction of a 3-dimensional TQFT is the Turaev-Viro TQFT  $\text{TV}_{\mathcal{C}}: \mathbf{Cob}_3 \rightarrow \text{Mod}_{\mathbb{k}}$  associated to a spherical fusion  $\mathbb{k}$ -category  $\mathcal{C}$  with invertible dimension (for details, see [32]). Moreover, in the case when  $\mathcal{C}$  is additive and  $\mathbb{k}$  is an algebraically closed field, the center  $\mathcal{Z}(\mathcal{C})$  of  $\mathcal{C}$  is an anomaly free modular category (see [32, Theorem 5.3., Theorem 5.4.]). In this case, according to [32, Theorem 17.1.], the TQFTs  $\text{RT}_{\mathcal{Z}(\mathcal{C})}$  and  $\text{TV}_{\mathcal{C}}$  are isomorphic. Denote by  $\mathbb{G}$  the coend of  $\mathcal{Z}(\mathcal{C})$ . These results and Theorem 7.1 imply the following corollary:

**Corollary 7.3.** *The cocyclic  $\mathbb{k}$ -modules  $\text{TV}_{\mathcal{C}} \circ X^\bullet$  and  $\mathbb{G}^\bullet \circ \Phi$  are isomorphic. The cyclic  $\mathbb{k}$ -modules  $\text{TV}_{\mathcal{C}} \circ X_\bullet$  and  $\mathbb{G}_\bullet \circ \Phi^{\text{op}}$  are isomorphic.*

By using cyclic duality  $L$  and reindexing involution  $\Phi$ , we obtain:

**Corollary 7.4.** *The cyclic  $\mathbb{k}$ -modules  $\text{TV}_{\mathcal{C}} \circ X^\bullet \circ \Phi \circ L$  and  $\mathbb{G}^\bullet \circ L$  are isomorphic. The cocyclic  $\mathbb{k}$ -modules  $\text{TV}_{\mathcal{C}} \circ X_\bullet \circ \Phi^{\text{op}} \circ L^{\text{op}}$  and  $\mathbb{G}_\bullet \circ L^{\text{op}}$  are isomorphic.*

To show the claim from Theorem 7.1, it follows from Section 4C that it suffices to compute  $\text{RT}_{\mathcal{B}} \circ Y^\bullet$  and  $\text{RT}_{\mathcal{B}} \circ Y_\bullet$ . In Section 7A, we give some algebraic preliminaries on coend of a modular category. Next, in Section 7B, we describe the Reshetikhin-Turaev TQFT  $\text{RT}_{\mathcal{B}}$  via the coend  $\mathbb{F}$  of  $\mathcal{B}$ . Then, in Section 7C, we compute the cocyclic  $\mathbb{k}$ -module  $\text{RT}_{\mathcal{B}} \circ Y^\bullet$ . In Section 7D we prove that the latter is isomorphic to  $\mathbb{F}^\bullet \circ \Phi$ , as stated in Theorem 7.1. Finally, in Section 7E, we sketch the computation of  $\text{RT}_{\mathcal{B}} \circ Y_\bullet$  and the proof of the fact that it is isomorphic to the cyclic  $\mathbb{k}$ -module  $\mathbb{F}_\bullet \circ \Phi^{\text{op}}$ .

Remember that  $\mathbb{F}$  is a Hopf algebra in  $\mathcal{B}$  endowed with a Hopf pairing  $\omega: \mathbb{F} \otimes \mathbb{F} \rightarrow \mathbb{1}$ . Here, we denote by  $m, u, \Delta, \varepsilon,$  and  $S$  multiplication, unit, comultiplication, counit, and antipode of  $\mathbb{F}$ , respectively. While using graphical calculus, we often drop  $\mathbb{F}$  from notation.

**7A. Modularity and pairing of a coend.** In this section we provide some algebraic preliminaries needed for computation of the Reshetikhin-Turaev TQFT  $\text{RT}_{\mathcal{B}}$  via the coend of anomaly-free modular category. In the following lemma, we compute the inverse, under some conditions, of the pairing of the coend. Note that the statement and the proof of Lemma 7.5(b) is similar to [32, Lemma 6.2].

**Lemma 7.5.** *Let  $\mathcal{B}$  be a ribbon  $\mathbb{k}$ -category with a coend  $\mathbb{F}$  and suppose that the canonical pairing  $\omega: \mathbb{F} \otimes \mathbb{F} \rightarrow \mathbb{1}$  associated to the coend is non-degenerate.*

- (a) *If  $\Lambda: \mathbb{1} \rightarrow \mathbb{F}$  is a right integral of a coend, then  $\omega(\Lambda \otimes \text{id}_{\mathbb{F}}): \mathbb{F} \rightarrow \mathbb{1}$  is a left cointegral of  $\mathbb{F}$ .*
- (b) *Let  $\Lambda$  be a right integral of the coend  $\mathbb{F}$  of  $\mathcal{B}$ . Suppose that the element  $\omega(\Lambda \otimes \Lambda)$  is invertible. The inverse of the pairing  $\omega$  is given by the morphism  $\Omega: \mathbb{1} \rightarrow \mathbb{F} \otimes \mathbb{F}$ , which is computed by*

$$\Omega = \left( \begin{array}{c} \omega \\ \Lambda \quad \Lambda \end{array} \right)^{-1} \circ \begin{array}{c} \oplus \\ \omega \\ \Lambda \end{array} .$$

*Proof.* (a) By the property of the bialgebra pairing and the fact that  $\Lambda$  is a right integral for  $C$ , we have

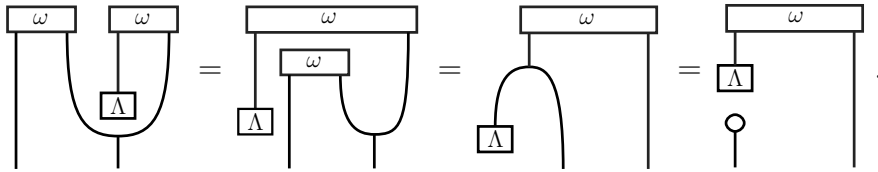

Since  $\omega$  is non-degenerate, the conclusion follows.

(b) We have

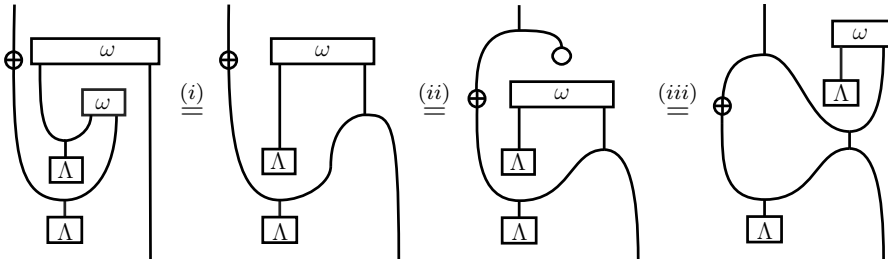

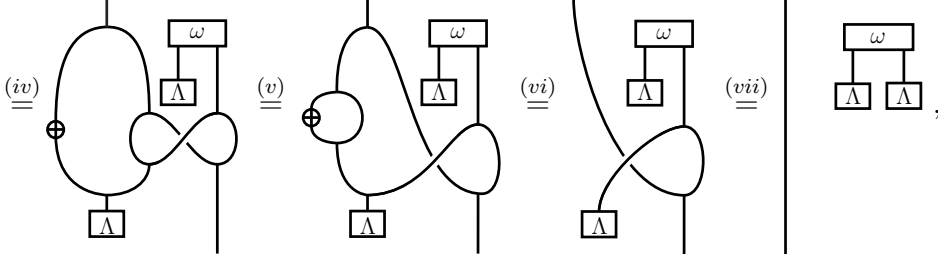

and so the claim follows by invertibility of  $\omega(\Lambda \otimes \Lambda)$ . Here (i) follows by property of bialgebra pairing, (ii) by (co)unitality, (iii) by the part (a), (iv) from bialgebra axioms, (v) by (co)associativity, (vi) by the antipode axiom and (co)unitality, (vii) by the naturality of the braiding, the fact that  $\Lambda$  is a right integral for  $\mathbb{F}$  and counitality.  $\square$

**Corollary 7.6.** *Let  $\mathcal{B}$  be a ribbon  $\mathbb{k}$ -category with a coend  $\mathbb{F}$  and  $\Lambda: \mathbb{1} \rightarrow \mathbb{F}$  a right integral for the coend  $\mathbb{F}$ . If the pairing  $\omega: \mathbb{F} \otimes \mathbb{F} \rightarrow \mathbb{1}$  is non-degenerate, then*

$$= \omega(\Lambda \otimes \Lambda). \quad (20)$$

*Proof.* By Lemma 7.5(b) and invertibility of the antipode, we have

Here (i) and (iii) follow from invertibility of the antipode, (ii) follows by Lemma 7.5(b).  $\square$

If  $\mathcal{B}$  is an additive ribbon fusion  $\mathbb{k}$ -category with a coend  $\mathbb{F}$ , then, according to [32, Theorem 6.6.], the category  $\mathcal{B}$  is modular (in the sense of Section 5L) if and only if the canonical pairing  $\omega: \mathbb{F} \otimes \mathbb{F} \rightarrow \mathbb{1}$  associated to  $\mathbb{F}$  is non-degenerate. Moreover, the coend  $\mathbb{F}$  is given by  $\mathbb{F} = \bigoplus_{i \in I} i^* \otimes i$ , where  $I$  is a representative set of simple objects of  $\mathcal{B}$ . For  $i \in I$ , we denote the projection associated with the direct sum decomposition by  $p_i: \mathbb{F} \rightarrow i^* \otimes i$ . However, we drop inclusions  $i^* \otimes i \rightarrow \mathbb{F}$  in our notation. By [32, Theorem 6.4.], any integral of  $\mathbb{F}$  is a scalar multiple of the universal integral

$$\Lambda = \sum_{i \in I} \dim(i) \widetilde{\text{coev}}_i: \mathbb{1} \rightarrow \mathbb{F}. \quad (21)$$

Similarly, one can show that any cointegral of  $\mathbb{F}$  is a scalar multiple of the universal cointegral

$$\lambda = \text{ev}_{\mathbb{1}} p_{\mathbb{1}}: \mathbb{F} \rightarrow \mathbb{1}. \quad (22)$$

Universal (co)integrals  $\lambda$  and  $\Lambda$  satisfy  $\lambda\Lambda = \text{id}_{\mathbb{1}}$ .



**Remark 7.7.** Let  $\mathcal{B}$  be an additive ribbon fusion  $\mathbb{k}$ -category such that the canonical pairing  $\omega$  associated to the coend  $\mathbb{F}$  is non-degenerate. Recall the universal integral  $\Lambda$  and the universal cointegral  $\lambda$  of the coend  $\mathbb{F}$ , defined in equations (21) and (22), respectively. Let us calculate  $\omega(\Lambda \otimes \Lambda)$ . By Lemma 7.5 (a),  $\omega(\Lambda \otimes \text{id}_{\mathbb{F}})$  is a left cointegral of  $\mathbb{F}$ . By universality of  $\lambda$ ,  $\omega(\Lambda \otimes \text{id}_{\mathbb{F}}) = k\lambda$ , for some  $k \in \mathbb{k} \cong \text{End}(\mathbb{1})$ . This further implies that

$$\omega(\Lambda \otimes \Lambda) = k\lambda\Lambda = k\text{id}_{\mathbb{1}}.$$

Now, remark also that

$$\omega(\Lambda \otimes u) = \varepsilon\Lambda = \dim(\mathcal{B}).$$

These two properties together with the fact that  $p_{\mathbb{1}}i_{\mathbb{1}} = \text{id}_{\mathbb{1}^* \otimes \mathbb{1}}$ , with definition of unit  $u$  of the coend  $\mathbb{F}$ , and definition of  $\lambda$ , give that

$$\begin{aligned} \omega(\Lambda \otimes \Lambda) &= k\text{id}_{\mathbb{1}} = k(\text{id}_{\mathbb{1}} \otimes \text{ev}_{\mathbb{1}})(\text{coev}_{\mathbb{1}} \otimes \text{id}_{\mathbb{1}}) = k(\text{id}_{\mathbb{1}} \otimes \text{ev}_{\mathbb{1}}p_{\mathbb{1}})(\text{id}_{\mathbb{1}} \otimes i_{\mathbb{1}})(\text{coev}_{\mathbb{1}} \otimes \text{id}_{\mathbb{1}}) = \\ &= k(\text{id}_{\mathbb{1}} \otimes \lambda)u = k\lambda u = \omega(\Lambda \otimes u) = \dim(\mathcal{B}). \end{aligned}$$

**7B. The Reshetikhin-Turaev TQFT via coends.** In [31], Turaev associates to any modular category  $\mathcal{B}$  a 3-dimensional TQFT  $\text{RT}_{\mathcal{B}}$ . There, a precise definition of a 3-dimensional TQFT involves Lagrangian spaces in homology of surfaces and  $p_1$ -structures in cobordisms. However, if the modular category  $\mathcal{B}$  is anomaly free (see Section 5L), then the TQFT  $\text{RT}_{\mathcal{B}}$  does not depend on this additional data and is a genuine symmetric monoidal functor  $\text{RT}_{\mathcal{B}}: \mathbf{Cob}_3 \rightarrow \text{Mod}_{\mathbb{k}}$ .

Let  $\mathcal{B}$  be an anomaly free modular  $\mathbb{k}$ -category. Recall from Section 5L that the scalar  $\Delta = \Delta_+ = \Delta_-$  is invertible and satisfies  $\Delta^2 = \dim(\mathcal{B})$ . By Section 3F, any special ribbon  $(g, h)$ -graph  $\Gamma$  represents a 3-cobordism  $M_{\Gamma}: S_g \rightarrow S_h$ . Our goal is to compute the  $\mathbb{k}$ -linear homomorphism

$$\text{RT}_{\mathcal{B}}(M_{\Gamma}): \text{RT}_{\mathcal{B}}(S_g) \rightarrow \text{RT}_{\mathcal{B}}(S_h)$$

in terms of the coend  $\mathbb{F}$  of  $\mathcal{B}$  (which always exists, see Section 7A). First, it follows from the definition of  $\text{RT}_{\mathcal{B}}$  and the computation of the coend  $\mathbb{F}$  in terms of a representative set  $I$  of simple objects of  $\mathcal{B}$  that

$$\text{RT}_{\mathcal{B}}(S_g) = \text{Hom}_{\mathcal{B}}(\mathbb{1}, \mathbb{F}^{\otimes g}) \quad \text{and} \quad \text{RT}_{\mathcal{B}}(S_h) = \text{Hom}_{\mathcal{B}}(\mathbb{1}, \mathbb{F}^{\otimes h}).$$

Next, the formula (2.3)(a) from [31, Section IV.2.3], which computes  $\text{RT}_{\mathcal{B}}(M_{\Gamma})$ , rewrites in our setting as

$$\text{RT}_{\mathcal{B}}(M_{\Gamma}) = \Delta^{-n-h} \text{Hom}_{\mathcal{B}}(\mathbb{1}, |\Gamma|), \quad (23)$$

where  $|\Gamma|: \mathbb{F}^{\otimes g} \rightarrow \mathbb{F}^{\otimes h}$  is a morphism in  $\mathcal{B}$  defined as follows. By pulling down some part of each circle component of  $\Gamma$  and of each arc connecting the outputs of  $\Gamma$ , we obtain that the ribbon graph  $\Gamma$  is isotopic to

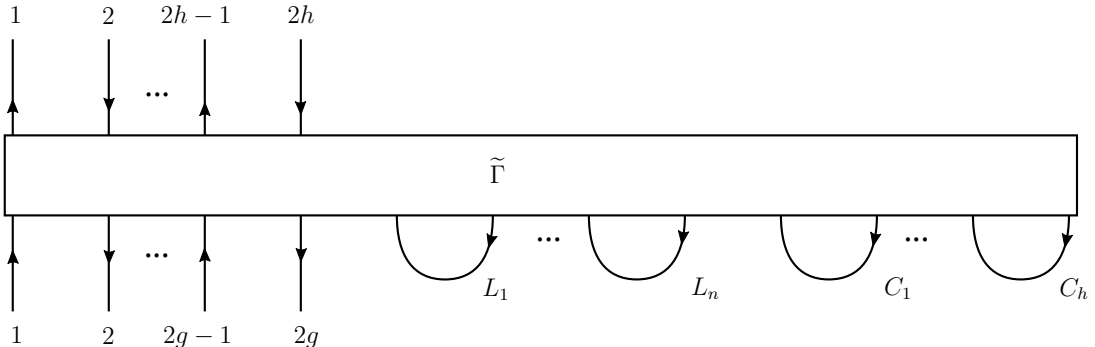

where the cups  $L_1, \dots, L_n$  correspond to the circle components of  $\Gamma$  and the cups  $C_1, \dots, C_h$  correspond to the upper arcs of  $\Gamma$ . Here,  $\tilde{\Gamma}$  is a ribbon graph with  $(g + n + 2h)$  arcs,  $(2g + 2n + 2h)$  inputs,  $2h$  outputs, no coupons, no circle components, and such that:

- for all  $1 \leq i \leq g + n$ , an arc  $a_i$  connects the  $(2i - 1)$ -th input to the  $(2i)$ -th input of  $\tilde{\Gamma}$ ,
- for all  $1 \leq j \leq h$ , an arc  $u_j$  connects the  $(2g + 2n + 2j - 1)$ -th input to the  $(2j - 1)$ -th output of  $\tilde{\Gamma}$ , and an arc  $v_j$  connects the  $(2j)$ -th output to the  $(2g + 2n + 2j)$ -th input of  $\tilde{\Gamma}$ .

The ribbon graph  $\Gamma$  is called *closure* of the ribbon graph  $\tilde{\Gamma}$ . Coloring the arc  $a_i$  by an object  $X_i$  of  $\mathcal{B}$  and coloring both the arcs  $u_j, v_j$  by an object  $Y_j$  of  $\mathcal{B}$ , we obtain a  $\mathcal{B}$ -colored ribbon graph representing a morphism  $\phi_{X_1, \dots, X_{g+n}, Y_1, \dots, Y_h}$ . Let  $i = \{i_X : X^* \otimes X \rightarrow \mathbb{F}\}_{X \in \text{Ob}(\mathcal{B})}$  be the universal dinatural transformation associated to the coend  $\mathbb{F}$ . Then the family of morphisms

$$(i_{Y_1} \otimes \dots \otimes i_{Y_h}) \circ \phi_{X_1, \dots, X_{g+n}, Y_1, \dots, Y_h}$$

from  $X_1^* \otimes X_1 \otimes \dots \otimes X_{g+n}^* \otimes X_{g+n} \otimes Y_1^* \otimes Y_1 \otimes \dots \otimes Y_h^* \otimes Y_h$  to  $\mathbb{F}^{\otimes h}$  is dinatural in each variable and so, by Lemma 5.1, it factorizes as

$$\phi_\Gamma \circ (i_{X_1} \otimes \dots \otimes i_{X_{g+n}} \otimes i_{Y_1} \otimes \dots \otimes i_{Y_h})$$

for a unique morphism  $\phi_\Gamma : \mathbb{F}^{\otimes g+n+h} \rightarrow \mathbb{F}^{\otimes h}$ . Then

$$|\Gamma| = \phi_\Gamma \circ (\text{id}_{\mathbb{F}^{\otimes g}} \otimes \Lambda^{\otimes(n+h)}): \mathbb{F}^{\otimes g} \rightarrow \mathbb{F}^{\otimes h},$$

where  $\Lambda$  is the universal integral defined in the equation (21). It follows from the fact that  $\Lambda$  is a right integral for  $\mathbb{F}$  (see Section 7A) that the morphism  $|\Gamma|$  is an isotopy invariant of  $\Gamma$ . This invariant is multiplicative:

$$|\Gamma \sqcup \Gamma'| = |\Gamma| \otimes |\Gamma'|, \quad (24)$$

for all special ribbon graphs, where  $\Gamma \sqcup \Gamma'$  is obtained by concatenating  $\Gamma'$  to the right of  $\Gamma$ .

**7C. Computation of  $\text{RT}_{\mathcal{B}} \circ Y^\bullet$ .** We remind that  $\mathcal{B}$  denotes an anomaly-free modular category. In the following lemma, we calculate the isotopy invariant  $|\cdot|$  (see Section 7B) of particular special graphs:

**Lemma 7.8.** *If  $T_i$  for  $i = 1, 2, 3$  are the following special ribbon graphs*

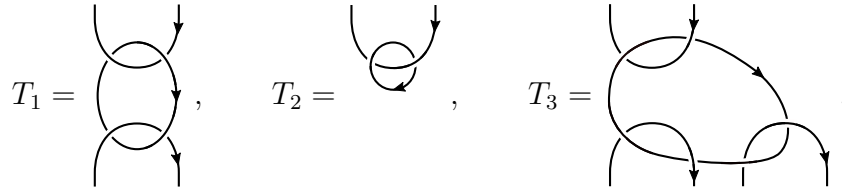

then

- $|T_1| = \dim(\mathcal{B}) \text{id}_{\mathbb{F}}$ ,
- $|T_2| = \dim(\mathcal{B}) u$ ,
- $|T_3| = \dim(\mathcal{B}) m$ .

*Proof.* (a) A ribbon graph whose closure is isotopic to  $T_1$  is

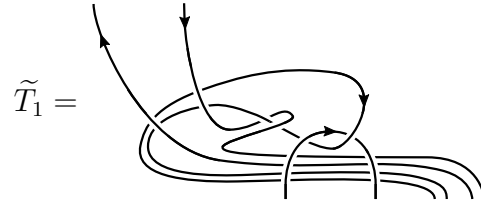

For all objects  $X, Y,$  and  $Z$  in  $\mathcal{B}$ , we have:

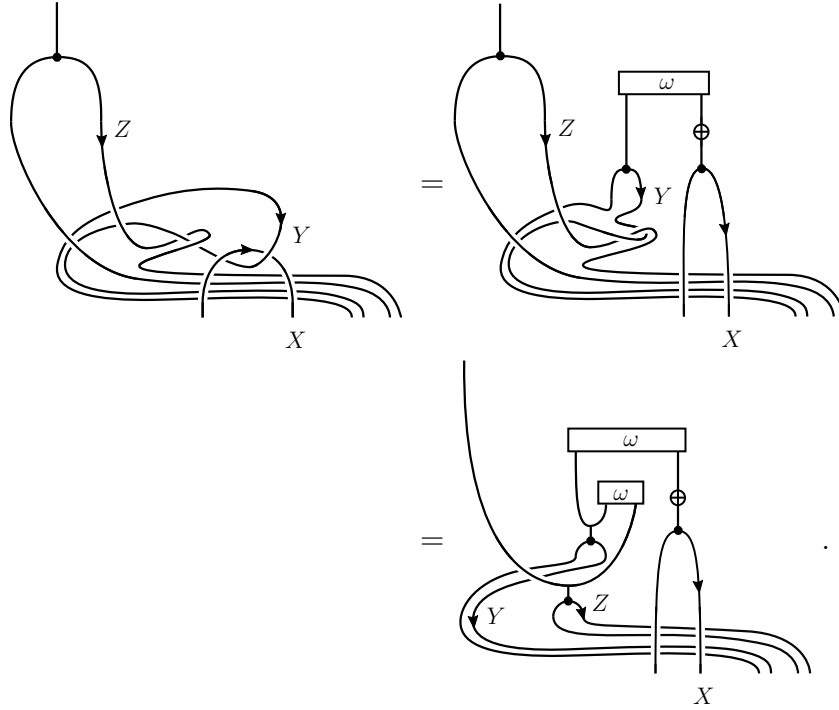

Hence, by definition of  $|\cdot|$  given in Section 7B, Corollary 7.6, and Remark 7.7, we have:

$$|T_1| = \left( \text{Diagram with } \omega \text{ box, } \Lambda \text{ boxes, and } \oplus \text{ symbol} \right) = \omega(\Lambda \otimes \Lambda)\text{id}_{\mathbb{F}} = \dim(\mathcal{B})\text{id}_{\mathbb{F}}.$$

(b) A ribbon graph whose closure is isotopic to  $T_2$  is

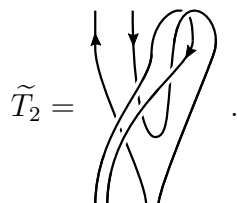

For all objects  $X, Y$  in  $\mathcal{B}$ , we have:

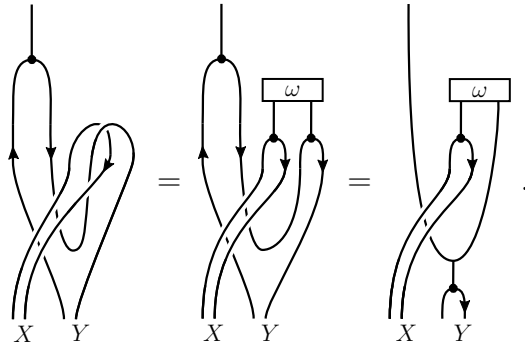

Hence, by definition of  $|\cdot|$  given in Section 7B, by Lemma 7.5 (a), and Remark 7.7, we have:

$$|T_2| = \begin{array}{c} \omega \\ \Lambda \\ \Lambda \end{array} = \begin{array}{c} \circ \\ \omega \\ \Lambda \\ \Lambda \end{array} = \omega(\Lambda \otimes \Lambda)u = \dim(\mathcal{B})u.$$

(c) A ribbon graph whose closure is isotopic to  $T_3$  is

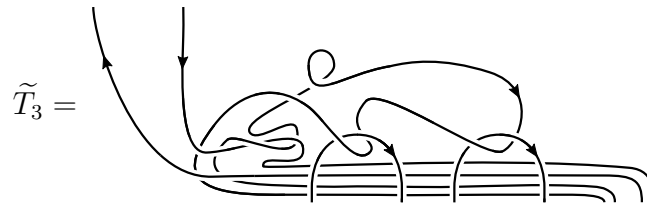

For all objects  $X, Y$ , and  $Z$  in  $\mathcal{B}$ , we have:

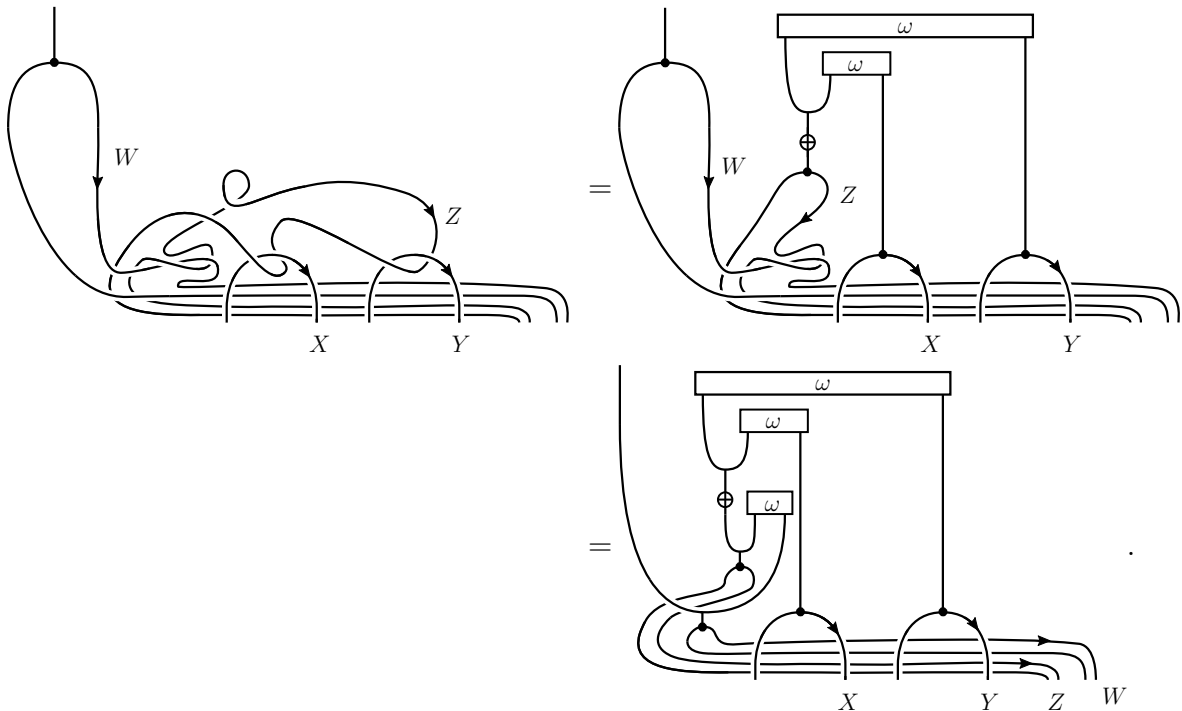

Hence, by definition of  $|\cdot|$  given in Section 7B, axioms of a Hopf pairing, the equation (17), Corollary 7.6, and Remark 7.7, we have

$$|T_3| = \begin{array}{c} \text{Diagram 1} \\ \text{Diagram 2} \end{array} = \omega(\Lambda \otimes \Lambda)m = \dim(\mathcal{B})m. \quad \square$$

The previously proved Lemma 7.8 implies the following result:

**Lemma 7.9.** *We have:*

$$(a) \quad |G_{Y \bullet (\delta_i^n)}| = \begin{cases} \dim(\mathcal{B})^{n+1} \begin{array}{c} | \quad \dots \quad | \\ 0 \quad n-1 \end{array}, & \text{if } i = 0, \\ \dim(\mathcal{B})^{n+1} \begin{array}{c} | \quad \dots \quad | \quad | \quad \dots \quad | \\ 0 \quad i-1 \quad i \quad n-1 \end{array}, & \text{if } 1 \leq i \leq n-1, \\ \dim(\mathcal{B})^{n+1} \begin{array}{c} | \quad \dots \quad | \quad | \\ 0 \quad n-1 \end{array}, & \text{if } i = n, \end{cases}$$

$$(b) \quad |G_{Y \bullet (\sigma_j^n)}| = \dim(\mathcal{B})^{n+1} \begin{array}{c} | \quad \dots \quad | \quad | \quad | \quad \dots \quad | \\ 0 \quad j \quad j+1 \quad n+1 \end{array},$$

$$(c) \quad |G_{Y \bullet (\tau_n)}| = \begin{cases} \dim(\mathcal{B})\text{id}_{\mathbb{F}}, & \text{if } n = 0, \\ \dim(\mathcal{B})^{n+1} \begin{array}{c} \text{Diagram} \\ 0 \quad 1 \quad \dots \quad n \end{array}, & \text{if } n \geq 1. \end{cases}$$

*Proof.* (a) Recall the special ribbon graphs  $T_1$  and  $T_2$  from Lemma 7.8. Let  $n \in \mathbb{N}^*$  and  $1 \leq i \leq n-1$ . By Lemma 7.8 and multiplicativity of  $|\cdot|$  (see equation (24)),

$$\begin{aligned} |G_{Y \bullet (\delta_i^n)}| &= (\dim(\mathcal{B})\text{id}_{\mathbb{F}})^{\otimes i} \otimes \dim(\mathcal{B})u \otimes (\dim(\mathcal{B})\text{id}_{\mathbb{F}})^{\otimes n-i} = \\ &= \dim(\mathcal{B})^{n+1} \begin{array}{c} | \quad \dots \quad | \quad | \quad \dots \quad | \\ 0 \quad i-1 \quad i \quad n-1 \end{array}. \end{aligned}$$

The cases  $i = 0$  and  $i = n$  are proven in a similar way.

(b) Recall the special ribbon graphs  $T_1$  and  $T_3$  from Lemma 7.8. Let  $n \in \mathbb{N}$  and  $0 \leq j \leq n$ . By Lemma 7.8,

$$\begin{aligned}
 |G_{Y^\bullet(\sigma_j^n)}| &= (\dim(\mathcal{B})\text{id}_{\mathbb{F}})^{\otimes j} \otimes \dim(\mathcal{B})m \otimes (\dim(\mathcal{B})\text{id}_{\mathbb{F}})^{\otimes n-j} \\
 &= \dim(\mathcal{B})^{n+1} \left| \begin{array}{c} \dots \\ \left| \begin{array}{c} \text{---} \\ \cup \\ \text{---} \end{array} \right. \\ \dots \end{array} \right|_{\substack{0 \\ j \quad j+1 \\ n+1}}.
 \end{aligned}$$

(c) Recall that  $Y^\bullet(\tau_0)$  is the identity morphism  $\text{id}_{S_1}$ . Hence

$$|G_{Y^\bullet(\tau_0)}| = \dim(\mathcal{B})\text{id}_{\mathbb{F}},$$

by Lemma 7.8 (a). Let us show the statement in the case  $n = 1$ . The general case is verified similarly. The special ribbon graph  $G_{Y^\bullet(\tau_1)}$  depicts as

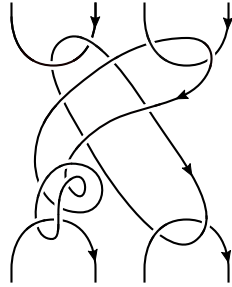

A ribbon graph, whose closure is isotopic to the special ribbon graph  $G_{Y^\bullet(\tau_1)}$  depicts as

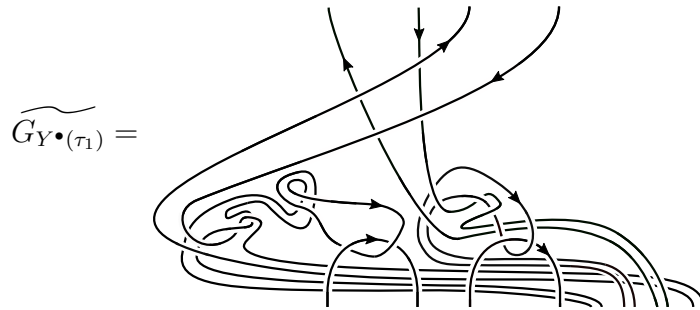

For all objects  $X, Y, Z, U, V$ , and  $W$  in  $\mathcal{B}$ , we have:

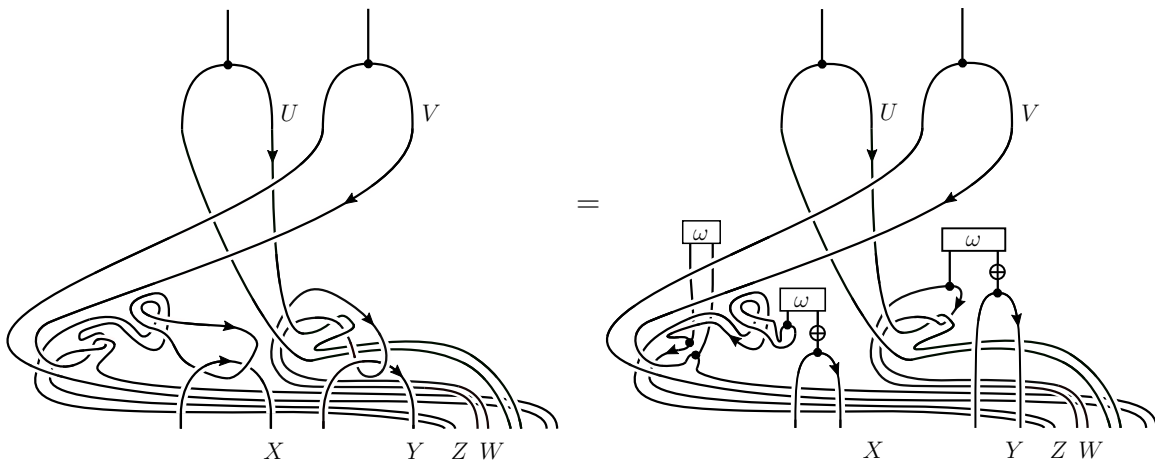

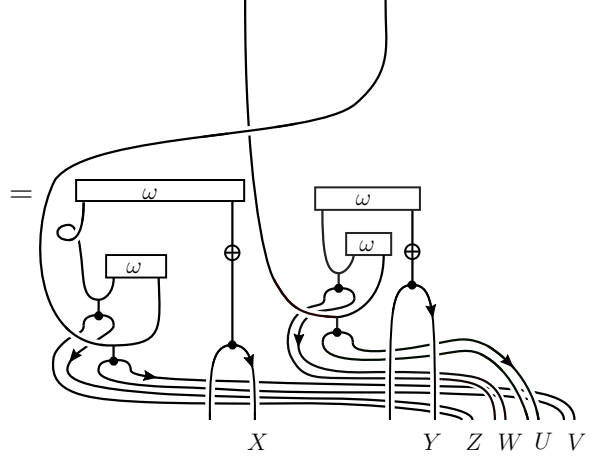

Hence, by definition of  $|\cdot|$  given in Section 7B, the equations (17) and (16), Corollary 7.6 and Remark 7.7, we have:

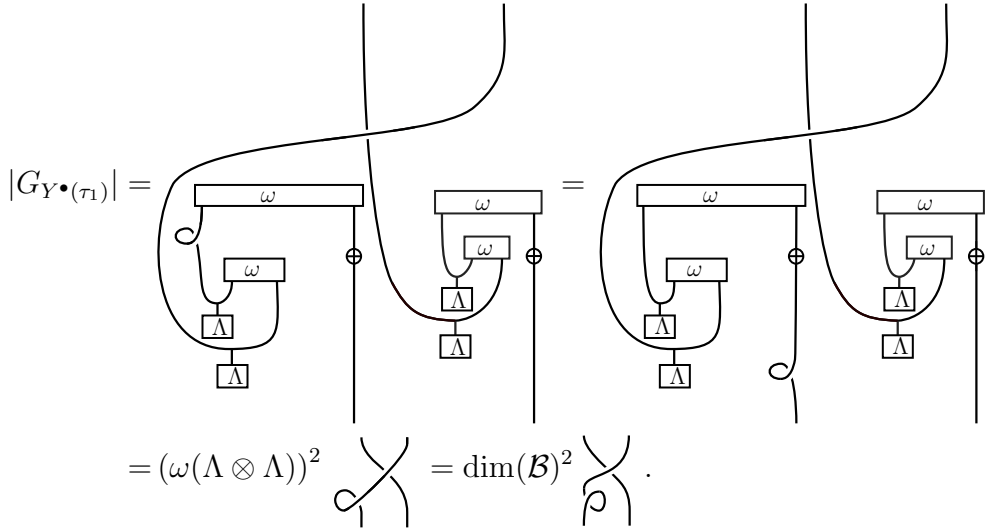

□

The computation of  $\text{RT}_{\mathcal{B}} \circ Y^\bullet$  follows from Lemma 7.9:

**Lemma 7.10.** *The cocyclic  $\mathbb{k}$ -module  $\text{RT}_{\mathcal{B}} \circ Y^\bullet$  equals to the cocyclic  $\mathbb{k}$ -module given by the family  $\{\text{Hom}_{\mathcal{B}}(\mathbb{1}, \mathbb{F}^{\otimes n+1})\}_{n \in \mathbb{N}}$ , equipped with the cofaces  $\{\text{RT}_{\mathcal{B}}(Y^\bullet(\delta_i^n))\}_{n \in \mathbb{N}^*, 0 \leq i \leq n}$ , codegeneracies  $\{\text{RT}_{\mathcal{B}}(Y^\bullet(\sigma_j^n))\}_{n \in \mathbb{N}, 0 \leq j \leq n}$ , and cocyclic operators  $\{\text{RT}_{\mathcal{B}}(Y^\bullet(\tau_n))\}_{n \in \mathbb{N}}$  given by formulas*

$$\begin{aligned} \delta_0^n(f) &= \begin{array}{c} \circ \mid 0 \dots \mid n-1 \\ \hline f \end{array}, & \delta_i^n(f) &= \begin{array}{c} 0 \mid i-1 \circ \mid i \dots \mid n-1 \\ \hline f \end{array}, & \delta_n^n(f) &= \begin{array}{c} 0 \mid n-1 \circ \mid 1 \\ \hline f \end{array}, \\ \sigma_j^n(f) &= \begin{array}{c} \dots \mid j \mid j+1 \mid \dots \\ \hline f \end{array}, & \tau_n(f) &= \begin{array}{c} \rho \mid 1 \dots \mid n \\ \hline f \end{array}. \end{aligned}$$

*Proof.* By using the formula (23) from Section 7B, the construction of  $Y^\bullet$  from Section 4A, and the Lemma 7.9, we calculate  $\{\text{RT}_{\mathcal{B}}(Y^\bullet(\delta_i^n))\}_{n \in \mathbb{N}^*, 0 \leq i \leq n}$ ,  $\{\text{RT}_{\mathcal{B}}(Y^\bullet(\sigma_j^n))\}_{n \in \mathbb{N}, 0 \leq j \leq n}$ , and

$\{\text{RT}_{\mathcal{B}}(Y^\bullet(\tau_n))\}_{n \in \mathbb{N}}$ . Let  $n \in \mathbb{N}^*$ . In the case when  $1 \leq i \leq n-1$ ,

$$\begin{aligned} \text{RT}_{\mathcal{B}}(Y^\bullet(\delta_i^n)) &= \Delta^{-(n+1)-(n+1)} \text{Hom}_{\mathcal{B}}(\mathbb{1}, |G_{Y^\bullet(\delta_i^n)}|) \\ &= \dim(\mathcal{B})^{-(n+1)} \text{Hom}_{\mathcal{B}} \left( \mathbb{1}, \dim(\mathcal{B})^{n+1} \left| \begin{array}{c} \cdots \\ \vdots \\ \vdots \\ \vdots \\ \vdots \end{array} \right| \begin{array}{c} \circ \\ \vdots \end{array} \left| \begin{array}{c} \cdots \\ \vdots \\ \vdots \\ \vdots \\ \vdots \end{array} \right| \right) \\ &= \text{Hom}_{\mathcal{B}} \left( \mathbb{1}, \left| \begin{array}{c} \cdots \\ \vdots \\ \vdots \\ \vdots \\ \vdots \end{array} \right| \begin{array}{c} \circ \\ \vdots \end{array} \left| \begin{array}{c} \cdots \\ \vdots \\ \vdots \\ \vdots \\ \vdots \end{array} \right| \right). \end{aligned}$$

The cases  $i = 0$  or  $i = n$  are verified analogously.

For  $n \in \mathbb{N}$  and  $0 \leq j \leq n$ ,

$$\begin{aligned} \text{RT}_{\mathcal{B}}(Y^\bullet(\sigma_j^n)) &= \Delta^{-(n+1)-(n+1)} \text{Hom}_{\mathcal{B}}(\mathbb{1}, |G_{Y^\bullet(\sigma_j^n)}|) \\ &= \dim(\mathcal{B})^{-(n+1)} \text{Hom}_{\mathcal{B}} \left( \mathbb{1}, \dim(\mathcal{B})^{n+1} \left| \begin{array}{c} \cdots \\ \vdots \\ \vdots \\ \vdots \\ \vdots \end{array} \right| \begin{array}{c} \vdots \\ \vdots \\ \vdots \\ \vdots \\ \vdots \end{array} \left| \begin{array}{c} \cdots \\ \vdots \\ \vdots \\ \vdots \\ \vdots \end{array} \right| \right) \\ &= \text{Hom}_{\mathcal{B}} \left( \mathbb{1}, \left| \begin{array}{c} \cdots \\ \vdots \\ \vdots \\ \vdots \\ \vdots \end{array} \right| \begin{array}{c} \vdots \\ \vdots \\ \vdots \\ \vdots \\ \vdots \end{array} \left| \begin{array}{c} \cdots \\ \vdots \\ \vdots \\ \vdots \\ \vdots \end{array} \right| \right). \end{aligned}$$

Finally,

$$\begin{aligned} \text{RT}_{\mathcal{B}}(Y^\bullet(\tau_0)) &= \Delta^{-1-1} \text{Hom}_{\mathcal{B}}(\mathbb{1}, |G_{Y^\bullet(\tau_0)}|) \\ &= \dim(\mathcal{B})^{-1} \text{Hom}_{\mathcal{B}}(\mathbb{1}, \dim(\mathcal{B}) \text{id}_{\mathbb{F}}) = \\ &= \text{id}_{\text{Hom}_{\mathcal{B}}(\mathbb{1}, \mathbb{F})}. \end{aligned}$$

In the case when  $n \geq 1$ ,

$$\begin{aligned} \text{RT}_{\mathcal{B}}(Y^\bullet(\tau_n)) &= \Delta^{-(n+1)-(n+1)} \text{Hom}_{\mathcal{B}}(\mathbb{1}, |G_{Y^\bullet(\tau_n)}|) \\ &= \dim(\mathcal{B})^{-(n+1)} \text{Hom}_{\mathcal{B}} \left( \mathbb{1}, \dim(\mathcal{B})^{n+1} \left| \begin{array}{c} \cdots \\ \vdots \\ \vdots \\ \vdots \\ \vdots \end{array} \right| \begin{array}{c} \vdots \\ \vdots \\ \vdots \\ \vdots \\ \vdots \end{array} \left| \begin{array}{c} \cdots \\ \vdots \\ \vdots \\ \vdots \\ \vdots \end{array} \right| \right) \\ &= \text{Hom}_{\mathcal{B}} \left( \mathbb{1}, \left| \begin{array}{c} \cdots \\ \vdots \\ \vdots \\ \vdots \\ \vdots \end{array} \right| \begin{array}{c} \vdots \\ \vdots \\ \vdots \\ \vdots \\ \vdots \end{array} \left| \begin{array}{c} \cdots \\ \vdots \\ \vdots \\ \vdots \\ \vdots \end{array} \right| \right). \end{aligned}$$

□

**7D. The final step.** In Section 4A, we constructed the cocyclic object  $Y^\bullet$  in the category of 3-cobordisms. Next, in Lemma 7.10, we computed the cocyclic  $\mathbb{k}$ -module  $\text{RT}_{\mathcal{B}} \circ Y^\bullet$ . To prove the first part of Theorem 7.1, it suffices to show that the latter is isomorphic to  $\mathbb{F}^\bullet \circ \Phi$ , where  $\Phi: \Delta C \rightarrow \Delta C$  is the reindexing involution from Section 2E. Recall that the coend  $\mathbb{F}$  is a Hopf algebra in  $\mathcal{B}$ , equipped with a non-degenerate Hopf pairing  $\omega$ . Denote its inverse by  $\Omega$ . The isomorphism between cocyclic  $\mathbb{k}$ -modules  $\text{RT}_{\mathcal{B}} \circ Y^\bullet$  and  $\mathbb{F}^\bullet \circ \Phi$  is provided by



the family  $\omega^\bullet = \{\omega^n : \text{Hom}_{\mathcal{B}}(\mathbb{1}, \mathbb{F}^{\otimes n+1}) \rightarrow \text{Hom}_{\mathcal{B}}(\mathbb{F}^{\otimes n+1}, \mathbb{1})\}_{n \in \mathbb{N}}$ , which is defined by setting for any  $n \in \mathbb{N}$  and  $f \in \text{Hom}_{\mathcal{B}}(\mathbb{1}, \mathbb{F}^{\otimes n+1})$ ,

$$\omega^n(f) = \begin{array}{c} \boxed{\omega} \\ \vdots \\ \begin{array}{c} \boxed{\omega} \\ \vdots \\ \boxed{f} \end{array} \\ \vdots \end{array} . \quad (25)$$

The inverse of  $\omega^\bullet$  is given by the family  $\Omega^\bullet = \{\Omega_n : \text{Hom}_{\mathcal{B}}(\mathbb{F}^{\otimes n+1}, \mathbb{1}) \rightarrow \text{Hom}_{\mathcal{B}}(\mathbb{1}, \mathbb{F}^{\otimes n+1})\}_{n \in \mathbb{N}}$ , which is defined by setting for any  $n \in \mathbb{N}$  and  $f \in (\mathbb{F}^{\otimes n+1}, \mathbb{1})$ ,

$$\Omega^n(f) = \begin{array}{c} \vdots \\ \begin{array}{c} \boxed{f} \\ \vdots \\ \boxed{\Omega} \end{array} \\ \boxed{\Omega} \end{array} .$$

It remains to check that  $\omega^\bullet$  is a natural transformation between cocyclic  $\mathbb{k}$ -modules  $\text{RT}_{\mathcal{B}} \circ Y^\bullet$  and  $\mathbb{F}^\bullet \circ \Phi$ . The equations (9) and (10) follow from axioms of a Hopf pairing  $\omega$  and isotopy invariance of graphical calculus. The equation (11) follows from equations (16) and (17), naturality of braiding, and isotopy invariance of graphical calculus.  $\square$

**7E. Sketch of computation of  $\text{RT}_{\mathcal{B}} \circ Y_\bullet$ .** Let us sketch the computation of  $\text{RT}_{\mathcal{B}} \circ Y_\bullet$ , which is similar to computation of  $\text{RT}_{\mathcal{B}} \circ Y^\bullet$  given in detail in Section 7C and 7D. The following lemma is analogously proved as the Lemma 7.8.

**Lemma 7.11.** *If  $T_4$  and  $T_5$  are the following special ribbon graphs*

$$T_4 = \begin{array}{c} \curvearrowright \end{array} , \quad T_5 = \begin{array}{c} \text{[Diagram of a ribbon graph with two crossings]} \end{array} ,$$

then

- (a)  $|T_4| = \varepsilon$ ,
- (b)  $|T_5| = \dim(\mathcal{B})^2 \Delta$ .

Next, by using Lemma 7.11, one obtains an analogue of Lemma 7.9:

**Lemma 7.12.** *We have:*

- (a)  $|G_{Y_\bullet(d_i^n)}| = \dim(\mathcal{B})^n \left| \begin{array}{c} \cdots \\ \vdots \\ \circ \\ \vdots \\ \cdots \end{array} \right|_0^i^n$ ,
- (b)  $|G_{Y_\bullet(s_j^n)}| = \dim(\mathcal{B})^{n+2} \left| \begin{array}{c} \cdots \\ \vdots \\ \cup \\ \vdots \\ \cdots \end{array} \right|_0^j^n$ ,

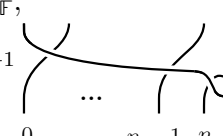
$$(c) |G_{Y_\bullet(t_n)}| = \begin{cases} \dim(\mathcal{B})\text{id}_{\mathbb{F}}, & \text{if } n = 0, \\ \dim(\mathcal{B})^{n+1} & \text{if } n \geq 1. \end{cases}$$

By using Lemma 7.12, one can compute that  $\text{RT}_{\mathcal{B}} \circ Y_\bullet$  is equal to the cyclic  $\mathbb{k}$ -module given by the family  $\{\text{Hom}_{\mathcal{B}}(\mathbb{1}, \mathbb{F}^{\otimes n+1})\}_{n \in \mathbb{N}}$ , equipped with the faces  $\{\text{RT}_{\mathcal{B}}(Y_\bullet(d_i^n))\}_{n \in \mathbb{N}^*, 0 \leq i \leq n}$ , codegeneracies  $\{\text{RT}_{\mathcal{B}}(Y_\bullet(s_j^n))\}_{n \in \mathbb{N}, 0 \leq j \leq n}$ , and cocyclic operators  $\{\text{RT}_{\mathcal{B}}(Y_\bullet(t_n))\}_{n \in \mathbb{N}}$  given by formulas

$$d_i^n(f) = \begin{array}{c} 0 \quad \dots \quad | \quad \circ \quad | \quad \dots \quad n \\ \hline f \end{array}, \quad s_j^n = \begin{array}{c} 0 \quad \dots \quad | \quad \cup \quad | \quad \dots \quad n \\ \hline f \end{array}, \quad t_n = \begin{array}{c} 0 \quad \dots \quad | \quad \dots \quad | \quad n \\ \hline f \end{array}.$$

The latter cyclic  $\mathbb{k}$ -module is isomorphic to  $\mathbb{F}_\bullet \circ \Phi^{\text{op}}$ , where  $\Phi$  is the reindexing involution automorphism from Section 2E. This follows from the fact that the coend  $\mathbb{F}$  is equipped with a non-degenerate Hopf pairing  $\omega$ . Indeed, the isomorphism is given by the family  $\omega_\bullet$ , defined by the formula (25). This completes our proof of Theorem 7.1.  $\square$

## 8. RELATED WORK

In this section we discuss some potentially related perspectives. From algebraic perspective, we review some constructions of paracyclic objects in a braided  $\mathbb{k}$ -category and outline their connections to (co)cyclic  $\mathbb{k}$ -modules from Section 6. These paracyclic objects can be further used to construct  $r$ -cyclic  $\mathbb{k}$ -modules in the sense of Feigin and Tsygan [15]. From topological perspective, we observe a relevance of the one-holed torus, which is a Hopf algebra in  $\text{Cob}_3(1)^{\text{conn}}$ , a cobordism category appearing in [17] and different that the one from Section 3.

**8A. Variations on cyclic category.** For  $r \in \mathbb{N}^*$ , the  $r$ -cyclic category  $\Delta C_r$  is defined in the same as cyclic category, except that the cyclic operators are replaced with  $r$ -cyclic operators  $\{\tau_n: n \rightarrow n\}_{n \in \mathbb{N}}$ , which satisfy (4)-(7) and additionally, for any  $n \in \mathbb{N}$ ,

$$\tau_n^{r(n+1)} = \text{id}_n. \quad (26)$$

Notice that  $\Delta C_1 = \Delta C$ . Another notion similar to that of the cyclic category is the paracyclic category  $\Delta C_\infty$ . Here the cyclic operators are replaced with the *paracyclic operators*  $\{\tau_n: n \rightarrow n\}_{n \in \mathbb{N}}$ , which are isomorphisms satisfying (4)-(7). Mutatis mutandi (see Section 2C) one defines  $r$ -(co)cyclic and para(co)cyclic objects in a category.

The cyclic duality from Section 2D descends to the paracyclic category. Indeed, the key ingredient of proof in [22] is the existence of the so called extra degeneracies, which only relies on the invertibility of (co)cyclic operators. Since the same formulas apply, we abusively denote the paracyclic duality with  $L: \Delta C_\infty^{\text{op}} \rightarrow \Delta C_\infty$ .

**8B. Paracyclic and  $r$ -cyclic objects from braided Hopf algebras.** Any Hopf algebra  $H$  in a braided monoidal category  $\mathcal{B}$  gives rise to a paracyclic object  $\mathbf{C}_\bullet(H): \Delta C_\infty^{\text{op}} \rightarrow \mathcal{B}$ , given by setting for any  $n \in \mathbb{N}$ ,  $\mathbf{C}_n(H) = H^{\otimes n+1}$  and

$$d_i^n = \begin{array}{c} | \quad | \quad | \quad \circ \quad | \quad | \quad | \\ \hline 0 \quad \quad i \quad \quad n \end{array}, \quad s_j^n = \begin{array}{c} | \quad | \quad | \quad \cup \quad | \quad | \quad | \\ \hline 0 \quad \quad j \quad \quad n \end{array}, \quad t_n = \begin{array}{c} | \quad | \quad | \quad \dots \quad | \quad | \quad | \\ \hline 0 \quad \quad n-1 \quad n \end{array}.$$

This construction is functorial, that is, any morphism between coalgebras in  $\mathcal{B}$  induces, in a functorial way, the morphism of corresponding paracyclic objects in  $\mathcal{B}$ .

Similarly, one can associate to  $H$  the paracyclic object  $\mathbf{A}_\bullet(H): \Delta C_\infty \rightarrow \mathcal{B}$ , given by setting for any  $n \in \mathbb{N}$ ,  $\mathbf{A}_n(H) = H^{\otimes n+1}$  and

$$\delta_i^n = \begin{array}{c} \left| \cdots \right| \\ \left| \cdots \right| \\ \left| \begin{array}{c} \circ \\ | \\ \circ \end{array} \right| \\ \left| \cdots \right| \\ \left| \cdots \right| \\ \begin{array}{cc} 0 & i-1 & i & n-1 \end{array} \end{array}, \quad \sigma_j^n = \begin{array}{c} \left| \cdots \right| \\ \left| \cdots \right| \\ \left| \begin{array}{c} | \\ \text{---} \\ | \end{array} \right| \\ \left| \cdots \right| \\ \left| \cdots \right| \\ \begin{array}{ccc} 0 & j & j+1 & n+1 \end{array} \end{array}, \quad \tau_n = \begin{array}{c} \left. \begin{array}{c} \text{---} \\ | \\ \oplus \end{array} \right\} \left. \begin{array}{c} \text{---} \\ | \\ \oplus \end{array} \right\} \cdots \left. \begin{array}{c} \text{---} \\ | \\ \oplus \end{array} \right\} \left. \begin{array}{c} \text{---} \\ | \\ \oplus \end{array} \right\} \\ \left| \cdots \right| \\ \begin{array}{cccc} 0 & 1 & \dots & n \end{array} \end{array}.$$

This construction is functorial, that is, any algebra morphism in  $\mathcal{B}$  induces, in a functorial way, the morphism of corresponding paracyclic objects in  $\mathcal{B}$ .

Notice that if  $\mathcal{B}$  is a ribbon category and if  $H$  is an involutive Hopf algebra in  $\mathcal{B}$  (that is,  $S^2 = \theta_H$ , where  $\theta$  is the canonical twist of  $\mathcal{B}$ ), then the paracyclic operators  $\{t_n\}_{n \in \mathbb{N}}$  of  $\mathbf{C}_\bullet(H)$  satisfy the ‘‘twisted cyclicity condition’’, that is, for all  $n \in \mathbb{N}$ ,

$$t_n^{n+1} = (\theta_{H^{\otimes n+1}})^{-1}. \quad (27)$$

If  $\mathcal{B}$  is additionally  $\mathbb{k}$ -linear, then the cocyclic  $\mathbb{k}$ -module  $H^\bullet$  from Section 6A can be obtained by composing  $\mathbf{C}_\bullet(H)$  with the hom-functor  $\text{Hom}_{\mathcal{B}}(-, \mathbb{1})$ . Here, the cocyclicity condition (8) for  $H^\bullet$  follows by naturality of twists and the fact that  $\theta_{\mathbb{1}} = \text{id}_{\mathbb{1}}$ . In this vein, one derives from  $\mathbf{C}_\bullet(H)$  an  $r$ -cocyclic  $\mathbb{k}$ -module as follows. Namely, if  $i$  is a simple object of  $\mathcal{B}$ , then the twist  $\theta_i$  is a scalar multiple of the identity morphism, still denoted by  $\theta_i$ . If  $\theta_i$  is of finite order  $r$ , then the composition of  $\mathbf{C}_\bullet(H)$  with the hom-functor  $\text{Hom}_{\mathcal{B}}(-, i)$  induces an  $r$ -cocyclic (respectively, cyclic)  $\mathbb{k}$ -module. In a similar way, one obtains  $r$ -cyclic modules from  $\mathbf{A}_\bullet(H)$ . For instance, according to [4], and built on theorems of Vafa [33] and Muger [27], all the twists on simple objects of a  $\mathbb{C}$ -linear ribbon fusion category are roots of unity.

Finally, we point out that the above construction of  $\mathbf{C}_\bullet(H)$  (respectively,  $\mathbf{A}_\bullet(H)$ ) may be restated for coalgebra  $H$  (respectively, algebra) in a braided category with a twist  $\mathcal{B}$ , just like we did in Section 6. Namely, in the above formulas, the square of the antipode should be replaced with the twists. As already remarked in Section 6C, by passing to  $\mathbf{C}_\bullet(H) \circ L$  (respectively,  $\mathbf{A}_\bullet(H) \circ L^{\text{op}}$ ), these constructions fit into a more general framework of Akrami and Majid in [1], who considered ribbon algebras (or dually, coribbon coalgebras) in a braided category.

**8C. Paracyclic and  $r$ -cyclic objects from Crane-Yetter Hopf algebra.** Another relevant category in quantum topology is that of connected 3-cobordisms, further denoted as  $\mathbf{3Cob}$ , which first appeared in [17], which was studied over the last three decades, notably in [18, 16, 2, 8], and most recently in [7]. For each  $g \in \mathbb{N}$ , fix a compact connected oriented genus  $g$ -surface  $\Sigma_{g,1}$  with one boundary component. The objects of  $\mathbf{3Cob}$  are surfaces  $\Sigma_{g,1}$  for each  $g \in \mathbb{N}$ . A morphism  $\Sigma_{g,1} \rightarrow \Sigma_{h,1}$  is given by the connected cobordism from  $\Sigma_{g,1}$  to  $\Sigma_{h,1}$ . In contrast to the category  $\mathbf{Cob}_3$  which is recalled in Section 3B and used throughout the paper, the category  $\mathbf{3Cob}$  is a braided monoidal category, the monoidal product on objects is given by connected sum of surfaces, on morphisms it is given by connected sum of cobordisms, and the unit object is  $\Sigma_{0,1}$ .

It is a result of Crane and Yetter [11], that the one-holed torus  $\Sigma_{1,1}$  has a structure of a Hopf algebra in  $\mathbf{3Cob}$ . By the general construction from Section 8B, one can organize the family of surfaces  $\{\Sigma_{1,1}^{\otimes g}\}_{g \in \mathbb{N}^*} = \{\Sigma_{g,1}\}_{g \in \mathbb{N}^*}$  into a paracyclic object  $C_\bullet(\Sigma_{1,1})$  (respectively, paracyclic object  $A_\bullet(\Sigma_{1,1})$ ) in  $\mathbf{3Cob}$ . The existence of  $C_\bullet(\Sigma_{1,1})$  (respectively,  $A_\bullet(\Sigma_{1,1})$ ) implies that any braided monoidal functor from  $\mathbf{3Cob}$  to a braided monoidal category  $\mathcal{B}$  induces a para(co)cyclic object in  $\mathcal{B}$ . Let  $\mathcal{B}$  be a ribbon unimodular factorizable category

and  $\mathbb{k}$  an algebraically closed field. Here the unimodularity means that  $\mathcal{B}$  is a finite  $\mathbb{k}$ -category in the sense of [12] and that the projective cover of  $\mathbb{1}$  is self-dual. By [7, Theorem 1.2.], there is a braided monoidal functor  $J_3: \mathbf{3Cob} \rightarrow \mathcal{B}$ , which, in particular, sends the one-holed torus to the end  $\mathbb{A}$  of category  $\mathcal{B}$ , that is, an end of functor  $(X, Y) \mapsto X \otimes Y^*$ . Furthermore,

$$J_3 \circ \mathbf{C}_\bullet(\Sigma_{1,1}) = \mathbf{C}_\bullet(\mathbb{A}) \quad \text{and} \quad J_3 \circ \mathbf{A}_\bullet(\Sigma_{1,1}) = \mathbf{A}_\bullet(\mathbb{A}).$$

Note that factorizability in the sense [7] is equivalent to non-degeneracy of coend of  $\mathcal{B}$  (see Remark 9.1). In this setting, the end  $\mathbb{A}$  and the coend  $\mathbb{F}$  are isomorphic Hopf algebras (see Section 9B). By functoriality, paracyclic objects  $\mathbf{C}_\bullet(\mathbb{A})$  and  $\mathbf{C}_\bullet(\mathbb{F})$  (respectively, paracocyclic objects  $\mathbf{A}_\bullet(\mathbb{A})$  and  $\mathbf{A}_\bullet(\mathbb{F})$ ) in  $\mathcal{B}$  are isomorphic. Finally, since  $S_{\mathbb{A}}^2 = \theta_{\mathbb{A}}$ , paracyclic operators of  $\mathbf{C}_\bullet(\mathbb{A})$  (respectively, paracocyclic operators of  $\mathbf{A}_\bullet(\mathbb{A})$ ) satisfy the twisted cyclicity (respectively, cocyclicity) condition (27). Hence, by composing  $J_3 \circ \mathbf{C}_\bullet(\Sigma_{1,1})$  with appropriate hom-functors (see Section 8B), one obtains  $r$ -(co)cyclic  $\mathbb{k}$ -modules.

**Remark 8.1.** Cobordisms in  $\mathbf{3Cob}$  admit surgery presentation by certain tangles (for a review, see [7, Section 4]). On one hand, there is a resemblance between tangles which present structural morphisms of the Hopf algebra  $\Sigma_{1,1}$  and the special ribbon graphs which present generating morphisms of (co)cyclic objects in  $\mathbf{Cob}_3$  (see Theorem 4.1). Note also that in the construction of the latter objects, we do not use the monoidal structure of  $\mathbf{Cob}_3$ . On the other hand, in the contrast with the Kirby calculus on special ribbon graphs from Section 3G, the moves **COUPON** and **TWIST** do not appear as moves between tangles presenting morphisms in  $\mathbf{3Cob}$ . It would be interesting to explore relationships between (co)cyclic objects in  $\mathbf{Cob}_3$  which were constructed in Section 4 and para(co)cyclic objects in  $\mathbf{3Cob}$  from Section 8C.

## 9. APPENDIX

In this section we discuss (co)end of a braided pivotal category  $\mathcal{B}$  via universal (co)actions, the Drinfeld map as in [14], and factorizability.

**9A. (Co)ends via universal (co)actions.** Coend  $(\mathbb{F}, i)$  of  $\mathcal{B}$  can be thought as universal right comodule. Indeed,  $\mathbb{F}$  coacts on each object  $X$  of  $\mathcal{B}$  via the coaction  $\phi_X: X \rightarrow X \otimes \mathbb{F}$ , defined by setting

$$\phi_X = (\text{id}_{X^*} \otimes i_X)(\text{coev}_X \otimes \text{id}_X), \quad \text{depicted by } \begin{array}{c} \downarrow \\ \bullet \\ \downarrow \\ X \end{array} \begin{array}{c} \uparrow \\ \uparrow \\ \uparrow \\ \mathbb{F} \end{array}.$$

This coaction is universal, that is, for any  $D \in \text{Ob}(\mathcal{B})$  and any natural transformation  $\{\gamma_X: X \rightarrow X \otimes D\}_{X \in \text{Ob}(\mathcal{B})}$ , there exists a unique morphism  $f: \mathbb{F} \rightarrow D$  such that for any  $X \in \text{Ob}(\mathcal{B})$ ,

$$\gamma_X = (\text{id}_X \otimes f)\phi_X.$$

The structural morphisms of coend  $\mathbb{F}$  from Section 5S are characterized in terms of the universal coaction as follows. For all  $X, Y \in \text{Ob}(\mathcal{B})$ ,

$$\begin{array}{c} \downarrow \\ \downarrow \\ \downarrow \\ \downarrow \\ X \end{array} \begin{array}{c} \downarrow \\ \downarrow \\ \downarrow \\ \downarrow \\ Y \end{array} \begin{array}{c} \uparrow \\ \uparrow \\ \uparrow \\ \uparrow \\ \mathbb{F} \end{array} \begin{array}{c} \uparrow \\ \uparrow \\ \uparrow \\ \uparrow \\ \mathbb{F} \end{array} \begin{array}{c} \uparrow \\ \uparrow \\ \uparrow \\ \uparrow \\ \mathbb{F} \end{array} \begin{array}{c} \uparrow \\ \uparrow \\ \uparrow \\ \uparrow \\ \mathbb{F} \end{array} = \begin{array}{c} \downarrow \\ \downarrow \\ \downarrow \\ \downarrow \\ X \otimes Y \end{array} \begin{array}{c} \uparrow \\ \uparrow \\ \uparrow \\ \uparrow \\ \mathbb{F} \end{array}, \quad u_{\mathbb{F}} = \phi_{\mathbb{1}} = \begin{array}{c} \downarrow \\ \downarrow \\ \downarrow \\ \downarrow \\ \mathbb{1} \end{array} \begin{array}{c} \uparrow \\ \uparrow \\ \uparrow \\ \uparrow \\ \mathbb{F} \end{array},$$

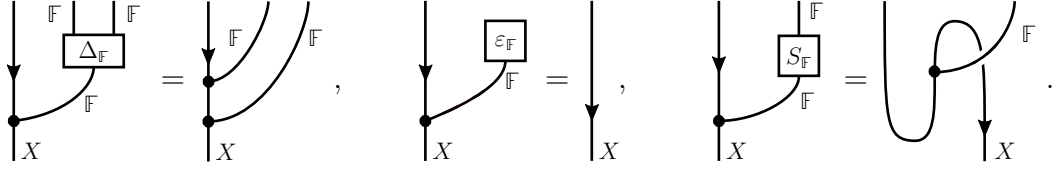

Similarly, end  $(\mathbb{A}, j)$  of  $\mathcal{B}$ , where  $j = \{j_X: \mathbb{A} \rightarrow X \otimes X^*\}_{X \in \text{Ob}(\mathcal{B})}$  is the universal dinatural transformation, can be thought as a universal left module, that is, for each  $X \in \text{Ob}(\mathcal{B})$  there is a left action  $\alpha_X: \mathbb{A} \otimes X \rightarrow X$ , defined by setting

$$\alpha_X = (\text{id}_X \otimes \text{ev}_X)(j_X \otimes \text{id}_X), \quad \text{depicted by } \begin{array}{c} \bullet \\ \text{---} \mathbb{A} \text{---} \\ \text{---} X \text{---} \end{array} .$$

As above, this action is universal, that is, for any  $D \in \text{Ob}(\mathcal{B})$  and any natural transformation  $\beta = \{\beta_X: D \otimes X \rightarrow X\}_{X \in \text{Ob}(\mathcal{B})}$ , there is a unique morphism  $f: D \rightarrow \mathbb{A}$  such that for any  $X \in \text{Ob}(\mathcal{B})$ ,

$$\beta_X = \alpha_X(f \otimes \text{id}_X).$$

The structural morphisms of end  $\mathbb{A}$  (as in [7, Section 7.1.]) are characterized in terms of the universal action as follows: for all  $X, Y \in \text{Ob}(\mathcal{B})$ ,

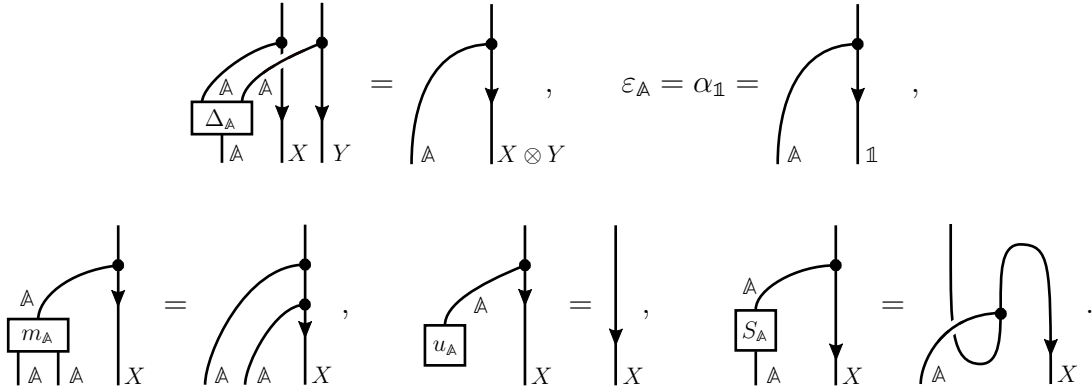

Note that if a coend of a braided pivotal category exists, then an end of it also exists and it is realized as dual of its coend. See [14, Lemma 4.12.] for details.

**9B. Drinfeld map.** By rewriting [14, equation (4.17)] via (co)actions of (co)ends, there is a unique map  $D: \mathbb{F} \rightarrow \mathbb{A}$ , called *Drinfeld map*, such that for all  $X, Y \in \text{Ob}(\mathcal{B})$ ,

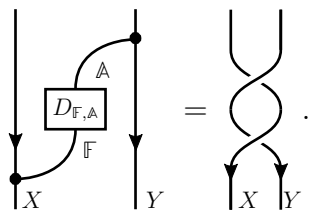

The Drinfeld map is a morphism of Hopf algebras  $\mathbb{F}$  and  $\mathbb{A}$ . Indeed, for all  $X, Y, Z \in \text{Ob}(\mathcal{B})$ ,

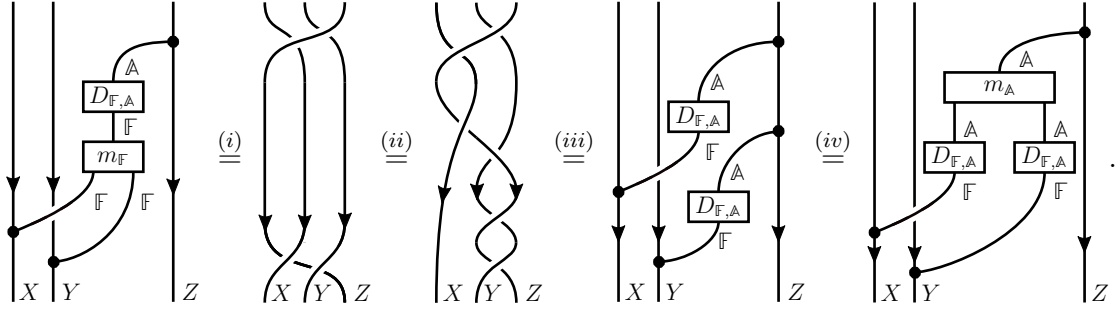

Here (i) follows by definition of  $m_{\mathbb{F}}$  and  $D_{\mathbb{F},\mathbb{A}}$ , (ii) by isotopy, (iii) by definition of  $D_{\mathbb{F},\mathbb{A}}$  and isotopy, and (iv) follows by definition of  $m_{\mathbb{A}}$ .

Next, for all  $X \in \text{Ob}(\mathcal{B})$ ,

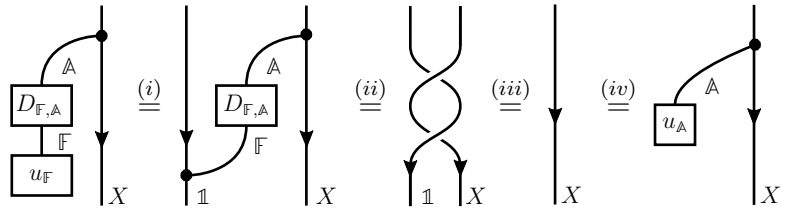

Here, (i) (respectively, (iv)) follows by definition of  $u_{\mathbb{F}}$  (respectively,  $u_{\mathbb{A}}$ ), (ii) by definition of  $D_{\mathbb{F},\mathbb{A}}$ , (iii) by the fact that  $\tau_{\mathbb{1},X} = \text{id}_X$  for any  $X \in \text{Ob}(\mathcal{B})$ . In conclusion,  $D_{\mathbb{F},\mathbb{A}}$  is an algebra morphism. One verifies similarly that it is also a coalgebra morphism.

**Remark 9.1.** A unimodular ribbon category  $\mathcal{B}$  is factorizable (see [14]) if the morphism

$$D_{\mathbb{F}} = \begin{array}{c} \omega \\ \downarrow \\ \mathbb{F} \end{array} : \mathbb{F} \rightarrow \mathbb{F}^*,$$

where  $\omega$  is the Hopf pairing on  $\mathbb{F}$  (see Section 5S), is an isomorphism. The latter is equivalent to the non-degeneracy of  $\omega$  in the sense of Section 5R. Indeed, if  $D_{\mathbb{F}}$  is an isomorphism, then  $\Omega = D_{\mathbb{F}}^{-1} \text{coev}_{\mathbb{F}}$  is an inverse of  $\omega$ . Conversely, if  $\omega$  is non-degenerate with inverse  $\Omega$ , then  $D_{\mathbb{F}}$  is an isomorphism with inverse  $D_{\mathbb{F}}^{-1} = (\text{ev}_{\mathbb{F}} \otimes \text{id}_{\mathbb{F}})(\text{id}_{\mathbb{F}^*} \otimes \Omega)$ .

According to [7, Appendix A.], the factorizability or modularity of in the sense of [7] is equivalent to the notion of factorizability in the above sense. The latter is also equivalent to invertibility of Drinfeld map (see [14, Proposition 4.11.]).

### REFERENCES

- [1] **S E Akrami, S Majid**, *Braided cyclic cocycles and nonassociative geometry*, Journal of mathematical physics 45 (2004) 3883–3911
- [2] **M Asaeda**, *Tensor functors on a certain category constructed from spherical categories*, Journal of Knot Theory and Its Ramifications 20 (2011) 1–46
- [3] **M F Atiyah**, *Topological quantum field theory*, Publications Mathématiques de l’IHÉS 68 (1988) 175–186
- [4] **D Barter, C Jones, H Tucker**, *Eigenvalues of rotations and braids in spherical fusion categories*, Journal of Algebra 515 (2018) 52–76
- [5] **I Bartulović**, *Cyclic sets from ribbon string links*, arXiv:2211.10977 (2022) submitted to Journal of Knot Theory and Its Ramifications

- [6] **I Bartulović**, *On the braided Connes-Moscovici construction*, arXiv:2205.15641 (2022) to appear in Journal of Noncommutative Geometry
- [7] **A Beliakova, M De Renzi**, *Kerler–Lyubashenko Functors on 4-Dimensional 2-Handlebodies*, International Mathematics Research Notices (2023)
- [8] **I Bobtcheva, R Piergallini**, *On 4-dimensional 2-handlebodies and 3-manifolds*, Journal of Knot Theory and Its Ramifications 21 (2012) 1250110
- [9] **A Connes**, *Cohomologie cyclique et foncteurs Extn*, C.R. Acad. Sci. Paris Sér. I Math 296 (1983) 953–958
- [10] **A Connes**, *Non-commutative differential geometry*, Publications Mathématiques de l’IHES 62 (1985) 41–144
- [11] **L Crane, D Yetter**, *On algebraic structures implicit in topological quantum field theories*, Journal of Knot Theory and its Ramifications 8 (1999) 125–163
- [12] **P Etingof, S Gelaki, D Nikshych, V Ostrik**, *Tensor categories*, volume 205, American Mathematical Society (2015)
- [13] **P Etingof, V V Ostrik**, *Finite tensor categories*, Moscow Mathematical Journal 4 (2004) 627–654
- [14] **V Farsad, A M Gainutdinov, I Runkel**,  *$SL(2, \mathbb{Z})$ -action for ribbon quasi-Hopf algebras*, Journal of Algebra 522 (2019) 243–308
- [15] **B L Feigin, B L Tsygan**, *Cyclic homology of algebras with quadratic relations, universal enveloping algebras and group algebras*, K-Theory, Arithmetic and Geometry (1987) 210–239
- [16] **K Habiro**, *Bottom tangles and universal invariants*, Algebraic and Geometric Topology 6 (2006) 1113–1214
- [17] **T Kerler**, *Genealogy of non-perturbative quantum invariants of 3-manifolds: The surgical family*, from “Geometry and physics (Aarhus, 1995)”, Lecture Notes in Pure and Appl. Math. 184, Dekker, New York (1997) 503–547
- [18] **T Kerler**, *Towards an algebraic characterization of 3-dimensional cobordisms*, from “Diagrammatic morphisms and applications (San Francisco, CA, 2000)”, Contemporary Mathematics 318, Providence, RI: American Mathematical Society (2003) 141–174
- [19] **M Khalkhali, B Rangipour**, *A note on cyclic duality and Hopf algebras*, Communications in Algebra 33 (2005) 763–773
- [20] **R Kirby**, *A calculus for framed links in  $S^3$* , Inventiones mathematicae 45 (1978) 35–56
- [21] **W B R Lickorish**, *An Introduction to Knot Theory*, volume 175 of *Graduate Texts in Mathematics*, Springer Science + Business Media, New York (1997)
- [22] **J-L Loday**, *Cyclic Homology*, volume 301 of *Grundlehren der mathematischen Wissenschaften*, Springer-Verlag, Berlin, Heidelberg (1998)
- [23] **V Lyubashenko**, *Modular transformations for tensor categories*, Journal of Pure and Applied Algebra 98 (1995) 279–327
- [24] **S Mac Lane**, *Homology*, volume 114 of *Classics in Mathematics*, Springer-Verlag, Berlin, Heidelberg (1995)
- [25] **S Mac Lane**, *Categories for the working mathematician*, volume 5 of *Graduate Texts in Mathematics*, Springer, New York (1998)
- [26] **S Majid**, *Braided groups*, Journal of pure and applied algebra 86 (1993) 187–221
- [27] **M Müger**, *From subfactors to categories and topology II: The quantum double of tensor categories and subfactors*, Journal of Pure and Applied Algebra 180 (2003) 159–219
- [28] **N Reshetikhin, V G Turaev**, *Invariants of 3-manifolds via link polynomials and quantum groups*, Inventiones mathematicae 103 (1991) 547–597
- [29] **K Shimizu**, *The monoidal center and the character algebra*, Journal of Pure and Applied Algebra 221 (2017) 2338–2371
- [30] **B L Tsygan**, *The homology of matrix Lie algebras over rings and the Hochschild homology*, Russian Mathematical Surveys 38 (1983) 198
- [31] **V G Turaev**, *Quantum invariants of knots and 3-manifolds*, volume 18 of *De Gruyter Studies in Mathematics*, De Gruyter, Berlin, New York (2010)
- [32] **V Turaev, A Virelizier**, *Monoidal categories and topological field theory*, volume 322 of *Progress in Mathematics*, Birkhäuser, Basel (2017)
- [33] **C Vafa**, *Toward classification of conformal theories*, Physics Letters B 206 (1988) 421–426
- [34] **A Virelizier**, *Kirby elements and quantum invariants*, Proceedings of the London Mathematical Society 93 (2006) 474–514

[35] **C A Weibel**, *An introduction to homological algebra*, volume 38 of *Cambridge studies in advanced mathematics*, Cambridge university press (1994)

TECHNISCHE UNIVERSITÄT DRESDEN, INSTITUT FÜR GEOMETRIE, ZELLESCHER WEG 12–14, 01062  
DRESDEN, GERMANY

*Email address:* `ivan.bartulovic@tu-dresden.de`