

## **Evaluation of The Concentrations of Naturally Occurring Radionuclides in Construction Material Used in Ignimbrite Rocks From South Gondar, Checheho Medihanialem, Ethiopia**

Getahun Kebede<sup>1\*</sup>, Getachew mengesha<sup>1</sup>

Department of physics<sup>1</sup>, Mizan Tepi University

Department of physics<sup>2</sup>: University of Gonder

Email<sup>1\*</sup>: [gkebede120@gmail.com](mailto:gkebede120@gmail.com)

Email<sup>1</sup>: dailywork872@gmail.com

### **Abstract**

The current study was carried out to determine the concentrations of primordial radionuclides ( $^{238}\text{U}$ ,  $^{232}\text{Th}$  and  $^{40}\text{K}$ ) in commonly used building materials (brick, cement and sand), the raw materials of cement and the by-products of coal-fired power plants (fly ash) collected from various manufacturers and suppliers in the Checheho, South-Gondar area of Ethiopia's northern eastern Amhara Region. To evaluate the potential radiological risk to individuals associated with these building materials, various radiological hazard indicators were calculated. The levels of naturally occurring radionuclides  $^{238}\text{U}$ ,  $^{232}\text{Th}$  and  $^{40}\text{K}$  were measured in four separate environmental samples (ignimbrite rock). The collected samples were then adequately processed for scintillation detector NaI(Tl), gamma spectrometry measurements and storage in an airtight container for more than 28 days to achieve radioactive equilibrium between daughters and parents of the  $^{226}\text{Ra}$ ,  $^{238}\text{U}$  and  $^{232}\text{Th}$  decay series. The average activity concentrations of radionuclides were compared to the NCRP and UN-SCEAR reference values as well as the global average value are lower than the recommended world average value. Furthermore, the dose rate and other radioactive hazard indices ( $H_{in}$ ,  $H_{ex}$ , and  $I_{\gamma}$ ) in ignimbrite rock samples are found to be lower than the UNSCEAR reference levels that recommended as international standards. Generally, the results indicated that the ignimbrite rock in the study area might not pose significant hazards to members of the public.

Keywords: Radionuclides, Igneous, Tuff, Metamorphic, Terrestrial Radionuclide, Naturally occurring Radionuclides

## 1. INTRODUCTION

There are primordial radionuclides in the environment everywhere in the world in different isotopic forms, and ionizing radiation from natural sources is something that humans are always exposed to. Natural environmental radioactivity is primarily determined by local geological and geographical factors, and it is particularly related to rock types at which the principal elements that contribute to natural terrestrial radioactivity are uranium (U), thorium (Th), and potassium (K). Most human activities involving minerals and raw materials result in levels of radionuclide exposure that are not significantly higher than typical background levels and are therefore not concern for radiation protection.

Certain work activities, on the other hand, can result in dramatically increased exposures that may need to be regulated. All of the U and Th decay series elements are incompatible in the major rock forming minerals, such as quartz, olivine and pyroxenes. All of these accessory minerals and feldspars also enhance in silica-saturated acidic magmatic rocks such as granite, rhyolite, syenite and pegmatite compared with intermediate, basic and ultrabasic rocks and thus higher radiation levels are associated with such rocks [1]. Beach sands are mineral deposits and are originated generally in the magmatic rocks such as granite, rhyolite, andesite etc., which may be rich in U and Th bearing accessory minerals.

The most important sources of ionizing radiation on Earth are the radionuclides in the natural decay series ( $^{238}\text{U}$ ,  $^{232}\text{Th}$ , and  $^{40}\text{K}$ ), which account for around 83% of the total effective dosage that people worldwide receive [2, 3]. We can eradicate radiation from our environment because it is inherently present. However, we can lower our health risks by limiting our exposure to it [4]. As a result of radiation applications, individuals can be exposed to radiation emitted by various radioactive sources depending on their activity and surroundings [5].

Hence, radionuclides are found naturally in air, water and soil, they are even found in our human body, being that we are products of our environment. Natural radioactivity is common in rocks and soil that makes up our planet, therefore in our building materials and homes. Generally, natural building materials reflect the geology of their site of origin [6]. Several rocks, especially the metamorphic ones, emit natural radiation. Metamorphic rocks, particularly granite, comprise all the radioisotopes of the half-life chain [7, 8]. Granite material birthed by metamorphic rock, commonly employed in building for decoration, poses a dangerous threat through a confined space to humans after a long exposure [9, 10].

Therefore, Radiation, on the other hand, moves from its source in the form of energy waves or energetic particles. There are two forms of radiation: ionizing radiation (IR) and non-ionizing radiation (NIR), with the former being more energetic than the latter. As a result, it can ionize atoms by knocking electrons out of them. Because ionizing radiation can influence the atoms in living things, it poses a health risk by causing tissue and DNA damage in genes. Ionizing radiation's most prevalent forms are  $\alpha$ -particles,  $\beta$ -particles, and gamma-rays.

Radiation levels presented by (NORM) are generally referred to as a component of natural background radiation while the term Technologically Enhanced Naturally Occurring Radiation Material (TENORM) is defined as: Naturally occurring radioactive materials that have been concentrated or exposed to the accessible environment as result of human activities such as manufacturing mineral or water processing [11].

All building materials contain various amounts of natural radioactive nuclides. Materials derived from rock and soil

contains mainly natural radioactive of the Uranium ( $^{238}\text{U}$ ) and Thorium ( $^{232}\text{Th}$ ) series and the radioactive isotope of potassium ( $^{40}\text{K}$ ).

It is therefore imperative to assess public exposure to radiation in building materials as the majority of the population has an indoor time frame of 80%. [12]. It has been reported that building materials contain naturally occurring radionuclides and are responsible for external radiation exposure risks in residences [13, 14]. Gamma radiation has been the potential radiation source originating from uranium and thorium series and from K-40 [15, 16]. The activity concentrations of radionuclides in these building materials are determined by mineralogy and geochemistry [17]. It is referred to as technologically enhanced naturally occurring radioactive materials (TENORM) when processed building materials possess much higher radioactive concentrations than raw building materials [18].

The decay chain segment beginning with Radium ( $^{226}\text{Ra}$ ) is radiologically the most important in the Uranium series, and so Radium is frequently used instead of Uranium. Radium, Thorium, and Potassium average concentrations in the earth's crust are 35Bq/kg, 30Bq/kg, and 400Bq/kg, respectively [19].

This work is concerned in Naturally Occurring Radioactive Material (NORM), which is defined as materials that may contain any of the primordial radionuclides or radioactive elements found in nature. Therefore, human environment is radioactive and human beings are exposed to radiation arising from sources including cosmic rays, natural radionuclides in water, air, soil and plants; and artificial radioactivity from fallout in nuclear testing and medical applications.

Granite is typically utilized in Nigeria for building and road construction. The use of rocks as building materials will subject the habitat inside the structure to radiation because the rocks contain naturally occurring radionuclide materials (NORMs). Depending on the rock formations and the geochemical properties, the amounts of natural radionuclides in construction materials can vary significantly. There is no reference level in the North geopolitical zone, specifically in north wollo, checheho kebele. The majority of people in the area have constructed their houses using different building materials, formed mostly from rocks.

There is inadequate knowledge about the assessment of naturally occurring radionuclides that result from various building materials used for construction in the Lay Gayint district, such as sand, granite (stone), ignimbrite rock, and cements that originated and were manufactured in Ethiopia. However, several studies on the risks of human exposure and the impact of ionizing radiations from NORM due to these materials used for construction from other places have been documented. Similarly, there are little or no data records on radon assessments in homes and workplaces on this site.

Therefore this study is fairly significant because adequate data is important for regulatory and advisory purposes in protection of the general public from unnecessary exposure to radiation. Thus, measurement of radioactivity concentration of naturally occurring radionuclide in construction building materials and measurement of indoor radon concentrations will be significantly contributing to the research field concerning radiation protection in the construction materials.

## **2. EXPERIMENT AND METHODOLOGY**

### **2.1. Instruments used in this study**

This study uses Maestro-32 capture a multichannel analyzer (MCA) “emulation” software package that is compatible with gamma and alpha spectroscopy system and Microsoft excel for data analysis. In this thesis the following laboratory Equipment were used during experiment: Plastic bag(polythene bag), Beam balance, concrete shielding materials, Mortar and Pestle (grinder), Minnelli beakers, oven used for drying samples, Scientific sieve of 1mm mesh size, Scintillation detector NaI(Tl) were used.

#### **2.1.1. Activity Concentration of building materials sample and their raw materials**

In the present work, two techniques are used for the measurement of the specific activity concentration of radionuclides, in addition to the preparation of standard sources. The first one is for gamma analysis by using gamma spectrometry system with scintillation detector NaI(Tl) and the second one is for the alpha analysis by measuring radon concentration which emitted from building material samples, using sodium iodide detector NaI(Tl). The radioactivity of the samples was measured on gamma spectrometry with scintillation detector which has a relative efficiency of 8.3% and energy resolution of  $keV$  (FWHM) at  $keV$  a peak-to-Compton ratio 80:1. The background was also counted under the same condition for second and subtracted from the background area for the measured samples during analysis process. Following the sample analysis-process, the specific activity concentration in Becquerel per kilogram for each radionuclide was calculated automatically by maestro-32 software keeping the sample one by one on the top of the detector and counted for a period of 36000 second and then the activity concentration (A) of each radionuclide in the sample was determined.

#### **2.1.2. Description of the study area**

This study was conducted at checheho kebele which is located in south gonder, amhara Ethiopia at 726km from the capital adisababa. This kebele has a latitude and longitude of 110:48'8'' north and 380:33'33'' east on elevation of 2235.00meters/7332.68ft on the elevation map with a total population of lay gaynt district 206499[20]. The complex is found between debrezeit and nefas mewucha on the road from woldia to bahrdar also known as the chines road and bekilo angit (meaning mule sequester and the derivation of the name is related to emperor tewodros. The site is to the east of the road side build church of medhanealem checheho. A second build church kidane mihret is found immediately below the complex. Felegethehay checheho medhanealem cathedral was established in the third century and holds various invisible historical and religious events.

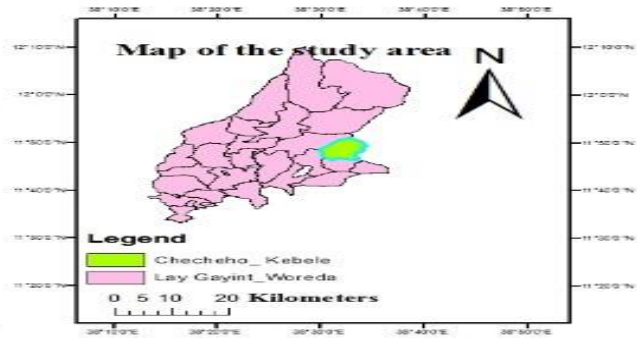
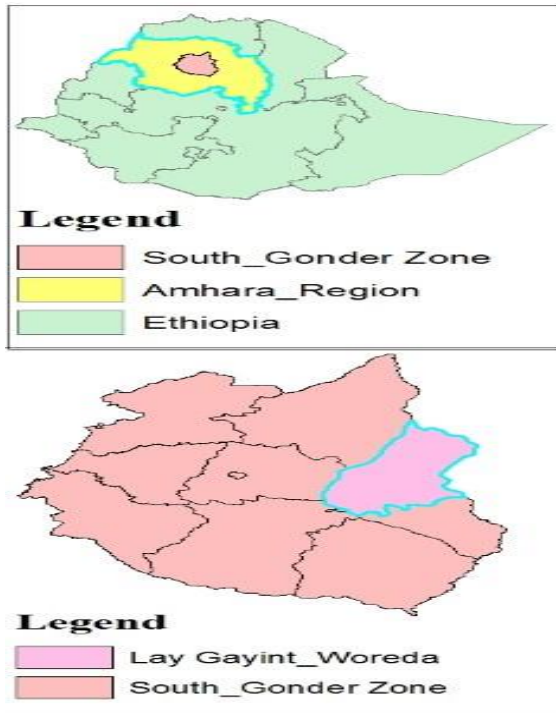

Figure 2.1: Map of the study area(provided by Google Map).

## 2.2. Methodology of the study

### 2.2.1. Sampling collection and Preparation

Using gamma-ray spectroscopy and the scintillation detector, the natural radioactivity (radionuclides) concentration in ignimbrite rock samples from the checheo and worki-washa areas determined in this paper. The samples are preparing in the concrete shielding in the school of house, building material and measure the radiation in Wollo University.

The research samples are comprised of building materials that are (Ignimbrite rock) stone at which ignimbrite rock samples were collected during the year of an experiment, 2022. A total of 4 stone samples in Lay Gaint discrit in checheho medihanialem and meket in worki-washa Geoyorgis at a local known as Lay-qiranbia kidanemhired, tach-qiranbia kidanemhired, Worki washa Goyorgis and Angagifo at a distance of 400m, 1km, 1.5km respectively from Lay-qiranbia kidanemihret were collected randomly from the sites for measurement of the specific radioactivity of  $^{238}\text{U}$ ,  $^{232}\text{Th}$  and  $^{40}\text{K}$ . All Ignimbrite rock samples were collected from holes having a depth of 2 – 5cm each and unwanted materials (such as plant leave, vegetation, roots and soils) were separated from the collected samples. The 500gm from each stone samples was placed in a well labeled polyethen bag and was sealed to avoid contamination of the samples during transportation to the laboratory.

The samples were dried at a temperature of  $80^{\circ}\text{C} - 120^{\circ}\text{C}$  for 24hr to remove the wetness, crushed and sieved through bag 1mm mesh. The dried samples were transferred to polyethylene Marinelli beakers or standard cans of volume 0.5 litter and sealed. Each deposit samples was left for at least month to reach secular equilibrium between radium, thorium and their progenies. The collected samples were crushed to fine powder with a particle size 1mm and sieved in order to achieve homogenized sample size. The powdered samples were packed in a standard Marinelli beaker and the lid was then tightened. The samples were sealed and left for 30 days before counting by gamma spectrometry in order to ensure that the daughter products of  $^{232}\text{Ra}$  and  $^{40}\text{K}$  are in secular equilibrium with their respective parent radionuclides.



Figure 2.2:



Figure 2.3:



Figure 4.4: the sample code, Weight, type and origin of essential building materials stone (Ign- imbrite rock)

### 2.2.2. Experimental Setup

In this experiment, the activity concentration of radionuclides  $^{238}\text{U}$ ,  $^{232}\text{Th}$  and  $^{40}\text{K}$  were measured by using a gamma spectrometry system which consists of the following components:

The basic components are Detector and high voltage power supply and Multichannel analyzer Detector type:- The most common detectors in gamma spectrometry system are Sodium Iodide (NaI), Scintillator detector with NaI (Ti) and High Purity Germanium (HPGE) but Sodium iodide is the best detector in my doing. Two Functions of the detector are A pulse is produced for each gamma ray interacting in the detector and the greater the energy deposited in the detector, the larger the pulse.

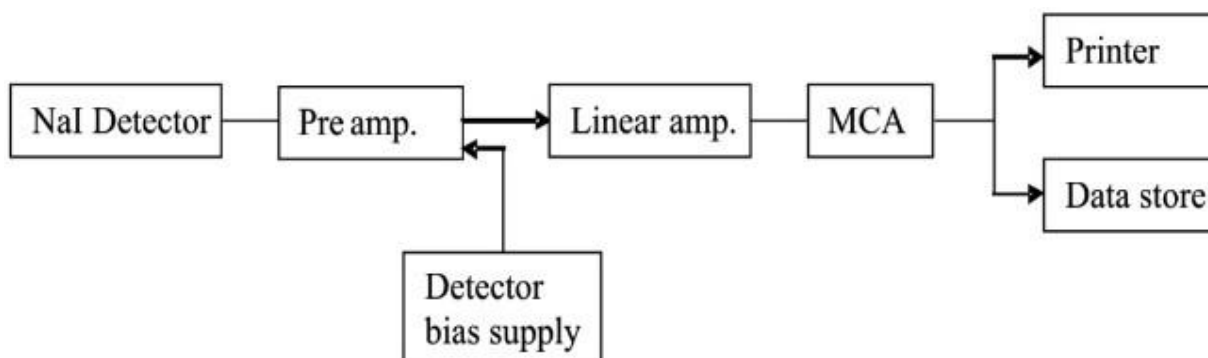

Figure 2.5: Electronic block diagram for scintillation detector, Multi-channel analyzer

The MCA contains most of the system's electronics. In the laboratory, the memory, display and analysis function of the MCA are usually handled by a computer. Three functions of the MCA, Count the pulses from the detector, the number of pulses can be related to the activity of the radionuclides in the sample (gamma spectrometry), and Measure the size of the pulses (pulse height analysis).

### 2.2.3. Data Analysis Method

In this study, gamma spectrometry analysis system was used to measure the activity concentration of  $^{226}\text{Ra}$ ,  $^{232}\text{Th}$  and  $^{40}\text{K}$  in building materials and to measure the indoor radon concentration individuals living in checheho and worki-washa village.

### 2.2.4. Calibration

It is a set of operation that establish under specified condition, the relationship between values of quantities indicated by a measuring instrument or measuring system and the corresponding values realized by standard can be done. NaI(Tl) scintillation detectors are known to have comparatively poorer resolution than germanium detectors, but are preferable in some specific types of analyses due to their relatively higher efficiency and besides, operates under room temperature conditions (i.e without the uses of liquid nitrogen gas as germanium detector).

The full width at half maximum (FWHM) which is a measure of the resolution of the counting system for NaI(Tl) detector is typically in a range of 7% – 9% in contrast with HPGE detector with resolution in a range of 0.1% – 0.2% . The smaller the figure for the energy resolution, the better the detector will be able to resolve between two radionuclides whose energies lie close to each other. The thallium activator, which is present as an impurity (about 0.2%) in the crystal structure of NaI (Tl) detector converts the energy absorbed in the crystal to light. In addition to the high density of the crystal (about  $3.67 \text{ gcm}^{-3}$ ), the high effective atomic number accounts for the high efficiency of the NaI (Tl) than HPGE detectors.

Atypical NaI (Tl) scintillation detector is shown in Fig.2.3 In general; there are two calibration steps to determine the performance of a gamma spectrometry system.

Firstly, energy calibration is performed, where the pulse heights scale is calibrated in terms of gamma-ray energy to enable the exact identification of photo peaks present in the spectrum produced by the detector



system. Energy calibration of the detector system is performed by measuring mixed standard sources of known radionuclides with well-defined energies within the energy range of interest, usually  $60\text{keV} - 2000\text{keV}$ . The energy calibration relates the channel number of the spectrometer system to energy of the standard reference material. The relationship between energy and the channel number is given as follows [21].

$$E = \sum_{i=0}^n A_i (C_n)^i \quad (2.1)$$

$$\epsilon_{abs} = \frac{\text{event recorded}}{\text{event emitted by source}} \quad (2.2)$$

Where  $E$  is the energy (keV) of the corresponding gamma line;  $C$  is the channel number;  $i = 0, 1, 2, 3, n$ , which is associated with the energy  $E$ ;  $A$  is a calibration constant.

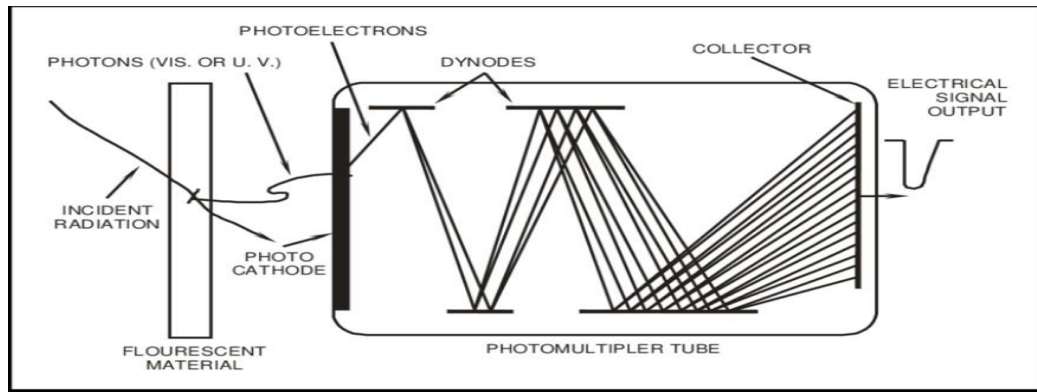

Figure 2.6: schematic diagram of the sequences of events in scintillation detector

The second step is the efficiency calibration, which involves measuring reference standard sources (i.e. sample) to obtain efficiency over the region of interest. Efficiency of the detector, in general, is defined as the ratio of the actual events registered by the detector to the events emitted by the source, and absolute efficiency is the ratio of events emitted by the source that is actually recorded by the detector. This is dependent on the properties of the detector and the design of the counting geometry.

**Intrinsic efficiency:** is also defined as the fraction of the events actually incident on the detector to that which are recorded.

$$\epsilon_{intr} = \frac{\text{event recorded}}{\text{event impinging on the detector}} \quad (2.3)$$

**Intrinsic efficiency** is a basic parameter of the detector. It is independent of the source and detector geometry. It is a function of the type of radiation, the energy of radiation, the detector material, and the physical thickness of the detector in the direction of the incident radiation.

The issue of efficiency is generally more important for neutral particles because they must first interact to produce charged particles. The interactions are often rare; so that it is important to capture a good fraction of the incident neutral particles.

**Efficiency calibration** of the gamma detection system is necessary for the quantification of the radionuclides

present in a sample. In efficiency calibration, a source with known nuclide activity and gamma emission probability over the region of interest is required. In order to calculate activities of the nuclides, the user has to supply the computer program with detector efficiency as a function of the gamma-ray energy (efficiency curve) [22]. The following factors are taken into account during the efficiency calibration; sample counting geometry, calibration method, calibration sources and the analytical efficiency expression.

It is recommended that the geometry of the reference standard materials should be the same as those used for the samples, such like Marinelli beakers used for the standard mixed radionuclide and also for the samples. Several theoretical calibration methods exist for use, but it is recommended that efficiency calibration be determined experimentally for environmental measurements. Appropriate radionuclides must be selected as standards to perform efficiency calibration. The certificate accompanying the certified mixed radionuclides should state with: uncertainty associated with activity, reference date, purity, mass or volume, chemical composition, values of half-lives, branching fractions for all modes of decay and the method of measurement of the radionuclides in the standard. Efficiency calibration curves are usually represented by expressing the efficiency as a function of energy. The generally accepted and simple expression is as follows .

$$\ln \varepsilon = a_1 + a_2 \ln E \tag{2.4}$$

(where  $\varepsilon$  is the absolute full energy peak efficiency;  $a_1$  and  $a_2$  are fit parameters; E is the energy (keV) of the corresponding gamma line. This expression is suitable for determining efficiency of gamma energies from 200 to 2000 keV.

Samples should be counted in the same type of container used to obtain the efficiency calibration. The density, volume and height of sample in the container must be the same as that of the standards used for the calibration [29]. The purpose of the study was to investigate the performance of newly installed NaI (TI) gamma spectrometry system to be used for analysis of radionuclides in ignimbrite rock samples.

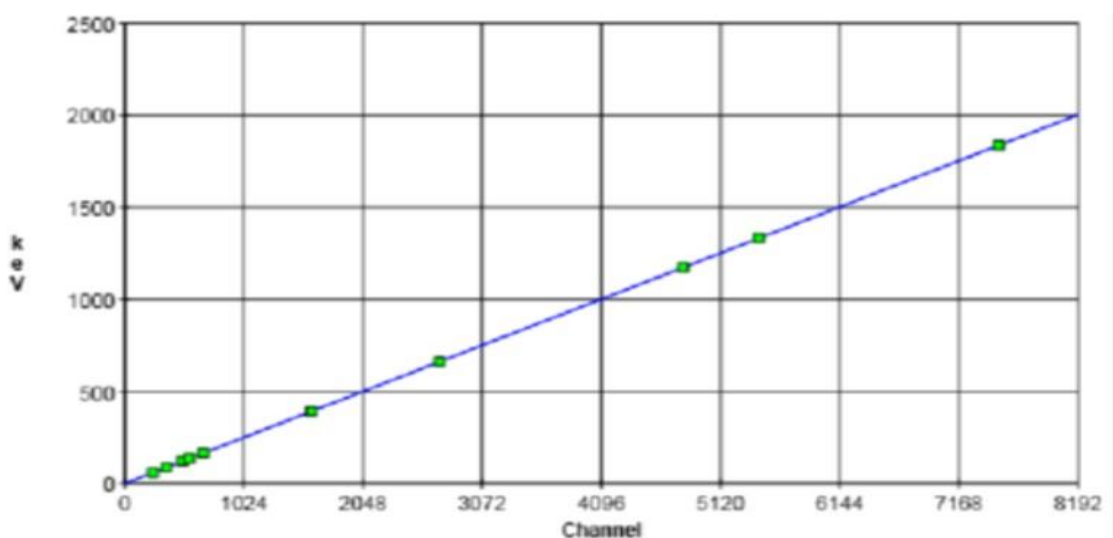

Figure 2.7: Calibration curve by standard check sources in the region of interests.

### 2.3. Energy and Efficiency calibration

Before any actual counting of samples, the scintillation detector was respect to energy and efficiency. The aim of energy calibration is to identify radionuclides in the sample by deriving a relationship between spectrum peak position and the corresponding gamma-ray energy. Energy calibration is performed by gamma-ray of precisely known gamma ray measuring the spectrum of a standard source emitting energy and comparing the measure peak position with their energy. In this study, the energy calibration was carried out by counting standard radionuclides of known activities emitting gamma energy in the energy range from 239KeV to 1461KeV. The standard counted for 10hour.

A good multi-channel analyzer has a linear response in it full dynamic range. That is bins of the MCA are directly proportional to the energy absorbed in the gamma spectrometry detector. This implies that, if one plots the absorbed energy against the channel number of theMCA.

The result was linear in line as shown in fig above, which is an indication that the system is operating properly [23]. The accuracy of all quantitative results will be depending on efficiency calibration of the system. Efficiency can be defined in number of different ways:-

The first one is absolute efficiency based on the number of radiation emitted by the source, and the second is intrinsic efficiency based on the number of radiation strike the detector.

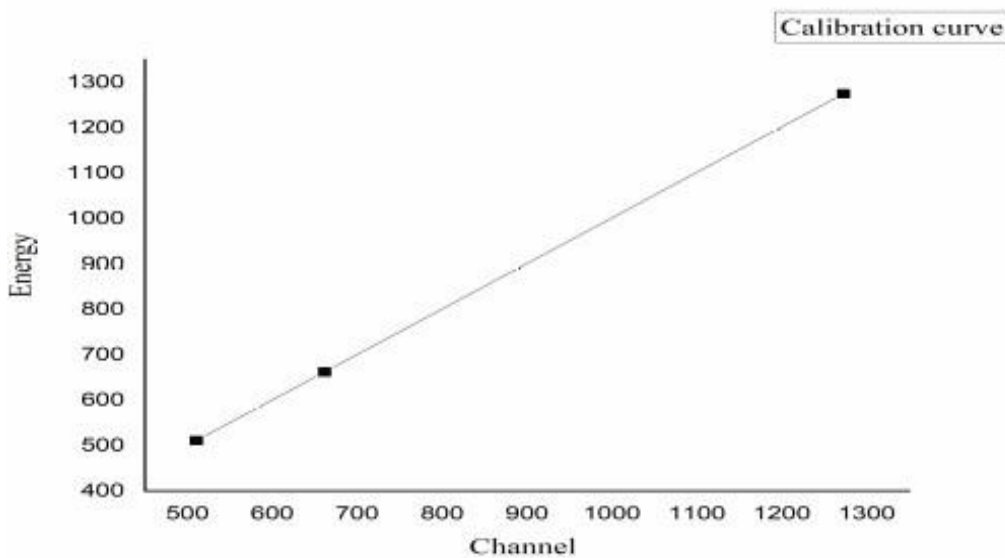

Figure 2.8: Energy calibration

### 2.4. Half-life

The activity half-life ( $T_{\frac{1}{2}}$ ) is the interval in which the original number radioactive nuclei or their activity is reduced to one-half. It is dynamical process governed by exponential decay has remarkable property. The half-life of the various radioactive elements varies with in very wide limits, from microseconds ( $\mu$ s) to thousands of millions of years [24].

$$T_{\frac{1}{2}} = \frac{\ln 2}{\lambda} = \frac{0.693}{\lambda} \quad (2.5)$$

## 2.5. Specific Activity concentration

The activity concentrations of the samples were determined using the net area under the photo peaks using Equation:

$$A(\text{sam}) = \frac{NPA(\text{samp})m(\text{stan})}{NPA(\text{stan})m(\text{samp})} \quad (2.6)$$

Where A is the activity concentration of the radionuclide in the sample given by  $Bq/kg^{-1}$ , m(sample) mass of the sample activity concentration, m(standard) mass of the standard activity concentration NPA(standard) is the Net photo peak area in standard(keV), NPA(sample) is the net photo peak area in the given sample(keV).

## 2.6. Radiological Effects Radiation dose calculation

The main purpose of assessing naturally occurring radiation (radioactivity) is to make an estimate of the possible radiation dose to be delivered externally to the general public. Exposure to radiation can be defined in terms of many hazard parameters.

Radium equivalent activity ( $Ra_{eq}$ ) is a widely used hazard index. Since the distribution of  $^{238}\text{U}$ ,  $^{232}\text{Th}$  and  $^{40}\text{K}$  in the environment is not the same, so that the radiological effect of the radiation can be measured through radium equivalent activity ( $Bq/kg$ ), gamma radiation absorbed dose rate ( $nGy/h$ ), the annual effective dose equivalent ( $Sv/y$ ), the external and internal radiation hazard index and gamma index.

### 2.6.1. Radium Equivalent activity ( $Ra_{eq}$ )

The  $Ra_{eq}$  activity index represents the weighted sum of activity concentrations of the natural radionuclides  $^{238}\text{U}$ ,  $^{232}\text{Th}$  and  $^{40}\text{K}$ . It is based on the assumption that  $370Bq/kg$  of  $^{238}\text{U}$  or  $259Bq/kg$  of  $^{232}\text{Th}$  and  $4810Bq/kg$  of  $^{40}\text{K}$  produces the same gamma radiation dose of  $1.5mGy/y$ , equal to  $1mSv$  annual effective dose [25]. The maximum radium equivalent activity ( $Ra_{eq}$ ) in building materials samples must be less than  $370Bq/kg$ , in order to keep the external dose below  $1mSv$  per year. The radium equivalent activity index was given as:

$$Ra_{eq} = U_A + 1.43Th_A + 0.077K_A \quad (2.7)$$

Where  $U_A$ ,  $Th_A$  and  $K_A$  are the activity concentrations of  $^{238}\text{U}$ ,  $^{232}\text{Th}$  and  $^{40}\text{K}$  in  $Bq/kg$  respectively. The permissible maximum value of the radiation equivalent activity is  $370Bq/kg$ .

### 2.6.2. Determination of radiation hazards

The gamma-ray spectrometry setup used in this analysis consists of a highly shielded and well calibrated  $45cm$ ,  $45cm$  and by  $60cm$  NaI (TI) detector enclosed in a  $2.5cm$  thick aluminum shield to assist in reducing background radiation. In addition, the setup was coupled with a computer based Multichannel Analyzer (MCA) which was used for the data acquisition and analysis of gamma spectra. The natural radioactivity of building materials can be estimated using external and internal radiation indices. These indices limit the radiation dose to a dose equivalent limit of  $1mSv/y$ .

For safe use of building material samples the external ( $H_{ex}$ ) and internal indices ( $H_{in}$ ) should be each less than unity.

### (A) External Hazard Index ( $H_{ex}$ )

The external radiation hazard arises from sources of radiation outside the body. The external radiation exposure occurs when part or all body is exposed to a penetrating gamma radiation that comes from radioactive materials existing in the ignimbrite rock. For the estimation of gamma radiation dose measurement, the external hazard index ( $H_{ex}$ ) is measured by the following equation [26],

$$H_{ex} = \frac{U_A}{370} + \frac{Th_A}{259} + \frac{K_A}{4810} \leq 1 \quad (2.8)$$

The  $H_{ex}$  must not exceed the limit of unity for the radiation hazard to be negligible.

Note that: Alpha and Beta particles, in general, constitute no external exposure hazard because the particles generally do not pass through skin.

**External ( $\gamma$  radioactivity) level index ( $I_\gamma$ ):** this index is also known as a representative level index & was calculated from the following relation:

$$I_\gamma = \frac{Ra_A}{300} + \frac{Th_A}{200} + \frac{K_A}{3000} \leq 1 \quad (2.9)$$

The OECD group of experts suggested sum criteria for a definition of different levels of to be (representative, first enhanced, secondly enhanced).

$I_\gamma = 1$  As an upper limit,  $I_\gamma \leq 1$  corresponds to  $0.3mSv/y$ .

$I_\gamma \leq 3$  Corresponds to  $1mSv/y$ [27].

### (B) Internal Hazard Index ( $H_{in}$ )

The most internal exposure is from radon and its products that are concentrated in indoor places. The  $H_{in}$  estimated of potential radiological hazard are expressed by the internal hazard index  $H_{in}$  satisfy criteria[28]. For the safe use of a material in the concentration of dwellings, should be less than unity and satisfy the following criteria.

$$H_{in} = \frac{Ra_A}{185} + \frac{Th_A}{159} + \frac{K_A}{4810} \leq 1 \quad (2.10)$$

Where  $H_{in}$  is the internal hazard index and  $Ra_A$ ,  $Th_A$  and  $K_A$  are the activity concentration of  $^{226}\text{Ra}$ ,  $^{232}\text{Th}$  and  $^{40}\text{K}$  respectively. For the safe use of a material in the construction of dwellings, the maximum value of  $H_{in}$  should less than unity [29].

**Internal ( $\alpha$  radioactivity) level index  $I_\alpha$ :** The excess alpha radiation due to radon inhalation originating from building materials is estimated using the relation below

$$I_\alpha = \frac{Ra_A}{200} \leq 1 \quad (2.11)$$

less than 200Bq/kg could not indoor radon concentration [30].

It should be lower than the maximum permissible and value of  $I_\alpha \leq 1$  which corresponding to 200Bq/Kg for alpha radiation & taking into consideration that a building materials with  $^{226}\text{Ra}$  concentration.

### 2.6.3. Absorbed Dose rate (ADR) in air

The effect of gamma radiation originating from radioactive sources in the environment are generally expressed in terms of the total gamma radiation absorbed dose rate in air, Dr. The absorbed gamma dose rate ( $nGy/h$ ) in the outdoor air at 1m above the ground due to the activity concentration of  $^{238}U$ ,  $^{232}Th$  and  $^{40}K$  can be calculated using the following formula [31]. The activity concentration of  $^{238}U$ ,  $^{232}Th$  and  $^{40}K$  are converted in to dose rates by applying the conversion factors 0.462, 0.604 and 0.0417 ( $nGy/h, kg/Bq$ ) of uranium, thorium and potassium in  $1Bq/kg$  activity respectively [32]. These factors are used to calculate the total dose rate (DR) in ( $nGy/h$ ),

$$ADR(Gy/h) = 0.462U_A + 0.604Th_A + 0.017K_A \quad (2.12)$$

The calculation refers to the dose rate in air at a height of 1m above the ground, if the naturally occurring radionuclides are uniformly distributed. The activity concentrations of the three radionuclides  $^{238}U$ ,  $^{232}Th$  and  $^{40}K$  were multiplied by the corresponding dose rate conversion factor (DRCF) which is the absorbed dose rates in air per unit activity per unit of ignimbrite rock ( $Gy/h/Bq/kg$ ). Where ADR is the absorbed dose rate ( $nGy/h$ ) at 1m above the ground due to  $^{238}U$ ,  $^{232}Th$  and  $^{40}K$  in the ignimbrite rock samples.  $U_A$ ,  $Th_A$ , and  $K_A$  are the activity concentrations of  $^{226}Ra$ ,  $^{232}Th$  and  $^{40}K$  in  $Bqkg^{-1}$  respectively.

The absorbed dose rate is two types, these are:

#### a. Annual Outdoor Effective Dose Rates ( $E_{out}$ )

The annual effective dose rate (in Gy/h) is calculated by using the following equation.

$$E(out)(in Sv/h) = ADR(Gy/h) \times DCF \times OF_{out}$$

$$E(out)(in Sv/h) = ADR(Gy/h) * 0.7(Sv/Gy) * 20\% \text{ of } 8760h$$

$$E(out)(in \mu Sv/h) = ADR * 1.226 \mu Sv \quad (2.13)$$

Where ADR is absorbed dose rate (in  $nGy/h$ ), ADR units are in  $Gy/h$ , DCF is dose conversion factor ( $0.7Sv/Gy$ ), and  $OF = F * 24hrs * 365.25$  days. The adult spend about 80% of their time indoors, while the remaining 20% time is spent outdoor. Therefore, the indoor and outdoor occupancy factors were given as  $F_{in} = 0.8$  and  $F_{out} = 0.2$  respectively [32].

#### b. The annual indoor effective dose rate ( $E_{in}$ )

The ( $E(in)$ ) is the dose which a person receives in the indoor environment. The  $E(in)$  depends on the indoor external dose  $D(in)$  that is the -ray dose with in the building dose conversion factor (CF that is  $0.7Sv/Gy$ ) and the time of stay in the indoor, (of that is 80% of the year). The annual indoor effective dose ( $E_{in}$ ) was calculated as per equation given below;

$$E(in) = ADR(nGy/h) * 80\% \text{ of } 8760h * 0.7(Sv/Gy)$$

$$E(in) = ADR * 4.905\mu Sv \quad (2.14)$$

Therefore, the total annual effective dose could be calculated using  $(E_{in} + E_{out})$ [32, 33, 34].

#### 2.6.4. Gamma (Representative) Activity concentration index ( $I_\gamma$ )

In order to examine whether the sample meets these limit of criteria, another radiation hazard index, the representative level index (I) used to estimate the level of gamma radiation hazard associated with the natural radionuclides in specific investigated samples is defined from the following equation[27].

$$I_\gamma = \frac{Ra_A}{150} + \frac{Th_A}{100} + \frac{K_A}{1500} \leq 1 \quad (2.15)$$

Where  $Ra_A$ ,  $Th_A$  and  $K_A$  are the activity concentration values of  $^{232}\text{Th}$ ,  $^{226}\text{Ra}$  and  $^{40}\text{K}$  in the final product expressed in  $(Bq/kg)$ . If the value of the activity concentration index is 1 unit or less, the corresponding materials can be used as building materials, so far as radioactivity is concerned without restriction. If the value of activity concentration index exceeds 1 unit, the corresponding materials cannot be used in the building.

#### 2.6.5. Excess life-time Cancer Risk (ELCR)

The annual effective dose equivalent (AEDE), life expectancy of DL (average 67 years), and the risk factor for RF, ICRP risk factors for lethal cancer in the whole population  $(1/Sv)$ ,  $RF = 0.072$ [35]. Based upon calculated values of annual effective dose excess lifetime cancer risk (ELCR) was calculated using the following equation;

$$(ELCR)(outdoor) = (E_{out}) \times LE \times RF$$

$$(ELCR)(indoor) = (E_{in}) \times LE \times RF$$

Where  $(E_{out})$  and  $(E_{in})$  are the annual outdoor and indoor effective doses, LE life expectancy (66 or 67 years) and RF  $(Sv^{-1})$  is fatal risk factor per Sievert, which is 0.05[34].

## 2. RESULT AND DISCUSSION

The current study attempted to evaluate outdoor and indoor gamma dose rates in Checheho Medhanealem in order to calculate the corresponding annual effective dosage and to quantify the radioactive content of naturally occurring radionuclide present in construction materials of this area.

### 2.1. The Activity Concentration

By Using Scintillation detector NaI(Tl) with a 8.3% relative efficiency and a resolution 662keV for the 5280keV of Cs-137 gamma line and MCA with 2000 channel in the gamma ray spectrometry analysis method the activity concentrations of naturally occurring radionuclides  $^{238}\text{U}$ ,  $^{232}\text{Th}$  and  $^{40}\text{K}$  were measured in the ignimbrite rock samples collected from four different location in Nefas Mewucha, checheho medihanaalem and Meket, worki-washa-geoyorgis village. The experimental results of these radionuclide activity concentrations for gamma ray measurement in ignimbrite rock samples collected from the study areas shown in table 3.1 and resulted as figure 3.1.

Sample location	Sample ID	Activity concentration in (Bq/kg)		
		U-238	Th-232	K-40
<u>Lay-qiranbia</u>	S1	12.57±0.282	7.23±0.372	233.55±15.284
<u>Tach-qiranbia</u>	S2	8.60±0.341	5.33±0.433	228.56±15.118
<u>Worki-washa</u>	S3	12.21±0.275	10.09±0.315	331.867±18.217
<u>Angagifo</u>	S4	6.09±0.405	3.01±0.576	142.44±11.935
Average value		9.868±0.326	6.42±0.424	234.10±15.385
World average value		50	50	500

Table 3.1: The measured activity concentrations of natural radionuclides  $^{238}\text{U}$ ,  $^{232}\text{Th}$  and  $^{40}\text{K}$  in the ignimbrite rock samples .

The results listed in above table 3.1, in all tested ignimbrite rock samples naturally occurring radionuclides  $^{238}\text{U}$ ,  $^{232}\text{Th}$  and  $^{40}\text{K}$  activity concentration were found. The value of measuring activity concentration of  $^{238}\text{U}$ ,  $^{232}\text{Th}$  and  $^{40}\text{K}$  were varies from  $6.09 \pm 0.405$  to  $12.57 \pm 0.282$ ,  $3.01 \pm 0.576$  to  $10.09$  and  $142.44 \pm 11.935$  to  $331.867 \pm 18.217$  respectively.

The estimated average activity concentration values of  $^{238}\text{U}$ ,  $^{232}\text{Th}$  and  $^{40}\text{K}$  were  $9.868 \pm 0.326$ ,  $6.42 \pm 0$  and  $234.10 \pm 15.385$  Bq/kg respectively. According to UNSCEAR, the activity concentrations of  $^{238}\text{U}$ ,  $^{232}\text{Th}$  and  $^{40}\text{K}$  in building materials are  $50\text{Bq/kg}$ ,  $50\text{Bq/kg}$  and  $500\text{Bq/kg}$  respectively [36]. Therefore, the concentration of naturally occurring building materials are in normal values which shows the natural type of rock which used to for construction building materials.



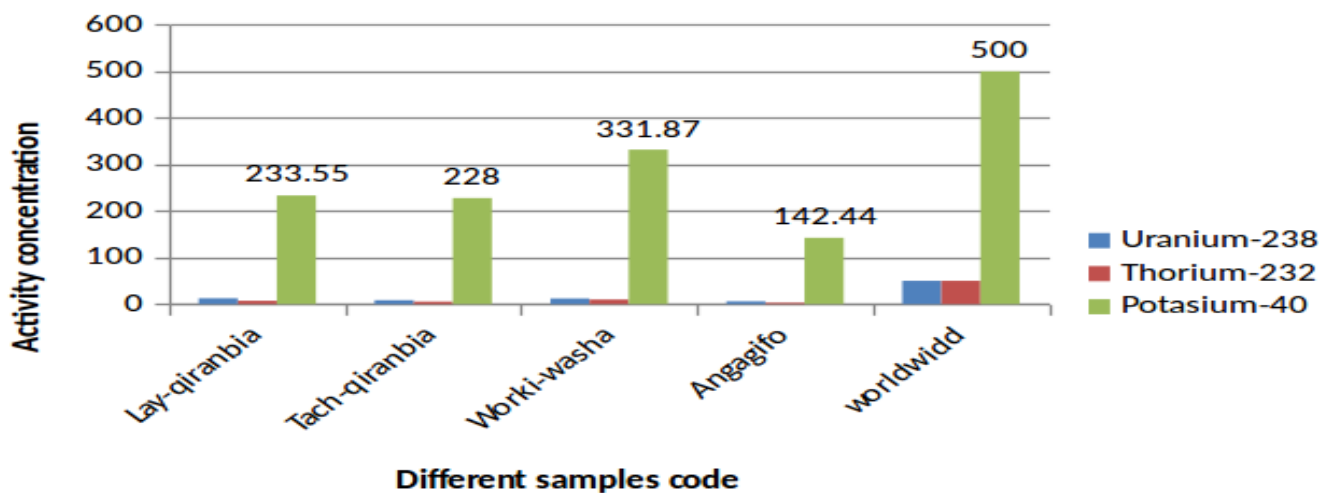

Figure 3.1: Activity concentration of  $^{238}\text{U}$ ,  $^{232}\text{Th}$  and  $^{40}\text{K}$ .

As it was shown in figure 3.1, worki-washa(S3) and Lay-qiranbia (S1) were found to poses high specific activity of uranium and thorium whereas Angagifo (S4) and Tach-qiranbia (S2) poses low specific activity of uranium and thorium. Generally according to the sample at Work-washa(S3) and lay-qiranbia (S1) have higher concentration of  $^{40}\text{K}$  than the others samples and less than the worldwide average value. Those two samples have high concentration of  $^{232}\text{Th}$  than others samples and greater than the world average value ( $50\text{Bq/kg}$ ) [36].

Natural thorium is present in trace quantities in vertically all rock or building materials. Where higher concentration is occur in rock or building materials, thorium may be mined and refined, producing waste product such as mill tailings. If not properly controlled, wind and water can introduce the tailing in to the wider environment so inhaling thorium dust will cause an increased risk of developing lung disease, including lung cancer or pancreatic cancer on population [37]. As a result those samples are not advisable for building and decorative purpose, but the other samples such as tach-qiranbia and angagifo are advisable for building and decorative purpose according to this study.

### 2.1.1. Radiological Effects

The gamma-radiation hazards associated with these samples were assessed according to different indexes. In this study, the radiological hazards such as indices of radium equivalent activity, external and internal hazard index and representative level index for ignimbrite rock sample were calculated as shown in table 3.2.

Sample location	Sample Id	Raeq,(Bq/kg)	Hex	Hin	I <sub>γ</sub>
Lay-qiranbia	S1	40.89	0.111	0.14	0.156
Tach-qiranbia	S2	33.82	0.091	0.115	0.132
Worki-easha	S3	52.19	0.14	0.17	0.202
Angagifo	S4	21.36	0.06	0.074	0.083
Minimum	-----	21.36	0.06	0.074	0.083
Maximum	-----	52.19	0.14	0.17	0.202
World	---+	370	1	1	1

Table 3.2: The calculated values Raeq, H<sub>ex</sub>, H<sub>in</sub> and (I<sub>γ</sub>) for studied Checheho and Wokri-washa ignimbrite rocks samples

It is important to assess the gamma radiation hazards to human associated with the used of these sample for building materials. Hence, these were done by calculating the different radiation hazard indices. The radium equivalent activities of samples under investigation were calculated on the basis of equation (2.7) and the result has shown in table 3.2. Its value is ranged from 21.36 to 52.19 Bq/kg in which the maximum value is acceptable safe for use and lowers than the world standard value 370 Bq/kg.

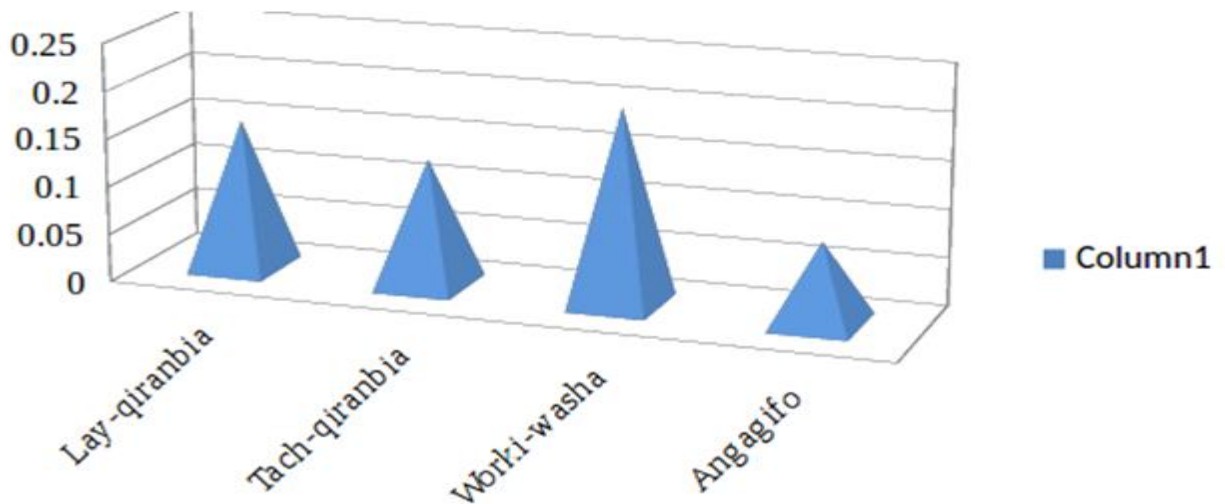

Figure 3.2: Gamma Activity concentration index (I<sub>γ</sub>)

The external H<sub>ex</sub> and internal (H<sub>in</sub>) hazard index due to the emitted gamma rays of checheho of ignimbrite rock samples were calculated and examined according to the following limit: The value of H<sub>ex</sub> must be lower than

unity in order to keep the radiation hazard insignificant. As shown from figure 3.3, the calculated external hazard index values were found to vary between 0.06 to 0.17 in which the maximum value is less than recommended which is one [38].

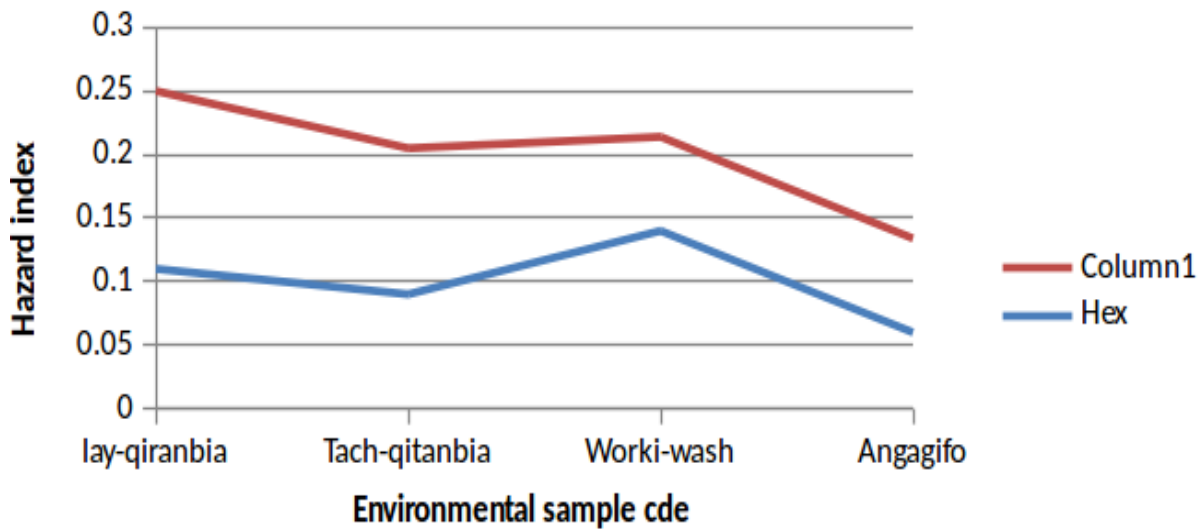

Figure 3.3: hazard index

Sample ID	ADR(nGy/h)	AED( $\mu$ Sv/y)		AED <sub>tot</sub> ( $\mu$ Sv/y)
		AED <sub>out</sub>	AED <sub>in</sub>	
S1	15.98	19.611	78.445	98.056
S2	15.37	18.838	75.450	94.288
S3	20.09	24.655	98.621	123.276
S4	8.94	10.971	43.886	54.857
Min	8.94	10.971	43.886	54.857
Max	20.09	24.655	98.621	123.276
Word	59	0.48mSv/yr		1mSv/yr

Table 3.3: Absorbed dose rate (ADR) in (Gy/h) and Annual effective dose (AED) in (Sv/y) for studied checheho and worki-washa ignimbrite rock.

As shown from table: 3.3 and figure 3.3, the absorbed dose rate (ADR) in checheho and worki-washa ignimbrite rocks is not the same distributed. The S3 ignimbrite rock sample has the maximum value of ADR ( $20.09nGy/hr$ ) from the samples based on the study and S4 sample has the minimum absorbed dose rate ( $8.94nGy/hr$ ). Generally the absorbed dose rate in Checheho and worki-washa

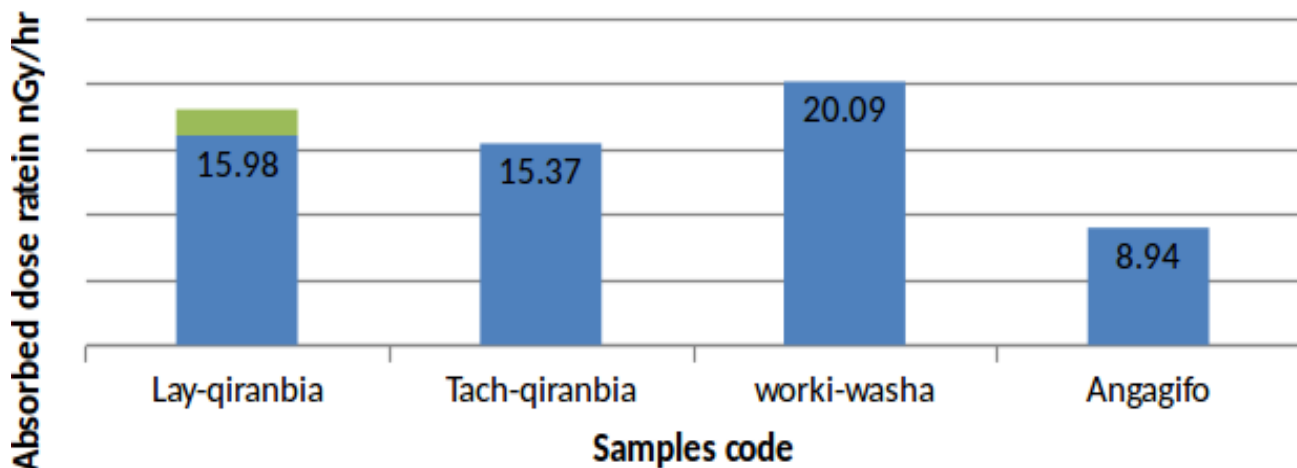

Figure 3.4: Absorbed dose rate.

rock samples are varies from  $8.94 nGy/hr$  to  $20.09 nGy/hr$  in which the highest values are less than the international standard value  $59nGy/hr$ .

The Annual Effective Dose in Checheho and worki-washa rock samples are also not the same distributed and Annual effective dose of outdoor was calculated from Absorbed Doses using conversion coefficient of  $0.7Sv/Gy$  with an outdoor occupancy factor of 0.2 and the Annual Effective Dose of indoor was calculated from absorbed dose rate using conversion coefficient of  $0.7Sv/Gy$  with an indoor occupancy factor of 0.8 [39]. As shown in table 3.3 and figure 3.4, the annual Effective Dose of outdoor in checheho and worki-washa rocks are fluctuated from  $10.971Sv/yr$  to  $24.655Sv/yr$  and indoor annual effective dose are fluctuated from  $43.886Sv/yr$  to  $98.621Sv/yr$ .

As shown from figure 3.5, the maximum outdoor annual effective dose is  $24.655Sv/yr$  or  $0.024655mSv/yr$ , whereas the maximum indoor annual effective dose is  $98.621Sv/yr$  or  $0.098621mSv/yr$ . This result indicates the total annual effective dose in checheho and worki-washa rock samples are generally less than the international recommended value. The recommended value of AED is  $1mSv/y$  for public exposure [40]. The annual worldwide effective dose is determined by adding the various components, as summarized in Table 3.3 and shown as figure 3.5.

The annual global effective dose due to natural radiation sources is  $2.4 mSv$ . However, the range of individual doses is wide. In any large population about 65% would be expected to have annual effective doses between  $1 mSv$  and  $3 mSv$ , about 25% of the population would have annual effective doses less than  $1 mSv$  and 10% would have annual effective doses greater than  $3 mSv$  [41].

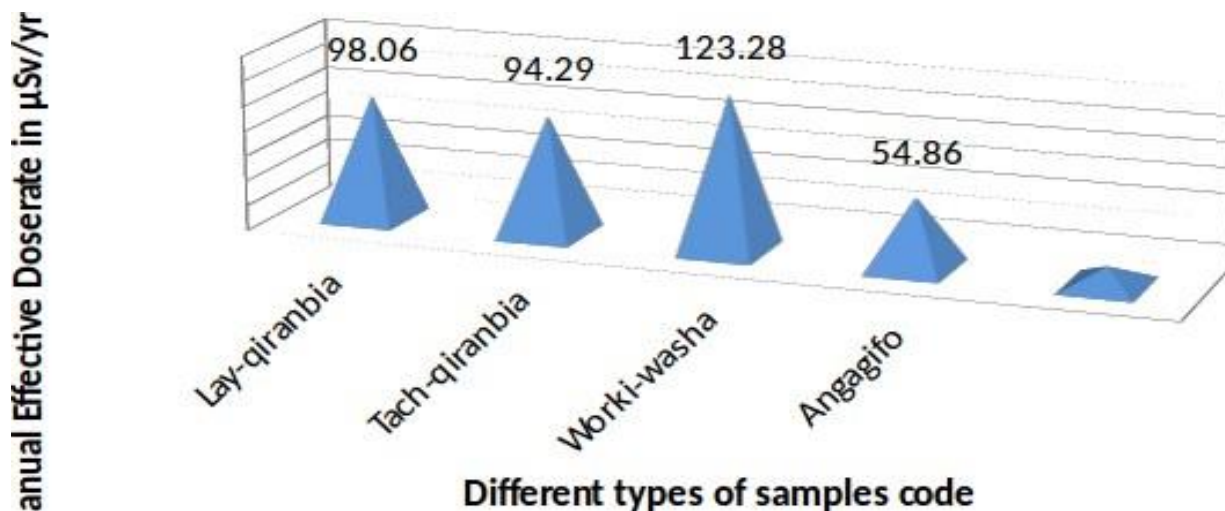

Figure 3.5: annual effective doses

Source	Worldwide average annual effective dose (mSv)	Typical range (mSv)
<b>External Exposure</b>		
Cosmic ray	0.4	0.3-1.0 <sup>a</sup>
Terrestrials gamma ray	0.5	0.3-0.6 <sup>b</sup>
<b>Internal Exposure</b>		
Inhalation (mainly radon)	1.2	0.2-10 <sup>c</sup>
Ingestion	0.3	0.2-0.8 <sup>d</sup>
<b>Total</b>	<b>2.4</b>	<b>1-10</b>

Table 3.4: Average radiation dose from natural resource

Where:

- ranges from sea level to high ground elevation
- depending on radionuclides composition of soil and building materials
- depending on indoor accumulation of radon gas
- depending on radionuclides composition of foods and drinking water

The (ELCR) for outdoor and indoor exposure, given in table 3.5 and figure 3.6, are ranged from 0.198 to 0.642 with an average value of 0.332 and 0.2442 to 0.4620 with an average of 0.457 respectively. As to be true, the total (ELCR) ranges from 0.4422 to 1.023 with an average value of 0.788. it is found that, the total (ELCR) is less than the world's average of 0.48mSv, of which 0.41 mSv comes from indoor and 0.07mSv from outdoor. The samples having higher (ELCR) were picked from the lower part of the study area [42].

Samples location	Sample ID	<u>ELCRout(mSv)</u>	<u>ELCRin (mSv)</u>	<u>TotalELCR (mSv)</u>
<u>Lay-qiranbia</u>	S1	0.3663	0.642	1.0083
<u>Tach-qiranbia</u>	S2	0.3003	0.3795	0.6798
<u>Worki-Washa</u>	S3	0.462	0.561	1.023
<u>Angagifo</u>	S4	0.198	0.2442	0.4422
Min	-----	0.198	0.2442	0.4422
Max	-----	0.462	0.642	1.023
Average	-----	0.332	0.412	0.79
World	-----	0.07	0.41	0.48

Table 3.5: The (ELCR) for outdoor exposure and for indoor exposure.

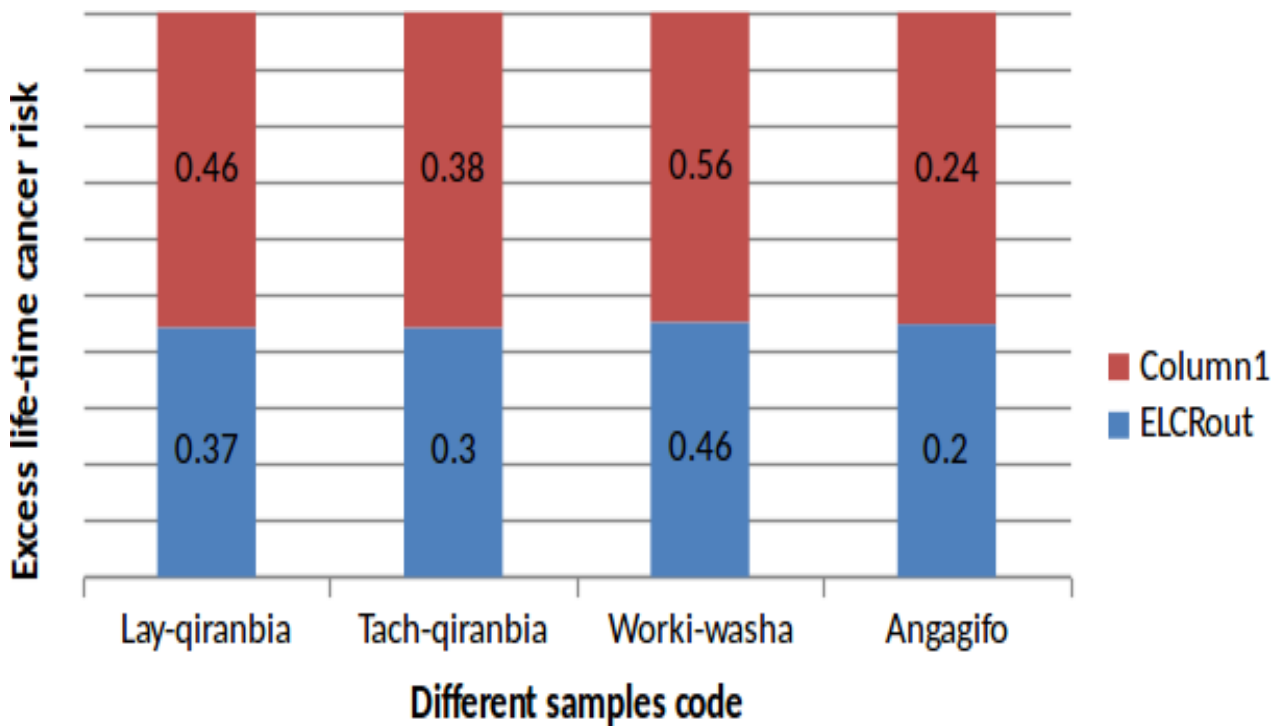

Figure 3.6: Excess life-time cancer risk

Sample	countries	$^{238}\text{U}$	$^{232}\text{Th}$	$^{40}\text{K}$	Raequi	Reference
Granite rock	Egypt	5.26-336.7	3.12-64.43	160.22-774.16	40.26 ± 465.26	<a href="#">D. Ayalew, B. Sitotaw and E. Mengistu,</a> <a href="#">Rom. J. Biophys,29(4),(2019).</a>
Game stone/rock	Ethiopia	29.84 ± 6.53	68.44±18.94	390.87 ± 6.09	151.68 ± 19.46	<a href="#">Mekuanint Lemlem Legasu and Ashok K Chaubey.</a> Evaluation of natural radioactivity level in <a href="#">delanta-dawunt, wollo district, ethiopia.</a> <a href="#">International Journal of Environmental Analytical Chemistry,</a> pages 1–14, 2021.
Rock	Nigeria	13.1 ± 1.6	42.4±4.5	64.5 ± 6.3	833 ± 91	<a href="#">L. Tettey-larbi, E.O. Darko,</a> <a href="#">C. Schandorf and A.A. Appiah,</a> <a href="#">SpringerPlus 2, 1 (2013). doi: , ,</a>
<a href="#">Ignimbrite rock</a>	Ethiopia	9.868 ± 0.326	6.42 ±0.424	234.10 ± 15.385	21.365 ± 2.19	Present study
World average		50	50	50	500	<a href="#">Iman et al.,[2013]and [UNSCEAR,2008]</a>

Table 3.6: Comparison of activity concentration and radium equivalent activity in Bq/kg of natural radionuclides in checheho and worki-washa ignimbrite rock with different countries of the world.

### 3. CONCLUSION AND RECOMMENDATION

#### 3.1. Conclusion

Natural stones are commonly employed as building materials in both indoor and outdoor applications. Their optical and physical mechanical qualities, as well as their distribution and availability, make them a great construction material. In last decades, the possible radioactive hazard of materials has been studied in scientific studies, and various regulations and recommendations have been produced in response to this worry. Radioactive materials emit a type of energy that moves in the form of waves or particles which is known as radiation. When a person is exposed to radiation, the energy penetrates the body.

Radiation can be described as energy or particles from a source that travel through space or other mediums. Light, heat, microwaves and radio waves used for wireless communications are all forms of radiation. The sun is a major source of cosmic radiation, or radiation originating from space. Airline flights and skiing at high altitudes are activities that will increase exposure to this cosmic radiation. Many buildings also emit ionizing radiation simply because the materials that were used to build them, such as ignimbrite rock and granite are naturally radioactive.

The naturally occurring radionuclides  $^{238}\text{U}$ ,  $^{232}\text{Th}$ , and  $^{40}\text{K}$  were measured in ignimbrite rock samples from four different places using gamma ray spectroscopy. Gamma emitter radionuclides were discovered, and their activity concentrations were determined for each sample. The measured activity concentrations in  $^{238}\text{U}$ ,  $^{232}\text{Th}$ , and  $^{40}\text{K}$  ignimbrite rock samples ranged from 6.090.405 to 12.5770.282, 3.010.576 to 10.090.315 and 142.4411.935 to 331.86718.217 Bq/kg, respectively. Furthermore, the average specific activity of  $^{238}\text{U}$ ,  $^{232}\text{Th}$ , and  $^{40}\text{K}$  were determined to be 9.8680.326, 6.420.424 and 234.115.385 Bq/kg, respectively. According to UNSCEAR report, the activity concentrations of  $^{238}\text{U}$ ,  $^{232}\text{Th}$  and  $^{40}\text{K}$  in building materials are 50Bq/kg, 50Bq/kg and 500Bq/kg [44]. Therefore, these value were lower than the recommended world average value for  $^{238}\text{U}$ ,  $^{232}\text{Th}$  and  $^{40}\text{K}$ . Likewise, these values are well compared with the values reported in Ethiopia and some countries of the world.

Furthermore, the computed hazard indices used to quantify the possible radiological health risk in ignimbrite rock samples, as well as the dose rate associated with it, are well below the allowable level. This study generated baseline data on the status of naturally occurring radionuclides in the study area, which will be used as a reference for future research. The amounts of naturally occurring radioactive elements detected in this study from four locations in Checheho and Worki- washa examined samples demonstrate that the study regions monitored had normal concentrations of natural background radiation.



### 3.2. Recommendation

I strongly want to recommend, future studies should assess the activity concentration of naturally occurring radionuclides on various types of Ethiopian construction materials. The total number of samples in the current researcher is quite little, and it provides very little information on the assessments of specific activity concentration in each sample.

The researcher exclusively investigates natural radionuclides found in the environment that are used in the construction process. Aside from ignimbrite rock, granite, and cement, various natural and man-made building materials may contribute to radiation exposure. Clay paintings, water, plants, ballast, and stones are examples of these. As a result, it is critical to examine the contribution of each of these construction materials to the external and internal dose rate in order to reduce the danger of exposure to high doses of radiation.

### Reference

- [1]. Y. Örgün, N. Altınsoy, S.Y. Şahin, Y. Güngör, A.H. Gültekin, G. Karahan, Z. Karacık, Natural and anthropogenic radionuclides in rocks and beach sands from Ezine region (Çanakkale), Western Anatolia, Turkey, *Applied Radiation and Isotopes*, Volume 65, Issue 6, 2007.
- [2]. Dinh Chau N, Dulinski M, Jodlowski P, Nowak J, Rozanski K, Sleziak M, et al. Natural radioactivity in groundwater, 2011;47: 415–437.
- [3]. UNSCEAR (United Nations Scientific Committee on the Effects of Atomic Radiation), Sources, Effects and Risks of Ionizing Radiation. New York (1988).
- [4]. N Todorovic, I Bikit, M Krmar, D Mrdja, J Hansman, J Nikolov, S Forkapic, M Veskovic, K Bikit, and I Jakonic. Natural radioactivity in raw materials used in building industry in serbia, 12(2):705–716, 2015.
- [5]. Huda Al-Sulaiti, Tabassum Nasir, KS Al Mugren, N Alkhomashi, N Al-Dahan, M Al-Dosari, DA Bradley, S Bukhari, M Matthews, PH Regan, et al, Determination of  $^{137}\text{Cs}$  activity in soil from qatar using high-resolution gamma-ray spectrometry, 127:222–235, 2016.
- [6]. Mbet Amos Akpanowo, Ibrahim Umaru, Shekwonyadu Iyakwari, Emmanuel Olugbemi Joshua, Samson Yusuf, and Godwin Bassey Ekong, Determination of natural radioactivity levels and radiological hazards in environmental samples from artisanal mining sites of anka, north-west Nigeria, 2020.
- [7]. Righi, S. and Bruzzi, L., *J. Environ. Radioact*, 2006, vol. 88, pp. 158–170.  
<https://doi.org/10.1016/j.jenvrad.2006.01.009>
- [8]. Taylor, S.R. and McLennan, S.M., *The Continental Crust: Its Composition and Evolution*, Blackwell

Scientific, 1985.

- [9]. CHRISTOPHER Y. H. CHAO, Determination of Radon Emanation and Back Diffusion Characteristics of Building Materials in Small Chamber Tests, 1996
- [10]. Ye Y, Wu W, Huang C, Kearfott KJ. Experimental study of the effect of seepage on radon exhalation in circular tubular porous emanation media, 29(5):701-710, 2020.
- [11]. Khalid AL Nabhani, Faisal Khan, and Ming Yang. Technologically enhanced naturally occurring radioactive materials in oil and gas production: a silent killer, 99:237–247, 2016.
- [12]. Lust, Merle, and Enn Realo, "Assessment of natural radiation exposure from building materials in Estonia", vol. 61, no. 2, 2012.
- [13]. Mehra R, Kaur S, Prakash R. Optimization of fly ash content in cement and assessment of radiological risk, 29(2):286-292; 2020.
- [14]. R. Ravisankar, K. Vanasundari, A. Chandrasekaran, A. Rajalakshmi, M. Suganya, P. Vijayagopal, V. Meenakshisundaram, Measurement of natural radioactivity in building materials of Namakkal, Tamil Nadu, India using gamma-ray spectrometry, Applied Radiation and Isotopes, Volume 70, Issue 4, 2012.
- [15]. M.Y. Shoeib, K.M. Thabayneh, Assessment of natural radiation exposure and radon exhalation rate in various samples of Egyptian building materials, Journal of Radiation Research and Applied Sciences, Volume 7, Issue 2, 2014,
- [16]. M Legasu, A.K. Chaubey, Determination of dose derived from building materials and radiological health related effects from the indoor environment of Dessie city, Wollo, Ethiopia, Heliyon, Volume 8, Issue 3, 2022.
- [17]. B.U. Chang, S.M. Koh, Y.J. Kim, J.S. Seo, Y.Y. Yoon, J.W. Row, D.M. Lee, Nationwide survey on the natural radionuclides in industrial raw minerals in South Korea, Journal of Environmental Radioactivity, Volume 99, Issue 3, 2008.
- [18]. J. Somlai, V. Jobbágy, C. Németh, Z. Gorjánác, N. Kávási, T. Kovács, Radiation dose from coal slag used as building material in the Transdanubian region of Hungary, Volume 118, Pages 82–87, Issue 1, April 2006.
- [19]. J Barescut, S Righi, R Guerra, M Jeyapandian, S Verità, and A Albertazzi, Natural radioactivity in italian ceramic tiles, 44(5):413–419, 2009.
- [20]. Baye Chekole, Trends of major crops productivity to climate variability in lay gayint woreda, northwest ethiopia. 2018.
- [21]. A Faanu, G Emi-Reynolds, EO Darko, R Awudu, ET Glover, OK Adukpo, F Otoo, DO Kpe-glo, and H Lawluvi. Calibration and performance testing of sodium iodide, nai (tl), detector at the food and environmental laboratory of the radiation protection institute of the ghana atomic energy commission,

19(1), 2011.

[22]. Hubert L Oczkowski, Calibration standard for use in gamma spectrometry and luminescence dating, 20, 2001.

[23]. Saman Khabbat Ezzulddin and Habeeb Hanna Mansour. Radon and radium activity concentration measurement in drinking water resources in kurdistan region-iraq, 324(3):963–976, 2020.

[24]. Halliday and rsnick 10<sup>th</sup> edition, Fundamental of physics, p 1286-1288, 2014.

[25]. Khalil Thabayneh, Natural radioactivity levels and estimation of radiation exposure in environmental soil samples from tulkarem province–palestine. 2012.

[26]. Usha Natesan, Chandrasekaran Seethapathy, Srinivasalu Seshachalam, et al. Eco-toxic risk assessment of near shore sediments in bay of bengal–environmental radioactivity and ecological risk as a proxy. 2022.

[27]. S Harb, Natural radioactivity and external gamma radiation exposure at the coastal red sea in egypt, 130(3):376–384, 2008.

[28]. M Mehade Hasan, AH Chaity, I Jahan, MA Haydar, MI Ali, and D Paul, Assesment of natural radioactivity and radiological analysis of soil and brick samples used as building materials in bangladesh, 11:860–869, 2020.

[29]. R Ravisankar, J Chandramohan, A Chandrasekaran, J Prince Prakash Jebakumar, I Vijay- alakshmi, P Vijayagopal, and B Venkatraman, Assessments of radioactivity concentration of natural radionuclides and radiological hazard indices in sediment samples from the east coast of tamilnadu, india with statistical approach, 97(1-2):419–430, 2015.

[30]. Fawzia Mubarak, M Fayez-Hassan, NA Mansour, Talaat Salah Ahmed, and Abdallah Ali, Radiological investigation of high background radiation areas, 7(1):1–12, 2017.

[31]. UNSCEAR (2000) United Nations Scientific Committee on the Effect of Atomic Radiation, report to the general assembly. Annex B: Exposures from Natural Radiation Sources.

[32]. A M El Arabi. <sup>226</sup>ra, <sup>232</sup>th and <sup>40</sup>k concentrations in igneous rocks from eastern desert, egypt and its radiological implications, 42(1):94–100, 2007.

[33]. Muiyiwa Michael Orosun, Taiye Benjamin Ajibola, Olusegun Emmanuel Ehinlafa, Ahmad Kolawole Issah, Banji Naheem Salawu, Sunday Danladi Ishaya, Kelechi Kingsley Ochommadu, and Abayomi Daniel Adewuyi, Annual effective dose assessment of radon in drinking water from abandoned tin and cassiterite mining site in oyun, kwara state, nigeria, 8(1):181–192, 2022.

[34]. Mohamed Th S Heikal and Gulcan Top, Assessment of radioactivity levels and potential radiation health hazards of madsus granites and associated dikes nearby and around ruwisat village, south sinai, egypt, 146:191–208, 2018.

- [35]. M Legasu and Ashok K Chaubey, Evaluation of natural radioactivity level in delanta-dawunt, wollo district, ethiopia, pages 1–14, 2021.
- [36]. Venkidasamy Ramasamy, Govindasamy Suresh, Venkatasubramanian Meenakshisundaram, and Velladurai Ponnusamy, Distribution and characterization of minerals and naturally occurring radionuclides in river sediments, 5(1):41–48, 2010.
- [37]. N Ayten UYANIK. An alternative approach to the excess lifetime cancer risk and prediction of radiological and cancer risks caused by terrestrial radiation, case of isparta/turkey. 2022.
- [38]. M Bashir, I Ibeanu, Y Zakari, and U Sadiq. Assessment of radiological risk in flooded soil samples of kudenda, kaduna state nigeria, pages 69–74, 2013.
- [39]. AK Mahur, Rajesh Kumar, RG Sonkawade, D Sengupta, and Rajendra Prasad, Measurement of natural radioactivity and radon exhalation rate from rock samples of jaduguda uranium mines and its radiological implications, 266(8):1591–1597, 2008.
- [40]. B Lyngkhoi and P Nongkynrih. Radioactivity in building materials and assessment of risk of human exposure in the east khasi hills district, meghalaya, india, 7(1):194–209, 2020.
- [41]. Yasutaka Omori, Masahiro Hosoda, Fumiaki Takahashi, Tetsuya Sanada, Shigekazu Hirao, Koji Ono, and Masahide Furukawa, Japanese population dose from natural radiation, 40(3):R99, 2020.
- [43]. Ngo Quang Huy, Pham Duy Hien, TV Luyen, DV Hoang, Huynh Thuong Hiep, Nguyen Hao Quang, Nguyen Quang Long, Dang Duc Nhan, Nguyen Thanh Binh, Phan Son Hai, Natural radioactivity and external dose assessment of surface soils in vietnam, 151(3):522–531, 2012.