

# Renewable fuel regulation: Implications for e-fuel production infrastructure in energy hubs

Lissy Langer\*, Ioannis Kountouris, Rasmus Bramstoft, Marie Münster and Dogan Keles  
Technical University of Denmark (DTU), Section for Energy Economics and Modeling,  
Produktionstorvet, Bld. 424, 2800 Kgs. Lyngby, Denmark

\*Corresponding author: lilang@dtu.dk

**Abstract**—Renewable fuel of non-biological origins (RFNBOs) are needed to decarbonize hard-to-electrify sectors which rely on liquid or gaseous fuels, such as long-haul shipping. The EU’s Delegated Act on RFNBOs defines *renewable hydrogen* by considering rules on additionality as well as temporal and geographical correlation of the electricity used. For a Danish case study, we examine the impact on the capacity expansion problem of an energy hub producing renewable hydrogen, e-methanol, and e-ammonia using a mixed-integer linear problem formulation. We analyze the investments in production capacity, storage assets, and Power Purchase Agreement (PPA) volume under different fuel price assumptions for 2030. We find that e-methanol (combined with limited storage to secure hydrogen supply to the synthesizer) provides the best business case with a PPA volume based on the maximum allowed electrolyzer size.

**Index Terms**—Electrolyzer, Energy Hub, Hydrogen, Power-to-X, Renewable Fuel Regulation

## I. INTRODUCTION

In its REPowerEU plan published in May 2022, the European Commission (EC) sets out to accelerate the clean energy transition and reduce the EU’s dependency on fossil fuel imports [1]. The aim is to reach 10 million tonnes of domestic renewable hydrogen production and 10 million tonnes of imports by 2030 to replace natural gas, coal, and oil in hard-to-abate industry and transport sectors [2]. Nevertheless, the use of *renewable* electricity is essential for hydrogen production, as hydrogen from fossil electricity is more emission-intensive than hydrogen from natural gas through steam methane reforming [1]. The EC expects that around 500–550 TWh or €200–300 billion of additional renewable energy production will be needed to fulfil the EU targets [3].

In Feb 2023, two Delegated Acts were published to provide regulatory certainty on what constitutes *renewable* hydrogen and fuels in the EU. These clarifications aim to ensure that net decarbonisation is achieved by using only *additional* renewable electricity produced at the same time and in the same region (see Section I-A). The Delegated Acts set guidelines for infrastructure investments, state aid, hydrogen imports, and for

The authors would like to acknowledge financial support from the SuperP2G project in the European Union’s Horizon 2020 research and innovation programme under grant agreement No 775970, the H2Elements project under the Marie Skłodowska–Curie grant agreement No 899987, and under the Nordic Energy Research’s mobility and network program NordNET under grant agreement No. 119646.

the proposed renewable consumption targets for industry and the transport sector of the Fit for 55 package [4].

### A. EU Delegated Act on Renewable Hydrogen and Fuels

In Dec 2018, the Renewable Energy Directive (RED II) introduced a renewable fuel quota of 14% for fuel suppliers in road and rail transport by 2030. In addition, it requested the EC to develop a Union methodology for the electricity used to produce RFNBOs to be considered as *fully renewable* [5]. In Feb 2023, the Delegated Act on Renewable Hydrogen [1] defined three ways to source fully renewable electricity:

- 1) **using on-site RES** no older than 36 months at the start of the RFNBO production (§ 3)
- 2) **using a PPA** following rules on additionality as well as temporal and geographical correlation (§ 5)
- 3) **using the grid** given a high share of RES in the past calendar year (§ 4.1), or at the time of consumption leading to downward dispatching (§ 4.3), or a low day-ahead or  $\text{CO}_{2_{eq}}$  allowance price (§ 6).

In addition, the EC added an exception for low-carbon countries (mainly with a high share of nuclear power)<sup>1</sup>, waiving the additionality rule on renewable PPAs (§ 4.2).

**The Additionality Rule** aims to introduce additional renewable energy capacity so as not to divert from regular electricity demand. A PPA can include renewable power plants not built more than 36 months before the start of RFNBO production (§ 5.a). The rule disallows stacking financial support and guarantee of origins (GOs) for the fuel produced and electricity used (§ 5.b). Until 2028, electrolyzers can still sign PPAs with existing renewable power plants not to delay investments.

**The Temporal Correlation Rule** aims to increase the share of renewable energy sources (RES) and storage assets with a higher system value by matching supply and demand in a given hour. Until 2030, only monthly matching is enforced to allow for constant delivery without hydrogen infrastructure and storage yet in place (member states can introduce hourly matching as of July 2027 upon notification).

**The Geographical Correlation Rule** aims to achieve *deliverability* of the introduced RES generation to limit the burden on the transmission infrastructure. A region also includes

<sup>1</sup>Separate regulation for low-carbon hydrogen using electricity produced from nuclear power might be introduced earliest by the end of 2024. Blue hydrogen (from natural gas with CCS) will most likely not be subsidized.

adjacent offshore wind zones as well as interconnected zones with a higher day-ahead price to reduce network congestion.

Simultaneously, the US Treasury Department is in the process of defining an equivalent US methodology, most likely also combining rules on additionality as well as temporal and geographical correlation. The financial gains are substantial, as the US Inflation Reduction Act (IRA) subsidizes hydrogen production with up to \$3 per kg<sub>H<sub>2</sub></sub> based on emission intensity. In addition, during the revision of the Greenhouse Gas Protocol's scope 2 emission standards, similar measures are being discussed [6].

### B. EU Renewable Hydrogen Support

In Feb 2023, the EC published its Green Deal Industrial Plan, claiming that it will be more cost-effective, fast, and administratively light than the US IRA [7]. It supports the scale-up of EU manufacturing capacity for net-zero technologies and products. The EU Innovation Fund will—through competitive bids—cover the funding gap between renewable hydrogen and fossil fuels by introducing a fixed premium for each kg of renewable hydrogen produced over a period of 10 years. The first auction of the European Hydrogen Bank is to take place in the autumn/end of 2023 with an indicative budget of €800 million and can, using an auction-as-a-service scheme, be extended with additional national funding [3]. Terms and conditions of the initial carbon contracts for difference (CCFD) format are to be published in May and finalized in June 2023.

### C. EU Renewable Hydrogen Production

The EC aims at 6000 MW<sub>e</sub> of electrolyzers by the end of 2025. Yet, the market is still emerging since most of the current 160 MW<sub>e</sub> of electrolyzer installations are demonstration plants with the largest plant currently under construction being 20 MW<sub>e</sub> [8]. The certainty on regulation and funding might lead to additional investments on the supply side. On the demand side, however, e.g., in the shipping sector, technology choices, future demand, and prices are still undetermined. The question remains how the gap between willingness-to-pay and production costs can be bridged in highly competitive yet hard-to-abate sectors. In this regard, we investigate the production of e-methanol and e-ammonia, both considered relevant for decarbonizing long-haul shipping.

We investigate the impact of the proposed EU regulation on the investment decisions of an energy hub producing renewable hydrogen (H<sub>2</sub>), e-methanol (MeOH), and e-ammonia (NH<sub>3</sub>). We combine the regulatory with the operational constraints and analyze varying flexibility requirements, such as additional investments in local battery and/or hydrogen storage assets. In particular, we evaluate the impact of:

- renewable fuel prices,
- level of capital expenditures, and
- level of operational details modelled

on the need for flexibility (mainly represented by storage assets), the full-load hours (FLH), as well as the production capacities, fuels produced, and overall cost of the system.

## II. RELATED WORK

For the Western US, Ricks et al. (2023) investigate the impact of the IRA hydrogen subsidies on the system, analyzing generation and storage capacities, cost, and emissions evaluating varying temporal correlation rules [9]. In a European context, two working papers investigate regulatory aspects in a German case study [10] and a number of EU countries considering the flexibility of hydrogen demand and different types of hydrogen storage assets [11]. However, the detailed ruling of the Delegated Act was not considered yet. In addition, the studies only consider the production and demand of hydrogen and not its derivatives. On the other hand, capacity expansion models of energy hubs predominantly focus on technical operation on a shorter time scale or policy evaluation on a macroeconomic scale with less technical detail.

## III. METHODOLOGY

The energy hub modelled is inspired by the industrial park GreenLab Skive (GLS) in North-West Denmark. The park aims to create a synergetic network for its partners on site. It plans local RES as well as producing hydrogen and potential derivatives. Therefore, we use this representative case to illustrate the respective investment decisions considering the renewable hydrogen regulation.

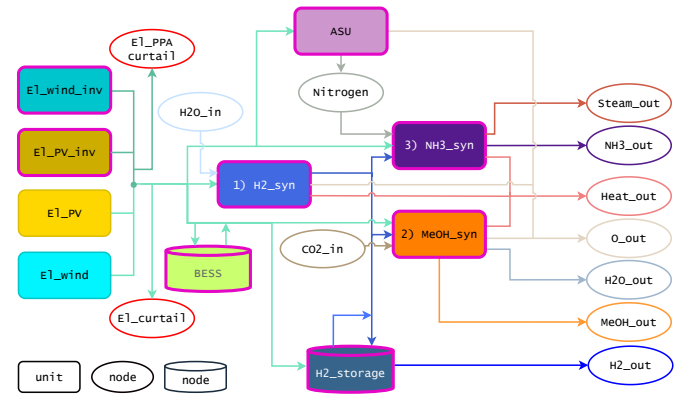

Fig. 1. GreenLab Skive energy park technology flow chart (magenta frames indicate investment decisions) adapted based on [12].

Fig. 1 illustrates the technical assets modelled for GLS. Investment assets are indicated with a magenta frame. We analyze three distinct setups of the energy hub: a) only H<sub>2</sub>, b) H<sub>2</sub> and MeOH, or c) H<sub>2</sub> and NH<sub>3</sub> production. In addition, we investigate the sensitivity of the results for different levels of fuel prices and capital expenditures. The model developed is based on the EnerHub2X model that was used to investigate the operational patterns of the GLS energy hub [12]. The model was expanded to consider investments.

### A. Modeling Framework

While the initial model used GAMS, we use the *SpineOpt* modelling framework, which allows for linear and mixed-integer linear problem (MILP) formulation within the same framework and flexible scenario generation and temporal resolution [13]. The model is constructed by defining unit

and node objects, as well as their relationships and respective parameter values, using the underlying constraints in a flexible generalized manner. The data flow is managed using *Spine Toolbox*, which can also be integrated with other modelling frameworks [14]. In the following, we briefly explain how the entities are modelled. The detailed data can be found in Appendix B and on GitHub.

## B. Units

As indicated in Fig. 1, units are used to represent converters such as the synthesizers and RES assets. Units can be invested in and can have multiple in- and outputs (for data see Tab.V).

*a) Investment Decisions and Unit Commitment Types:* Capacity investment decisions can be continuous or integer units of a specific size—introducing a MILP. Using a MILP formulation, one can also introduce unit commitment constraints such as minimum loads or ramping constraints.

The MILP model includes a minimum operating level of 20% and an (optimistic) cold-start ramp-up time of two hours for all Power-to-X (P2X) synthesizers to make operations more realistic. The impact will be discussed briefly in Sec.IV-B. The LP version of the model does not include unit commitment, and all units can be invested in continuously.

**For example**, the investment in the air-separation unit (ASU) is continuous and does not include unit commitment. The electrolyzer, on the other hand, is represented using distinct stacks of 450 kW<sub>e</sub> each. Then, unit commitment applies to each separate stack unit. Finally, the P2X synthesizers are represented by units with distinct capacities ranging from 1 to 10 tons of fuel output per hour. Then, unit commitment applies to the whole unit.

Unit	Candidate Units	Unit Capacity	Investment Type
ASU	10	1 tons <sub>N</sub> /h	continuous
H <sub>2</sub> _syn	222	8.1 kg <sub>H<sub>2</sub></sub> /h	integer
NH <sub>3</sub> _syn	1	1–10 tons <sub>NH<sub>3</sub></sub> /h	binary

*b) Input-Output Ratios:* are used to fix the relationship between in- and outputs. They can be defined between two inputs, two outputs, or an in- and an output.

**For example**, the electrolyzer takes water ( $H_2O_{in}$ ) and electricity as input and produces hydrogen ( $H_2$ ), oxygen ( $O_{out}$ ), and heat ( $Heat_{out}$ ). The fixed input-output ratio for electricity and water are 53.6 and 9.99, respectively, so for one ton of hydrogen 53.6 MWh of power and 9.99 tons of water are needed. At the same time, the output-output ratios define that per ton of hydrogen 9.76 MWh heat and 4.96 tons of oxygen are produced.

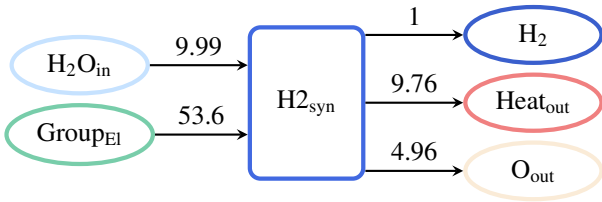

*c) Unit Availability and Flow Variables:* The variability of the RES units is modelled using a `unit_availability_factor`. For an existing unit, the factor is multiplied with the `unit_capacity`, the following (unit commitment) variables are bounded accordingly:

$\geq \text{units\_available} \geq \text{units\_on} \geq \text{unit\_flow}$ . For investments, the availability is determined by the `units_invested` in.

**For example**, PV can be invested in to approximate a PPA connection [11]. The following parameters are defined:

Class	Object	Parameter	Value
unit	PV	candidate_units	1000
unit	PV	number_of_units	0
unit	PV	unit_availability_factor	time series
unit	PV	unit_investment_cost	41,259
unit	PV	unit_investment_variable_type	continuous
unit_to_node	PV,El_PPA	unit_capacity	1

Accordingly, the system could invest continuously in PV assets up to 1000 MW with an availability defined by the hourly `unit_availability_factor` and with annualized investments of €41,259 per MW. The unit flow from the PV asset to the PPA electricity node is then restricted by the following equations:

The investment and retirement per investment period (e.g., years) define the *available* investments restricted by the `candidate_units`. This is the case for all investments in units and nodes (where variables are called `storages_invested...` instead of `units_invested...`).

$$\text{units\_invested\_available}_t \leq \text{candidate\_units} \quad \forall t \in \text{investment periods} \quad (1)$$

$$\begin{aligned} & \text{units\_invested\_available}_t = \\ & \text{units\_invested\_available}_{t-1} + \text{units\_invested}_t \\ & - \text{units\_mothballed}_t \quad \forall t \in \text{investment periods} \end{aligned} \quad (2)$$

The `units_invested_available` are the upper bound for the `units_available` per period (e.g., hours), taking into account initial units and the availability factor.

$$\begin{aligned} & \text{units\_available}_h \leq \\ & \text{units\_availability\_factor}_h \\ & \times (\text{number\_of\_units} + \text{units\_invested\_available}_t) \\ & \quad \forall h \subset t \in \text{investment periods} \end{aligned} \quad (3)$$

The `units_available` are the upper bound for the `units_on` per period.

$$\text{units\_on}_h \leq \text{unit\_available}_h \quad \forall h \quad (4)$$

The `units_on` times the `unit_capacity` are the upper bound for the `unit_flow` per period.

$$\text{unit\_flow}_h \leq \text{units\_on}_h \times \text{unit\_capacity} \quad \forall h \quad (5)$$

Since the availability factors do only set an upper bound and do not fix the `units_available` as the `units_on`, one has to carefully model RES curtailment.

### C. Nodes

There are four different kinds of nodes illustrated in Fig. 1: sources, sinks, intermediate products, and storage assets (data see Tab.VII).

a) *Nodal Balance Sense*: The first three types have distinct nodal balance senses.

Type	Example Node	Nodal Balance Sense
Sources	CO2_in	<=
Sinks	H2_out	>=
Products	H2	==

The sources create a product (e.g., CO<sub>2</sub>) that becomes the input to units, inducing a `fuel_cost`. Both CO<sub>2</sub> and H<sub>2</sub>O are assumed to be infinitely available. The sinks consume a product (e.g., H<sub>2</sub>), inducing a negative `fuel_cost` as the fuels are the main products sold. Intermediate products need to be balanced, e.g., the hydrogen from the electrolyser must either be stored, compressed, or used in a P2X unit.

b) *Storage Assets*: Nodes can work as storage assets by setting `has_state`. Subsequently, storage equality constraints apply, e.g. for BESS, these parameters are set:

Class	Object	Parameter	Value
node	BESS	<code>has_state</code>	True
node	BESS	<code>fix_node_state</code>	time series
node,t	BESS,t	<code>cyclic_condition</code>	True
node	BESS	<code>frac_state_loss</code>	4e-05
node	BESS	<code>node_state_cap</code>	1

The initial state of charge can be defined using `fix_node_state`, with the `cyclic_condition` as True this state also has to be reached again at the end of the planning horizon. The `frac_stat_loss` defines a percentage loss per time period and `node_state_cap` the upper limit of the state of charge. Considering storage investments, this value is multiplied by `storages_invested_available` similar to Eq. 4 to restrict the `node_state` at a given time.

c) *Groups*: These sum commodities of the same kind, e.g., to define `unit_capacities` and `fixed_ratios` over the sum of a group. Groups can, however, not be used to define common parameters such as `fixed_ratios` or `fuel_cost` for assets of the same kind.

**For example**, the different sources of renewable electricity are combined in the `Group_El` that can be used as input, e.g., to the electrolyzer with a `fix_ratio_in_out_unit_flow` of 53.6 MWh per ton of hydrogen.

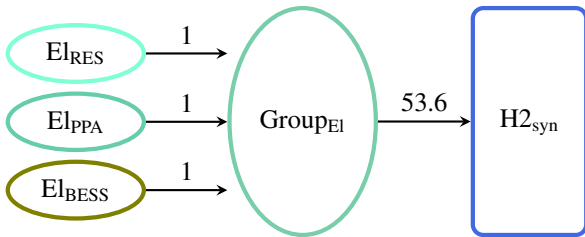

## IV. RESULTS

We investigate four groups of scenarios (Tab. I) with results (Tab. II) illustrated in Fig. 2 and with more detail in Figs.3–12.

#	Fuels	RES	Fuel Prices
0	H <sub>2</sub>	Local	1x
1	H <sub>2</sub>	Local	1.5x
2	H <sub>2</sub>	Local	2x
3	H <sub>2</sub>	Local + PPA	1x
4	H <sub>2</sub>	Local + PPA	1.5x
5	H <sub>2</sub>	Local + PPA	2x
6	H <sub>2</sub> + MeOH	Local + PPA	1x
7	H <sub>2</sub> + MeOH	Local + PPA	1.5x
8	H <sub>2</sub> + MeOH	Local + PPA	2x
9	H <sub>2</sub> + NH <sub>3</sub>	Local + PPA	1x
10	H <sub>2</sub> + NH <sub>3</sub>	Local + PPA	1.5x
11	H <sub>2</sub> + NH <sub>3</sub>	Local + PPA	2x

TABLE I  
SCENARIO DESCRIPTIONS.

### A. Scenario Results

The first two groups (S0–5), allow only hydrogen production. In S0–2, only the local RES (27 MW of PV and 54 MW of wind) are available. In S3–5, investments in additional RES of the same kind can be made. These approximate a PPA considering additionality as well as hourly and regional matching (similar to [11]). In S6–8, investments in methanol production, in S9–11, in ammonia production instead, are allowed. The base prices are P2X price projections made for 2030 by the Danish Energy Agency: H<sub>2</sub> for €2.16 per kg, MeOH for €0.65 per kg, and NH<sub>3</sub> for €0.46 per kg [15]. In addition, we examine price increases of 50% and 100%—roughly equivalent to the increase that natural-gas-based ammonia reached in 2021 and 2022, respectively.

a) *S0–2 (H<sub>2</sub> Local RES)*: Using the base fuel prices and with only the local RES available (S0), the system does not invest in any production capacity. We assume the P2X owner has to pay the 2019 DK1 day-ahead prices (without additional tariffs) for local electricity—then H<sub>2</sub> production is not profitable. With increased H<sub>2</sub> prices (S1+2), the synthesizer and compressor capacities are expanded up to 110 electrolyzer stacks with an overall capacity of 0.89 t<sub>H<sub>2</sub></sub> per hour and a compressor of the same size to sell the compressed H<sub>2</sub>.

b) *S3–5 (H<sub>2</sub> PPA)*: Allowing contracting PPAs, investments in additional wind generation are made (up to 171 MW). For all fuel prices, the maximum number of 222 H<sub>2</sub> stacks are invested in (with a capacity of around 1.8 t<sub>H<sub>2</sub></sub> per hour). Some negligible investments in battery capacity are made to fulfil the (small) minimum load requirement of 20% per single stack.

c) *S6–8 (MeOH PPA)*: Allowing investments in MeOH production, similar investments in wind are made (up to 177 MW). For the high price scenarios (S7+8) up to 40 MW of additional PV are invested in. Only with +100% fuel prices (e.g., MeOH €1,300 per ton) (S8), the maximum available capacity of 10 t<sub>MeOH</sub> per hour is invested in. Base prices (S6) lead to a capacity of 4 t<sub>MeOH</sub> per hour, selling a mix of MeOH (86%) and compressed H<sub>2</sub> (14%). Higher fuel prices lead to more MeOH and, eventually, no H<sub>2</sub> being sold.

At base prices (S6), two H<sub>2</sub> storage tanks of 500 kg<sub>H<sub>2</sub></sub> each are invested in to buffer H<sub>2</sub> supply to the MeOH synthesizer. A smaller compressor of 1.05 t<sub>H<sub>2</sub></sub> per hour is sufficient because most H<sub>2</sub> is directly used for MeOH production. A 50% increase in fuel prices (S7) leads to four H<sub>2</sub> storage units



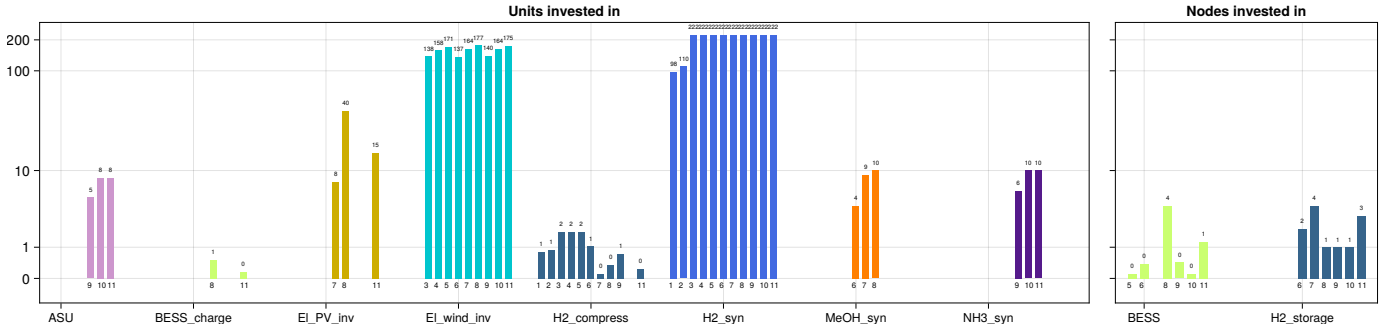

Fig. 2. GreenLab Skive energy park investment decisions based on scenarios in Table I (non-indicated values are zero).

(2 t<sub>H2</sub>) which are subsequently filled using a small compressor unit of 0.11 t<sub>H2</sub>/h. A 100% increase in fuel prices (S8) reduces the need for H<sub>2</sub> storage (500 kg<sub>H2</sub> only). Instead, the additional PV and a BESS of 4 MW is used to buffer some low-wind hours to continuously feed H<sub>2</sub> to the MeOH units.

*d) S9–11 (NH<sub>3</sub> PPA):* Allowing for NH<sub>3</sub> production, wind investments are similar (up to 174 MW). Base prices (S9) lead to investments of 6 t<sub>NH<sub>3</sub></sub> per hour with mostly NH<sub>3</sub> being sold (93%), higher fuel prices lead to the maximum capacity of 10 t<sub>NH<sub>3</sub></sub> per hour and all H<sub>2</sub> being used for NH<sub>3</sub> production. Hydrogen supply is mainly buffered using H<sub>2</sub> storage (500 kg for S10 and 1.5 t<sub>H2</sub> for S11) plus some PV and BESS in S11.

### B. Sensitivities

In addition, we investigate how the given results change when the CAPEX of the MeOH and NH<sub>3</sub> units are lower than expected, and when no unit commitment is enforced.

*a) Optimistic P2X CAPEX:* The values used so far are based on Danish Energy Agency estimates for a 12.5 t per hour plant size [16]. In general, investment expenditures quoted vary greatly between 4–17 M€ per ton methanol [17] and 3–7 M€ per ton ammonia [18] per hour. We find that with more optimistic CAPEX, full investment in P2X assets (even with base fuel prices) is conducted (S9–11). PPAs of 150 MW and less H<sub>2</sub> storage assets are needed to secure H<sub>2</sub> supply. Almost only P2X fuels and no H<sub>2</sub> is sold (Figs. 9+10).

*b) No Unit Commitment:* For the H<sub>2</sub>-only scenarios (S0–5), the linear optimization delivers approximately the same results as the MILP version because unit commitment plays a minor role for the more flexible electrolyzer. For the P2X scenarios (S6–11), however, the need for storage flexibility varies showing complex trade-offs between excess capacities, H<sub>2</sub> storage, and BESS (Figs. 11–12). The underlying effects should be investigated further.

## V. CONCLUSION

We model the capacity expansion problem for an energy hub inspired by the industrial park GreenLab Skive in North-West Denmark. Following the EC’s regulation on renewable hydrogen, we consider additionality as well as hourly and regional matching. The site has (fixed capacity) local RES (which it purchases at day-ahead prices) and can invest in additional PPAs and production capacities for different P2X

#	H2 sold t	H2 produced t (FLH)	P2X sold t (FLH)	Profit M€
0	0	0	-	-
1	all	4,532t (5,709h)	-	2.73
2	all	4,948t (5,553h)	-	7.94
3	all	11,509t (6400h)	-	4.96
4	all	13,134t (7,304h)	-	18.45
5	all	13,457t (7,483h)	-	32.86
6	5,541t	11,846t (6,587h)	33,503t (8,376h)	<b>5.68</b>
7	390t	13,570t (7,546h)	69,959t (7,773h)	<b>27.56</b>
8	3t	13,968t (7,768h)	74,281t (7,428h)	<b>50.67</b>
9	3,434t	11,905t (6,620h)	47,038t (7,840h)	5.66
10	0	13,357t (7,428h)	74,202t (7,420h)	21.86
11	0	13,677t (7,606h)	75,981t (7,598h)	39.02

TABLE II  
PRODUCED AND SOLD FUEL, FULL-LOAD HOURS AND PROFITS.

assets. We examine scenarios with only H<sub>2</sub>, and added either MeOH or NH<sub>3</sub> production. In addition, we evaluate the need for flexibility considering H<sub>2</sub> and battery storage systems. We take into account current P2X fuel price projections for 2030 and potential increases by 50% and 100%.

Using the current P2X fuel price projections for 2030 and restricting electricity sourcing to the existing local RES, only producing H<sub>2</sub> is not profitable (at €2.16 per kg). Only with higher fuel prices, a PPA, or producing H<sub>2</sub> derivatives can a profitable business case be achieved.

Producing P2X fuels, the PPA volume remains similar to the H<sub>2</sub>-only case because electricity is mainly used to produce and compress H<sub>2</sub>. 50% higher fuel prices lead to a mix of additional PV and H<sub>2</sub> storage to buffer supply to the P2X units. With higher fuel prices (+100%), continuous H<sub>2</sub> supply is secured using additional PV and battery storage. In all price scenarios, producing MeOH leads to the highest profit, followed by NH<sub>3</sub> and H<sub>2</sub>—the impact of CO<sub>2</sub> prices and availability should be investigated. More optimistic CAPEX shows larger assets already at lower fuel prices, reducing the need for flexibility from H<sub>2</sub> or BESS.

The maximum available capacity of the electrolyzer drives the PPA volume, which is needed to comply with renewable fuel regulations instead of sourcing from the grid. With additional RES available via PPA, the maximum electrolyzer installation seems to be the no-regret option (with quite high full-load hours). When producing the more profitable P2X fuels, H<sub>2</sub> supply can be subsequently expanded starting with a small H<sub>2</sub> storage unit of 500 kg<sub>H2</sub> plus any required fuel

storage depending on the final demand pattern, complemented later with additional PV and BESS.

Because we do not allow selling excess electricity, substantial amounts of RES are "curtailed". This could provide additional income for the owner of the assets—leading to an upper-bound price assumption for the PPA. However, large amounts of the local RES are also not consumed during hours of high day-ahead prices. This indicates that the balance of risks and rewards of these bilateral contracts needs to be reassessed in the context of instruments with greater long-term price certainty, such as PPAs on the supply side, but also in the light of the upcoming European Hydrogen Bank auctions for carbon contracts for difference (CCFDs) on the demand side. The impact on overall system capacities, flexibility, and emissions should be examined in this context.

## REFERENCES

- [1] European Commission. Commission sets out rules for renewable hydrogen; 2023. Available from: [https://ec.europa.eu/commission/presscorner/detail/en/IP\\_23\\_594](https://ec.europa.eu/commission/presscorner/detail/en/IP_23_594).
- [2] European Commission. REPowerEU: A plan to rapidly reduce dependence on Russian fossil fuels and fast forward the green transition; 2022. Available from: [https://ec.europa.eu/commission/presscorner/detail/en/IP\\_22\\_3131](https://ec.europa.eu/commission/presscorner/detail/en/IP_22_3131).
- [3] European Commission. Commission outlines European Hydrogen Bank to boost renewable hydrogen; 2023. Available from: <https://europa.eu/!kBjCrb>.
- [4] European Commission. European Green Deal: Commission proposes transformation of EU economy and society to meet climate ambitions; 2021. Available from: [https://ec.europa.eu/commission/presscorner/detail/en/ip\\_21\\_3541](https://ec.europa.eu/commission/presscorner/detail/en/ip_21_3541).
- [5] European Commission. Directive (EU) 2018/2001 of the European Parliament and of the Council of 11 December 2018 on the promotion of the use of energy from renewable sources; 2018. Available from: [https://eur-lex.europa.eu/legal-content/EN/TXT/?uri=uriserv:OJ.L\\_.2018.328.01.0082.01.ENG&toc=OJ:L:2018:328:TOC](https://eur-lex.europa.eu/legal-content/EN/TXT/?uri=uriserv:OJ.L_.2018.328.01.0082.01.ENG&toc=OJ:L:2018:328:TOC).
- [6] World Resources Institute (WRI). GHG Protocol Standards Update Process: Topline Findings From Scope 2 Feedback; 2023. Available from: [https://ghgprotocol.org/sites/default/files/2023-05/Topline%20Findings%20from%20Scope%20%20Feedback%20Webinar\\_GHG%20Protocol\\_05.02.2023.pdf](https://ghgprotocol.org/sites/default/files/2023-05/Topline%20Findings%20from%20Scope%20%20Feedback%20Webinar_GHG%20Protocol_05.02.2023.pdf).
- [7] European Commission. The Green Deal Industrial Plan: putting Europe's net-zero industry in the lead; 2023. Available from: [https://ec.europa.eu/commission/presscorner/detail/en/ip\\_23\\_510](https://ec.europa.eu/commission/presscorner/detail/en/ip_23_510).
- [8] European Commission. Questions and Answers on the EU Delegated Acts on Renewable Hydrogen; 2023. Available from: [https://ec.europa.eu/commission/presscorner/detail/en/qanda\\_23\\_595](https://ec.europa.eu/commission/presscorner/detail/en/qanda_23_595).
- [9] Ricks W, Xu Q, Jenkins JD. Minimizing emissions from grid-based hydrogen production in the United States. *Environmental Research Letters*. 2023 Jan;18(1):014025. Publisher: IOP Publishing. Available from: <https://dx.doi.org/10.1088/1748-9326/acab5>.
- [10] Brauer J, Villavicencio M, Trüby J. Green hydrogen – How grey can it be? Robert Schuman Centre for Advanced Studies (FSR); 2022. Available from: <https://cadmus.eui.eu/handle/1814/74850>.
- [11] Zeyen E, Riepin I, Brown T. Hourly versus annually matched renewable supply for electrolytic hydrogen; 2022. Available from: [https://zenodo.org/record/7457441/preview/Report\\_TUB\\_hourlyvsannually.pdf](https://zenodo.org/record/7457441/preview/Report_TUB_hourlyvsannually.pdf).
- [12] Kountouris I, Langer L, Bramstoft R, Münster M, Keles D. Power-to-X in energy hubs: A Danish case study of renewable fuel production. *Energy Policy*. 2023 Apr;175:113439. Available from: <https://www.sciencedirect.com/science/article/pii/S0301421523000241>.
- [13] Ihlemann M, Kouveliotis-Lysikatos I, Huang J, Dillon J, O'Dwyer C, Rasku T, et al. SpineOpt: A flexible open-source energy system modelling framework. *Energy Strategy Reviews*. 2022 Sep;43:100902. Available from: <https://www.sciencedirect.com/science/article/pii/S2211467X22000955>.
- [14] Kiviluoma J, Pallonetto F, Marin M, Savolainen PT, Soininen A, Vennström P, et al. Spine Toolbox: A flexible open-source workflow management system with scenario and data management. *SoftwareX*. 2022 Jan;17:100967. Available from: <https://www.sciencedirect.com/science/article/pii/S2352711021001886>.
- [15] Energinet. SYSTEM PERSPECTIVE ANALYSIS 2022 PATHWAYS TOWARDS A ROBUST FUTURE ENERGY SYSTEM; 2022. Available from: [https://www.energinet.dk/media/5rhoqjy/pathways-towards-a-robust-future-energy-system\\_energinet-2023-01-23.pdf](https://www.energinet.dk/media/5rhoqjy/pathways-towards-a-robust-future-energy-system_energinet-2023-01-23.pdf).
- [16] Danish Energy Agency. Technology Data for energy carrier generation and conversion; 2022. Available from: <https://ens.dk/en/our-services/projections-and-models/technology-data/technology-data-renewable-fuels>.
- [17] PyPSA. Technology data 2030; 2022. Available from: [https://github.com/PyPSA/technology-data/blob/master/outputs/costs\\_2030.csv](https://github.com/PyPSA/technology-data/blob/master/outputs/costs_2030.csv).
- [18] Ikäheimo J, Kiviluoma J, Weiss R, Holttinen H. Power-to-ammonia in future North European 100 % renewable power and heat system. *International Journal of Hydrogen Energy*. 2018 Sep;43(36):17295-308. Available from: <https://linkinghub.elsevier.com/retrieve/pii/S0360319918319931>.

APPENDIX A  
ADDITIONAL FIGURES

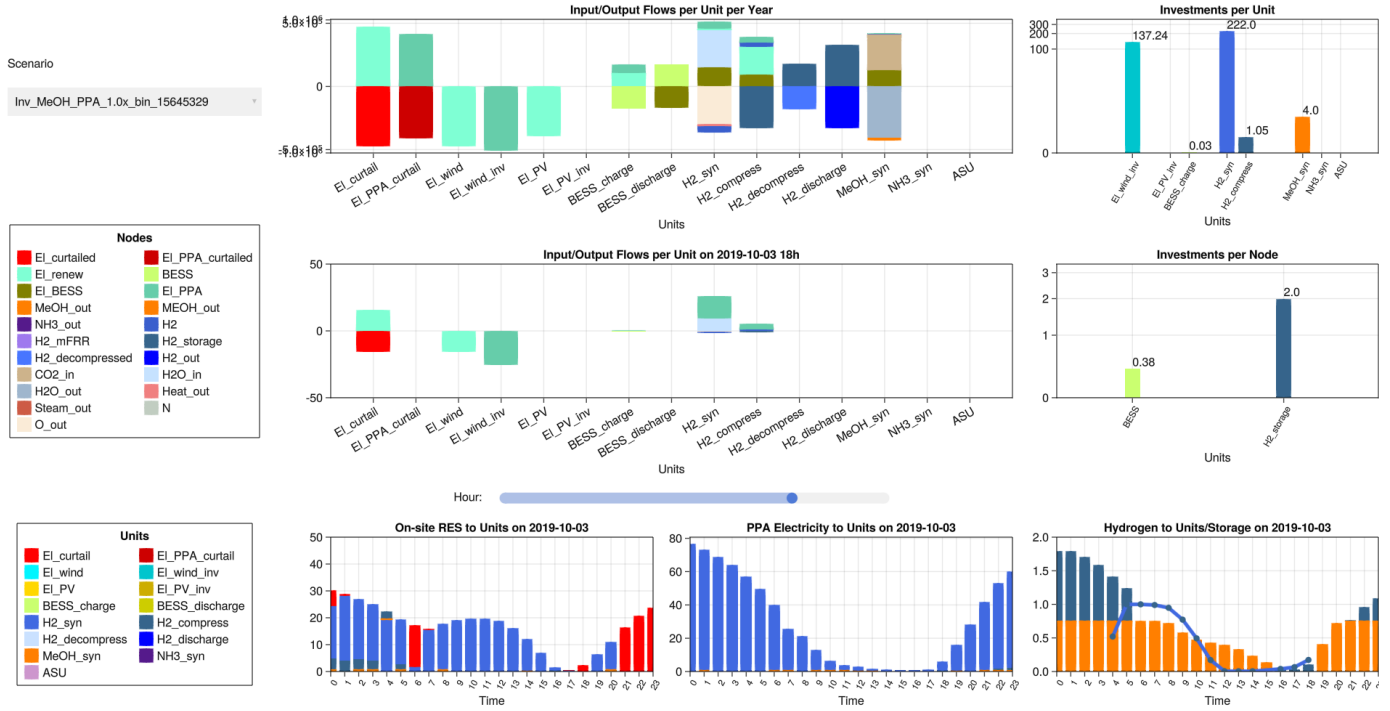

Fig. 3. GreenLab Skive energy park investment and illustrative operational decisions of scenario S6 in Table I (non-indicated values are zero).

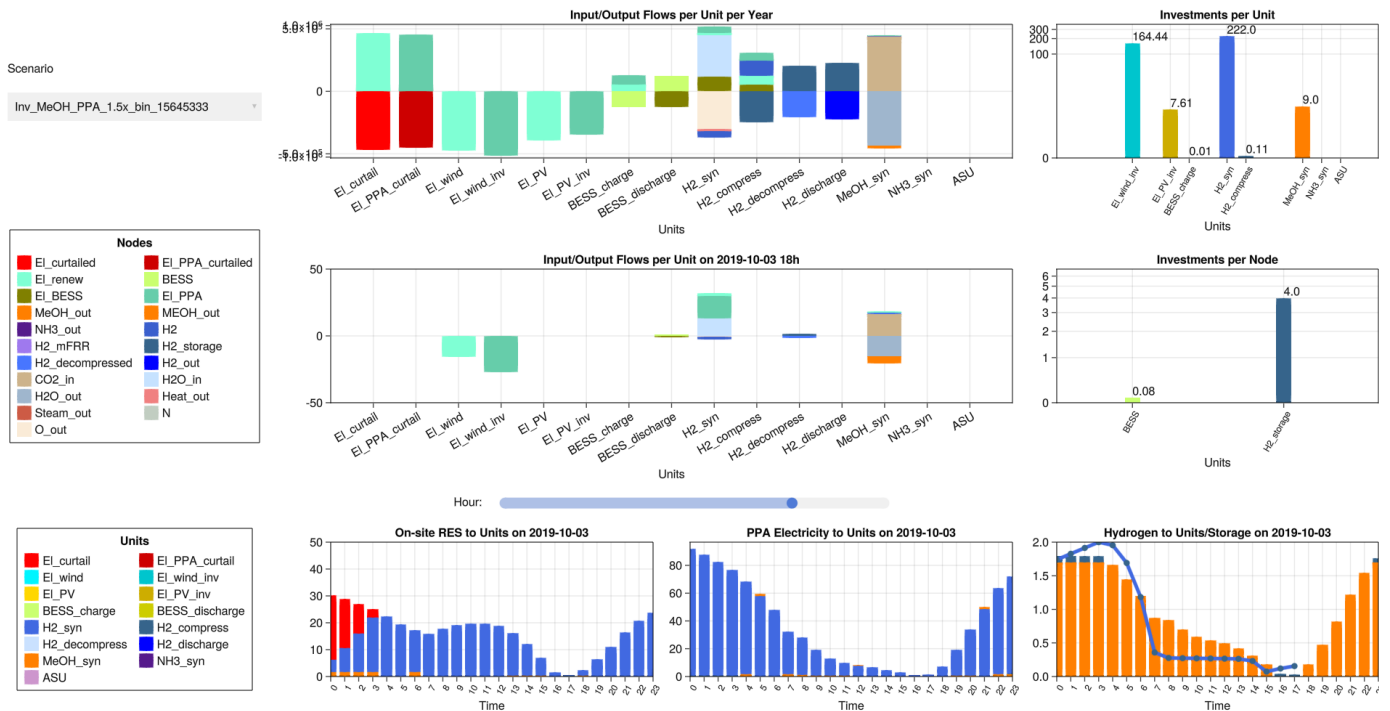

Fig. 4. GreenLab Skive energy park investment and illustrative operational decisions of scenario S7 in Table I (non-indicated values are zero).



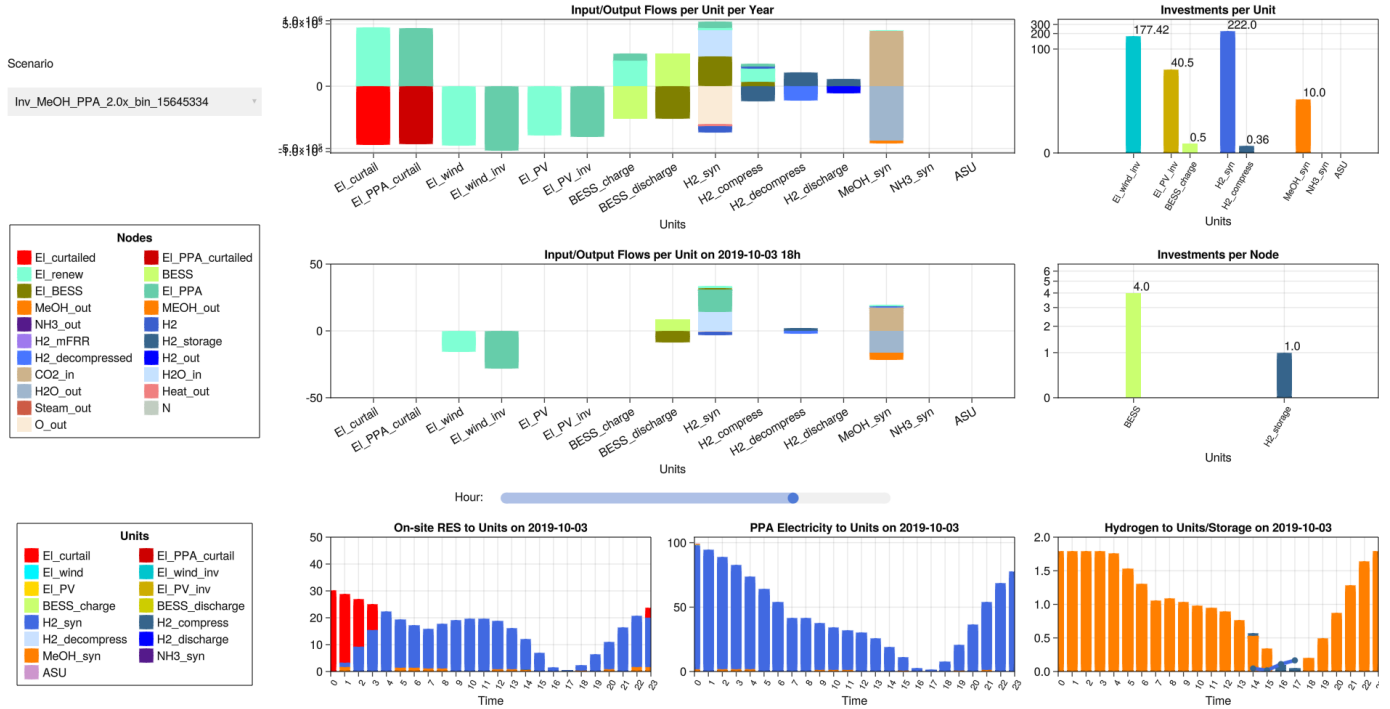

Fig. 5. GreenLab Skive energy park investment and illustrative operational decisions of scenario S8 in Table I (non-indicated values are zero).

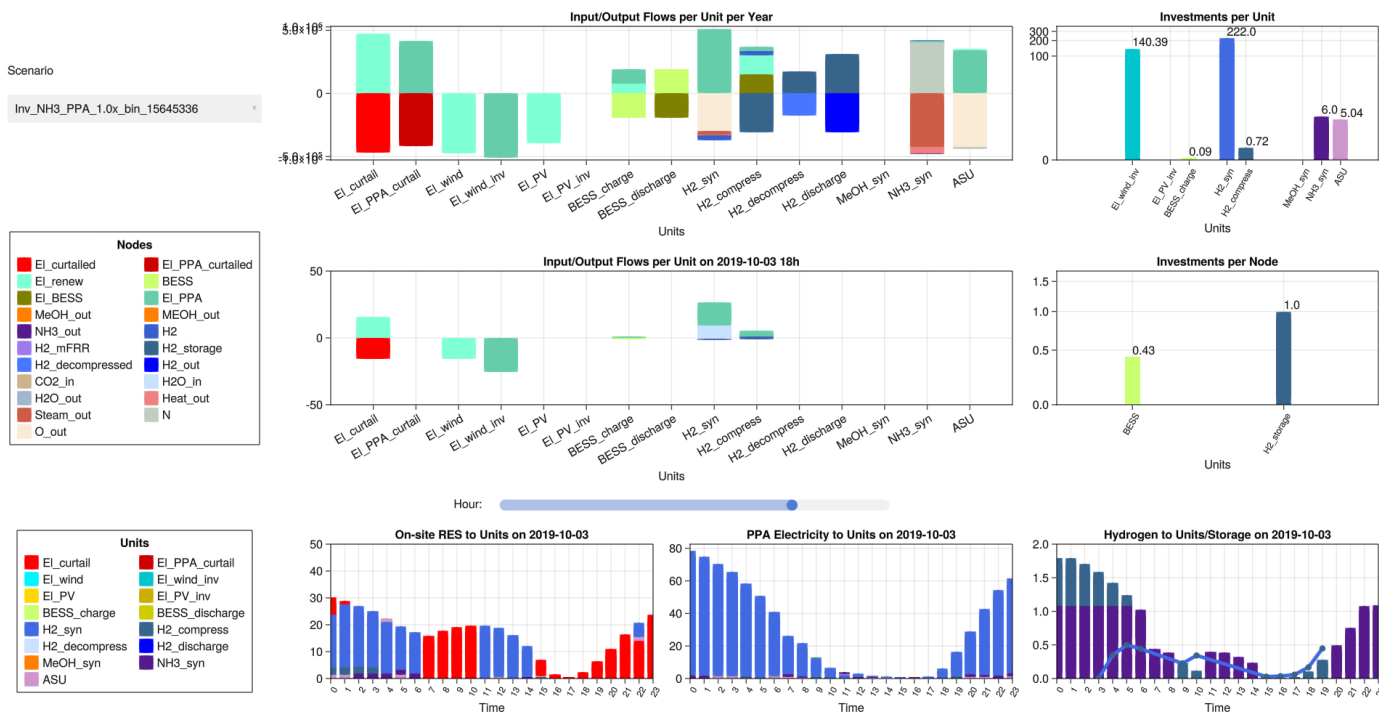

Fig. 6. GreenLab Skive energy park investment and illustrative operational decisions of scenario S9 in Table I (non-indicated values are zero).

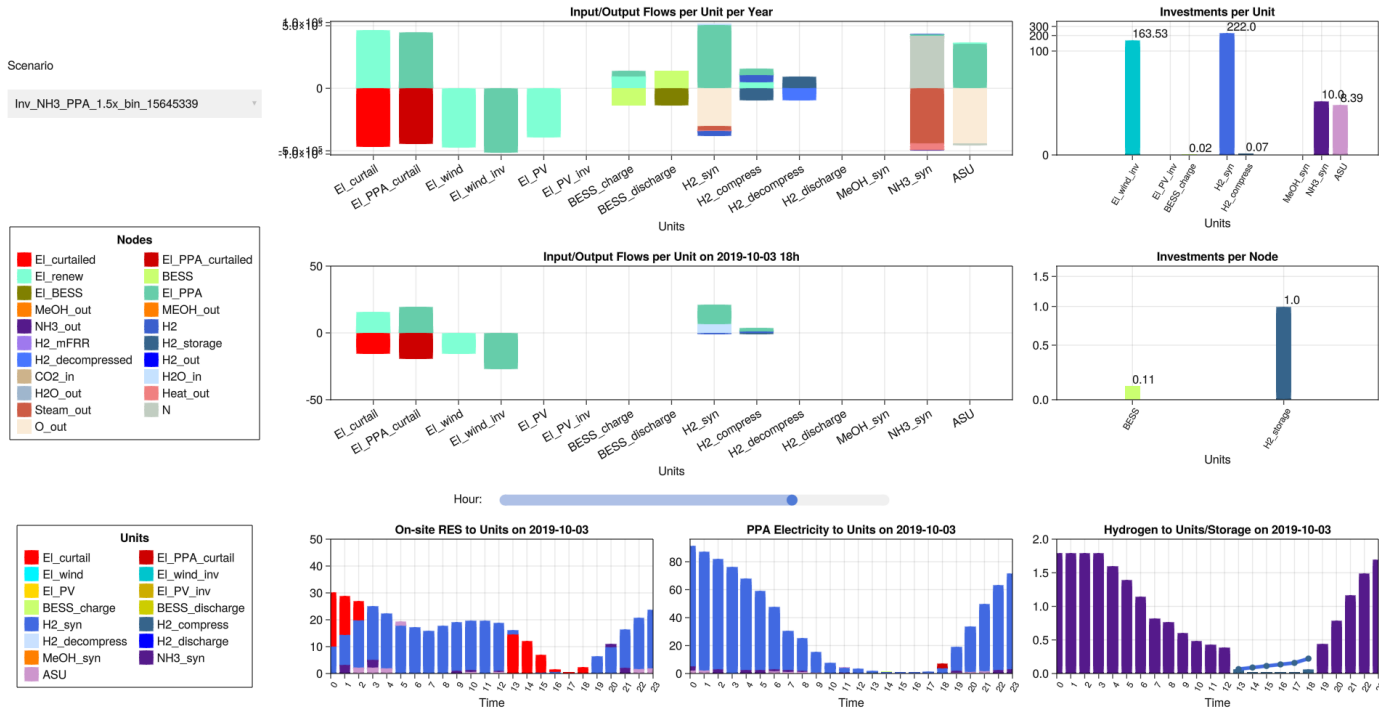

Fig. 7. GreenLab Skive energy park investment and illustrative operational decisions of scenario S10 in Table I (non-indicated values are zero).

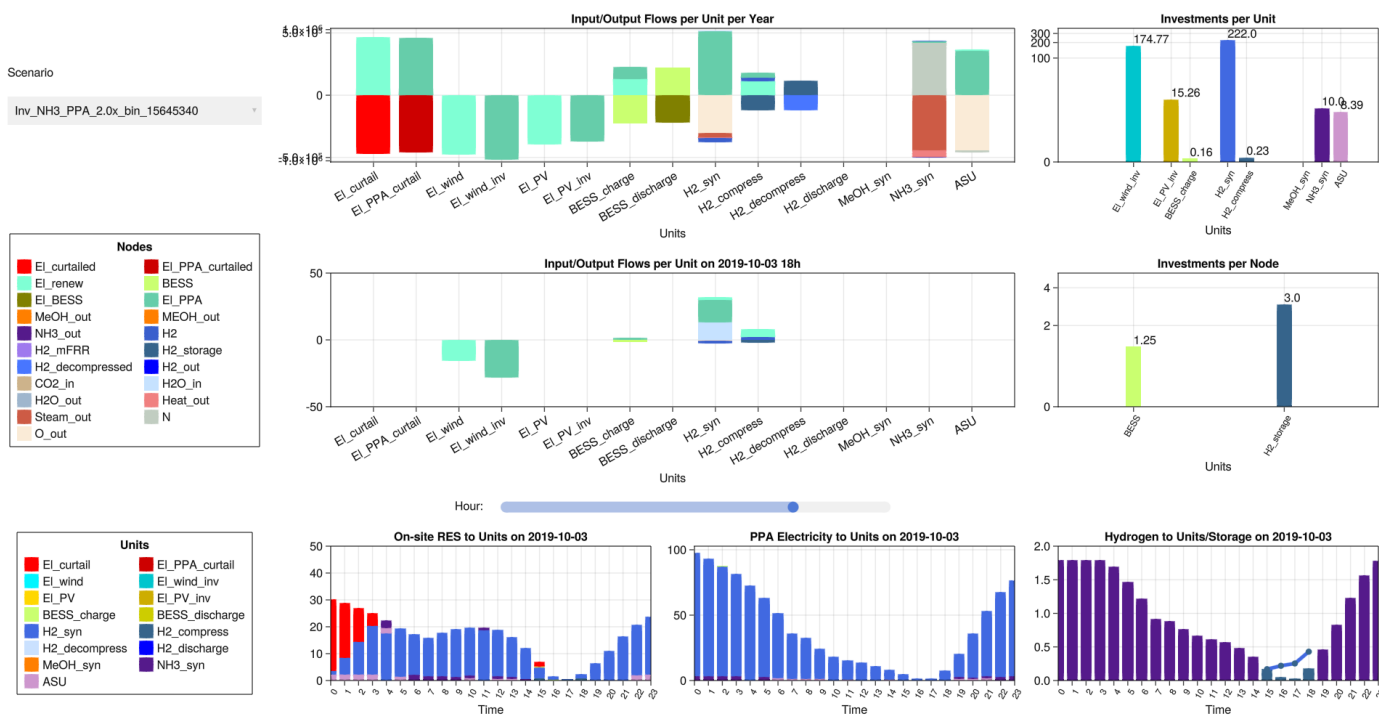

Fig. 8. GreenLab Skive energy park investment and illustrative operational decisions of scenario S11 in Table I (non-indicated values are zero).

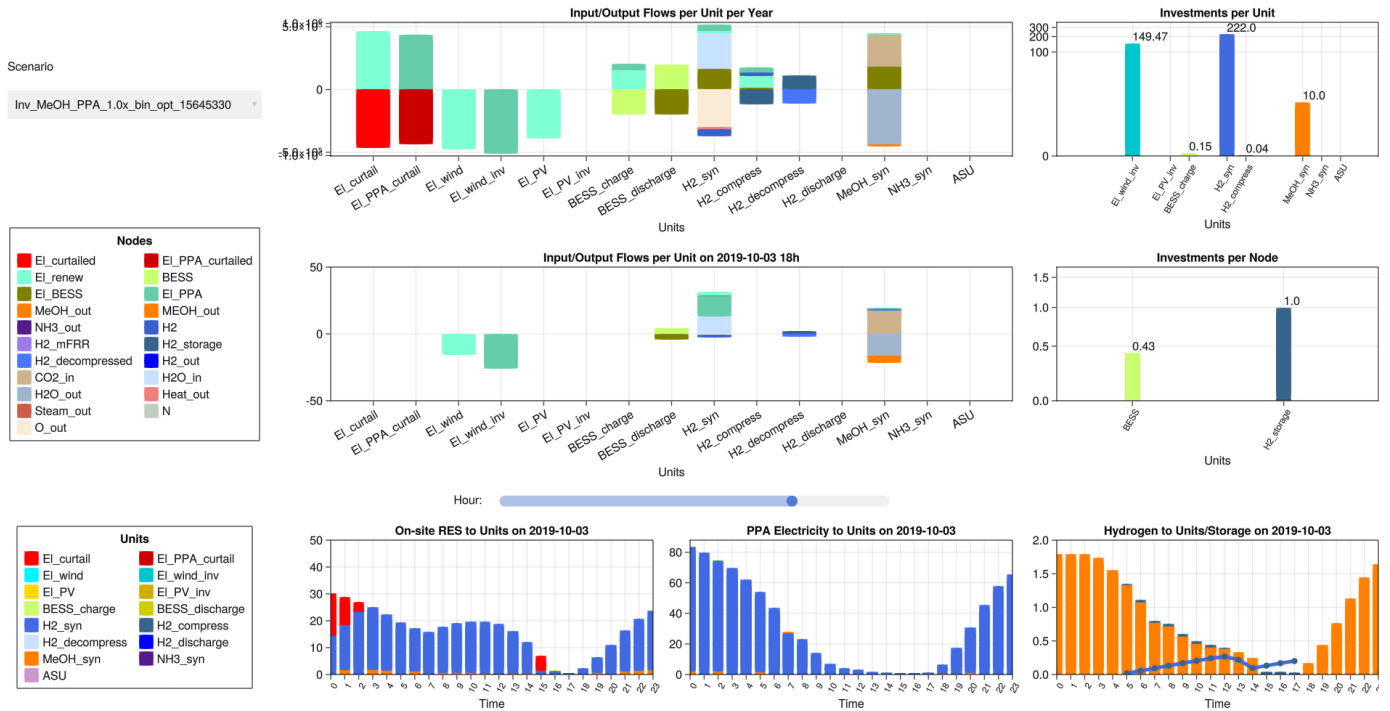

Fig. 9. GreenLab Skive energy park investment and illustrative operational decisions of scenario S6 with optimistic CAPEX (non-indicated values are zero).

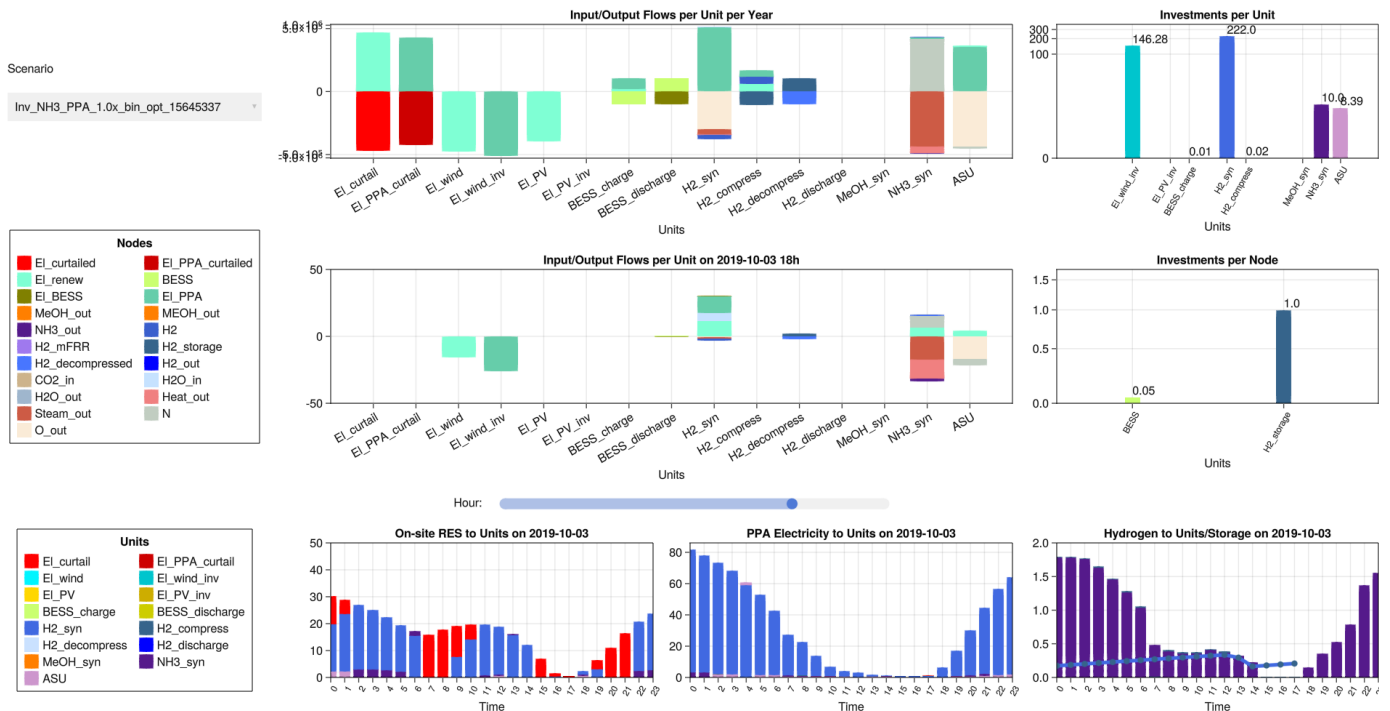

Fig. 10. GreenLab Skive energy park investment and illustrative operational decisions of scenario S9 with optimistic CAPEX (non-indicated values are zero).

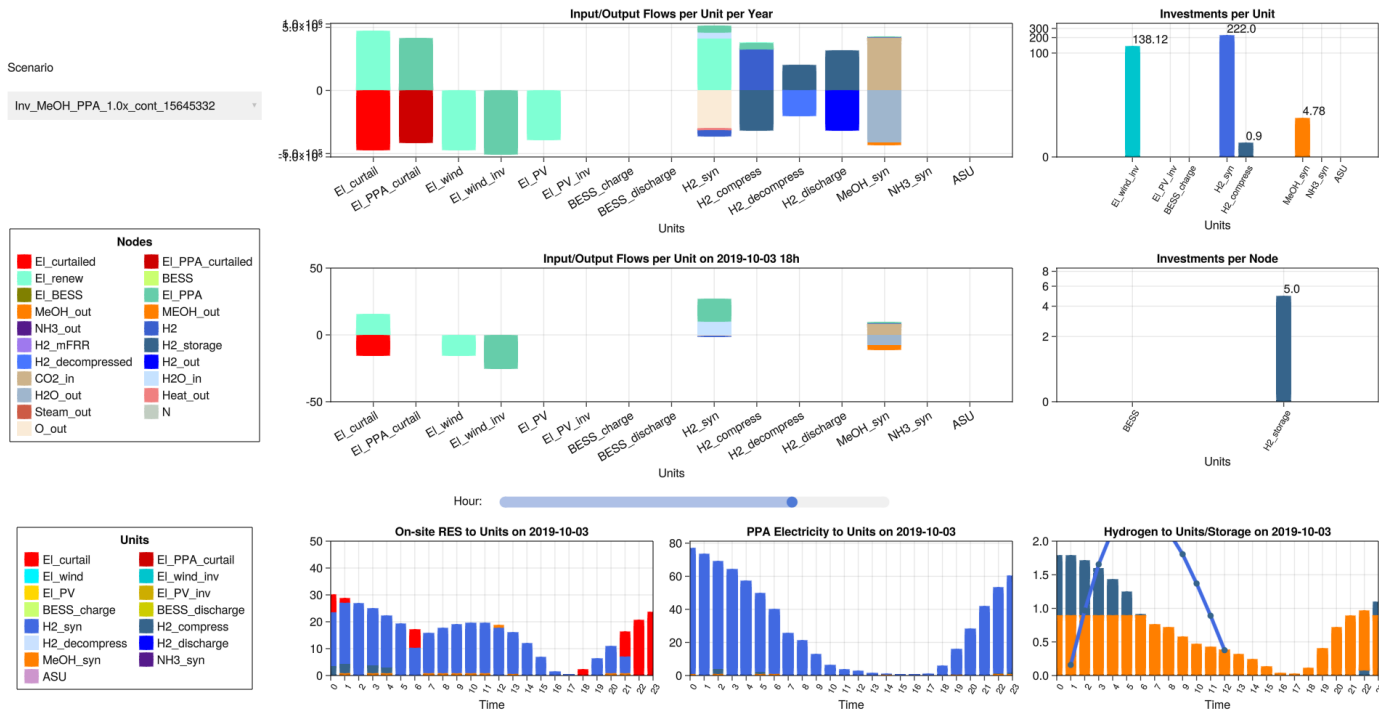

Fig. 11. GreenLab Skive energy park investment and illustrative operational decisions of scenario S6 **without unit commitment** (non-indicated values are zero).

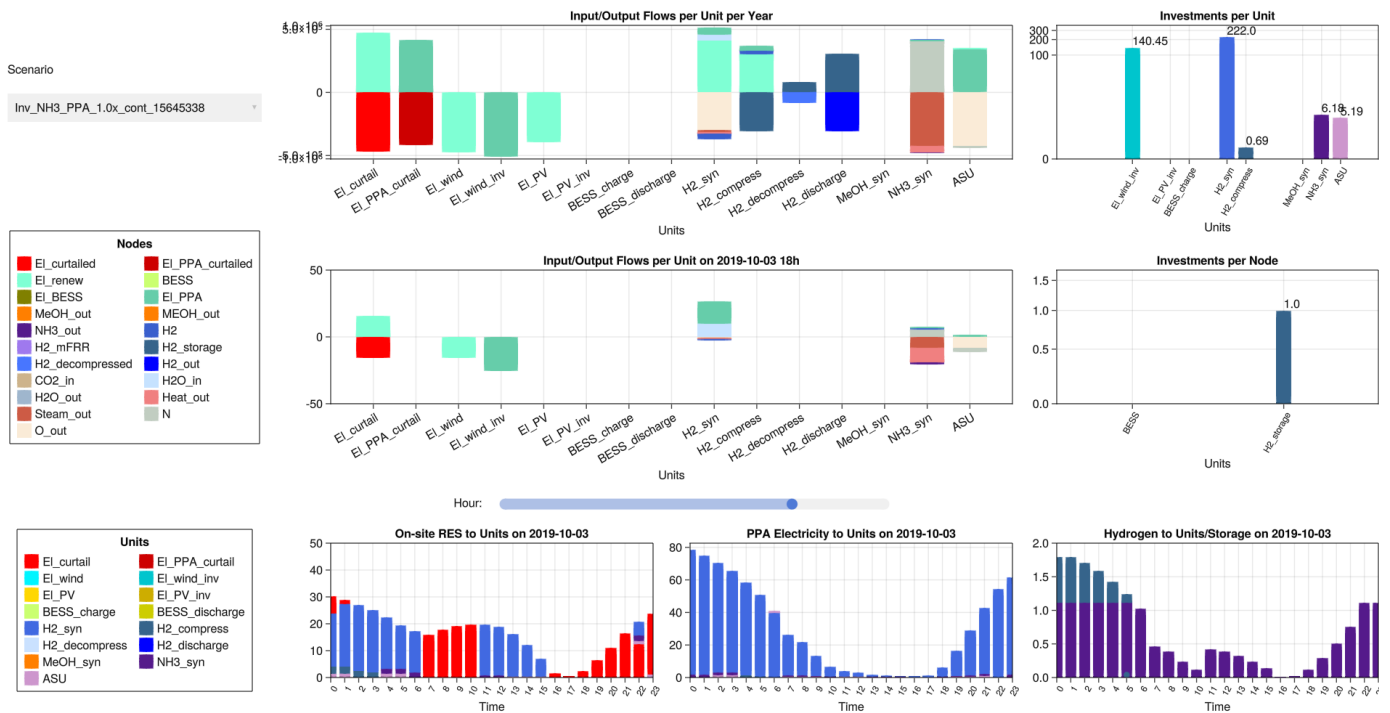

Fig. 12. GreenLab Skive energy park investment and illustrative operational decisions of scenario S9 **without unit commitment** (non-indicated values are zero).

APPENDIX B  
DATA INPUT

Scenario	0	1	2	3	4	5	6	7	8	9	10	11	a	b
Base	✓	✓	✓	✓	✓	✓	✓	✓	✓	✓	✓	✓	✓	✓
Inv	✓	✓	✓	✓	✓	✓	✓	✓	✓	✓	✓	✓	✓	✓
Tech-H2-units (place before H2 invests)	✓	✓	✓	✓	✓	✓	✓	✓	✓	✓	✓	✓	✓	✓
Inv-H2-on	✓	✓	✓	✓	✓	✓	✓	✓	✓	✓	✓	✓	✓	✓
Inv-H2-int	✓	✓	✓	✓	✓	✓	✓	✓	✓	✓	✓	✓	✓	✓
Inv-H2-cont													✓	✓
Inv-MeOH-on							✓	✓	✓				⊗	⊗
Inv-MeOH-bin (combine with on)							✓	✓	✓				⊗	⊗
Inv-MeOH-cont (combine with on)													⊗	⊗
Inv-NH3-on										✓	✓	✓	⊗	⊗
Inv-NH3-bin (combine with on)										✓	✓	✓	⊗	⊗
Inv-NH3-cont (combine with on)													⊗	⊗
Inv-PPA				✓	✓	✓	✓	✓	✓	✓	✓	✓	⊗	⊗
Inv-storage-compress	✓	✓	✓	✓	✓	✓	✓	✓	✓	✓	✓	✓	⊗	⊗
Mod-UC	✓	✓	✓	✓	✓	✓	✓	✓	✓	✓	✓	✓	⊗	⊗
Premium-1.5x		✓			✓			✓			✓		⊗	⊗
Premium-2x						✓			✓				⊗	⊗
Solver-Gurobi	✓	✓	✓	✓	✓	✓	✓	✓	✓	✓	✓	✓	⊗	⊗
Year	✓	✓	✓	✓	✓	✓	✓	✓	✓	✓	✓	✓	⊗	⊗

TABLE III  
PAPER SCENARIOS MATCHED WITH MODEL SCENARIOS (STACKED).

Parameter	Type	Value	Scenario
db_lp_solver	model	Gurobi.jl	Solver-Gurobi
db_mip_solver	model	Gurobi.jl	Solver-Gurobi
duration_unit	model	hour	Base
model_end	model	2019-01-01T03:00:00	Base
model_end	model	2019-12-31T00:00:00	Year
model_start	model	2019-01-01T00:00:00	Base
resolution	temporal_block	1h	Base
block_end	temporal_block	364D	Inv
block_start	temporal_block	0h	Inv
resolution	temporal_block	364D	Inv
constraint_sense	user_constraint	<=	Inv-MeOH-bin (combine with on)
right_hand_side	user_constraint	8736	Inv-MeOH-bin (combine with on)
constraint_sense	user_constraint	<=	Inv-NH3-bin (combine with on)
right_hand_side	user_constraint	8736	Inv-NH3-bin (combine with on)

TABLE IV  
MODEL PARAMETERS.



Unit	Parameter	Time	Value	Scenario
BESS_charge	candidate_units		3	Inv-storage-compress
BESS_charge	fom_cost		4800	Inv-storage-compress
BESS_charge	number_of_units		0	Inv-storage-compress
BESS_charge	unit_investment_cost		23845	Inv-storage-compress
BESS_charge	unit_investment_variable_type		unit_investment_variable_type_continuous	Inv-storage-compress
El_PV	fix_units_on	hourly	time series	Base
El_wind	fix_units_on	hourly	time series	Base
H2_compress	candidate_units		35	Inv-storage-compress
H2_compress	fom_cost		8339	Inv-storage-compress
H2_compress	number_of_units		0	Inv-storage-compress
H2_compress	unit_investment_cost		807792	Inv-storage-compress
H2_compress	unit_investment_variable_type		unit_investment_variable_type_continuous	Inv-storage-compress
H2_syn	candidate_units		222	Inv-H2-on
H2_syn	fom_cost		3732	Inv-H2-on
H2_syn	min_down_time		2h	Mod-UC
H2_syn	number_of_units		0	Inv-H2-on
H2_syn	number_of_units		222	Tech-H2-units (place before H2 invests)
H2_syn	online_variable_type		unit_online_variable_type_integer	Mod-UC
H2_syn	unit_investment_cost		16574	Inv-H2-on
H2_syn	unit_investment_variable_type		unit_investment_variable_type_continuous	Inv-H2-cont
H2_syn	unit_investment_variable_type		unit_investment_variable_type_integer	Inv-H2-int
H2_syn	unit_investment_variable_type		unit_investment_variable_type_continuous	Inv-H2-cont
MeOH_syn	candidate_units		1	Inv-MeOH-bin (combine with on)
MeOH_syn	candidate_units		10	Inv-MeOH-cont (combine with on)
MeOH_syn	fom_cost		292972	Inv-MeOH-on
MeOH_syn	is_active		true	Inv-MeOH-on
MeOH_syn	number_of_units		0	Inv-MeOH-on
MeOH_syn	unit_investment_cost		1477965	Inv-MeOH-on
MeOH_syn	unit_investment_variable_type		unit_investment_variable_type_integer	Inv-MeOH-bin (combine with on)
MeOH_syn	unit_investment_variable_type		unit_investment_variable_type_continuous	Inv-MeOH-cont (combine with on)
MeOH_syn_02	candidate_units		1	Inv-MeOH-bin (combine with on)
MeOH_syn_02	fom_cost		585944	Inv-MeOH-bin (combine with on)
MeOH_syn_02	is_active		true	Inv-MeOH-bin (combine with on)
MeOH_syn_02	number_of_units		0	Inv-MeOH-bin (combine with on)
MeOH_syn_02	unit_investment_cost		2955930	Inv-MeOH-bin (combine with on)
MeOH_syn_02	unit_investment_variable_type		unit_investment_variable_type_integer	Inv-MeOH-bin (combine with on)
...				
MeOH_syn_10	candidate_units		1	Inv-MeOH-bin (combine with on)
MeOH_syn_10	fom_cost		2929722	Inv-MeOH-bin (combine with on)
MeOH_syn_10	is_active		true	Inv-MeOH-bin (combine with on)
MeOH_syn_10	number_of_units		0	Inv-MeOH-bin (combine with on)
MeOH_syn_10	unit_investment_cost		14779652	Inv-MeOH-bin (combine with on)
MeOH_syn_10	unit_investment_variable_type		unit_investment_variable_type_integer	Inv-MeOH-bin (combine with on)
NH3_syn	candidate_units		1	Inv-NH3-bin (combine with on)
NH3_syn	candidate_units		10	Inv-NH3-cont (combine with on)
NH3_syn	fom_cost		211646	Inv-NH3-on
NH3_syn	is_active		true	Inv-NH3-on
NH3_syn	number_of_units		0	Inv-NH3-on
NH3_syn	unit_investment_cost		626666	Inv-NH3-on
NH3_syn	unit_investment_variable_type		unit_investment_variable_type_integer	Inv-NH3-bin (combine with on)
NH3_syn	unit_investment_variable_type		"unit_investment_variable_type_continuous"	Inv-NH3-cont (combine with on)
NH3_syn_05	candidate_units		1	Inv-NH3-bin (combine with on)
NH3_syn_05	fom_cost		1058230	Inv-NH3-bin (combine with on)
NH3_syn_05	is_active		true	Inv-NH3-bin (combine with on)
NH3_syn_05	number_of_units		0	Inv-NH3-bin (combine with on)
NH3_syn_05	unit_investment_cost		3133329	Inv-NH3-bin (combine with on)
NH3_syn_05	unit_investment_variable_type		unit_investment_variable_type_integer	Inv-NH3-bin (combine with on)
...				
NH3_syn_10	candidate_units		1	Inv-NH3-bin (combine with on)
NH3_syn_10	fom_cost		2116460	Inv-NH3-bin (combine with on)
NH3_syn_10	is_active		true	Inv-NH3-bin (combine with on)
NH3_syn_10	number_of_units		0	Inv-NH3-bin (combine with on)
NH3_syn_10	unit_investment_cost		6266657	Inv-NH3-bin (combine with on)
NH3_syn_10	unit_investment_variable_type		unit_investment_variable_type_integer	Inv-NH3-bin (combine with on)

TABLE V  
UNIT PARAMETERS.

Node	Parameter	Time	Value	Scenario
BESS	candidate_storages	2018-12-31T23:00:00	10	Inv-storage-compress
BESS	fix_node_state		0	Base
BESS	frac_state_loss		4.00E-05	Base
BESS	has_state		TRUE	Base
BESS	node_state_cap		1	Inv-storage-compress
BESS	storage_investment_cost		13302	Inv-storage-compress
BESS	storage_investment_variable_type		variable_type_continuous	Inv-storage-compress
El_BESS	nodal_balance_sense		==	Base
El_curtailed	nodal_balance_sense		>=	Base
El_renew	nodal_balance_sense		==	Base
Group_El	nodal_balance_sense		==	Base
Group_H2_mFRR	nodal_balance_sense		==	Base
H2	nodal_balance_sense		==	Base
H2_decompressed	nodal_balance_sense		==	Base
H2_out	nodal_balance_sense		>=	Base
H2_storage	candidate_storages		5	Inv-storage-compress
H2_storage	fix_node_state		0	Base
H2_storage	frac_state_loss		0.01	Base
H2_storage	has_state		TRUE	Base
H2_storage	node_state_cap		0.5	Inv-storage-compress
H2_storage	storage_investment_cost	24229	Inv-storage-compress	
H2_storage	storage_investment_variable_type	variable_type_integer	Inv-storage-compress	
H2O_in	nodal_balance_sense	<=	Base	
H2O_out	nodal_balance_sense	>=	Base	
Heat_out	nodal_balance_sense	>=	Base	
O_out	nodal_balance_sense	>=	Base	
Steam_out	nodal_balance_sense	>=	Base	

TABLE VI  
NODE PARAMETERS.

Parameter	Relationship	Direction	Unit	Node	Time	Value	Scenario
fix_ratio_in_out_unit_flow	unit__node__node_BESS_charge_Group_El_BESS	unit__node__node	BESS_charge	Group_El		1.015	Base
fix_ratio_in_out_unit_flow	unit__node__node_BESS_discharge_BESS_El_BESS	unit__node__node	BESS_discharge	BESS		1.026	Base
fix_ratio_in_out_unit_flow	unit__node__node_El_curtail_El_renew_El_curtailed	unit__node__node	El_curtail	El_renew		1	Base
fix_ratio_in_out_unit_flow	unit__node__node_H2_compress_Group_El_H2_storage	unit__node__node	H2_compress	Group_El		4	Base
fix_ratio_in_out_unit_flow	unit__node__node_H2_compress_H2_H2_storage	unit__node__node	H2_compress	H2		1	Base
fix_ratio_in_out_unit_flow	unit__node__node_H2_decompress_H2_storage_H2_decompressed	unit__node__node	H2_decompress	H2_storage		1	Base
fix_ratio_in_out_unit_flow	unit__node__node_H2_discharge_H2_storage_H2_out	unit__node__node	H2_discharge	H2_storage		1	Base
fix_ratio_in_out_unit_flow	unit__node__node_H2_syn_Group_El_Group_H2_mFRR	unit__node__node	H2_syn	Group_El		53.6	Base
fix_ratio_in_out_unit_flow	unit__node__node_H2_syn_H2O_in_H2	unit__node__node	H2_syn	H2O_in		9.9999	Base
fix_ratio_out_out_unit_flow	unit__node__node_H2_syn_H2_Heat_out	unit__node__node	H2_syn	H2		9.763	Base
fix_ratio_out_out_unit_flow	unit__node__node_H2_syn_H2_O_out	unit__node__node	H2_syn	H2		4.965	Base
fuel_cost	unit__from__node_BESS_charge_El_renew	unit__from__node	BESS_charge	El_renew	hourly	DK1 2019	Base
fuel_cost	unit__from__node_H2_compress_El_renew	unit__from__node	H2_compress	El_renew	hourly	DK1 2019	Base
fuel_cost	unit__from__node_H2_syn_El_renew	unit__from__node	H2_syn	El_renew	hourly	DK1 2019	Base
fuel_cost	unit__from__node_H2_syn_H2O_in	unit__from__node	H2_syn	H2O_in		10	Base
fuel_cost	unit__to__node_El_curtail_El_curtailed	unit__to__node	El_curtail	El_curtailed		-0.0001	Base
fuel_cost	unit__to__node_H2_discharge_H2_out	unit__to__node	H2_discharge	H2_out		-2160	Base
fuel_cost	unit__to__node_H2_discharge_H2_out	unit__to__node	H2_discharge	H2_out		-3240	Premium-1.5x
fuel_cost	unit__to__node_H2_discharge_H2_out	unit__to__node	H2_discharge	H2_out		-4320	Premium-2x
fuel_cost	unit__to__node_H2_syn_Heat_out	unit__to__node	H2_syn	Heat_out		-2	Base
fuel_cost	unit__to__node_H2_syn_O_out	unit__to__node	H2_syn	O_out		-1	Base
minimum_operating_point	unit__to__node_H2_syn_Group_H2_mFRR	unit__to__node	H2_syn	Group_H2_mFRR		0.2	Mod-UC
minimum_operating_point	unit__to__node_H2_syn_H2	unit__to__node	H2_syn	H2		0.2	Mod-UC
unit_capacity	unit__from__node_BESS_discharge_BESS	unit__from__node	BESS_discharge	BESS		1	Base
unit_capacity	unit__from__node_H2_compress_H2	unit__from__node	H2_compress	H2		0.06	Base
unit_capacity	unit__from__node_H2_compress_H2	unit__from__node	H2_compress	H2		1	Inv-storage-compress
unit_capacity	unit__to__node_BESS_charge_BESS	unit__to__node	BESS_charge	BESS		1	Base
unit_capacity	unit__to__node_El_PV_El_renew	unit__to__node	El_PV	El_renew		27	Base
unit_capacity	unit__to__node_El_wind_El_renew	unit__to__node	El_wind	El_renew		54	Base
unit_capacity	unit__to__node_H2_syn_Group_H2_mFRR	unit__to__node	H2_syn	Group_H2_mFRR		0.235	Base
unit_capacity	unit__to__node_H2_syn_Group_H2_mFRR	unit__to__node	H2_syn	Group_H2_mFRR		0.0081	Tech-H2-units (place before H2 invests)
unit_capacity	unit__to__node_H2_syn_H2	unit__to__node	H2_syn	H2		0.235	Base
unit_capacity	unit__to__node_H2_syn_H2	unit__to__node	H2_syn	H2		0.0081	Tech-H2-units (place before H2 invests)

TABLE VII  
RELATIONSHIP PARAMETERS.