

A NEW YOUNG WALL REALIZATION OF $B(\lambda)$ AND $B(\infty)$

ZHAOBING FAN, SHAOLONG HAN, SEOK-JIN KANG, AND YOUNG ROCK KIM*

ABSTRACT. Using new combinatorics of Young walls, we give a new construction of the arbitrary level highest weight crystal $B(\lambda)$ for the quantum affine algebras of types $A_{2n}^{(2)}$, $D_{n+1}^{(2)}$, $A_{2n-1}^{(2)}$, $D_n^{(1)}$, $B_n^{(1)}$ and $C_n^{(1)}$. We show that the crystal consisting of reduced Young walls is isomorphic to the crystal $B(\lambda)$. Moreover, we provide a new realization of the crystal $B(\infty)$ in terms of reduced virtual Young walls and reduced extended Young walls.

CONTENTS

1. Introduction	1
2. Quantum affine algebras and perfect crystals	4
3. Higher level Young columns	9
4. Higher level Young walls	25
5. New Young wall realization of the crystal $B(\infty)$	37
References	43

1. INTRODUCTION

Arguably, one of the most remarkable achievements in representation theory in 1990's would be the canonical basis theory and crystal basis theory for quantum groups, which were developed by Lusztig and Kashiwara, respectively [15, 16, 11, 12]. They have made very deep and important impacts on a wide variety of areas in mathematics.

Among others, when we narrow down to the case of quantum affine algebras, it was discovered that their representation theory has a close connection with mathematical physics such as soliton equations, conformal field theory and vertex models. For example, the one point function for the 6-vertex model can be expressed as the quotient of the string function by the character of $V(\Lambda_0)$ over $U_q(\widehat{\mathfrak{sl}}_2)$. Thus it is a very important problem to give an explicit realization of integrable highest weight modules over quantum affine algebras.

Motivated by this problem, Kang, Kashiwara, Misra, Miwa, Nakashima and Nakayashiki developed the theory of *perfect crystals* [6, 7]. Using perfect crystals, one can give a *path realization* of the crystal $B(\lambda)$ of the integrable highest weight module $V(\lambda)$. In this way, the theory of vertex models can be explained in the language of crystal basis theory of quantum affine algebras.

The aim of this paper is to provide a new combinatorial realization of the crystal $B(\lambda)$ and $B(\infty)$ for the quantum affine algebras of types $A_{2n}^{(2)}$, $D_{n+1}^{(2)}$, $A_{2n-1}^{(2)}$, $D_n^{(1)}$, $B_n^{(1)}$ and $C_n^{(1)}$. Here, λ is a dominant integral weight of arbitrary level.

2010 *Mathematics Subject Classification.* 17B37, 17B67, 16G20.

Key words and phrases. quantum affine algebra, crystal basis, highest weight crystal, Young wall.

* Corresponding author.

The basic idea behind this realization is *combinatorics of Young walls*; i.e., playing a game with various blocks of different colors and different shapes. The combinatorics of Young walls and its connection with crystal bases were introduced by Kang [4]. More precisely, he first introduced the notion of Young walls and reduced Young walls, and explained their combinatorics. The action of Kashiwara operators was defined in terms of combinatorics of Young walls, which provides a crystal structure on the set of (reduced) Young walls. Then he proved that the crystal consisting of reduced Young walls is isomorphic to the level-1 highest weight crystal $B(\lambda)$.

Kang's construction was extended to the case of higher level Young walls by Kang and Lee [9, 10]. As a natural approach, to define higher level Young walls, they used multiple layers of level-1 Young walls. They defined the notion of Young walls and reduced Young walls, and proved that the crystal consisting of reduced Young walls is isomorphic to the crystal $B(\lambda)$ with a dominant integral weight of higher level. However, in this approach, it is quite complicated to describe the combinatorics. In particular, the definition of Kashiwara operators is not easy to follow. Thus it is desirable to find another combinatorial construction which has much simpler description of Young walls, reduced Young walls and Kashiwara operators. We think it is worth to mention that Lee gave a Young wall realization of the crystal $B(\infty)$ as the direct limit of the crystals $B(\lambda)$ using marginally large Young walls [14]. Also, in [18], Savage gave a combinatorial realization of higher level crystals for $U_q(A_n^{(1)})$ in terms of Young pyramids.

In this paper, we take a different approach from the one given in [9, 10]. As usual, we will denote the size of a block by width \times depth \times height. Let us begin with a unit cube, i.e., a block of size $1 \times 1 \times 1$. Given a positive integer $l \geq 1$, we cut this unit cube vertically to obtain the blocks of size $\frac{1}{l} \times 1 \times 1$, $\frac{1}{l} \times \frac{1}{2} \times 1$, $\frac{1}{2l} \times 1 \times 1$ and $\frac{1}{2l} \times \frac{1}{2} \times 1$. Note that the *vertical cutting* includes two vertical directions.

We give a coloring to these blocks depending on the type of affine Cartan datum. Then we provide explicit stacking patterns for blocks and introduce the notion of δ -slices, Young columns and reduced Young columns. Each reduced Young column corresponds to an element in a given perfect crystal. We now define and describe new combinatorics of all these materials, which is much simpler and easier to deal with than the one given in [9, 10]. Based on this new combinatorics, the set of all (reduced) Young columns is endowed with a crystal structure. In particular, the description of Kashiwara operators, defined by adding and removing colored blocks, is quite explicit and easy to follow.

Now we go ahead and provide a combinatorial construction of the level- l highest weight crystal $B(\lambda)$. A level- l Young wall is an infinite sequence of level- l Young columns extending to the left satisfying certain conditions given in Section 4. We introduce the notion of δ -slices, *ground-state* walls of weight λ , *reduced* Young walls and define a crystal structure on the set of (reduced) Young walls. As one of our main results, we prove that the crystal consisting of reduced Young walls on λ is isomorphic to the crystal $B(\lambda)$.

Finally, we take $l = 0$ and allow the *negative integers* to *count* the number of slices in the reduced Young columns. Under this expanded concept, we now follow a similar process of defining Young columns and Young walls for higher level case. We introduce the notion of virtual Young columns, extended Young columns, virtual Young walls and extended Young walls. Using the expression of the crystal $B(\infty)$ in [5], we obtain an explicit construction of $B(\infty)$ in terms of virtual Young walls and extended Young walls.

The combinatorial theory of level-1 Young walls has many applications in representation theory. In [2], Brundan and Kleshchev demonstrated that the irreducible representations of the Hecke-Clifford superalgebra $\mathcal{H}_N(\zeta)$ with ζ a primitive $(2n+1)$ -th root of unity are parametrized by the set of reduced Young walls of type $A_{2n}^{(2)}$ with N blocks. In [8], Kang and Kwon constructed a Fock space representation of all quantum affine algebras of classical type using combinatorics of Young walls. In addition, they discovered a generalized version of Lascoux-Leclerc-Thibon algorithm of computing the lower global basis elements corresponding to reduced Young walls. It is an interesting problem to understand the coefficients in the algorithm as in the Lascoux-Leclerc-Thibon-Ariki theory.

The Young wall realization is closely related to the representation theory of Khovanov-Lauda-Rouquier algebras. For instance, in [17], Oh and Park obtained the graded dimension formulas for the cyclotomic quotient of Khovanov-Lauda-Rouquier algebra at Λ_0 of types $A_{2n}^{(2)}$ and $D_{n+1}^{(2)}$ in terms of Young walls. In [1], Benkart, Kang, Oh and Park gave a combinatorial construction of irreducible modules over Khovanov-Lauda-Rouquier algebras of finite classical type. In the forthcoming work, we will give a Young wall construction of finite dimensional irreducible modules over Khovanov-Lauda-Rouquier algebras associated with quantum affine algebras.

As is the case with combinatorics of level-1 Young walls, we expect that this new combinatorics of higher level Young walls will give rise to a lot more interesting developments in the near future.

This paper is organized as follows. In Section 2, we review some of the basic theory of quantum affine algebras, perfect crystals and path realization. In Section 3, we introduce the new notion of blocks, higher level slices and describe their stacking patterns, which yields the definition of higher level (reduced) Young columns. We define the action of Kashiwara operators carefully on the set of (reduced) Young columns and show that the crystal consisting of reduced Young columns is isomorphic to the given perfect crystal. In Section 4, we define the notions of ground-state walls, level- l Young walls and level- l reduced Young walls. We define the Kashiwara operators on level- l Young walls using the tensor product rule. Thus the set of level- l reduced Young walls is endowed with a crystal structure. We prove that the crystal consisting of reduced Young walls is isomorphic to the crystal $B(\lambda)$. We illustrate the top parts of the level-2 highest weight crystals $B(\lambda)$ for types $B_3^{(1)}$, $A_2^{(2)}$, $D_3^{(2)}$ and $C_2^{(1)}$. The final section presents the new Young wall realization of $B(\infty)$ in terms of reduced virtual Young walls and reduced extended Young walls. As an example, we use reduced virtual Young walls to describe the top part of the crystal $B(\infty)$ of type $D_3^{(2)}$.

Acknowledgements.

Z. Fan was partially supported by the NSF of China grant 11671108, the NSF of Heilongjiang Province grant JQ2020A001, and the Fundamental Research Funds for the central universities. S.-J. Kang was supported by the NSF of China grant 11671108. Young Rock Kim was supported by the National Research Foundation of Korea (NRF) grant funded by the Korea government (MSIT) (No. 2021R1A2C1011467) and was supported by Hankuk University of Foreign Studies Research fund.

2. QUANTUM AFFINE ALGEBRAS AND PERFECT CRYSTALS

Let $I = \{0, 1, \dots, n\}$ be a finite index set and let $(A, P, \Pi, P^\vee, \Pi^\vee)$ be an affine Cartan datum consisting of:

- (1) a symmetrizable Cartan matrix $A = (a_{ij})_{i,j \in I}$ of affine type,
- (2) a free abelian group P of rank $n + 2$,
- (3) a \mathbf{Q} -linearly independent set $\Pi = \{\alpha_i \in P \mid i \in I\}$,
- (4) $P^\vee = \text{Hom}_{\mathbf{Z}}(P, \mathbf{Z})$,
- (5) $\Pi^\vee = \{h_i \in P^\vee \mid i \in I\}$

such that $\langle h_i, \alpha_j \rangle = a_{ij}$ ($i, j \in I$).

We can write $P^\vee = \bigoplus_{i=0}^n \mathbf{Z}h_i \oplus \mathbf{Z}d$ satisfying $\alpha_i(d) = \delta_{i,0}$ ($i \in I$). Let $\mathfrak{h} = \mathbf{Q} \otimes_{\mathbf{Z}} P^\vee$. The *fundamental weights* $\Lambda_i \in \mathfrak{h}^*$ ($i \in I$) are given by

$$\Lambda_i(h_j) = \delta_{ij}, \quad \Lambda_i(d) = 0 \quad \text{for } i, j \in I.$$

There is a non-degenerate symmetric bilinear form $(\ , \)$ on \mathfrak{h}^* such that

$$\langle h_i, \lambda \rangle = \frac{2(\alpha_i, \lambda)}{(\alpha_i, \alpha_i)} \quad \text{for } \lambda \in P, i \in I.$$

Let q be an indeterminate and let

$$q_i = q^{(\alpha_i, \alpha_i)/2}, \quad [n]_i = \frac{q_i^n - q_i^{-n}}{q_i - q_i^{-1}}.$$

Definition 2.1. *The quantum affine algebra $U_q(\mathfrak{g})$ associated with $(A, P, \Pi, P^\vee, \Pi^\vee)$ is the $\mathbf{Q}(q)$ -algebra with 1 generated by e_i, f_i ($i \in I$), q^h ($h \in P^\vee$) subject to the defining relations*

$$\begin{aligned} q^0 &= 1, \quad q^h q^{h'} = q^{h+h'} \quad (h, h' \in P^\vee), \\ q^h e_j q^{-h} &= q^{\langle h, \alpha_j \rangle} e_j, \\ q^h f_j q^{-h} &= q^{-\langle h, \alpha_j \rangle} f_j \quad (h \in P^\vee, j \in I), \\ e_i f_j - f_j e_i &= \delta_{ij} \frac{K_i - K_i^{-1}}{q_i - q_i^{-1}}, \\ \sum_{k=0}^{1-a_{ij}} (-1)^k e_i^{(1-a_{ij}-k)} e_j e_i^{(k)} &= 0 \quad (i \neq j), \\ \sum_{k=0}^{1-a_{ij}} (-1)^k f_i^{(1-a_{ij}-k)} f_j f_i^{(k)} &= 0 \quad (i \neq j), \end{aligned}$$

where $K_i = q^{\frac{(\alpha_i, \alpha_i)}{2} h_i}$, $e_i^{(k)} = e_i^k / [k]_i!$ and $f_i^{(k)} = f_i^k / [k]_i!$.

The subalgebra $U'_q(\mathfrak{g})$ generated by $e_i, f_i, K_i^{\pm 1}$ ($i \in I$) is also called the *quantum affine algebra*.

Let $c = c_0 h_0 + \dots + c_n h_n$ be the *canonical central element* and let $\delta = d_0 \alpha_0 + \dots + d_n \alpha_n$ be the *null root*. Here the coefficients c_i and d_i ($i \in I$) are non-negative integers given in [3, Section 6.2]. Then we have

$$P = \bigoplus_{i \in I} \mathbf{Z} \Lambda_i \oplus \mathbf{Z} \left(\frac{1}{d_0} \delta \right).$$

Let $\text{cl} : P \rightarrow P/\mathbf{Z}(\frac{1}{d_0}\delta)$ be the canonical projection and let

$$P_{\text{cl}} := \text{cl}(P) = \bigoplus_{i \in I} \mathbf{Z}\text{cl}(\Lambda_i).$$

We define

$$P^+ := \{\lambda \in P \mid \langle h_i, \lambda \rangle \geq 0 \text{ for all } i \in I\}$$

and set $P_{\text{cl}}^+ := \text{cl}(P^+)$, the set of *dominant integral weights*. The integer $\langle c, \lambda \rangle$ is called the *level* of $\lambda \in P$.

The difference between $U_q(\mathfrak{g})$ and $U'_q(\mathfrak{g})$ are as follows. The non-trivial integrable irreducible $U_q(\mathfrak{g})$ -modules should be the highest weight modules $V(\lambda)$ with dominant integral weights. They are of infinite dimension but the weight spaces have finite dimension. On the other hand, $U'_q(\mathfrak{g})$ may have finite dimensional irreducible modules but the weight spaces of $V(\lambda)$ should be of infinite dimension.

In the following figures, we list the Dynkin diagrams, the canonical central elements and the null roots for affine Cartan data of types $A_{2n}^{(2)}$, $D_{n+1}^{(2)}$, $A_{2n-1}^{(2)}$, $D_n^{(1)}$, $B_n^{(1)}$ and $C_n^{(1)}$:

(1) $A_{2n}^{(2)}$ ($n \geq 2$)

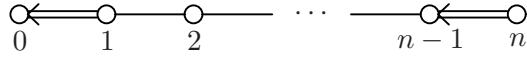

$$c = h_0 + 2h_1 + \cdots + 2h_{n-1} + 2h_n,$$

$$\delta = 2\alpha_0 + 2\alpha_1 + \cdots + 2\alpha_{n-1} + \alpha_n.$$

(2) $D_{n+1}^{(2)}$ ($n \geq 2$)

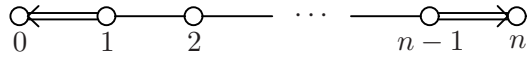

$$c = h_0 + 2h_1 + \cdots + 2h_{n-1} + h_n,$$

$$\delta = \alpha_0 + \alpha_1 + \cdots + \alpha_{n-1} + \alpha_n.$$

(3) $A_{2n-1}^{(2)}$ ($n \geq 3$)



$$c = h_0 + h_1 + 2h_2 + \cdots + 2h_{n-1} + 2h_n,$$

$$\delta = \alpha_0 + \alpha_1 + 2\alpha_2 + \cdots + 2\alpha_{n-1} + \alpha_n.$$

(4) $D_n^{(1)}$ ($n \geq 4$)

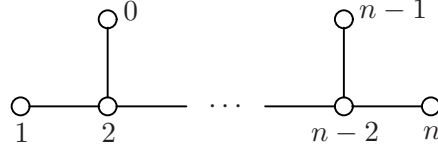

$$c = h_0 + h_1 + 2h_2 + \cdots + 2h_{n-2} + h_{n-1} + h_n,$$

$$\delta = \alpha_0 + \alpha_1 + 2\alpha_2 + \cdots + 2\alpha_{n-2} + \alpha_{n-1} + \alpha_n.$$

(5) $B_n^{(1)}$ ($n \geq 3$)

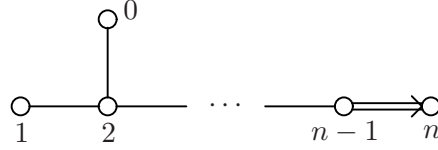

$$c = h_0 + h_1 + 2h_2 + \cdots + 2h_{n-1} + h_n,$$

$$\delta = \alpha_0 + \alpha_1 + 2\alpha_2 + \cdots + 2\alpha_{n-1} + 2\alpha_n.$$

(6) $C_n^{(1)}$ ($n \geq 2$)

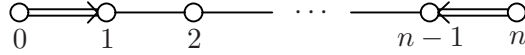

$$c = h_0 + h_1 + \cdots + h_{n-1} + h_n,$$

$$\delta = \alpha_0 + 2\alpha_1 + \cdots + 2\alpha_{n-1} + \alpha_n.$$

Definition 2.2. A $U_q(\mathfrak{g})$ -crystal (resp. a $U'_q(\mathfrak{g})$ -crystal) is a set B together with the maps $\tilde{e}_i, \tilde{f}_i : B \rightarrow B \cup \{0\}$, $\varepsilon_i, \varphi_i : B \rightarrow \mathbf{Z} \cup \{-\infty\}$, $\text{wt} : B \rightarrow P$ (resp. $\overline{\text{wt}} : B \rightarrow P_{cl}$) satisfying the following conditions:

- (1) for each $i \in I$, we have $\varphi_i(b) = \varepsilon_i(b) + \langle h_i, \text{wt}(b) \rangle$ (resp. $\varphi_i(b) = \varepsilon_i(b) + \langle h_i, \overline{\text{wt}}(b) \rangle$),
- (2) $\text{wt}(\tilde{e}_i b) = \text{wt}(b) + \alpha_i$ (resp. $\overline{\text{wt}}(\tilde{e}_i b) = \overline{\text{wt}}(b) + \alpha_i$) if $\tilde{e}_i b \in B$,
- (3) $\text{wt}(\tilde{f}_i b) = \text{wt}(b) - \alpha_i$ (resp. $\overline{\text{wt}}(\tilde{f}_i b) = \overline{\text{wt}}(b) - \alpha_i$) if $\tilde{f}_i b \in B$,
- (4) $\varepsilon_i(\tilde{e}_i b) = \varepsilon_i(b) - 1$, $\varphi_i(\tilde{e}_i b) = \varphi_i(b) + 1$ if $\tilde{e}_i b \in B$,
- (5) $\varepsilon_i(\tilde{f}_i b) = \varepsilon_i(b) + 1$, $\varphi_i(\tilde{f}_i b) = \varphi_i(b) - 1$ if $\tilde{f}_i b \in B$,
- (6) $\tilde{f}_i b = b'$ if and only if $b = \tilde{e}_i b'$ for all $b, b' \in B$, $i \in I$,
- (7) if $\varphi_i(b) = -\infty$, then $\tilde{e}_i b = \tilde{f}_i b = 0$.

Let B be a $U'_q(\mathfrak{g})$ -crystal. For an element $b \in B$, we define

$$\varepsilon(b) = \sum_{i \in I} \varepsilon_i(b) \text{cl}(\Lambda_i), \quad \varphi(b) = \sum_{i \in I} \varphi_i(b) \text{cl}(\Lambda_i).$$

For simplicity, we often write Λ_i for $\text{cl}(\Lambda_i)$ ($i \in I$) and $\text{wt}(b)$ for $\overline{\text{wt}}(b)$ if there is no danger of confusion.

Let B_1, B_2 be $U_q(\mathfrak{g})$ -crystals (or $U'_q(\mathfrak{g})$ -crystals). The tensor product $B_1 \otimes B_2 = B_1 \times B_2$ is defined by

$$\begin{aligned}
(2.1) \quad & \text{wt}(b_1 \otimes b_2) = \text{wt}(b_1) + \text{wt}(b_2) \quad (\text{resp. } \overline{\text{wt}}(b_1 \otimes b_2) = \overline{\text{wt}}(b_1) + \overline{\text{wt}}(b_2)), \\
& \varepsilon_i(b_1 \otimes b_2) = \max(\varepsilon_i(b_1), \varepsilon_i(b_2) - \langle h_i, \text{wt}(b_1) \rangle), \\
& \varphi_i(b_1 \otimes b_2) = \max(\varphi_i(b_2), \varphi_i(b_1) + \langle h_i, \text{wt}(b_2) \rangle), \\
& \tilde{\varepsilon}_i(b_1 \otimes b_2) = \begin{cases} \tilde{\varepsilon}_i b_1 \otimes b_2 & \text{if } \varphi_i(b_1) \geq \varepsilon_i(b_2), \\ b_1 \otimes \tilde{\varepsilon}_i b_2 & \text{if } \varphi_i(b_1) < \varepsilon_i(b_2), \end{cases} \\
& \tilde{f}_i(b_1 \otimes b_2) = \begin{cases} \tilde{f}_i b_1 \otimes b_2 & \text{if } \varphi_i(b_1) > \varepsilon_i(b_2), \\ b_1 \otimes \tilde{f}_i b_2 & \text{if } \varphi_i(b_1) \leq \varepsilon_i(b_2). \end{cases}
\end{aligned}$$

Definition 2.3. Let l be a positive integer. A finite $U'_q(\mathfrak{g})$ -crystal B is called a *perfect crystal of level l* if B satisfies the following conditions:

- (1) there exists a finite dimensional $U'_q(\mathfrak{g})$ -module with crystal B ,
- (2) $B \otimes B$ is connected,
- (3) there is $\lambda \in P_{cl}$ such that $\text{wt}(B) \subset \lambda - \sum_{i \neq 0} \mathbf{Z}_{\geq 0} \alpha_i$, $\#(B_\lambda) = 1$,
- (4) for any $b \in B$, we have $\langle c, \varepsilon_i(b) \rangle \geq l$,
- (5) for each $\lambda \in P_{cl}^+$ with $\langle c, \lambda \rangle = l$, there exist uniquely determined elements b^λ and b_λ such that $\varepsilon(b^\lambda) = \varphi(b_\lambda) = \lambda$.

The elements b^λ and b_λ are called the *minimal vectors*.

Let $V(\lambda)$ be the irreducible highest weight $U'_q(\mathfrak{g})$ -module with a dominant integral weight $\lambda \in P_{cl}^+$ and let $B(\lambda)$ be the crystal of $V(\lambda)$. Then by [6, 7], we have a $U'_q(\mathfrak{g})$ -crystal isomorphism

$$(2.2) \quad \begin{array}{ccc} \Psi_\lambda : B(\lambda) & \xrightarrow{\sim} & B(\varepsilon(b_\lambda)) \otimes B \\ u_\lambda & \mapsto & u_{\varepsilon(b_\lambda)} \otimes b_\lambda, \end{array}$$

where u_λ denotes the highest weight vector of $B(\lambda)$. Applying the isomorphism (2.2) repeatedly, we obtain a sequence of $U_q(\mathfrak{g})$ -crystal isomorphisms

$$\begin{array}{ccccccc} B(\lambda) & \xrightarrow{\sim} & B(\lambda_1) \otimes B & \xrightarrow{\sim} & B(\lambda_2) \otimes B \otimes B & \xrightarrow{\sim} & \dots \\ u_\lambda & \mapsto & u_{\lambda_1} \otimes b_0 & \mapsto & u_{\lambda_2} \otimes b_1 \otimes b_0 & \mapsto & \dots, \end{array}$$

where

$$\begin{aligned} \lambda_0 &= \lambda, & b_0 &= b_{\lambda_0} = b_\lambda, \\ \lambda_{k+1} &= \varepsilon(b_k), & b_{k+1} &= b_{\lambda_{k+1}} \quad \text{for } k \geq 0. \end{aligned}$$

Definition 2.4. The infinite sequence $\mathbf{b}_\lambda = (b_k)_{k \geq 0} = \dots \otimes b_k \otimes \dots \otimes b_1 \otimes b_0 \in B^{\otimes \infty}$ is called the *ground-state path of weight λ* . The infinite sequence $\mathbf{p} = (p_k)_{k \geq 0} \in B^{\otimes \infty}$ is called a *λ -path* if $p_k = b_k$ for $k \gg 0$.

Let $\mathcal{P}(\lambda)$ denote the set of all λ -paths. By the tensor product rule (2.1), $\mathcal{P}(\lambda)$ has a $U'_q(\mathfrak{g})$ -crystal structure. It is proved in [6, 7] that $\mathcal{P}(\lambda)$ provides a path realization of $B(\lambda)$ as a $U'_q(\mathfrak{g})$ -crystal.

Proposition 2.5 ([6, 7]). For each $\lambda \in P_{cl}^+$, there exists a $U'_q(\mathfrak{g})$ -crystal isomorphism

$$\Phi_\lambda : B(\lambda) \longrightarrow \mathcal{P}(\lambda) \quad \text{given by } u_\lambda \mapsto \mathbf{b}_\lambda.$$

For the quantum affine algebras of types $A_{2n}^{(2)}$, $D_{n+1}^{(2)}$, $A_{2n-1}^{(2)}$, $D_n^{(1)}$, $B_n^{(1)}$ and $C_n^{(1)}$, it was shown in [5, 7] that there exists a *coherent family of perfect crystals* $\{\mathcal{B}^{(l)} \mid l \in \mathbf{Z}_{>0}\}$. We give an explicit description of these perfect crystals as follows:

- (1) $A_{2n}^{(2)}$ ($n \geq 1$)
 $\mathcal{B}^{(l)} = \left\{ (x_1, \dots, x_n | \bar{x}_n, \dots, \bar{x}_1) \mid x_i, \bar{x}_i \in \mathbf{Z}_{\geq 0}, \sum_{i=1}^n (x_i + \bar{x}_i) \leq l \right\},$
- (2) $D_{n+1}^{(2)}$ ($n \geq 2$)
 $\mathcal{B}^{(l)} = \left\{ (x_1, \dots, x_n | x_0 | \bar{x}_n, \dots, \bar{x}_1) \mid \begin{array}{l} x_0 = 0 \text{ or } 1, x_i, \bar{x}_i \in \mathbf{Z}_{\geq 0}, \\ x_0 + \sum_{i=1}^n (x_i + \bar{x}_i) \leq l \end{array} \right\},$
- (3) $C_n^{(1)}$ ($n \geq 2$)
 $\mathcal{B}^{(l)} = \left\{ (x_1, \dots, x_n | \bar{x}_n, \dots, \bar{x}_1) \mid x_i, \bar{x}_i \in \mathbf{Z}_{\geq 0}, 2l \geq \sum_{i=1}^n (x_i + \bar{x}_i) \in 2\mathbf{Z} \right\},$
- (4) $A_{2n-1}^{(2)}$ ($n \geq 3$)
 $\mathcal{B}^{(l)} = \left\{ (x_1, \dots, x_n | \bar{x}_n, \dots, \bar{x}_1) \mid x_i, \bar{x}_i \in \mathbf{Z}_{\geq 0}, \sum_{i=1}^n (x_i + \bar{x}_i) = l \right\},$
- (5) $D_n^{(1)}$ ($n \geq 4$)
 $\mathcal{B}^{(l)} = \left\{ (x_1, \dots, x_n | \bar{x}_n, \dots, \bar{x}_1) \mid \begin{array}{l} x_n = 0 \text{ or } \bar{x}_n = 0, x_i, \bar{x}_i \in \mathbf{Z}_{\geq 0}, \\ \sum_{i=1}^n (x_i + \bar{x}_i) = l \end{array} \right\},$
- (6) $B_n^{(1)}$ ($n \geq 3$)
 $\mathcal{B}^{(l)} = \left\{ (x_1, \dots, x_n | x_0 | \bar{x}_n, \dots, \bar{x}_1) \mid \begin{array}{l} x_0 = 0 \text{ or } 1, x_i, \bar{x}_i \in \mathbf{Z}_{\geq 0}, \\ x_0 + \sum_{i=1}^n (x_i + \bar{x}_i) = l \end{array} \right\}.$

For the convenience of readers, we give an explicit description of the maps wt , \tilde{e}_i , \tilde{f}_i , ε_i and φ_i ($i \in I$) for the perfect crystal $\mathcal{B}^{(l)}$ of type $B_n^{(1)}$. Let $b = (x_1, \dots, x_n | x_0 | \bar{x}_n, \dots, \bar{x}_1) \in \mathcal{B}^{(l)}$ such that $x_0 = 0$ or 1 , $x_i, \bar{x}_i \in \mathbf{Z}_{\geq 0}$, and $x_0 + \sum_{i=1}^n (x_i + \bar{x}_i) = l$.

For $i = 0$ and $i = n$, the Kashiwara operators \tilde{f}_i are given by

$$(2.3) \quad \begin{aligned} \tilde{f}_0 b &= \begin{cases} (x_1, x_2 + 1, x_3, \dots, x_n | x_0 | \bar{x}_n, \dots, \bar{x}_2, \bar{x}_1 - 1) & \text{if } x_2 \geq \bar{x}_2, \\ (x_1 + 1, x_2, \dots, x_n | x_0 | \bar{x}_n, \dots, \bar{x}_3, \bar{x}_2 - 1, \bar{x}_1) & \text{if } x_2 < \bar{x}_2, \end{cases} \\ \tilde{f}_n b &= \begin{cases} (x_1, \dots, x_{n-1}, x_n - 1 | x_0 + 1 | \bar{x}_n, \dots, \bar{x}_1) & \text{if } x_0 = 0, \\ (x_1, \dots, x_n | x_0 - 1 | \bar{x}_n + 1, \bar{x}_{n-1}, \dots, \bar{x}_1) & \text{if } x_0 = 1. \end{cases} \end{aligned}$$

For $i = 1, \dots, n-1$, the Kashiwara operators \tilde{f}_i are given by

$$(2.4) \quad \tilde{f}_i b = \begin{cases} (x_1, \dots, x_i - 1, x_{i+1} + 1, \dots, x_n | x_0 | \bar{x}_n, \dots, \bar{x}_1) & \text{if } x_{i+1} \geq \bar{x}_{i+1}, \\ (x_1, \dots, x_n | x_0 | \bar{x}_n, \dots, \bar{x}_{i+1} - 1, \bar{x}_i + 1, \dots, \bar{x}_1) & \text{if } x_{i+1} < \bar{x}_{i+1}. \end{cases}$$

The action of Kashiwara operators \tilde{e}_i is given by $\tilde{e}_i b = b'$ if and only if $\tilde{f}_i b' = b$. The maps ε_i , φ_i and wt are given by

$$\begin{aligned} \varepsilon_0(b) &= x_1 + (x_2 - \bar{x}_2)_+, \quad \varepsilon_n(b) = 2\bar{x}_n + x_0, \\ \varphi_0(b) &= \bar{x}_1 + (\bar{x}_2 - x_2)_+, \quad \varphi_n(b) = 2x_n + x_0, \\ \varepsilon_i(b) &= \bar{x}_i + (x_{i+1} - \bar{x}_{i+1})_+ \quad (i = 1, \dots, n-1), \\ \varphi_i(b) &= x_i + (\bar{x}_{i+1} - x_{i+1})_+ \quad (i = 1, \dots, n-1), \\ wt(b) &= \sum_{i=0}^n (\varphi_i(b) - \varepsilon_i(b)) \Lambda_i, \end{aligned}$$

where $(a)_+ = \max(0, a)$ for $a \in \mathbf{Z}$.

For other types, we can find precise definitions of maps $\tilde{e}_i, \tilde{f}_i, \varepsilon_i, \varphi_i$ and wt in [5, 13].

3. HIGHER LEVEL YOUNG COLUMNS

In this section, we define the level- l Young columns and level- l reduced Young columns. We also define the crystal structure on the set $\mathcal{C}^{(l)}$ of level- l reduced Young columns. Then we will prove that $\mathcal{C}^{(l)}$ has the same crystal structure as $\mathcal{B}^{(l)}$.

3.1. Level- l stacking patterns and Young columns.

The colored blocks we will work with are one of the following sizes which are obtained by splitting the unit cube: (we use width \times depth \times height)

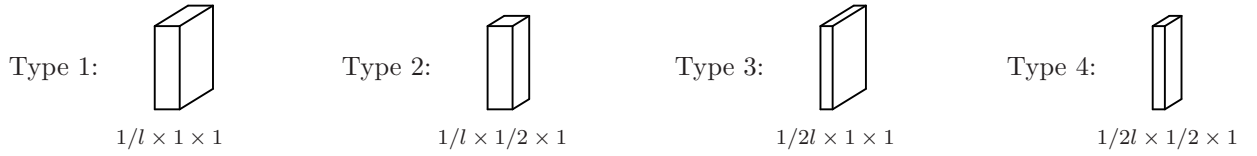

Here, l stands for the level.

For each affine Cartan datum, we use different coloring and shapes of blocks given below.

(1) $A_{2n}^{(2)}$ ($1 \leq i \leq n$)

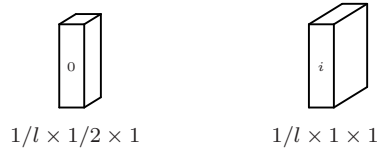

(2) $D_{n+1}^{(2)}$ ($1 \leq i \leq n-1$)

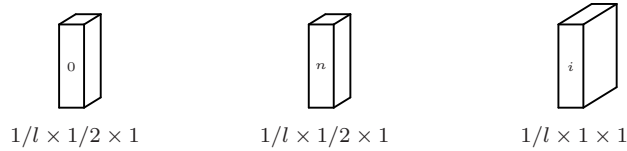

(3) $A_{2n-1}^{(2)}$ ($2 \leq i \leq n$)

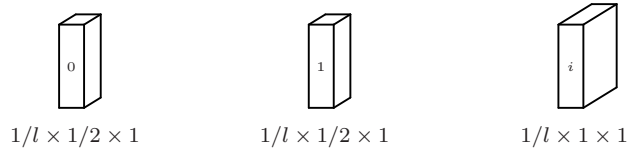

(4) $D_n^{(1)}$ ($2 \leq i \leq n-2$)

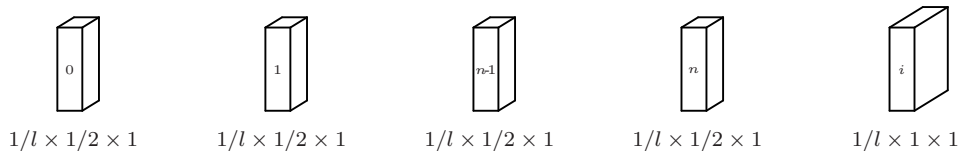

(5) $B_n^{(1)}$ ($2 \leq i \leq n-1$)

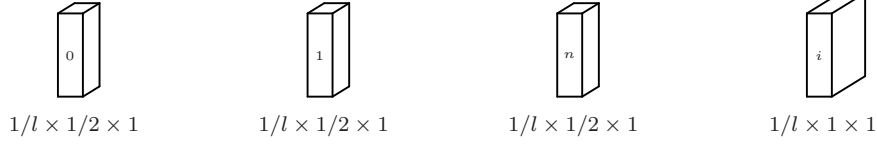

(6) $C_n^{(1)}$ ($1 \leq i \leq n$)

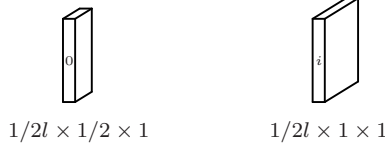

For simplicity, we use a planar representation of our blocks. The triangle on the upper-left corner represents the block in the front, and the triangle on the lower-right corner represents the block at the back.

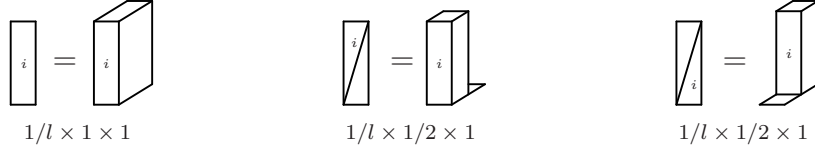

We will now explain how we stack a block on another block:

We can place a set A of blocks on top of another set B of blocks if

- The width of B is $\frac{i}{l}$ ($1 \leq i \leq l$), the depth of B is 1 or $\frac{1}{2}$.
- The width and depth of A is less than or equal to the width and depth of B .

Example 3.1. We consider the case of $l = 2$.

(a) The ways of placing blocks below are allowed.

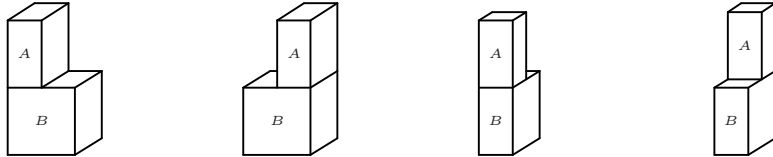

(b) The ways of placing blocks below are not allowed.

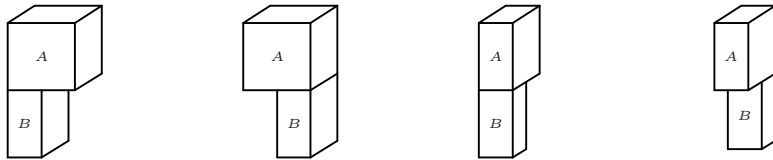

Definition 3.2. A level- l slice is defined to be a set of finitely many blocks stacked in a column of unit depth and $\frac{1}{l}$ or $\frac{1}{2l}$ width.

In the following text, a level- l slice is referred to as a slice for short.

Definition 3.3. For each type of affine Cartan datum, a level- l Young Column is defined to be a set of finitely many blocks in a column of unit width and unit depth stacked following the patterns given in the Picture **Stacking Patterns** such that the number of blocks in the slice is weakly decreasing from right to left.

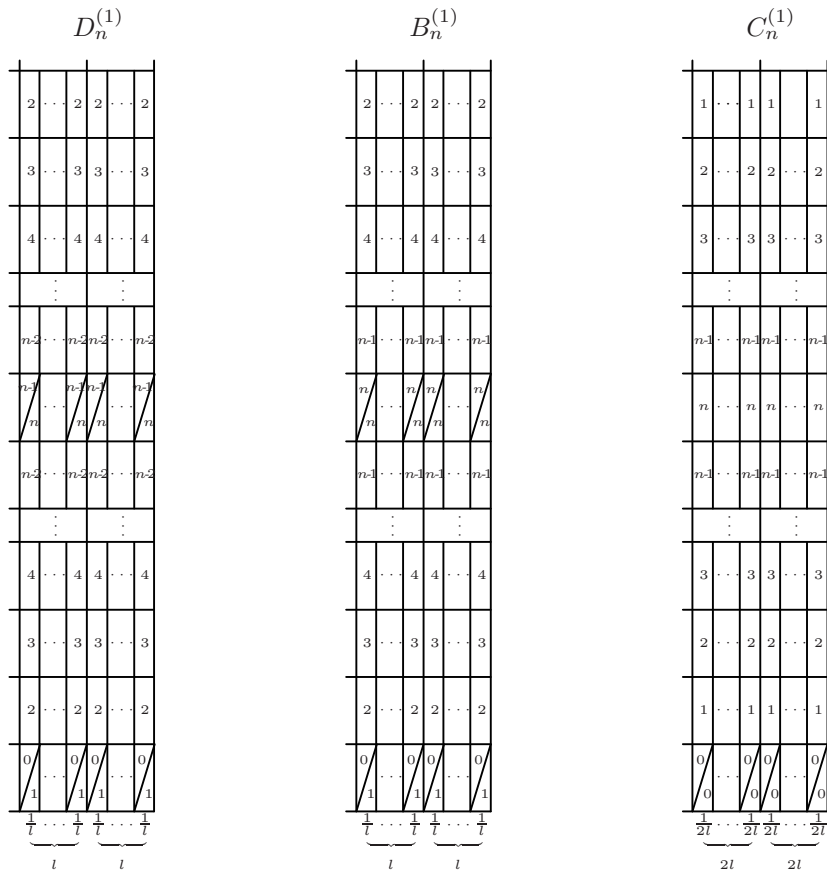
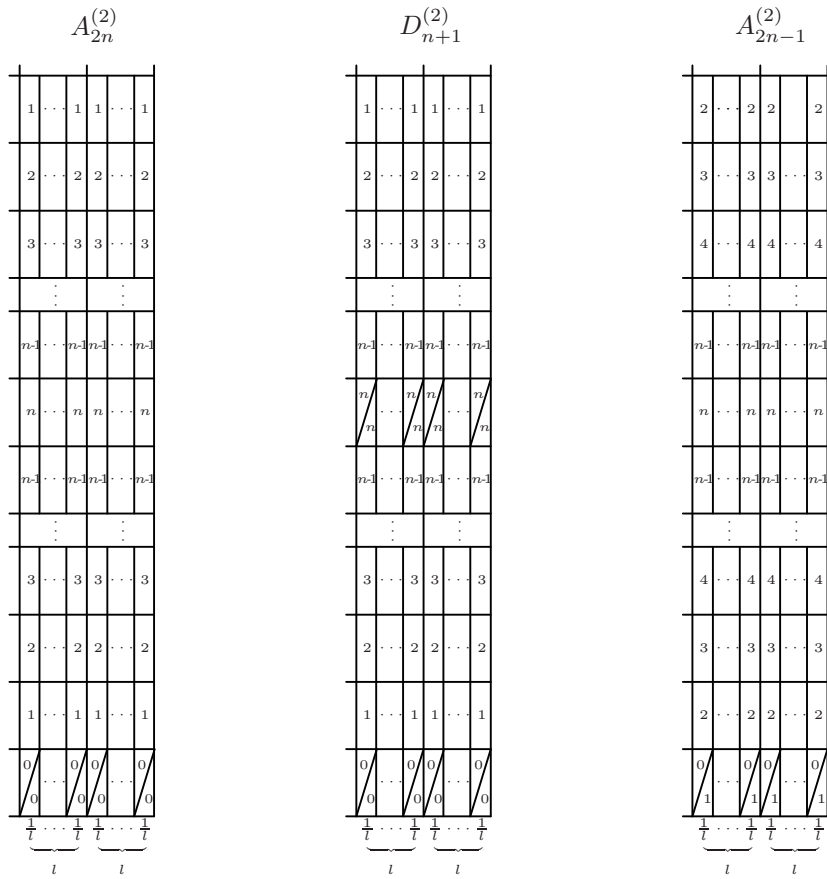

Stacking Patterns

Definition 3.4. For each stacking pattern, the first complete cycle of a slice with $\frac{1}{l}$ -width (or $\frac{1}{2l}$ -width in $C_n^{(1)}$ -case) from the bottom of a pattern is called a level- l δ -slice.

The stacking patterns in Definition 3.3 consist of repeated δ -slices extending to upward and left infinitely. In the following text, a level- l δ -slice is referred to as a δ -slice for short. For simplicity, we could present a δ -slice as a sequence of colors corresponding to it. For example:

$$A_{2n}^{(2)} : (0, 0, 1, 2, \dots, n-1, n, n-1, \dots, 2, 1),$$

$$D_{n+1}^{(2)} : (0, 0, 1, 2, \dots, n-1, n, n, n-1, \dots, 2, 1),$$

$$A_{2n-1}^{(2)} : (0, 1, 2, \dots, n-1, n, n-1, \dots, 2),$$

$$D_n^{(1)} : (0, 1, 2, \dots, n-2, n-1, n, n-2, \dots, 2),$$

$$B_n^{(1)} : (0, 1, 2, \dots, n-1, n, n, n-1, \dots, 2),$$

$$C_n^{(1)} : (0, 1, 2, \dots, n-1, n, n-1, \dots, 2, 1).$$

Example 3.5. We list the stacking patterns of types $A_4^{(2)}$, $A_5^{(2)}$, $B_3^{(1)}$ for level-2 cases.

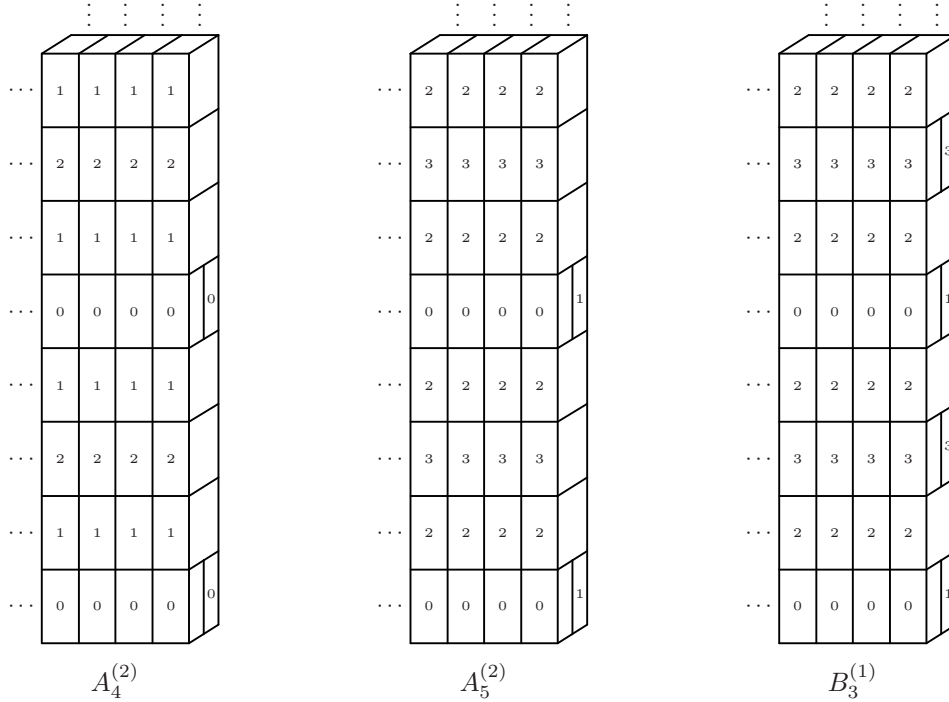

Example 3.6. A level-15 Young column of type $B_4^{(1)}$ is given below.

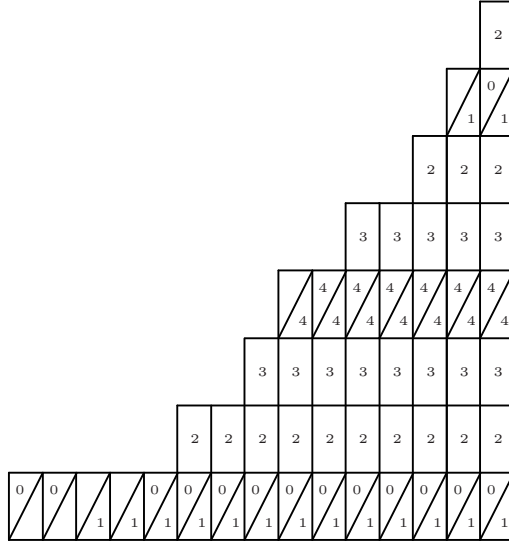

3.2. Level- l reduced Young columns.

A δ -slice in a level- l Young column is called *removable* if there is at least one block on the top of the δ -slice. A level- l Young column is called *reduced* if there is no removable δ -slice. We list the level- l reduced Young columns corresponding to the vectors in the perfect crystals as follows:

We denote the number of slices by x_i, \bar{x}_i and l' in the following statements.

- (1) $A_{2n}^{(2)}$ case : Level- l reduced Young column $C_{(x_1, \dots, x_n, \bar{x}_n, \dots, \bar{x}_1)}$, where $\sum_{i=1}^n (x_i + \bar{x}_i) \leq l$, $x_i, \bar{x}_i \geq 0$ and $l' = l - \sum_{i=1}^n (x_i + \bar{x}_i)$.

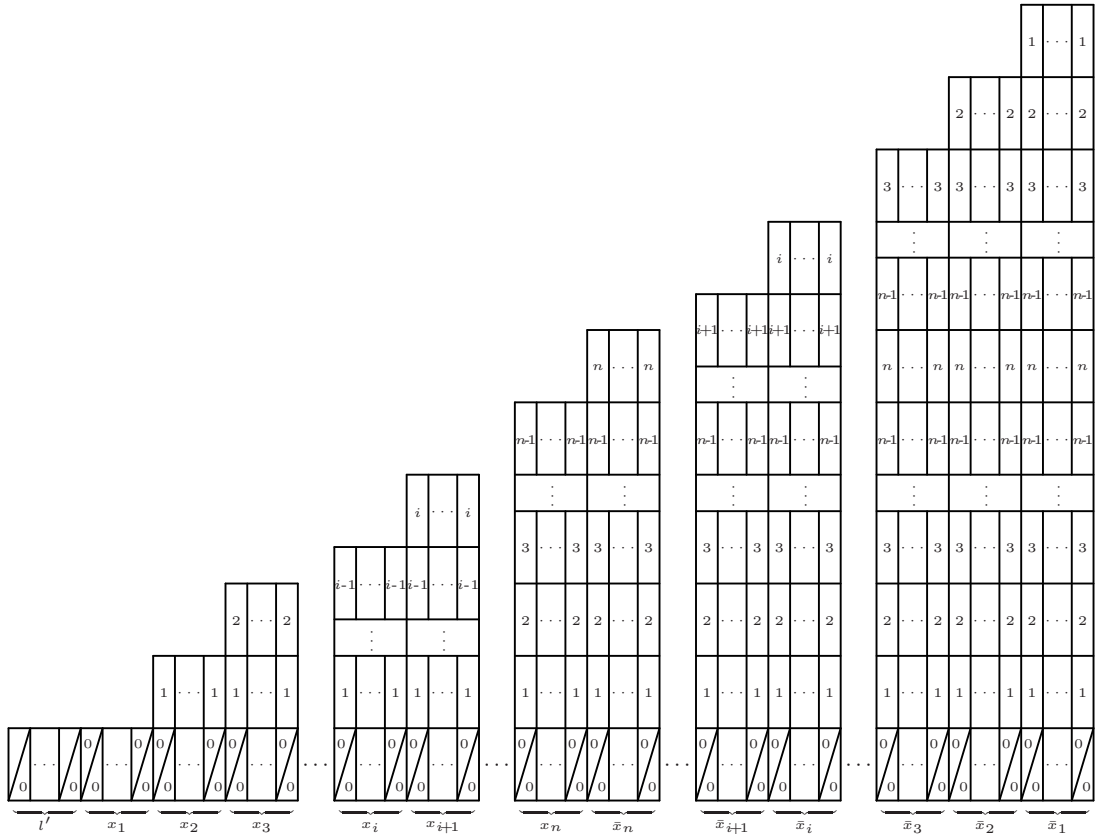

- (2) $D_{n+1}^{(2)}$ case : Level- l reduced Young column $C_{(x_1, \dots, x_n, x_0, \bar{x}_n, \dots, \bar{x}_1)}$, where $x_0 + \sum_{i=1}^n (x_i + \bar{x}_i) \leq l$, $x_0 = 0$ or 1 , $x_i, \bar{x}_i \geq 0$ and $l' = l - \sum_{i=1}^n (x_i + \bar{x}_i) - x_0$.

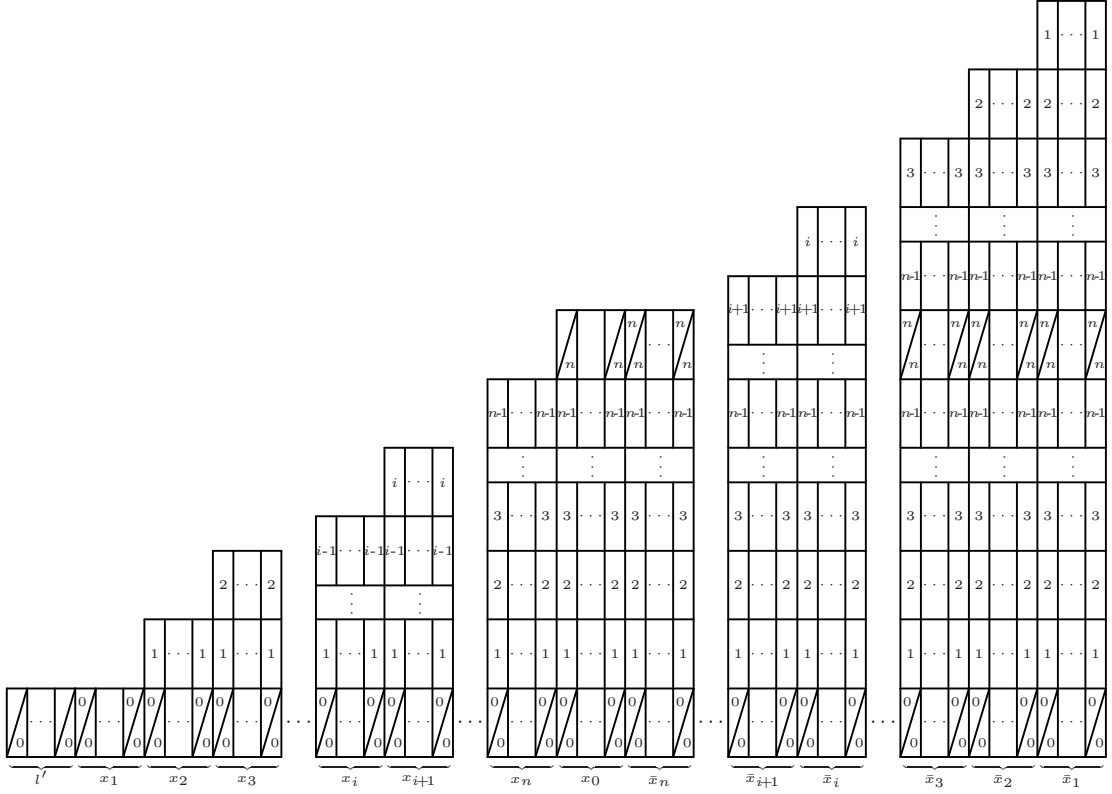

- (3) $A_{2n-1}^{(2)}$ case : Level- l reduced Young column $C_{(x_1, \dots, x_n, \bar{x}_n, \dots, \bar{x}_1)}$, where $\sum_{i=1}^n (x_i + \bar{x}_i) = l$ and $x_i, \bar{x}_i \geq 0$.

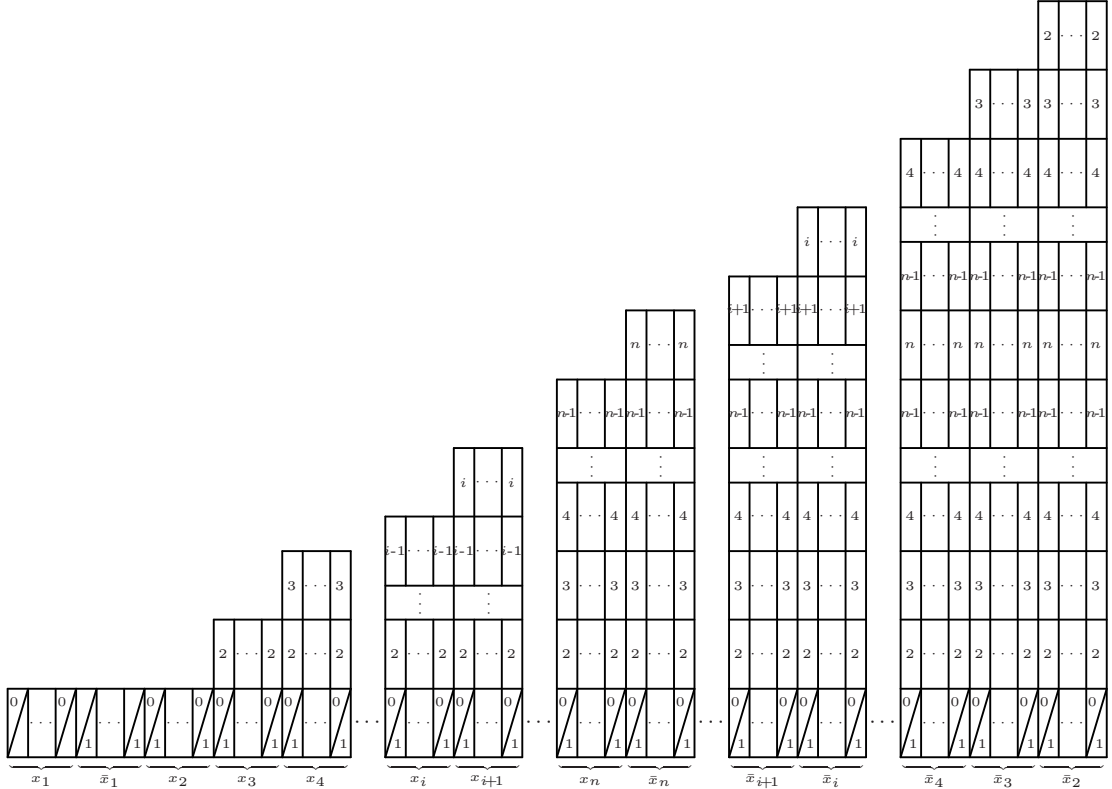

- (4) $D_n^{(1)}$ case : Level- l reduced Young column $C_{(x_1, \dots, x_n, \bar{x}_n, \dots, \bar{x}_1)}$, where $x_n = 0$ or $\bar{x}_n = 0$, $x_i, \bar{x}_i \geq 0$ and $\sum_{i=1}^n (x_i + \bar{x}_i) = l$.

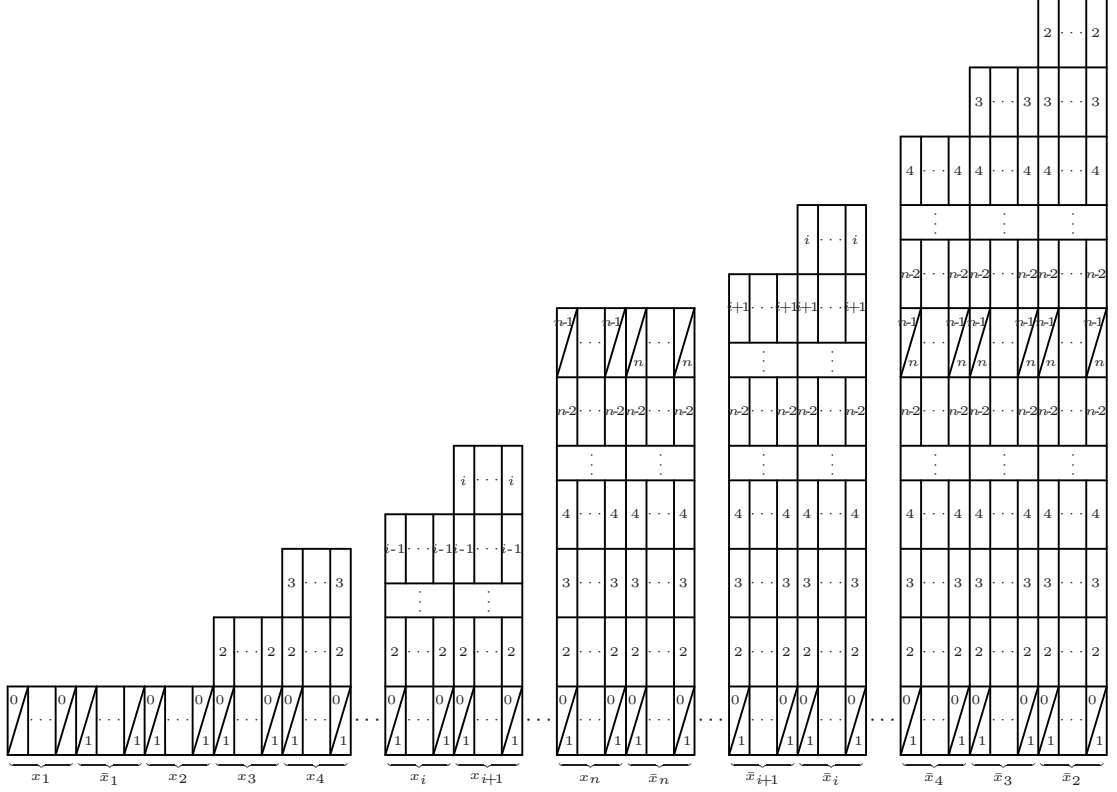

- (5) $B_n^{(1)}$ case : Level- l reduced Young column $C_{(x_1, \dots, x_n, x_0, \bar{x}_n, \dots, \bar{x}_1)}$, where $x_0 = 0$ or 1 , $x_i, \bar{x}_i \geq 0$ and $x_0 + \sum_{i=1}^n (x_i + \bar{x}_i) = l$.

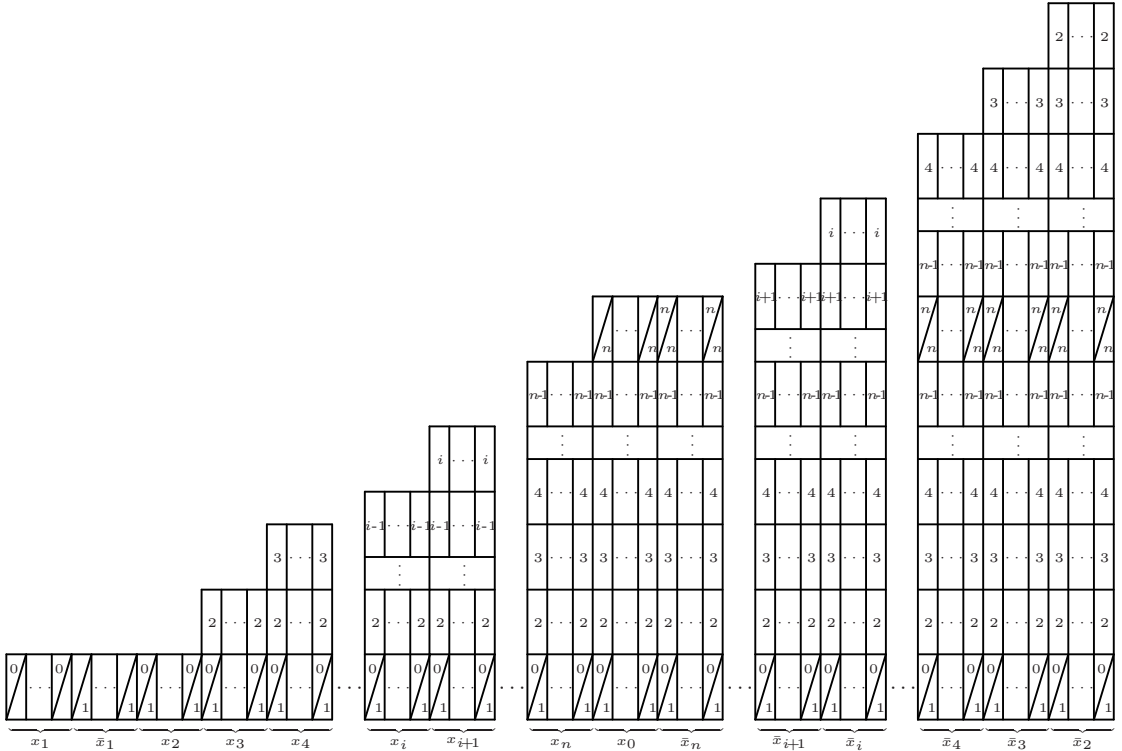

- (6) $C_n^{(1)}$ case : Level- l reduced Young column $C_{(x_1, \dots, x_n, \bar{x}_n, \dots, \bar{x}_1)}$, where $2l \geq \sum_{i=1}^n (x_i + \bar{x}_i) \in 2\mathbf{Z}$, $x_i, \bar{x}_i \geq 0$ and $l' = 2l - \sum_{i=1}^n (x_i + \bar{x}_i)$.

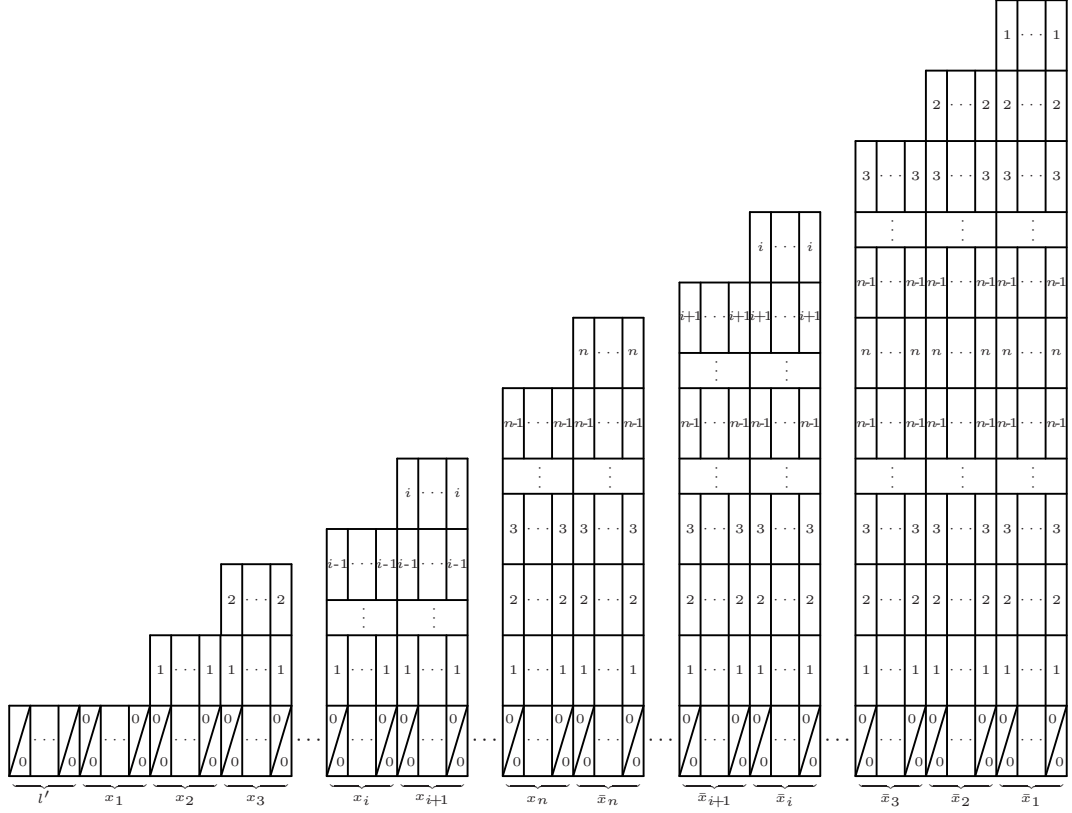

For convenience, we denote

$$* = \begin{cases} 0 & \text{for types } A_{2n}^{(2)}, D_{n+1}^{(2)} \text{ and } C_n^{(1)}, \\ 1 & \text{for types } A_{2n-1}^{(2)}, D_n^{(1)} \text{ and } B_n^{(1)}. \end{cases}$$

The level- l reduced Young columns defined above should satisfy the following conditions:

- For types $A_{2n}^{(2)}$ ($1 \leq i \leq n$), $D_{n+1}^{(2)}$ ($1 \leq i \leq n-1$), $A_{2n-1}^{(2)}$ ($3 \leq i \leq n$), $D_n^{(1)}$ ($3 \leq i \leq n-2$), $B_n^{(1)}$ ($3 \leq i \leq n-1$) and $C_n^{(1)}$ ($1 \leq i \leq n$), we choose a part of level- l reduced Young columns 3.2(1)-3.2(6) as in Picture (i). We could not add $(i-1)$ -block or remove $(i-1)$ -block on this part if $x_i = \bar{x}_i$.
- For types $A_{2n-1}^{(2)}$, $D_n^{(1)}$ and $B_n^{(1)}$, we choose a part of level- l reduced Young columns 3.2(3)-3.2(5) as in Picture (ii). We could not add 0-block or remove 0-block, and also not add 1-block or remove 1-block on this part if $x_2 = \bar{x}_2$.
- For types $D_{n+1}^{(2)}$ and $B_n^{(1)}$, we choose a part of level- l reduced Young columns 3.2(2) and 3.2(5) as in Picture (iii). We could not add $(n-1)$ -block or remove $(n-1)$ -block on this part if $x_n = \bar{x}_n$.

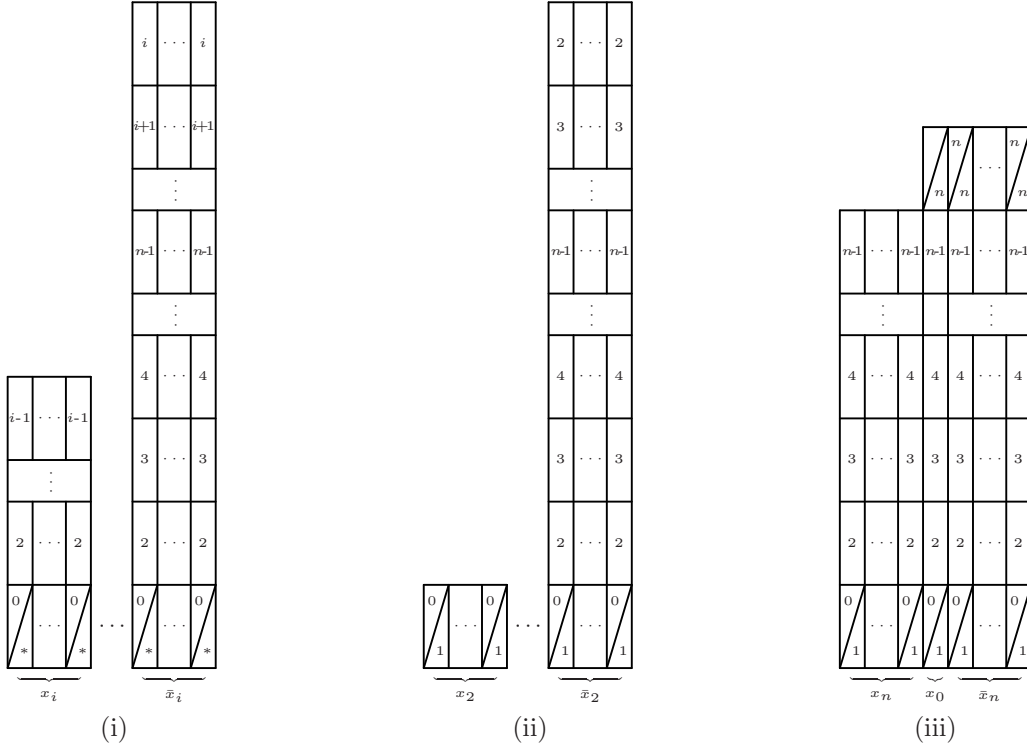

We need to make some special rules for the Young columns of type $C_n^{(1)}$. When we count the number of 0-blocks which can be added or removed, we should treat two 0-blocks of shape $\frac{1}{2l} \times \frac{1}{2} \times 1$ as a whole block.

Example 3.7. A level-15 reduced Young column of type $B_4^{(1)}$ is given below.

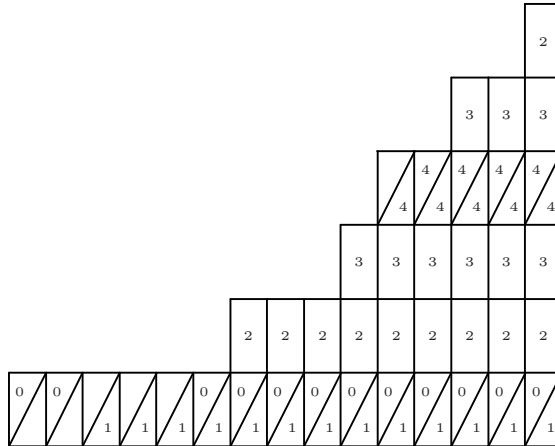

Note that the Young column in Example 3.6 is not reduced.

3.3. The crystal structure on Young columns.

We denote the set of level- l reduced Young columns of types $A_{2n}^{(2)}$, $D_{n+1}^{(2)}$, $A_{2n-1}^{(2)}$, $D_n^{(1)}$, $B_n^{(1)}$ and $C_n^{(1)}$ by $\mathcal{C}^{(l)}$ uniformly. We shall define the crystal structure on the set $\mathcal{C}^{(l)}$.

We define the maps \tilde{f}_i ($i \in I$) from $\mathcal{C}^{(l)}$ to $\mathcal{C}^{(l)}$ by adding an i -block on level- l reduced Young columns. We list the definition of \tilde{f}_i for each type as follows:

- (1) For types $A_{2n}^{(2)}$ ($1 \leq i \leq n-1$), $D_{n+1}^{(2)}$ ($1 \leq i \leq n-1$), $C_n^{(1)}$ ($1 \leq i \leq n-1$), $A_{2n-1}^{(2)}$ ($1 < i \leq n-1$), $D_n^{(1)}$ ($1 < i \leq n-2$) and $B_n^{(1)}$ ($1 < i \leq n-1$),

if $x_{i+1} \geq \bar{x}_{i+1}$, the map \tilde{f}_i is given by

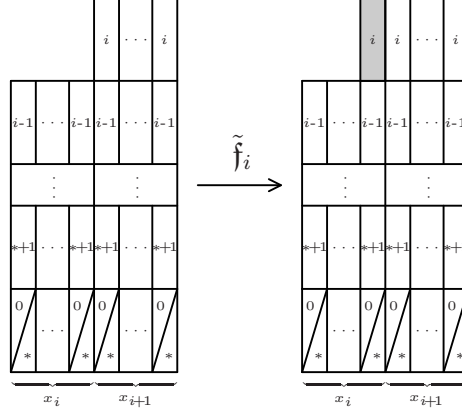

if $x_{i+1} < \bar{x}_{i+1}$, the map \tilde{f}_i is given by

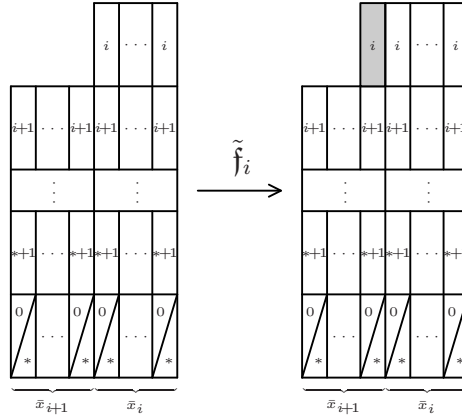

- (2) For types $A_{2n}^{(2)}$ and $D_{n+1}^{(2)}$,

if $x_1 \geq \bar{x}_1$, the map \tilde{f}_0 is given by

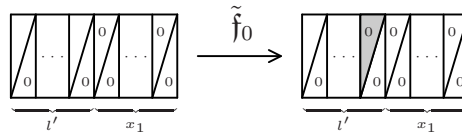

if $x_1 < \bar{x}_1$, the map \tilde{f}_0 is given by

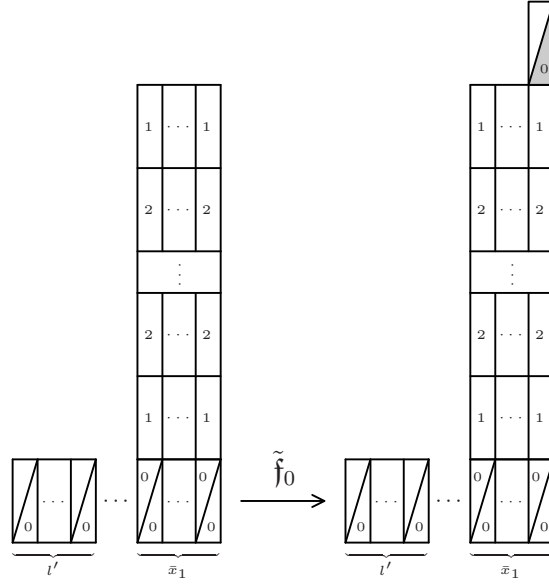

where $l' = l - \sum_{i=1}^n (x_i + \bar{x}_i)$ for type $A_{2n}^{(2)}$ and $l' = l - \sum_{i=1}^n (x_i + \bar{x}_i) - x_0$ for type $D_{n+1}^{(2)}$.

(3) For types $A_{2n-1}^{(2)}$, $D_n^{(1)}$ and $B_n^{(1)}$,

if $x_2 \geq \bar{x}_2$, the map \tilde{f}_1 is given by

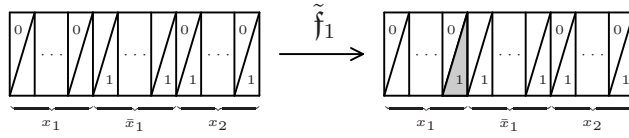

if $x_2 < \bar{x}_2$, the map \tilde{f}_1 is given by

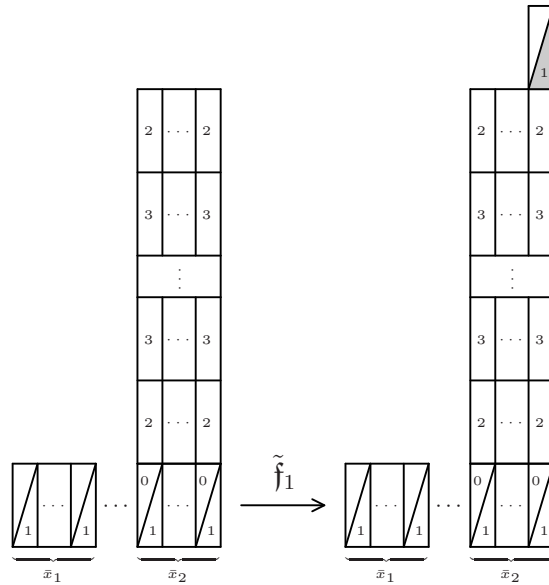

(4) For types $A_{2n-1}^{(2)}$, $D_n^{(1)}$ and $B_n^{(1)}$,

if $x_2 \geq \bar{x}_2$, the map \tilde{f}_0 is given by

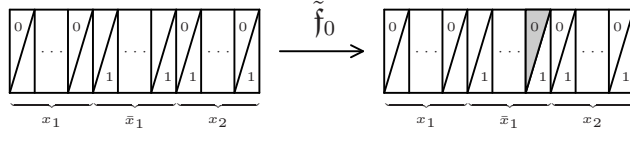

if $x_2 < \bar{x}_2$, the map \tilde{f}_0 is given by

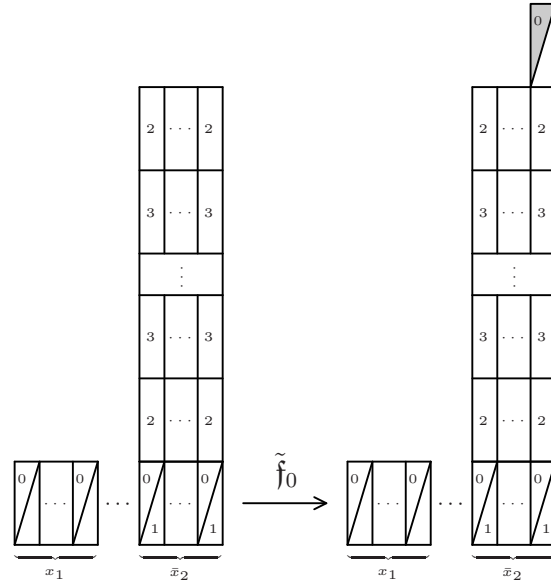

(5) For types $D_{n+1}^{(2)}$ and $B_n^{(1)}$,

if $x_0 = 0$, the map \tilde{f}_n is given by

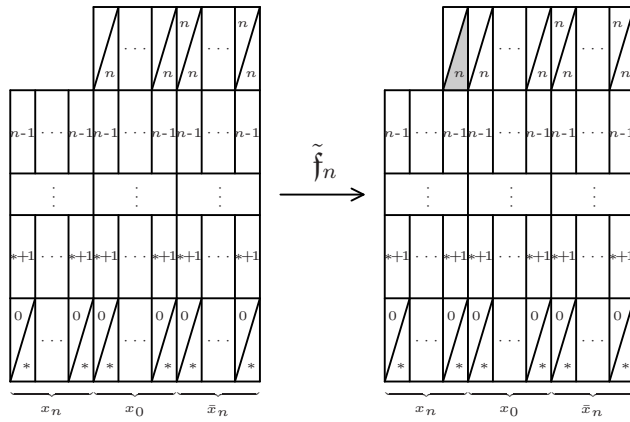

if $x_0 = 1$, the map \tilde{f}_n is given by

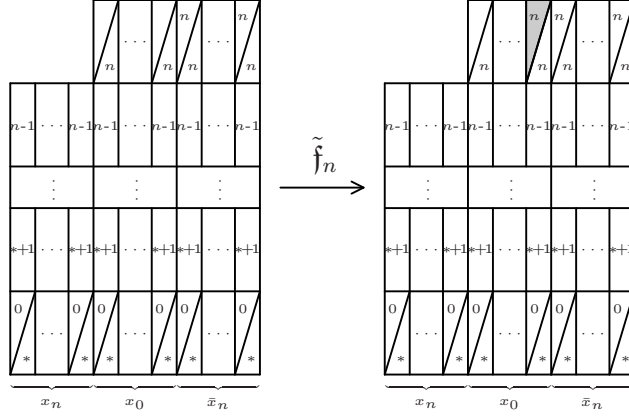

(6) For types $A_{2n}^{(2)}$, $C_n^{(1)}$, $A_{2n-1}^{(2)}$, the map \tilde{f}_n is given by

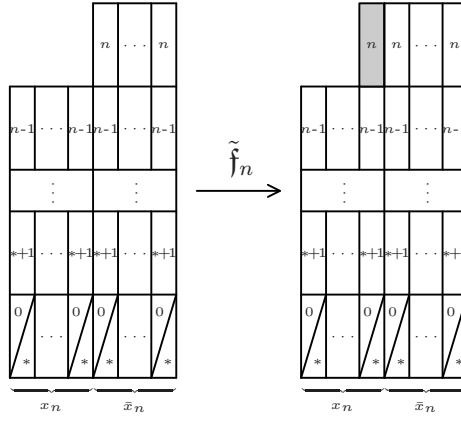

(7) For type $D_n^{(1)}$,

if $x_n \geq 0$, $\bar{x}_n = 0$, the map \tilde{f}_{n-1} is given by

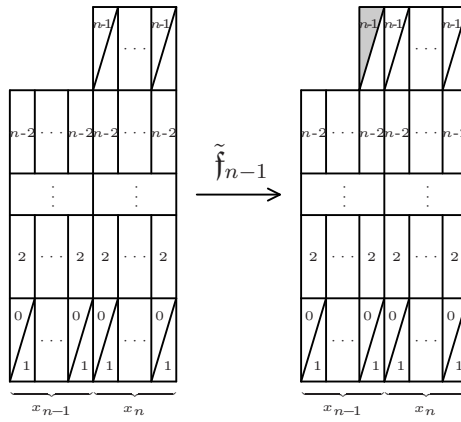

if $x_n = 0$, $\bar{x}_n \geq 1$, the map \tilde{f}_{n-1} is given by

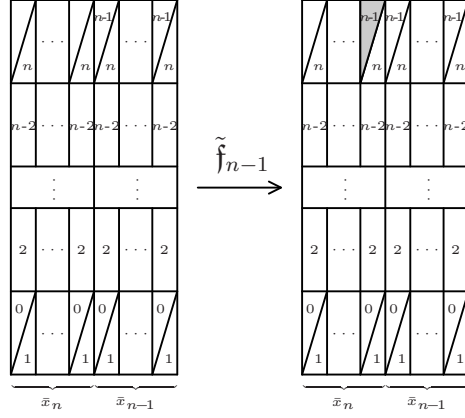

if $x_n \geq 1$, $\bar{x}_n = 0$, the map \tilde{f}_n is given by

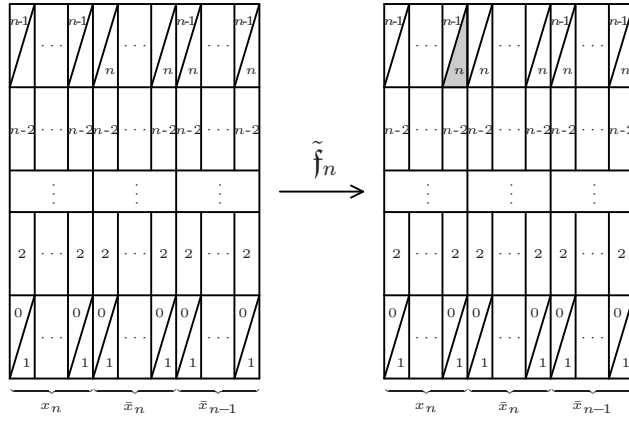

if $x_n = 0$, $\bar{x}_n \geq 0$, the map \tilde{f}_n is given by

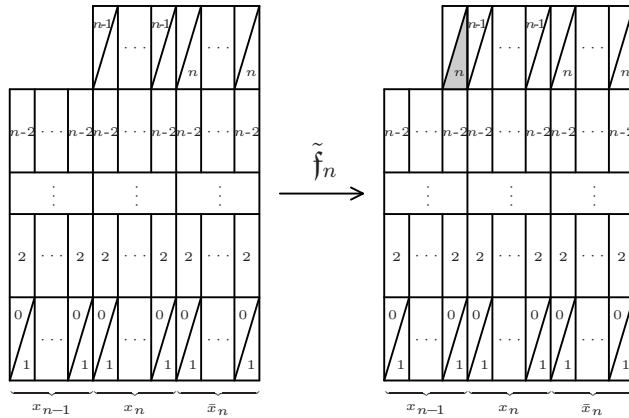

(8) For type $C_n^{(1)}$,

if $x_1 \geq \bar{x}_1$, the map \tilde{f}_0 is given by

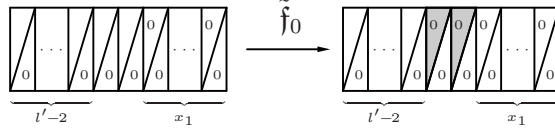

where $l' = 2l - \sum_{i=1}^n (x_i + \bar{x}_i)$.

if $x_1 = \bar{x}_1 - 1$, the map \tilde{f}_0 is given by

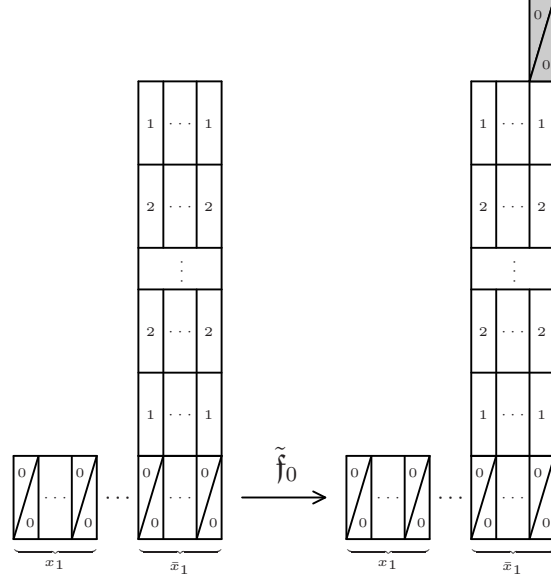

if $x_1 \leq \bar{x}_1 - 2$, the map \tilde{f}_0 is given by

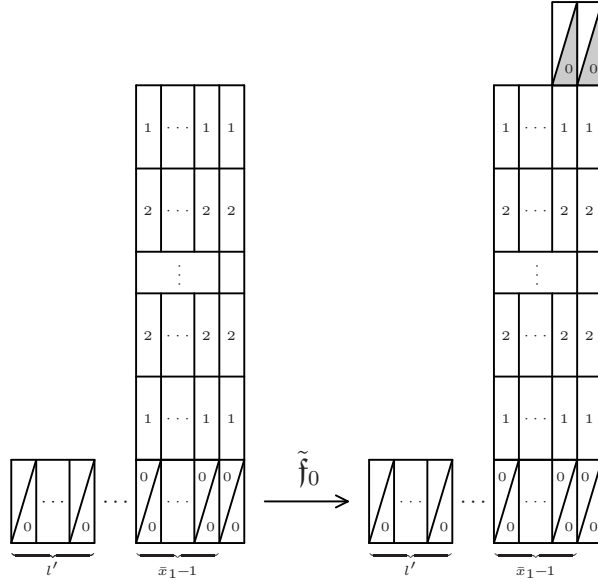

where $l' = 2l - \sum_{i=1}^n (x_i + \bar{x}_i)$.

Remark 3.8. After we perform the \tilde{f}_i -action on the level- l reduced Young columns, we remove all removable δ -slices and move some slices in the Young columns to keep the shapes of the level- l reduced Young columns in Section 3.2.

Example 3.9. We consider the case $B_4^{(1)}$. Let $l = 15$ and $b = (2, 1, 2, 2, 1, 1, 1, 2, 3)$. The action of \tilde{f}_1 on the reduced Young Column C_b is given below.

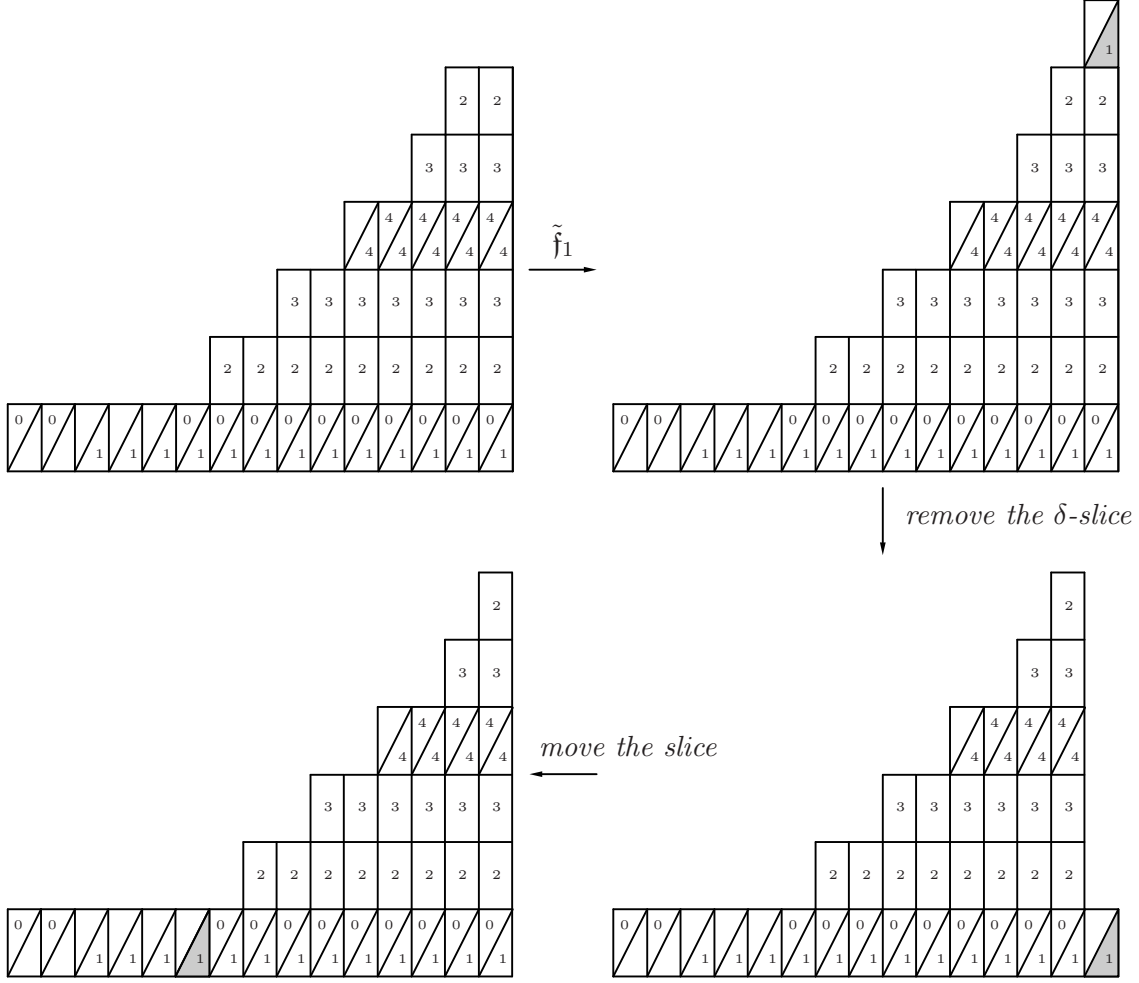

Let $C \in \mathcal{C}^{(l)}$ be a level- l reduced Young column. We define $\tilde{\mathbf{e}}_i C = C'$ ($i \in I$) by removing the i -block in C such that $\tilde{\mathbf{f}}_i C' = C$. We denote the number of i -blocks which can be removed and added in C by $\epsilon_i(C)$ and $\phi_i(C)$, respectively. We define $\text{wt}(C) = \sum_{i=0}^n (\phi_i(C) - \epsilon_i(C)) \Lambda_i$.

According to the definitions of $\tilde{\mathbf{e}}_i$, $\tilde{\mathbf{f}}_i$, ϵ_i , ϕ_i ($i \in I$) and wt on $\mathcal{C}^{(l)}$, we have the following theorem:

Theorem 3.10. *For the quantum affine algebras of types $A_{2n}^{(2)}$, $D_{n+1}^{(2)}$, $A_{2n-1}^{(2)}$, $D_n^{(1)}$, $B_n^{(1)}$ and $C_n^{(1)}$, there is a crystal isomorphism*

$$\Phi : \mathcal{C}^{(l)} \rightarrow \mathcal{B}^{(l)}, \quad C_b \rightarrow b.$$

Proof. We now focus on the type $B_n^{(1)}$. Let C_b be a level- l reduced Young column in $\mathcal{C}^{(l)}$. We assume $\tilde{\mathbf{f}}_i C_b = C_{b'}$. According to the definitions of Kashiwara operators \tilde{f}_i on $\mathcal{B}^{(l)}$ in (2.3), (2.4) and the maps $\tilde{\mathbf{f}}_i$ of type $B_n^{(1)}$ in 3.3(1), 3.3(3)-3.3(5), we have $\tilde{f}_i b = b'$. Hence $\Phi \tilde{\mathbf{f}}_i = \tilde{f}_i \Phi$.

We can verify the commutative relation $\Phi \tilde{\mathbf{e}}_i = \tilde{e}_i \Phi$ by the same approach. The surjectivity of Φ is natural. The injectivity of Φ follows from the definitions of level- l reduced Young columns. The proofs of other types are similar. \square

4. HIGHER LEVEL YOUNG WALLS

In this section, we introduce the notions of ground-state walls, Young walls and reduced Young walls. We show that the set of reduced Young walls is isomorphic to $B(\lambda)$ as $U'_q(\mathfrak{g})$ -crystals.

4.1. Ground-state columns and ground-state walls.

The *ground-state column* is a special case of Young column. The *ground-state wall* is constructed from the ground-state columns by extending to the left infinitely. Let $\lambda = \sum_{i=0}^n k_i \Lambda_i$ be a level l dominant integral weight and let b or b' be the minimal vectors in $\mathcal{B}^{(l)}$. We list the constructions of the ground-state columns and ground-state walls for each type as follows:

(1) For type $A_{2n}^{(2)}$, we have

$$\langle \lambda, c \rangle = k_0 + 2k_1 + \cdots + 2k_{n-1} + 2k_n = l.$$

Let $b = (k_1, \cdots, k_n, k_n, \cdots, k_1)$. Then the ground-state column is C_b and the ground-state wall is

$$Y_\lambda = (\cdots, C_b, C_b, C_b).$$

(2) For type $D_{n+1}^{(2)}$, we have

$$\langle \lambda, c \rangle = k_0 + 2k_1 + \cdots + 2k_{n-1} + k_n = l.$$

Let $b = (x_1, \cdots, x_n, x_0, \bar{x}_n, \cdots, \bar{x}_1)$ such that

$$\begin{aligned} x_0 &= \begin{cases} 0 & \text{if } k_n \text{ is even,} \\ 1 & \text{if } k_n \text{ is odd,} \end{cases} \\ x_i &= \bar{x}_i = k_i \quad \text{for } i = 1, 2, \cdots, n-1, \\ x_n &= \bar{x}_n = \frac{1}{2}(k_n - x_0). \end{aligned}$$

Then the ground-state column is C_b and the ground-state wall is

$$Y_\lambda = (\cdots, C_b, C_b, C_b).$$

(3) For type $C_n^{(1)}$, we have

$$\langle \lambda, c \rangle = k_0 + k_1 + \cdots + k_{n-1} + k_n = l.$$

Let $b = (k_1, \cdots, k_n, k_n, \cdots, k_1)$. Then the ground-state column is C_b and the ground-state wall is

$$Y_\lambda = (\cdots, C_b, C_b, C_b).$$

(4) For type $D_n^{(1)}$, we have

$$\langle \lambda, c \rangle = k_0 + k_1 + 2k_2 + \cdots + 2k_{n-2} + k_{n-1} + k_n = l.$$

Let $b = (x_1, \dots, x_n, \bar{x}_n, \dots, \bar{x}_1)$ such that

$$\begin{aligned} x_1 &= k_0, \quad \bar{x}_1 = k_1, \\ x_i &= \bar{x}_i = k_i \quad \text{for } i = 2, \dots, n-2, \\ x_{n-1} &= \bar{x}_{n-1} = \min(k_{n-1}, k_n), \\ x_n &= (k_{n-1} - k_n)_+, \\ \bar{x}_n &= (k_n - k_{n-1})_+ \end{aligned}$$

and let $b' = (y_1, \dots, y_n, \bar{y}_n, \dots, \bar{y}_1)$ such that

$$\begin{aligned} y_1 &= k_1, \quad \bar{y}_1 = k_0, \\ y_i &= \bar{y}_i = k_i \quad \text{for } i = 2, \dots, n-2, \\ y_{n-1} &= \bar{y}_{n-1} = \min(k_{n-1}, k_n), \\ y_n &= (k_{n-1} - k_n)_+, \\ \bar{y}_n &= (k_n - k_{n-1})_+. \end{aligned}$$

Then the ground-state columns are C_b and $C_{b'}$ and the ground-state wall is

$$Y_\lambda = (\dots, C_b, C_{b'}, C_b, C_{b'}).$$

(5) For type $B_n^{(1)}$, we have

$$\langle \lambda, c \rangle = k_0 + k_1 + 2k_2 + \dots + 2k_{n-1} + k_n = l.$$

Let $b = (x_1, \dots, x_n, x_0, \bar{x}_n, \dots, \bar{x}_1)$ such that

$$\begin{aligned} x_0 &= \begin{cases} 0 & \text{if } k_n \text{ is even,} \\ 1 & \text{if } k_n \text{ is odd,} \end{cases} \\ x_1 &= k_0, \quad \bar{x}_1 = k_1, \\ x_i &= \bar{x}_i = k_i \quad \text{for } i = 2, \dots, n-1, \\ x_n &= \bar{x}_n = \frac{1}{2}(k_n - x_0) \end{aligned}$$

and let $b' = (y_1, \dots, y_n, y_0, \bar{y}_n, \dots, \bar{y}_1)$ such that

$$\begin{aligned} y_0 &= \begin{cases} 0 & \text{if } k_n \text{ is even,} \\ 1 & \text{if } k_n \text{ is odd,} \end{cases} \\ y_1 &= k_1, \quad \bar{y}_1 = k_0, \\ y_i &= \bar{y}_i = k_i \quad \text{for } i = 2, \dots, n-1, \\ y_n &= \bar{y}_n = \frac{1}{2}(k_n - y_0). \end{aligned}$$

Then the ground-state columns are C_b and $C_{b'}$ and the ground-state wall is

$$Y_\lambda = (\dots, C_b, C_{b'}, C_b, C_{b'}).$$

(6) For type $A_{2n-1}^{(2)}$, we have

$$\langle \lambda, c \rangle = k_0 + k_1 + 2k_2 + \dots + 2k_{n-1} + 2k_n = l.$$

Let $b = (x_1, \dots, x_n, \bar{x}_n, \dots, \bar{x}_1)$ such that

$$\begin{aligned} x_1 &= k_0, \quad \bar{x}_1 = k_1, \\ x_i &= \bar{x}_i = k_i \quad \text{for } i = 2, \dots, n \end{aligned}$$

and let $b' = (y_1, \dots, y_n, \bar{y}_n, \dots, \bar{y}_1)$ such that

$$\begin{aligned} y_1 &= k_1, \quad \bar{y}_1 = k_0, \\ y_i &= \bar{y}_i = k_i \quad \text{for } i = 2, \dots, n. \end{aligned}$$

Then the ground-state columns are C_b and $C_{b'}$ and the ground-state wall is

$$Y_\lambda = (\dots, C_b, C_{b'}, C_b, C_{b'}).$$

Remark 4.1. *The ground-state columns and ground-state walls constructed above correspond to the minimal vectors and ground-state paths in [7].*

In the following examples, we list the ground-state walls of types $A_4^{(2)}$, $A_5^{(2)}$ and $B_3^{(1)}$ for the level-2 case.

Example 4.2. *For type $A_4^{(2)}$, the level-2 dominant integral weights are $2\Lambda_0$, Λ_1 , Λ_2 and the corresponding minimal vectors are*

$$b_1 = (0, 0, 0, 0), \quad b_2 = (1, 0, 0, 1), \quad b_3 = (0, 1, 1, 0).$$

The ground-state walls corresponding to these vectors are

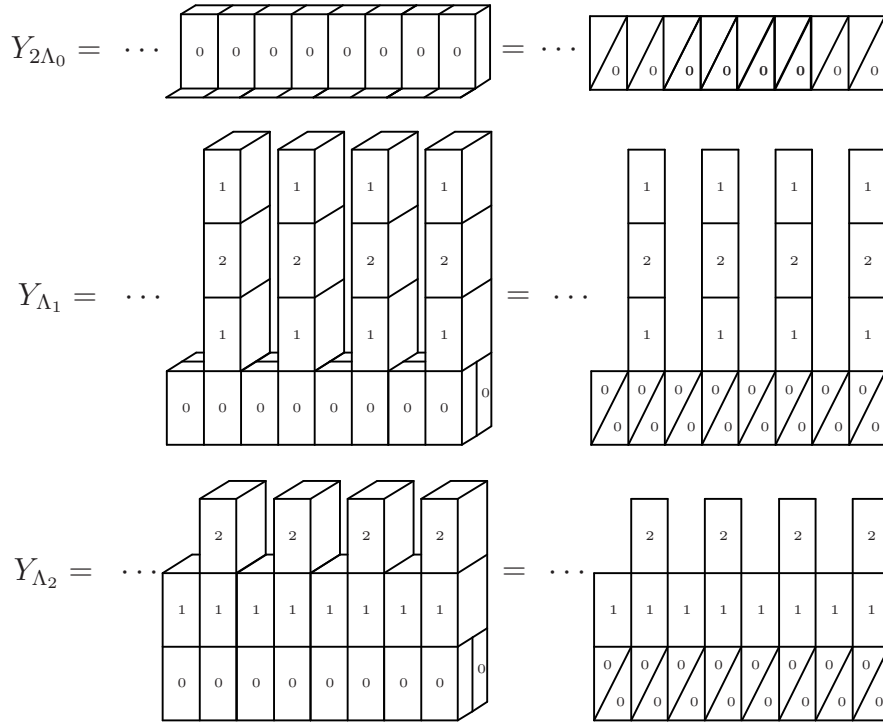

Example 4.3. *For type $A_5^{(2)}$, the level-2 dominant integral weights are $2\Lambda_0$, $2\Lambda_1$, $\Lambda_0 + \Lambda_1$, Λ_2 , Λ_3 and the corresponding minimal vectors are*

$$\begin{aligned}
 b_1 &= (2, 0, 0, 0, 0, 0), & b'_1 &= (0, 0, 0, 0, 0, 2), \\
 b_2 &= (0, 0, 0, 0, 0, 2), & b'_2 &= (2, 0, 0, 0, 0, 0), \\
 b_3 &= b'_3 = (1, 0, 0, 0, 0, 1), \\
 b_4 &= b'_4 = (0, 1, 0, 0, 1, 0), \\
 b_5 &= b'_5 = (0, 0, 1, 1, 0, 0).
 \end{aligned}$$

The ground-state walls corresponding to these vectors are

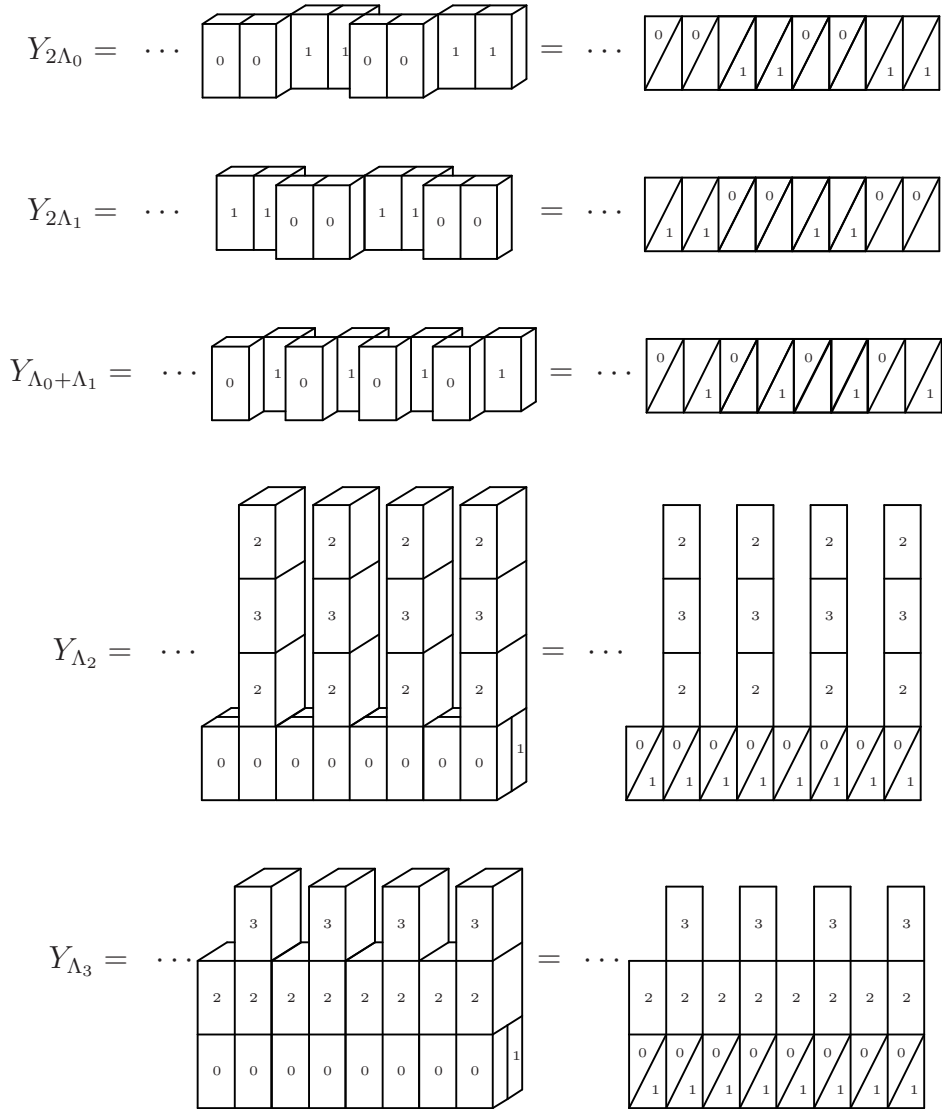

Example 4.4. For type $B_3^{(1)}$, the level-2 dominant integral weights are $2\Lambda_0, 2\Lambda_1, \Lambda_0 + \Lambda_1, \Lambda_2, 2\Lambda_3, \Lambda_0 + \Lambda_3, \Lambda_1 + \Lambda_3$ and the corresponding minimal vectors are

$$\begin{aligned}
 b_1 &= (2, 0, 0, 0, 0, 0, 0), & b'_1 &= (0, 0, 0, 0, 0, 0, 2), \\
 b_2 &= (0, 0, 0, 0, 0, 0, 2), & b'_2 &= (2, 0, 0, 0, 0, 0, 0), \\
 b_3 &= b'_3 = (1, 0, 0, 0, 0, 0, 1), \\
 b_4 &= b'_4 = (0, 1, 0, 0, 0, 1, 0), \\
 b_5 &= b'_5 = (0, 0, 1, 0, 1, 0, 0), \\
 b_6 &= (1, 0, 0, 1, 0, 0, 0), & b'_6 &= (0, 0, 0, 1, 0, 0, 1), \\
 b_7 &= (0, 0, 0, 1, 0, 0, 1), & b'_7 &= (1, 0, 0, 1, 0, 0, 0).
 \end{aligned}$$

The ground-state walls corresponding to these vectors are

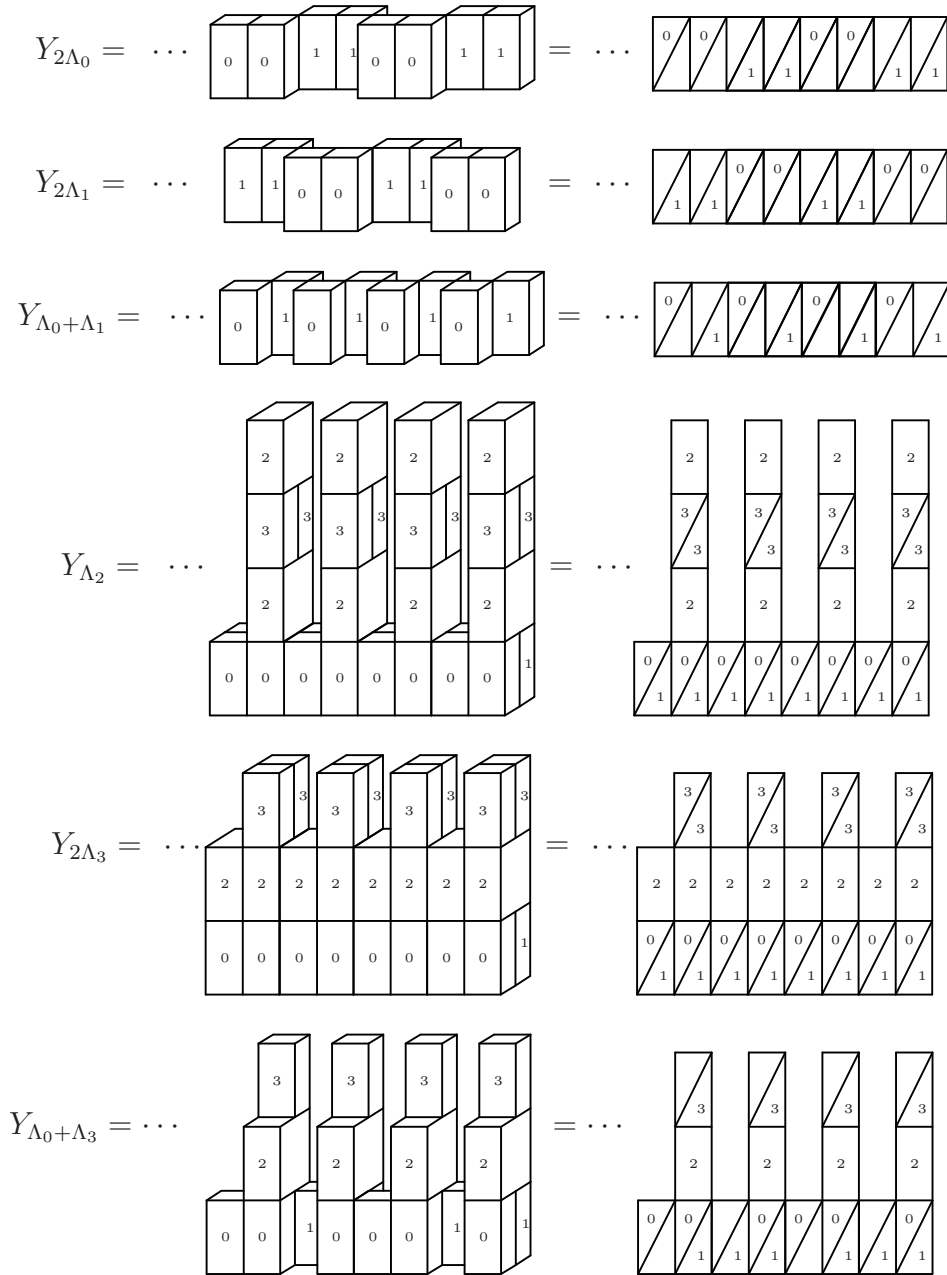

$$Y_{\Lambda_1 + \Lambda_3} = \dots$$

4.2. New Young wall realization of the crystal $B(\lambda)$.

A level- l Young wall consists of infinitely many level- l Young columns which are extended to the left. We denote a level- l Young wall by $Y = (\dots, C_2, C_1, C_0)$, where C_i ($i \geq 0$) are level- l Young columns.

The rules for building Young walls are given as follows:

- (1) The Young walls should be built on top of one of the ground-state walls.
- (2) The colored blocks should be stacked by the stacking patterns in Definition 3.3.
- (3) No block with unit depth can be placed on top of a block with half-unit depth.
- (4) There is no i -block added on the k -th Young column if $\phi_i(C_k) \leq \epsilon_i(C_{k-1})$ ($k \geq 1$).
- (5) For two adjacent Young columns C_k and C_{k-1} , the height of the i -th slice in C_{k-1} is not less than the height of the $(i + l)$ -th slice in C_k .

We say that a slice in a Young wall Y has a *removable δ -slice* if we may remove a δ -slice and still get a Young wall. A Young wall Y is called *reduced* if there is no removable δ -slice in Y . We always assume that the ground-state walls are reduced.

Example 4.5. We give an example of level-2 reduced Young wall built on the ground-state wall $Y_{2\Lambda_0}$ of type $B_3^{(1)}$.

Remark 4.6. The removable δ -slices in Young walls are different from the removable δ -slices in Young columns. For types $A_{2n}^{(2)}$, $D_{n+1}^{(2)}$ and $C_n^{(1)}$, we make a δ -slice only when we add a 0-block. For types $A_{2n-1}^{(2)}$, $D_n^{(1)}$ and $B_n^{(1)}$, we can make a removable δ -slice only when we add both 0-block and 1-block together.

We define the i -signature of a Young column C to be the pair of integers $\text{Sign}_i(C) = (\epsilon_i(C), \phi_i(C))$. To express the i -signature, we will also use a sequence of $\epsilon_i(C)$ many $-$'s followed by $\phi_i(C)$ many $+$'s.

Let $Y = (\dots, C_2, C_1, C_0)$ be a Young Wall. Cancel out all $(+, -)$ -pairs in this sequence $(\dots, \text{Sign}_i(C_2), \text{Sign}_i(C_1), \text{Sign}_i(C_0))$. The remaining finite sequence of $-$'s followed by $+$'s is called the i -signature of Y . We denote the i -signature of Y by $\text{Sign}_i(Y)$.

We define $\tilde{E}_i Y$ ($i \in I$) to be the Young wall obtained by removing an i -block from the Young column of Y that corresponds to the rightmost $-$ in $\text{Sign}_i(Y)$. We define $\tilde{E}_i Y = 0$ if there is no $-$ in $\text{Sign}_i(Y)$.

We define $\tilde{F}_i Y$ ($i \in I$) to be the Young wall obtained by adding an i -block to the Young column of Y that corresponds to the leftmost $+$ in $\text{Sign}_i(Y)$. We define $\tilde{F}_i Y = 0$ if there is no $+$ in $\text{Sign}_i(Y)$.

Let $\mathbf{Y}(\lambda)$ be the set of all level- l reduced Young walls. We define the maps

$$\text{wt} : \mathbf{Y}(\lambda) \longrightarrow P, \quad \varepsilon_i : \mathbf{Y}(\lambda) \longrightarrow \mathbf{Z}, \quad \varphi_i : \mathbf{Y}(\lambda) \longrightarrow \mathbf{Z}$$

by

$$\text{wt}(Y) = \lambda - \sum_{i \in I} k_i \alpha_i,$$

$$\varepsilon_i(Y) = \text{the number of } -\text{'s in the } i\text{-signature of } Y,$$

$$\varphi_i(Y) = \text{the number of } +\text{'s in the } i\text{-signature of } Y,$$

where k_i is the number of i -blocks in Y that have been added to the ground-state wall Y_λ .

Theorem 4.7. *The maps $\text{wt} : \mathbf{Y}(\lambda) \rightarrow P$, $\tilde{E}_i, \tilde{F}_i : \mathbf{Y}(\lambda) \rightarrow \mathbf{Y}(\lambda) \cup \{0\}$ and $\varepsilon_i, \varphi_i : \mathbf{Y}(\lambda) \rightarrow \mathbf{Z}$ define a crystal structure on $\mathbf{Y}(\lambda)$.*

Proof. We only need to prove that $\mathbf{Y}(\lambda) \cup \{0\}$ is closed under the maps \tilde{F}_i ($i \in I$). Let $Y = (\cdots, C_2, C_1, C_0)$ be a level- l reduced Young wall.

For types $A_{2n}^{(2)}$ and $D_{n+1}^{(2)}$, only \tilde{F}_0 -action can produce δ -slices.

Suppose \tilde{F}_0 acts on the Young column C_k in Y . Then $\phi_0(C_{k+1}) \leq \epsilon_0(C_k)$ and $x_1 < \bar{x}_1$ in C_k . Thus we have

$$2l - (\phi_0(C_{k+1}) - 2(\bar{x}'_1 - x'_1)_+) \geq 2l - \phi_0(C_{k+1}) \geq 2l - \epsilon_0(C_k).$$

If we can remove the δ -slice in C_k , we obtain

$$2l - (\phi_0(C_{k+1}) - 2(\bar{x}'_1 - x'_1)_+) \geq 2l - \phi_0(C_{k+1}) > 2l - \epsilon_0(C_k) - 2,$$

which means the number of 0-blocks in C_{k+1} is bigger than the number of 0-blocks in C_k . This is a contradiction to the tensor product rule. Hence $\tilde{F}_0 Y$ is reduced.

For types $A_{2n-1}^{(2)}$, $D_n^{(1)}$ and $B_n^{(1)}$, only the simultaneous action of \tilde{F}_0 and \tilde{F}_1 can produce removable δ -slices.

Suppose \tilde{F}_0 and \tilde{F}_1 act on the Young column C_k . Then $\phi_0(C_{k+1}) \leq \epsilon_0(C_k)$, $\phi_1(C_{k+1}) \leq \epsilon_1(C_k)$ and $x_2 < \bar{x}_2$ in C_k . Thus we obtain

$$l - (\phi_0(C_{k+1}) - (\bar{x}'_2 - x'_2)_+) \geq l - \phi_0(C_{k+1}) \geq l - \epsilon_0(C_k),$$

$$l - (\phi_1(C_{k+1}) - (\bar{x}'_2 - x'_2)_+) \geq l - \phi_1(C_{k+1}) \geq l - \epsilon_1(C_k),$$

which implies the number of 0-blocks and 1-blocks in C_{k+1} is no less than the number of 0-blocks and 1-blocks in C_k .

If we remove a δ -slice in C_k , the number of 0-blocks and 1-blocks in C_k will be reduced by two. This is also a contradiction to the tensor product rule. Hence $\tilde{F}_0 Y$ and $\tilde{F}_1 Y$ are reduced.

For type $C_n^{(1)}$, only \tilde{F}_0 -action can produce δ -slices. Let $b = (x_1, \dots, x_n, \bar{x}_n, \dots, \bar{x}_1)$ and $b' = (x'_1, \dots, x'_n, \bar{x}'_n, \dots, \bar{x}'_1)$ denote the vectors in the perfect crystal corresponding to the Young columns C_k and C_{k+1} , respectively.

Suppose \tilde{F}_0 act on the Young column C_k and $x_1 = \bar{x}_1 - 1$ or $x_1 \leq \bar{x}_1 - 2$ in C_k . Then $\phi_0(C_{k+1}) \leq \epsilon_0(C_k)$ and we obtain the following inequality

$$(4.1) \quad \sum_{i=1}^n (x_i + \bar{x}_i) \leq \sum_{i=1}^n (x'_i + \bar{x}'_i) - 2(\bar{x}'_1 - x'_1)_+.$$

The number of 0-blocks in C_k is $2l + \sum_{i=1}^n (x_i + \bar{x}_i)$ and the number of 0-blocks in C_{k+1} is $2l + \sum_{i=1}^n (x'_i + \bar{x}'_i)$. It follows that

$$2l + \sum_{i=1}^n (x'_i + \bar{x}'_i) \leq 2l + \sum_{i=1}^n (x_i + \bar{x}_i).$$

Assume that we can remove a δ -slice and still get a Young wall.

If $x_1 = \bar{x}_1 - 1$ and remove a δ -slice, then we must have

$$2l + \sum_{i=1}^n (x'_i + \bar{x}'_i) \leq 2l + \sum_{i=1}^n (x_i + \bar{x}_i) - 2.$$

If $x_1 \leq \bar{x}_1 - 2$ and remove two δ -slices, then we must have

$$2l + \sum_{i=1}^n (x'_i + \bar{x}'_i) \leq 2l + \sum_{i=1}^n (x_i + \bar{x}_i) - 4.$$

Both cases will contradict to the inequality (4.1). Hence $\tilde{F}_0 Y$ is reduced. \square

Theorem 4.8. *There exists a $U'_q(\mathfrak{g})$ -crystal isomorphism*

$$\Psi : \mathbf{Y}(\lambda) \xrightarrow{\sim} B(\lambda) \quad \text{given by} \quad Y_\lambda \mapsto u_\lambda.$$

Proof. Since $B(\lambda) \cong \mathcal{P}(\lambda)$, we have only to prove $\mathbf{Y}(\lambda) \cong \mathcal{P}(\lambda)$. Thanks to the crystal isomorphism Φ in Theorem 3.10, we may define a map $\Psi : \mathbf{Y}(\lambda) \rightarrow \mathcal{P}(\lambda)$ by

$$Y = (\dots, C_2, C_1, C_0) \mapsto P_Y = (\dots, \Phi(C_2), \Phi(C_1), \Phi(C_0)).$$

Clearly, the map Ψ is a bijection. Using the tensor product rule, it is straightforward to check that Ψ commutes with the Kashiwara operators; i.e.,

$$\tilde{e}_i \circ \Psi = \Psi \circ \tilde{E}_i, \quad \tilde{f}_i \circ \Psi = \Psi \circ \tilde{F}_i \quad \text{for all } i \in I.$$

\square

In the following examples, the arrows represent the action of Kashiwara operators \tilde{f}_i ($i \in I$).

Example 4.9. *The top part of the crystal $\mathbf{Y}(2\Lambda_0)$ for $B_3^{(1)}$ is given below.*

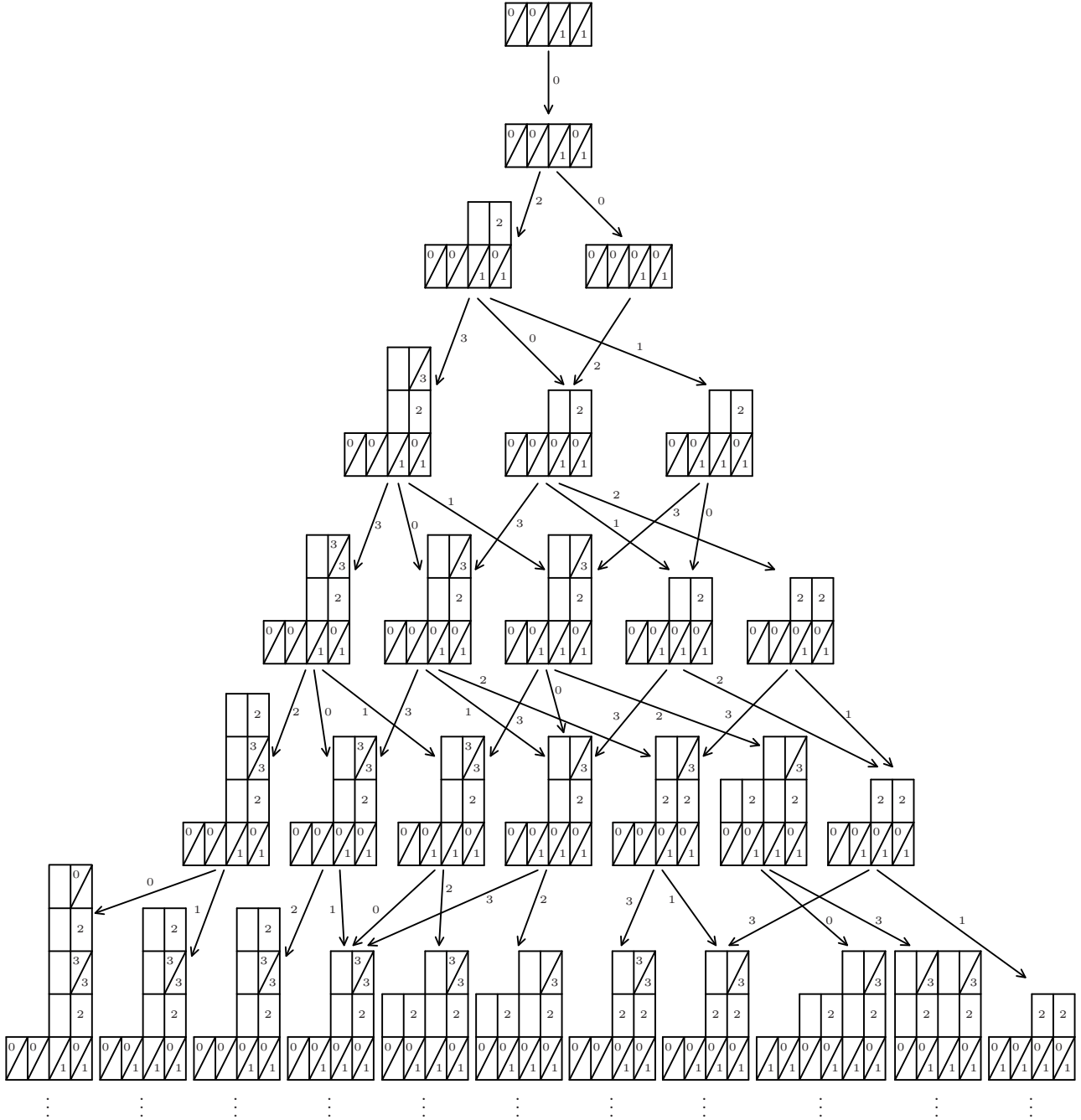

Example 4.10. *The top part of the crystal $\mathbf{Y}(2\Lambda_0)$ for $A_2^{(2)}$ is given below.*

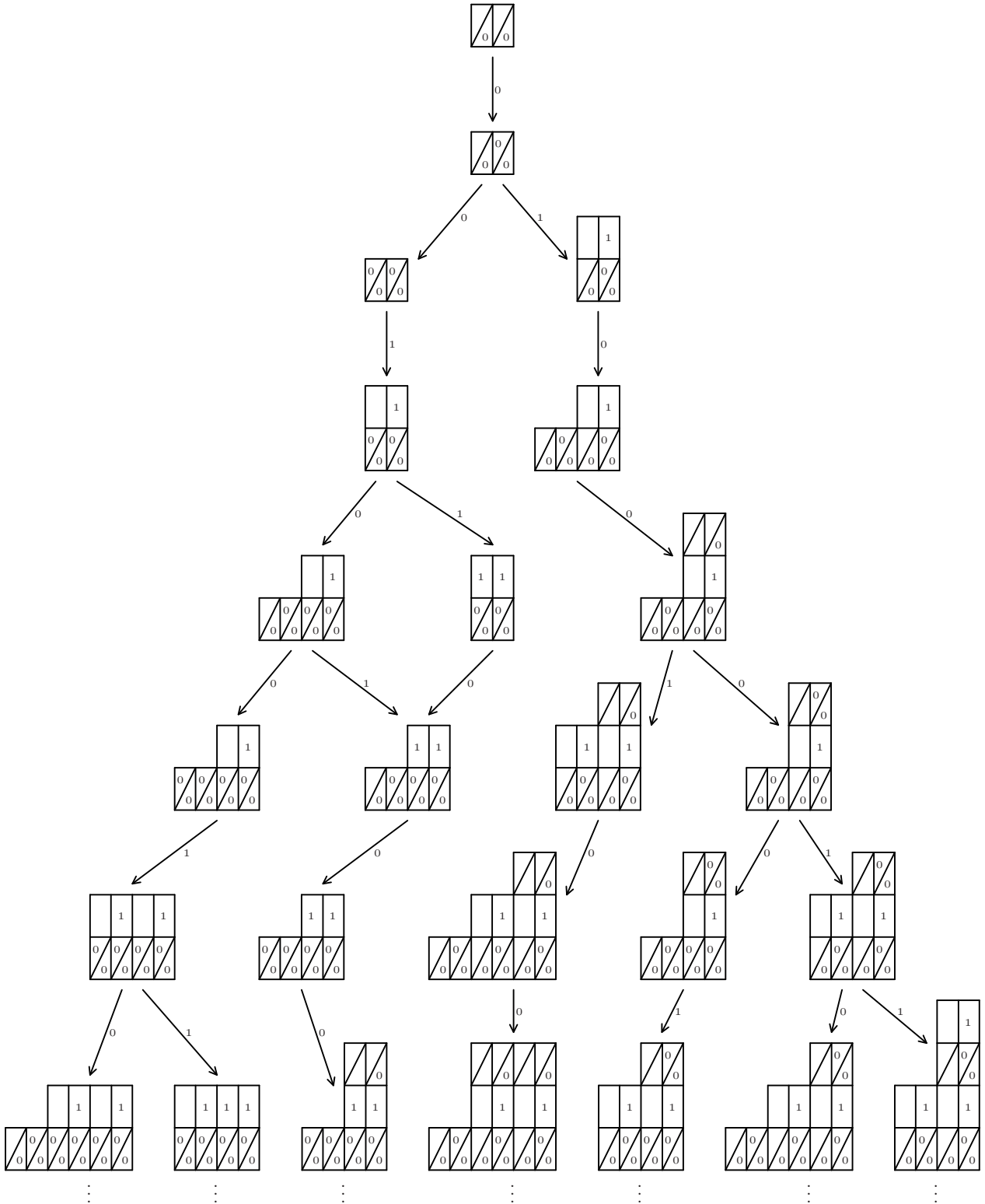

Example 4.11. *The top part of the crystal $\mathbf{Y}(2\Lambda_0)$ for $D_3^{(2)}$ is given below.*

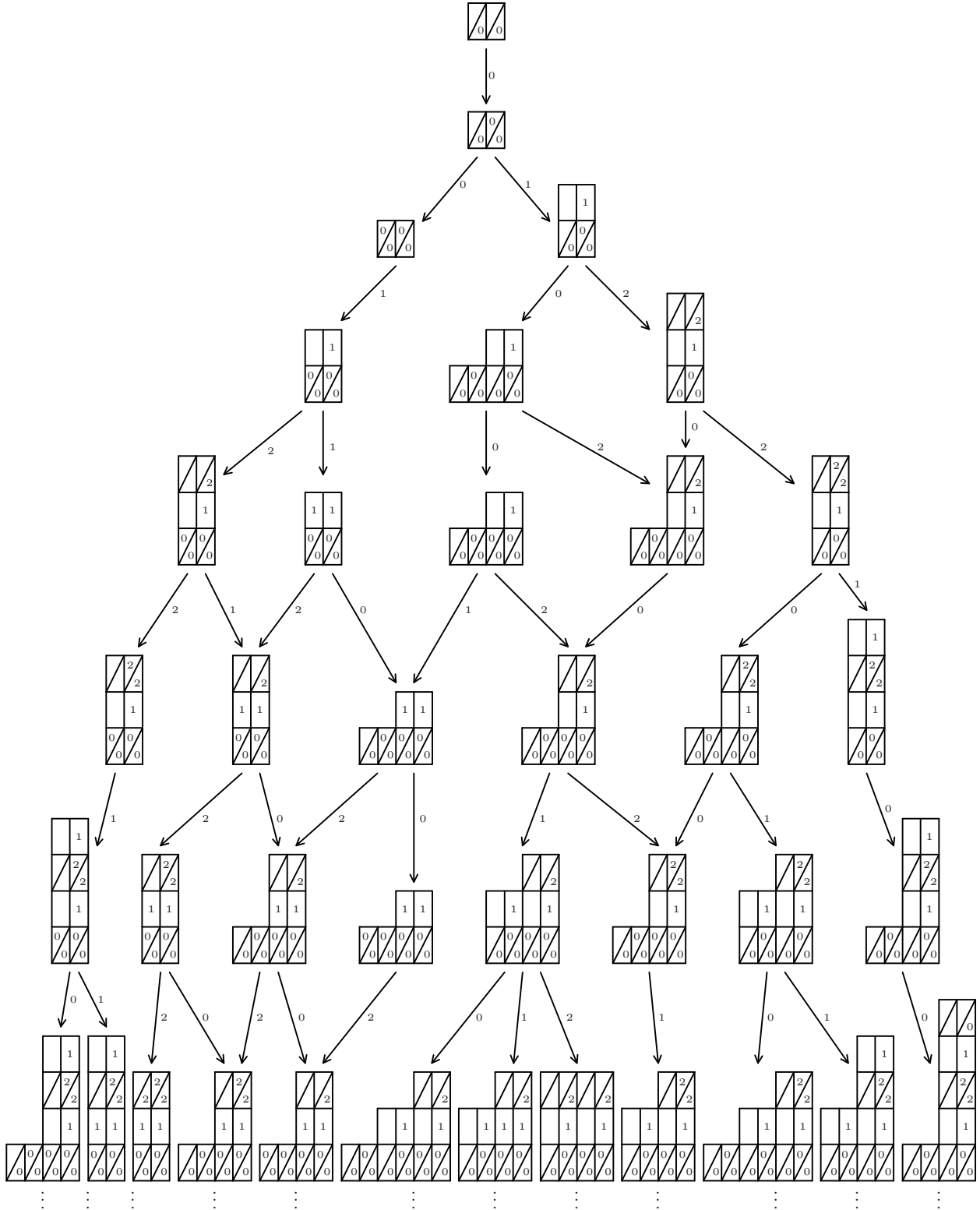

Example 4.12. *The top part of the crystal $\mathbf{Y}(2\Lambda_0)$ for $C_2^{(1)}$ is given below.*

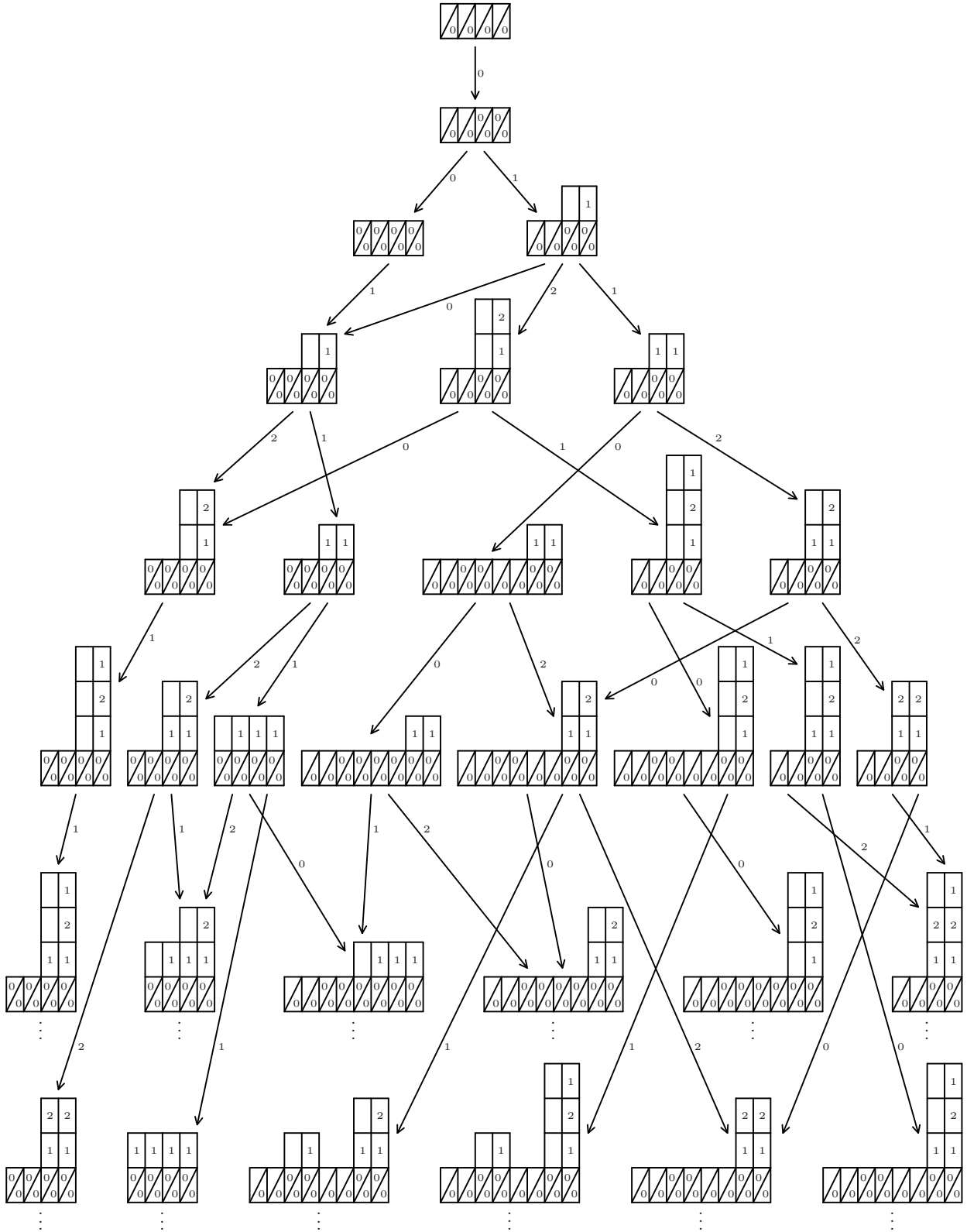

5. NEW YOUNG WALL REALIZATION OF THE CRYATAL $B(\infty)$

Let $B(\infty)$ denote the crystal of the negative half $U_q^-(\mathfrak{g})$ of $U_q(\mathfrak{g})$. In this section, we will give a new Young wall realization of $B(\infty)$.

Let (B_∞, b_∞) be the crystal limit of coherent family of perfect crystals $\{\mathcal{B}^{(l)}\}_{l \geq 1}$ [5, Lemma 4.3]. One could find an explicit description of B_∞ in [5, Section 5]. Then there is a $U_q(\mathfrak{g})$ -crystal isomorphism

$$(5.1) \quad B(\infty) \cong B(\infty) \otimes B_\infty, \quad u_\infty \mapsto u_\infty \otimes b_\infty,$$

where u_∞ is the element in $B(\infty)$ corresponding to $1 \in U_q^-(\mathfrak{g})$.

By applying the isomorphism (5.1) repeatedly, we have the crystal isomorphism as follows:

$$\psi_k : B(\infty) \cong B(\infty) \otimes \underbrace{B_\infty^k}_{k}, \quad u_\infty \mapsto u_\infty \otimes \underbrace{b_\infty \otimes \cdots \otimes b_\infty}_k.$$

The infinite sequence $(\cdots, b_\infty, b_\infty, b_\infty)$ in $B_\infty^{\otimes \infty}$ is called the *ground-state path*. A *path* in $B_\infty^{\otimes \infty}$ is an infinite sequence $p = (p_k)_{k \geq 1}$ such that $p_k = b_\infty$ for $k \gg 0$. Let $\mathcal{P}(\infty)$ denote the set of all paths in $B_\infty^{\otimes \infty}$.

The crystal $B(\infty)$ has the following path realization.

Theorem 5.1 ([5]). *There exists a $U_q(\mathfrak{g})$ -crystal isomorphism*

$$B(\infty) \longrightarrow \mathcal{P}(\infty) \quad \text{given by } b \rightarrow \cdots \otimes p_k \otimes \cdots \otimes p_2 \otimes p_1,$$

where $\psi_k(b) = u_\infty \otimes p_k \otimes \cdots \otimes p_1$ for $k \gg 0$.

For all $i \in I$, the following colored blocks will be used to construct Young columns corresponding to the vectors in B_∞ .

$$\begin{array}{ccc} \begin{array}{c} \boxed{i} \\ 1/\infty \times 1 \times 1 \end{array} = \begin{array}{c} \boxed{i} \\ 1/\infty \times 1 \times 1 \end{array} & \begin{array}{c} \boxed{i} \\ 1/\infty \times 1/2 \times 1 \end{array} = \begin{array}{c} \boxed{i} \\ 1/\infty \times 1/2 \times 1 \end{array} & \begin{array}{c} \boxed{i} \\ 1/\infty \times 1/2 \times 1 \end{array} = \begin{array}{c} \boxed{i} \\ 1/\infty \times 1/2 \times 1 \end{array} \end{array}$$

Here, the notation $\frac{1}{\infty}$ is just a formal symbol. We can think of it as a constant.

To define the notion of Young columns for $B(\infty)$, we need to make some changes of the definitions in Section 3.2.

- (1) For type $A_{2n}^{(2)}$, let $l' = -\sum_{i=1}^n (x_i + \bar{x}_i)$ and $x_i, \bar{x}_i \in \mathbf{Z}$.
- (2) For type $D_{n+1}^{(2)}$, let $l' = -\sum_{i=1}^n (x_i + \bar{x}_i) - x_0$, $x_0 = 0$ or 1 and $x_i, \bar{x}_i \in \mathbf{Z}$.
- (3) For type $A_{2n-1}^{(2)}$, let $\sum_{i=1}^n (x_i + \bar{x}_i) = 0$ and $x_i, \bar{x}_i \in \mathbf{Z}$.
- (4) For type $D_n^{(1)}$, let $\sum_{i=1}^n (x_i + \bar{x}_i) = 0$, $x_n = 0$ or $\bar{x}_n = 0$ and $x_i, \bar{x}_i \in \mathbf{Z}$.
- (5) For type $B_n^{(1)}$, let $x_0 + \sum_{i=1}^n (x_i + \bar{x}_i) = 0$, $x_0 = 0$ or 1 and $x_i, \bar{x}_i \in \mathbf{Z}$.
- (6) For type $C_n^{(1)}$, let $l' = -\sum_{i=1}^n (x_i + \bar{x}_i)$, $x_0 = 0$ and $x_i, \bar{x}_i \in \mathbf{Z}$.

The modified Young columns are called the *virtual Young columns*. In this case, we allow *negative* integers to count the number of blocks or slices that appear in a virtual Young column.

Let $\widehat{\mathbf{Z}}_{\geq 0} = \mathbf{Z}_{\geq 0} \cup \{\infty\}$. We define the notion of *extended Young columns* as follows. We use $u_i, v_i, \bar{u}_i, \bar{v}_i$ to represent the number of slices in the blank areas. We use the rightmost column to mark the colors of the blocks in a Young column.

For type $A_{2n}^{(2)}$, let $C_{(x_1, \dots, x_n, \bar{x}_n, \dots, \bar{x}_1)}$ be a virtual Young column. We choose $u_i, v_i, \bar{u}_i, \bar{v}_i \in \widehat{\mathbf{Z}}_{\geq 0}$ such that

$$\bar{u}_i - \bar{v}_i = \bar{x}_i, \quad u_i - v_i = x_i, \quad u_{n+1} - v_{n+1} = -\sum_{i=1}^n (x_i + \bar{x}_i).$$

Then the corresponding extended Young column is given as

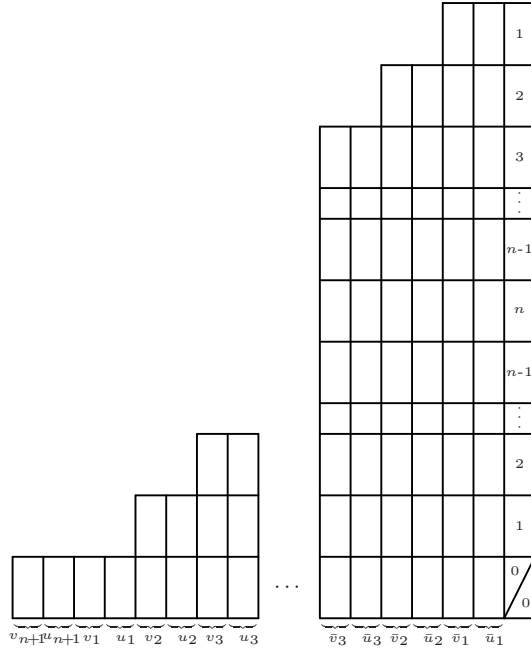

For type $D_{n+1}^{(2)}$, let $C_{(x_1, \dots, x_n, x_0, \bar{x}_n, \dots, \bar{x}_1)}$ be a virtual Young column. We choose $u_i, v_i, \bar{u}_i, \bar{v}_i \in \widehat{\mathbf{Z}}_{\geq 0}$ such that

$$\bar{u}_i - \bar{v}_i = \bar{x}_i, \quad u_i - v_i = x_i, \quad u_{n+1} - v_{n+1} = -\sum_{i=1}^n (x_i + \bar{x}_i) - x_0.$$

Then the corresponding extended Young column is given as

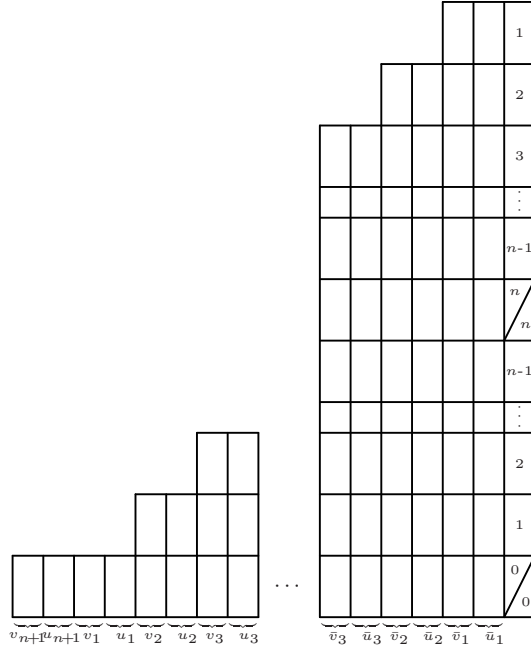

For type $A_{2n-1}^{(2)}$, let $C_{(x_1, \dots, x_n, \bar{x}_n, \dots, \bar{x}_1)}$ be a virtual Young column. We choose $u_i, v_i, \bar{u}_i, \bar{v}_i \in \widehat{\mathbf{Z}}_{\geq 0}$ such that

$$\bar{u}_i - \bar{v}_i = \bar{x}_i, \quad u_i - v_i = x_i.$$

Then the corresponding extended Young Column is given as

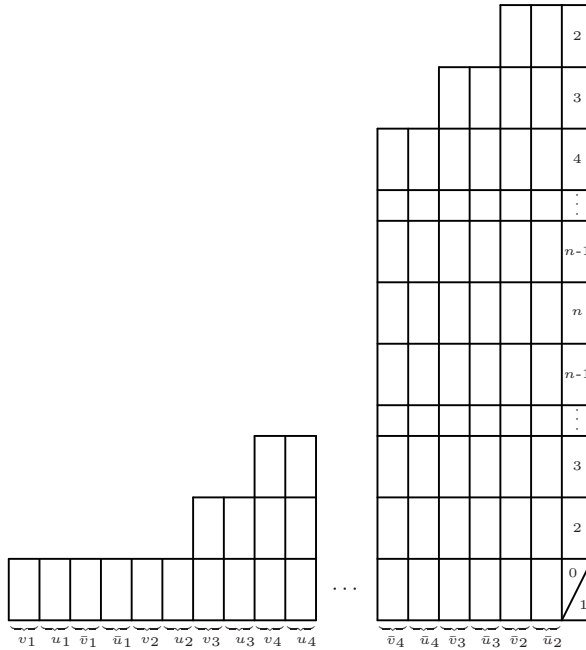

For type $D_n^{(1)}$, let $C_{(x_1, \dots, x_n, \bar{x}_n, \dots, \bar{x}_1)}$ be a virtual Young column. We choose $u_i, v_i, \bar{u}_i, \bar{v}_i \in \widehat{\mathbf{Z}}_{\geq 0}$ such that

$$\bar{u}_i - \bar{v}_i = \bar{x}_i, \quad u_i - v_i = x_i.$$

Then the corresponding extended Young column is given as

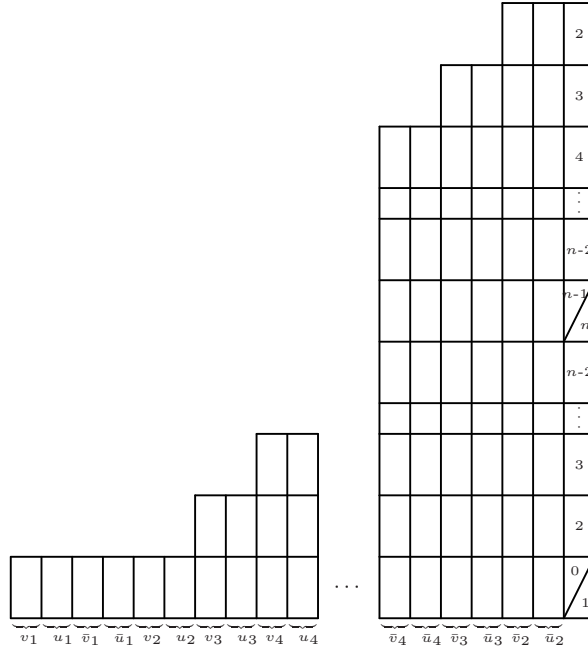

For type $B_n^{(1)}$, let $C_{(x_1, \dots, x_n, x_0, \bar{x}_n, \dots, \bar{x}_1)}$ be a virtual Young column. We choose $u_i, v_i, \bar{u}_i, \bar{v}_i \in \widehat{\mathbf{Z}}_{\geq 0}$ such that

$$\bar{u}_i - \bar{v}_i = \bar{x}_i, \quad u_i - v_i = x_i.$$

Then the corresponding extended Young column is given as

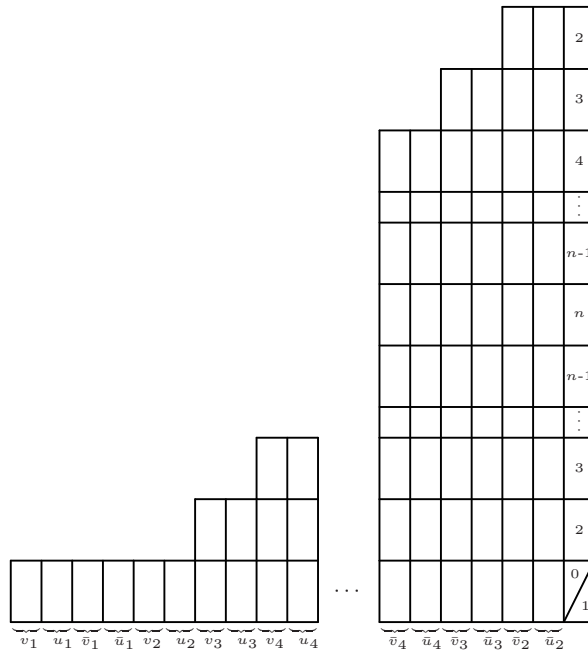

For type $C_n^{(1)}$, let $C_{(x_1, \dots, x_n, \bar{x}_n, \dots, \bar{x}_1)}$ be a virtual Young column. We choose $u_i, v_i, \bar{u}_i, \bar{v}_i \in \widehat{\mathbf{Z}}_{\geq 0}$ such that

$$\bar{u}_i - \bar{v}_i = \bar{x}_i, \quad u_i - v_i = x_i, \quad u_{n+1} - v_{n+1} = -\sum_{i=1}^n (x_i + \bar{x}_i).$$

Then the corresponding extended Young column is given as

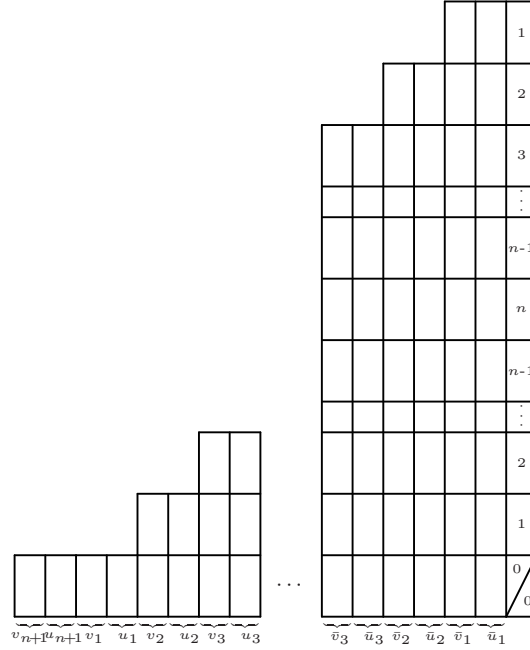

In the extended Young columns defined above, the vertical line separating $u_i(\bar{u}_i)$ and $v_i(\bar{v}_i)$ is called a *virtual line*.

Remark 5.2. *The stacking patterns for extended Young columns follow the patterns given in Definition 3.3.*

We define the action of Kashiwara operators on extended Young columns in the same way as in Section 3.3. But we only add or remove blocks on the right side of each virtual line.

We can read off the same virtual Young column from different extended Young columns. We say that two extended Young columns are *equivalent* if they correspond to the same virtual Young column. The extended Young columns given below form an equivalence class of extended Young columns.

In each type, set $u_i = v_i = \bar{u}_i = \bar{v}_i = \infty$. The extended Young columns in this case are called the *ground-state extended Young columns*. The virtual Young column corresponding to the ground-state extended Young column is an empty Young column, which can be regarded as the *ground-state virtual Young column*.

We can define the notions of virtual Young walls, reduced virtual Young walls, extended Young walls, reduced extended Young walls, i -signatures and Kashiwara operators in a similar way as in Section 4.2. Practically, we usually consider the Kashiwara operators acting on extended Young walls rather than virtual Young walls.

Let Y_∞ denote the extended Young wall consisting of infinitely many ground-state extended Young columns extending to the left.

For a virtual Young wall or an extended Young wall Y , we define

- (1) $\text{wt}(Y) = -\sum_{i \in I} k_i \alpha_i$, where k_i is the number of i -blocks added on Y_∞ ,
- (2) $\varepsilon_i(Y)$ is the number of $-$'s in the i -signature of Y ,
- (3) $\varphi_i(Y)$ is the number of $+$'s in the i -signature of Y .

Let $\mathcal{Y}(\infty)$ and $\widehat{\mathcal{Y}}(\infty)$ denote the set of all reduced virtual Young walls and reduced extended Young walls, respectively. Let Y_\emptyset be the virtual Young wall consisting of infinitely many empty Young columns extending to the left.

By a similar argument as in the proof of Theorem 4.8, we have the following theorem.

Theorem 5.3.

- (a) The sets $\mathcal{Y}(\infty)$ and $\widehat{\mathcal{Y}}(\infty)$ are $U'_q(\mathfrak{g})$ -crystals.
- (b) There exist $U'_q(\mathfrak{g})$ -crystal isomorphisms

$$\begin{array}{ccc} \mathcal{Y}(\infty) & \xrightarrow{\sim} & \widehat{\mathcal{Y}}(\infty) \xrightarrow{\sim} B(\infty) \\ Y_\emptyset & \mapsto & Y_\infty \mapsto u_\infty. \end{array}$$

Proof. For part (a), we follow a similar approach in the proof of Theorem 4.7. We need to prove that the set $\widehat{\mathcal{Y}}(\infty) \cup \{0\}$ is closed under the maps \tilde{F}_i ($i \in I$). Let $Y = (\cdots, C_2, C_1, C_0)$ be a reduced extended Young wall in $\widehat{\mathcal{Y}}(\infty)$.

For type $A_{2n}^{(2)}$, only \tilde{F}_0 -action can produce δ -slices. Assume \tilde{F}_0 acts on the extended Young column C_k in Y , then we have

$$\phi_0(C_{k+1}) \leq \epsilon_0(C_k), \quad x_1 < \bar{x}_1.$$

Thus we have

$$-(\phi_0(C_{k+1}) - 2(\bar{x}'_1 - x'_1)_+) \geq -\phi_0(C_{k+1}) \geq -\epsilon_0(C_k).$$

If we remove the δ -slice in C_k , we obtain

$$-(\phi_0(C_{k+1}) - 2(\bar{x}'_1 - x'_1)_+) \geq -\phi_0(C_{k+1}) > -\epsilon_0(C_k) - 2,$$

which means the number of 0-blocks in C_{k+1} is bigger than the number of blocks in C_k . This will be contradict to the tensor product rule. Hence $\tilde{F}_0 Y$ is reduced.

The crystal structure on $\widehat{\mathcal{Y}}(\infty)$ of other types can also be proved in a similar way. Since virtual Young walls can be obtained from extended Young walls, the crystal structure on $\mathcal{Y}(\infty)$ follows from the crystal structure on $\widehat{\mathcal{Y}}(\infty)$.

For part (b), it is easy to see that the crystal $\mathcal{Y}(\infty)$ is isomorphic to the crystal $\widehat{\mathcal{Y}}(\infty)$. We can prove that the crystal $\widehat{\mathcal{Y}}(\infty)$ and $B(\infty)$ are isomorphic using a similar approach in the proof of Theorem 4.8. \square

Example 5.4. We illustrate the top part of the crystal $B(\infty)$ for type $D_3^{(2)}$ in terms of reduced virtual Young walls. For each reduced virtual Young wall, the number below the slice represents the number of slices.

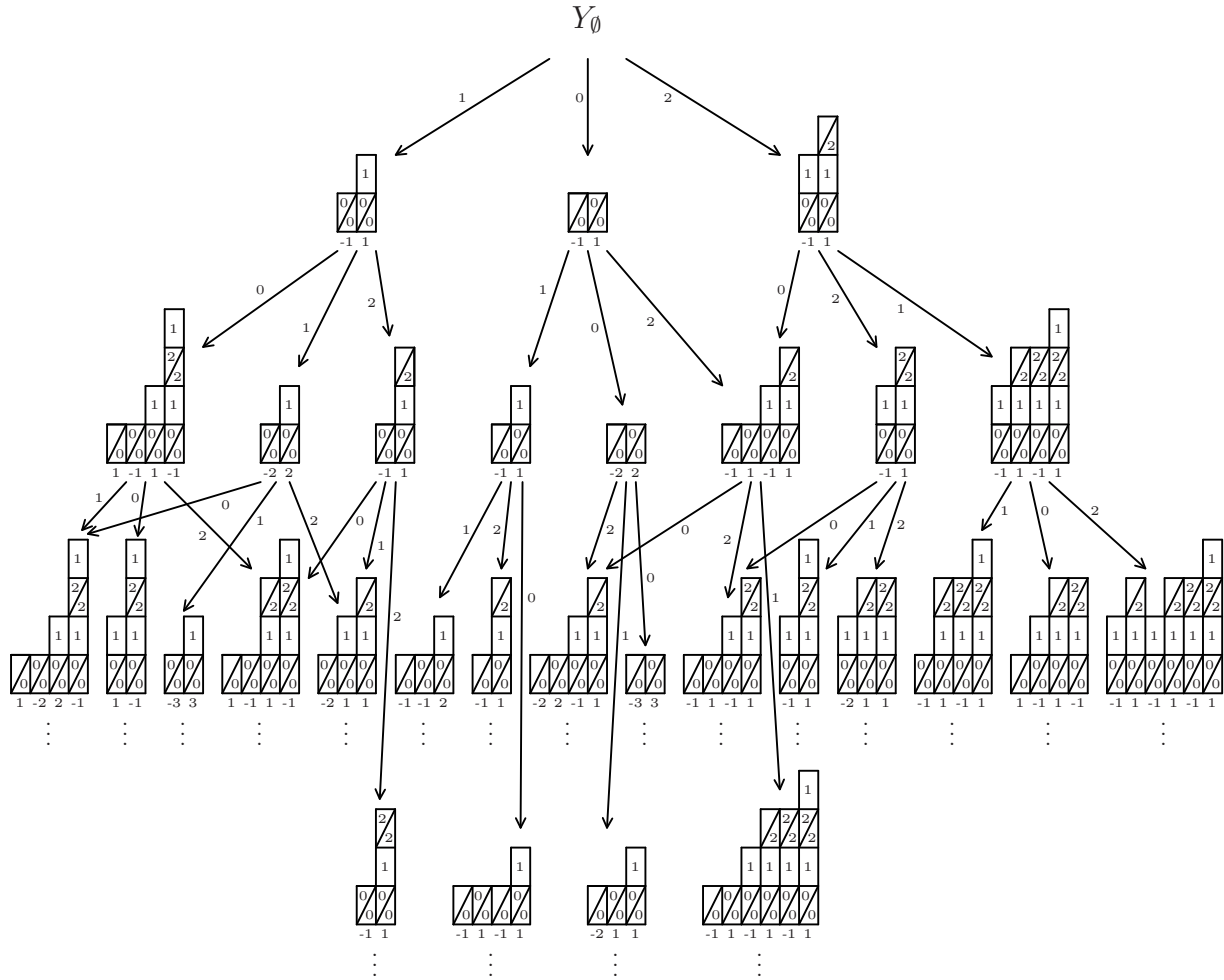

REFERENCES

- [1] G. Benkart, S.-J. Kang, S.-J. Oh and E. Park, *Construction of irreducible representations over Khovanov-Lauda-Rouquier algebras of finite classical type*, Int. Math. Res. Not. **2014**(5) (2014), 1312–1366.
- [2] J. Brundan and A. Kleshchev, *Hecke-Clifford superalgebras, crystals of type $A_{2\ell}^{(2)}$ and modular branching rules for \widehat{S}_n* , Represent. Theory **5** (2001), 317–403.
- [3] Victor G. Kac, *Infinite dimensional Lie algebras*, third edition (Cambridge University Press, 1990).
- [4] S.-J. Kang, *Crystal bases for quantum affine algebras and combinatorics of Young walls*, Proc. Lond. Math. Soc. **86**(3) (2003), 29–69.
- [5] S.-J. Kang, M. Kashiwara and K. C. Misra, *Crystal bases of Verma modules for quantum affine Lie algebras*, Compos. Math. **92**(3) (1994), 299–325.
- [6] S.-J. Kang, M. Kashiwara, K. C. Misra, T. Miwa, T. Nakashima and A. Nakayashiki, *Affine crystals and vertex models*, Int. J. Mod. Phys. A. **7**(Suppl. 1A) (1992), 449–484.
- [7] ———, *Perfect crystals of quantum affine Lie algebras*, Duke Math. J. **68**(3) (1992), 499–607.
- [8] S.-J. Kang and J.-H. Kwon, *Fock space representations of quantum affine algebras and generalized Lascoux-Leclerc-Thibon algorithm*, J. Korean Math. Soc. **45**(4) (2008), 1135–1202.
- [9] S.-J. Kang and H. Lee, *Higher level affine crystals and Young walls*, Algebr. Represent. Theory **9**(6) (2006), 593–632.
- [10] S.-J. Kang and H. Lee, *Crystal bases for quantum affine algebras and Young walls*, J. Algebra **322**(6) (2009), 1979–1999.
- [11] M. Kashiwara, *Crystalizing the q -analogue of universal enveloping algebras*, Comm. Math. Phys. **133**(2) (1990), 249–260.
- [12] ———, *On crystal bases of the q -analogue of universal enveloping algebras*, Duke Math. J. **63**(2) (1991), 465–516.

- [13] A. Kuniba, K.C. Misra, M. Okado, T. Takagi and J. Uchiyama, *Crystals for Demazure modules of classical affine Lie algebras*, J. Algebra **208**(1) (1998), 185–215.
- [14] H. Lee, *Crystal $B(\infty)$ for Quantum Affine Algebras: A Young Wall Description*, Comm. Algebra **42**(10) (2014), 4509–4525.
- [15] G. Lusztig, *Canonical bases arising from quantized enveloping algebras*, J. Amer. Math. Soc. **3**(2) (1990), 447–498.
- [16] G. Lusztig, *Quivers, perverse sheaves, and quantized enveloping algebras*, J. Amer. Math. Soc. **4**(2) (1991), 365–421.
- [17] S.-J. Oh and E. Park, *Young walls and graded dimension formulas for finite quiver Hecke algebras of type $A_{2\ell}^{(2)}$ and $D_{\ell+1}^{(2)}$* , J. Algebraic Combin. **40**(4) (2014), 1077–1102.
- [18] A. Savage, *Geometric and combinatorial realizations of crystal graphs*, Algebr. Represent. Theory **9**(2) (2006), 161–199.

HARBIN ENGINEERING UNIVERSITY, HARBIN, CHINA
Email address: fanzhaobing@hrbeu.edu.cn

HARBIN ENGINEERING UNIVERSITY, HARBIN, CHINA
Email address: algebra@hrbeu.edu.cn

KOREA RESEARCH INSTITUTE OF ARTS AND MATHEMATICS, ASAN-SI, CHUNGCHEONGNAM-DO, 31551, KOREA
Email address: soccerkang@hotmail.com

GRADUATE SCHOOL OF EDUCATION, HANKUK UNIVERSITY OF FOREIGN STUDIES, SEOUL, 02450, KOREA
Email address: rocky777@hufs.ac.kr