

# On some random billiards in a tube with superdiffusion

Henk Bruin <sup>\*</sup>      Niels Kolenbrander <sup>†</sup>      Dalia Terhesiu <sup>‡</sup>

October 15, 2024

## Abstract

*We consider a class of random billiards in a tube, where reflection angles at collisions with the boundary of the tube are random variables rather than deterministic (and elastic) quantities. We obtain a (non-standard) Central Limit Theorem for the horizontal displacement of a particle, which marginally fails to have a second moment w.r.t. the invariant measure of the random billiard.*

*2000 Mathematics Subject Classification. Primary 37D50, Secondary 37A30, 60D05*

*Keywords and phrases. billiards, random billiards, limit law, non-Gaussian Central Limit Theorem*

## 1 Introduction

Our aim is to prove a (non standard) Central Limit Theorem for the horizontal displacement of a particle that moves horizontally, but in a random way, in an infinite strip (called the tube) of width  $W$  that has non-smooth boundaries. Classical billiards [5] have a two dimension phase space, parametrized by an angle post-collision  $\theta$  and a position  $r$  on the boundary of the billiard table, and the billiard map preserves the measure  $\frac{1}{2} \sin \theta dr d\theta$ . As explained in the sequel (see Lemma 7.1), the horizontal displacement does not have a second moment w.r.t. the invariant measure of the random billiard described below (a version of  $\frac{1}{2} \sin \theta dr d\theta$ ), and it is subject to superdiffusion. Furthermore, this is the only natural observable of the random billiard considered here.

In the random billiard model described in Section 2, we consider reflection angles at collisions with the boundary as random variables rather than deterministic (and elastic) quantities. This point of view was taken by Feres & Yablokshi [8] and Feres & Zhang [9, 10], who model this system by a Markov chain. We will model the boundary of the tube as covered by tiny so-called *microstructures*, which are pockets bounded by finitely many convex smooth curves with positive angles in between, see Section 2 for a precise description. We will compute the trajectories in these microstructures using the rules of deterministic, elastic billiards. The randomness is sitting only in the position of the microstructures on the boundary of the tube, i.e., the entrance point of the particle when it reaches the boundary of the tube is a random variable. This is motivated by the fact that the microstructures are tiny compared to the width  $W$  of the tube. Due to the sensitive dependence of billiard trajectories, it is unpredictable where in the microstructure the particle will enter next.

The effect of this randomization is that the two-dimensional classical billiard map is replaced by a piecewise expanding one-dimensional random map  $\Psi_{R_i}$  (modeling the passage through the  $i$ -th microstructure). The sequence  $(R_i)_{i \geq 1}$  can be thought of a sequence of independent random variables taking values in  $[0, 1]$ , distributed according to some probability measure  $\nu$  and representing the entry points into the microstructures, see Section 2 for a precise description. The

---

<sup>\*</sup>Faculty of Mathematics, University of Vienna, Oskar Morgensternplatz 1, 1090 Vienna, Austria; [henk.bruin@univie.ac.at](mailto:henk.bruin@univie.ac.at)

<sup>†</sup>Mathematisch Instituut, University of Leiden, University of Leiden, Einsteinweg 55, 2333 CC Leiden, The Netherlands [niels.kolenbrander@outlook.com](mailto:niels.kolenbrander@outlook.com)

<sup>‡</sup>Mathematisch Instituut, University of Leiden, Einsteinweg 55, 2333 CC Leiden, The Netherlands [daliaterhesiu@gmail.com](mailto:daliaterhesiu@gmail.com)

measure  $d\mu = \frac{1}{2} \sin \theta d\theta$  is invariant under  $\Psi_{R_i}$  for each  $R_i$  (this is the restriction of the usual billiard measure  $\frac{1}{2} \sin \theta d\theta dr$  (see [5]) to the open sides of the microstructures, and since this is independent of  $r$ , its marginal for  $\theta$  is preserved by  $\Psi_{R_i}$ ). Instead of modelling the random billiard by a Markov chain, we carry out the analysis in terms of a random dynamical systems (that is, a skew product) with expanding fiber maps, see Section 3 for a precise description. This will allow us to study the associated transfer operator (the analogue of the Markov operator for the involved Markov chain) using bounded variation (BV) spaces.

A crucial role in our analysis is played by the precise form of the randomization (as introduced in Section 3). In particular, this type of randomization will allow us to employ the usual Nagaev method for random dynamical systems for proving the desired limit theorem. The involved perturbed averaged operator  $P_t, t \in \mathbb{R}$  is introduced in Section 3 and the analysis is carried out in BV.

The main result of this paper is Theorem 1.1, which gives a Central Limit Theorem with nonstandard normalization for the global horizontal displacement  $X(\theta) = W/\tan \theta$  as function of the postcollision angle. Note that  $\mathbb{E}_\mu(X) = 0$ .

**Theorem 1.1.** *Write  $S_n X := \sum_{i=0}^{n-1} X_i$  where  $X_i = X \circ (\Psi_{R_i} \circ \dots \circ \Psi_{R_0})$ . Then  $\frac{S_n X}{\sqrt{n \log n}}$  converges in distribution to a Gaussian random variable with mean zero and variance  $W^2$  under the measure  $\nu^{\otimes \mathbb{Z}} \otimes \mu$ .*

Several limit theorems for random expanding dynamical systems, in particular the Central Limit Theorem with standard normalization, are obtained in [3, 6, 7] (see also references therein). As far as we know, the random billiard model treated here is the first example of a random dynamical system (also with an expanding map as a base map) characterized by superdiffusion (in the sense of Theorem 1.1).

**Structure of the paper.** In Section 2 we give a precise description of the model and record some needed technical results. In Section 3 we discuss the randomization, and the form of the transfer operator that comes with it. Section 4 contains the main variation estimates of the map  $\Psi_{R_i}$ . In Section 5 we give the continuity estimates for the transfer operator perturbed with the displacement function  $X$ , as needed for the Nagaev method. The spectral decomposition (in BV) of the averaged operator, along with Lasota-Yorke inequalities, is obtained in Section 6. In Section 7 we provide the proof of Theorem 1.1.

## 2 Definition of model and basic calculations

### 2.1 The tube

The *tube* is a bi-infinite strip  $\mathbb{R} \times [0, W]$ , bounded by two horizontal lines  $\ell_0 = \mathbb{R} \times \{0\}$  and  $\ell_W = \mathbb{R} \times \{W\}$  for some large  $W > 0$ . A particle moves with constant speed back and forth between  $\ell_0$  and  $\ell_W$ . When the particle reaches  $\ell_0$  or  $\ell_W$  for the  $i$ -th time, it enters a microstructure  $\mathcal{M}_i$ . It will bounce a **bounded** number of times inside  $\mathcal{M}_i$  before exiting and moving to the other side of the tube gaining a horizontal displacement  $X_i$ , see Figure 1.

**Remark 2.1.** *All angles will be between  $\ell_0$  or  $\ell_W$  (for  $\theta_i^{out}$ ) or tangent lines at collision points (for  $\theta_{i,j}$ ) and the outgoing trajectory. We use the direction of the parametrization, as in the Chernov & Markarian book [5], except that they use angles with the normal vectors, rather than with tangent lines, see Figure 2. This convention means that  $\ell_0$  is parametrized left-to-right and  $\ell_W$  is parametrized right-to-left, as shown already in Figure 1.*

Let us denote by  $h_i$  the map that assigns the  $i$ -th entrance coordinates  $(r_i^{in}, \theta_i^{in})$  to the previous exit coordinates  $(r_{i-1}^{out}, \theta_{i-1}^{out})$ . The arrows of  $\ell_0$  and  $\ell_W$  as depicted in Figure 1 follow this convention for the tube, but for the open side of the microstructures  $\mathcal{M}_i$ , the arrow should be reversed. The map  $h_i$  therefore has the form

$$\begin{cases} h_i(r_{i-1}^{out}, \theta_{i-1}^{out}) = (r_i^{in}, \theta_i^{in}) = (r_{i-1}^{out} - W/\tan \theta_i^{out}, \theta_i^{out}) \\ Dh_i = \begin{pmatrix} 1 & W/\sin^2 \theta_{i-1}^{out} \\ 0 & 1 \end{pmatrix}. \end{cases} \quad (1)$$

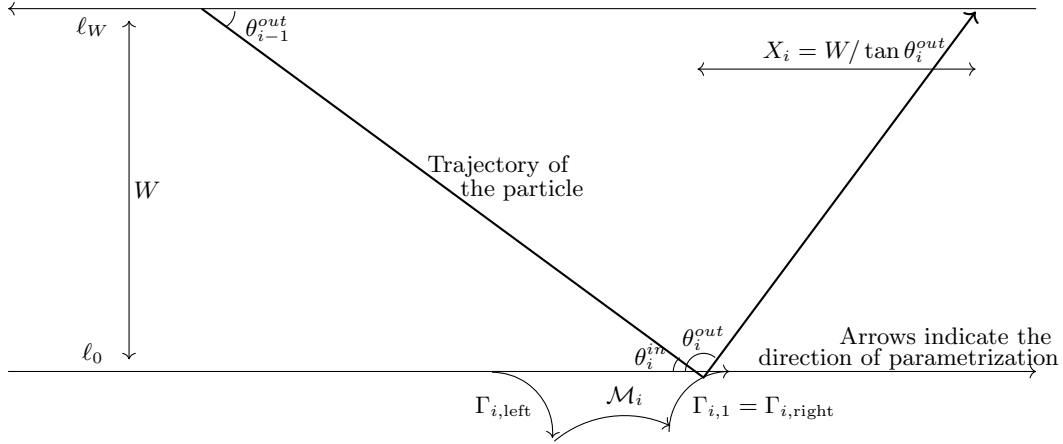

Figure 1: The tube with a piece of trajectory and microstructure  $\mathcal{M}_i$ .

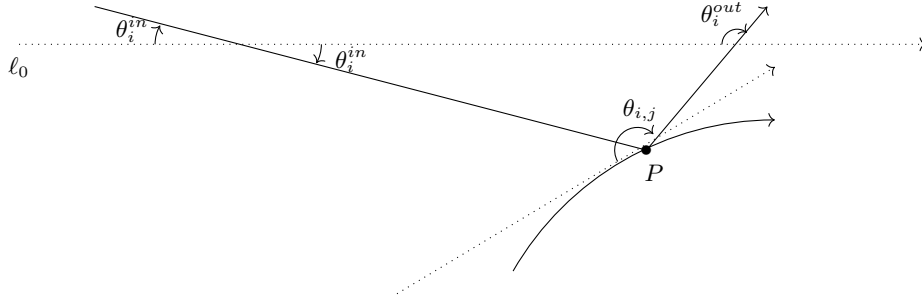

Figure 2: Convention for the angles  $\theta_i^{out}$ ,  $\theta_i^{in}$  and  $\theta_{i,j}$ .

Thus  $h_i$  represents the flight from the line  $\ell_W$  to  $\ell_0$  (or from  $\ell_0$  back to  $\ell_W$ ), and this flight has length  $\tau_i = W / \sin \theta_{i-1}^{out}$ . The term  $W / \sin^2 \theta_{i-1}^{out}$  in  $Dh_i$  in (1) expresses the effect of a change in  $\theta_{i-1}^{out}$  on the horizontal displacement at the entrance on the other side of the tube; it depends on  $W$  and even if it has no effect on  $\theta_i^{in}$ , it will have an important effect on the next collision points and angles.

## 2.2 The microstructures

The microstructure  $\mathcal{M}_i$  entered at the  $i$ -th visit of the boundary of the tube is an area of unit size, bounded by smooth convex segments  $\Gamma_{i,j}$ , where  $j = 1, \dots, n_i$  indicates the number of the collision of the particle with  $\partial\mathcal{M}_i$ , i.e., the particle first collides with  $\Gamma_{i,1}$ , next with  $\Gamma_{i,2}$ , etc. Let  $\Gamma_{i,0} \subset \partial\mathcal{M}_i$  be the open side of  $\mathcal{M}_i$ , so  $\Gamma_{i,0}$  belongs to  $\ell_0$  and  $\ell_W$ , alternatingly. The lengths  $|\Gamma_{i,0}| = 1$ . Let us use coordinates  $(r_i^{in}, \theta_i^{in}) \in \mathbb{R} \times (0, \pi)$ ,  $i \in \mathbb{Z}$ , for the entrance of the trajectory at the open side  $\Gamma_{i,0}$  of  $\mathcal{M}_i$ , and  $(r_i^{out}, \theta_i^{out})$  for the exit coordinates at  $\Gamma_{i,0}$ .

In accordance with Remark 2.1, the boundary pieces are parametrized by  $r$  oriented in such a way that  $\mathcal{M}_i$  is always to the left of the positively oriented tangent vector.

Let  $(r_{i,j}, \theta_{i,j})$  indicate the position and outgoing angle at the  $j$ -th collision with  $\partial\mathcal{M}_i$ . The angle  $\theta_{i,j}$  is measured with respect to the tangent line at the collision point  $\Gamma_{i,j}(r_{i,j})$  following the convention of Remark 2.1, so  $\theta_{i,j} \in [0, \pi]$ , with grazing collisions for  $\theta_{i,j} = 0$  or  $\pi$ . Note that

$$(r_i^{in}, \theta_i^{in}) = (r_{i,0}, \theta_{i,0}) \quad \text{and} \quad (r_i^{out}, \theta_i^{out}) = (r_{i,n_i}, \theta_{i,n_i}). \quad (2)$$

The curvatures corresponding to the collision points  $\Gamma_{i,j}(r_{i,j})$  are denoted as  $\kappa_{i,j}$ . The ‘‘open’’

side  $\Gamma_{i,0}$  of  $\partial\mathcal{M}_i$  is a straight arc, so  $\kappa_{i,0} = \kappa_{i,n_i} = 0$ .

For simplicity of exposition (so that we can interpret the system as a proper  $\mathbb{Z}$ -extension of a compact billiard system, see Remark 3.2), we assume that all microstructures have the same shape, but we will impose the following general conditions.

- (M1) All  $\Gamma_{i,j}$  are convex and there exist  $0 < \kappa_{\min} \leq \kappa_{\max} < \infty$  such that the curvature  $r \mapsto \kappa_{i,j}(r)$  are piecewise monotone functions bounded between  $\kappa_{\min}$  and  $\kappa_{\max}$ . Here  $r$  is the parameter parametrizing  $\Gamma_{i,j}$ .
- (M2) The curves  $\Gamma_{i,\text{left}}$  and  $\Gamma_{i,\text{right}}$  (called *left cheek* and *right cheek*) that are adjacent to the open side  $\Gamma_{i,0}$  of  $\mathcal{M}_i$  are circle segments tangent to the boundary of the tube.
- (M3) There is  $\gamma_0 > 0$  such that the angle  $\gamma$  between any neighbouring pair of curves (other than  $\Gamma_{i,0}$ ) satisfies  $\sin \gamma > \gamma_0$ .
- (M4) There is  $\alpha_0 < \frac{\pi}{2}$  such that the normal vectors on  $\Gamma_i$  pointing toward the tube have an angle  $\alpha \in [-\alpha_0, \alpha_0]$  with the vertical direction pointing towards the tube.

These assumptions imply that there is a uniform upper bound  $N$  in the number of collisions  $n_i$  that a particle can have before exiting  $\mathcal{M}_i$ , see Lemma 2.3 below. Assumption (M3) in this list prevents that  $\partial\mathcal{M}_i$  has cusps (essential for establishing the bound  $N$ ), and it also prevents that there are two grazing collisions (i.e.,  $\sin \theta_{i,j-1} = \sin \theta_{i,j} = 0$ ) with arbitrarily small intermediate flight time. A somewhat more technical version of this fact is stated in the next lemma; it is used this way later in Lemma 4.2.

**Lemma 2.2.** *Under Assumption (M3) above, there is  $K = K(\gamma_0) > 0$  such that*

$$\inf_{i,j} \tau_{i,j} \kappa_{i,j} \kappa_{i,j-1} + \kappa_{i,j-1} \sin \theta_{i,j} + \kappa_{i,j} \sin \theta_{i,j-1} \geq K. \quad (3)$$

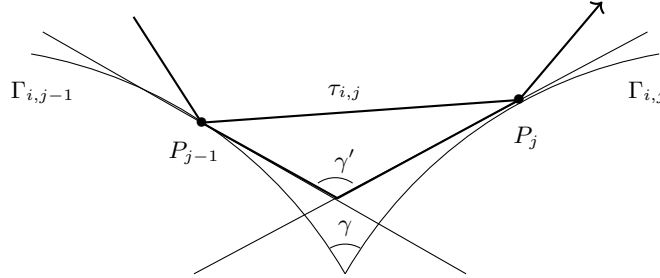

Figure 3: The triangle with angles  $\theta_{i,j-1}$ ,  $\theta_{i,j}$  and  $\gamma' > \gamma$ ,  $\sin \gamma > \gamma_0$ .

*Proof.* All curvatures  $\kappa_{i,j}$  are bounded away from zero, so the three terms in (3) are non-negative. Thus it suffices to show that no more than two of these terms can be arbitrarily small. Assume that the  $j$ -th flight-time  $\tau_{i,j}$  is very small. Then the  $j-1$ -st and  $j$ -th collision points  $P_{j-1}$  and  $P_j$  are on neighbouring arcs of  $\Gamma_i$ . Consider the triangle as in Figure 3; its angles are  $\pi - \theta_{i,j-1}$ ,  $\pi - \theta_{i,j}$  and  $\gamma'$  where  $\gamma' > \gamma$ , which is the angle between  $\Gamma_{i,j-1}$  and  $\Gamma_{i,j}$ . This angle  $\gamma' \rightarrow \gamma$  as  $\tau_{i,j} \rightarrow 0$ , so we can assume that  $\gamma' \leq (\pi + \gamma)/2$  for small  $\tau_{i,j}$ . Then  $\theta_{i,j-1} + \theta_{i,j} = \pi + \gamma' \leq (3\pi + \gamma)/2$  is bounded away from  $2\pi$ . Thus for small  $\tau_{i,j}$ , the angles  $\theta_{i,j-1}$  and  $\theta_{i,j}$  cannot be simultaneously close to  $\pi$ . The lemma follows from this.  $\square$

**Lemma 2.3.** *Under (M2) and (M4), the number of collisions during a visit to a microstructure is bounded.*

*Proof.* (M2) excludes cusps, so there are  $\varepsilon > 0$  and  $\delta > 0$  such that if  $\tau_{i,j} < \varepsilon$ , then the angle between the tangent lines at collision point  $r_{i,j-1}$  and  $r_{i,j}$  is at least  $\delta$ . This prevents a trajectory from having many consecutive collisions near a single corner point.

Let  $\psi_{i,j}$  be the angle of the outgoing trajectory from collision point  $r_{i,j}$  with the horizontal. We will assume that  $\cos \psi_{i,j} \geq 0$ ; otherwise we can look at the image under left-to-right reflection

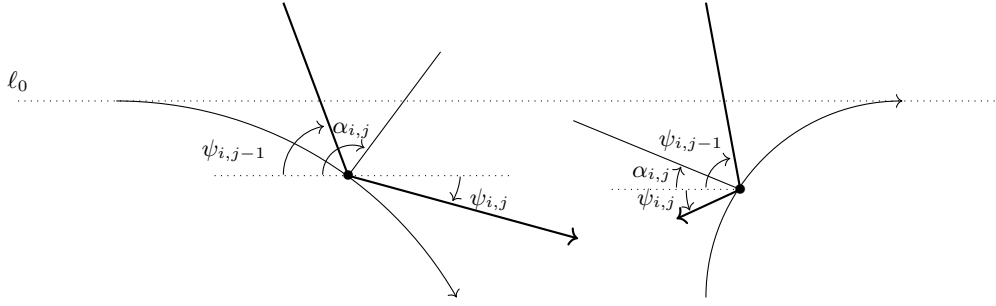

Figure 4: Rules 1. and 2. in the proof of Lemma 2.3.

and get the same result. Also assume that  $\sin \psi_{i,j} > 0$ , so the trajectory points away from the tube.

Let  $\alpha_{i,j}$  be the angle of the normal vector at  $r_{i,j}$  with the horizontal. By assumption,  $\alpha_{i,j} \in (0, \pi)$ . Recalling (M4), we have two cases, see Figure 4:

1. If  $\alpha_{i,j} \in [\frac{\pi}{2}, \frac{\pi}{2} + \alpha_0]$ , then  $\psi_{i,j-1} \geq \alpha_{i,j} - \frac{\pi}{2}$ . Therefore

$$\psi_{i,j} = \psi_{i,j-1} + 2(\alpha_{i,j} - \psi_{i,j-1}) - \pi \leq \psi_{i,j-1} + 2\frac{\pi}{2} - \pi = \psi_{i,j-1}.$$

This can happen without  $\psi_{i,j-1}$  actually decreasing, namely at a grazing collision when  $\psi_{i,j-1} = \alpha_{i,j} - \frac{\pi}{2}$ . But consecutive (almost) grazing collisions can only occur with a definite distance in between, according to Lemma 2.2, so after a bounded number of collisions,  $\psi_{i,j-1}$  will have decreased by a definite amount, or the other case occurs.

2. If  $\alpha_{i,j} \in [\frac{\pi}{2} - \alpha_0, \frac{\pi}{2})$ , then

$$\psi_{i,j} = -(\psi_{i,j-1} - 2(\psi_{i,j-1} - \alpha_{i,j})) = \psi_{i,j-1} - 2\alpha_{i,j} \leq \psi_{i,j-1} - (\pi - 2\alpha_0).$$

This means that starting with  $\psi_{i,0} \in (0, \pi)$ ,  $\psi_{i,j}$  will decrease with  $j$ , until, after a bounded number of steps,  $\psi_{i,j} < 0$  and the trajectory will move towards the tube again. From this point onward, we can use rules for the time-reversed trajectory. This leads to the claimed bounded number of collisions.  $\square$

## 2.3 Collision maps and their derivatives

We define a two-dimensional map

$$\Psi^i = (\Psi_r^i, \Psi_\theta^i) : (r_{i-1}^{out}, \theta_{i-1}^{out}) \mapsto (r_i^{out}, \theta_i^{out}), \quad (4)$$

mapping the exit coordinates of the previous microstructure  $\mathcal{M}_{i-1}$  to the exit coordinates of the current microstructure  $\mathcal{M}_i$ .

Let  $F_{i,j} : (r_{i,j-1}, \theta_{i,j-1}) \mapsto (r_{i,j}, \theta_{i,j})$  be the collision map and  $\tau_{i,j}$  the lengths of the flights involved. By (2.26) from the Chernov & Markarian book [5], we have

$$DF_{i,j} = \frac{-1}{\sin \theta_{i,j}} \begin{pmatrix} \tau_{i,j} \kappa_{i,j-1} + \sin \theta_{i,j-1} & \tau_{i,j} \\ \tau_{i,j} \kappa_{i,j} \kappa_{i,j-1} + \kappa_{i,j-1} \sin \theta_{i,j} + \kappa_{i,j} \sin \theta_{i,j-1} & \tau_{i,j} \kappa_{i,j} + \sin \theta_{i,j} \end{pmatrix}, \quad (5)$$

so apart from the initial minus sign, all the entries are positive. That is,  $\theta_{i,j}$  and  $r_{i,j}$  are decreasing functions, both of  $r_{i,j-1}$  and of  $\theta_{i,j-1}$ . Composing these collision maps shows that the signs of the corresponding derivatives satisfy

$$\operatorname{sgn} \frac{d\theta_{i,j-1}}{d\theta_{i-1}^{out}} = \operatorname{sgn} \frac{dr_{i,j-1}}{d\theta_{i-1}^{out}} = -\operatorname{sgn} \frac{d\theta_{i,j}}{d\theta_{i-1}^{out}} = -\operatorname{sgn} \frac{dr_{i,j}}{d\theta_{i-1}^{out}} \neq 0. \quad (6)$$

The map  $\Psi^i$  is obtained by composing the separate collision maps:

$$\Psi^i = F_{i,n_i} \circ \cdots \circ F_{i,1} \circ h_i.$$

**Remark 2.4.** The map  $h$  is not a collision map, because  $\ell_0$  and  $\ell_W$  are not part of the boundary of the billiard table. However, when composed with a collision map, the composition is in the form (5). Indeed, because  $\kappa_{i-1, n_{i-1}} = \kappa_{i,0} = 0$ ,

$$\begin{aligned} DF_{i,1} \cdot Dh_i &= \frac{-1}{\sin \theta_{i,1}} \begin{pmatrix} \sin \theta_{i,0} & \tau_{i,1} \\ \kappa_{i,1} \sin \theta_{i,0} & \tau_{i,1} \kappa_{i,1} + \sin \theta_{i,1} \end{pmatrix} \cdot \begin{pmatrix} 1 & \tau_i / \sin \theta_{i,0} \\ 0 & 1 \end{pmatrix} \\ &= \frac{-1}{\sin \theta_{i,1}} \begin{pmatrix} \sin \theta_{i,0} & \tau_i + \tau_{i,1} \\ \kappa_{i,1} \sin \theta_{i,0} & (\tau_i + \tau_{i,1}) \kappa_{i,1} + \sin \theta_{i,1} \end{pmatrix}, \end{aligned} \quad (7)$$

as is to be expected.

Now to get a lower bound for  $|\frac{d}{d\theta_{i-1}^{out}} \Psi_{\theta}^i(\theta_{i-1}^{out})|$ , necessary to prove that  $\Psi_{R_i}$  is expanding, we can look at the right bottom entry of the derivative matrix

$$\begin{aligned} D\Psi^i &= DF_{i, n_i} \cdots DF_{i,1} \cdot Dh_i \\ &= DF_{i, n_i} \cdots DF_{i,2} \cdot \frac{-1}{\sin \theta_{i,1}} \begin{pmatrix} \sin \theta_{i,0} & \tau_i + \tau_{i,1} \\ \kappa_{i,1} \sin \theta_{i,0} & (\tau_i + \tau_{i,1}) \kappa_{i,1} + \sin \theta_{i,1} \end{pmatrix}, \end{aligned} \quad (8)$$

where we used (7) to get the second line. Note that  $\tau_i = W / \sin \theta_i^{in}$ . Just multiplying the right bottom entries of each matrix and ignoring the factors  $-1$ , we obtain a term

$$\begin{aligned} \left(1 + \frac{(\tau_i + \tau_{i,0}) \kappa_{i,1}}{\sin \theta_{i,1}}\right) \prod_{j=2}^{n_i} \left(1 + \frac{\tau_{i,j} \kappa_{i,j}}{\sin \theta_{i,j}}\right) &\geq 1 + \frac{\tau_1 \kappa_1}{\max(\sin \theta_i^{in}, \sin \theta_i^{out})} \\ &\geq 1 + \frac{W \kappa_{i,1}}{\sin \theta_i^{in} \max(\sin \theta_i^{in}, \sin \theta_i^{out})}. \end{aligned} \quad (9)$$

The other terms all have the same sign, so the total derivative  $\frac{d}{d\theta_{i-1}^{out}} \Psi_{\theta}^i(\theta_{i-1}^{out})$  is only larger in absolute value.

The next lemma is necessary for the estimates of the variation of  $1/|\Psi'_{R_i}|$  done in Section 4. The map  $\Psi$  has discontinuities, caused by the particle having a grazing collision or hitting a corner of  $\mathcal{M}_i$ , but since there are only finitely many of those within any visit to a microstructure by our assumptions, the domain  $(0, \pi)$  of  $\Psi$  is partitioned into finitely many intervals  $J$  (called *pieces of continuity*) where  $\Psi$  is continuous (and in fact  $C^1$ -smooth). At boundary points,  $\Psi'_{R_i}$  is not properly defined, but since there are only finitely many of them, they can be ignored. However, also restricted to a piece of continuity,  $\Psi_{R_i}$  need not be monotone. So we will have to subdivide into maximal subintervals (called *domains of monotonicity*) where  $\Psi_{R_i}$  is monotone as well. A one-dimensional map is *piecewise monotone*, if there finitely many pieces of monotonicity.

**Lemma 2.5.** *The flight-times  $\tau_{i,j}$  as functions of  $\theta_{i-1}^{out}$  have at most two monotone branches on each piece of continuity.*

*Proof.* Recall that  $\Gamma_{i,j-1}$  and  $\Gamma_{i,j}$  are the pieces of the boundary of the  $i$ -th microstructure that the particle has its  $j-1$ -st and  $j$ -th collision with, namely at the collision points  $\Gamma_{i,j-1}(r_{i,j-1})$  and  $\Gamma_{i,j}(r_{i,j})$ . These  $r_{i,j-1}$  and  $r_{i,j}$  are functions of  $\theta_{i-1}^{out}$ , as are the outgoing angles  $\theta_{i,j-1}$  and  $\theta_{i,j}$  at these collision points. Let  $A_{i,j} := [\Gamma_{i,j-1}(r_{i,j-1}), \Gamma_{i,j}(r_{i,j})]$  be the straight arc between these two consecutive collision points, so the flight time  $\tau_{i,j} = |A_{i,j}|$  is also a function of  $\theta_{i-1}^{out}$ .

Assume by contradiction that  $\theta_{i-1}^{out} \mapsto \tau_{i,j}(\theta_{i-1}^{out})$  has at least three monotone branches on an interval where it is well-defined and continuous. Then there is a local maximum in the interior of this interval. Hence there is a pair of distinct angles  $\theta_{\pm}^{out}$  such that

$$\tau_{i,j}(\theta_{-}^{out}) = \tau_{i,j}(\theta_{+}^{out}) =: \hat{\tau}, \quad \text{and} \quad \tau_{i,j}(\theta_{i-1}^{out}) > \hat{\tau} \quad \text{for all } \theta_{i-1}^{out} \in (\theta_{-}^{out}, \theta_{+}^{out}). \quad (10)$$

Let  $r_{i,j-1}^{\pm} = r_{i,j-1}(\theta_{\pm}^{out})$ ,  $r_{i,j}^{\pm} = r_{i,j}(\theta_{\pm}^{out})$  and  $A^{\pm} = A_{i,j}(\theta_{\pm}^{out})$ . Also defined the straight arcs

$$A' = [\Gamma_{i,j-1}(r_{i,j-1}^{-}), \Gamma_{i,j-1}(r_{i,j-1}^{+})] \quad \text{and} \quad A'' = [\Gamma_{i,j}(r_{i,j}^{-}), \Gamma_{i,j}(r_{i,j}^{+})].$$

Then  $A^+$ ,  $A^-$ ,  $A'$  and  $A''$  define a quadrilateral  $Q$  with two equal sides, see Figure 5.

By convexity, the segment of  $\Gamma_{i,j-1}$  between  $\Gamma_{i,j-1}(r_{i,j-1}^{-})$  and  $\Gamma_{i,j-1}(r_{i,j-1}^{+})$  and the segment of  $\Gamma_{i,j}$  between  $\Gamma_{i,j}(r_{i,j}^{-})$  and  $\Gamma_{i,j}(r_{i,j}^{+})$  lie inside  $Q$ .

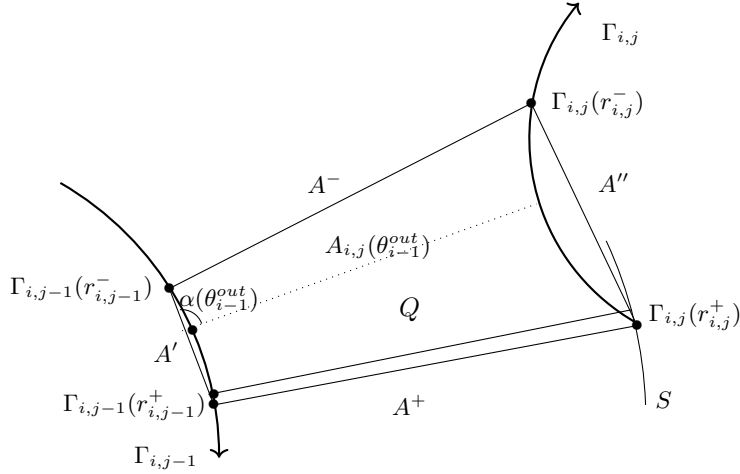

Figure 5: The quadrilateral  $Q$  in the proof, with  $|A^-| = |A^+| = \hat{\tau}$ .

Orient  $A'$  in the same way as  $\Gamma_{i,j-1}$ , and let  $\alpha(\theta_{i-1}^{out})$  be the angle between  $A'$  in its negative direction and  $A_{i,j}(\theta_{i-1}^{out})$ . Monotonicity of  $\theta_{i-1}^{out} \mapsto \theta_{i,j-1}(\theta_{i-1}^{out})$  together with the convexity of  $\Gamma_{i,j-1}$  imply that  $\theta_{i-1}^{out} \mapsto \alpha(\theta_{i-1}^{out})$  is monotone. Note that  $r_{i,j} \mapsto \alpha(\theta_{i-1}^{out}(r_{i,j}))$  is increasing, when we consider  $\alpha$  as function of  $r_{i,j}$ , namely by taking the inverse function of  $\theta_{i-1}^{out} \mapsto r_{i,j}(\theta_{i-1}^{out})$ , which is decreasing due to (6).

Let  $\alpha^\pm = \alpha(\theta_{i-1}^{\pm out})$ . The monotonicity of  $\theta_{i-1}^{out} \mapsto \alpha(\theta_{i-1}^{out})$  implies that  $|A'| < |A''|$ . As mentioned, the sides  $A^+$  and  $A^-$  have equal length  $\hat{\tau}$ .

Let  $\beta^\pm$  be the internal angles of  $Q$  where  $A''$  meets with  $A^\pm$ . Since  $|A''| > |A'|$ , the smallest of  $\beta^\pm$ , say  $\beta^+$ , is a sharp angle. Therefore, the arc  $A''$  near  $\Gamma_{i,j}(r_{i,j}^+)$  lies inside a circle of radius  $\hat{\tau}$  with center  $\Gamma_{i,j}(r_{i,j}^+)$ , see the blue circle segment  $S$  as in Figure 5.

Now take  $\alpha^\varepsilon = \alpha(\theta_{i-1}^{out} - \varepsilon) \in (\alpha^-, \alpha^+)$  and  $r_{i,j-1}^\varepsilon = r_{i,j-1}(\theta_{i-1}^{out} - \varepsilon)$  for a small  $\varepsilon > 0$ . Then it is impossible to fit a segment of length  $\hat{\tau}$  between  $\Gamma_{i,j}(r_{i,j}^+ - \varepsilon)$  and  $\Gamma_{i,j}$  at an angle  $\alpha^\varepsilon \in (\alpha^-, \alpha^+)$  with  $A'$ . So  $\tau_{i,j}(\theta_{i-1}^{out} - \varepsilon) < \hat{\tau}$ , contradicting (10). This proves the lemma.  $\square$

## 3 Randomization and transfer operators

### 3.1 Randomization

As mentioned in the beginning of Section 2, the randomness concerns the position of microstructure  $\mathcal{M}_i$  relative to the position  $r_i^{in}$  where the trajectory crosses the boundary of the tube, namely, the left endpoint of  $\mathcal{M}_i$  is randomized to

$$m_i = r_i^{in} - R_i, \quad (11)$$

where  $R_i$  are independent identically distributed random variables, distributed according to some probability measure  $\nu$  such that the Radon-Nikodým derivatives  $\frac{d\nu(R_i)}{d\text{Leb}}$  exist and are bounded. (One can think of a uniform distribution:  $R_i \simeq U([0, 1])$ .)

**Remark 3.1.** *This choice of randomization has the advantage that the trajectory and its derivatives still follow the rules of non-random elastic billiards. The randomization only affects where and with which angles the particle collides with the closed sides of microstructure  $\mathcal{M}_i$ . This randomization doesn't neglect the expansion and sensitivity of the past trajectory. In particular, it doesn't ignore the expansion built up due to the width of the tube, which the model considered in [9, 10] seems to ignore. Ignoring the size of the tube would be physically inconsistent with the fact that the width of the tube  $W$  features in the displacement  $X_i = W/\tan\theta_i^{out}$  after exiting  $\mathcal{M}_i$ . For us, a large value of  $W$  is crucial to get enough expansion for the Lasota-Yorke inequalities to hold.*

The random version of  $\Psi^i$  is a one-dimensional random map, denoted as:

$$\Psi_{R_i} : (0, \pi) \rightarrow (0, \pi), \quad \theta_{i-1}^{out} \mapsto \theta_i^{out}, \quad (12)$$

where  $R_i$  is the sequence of random variables introduced in (11). Independent of the value of  $R_i$ , we can use the equation before (9) to obtain

$$|\Psi'_{R_i}(\Psi_{R_i}^{-1}(\theta))| \geq 1 + \frac{W \kappa_{i,1}}{\sin \theta_i^{in} \max\{\sin \theta_i^{in}, \sin \theta_i^{out}\}}. \quad (13)$$

We can represent  $\Psi_{R_i}$  as a skew-product with fiber map  $\Psi_{R_0}$ , as follows

$$T : [0, 1]^{\mathbb{Z}} \times (0, \pi) \rightarrow [0, 1]^{\mathbb{Z}} \times (0, \pi), \quad T((R_i)_{i \in \mathbb{Z}}, \theta) = (\sigma((R_i)_{i \in \mathbb{Z}}), \Psi_{R_0}(\theta)), \quad (14)$$

where  $\sigma$  is the usual left shift. The infinite product measure  $\nu^{\otimes \mathbb{Z}}$  leaves on  $[0, 1]^{\mathbb{Z}}$  and is left shift invariant. The iterates of  $T^n$  are given by  $T^n((R_i)_{i \in \mathbb{Z}}, \theta) = (\sigma^n((R_i)_{i \in \mathbb{Z}}), \Psi_{R_{n-1}} \circ \dots \circ \Psi_{R_0}(\theta))$ .

The whole random billiards seen as a  $\mathbb{Z}$ -extension over a compact billiard table is given by the skew-product with one extra component  $k \in \mathbb{Z}$ :

$$((R_i)_{i \in \mathbb{Z}}, \theta, k) \mapsto (\sigma((R_i)_{i \in \mathbb{Z}}), \Psi_{R_0}(\theta), k + \xi(\theta)), \quad (15)$$

where  $\xi(\theta) = \lfloor (r_i^{out} - m_i) + W/\tan \theta \rfloor$ .

**Remark 3.2.** *Our results also hold if the shape of the microstructures are not all the same, but satisfy (M1)-(M4) in a uniform way, e.g., the lengths of the left and the right cheeks are uniformly bounded away from zero. For this, the maps  $\Psi$  not only depend on  $R_i$ , but also on the position  $k \in \mathbb{Z}$  in the tube that the microstructure  $\mathcal{M}_i$  that the trajectory exits from. That is, (15) becomes*

$$((R_i)_{i \in \mathbb{Z}}, \theta, k) \mapsto (\sigma((R_i)_{i \in \mathbb{Z}}), \Psi_{R_0, k}(\theta), k + \xi(\theta)), \quad (16)$$

### 3.2 Transfer operators (average and perturbed) and the BV space for one dimensional maps

Our transfer operators will be with respect to the invariant measure  $d\mu = \frac{1}{2} \sin \theta d\text{Leb}$  given by  $\int P_{R_i} f \cdot g d\mu = \int f \cdot g \circ \Psi_{R_i} d\mu$ .

In the random setting of  $\Psi_{R_i}$ ,  $i \in \mathbb{Z}$ , the pointwise formula for the transfer operator  $P_{R_i}$  (defined w.r.t.  $\mu$ ) takes the form

$$P_{R_i} f(\theta) = \sum_{\ell \in \Lambda} \frac{f(\Psi_{R_i}^{-1}(\theta)) \sin(\Psi_{R_i}^{-1}(\theta))}{|\Psi'_{R_i}(\Psi_{R_i}^{-1}(\theta))| \sin \theta} \mathbb{1}_{J_{\xi, \ell}}(\Psi_{R_i}^{-1} \theta) \quad (17)$$

where index  $\ell$  counts<sup>1</sup> the branches  $\Psi_{R_i}$  (this may be a different number for different values of  $R_i$ ). The average transfer operator is given by

$$Pf(\theta) = \int_0^1 \sum_{\ell \in \Lambda} \frac{f(\Psi_{R_i}^{-1}(\theta)) \sin(\Psi_{R_i}^{-1}(\theta))}{|\Psi'_{R_i}(\Psi_{R_i}^{-1}(\theta))| \sin \theta} \mathbb{1}_{J_{\xi, \ell}}(\Psi_{R_i}^{-1} \theta) d\nu(R_i). \quad (18)$$

**Remark 3.3.** *In (18) and throughout,  $\int_{[0,1]} \cdot d\nu(R_i)$  is shorthand for  $\int_{[0,1]^{\mathbb{Z}}} \cdot d\nu^{\otimes \mathbb{Z}}((R_j)_{j \in \mathbb{Z}})$ . This is justified because the integrand depends on  $R_i$  only and it is independent of  $R_j$ ,  $j \neq i$ .*

To obtain the desired limit theorem we consider a perturbed version of  $P$  by  $e^{itX}$ ,  $t \in \mathbb{R}$ , where  $X(\theta) = W/\tan(\theta)$ . The perturbed averaged operator is defined by

$$P_t f(\theta) = \int_0^1 P_{R_i} f(e^{itX})(\theta) d\nu(R_i). \quad (19)$$

We note that  $P_0 = P$ , as defined in (18).

---

<sup>1</sup>Recall that  $i$  counts the visits to microstructures.



We want to apply the usual Nagaev method to  $P_t$ . In this sense, we need to establish Lasota-Yorke inequalities and 'good' continuity estimates (as in Section 5 below) in BV for  $P_t$ . Here and throughout,

$$\|f\|_{BV} = \text{Var}(f) + \|f\|_\infty, \quad \text{Var}(f) = \inf_{g \sim f} \sup_{0=y_0 < \dots < y_k=1} \sum_{j=1}^k |g(y_j) - g(y_{j-1})|,$$

where  $g \sim f$  if  $f$  and  $g$  differ on a null set. Here and throughout,  $\text{Var}(f)$  denotes the variation of the (equivalence class) of  $f$ .

We record two inequalities that we shall use throughout without further comments. While it is clear that  $\|Pf(\theta)\|_\infty \leq \int_0^1 \|P_{R_i} f(\theta)\|_\infty d\nu(R_i)$ , we clarify that  $\text{Var}(Pf(\theta)) \leq \int_0^1 \text{Var}(P_{R_i} f(\theta)) d\nu(R_i)$ . The latter can be justified as follows

$$\begin{aligned} \text{Var}\left(\int_0^1 P_{R_i} f d\nu(R_i)\right) &= \int_0^\pi \left| \frac{d}{d\theta} \int_0^1 P_{R_i} f(\theta) d\nu(R_i) \right| d\theta \leq \int_0^\pi \int_0^1 \left| \frac{d}{d\theta} P_{R_i} f(\theta) \right| d\nu(R_i) d\theta \\ &= \int_0^1 \int_0^\pi \left| \frac{d}{d\theta} P_{R_i} f(\theta) \right| d\theta d\nu(R_i) = \int_0^1 \text{Var}(P_{R_i} f) d\nu(R_i). \end{aligned}$$

### 3.3 A classical estimate for near-grazing collisions

In the remainder of the paper we abbreviate systematically

$$\tilde{\theta} := \theta_{i-1}^{out} \quad \text{and} \quad \theta := \theta_i^{out} = \Psi_{R_i}(\tilde{\theta}). \quad (20)$$

We also introduce a threshold  $\eta > 0$  such that if  $\sin \tilde{\theta} < \eta$ , then there are only three collision patterns possible in the microstructure  $\mathcal{M}_i$ , namely (when the particle enters  $\mathcal{M}_i$  from the left) a single collision with the left cheek, a single collision with the right cheek, or a single collision with the left cheek followed by a collision with the right cheek. The latter we call a double collision. (If the particle enters  $\mathcal{M}_i$  from the right, then we have to swap the word "left" and "right", but there are still these three collision patterns.) It follows that  $\Psi_{R_i}$  has six branches on the region  $\sin \tilde{\theta} < \eta$ , three for  $\tilde{\theta}$  close to 0 and another three for  $\tilde{\theta}$  close to  $\pi$ .

The following lemma compares  $\sin \tilde{\theta}$  with  $\sin \theta$  in these cases. It comes basically from [14, Propositions 8 and 9], but we give a proof for transparency and completeness.

**Lemma 3.4.** *Given (M1) and (M2), there exists a constant  $C_\kappa > 0$  (depending only on  $\kappa$ ) such that when  $\sin \tilde{\theta} < \eta$ ,*

$$C_\kappa^{-1} \sin^2 \theta \leq \sin \tilde{\theta} \leq C_\kappa \sqrt{\sin \tilde{\theta}}. \quad (21)$$

This means that  $W(\sin \theta)^{-1/2} \ll \xi(\Psi_{R_i}^{-1}(\theta)) \ll W(\sin \theta)^{-2}$ , where  $\xi$  is the skew-function from (15). Also  $\sin \tilde{\theta} < \eta$  implies that  $\sin \theta < \sqrt{\eta C_\kappa}$ .

*Proof.* From Figure 6, for the collision with the right cheek we find  $\alpha = \beta + \theta - \frac{\pi}{2}$ ,  $(\pi - \theta) + \tilde{\theta} + 2\alpha = \pi$  and  $\frac{1}{\kappa}(1 - \cos \beta) = s \sin \tilde{\theta}$  for some  $s \in (0, 1)$ . Rearrangement gives  $\sin \beta = \sqrt{1 - \cos^2 \beta} \sim \sqrt{2\kappa s \sin \tilde{\theta}}$ , which combined with  $\pi - \theta = \tilde{\theta} + \beta \leq 2\beta$  gives  $\sin \theta = \sin(\pi - \theta) \sim \sqrt{8\kappa s \sin \tilde{\theta}} \leq \sqrt{8\kappa_{\max}} \sqrt{\sin \tilde{\theta}}$ . Swapping the role of  $\theta$  and  $\tilde{\theta}$  (that is, looking at the collision with the left cheek), gives the other inequality.

For the double cheek collision, we use notation and estimates from Figure 9, with  $\theta = \theta_i^{out}$ ,  $\tilde{\theta} = \theta_{i-1}^{out}$ ,  $\theta_1 = \theta_{i,1}$  and  $\theta_2 = \theta_{i,2}$ . Also  $\beta_1$  and  $\beta_2$  are the angles at the collision points with  $\Gamma_{i,1}$  and  $\Gamma_{i,2}$  with curvatures  $\kappa_1$  and  $\kappa_2$ , respectively.

We have

$$\begin{cases} \beta_1 + (\pi - \theta_1) = \tilde{\theta}, & \pi - \theta = \beta_2 + (\pi - \theta_2) \quad \text{and} \quad \beta_2 - (\pi - \theta_2) = (\pi - \theta_1) - \beta_1 \\ \frac{1}{\kappa_1}(1 - \cos \beta_1) \sim \frac{1}{\kappa_2}(1 - \cos \beta_2) + s \sin(\pi - \theta_1 - \beta_1) & \text{for } s \lesssim 1. \end{cases} \quad (22)$$

First assume that  $\beta_2 - (\pi - \theta_2) = \pi - \theta_1 - \beta_1 \geq 0$ , which means that the middle part of the trajectory in  $\mathcal{M}_i$  goes upwards, as in Figure 9. This means that

$$2\beta_1 \leq \beta_1 + (\pi - \theta_1) = \tilde{\theta} < 3\beta_1,$$

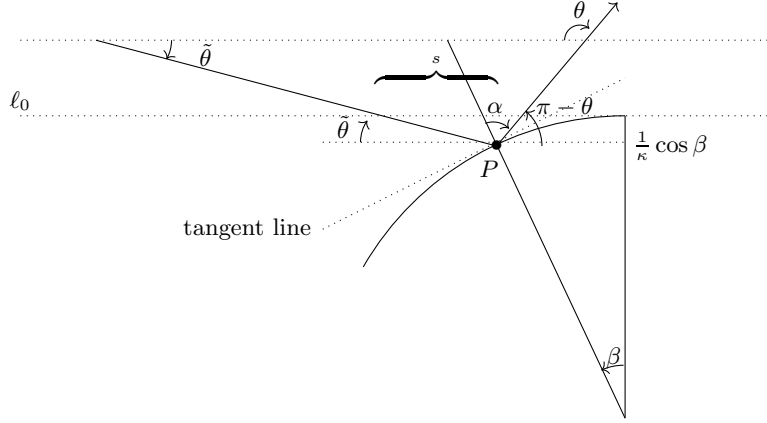

Figure 6: Comparing  $\theta$  to  $\tilde{\theta}$  for  $\sin \tilde{\theta} < \eta$  at a right cheek collision.

where the second inequality follows because  $s \sin(\pi - \theta_1 - \beta_1) \leq \frac{1}{\kappa_1}(1 - \cos \beta_1)$  to make a collision with  $\Gamma_{i,2}$  possible. Using the main term in the Taylor expansions of  $\cos$  and  $\sin$ , we can rewrite (22) to

$$\frac{\beta_1^2}{2\kappa_1} \sim \frac{\beta_2^2}{2\kappa_2} + \beta_2 - (\pi - \theta_2).$$

If  $\beta_2 - (\pi - \theta_1) \gtrsim \frac{\beta_2^2}{2\kappa_2}$ , then

$$\sin \tilde{\theta} \leq \sqrt{6\kappa\beta_2} \leq \sqrt{12\kappa_1} \sin \theta.$$

Otherwise,

$$\sin \tilde{\theta} \geq \sqrt{\frac{\kappa_1}{\kappa_2}} \beta_2 \geq \sqrt{\frac{\kappa_1}{\kappa_2}} \sin \theta.$$

If  $\beta_2 - (\pi - \theta_2) = \pi - \theta_1 - \beta_1 \leq 0$ , then we can reverse the roles of  $\tilde{\theta}$  and  $\theta$ , and the analogous inequalities follow.  $\square$

## 4 The variation of $1/|\Psi'_{R_i}|$

The horizontal displacement  $\xi \in \mathbb{Z}$  between microstructures  $\mathcal{M}_{i-1}$  and  $\mathcal{M}_i$  can in principle be arbitrary; for each there is an subinterval  $J_\xi \subset (0, \pi)$  such that  $\theta_{i-1}^{out} \in J_\xi$  means that  $\xi(\theta_{i-1}^{out}) = \xi$ . For each  $\xi \in \mathbb{Z}$ , since there is a bounded number of collisions in each microstructure  $\mathcal{M}_i$ , the number of piece of continuity of  $\Psi_{R_i}$  inside  $J_\xi$  is finite (and in fact three if  $|\xi|$  is large), but since there are infinitely many  $\xi \in \mathbb{Z}$ , the total number of pieces on which  $\Psi_{R_i}$  is continuous is infinite.

**Lemma 4.1.** *Assume (M3) and (M4). Let  $\Lambda_\eta = \Lambda_\eta(W, R_i)$  refer to the set of branches of  $\Psi_{R_i} : \tilde{\theta} \mapsto \theta$  on the subinterval of  $(0, \pi)$  where  $\sin \tilde{\theta} \geq \eta$ . There is  $C_\eta > 0$  such that  $\#\Lambda_\eta \leq C_\eta W$ .*

*Proof.* By the assumption on the microstructures, there is an upper bound  $N$  on the number of branches associated to a single microstructure  $\mathcal{M}_i$ . At angles  $\tilde{\theta}$  satisfying  $\sin \tilde{\theta} \geq \eta$ , only microstructures with displacement  $|\xi| \leq W/|\tan \tilde{\theta}| \leq W/\eta$  can be reached. So the lemma holds for  $C_\eta = N/\eta$ .  $\square$

From Lemma 2.5 we can derive that there are a bounded number of pieces of monotonicity inside each pieces of continuity  $J$ , and therefore  $\Psi_{R_i}|_J$  has bounded variation. Let  $I_\xi$  be the collection of branches associated to a displacement  $\xi$ , i.e.,  $\xi(\tilde{\theta}) = \xi$  for each  $\tilde{\theta} \in J_\xi$ . The next lemma estimates the variation of  $1/|\Psi'_{R_i}|$  restricted to each  $J_\xi$  for  $\sin \tilde{\theta} < \eta$  (which means large values of  $|\xi| \sim W/|\tan \tilde{\theta}|$ ), as function of  $\theta = \Psi_{R_i}(\tilde{\theta})$ . On each monotone branch of  $\Psi_{R_i}$ , the variation in  $\theta$  and in  $\tilde{\theta} = \Psi_{R_i}^{-1}$  are the same. Also, the variation of a monotone function  $\text{Var}(f) \leq 2\|f\|_\infty$ , or even  $\text{Var}(f) \leq \|f\|_\infty$  if  $f$  is non-negative. If  $f$  is non-negative with  $N$  monotone branches, then  $\text{Var}(f) \leq N\|f\|_\infty$ , which is why Lemma 2.5 is important in the next estimates.

**Lemma 4.2.** *Assume properties (M1), (M3) and (M4) of the microstructures. Then*

$$\text{Var}_\theta \left( \frac{1}{|\Psi'_{R_i}|} \Big|_{J_\xi} \right) = O(|\xi|^{-\frac{3}{2}}) \quad \text{as } |\xi| \rightarrow \infty.$$

*Proof.* Throughout this proof we suppress the index  $\tilde{\theta}$  in the variation, and also write  $R$  instead of  $R_i$ . Separating the entries with  $\tau_i + \tau_{i,1}$  and  $(\tau_i + \tau_{i,1})\kappa_{i,1} + \sin \theta_{i,1}$  in the rightmost matrix in (8), obtain

$$\begin{aligned} \Psi'_R|_{J_\xi} &= \frac{\tau_i + \tau_{i,1}}{-\sin \theta_{i,1}} \frac{\Omega(\sin \theta_{i,1}, \sin \theta_{i,2}, \dots, \sin \theta_{i,n_i-1}, \tau_i, \tau_{i,1}, \dots, \tau_{i,n_i}, \kappa_{i,1}, \dots, \kappa_{i,n_i})}{\prod_{j=2}^{n_i} (-\sin \theta_{i,j})} \\ &+ \frac{(\tau_i + \tau_{i,1})\kappa_{i,1} + \sin \theta_{i,1}}{-\sin \theta_{i,1}} \frac{\widehat{\Omega}(\sin \theta_{i,1}, \sin \theta_{i,2}, \dots, \sin \theta_{i,n_i-1}, \tau_i, \tau_{i,1}, \dots, \tau_{i,n_i}, \kappa_{i,1}, \dots, \kappa_{i,n_i})}{\prod_{j=2}^{n_i} (-\sin \theta_{i,j})} \\ &= \frac{(\tau_i + \tau_{i,1})\kappa_{i,1} + \sin \theta_{i,1}}{-\sin \theta_{i,1}} \times \\ &\left( \frac{\tau_i + \tau_{i,1}}{(\tau_i + \tau_{i,1})\kappa_{i,1} + \sin \theta_{i,1}} \frac{\Omega(\sin \theta_{i,1}, \sin \theta_{i,2}, \dots, \sin \theta_{i,n_i-1}, \tau_i, \tau_{i,1}, \dots, \tau_{i,n_i}, \kappa_{i,1}, \dots, \kappa_{i,n_i})}{\prod_{j=2}^{n_i} (-\sin \theta_{i,j})} \right. \\ &\left. + \frac{\widehat{\Omega}(\sin \theta_{i,1}, \sin \theta_{i,2}, \dots, \sin \theta_{i,n_i-1}, \tau_i, \tau_{i,1}, \dots, \tau_{i,n_i}, \kappa_{i,1}, \dots, \kappa_{i,n_i})}{\prod_{j=2}^{n_i} (-\sin \theta_{i,j})} \right), \end{aligned} \quad (23)$$

where  $\Omega$  and  $\widehat{\Omega}$  are a multivariate polynomials in their arguments. It follows that

$$\frac{1}{\Psi'_R|_{J_\xi}} = \frac{-\sin \theta_{i,1}}{(\tau_i + \tau_{i,1})\kappa_{i,1} + \sin \theta_{i,1}} \cdot \frac{\prod_{j=2}^{n_i} (-\sin \theta_{i,j})}{\frac{\tau_i + \tau_{i,1}}{(\tau_i + \tau_{i,1})\kappa_{i,1} + \sin \theta_{i,1}} \Omega + \widehat{\Omega}}. \quad (24)$$

By our assumptions (see Subsection 2.2), there are  $n_i \leq N$  collisions. So, every  $\Psi_{R_i}|_{J_\xi}$  has a uniform bounded number of pieces of continuity. Below we show that the variation of  $1/\Psi'_{R_i}$  on each of these pieces is  $O(1/W)$ .

Next, we use of the general formula

$$\begin{aligned} \text{Var} \left( \frac{g}{f} \right) &= \sup_{x_0 < x_1 < \dots < x_r} \sum_{j=1}^r \left| \frac{g(x_j)}{f(x_j)} - \frac{g(x_{j-1})}{f(x_{j-1})} \right| \\ &\leq \sup_{x_0 < x_1 < \dots < x_r} \sum_{j=1}^r \frac{|g(x_j)| |f(x_j) - f(x_{j-1})| + |g(x_{j-1})| |f(x_j) - f(x_{j-1})|}{|f(x_{j-1})f(x_j)|} \\ &\leq \frac{\sup |g| \text{Var}(f) + \sup |f| \text{Var}(g)}{\inf |f|^2}. \end{aligned} \quad (25)$$

Applying this for  $f = (\tau_i + \tau_{i,1})\kappa_{i,1} + \sin \theta_{i,1} \geq \sqrt{W^2 + \xi^2}$  and  $g = \sin \theta_{i,1}$ , we get

$$\begin{aligned} \text{Var} \left( \frac{-\sin \theta_{i,1}}{(\tau_i + \tau_{i,1})\kappa_{i,1} + \sin \theta_{i,1}} \Big|_{J_\xi} \right) &\leq \frac{1}{W^2 + \xi^2} \left( \sup |\sin \theta_{i,1}| \text{Var}((\tau_i + \tau_{i,1})\kappa_{i,1} + \sin \theta_{i,1}) \right. \\ &\quad \left. + \text{Var}(\sin \theta_{i,1}) \sup((\tau_i + \tau_{i,1})\kappa_{i,1} + \sin \theta_{i,1}) \right) \\ &\ll \frac{1}{W^2 + \xi^2} \left( \sqrt{\frac{W}{|\xi|}} + \sqrt{\frac{W}{|\xi|}} \sqrt{W^2 + \xi^2} \right) \quad \text{as } |\xi| \rightarrow \infty. \end{aligned}$$

This bound is summable over all displacements  $\xi \in \mathbb{Z}$ , and the best upper bound of the sum is independent of  $W$ . This makes  $\text{Var} \left( \frac{1}{|\Psi'|} \right) = O(1)$ .

It remains to show that the second factor in (24) has bounded variation and supremum.

The quotient  $\frac{\tau_i + \tau_{i,1}}{(\tau_i + \tau_{i,1})\kappa_{i,1} + \sin \theta_{i,1}}$  is bounded by  $\frac{1}{\kappa_{i,1}}$ , bounded away from zero, and has at most four branches, so the variation is bounded by  $4/\kappa_{\min}$ .

The factor  $\Omega = \sum_{\ell=1}^{L_i} \Omega_\ell = \sum_{\ell=1}^{L_i} \prod_{k=2}^{n_i} \Omega_{\ell,k}$ , where  $\Omega_{\ell,k}$  is one of the four entries of the  $2 \times 2$  matrix of  $DF_k$  (without the prefactor  $-1/\sin \theta_{i,j}$ ) in (5), and  $L_i$  is some bounded number, depending on the (bounded) number of collisions  $n_i$ . All these functions have bounded variation, so  $\text{Var}(\Omega) < \infty$ , independently of  $W$ . The same holds for  $\widehat{\Omega}$ . Therefore the denominator  $\frac{\tau_i + \tau_{i,1}}{(\tau_i + \tau_{i,1})\kappa_{i,1} + \sin \theta_{i,1}} \Omega + \Omega'$  has bounded variation, and so has the numerator  $\prod_{j=2}^{n_i} (-\sin \theta_{i,j})$ .

Next, we use (25) for  $f = \frac{\tau_i + \tau_{i,1}}{(\tau_i + \tau_{i,1})\kappa_{i,1} + \sin \theta_{i,1}} \Omega + \Omega'$  and  $g \equiv 1$ . For this, we need to show that  $\inf |f|$  is bounded away from zero. This infimum  $\inf |f|$  is positive because  $\Omega'$  has only positive terms, including

$$\prod_{k=2}^{n_i} (\tau_{i,k} \kappa_{i,k} \kappa_{i,k-1} + \kappa_{i,k-1} \sin \theta_{i,k} + \kappa_{i,k} \sin \theta_{i,k-1})$$

obtained from taking the left bottom entries of the  $DF_{i,k}$ ,  $k = 2, \dots, n_i$ , in (5). According to Lemma 2.2, this term is at least  $K^{n-1} > 0$  (recall that  $n_i \leq n < \infty$  by assumption). This ends the proof.  $\square$

An immediate consequence of Lemma 4.2 is

**Corollary 4.3.** *There is a constant  $C > 0$  such that for those  $\xi \sim W/\tan \tilde{\theta}$  corresponding to  $\sin \tilde{\theta} < \eta$ ,*

$$\text{Var}_\theta \left( \frac{\sin \tilde{\theta}}{|\Psi'_{R_i}(\tilde{\theta})|} \Big|_{J_\xi} \right) \leq C |\xi|^{-\frac{5}{2}}.$$

*Proof.* This follows from Lemma 4.2 with the multiplication with the factor  $\sin \tilde{\theta}$ , for which we notice that  $\text{Var}(\sin \tilde{\theta}|_{J_\xi}) \leq \sup_{\tilde{\theta} \in J_\xi} (\sin \tilde{\theta})$ .  $\square$

## 5 Continuity estimates

In this section, we obtain the needed continuity estimate for the perturbed average operator  $P_t$  defined in (19).

**Proposition 5.1.** *Let  $f \in BV$ . There exists  $C_{BV} > 0$  so that for all  $\theta \in (0, \pi)$  and all  $t \in \mathbb{R}$ ,*

$$\|(P_t - P_0)f\|_{BV} \leq C_{BV} |t| \|f\|_{BV}$$

The proof is carried out in the remainder of this section.

### 5.1 Continuity estimates using averaging for $\sin \theta < \eta$ .

Due to (M1)-(M4), the microstructures are shaped so that a visiting trajectory has only a bounded number of collisions, so the map  $\Psi_{R_i} : (0, \pi) \rightarrow (0, \pi)$  has finitely many branches **associated to a single** microstructure. However, every microstructure can be reached by taking  $\tilde{\theta} \in \Psi_{R_i}^{-1}(\theta)$  sufficiently close to 0 or  $\pi$ . Therefore  $\Psi_{R_i}$  has infinitely many branches, but the domains of these branches have only 0 and  $\pi$  as accumulation points. If  $\sin \tilde{\theta} < \eta$  where  $\eta$  is as in Lemma 3.4, i.e.,  $|\xi(\tilde{\theta})| \geq \xi_\eta \sim W/\eta$ , and if the particle enters  $\mathcal{M}_i$  from the left, then there are only three branches associated to each microstructure, representing trajectories that

1. collide only with the left “cheek” of the microstructure:  $\sin \theta < \sin \theta_{i,1} < \sin \tilde{\theta}$ ;
2. collide only with the right “cheek” of the microstructure:  $\sin \tilde{\theta} < \sin \theta_{i,1} < \sin \theta$ ;
3. collide once with the left “cheek” and once with the right “cheek” of the microstructure:  $\sin \theta_{i,1} < \sin \tilde{\theta}$  and  $\sin \theta_{i,2} < \sin \theta$ .

If the particle enters  $\mathcal{M}_i$  from the right, then the three above cases work with “left” and “right” swapped.

The derivative of those branches  $\geq W \kappa_{i,1} / \sin^2 \theta$  according to (9). In cases 1. and 2. this bound is sharp, in case 3. there is another factor  $\approx 1 + \frac{s \kappa_{i,2}}{\sin \theta_{i,2}}$  associated to the second reflection in the microstructure and  $s = \tau_{i,2} \approx 1$  (i.e., the width of the microstructure). Hence the derivative of the branch of case 3. is much larger.

### 5.1.1 Estimating without using averaging

Recall that  $X(\theta) = W/\tan \theta$  and that

$$P_{R_i} f \left( e^{itX} - 1 \right) (\theta) = \sum_{\ell \in \Lambda} \frac{f(\Psi_{R_i}^{-1}(\theta)) \sin(\Psi_{R_i}^{-1}(\theta)) \left( e^{itX(\Psi_{R_i}^{-1}(\theta))} - 1 \right)}{|\Psi'_{R_i}(\Psi_{R_i}^{-1}(\theta))| \sin \theta} \mathbb{1}_{J_{\xi, \ell}}(\Psi_{R_i}^{-1}(\theta)). \quad (26)$$

The continuity estimate of the transfer operator involves (17) with an extra factor  $|e^{itX} - 1| \leq |tX|$  for  $X = W/\tan \Psi_{R_i}^{-1}(\theta)$ . The estimate below suggests that without averaging, there is no hope to obtain the desired continuity estimate. For  $\sin \theta \rightarrow 0$ , using the only the “left cheek” branches where  $\sin \tilde{\theta} \geq \sin \theta_{i,1} \geq \sin \theta$  in (9), we obtain, say for a positive  $f$ :

$$\begin{aligned} \left| P_{R_i} f \left( e^{itX} - 1 \right) (\theta) \right| &\gg \sum_{\xi = W \max\{\frac{1}{\eta}, \frac{1}{\sqrt{C_\kappa \sin \theta}}\}}^{\frac{W}{\sin \theta}} \frac{f(\tilde{\theta}) \sin(\tilde{\theta}) |tW| \tan \tilde{\theta}}{|\Psi'_{R_i}(\tilde{\theta})| \sin \theta} \mathbb{1}_{\xi(\tilde{\theta})=\xi} \\ &\gg |tW| \sum_{\xi = W \max\{\frac{1}{\eta}, \frac{1}{\sqrt{C_\kappa \sin \theta}}\}}^{\frac{W}{\sin \theta}} \frac{f(\tilde{\theta}) |\cos(\tilde{\theta})|}{(W\kappa/\sin^2 \tilde{\theta}) \sin \theta} \mathbb{1}_{\xi(\tilde{\theta})=\xi} \\ &\gg |tW| \sum_{\xi = W \max\{\frac{1}{\eta}, \frac{1}{\sqrt{C_\kappa \sin \theta}}\}}^{\frac{W}{\sin \theta}} \frac{\sin^2 \tilde{\theta} f(\tilde{\theta})}{W\kappa \sin \theta} \mathbb{1}_{\xi(\tilde{\theta})=\xi} \\ &\gg \frac{|tW|}{\kappa_{\max} \sin \theta} \sum_{\xi = W \max\{\frac{1}{\eta}, \frac{1}{\sqrt{C_\kappa \sin \theta}}\}}^{\frac{W}{\sin \theta}} \frac{W}{\xi^2} f(\tilde{\theta}) \gg \inf |f| \frac{|t| \sqrt{C_\kappa} W}{2\kappa_{\max} \sqrt{\sin \theta}}, \end{aligned} \quad (27)$$

so this blows up as  $\sin \theta \rightarrow 0$ . This shows that the averaging in  $Pf$  is crucial to obtain a useful continuity estimate.

### 5.1.2 Estimates using averaging

The main idea of exploiting the averaging for small values of  $\sin \theta$  is that the integration over  $d\nu(R_i)$  will be over a small subinterval  $p(J_\xi, \tilde{\theta})$  of  $[0, 1]$ , which leads to a gain of a small factor  $\nu(p(J_\xi, \tilde{\theta}))$  inside the sum in (26). By our assumption on  $\nu$ , this is comparable to the length  $|p(J_\xi, \tilde{\theta})|$ , and this multiplication will lead to bounded sums, as argued below.

If the exit angle  $\theta = \theta_i^{out}$  is fixed, and the displacement  $|\xi| > \xi_\eta$ , then the inverse map  $\Psi_{R_i}^{-1}$  has only three branches. But not all entrance positions agree with these branches. Depending on whether we look at the left cheek branch  $J_{\xi, L}$ , double cheek branch  $J_{\xi, D}$  or right cheek branch  $J_{\xi, R}$ , there is a different interval of possible entrance positions. This means that a different subinterval  $p(J_{\xi, \cdot}, \tilde{\theta}) \subset [0, 1]$  of  $R_i$ -values such that the random shift of the position of  $\mathcal{M}_i$  realizes the required entrance.

In the following illustrating computation, all summands are non-negative, and thus, we can swap an integral and an infinite sum. Recall from Lemma 3.4 that  $\xi_\eta \sim W/\eta$  is a lower bound for the absolute value of all displacements when  $\sin \tilde{\theta} < \eta$ .

$$\begin{aligned} Pf(\theta) \Big|_{\{\sin \tilde{\theta} < \eta\}} &= \int_0^1 \sum_{\Lambda_\eta} \frac{f(\tilde{\theta})}{|\Psi'_{R_i}(\tilde{\theta})|} \frac{\sin \tilde{\theta}}{\sin \theta} \mathbb{1}_{J_{\xi, \ell}}(\tilde{\theta}) d\nu(R_i) \\ &= \int_0^1 \sum_{|\xi| \geq \xi_\eta} \sum_{\ell \in \{L, R, D\}} \frac{f(\tilde{\theta})}{|\Psi'_{R_i}(\tilde{\theta})|} \frac{\sin \tilde{\theta}}{\sin \theta} \mathbb{1}_{J_{\xi, \ell}}(\tilde{\theta}) d\nu(R_i) \\ &= \sum_{|\xi| \geq \xi_\eta} \sum_{\ell \in \{L, R, D\}} \int_0^1 \frac{f(\tilde{\theta})}{|\Psi'_{R_i}(\tilde{\theta})|} \frac{\sin \tilde{\theta}}{\sin \theta} \mathbb{1}_{J_{\xi, \ell}}(\tilde{\theta}) d\nu(R_i) \\ &= \sum_{|\xi| \geq \xi_\eta} \sum_{\ell \in \{L, R, D\}} \int_{p(J_{\xi, \ell}, \tilde{\theta})} \frac{f(\tilde{\theta})}{|\Psi'_{R_i}(\tilde{\theta})|} \frac{\sin \tilde{\theta}}{\sin \theta} \mathbb{1}_{J_{\xi, \ell}}(\tilde{\theta}) d\nu(R_i). \end{aligned} \quad (28)$$

The interval  $p = p(J_\xi, \tilde{\theta})$  is portrayed in Figure 7.

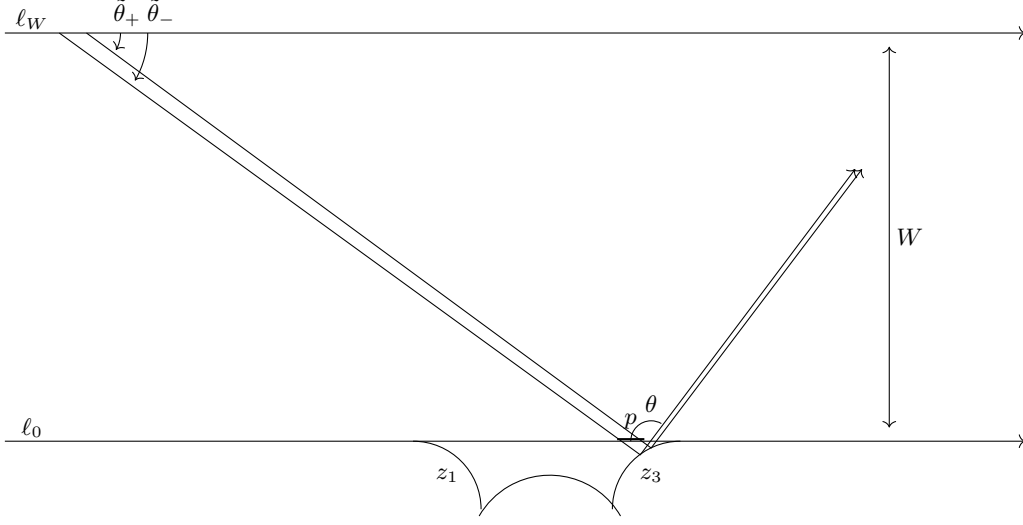

Figure 7: The interval  $p = p(J_\xi, \tilde{\theta}) \subset \Gamma_0$ . We took  $\sin \theta$  far from 0 to make the picture clearer.

In words, (28) tells us that estimating the integrand by its supremum (or its variation, if that is what we are interested in), we can replace the integral by a multiplication of  $\nu(p(J_{\xi,j}, \tilde{\theta})) \leq h^+ |p(J_{\xi,j}, \tilde{\theta})|$  for  $h^+ := \sup \frac{d\nu}{d\text{Leb}}$ , which will give the mentioned factor in the estimates of the sums. More precisely, using (28),

$$\begin{aligned} & \left\| P_{R_i} f \left( e^{itX} - 1 \right) \Big|_{\{\sin \tilde{\theta} < \eta\}} \right\|_\infty \\ & \leq \sup_\theta \sum_{\xi=W(C\kappa^{-1} \sin \theta)^{-1/2}}^{W(C\kappa \sin \theta)^{-2}} \left| \frac{f(\tilde{\theta}) \sin(\tilde{\theta}) |t|W/|\tan \tilde{\theta}|}{|\Psi'_{R_i}(\tilde{\theta})| \sin \theta} \right| \nu(p(J_\xi, \theta)) \mathbb{1}_{\xi(\tilde{\theta})=\xi}. \end{aligned} \quad (29)$$

A similar argument can be used to bound the variation, again starting from (28). The precise details are provided in Subsection 5.1.4.

Recall that  $p(J_{\xi,L/R}, \tilde{\theta})$  denotes the interval in  $[0, 1]$  obtained from looking at the left or right cheek branches, while  $p(J_{\xi,D}, \tilde{\theta})$  denotes the interval coming from looking at the double cheek branch.

**Lemma 5.2.** *The following estimates for the left, right and double cheek collisions hold:*

$$\nu(p(J_{\xi,\ell}, \tilde{\theta})) \leq h^+ |p(J_{\xi,\ell}, \tilde{\theta})| \leq \frac{h^+ \max\{|\tan \tilde{\theta}|^2 : \xi(\tilde{\theta}) = \xi\}}{2\kappa_{\min} W} \leq \frac{h^+ W}{2\kappa_{\min}} \frac{1}{(|\xi| - 1)^2},$$

where  $h^+ = \sup \frac{d\nu}{d\text{Leb}}$  and  $\ell \in \{L, R, D\}$ .

*Proof.* We start with the computation for the right cheek branch. Let  $\tilde{\theta}_+$  and  $\tilde{\theta}_-$  be the angles whose trajectories correspond to the end-points of  $p$ . The angles between the outgoing normal vectors with the vertical at the corresponding collision points at the left or right cheek of the microstructure are  $\beta_+$  and  $\beta_-$ . Let  $\alpha_+$  and  $\alpha_-$  be the angles that the outgoing trajectories makes with the normal vectors at the two collision points. Adding up the angles in the triangles  $APC$  and  $BPC$  in Figure 8 (and doing the same for the trajectory with incoming angle  $\tilde{\theta}_-$ ), we obtain

$$\begin{cases} \theta = 2\alpha_+ + \tilde{\theta}_+, & \alpha_+ = \beta_+ + \theta - \frac{\pi}{2}, \\ \theta = 2\alpha_- + \tilde{\theta}_-, & \alpha_- = \beta_- + \theta - \frac{\pi}{2}, \end{cases} \quad \text{and} \quad \left| \frac{W}{\tan \tilde{\theta}_+} - \frac{W}{\tan \tilde{\theta}_-} \right| \leq 1.$$

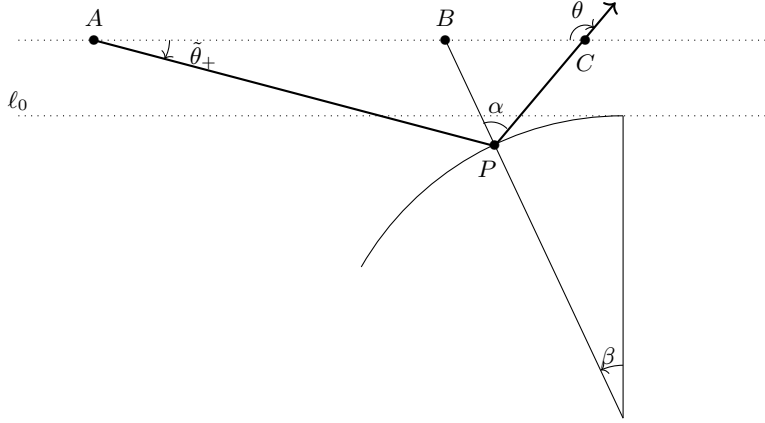

Figure 8: Relations between  $\alpha, \beta, \theta$  and  $\tilde{\theta}$ .

So

$$|\alpha_+ - \alpha_-| = |\beta_+ - \beta_-| = \frac{1}{2} |\tilde{\theta}_+ - \tilde{\theta}_-| \leq \frac{|\tan \tilde{\theta}^+ \tan \tilde{\theta}^-|}{2W}.$$

Thus, by (M2),

$$|p(J_{\xi, R}, \tilde{\theta})| \leq \left| \frac{\sin \beta_+}{\kappa} - \frac{\sin \beta_-}{\kappa} \right| \ll \frac{\max\{|\tan \tilde{\theta}|^2 : \xi(\tilde{\theta}) = \xi\}}{2\kappa W}.$$

The estimate for the left cheek branch is the same.

For the double cheek branch we have the following relations between the angles indicated in Figure 9 (where we abbreviated  $\theta_1 = \theta_{i,1}$  and  $\theta_2 = \theta_{i,2}$ ):

$$\tilde{\theta} = \beta_1 + (\pi - \theta_1), \quad \pi - \theta = \beta_2 + \pi - \theta_2, \quad \theta_1 - \beta_1 = \beta_2 - (\pi - \theta_2).$$

This gives  $\pi - \theta + \tilde{\theta} = 2(\beta_1 + \beta_2) =: 2\beta$ . As before, let  $\tilde{\theta}^\pm$  be angle corresponding to the left-most and right-most entrance positions satisfying  $\xi(\tilde{\theta}^+) = \xi(\tilde{\theta}^-) = \xi$ , and let  $\beta_1^\pm$  and  $\beta_2^\pm$  and  $\beta^\pm = \beta_1^\pm + \beta_2^\pm$  indicate the angle of the corresponding collision points. The collision points themselves satisfy  $r_{i,1} \sim \beta_1/\kappa_1$  and  $r_{i,2} \sim (\pi - \beta_2)/\kappa_2$  as arc-lengths of  $\Gamma_{i,1}$  and  $\Gamma_{i,2}$  with local curvatures  $\kappa_1$  and  $\kappa_2$ , respectively. Therefore

$$\operatorname{sgn} \frac{d\beta_1}{d\tilde{\theta}} = \operatorname{sgn} \frac{dr_{i,1}}{d\tilde{\theta}} = -\operatorname{sgn} \frac{dr_{i,2}}{d\tilde{\theta}} = \operatorname{sgn} \frac{d\beta_2}{d\tilde{\theta}}.$$

This shows that  $|\beta_1^+ - \beta_1^-| \leq |\beta^+ - \beta^-|$ .

As before  $\left| \frac{W}{\tan \tilde{\theta}^+} - \frac{W}{\tan \tilde{\theta}^-} \right| \leq 1$ . This gives, again due to (M2),

$$|p(J_{\xi, D}, \tilde{\theta})| \leq \frac{|\sin \beta_1^+ - \sin \beta_1^-|}{\kappa_1} \leq \frac{|\beta_2 - \beta_1|}{\kappa_1} \leq \frac{|\tilde{\theta}^+ - \tilde{\theta}^-|}{2\kappa_1} \leq \frac{\max\{|\tan \tilde{\theta}|^2 : \xi(\tilde{\theta}) = \xi\}}{2\kappa_{\min} W}.$$

Finally, we estimate the  $\nu$ -measure of the interval  $p(J_{\xi, R/L/D}, \tilde{\theta})$  by  $h^+ |p(J_{\xi, R/L/D}, \tilde{\theta})|$ , and recall that  $|\tan \tilde{\theta}| \leq W/(|\xi(\tilde{\theta})| - 1)$ .  $\square$

### 5.1.3 Estimating the $\|\cdot\|_\infty$ norm

**Lemma 5.3.** *Assume  $\sin \tilde{\theta} = \sin \Psi_{R_i}^{-1}(\theta) < \eta$ . There exists  $C_\infty > 0$  (independent of  $\theta$ ) so that for all  $t \in \mathbb{R}$  and  $f \in BV$ ,*

$$\left\| (P_t - P_0)f|_{\{\sin \tilde{\theta} < \eta\}} \right\|_\infty \leq C_\infty |t| \|f\|_\infty.$$

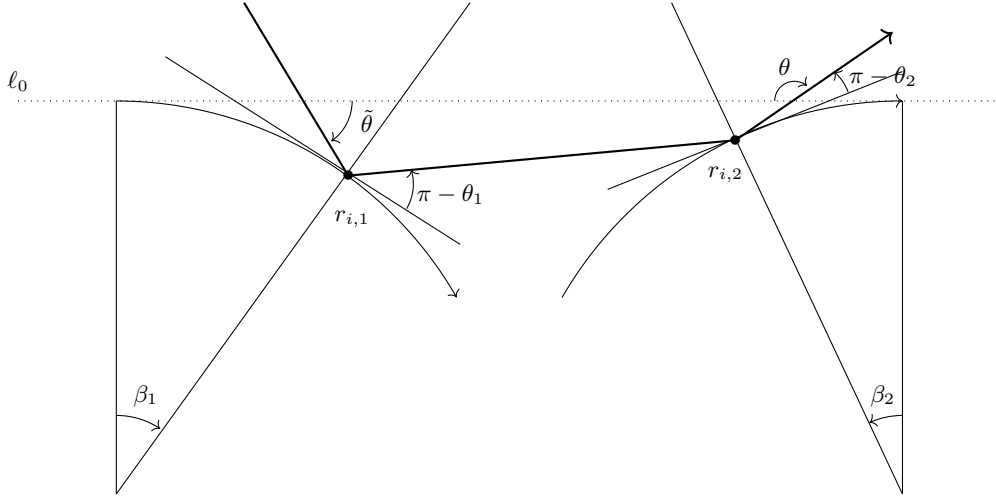

Figure 9: Relations between  $\beta_1, \beta_2, \theta_1, \theta_2, \theta$  and  $\tilde{\theta}$ .

*Proof.* Formula (29) tells us that we have an extra factor  $\nu(p(J_\xi, \tilde{\theta}))$  in each term of (27). We split the sum according to the type of trajectory inside the microstructure. If the inward trajectory (approaching  $\ell_0 \cap \mathcal{M}_i$  from the left) first hits the left cheek and then exits, then  $\sin \theta \leq \sin \tilde{\theta}$ . If the trajectory first hits the right cheek and then exits, then  $\sin \tilde{\theta} \leq \sin \theta$ . As a result, for fixed  $\theta$ , the ranges of  $\sin \tilde{\theta}$  are adjacent subintervals of  $[C_\kappa \sin^2 \theta, \sin \theta]$  for the left cheek, and  $[\sin \theta, C_\kappa \sqrt{\sin \theta}]$  for the right cheek, and hence the boundaries of the sums for these cheeks in the computation below overlap only for  $W/\sin \theta$ .

If there is a collision with both cheeks, then we can still compare  $\sin \tilde{\theta}$  and  $\sin \theta$  according to Lemma 3.4, but we have  $\sin \theta_{i,1} < \sin \tilde{\theta}$  and  $\sin \theta_{i,2} < \sin \theta$ , and also  $|\Psi'_{R_i}|$  has an extra factor  $\geq \tau_{i,1} \kappa_{i,1} / \sin \theta_{i,2} \geq \frac{\kappa_{\min}}{2 \sin \theta}$ . This leads to three cases in the estimate of the derivative of (9) and



therefore three sums in the estimate  $P(f \cdot |e^{iX} - 1|)(\theta)$ , as follows:

$$\begin{aligned}
|P(f \cdot |e^{iX} - 1|)(\theta)| &\ll \frac{|t|W}{2\kappa_{\min}W} \sum_{\xi=W \max\{\frac{1}{\eta}, \frac{1}{\sqrt{C_\kappa \sin \theta}}\}}^{\frac{W}{\sin \theta}} \frac{|\tan \tilde{\theta}|^2 |f(\tilde{\theta})| |\cos \tilde{\theta}|}{\frac{W\kappa_{\min}}{\sin^2 \tilde{\theta}} \sin \theta} \mathbb{1}_{\xi(\tilde{\theta})=\xi} && \text{(left cheek)} \\
&+ \frac{|t|W}{2\kappa_{\min}W} \sum_{\xi=W \max\{\frac{1}{\eta}, \frac{1}{\sin \theta}\}}^{\frac{W}{C_\kappa \sin^2 \theta}} \frac{|\tan \tilde{\theta}|^2 |f(\tilde{\theta})| |\cos \tilde{\theta}|}{\frac{W\kappa_{\min}}{\sin \theta \sin \tilde{\theta}} \sin \theta} \mathbb{1}_{\xi(\tilde{\theta})=\xi} && \text{(right cheek)} \\
&+ \frac{|t|W}{2\kappa_{\min}W} \sum_{\xi=W \max\{\frac{1}{\eta}, \frac{1}{\sqrt{C_\kappa \sin \theta}}\}}^{\frac{W}{C_\kappa \sin \theta}} \frac{|\tan \tilde{\theta}|^2 |f(\tilde{\theta})| |\sin \tilde{\theta}|}{\frac{2W\kappa_{\min}^2}{\sin^2 \tilde{\theta} \sin \theta} \sin \theta |\tan \tilde{\theta}|} \mathbb{1}_{\xi(\tilde{\theta})=\xi} && \text{(double cheek)} \\
&= \frac{|t|W^3}{\kappa_{\min}^2 \sin \theta} \sum_{\xi=W \max\{\frac{1}{\eta}, \frac{1}{\sqrt{C_\kappa \sin \theta}}\}}^{\frac{W}{\sin \theta}} \frac{|\sin \tilde{\theta}|^4 |f(\tilde{\theta})|}{W^4} \mathbb{1}_{\xi(\tilde{\theta})=\xi} \\
&+ \frac{|t|W^2}{\kappa_{\min}^2} \sum_{\xi=W \max\{\frac{1}{\eta}, \frac{1}{\sin \theta}\}}^{\frac{W}{C_\kappa \sin^2 \theta}} \frac{|\tan \tilde{\theta}|^3 |f(\tilde{\theta})|}{W^3} \mathbb{1}_{\xi(\tilde{\theta})=\xi} \\
&+ \frac{|t|W^3}{2\kappa_{\min}^3} \sum_{\xi=W \max\{\frac{1}{\eta}, \frac{1}{\sqrt{C_\kappa \sin \theta}}\}}^{\frac{W}{C_\kappa \sin^2 \theta}} \frac{|\tan \tilde{\theta}|^4 |f(\tilde{\theta})|}{W^4} \mathbb{1}_{\xi(\tilde{\theta})=\xi} \\
&\ll \frac{|t|W^3 \|f\|_\infty}{\kappa_{\min}^2 \sin \theta} \sum_{\xi=W \max\{\frac{1}{\eta}, \frac{1}{\sqrt{C_\kappa \sin \theta}}\}}^{\frac{W}{\sin \theta}} \frac{1}{|\xi|^4} + \frac{|t|W^2 \|f\|_\infty}{\kappa_{\min}^2} \sum_{\max\{\xi, \frac{W}{\sin \theta}\}}^{W(C_\kappa^{-1} \sin \theta)^{-2}} \frac{1}{\xi^3} \\
&+ \frac{|t|W^3 \|f\|_\infty}{2\kappa_{\min}^3} \sum_{\xi=W \max\{\frac{1}{\eta}, \frac{1}{\sqrt{C_\kappa \sin \theta}}\}}^{\frac{W}{C_\kappa \sin^2 \theta}} \frac{1}{\xi^4} \\
&\leq \frac{|t| \|f\|_\infty}{\kappa_{\min}^2} \left( \frac{C_\kappa \eta}{3} + \frac{\eta^2}{2} + \frac{\eta^3}{3\kappa_{\min}} \right),
\end{aligned}$$

so taking  $C_\infty = \frac{\eta}{2\kappa_{\min}^2} \left( \frac{C_\kappa}{3} + \frac{\eta}{2} + \frac{\eta^2}{3\kappa_{\min}} \right)$  gives the lemma.  $\square$

### 5.1.4 Estimating the variation

**Lemma 5.4.** *Assume  $\sin \theta < \eta$ . Let  $f \in BV$ . There exists  $C_{Var} > 0$  (independent of  $\theta$ ) so that for all  $t \in \mathbb{R}$ ,*

$$\text{Var}_\theta \left( (P_t - P_0) f|_{\{\sin \tilde{\theta} < \eta\}} \right) \leq C_{Var} |t| \|f\|_{BV}.$$

*Proof.* We first obtain a general bound for the variation starting from (28).

$$\begin{aligned}
&\text{Var}_\theta (P f(e^{itX} - 1)|_{\{\sin \tilde{\theta} < \eta\}}) \\
&= \text{Var}_\theta \left( \sum_{|\xi| \geq \xi_\eta} \sum_{\ell \in \{L, R, D\}} \int_{p(J_{\xi, \ell}, \tilde{\theta})} \frac{f(\tilde{\theta})}{|\Psi'_{R_i}(\tilde{\theta})|} \frac{\sin \tilde{\theta}}{\sin \theta} (e^{itX(\tilde{\theta})} - 1) \mathbb{1}_{J_{\xi, \ell}}(\tilde{\theta}) d\nu(R_i) \right) \\
&\leq \sum_{|\xi| \geq \xi_\eta} \sum_{\ell \in \{L, R, D\}} \text{Var}_\theta \left( \int_{p(J_{\xi, \ell}, \tilde{\theta})} \frac{f(\tilde{\theta})}{|\Psi'_{R_i}(\tilde{\theta})|} \frac{\sin \tilde{\theta}}{\sin \theta} (e^{itX(\tilde{\theta})} - 1) \mathbb{1}_{J_{\xi, \ell}}(\tilde{\theta}) d\nu(R_i) \right).
\end{aligned}$$

The integral is over  $R_i$ , not  $\theta$ , and for each  $(\xi, \ell)$ , the set  $\Theta_{\xi, \ell} = \bigcup_{R_i} \Psi_{R_i}(J_{\xi, \ell})$  (where the union only runs over those  $R_i \in [0, 1]$  for which the branch  $J_{\xi, \ell}$  actually exists) is an interval of length  $O(\sqrt{1/|\xi|})$ , according to Lemma 3.4. This is too long for our purpose.

However, for each pair  $(\xi, \ell)$ , and  $\tilde{\theta}$  with  $\xi(\tilde{\theta}) = \xi$ , the measure  $\nu(p(J_{\xi, \ell}, \tilde{\theta})) \leq \frac{h^+ W}{2\kappa_{\min}(|\xi| - 1)^2}$  by Lemma 5.2. Also, the interval  $p(J_{\xi, \ell}, \tilde{\theta})$  moves continuously in  $\tilde{\theta}$ . Therefore, if  $\Theta_{\xi, \ell, k}$  is a sufficiently small neighbourhood of  $\theta = \Psi_{R_i}(\tilde{\theta})$ , and we set

$$p(\xi, \ell, k) = \left\{ R_i \in [0, 1] : R_i \in p(J_{\xi, \ell}, \tilde{\theta}) \text{ for some } \tilde{\theta} \text{ with } \Psi_{R_i}(\tilde{\theta}) \in \Theta_{\xi, \ell, k} \right\},$$

then we can assure that  $\nu(p(\xi, \ell, k))$  is about four times as big, say  $\frac{h^+ W}{\kappa_{\min} \xi^2} \leq \nu(p(\xi, \ell, k)) \leq \frac{2h^+ W}{\kappa_{\min} \xi^2}$ . The derivative of the corresponding branch  $\Psi_{R_i}$  is bounded away from zero, and therefore we can partition  $\Theta_{\xi, \ell}$  into finitely many subintervals  $\Theta_{\xi, \ell, k}$  (i.e., for  $k$  in a finite index set  $K_{\xi, \ell}$ ) such that  $\nu(p(\xi, \ell, k)) \leq \frac{h^+ W}{\kappa_{\min} |\xi|^2}$  for each  $k \in K_{\xi, \ell}$ . Then

$$\begin{aligned} & \text{Var}_{\theta} \left( \int_{p(J_{\xi, \ell}, \tilde{\theta})} \frac{f(\tilde{\theta})}{|\Psi'_{R_i}(\tilde{\theta})|} \frac{\sin \tilde{\theta}}{\sin \theta} (e^{itX(\tilde{\theta})} - 1) \mathbb{1}_{J_{\xi, \ell}}(\tilde{\theta}) d\nu(R_i) \right) \\ &= \sum_{k \in K_{\xi, \ell}} \text{Var}_{\theta} \left( \int_{p(\xi, \ell, k)} \frac{f(\tilde{\theta})}{|\Psi'_{R_i}(\tilde{\theta})|} \frac{\sin \tilde{\theta}}{\sin \theta} (e^{itX(\tilde{\theta})} - 1) \mathbb{1}_{\Theta_{\xi, \ell, k}} \circ \Psi_{R_i}(\tilde{\theta}) d\nu(R_i) \right) \\ &\leq \frac{2h^+ W}{\kappa_{\min} \xi^2} \sum_{k \in K_{\xi, \ell}} \sup_{R_i \in p(\xi, \ell, k)} \text{Var}_{\theta} \left( \frac{f(\tilde{\theta})}{|\Psi'_{R_i}(\tilde{\theta})|} \frac{\sin \tilde{\theta}}{\sin \theta} (e^{itX(\tilde{\theta})} - 1) \mathbb{1}_{\Theta_{\xi, \ell, k}} \circ \Psi_{R_i}(\tilde{\theta}) \right) \\ &\leq \frac{C_p W}{\xi^2} \sum_{k \in K_{\xi, \ell}} \sup_{R_i \in [0, 1]} \text{Var}_{\theta} \left( \frac{f(\tilde{\theta})}{|\Psi'_{R_i}(\tilde{\theta})|} \frac{\sin \tilde{\theta}}{\sin \theta} (e^{itX(\tilde{\theta})} - 1) \mathbb{1}_{\Theta_{\xi, \ell, k}} \circ \Psi_{R_i}(\tilde{\theta}) \right), \end{aligned} \quad (30)$$

for some  $C_p$  independent of  $\xi$  and  $W$ . Let  $J_{\xi, \ell, k} = \{\tilde{\theta} \in J_{\xi, \ell} : \Psi_{R_i}(\tilde{\theta}) \in \Theta_{\xi, \ell, k}\}$ . These intervals depend on  $R_i$ , but in order not to overload the notation even more, we will suppress this dependence.

The map  $\Psi_{R_i}|_{J_{\xi, \ell}}$  is monotone for each  $|\xi| \geq \xi_{\eta}$ ,  $\ell \in \{L, R, D\}$ . So, if we split the above into parts depending on  $\tilde{\theta} \in J_{\xi, \ell}$  and  $\theta = \Psi_{R_i}(\tilde{\theta})$ , we can look at the variation in  $\tilde{\theta}$ :

$$\begin{aligned} & \text{Var}_{\theta} \left( \frac{f(\tilde{\theta})}{|\Psi'_{R_i}(\tilde{\theta})|} \frac{\sin \tilde{\theta}}{\sin \theta} (e^{-tX(\tilde{\theta})} - 1) \mathbb{1}_{J_{\xi, \ell, k}}(\tilde{\theta}) \right) \\ &= \text{Var}_{\theta} \left( \frac{1}{\sin \theta} \Big|_{\Theta_{\xi, \ell, k}} \right) \sup_{\tilde{\theta} \in J_{\xi, \ell, k}} \left| \frac{f(\tilde{\theta})}{|\Psi'_{R_i}(\tilde{\theta})|} \sin \tilde{\theta} (e^{itX(\tilde{\theta})} - 1) \right| \\ &\quad + \sup_{\theta \in \Theta_{\xi, \ell, k}} \frac{1}{\sin \theta} \text{Var}_{\tilde{\theta} \in J_{\xi, \ell, k}} \left( \frac{f(\tilde{\theta})}{|\Psi'_{R_i}(\tilde{\theta})|} \sin \tilde{\theta} (e^{itX(\tilde{\theta})} - 1) \right) \\ &= I_{\xi, \ell, k}(f) + II_{\xi, \ell, k}(f), \end{aligned} \quad (31)$$

and we estimate the sums of  $I_{\xi, \ell, k}$  and  $II_{\xi, \ell, k}$  over  $k \in K_{\xi, \ell}$ .

We start with  $I_{\xi, \ell, k}$  in (31). As  $\theta \rightarrow \frac{1}{\sin \theta}$  is monotone on  $\Psi_{R_i}(J_{\xi, \ell})$ , and keeping in mind that the sum of variations of a continuous function over adjacent intervals is the variation over the union of those intervals, we have

$$\sum_{k \in K_{\xi, \ell}} \sup_{R_i \in p(\xi, \ell, k)} \text{Var}_{\theta} \left( \frac{1}{\sin \theta} \Big|_{\Psi_{R_i}(J_{\xi, \ell})} \right) \leq \sup_{\theta \in \Psi_{R_i}(J_{\xi, \ell})} \frac{1}{\sin \theta}.$$

Hence, the first term in (31) contains only suprema, and can be bounded by  $|t| \kappa_{\min}^{-2} \|f\|_{\infty}$  using the computation similar to the one used in Lemma 5.3. More precisely, recall from (13) that  $\frac{1}{|\Psi'_{R_i}(\tilde{\theta})|} \leq \frac{\sin \theta_i^{in} \max\{\sin \theta_i^{out}, \sin \theta_i^{in}\}}{W \kappa_{i, 1}}$ . Considering the worst case (i.e., left cheek collision) with  $\max\{\sin \theta_i^{out}, \sin \theta_i^{in}\} = \sin \tilde{\theta} = \sin \theta$ , we obtain that  $\frac{1}{|\Psi'_{R_i}(\tilde{\theta})|} \leq C \frac{\sin^2 \tilde{\theta}}{W \kappa_{\min}}$ . Recalling that  $\sin \tilde{\theta} \sim W/|\xi|$  and  $\frac{1}{\sin \theta} \leq C \frac{\xi^2}{W^2}$  from Lemma 3.4, we have:

$$\sum_{k \in K_{\xi, \ell}} \sup_{R_i \in p(\xi, \ell, k)} I_{\xi, \ell, k}(f) \leq C_{\kappa}^2 |t| \|f\|_{\infty} \frac{\xi^2}{W^2} \frac{W^2}{\xi^2} = C_{\kappa}^2 |t| \|f\|_{\infty}.$$

Thus, the sum in (30) coming from  $I$  satisfies (recall  $\xi_\eta \sim W/\eta$ ),

$$\sum_{|\xi| > \xi_\eta} \sum_{\ell \in \{L, R, D\}} \sum_{k \in K_{\xi, \ell}} I(\xi, f) \leq C_\kappa^2 |t| \|f\|_\infty \sum_{|\xi| \geq \xi_\eta} \sum_{\ell \in \{L, R, D\}} \frac{C_p W}{\xi^2} = O(|t| \|f\|_\infty). \quad (32)$$

Regarding  $II_{\xi, \ell, k}$  in (31), we first separate  $f$ :

$$\begin{aligned} II_{\xi, \ell, k}(f) &\leq \sup_{\theta \in \Theta_{\xi, \ell, k}} \frac{1}{\sin \theta} \text{Var}(f|_{J_{\xi, \ell, k}}) \sup_{\tilde{\theta} \in J_{\xi, \ell}} \left| \frac{\sin \tilde{\theta} (e^{itX(\tilde{\theta})} - 1)}{|\Psi'_{R_i}(\tilde{\theta})|} \right| \\ &\quad + \sup_{\theta \in \Theta_{\xi, \ell, k}} \frac{\|f\|_\infty}{\sin \theta} \text{Var}_{\tilde{\theta} \in J_{\xi, \ell, k}} \left( \frac{\sin \tilde{\theta} (e^{itX(\tilde{\theta})} - 1)}{|\Psi'_{R_i}|} \right). \end{aligned} \quad (33)$$

For the remaining terms, we first note that  $x \mapsto e^{itx} - 1$  is smooth and sufficiently ‘‘monotone’’ so that  $\sum_{k \in K_{\xi, \ell}} \text{Var}_{\tilde{\theta} \in J_{\xi, \ell, k}} (e^{itX(\tilde{\theta})} - 1) \leq |t| \sum_{k \in K_{\xi, \ell}} \text{Var}_{\tilde{\theta} \in J_{\xi, \ell, k}} X(\tilde{\theta}) \leq |t| \sup_{\tilde{\theta} \in J_{\xi, \ell}} \frac{W}{|\tan \tilde{\theta}|}$ . Therefore,

$$\begin{aligned} \sum_{k \in K_{\xi, \ell}} \sup_{R_i \in p(\xi, \ell, k)} \text{Var}_{\tilde{\theta} \in J_{\xi, \ell, k}} \left( \frac{\sin \tilde{\theta} (e^{it} - 1)}{|\Psi'_{R_i}|} \right) &\leq \\ \sum_{k \in K_{\xi, \ell}} |t| \sup_{\tilde{\theta} \in J_{\xi, \ell}} \frac{W}{|\tan \tilde{\theta}|} \sup_{R_i \in p(\xi, \ell, k)} \left( \frac{\sin \tilde{\theta}}{|\Psi'_{R_i}(\tilde{\theta})|} \right) &+ |t| \sup_{\tilde{\theta} \in J_{\xi, \ell}} \frac{W}{|\tan \tilde{\theta}|} \sup_{R_i \in p(\xi, \ell, k)} \text{Var}_{\tilde{\theta} \in J_{\xi, \ell, k}} \left( \frac{\sin \tilde{\theta}}{|\Psi'_{R_i}|} \right). \end{aligned} \quad (34)$$

We can merge the intervals  $J_{\xi, \ell, k}$  over  $k \in K_{\xi, \ell}$  again and apply Corollary 4.3 for the remaining sum over the variations in this expression. Using again the estimates listed before (32), continuing from (34), we have that the following holds for some  $C_0, C_1 > 0$ :

$$\sum_{k \in K_{\xi, \ell}} \sup_{R_i \in p(\xi, \ell, k)} \text{Var}_{\tilde{\theta} \in J_{\xi, \ell, k}} \left( \frac{\sin \tilde{\theta} (e^{itX} - 1)}{|\Psi'_{R_i}|} \right) \leq C_0 |t| \frac{W^2}{\xi^2} + C_1 |t| \frac{1}{|\xi|^{3/2}}.$$

This together with (33) (recalling  $\frac{1}{\sin \theta} \leq C_\kappa \frac{\xi^2}{W^2}$  and  $\xi_\eta \sim W/\eta$ ) gives:

$$\begin{aligned} \sum_{|\xi| > \xi_\eta} \sum_{\ell \in \{L, R, D\}} \sum_{k \in K_{\xi, \ell}} \sup_{R_i \in p(\xi, \ell, k)} J_{\xi, \ell, k}(f) \\ \leq C |t| \|f\|_{BV} \sum_{|\xi| > \xi_\eta} \sum_{\ell \in \{L, R, D\}} \frac{C_p W}{\xi^2} \frac{C_\kappa \xi^2}{W^2} \left( C_0 |t| \frac{W^2}{\xi^2} + C_1 |t| \frac{1}{|\xi|^{3/2}} \right) = O(|t| \|f\|_{BV}). \end{aligned}$$

This together with (32) implies that  $\text{Var}_\theta((P_t - P_0)f) = O\left(\frac{|t| \|f\|_{BV}}{W}\right)$ , as required.  $\square$

An immediate consequence of Lemmas 5.3 and 5.4 is

**Corollary 5.5.** *Assume  $\sin \theta < \eta$ . Let  $f \in BV$ . There exists  $C > 0$  (independent of  $\theta$ ) so that for all  $t \in \mathbb{R}$ ,  $\left\| (P_t - P_0)f|_{\{\sin \tilde{\theta} < \eta\}} \right\|_{BV} \leq C |t| \|f\|_{BV}$ .*

## 5.2 Continuity estimate when $\sin \tilde{\theta} \geq \eta$

As in the proof of Lemma 5.6 below, the averaging plays no role when  $\sin \tilde{\theta} \geq \eta$ , that is when Throughout this paragraph we shall exploit the formula for transfer operator  $P_{R_i}$  defined in (17).

**Lemma 5.6.** *There exists  $C > 0$  so that  $\left\| (P_t - P_0)f|_{\{\sin \tilde{\theta} \geq \eta\}} \right\|_{BV} \leq C |t| \|f\|_{BV}$ .*

*Proof.* We display the argument for bounding the variation. The argument for the  $\|\cdot\|_\infty$  norm is simpler and omitted.

If  $\theta \mapsto \Psi_{R_i}^{-1}(\theta) = \tilde{\theta} \in J_{\xi, \ell}$  refers to a single monotone branch of  $\Psi_{R_i}^{-1}$ , then  $\text{Var}_\theta(f \circ \Psi_{R_i}^{-1}) = \text{Var}_{\tilde{\theta}}(f|_{I_{\xi, \ell}})$ . Recall from Lemma 4.1 that  $\Lambda_\eta$  indicates the collection of branches of  $\Psi_{R_i}^{-1}$  for  $\sin \tilde{\theta} \geq \eta$ .

With these specified, writing again  $\tilde{\theta} = \Psi_{R_i}^{-1}(\theta)$  and using  $\text{Var}(f \cdot g) = \|f\|_\infty \text{Var}(g) + \|g\|_\infty \text{Var}(f)$  multiple times, we compute that

$$\begin{aligned}
& \text{Var}_\theta \left( P_{R_i} \left( e^{itX} - 1 \right) f \Big|_{\{\sin \tilde{\theta} \geq \eta\}} \right) \\
& \leq \text{Var}_\theta \left( \frac{1}{\sin \theta} \Big|_{\sin \tilde{\theta} \geq \eta} \right) \sum_{\ell \in \Lambda_\eta} \sup_{\tilde{\theta} \in J_\ell} \frac{f(\tilde{\theta}) \cdot \sin(\tilde{\theta})(e^{itX} - 1)}{|\Psi'_{R_i}(\tilde{\theta})|} \Big|_{\{\sin \tilde{\theta} \geq \eta\}} \\
& \quad + \sup_{\sin \tilde{\theta} \geq \eta} \left( \frac{1}{\sin \theta} \right) \sum_{\ell \in \Lambda_\eta} \text{Var}_{\tilde{\theta} \in J_\ell} \left( \frac{f(\tilde{\theta}) \cdot \sin(\tilde{\theta})(e^{-itX} - 1)}{|\Psi'_{R_i}(\tilde{\theta})|} \right) \\
& \leq \frac{|t|WC_\kappa^2}{\eta^2} \|f\|_\infty \sum_{\ell \in \Lambda_\eta} \left\| \frac{1}{|\Psi'_{R_i}(\tilde{\theta})|} \right\|_\infty + \frac{C_\kappa^2}{\eta^2} \sum_{\ell \in \Lambda_\eta} \text{Var}_{\tilde{\theta} \in J_\ell} \left( \frac{f(\tilde{\theta}) \cdot \sin(\tilde{\theta})(e^{-itX} - 1)}{|\Psi'_{R_i}(\tilde{\theta})|} \right) \\
& \leq \frac{|t|WC_\kappa^2}{\eta^2} \sum_{\ell \in \Lambda_\eta} \left\| \frac{1}{|\Psi'_{R_i}(\tilde{\theta})|} \right\|_\infty \left( 3\|f\|_\infty + \text{Var}(f) \right) + \frac{|t|WC_\kappa^2}{\eta^2} \sum_{\ell \in \Lambda_\eta} \text{Var}_{\tilde{\theta} \in J_\ell} \left( \frac{1}{|\Psi'_{R_i}(\tilde{\theta})|} \right) \\
& \leq \frac{|t|WC_\kappa^2}{\eta^2} \left( 3\|f\|_\infty + \text{Var}(f) \right) C_\eta + \frac{|t|WC_\kappa^2}{\eta^2} \|f\|_\infty C \leq \frac{C'W}{\eta^2} |t| \|f\|_{BV},
\end{aligned}$$

for some  $C' > 0$ . Here we used that  $\Lambda_\eta$  pertains to at most  $C_\eta W$  branches (see from Lemma 4.1), and Lemma to get the bound  $\sum_{\ell \in \Lambda_\eta} \text{Var}_{\tilde{\theta} \in J_\ell} \left( \frac{1}{|\Psi'_{R_i}(\tilde{\theta})|} \right) \leq C$  for some  $C$ . The desired continuity estimate for the variation of the averaged operator follows immediately.  $\square$

### 5.3 Proof of Proposition 5.1

This follows at once from Corollary 5.5 and Lemma 5.6 with  $C_{BV} = C_\infty + C'/\sqrt{\eta}$ .

## 6 Spectral properties for the averaged operator

Unlike in previous literature on random dynamical systems (see [3] and references therein), in the present set up we have uniform expansion (that is, not just in average), but to deal with the variation in  $\theta$  of the transfer operator in the case that  $\sin \theta < \eta$ , we will heavily exploit the averaging (in a similar manner as in Section 5), see Subsection 6.3. For  $\sin \theta \geq \eta$ , averaging plays no role (again, similar to the continuity estimate in Section 5), see Subsection 5.2.

The result below gives the required Lasota-Yorke inequalities in BV.

**Proposition 6.1.** *There exist  $\alpha \in (0, 1)$  and  $C_1, C_2 > 0$  so that for all  $n \geq 1$  and all  $f \in BV$ ,*

$$\|P^n f\|_{BV} \leq \alpha^n \|f\|_{BV} + C_1 \|f\|_\infty \quad \text{and} \quad \|P^n f\|_\infty \leq C_2 \|f\|_\infty.$$

The proof of this result is provided in Subsections 6.3–6.5.

### 6.1 Spectral decomposition of $P$

Proposition 6.1 together with a classical result [12] implies that when regarded as an operator in BV, for  $n \geq 1$ ,  $P^n = \sum_i \lambda_i^n \Pi_i + Q^n$ , where  $\lambda_i$  are eigenvalues of modulus 1,  $\Pi_i$  are finite-rank projectors onto the associated eigenspaces, and  $Q$  is a bounded operator with a spectral radius strictly less than 1. Also, there are only finitely many eigenvalues on the unit circle, and all  $\lambda_i$  are roots of unity. (This type of decomposition for the perturbed averaged operator  $P_t$  would be enough for the proof of Theorem 1.1.)

Moreover, we can also ensure that 1 is a simple isolated eigenvalue in the spectrum of  $P$ . To do so, we will employ the correspondence between properties of random dynamical systems and associated Markov chains as in, for instance, [13, 3].

Following a similar notation as in [3, Sections 2 and 4], we note that the averaged Koopman operator  $U$  acts on functions defined on  $(0, \pi)$  via  $Uf = \int_0^1 f(\Psi_{R_i}) d\nu(R_i)$ . In particular,  $U$

corresponds to a transition probability matrix on  $(0, \pi)$  defined by

$$U\mathbb{1}_A(\theta) = \nu^{\otimes \mathbb{Z}} \left( (R_j)_{j \in \mathbb{Z}} \in [0, 1]^{\mathbb{Z}} : \Psi_{R_{i+n-1}} \circ \cdots \circ \Psi_{R_i}(\theta) \in A \right), \quad A \in \mathcal{A},$$

where  $\mathcal{A}$  is the  $\sigma$ -algebra of  $\mu$ -measurable sets on  $(0, \pi)$ .

Let

$$Y_n((R_i)_{i \in \mathbb{Z}}, \theta) = \Psi_{R_{i+n-1}} \circ \cdots \circ \Psi_{R_i}(\theta), \quad \theta \in A \in \mathcal{A}, \quad (R_i, \dots, R_{i+n-1}) \in [0, 1]^n. \quad (35)$$

Then  $(Y_n)_{n \geq 1}$  defines a homogeneous Markov chain on state space  $((0, \pi), \mathcal{A})$ . The transition operator (probability matrix) is given by  $U$ .

Recall that  $\mu$  is an invariant measure for  $\Psi_{R_i}$ . Since  $\mu(A) = \int_0^1 \mu(\Psi_{R_i}^{-1}(A)) d\nu(R_i)$  for each  $A \in \mathcal{A}$ ,  $\mu$  is a stationary measure for the associated Markov chain and  $\mu U = \mu$ . As clarified in Lemma 6.3 below, the Markov chain  $(Y_n)_{n \geq 1}$  is aperiodic. Thus,  $\mu$  is the unique stationary measure for this Markov chain and thus the unique left eigenvector of  $U$  with eigenvalue 1, which is simple. Recalling Remark 3.3, we see that the averaged operator  $P$  is the dual, or adjoint, operator of  $U$ , i.e.,  $\int_0^\pi P f g d\mu = \int_0^\pi f U g d\mu$ .

It follows that the constant function 1 is the unique eigenfunction of modulus 1 for  $P$ . Indeed, if  $f \neq 1$  were a fixed point of the average transfer operator:  $f = P f := \int_{[0,1]^{\mathbb{Z}}} P_{(R_i)_{i \in \mathbb{Z}}} f d\nu^{\otimes \mathbb{Z}}$ , that is, if 1 is not a simple eigenvalue of  $P$ , then, using duality for an arbitrary  $g : (0, \pi) \rightarrow \mathbb{R}$ ,

$$\begin{aligned} \int_0^\pi \int_{[0,1]^{\mathbb{Z}}} f \cdot g \circ \Psi_{R_i} d\nu^{\otimes \mathbb{Z}} d\mu &= \int_0^\pi \int_{[0,1]^{\mathbb{Z}}} P_{(R_i)_{i \in \mathbb{Z}}} f \cdot g d\nu^{\otimes \mathbb{Z}} d\mu \\ &= \int_0^\pi \left( \int_{[0,1]^{\mathbb{Z}}} P_{(R_i)_{i \in \mathbb{Z}}} f d\nu^{\otimes \mathbb{Z}} \right) \cdot g d\mu \\ &= \int_0^\pi f \cdot g d\mu = \int_0^\pi f \circ \Psi_{R_i} \cdot g \circ \Psi_{R_i} d\mu \\ &= \int_0^\pi \int_{[0,1]^{\mathbb{Z}}} f \circ \Psi_{R_i} \cdot g \circ \Psi_{R_i} d\nu^{\otimes \mathbb{Z}} d\mu. \end{aligned}$$

Since  $g$  is arbitrary, this shows that

$$\int_{[0,1]^{\mathbb{Z}}} f(x) \circ \Psi_{R_i} \cdot g \circ \Psi_{R_i}(x) d\nu^{\otimes \mathbb{Z}} = \int_{[0,1]^{\mathbb{Z}}} f(x) \cdot g \circ \Psi_{R_i}(x) d\nu^{\otimes \mathbb{Z}}.$$

for  $\mu$ -a.e.  $x \in (0, \pi)$ . The special case  $g \equiv 1$  gives

$$U f(x) := \int_{[0,1]^{\mathbb{Z}}} f \circ \Psi_{R_i}(x) d\nu^{\otimes \mathbb{Z}} = \int_{[0,1]^{\mathbb{Z}}} f(x) d\nu^{\otimes \mathbb{Z}} = f(x) \quad \mu\text{-a.s.},$$

but this contradicts that  $U$  has a unique fixed point, i.e., it contradicts the uniqueness of the stationary measure.

Hence 1 is a simple eigenvalue of  $P$ . If  $\lambda_i$  were another eigenvalue of the unit circle, say  $\lambda_i^k = 1$ , then we repeat the argument with  $U^k$  and  $P^k$ . This would imply that the eigenvalue 1 would not be simple for this iterate, contradicting the aperiodicity of  $U$ . Thus, 1 is the only eigenvalue on the unit circle, and

$$P^n = \Pi + Q^n, \quad \Pi f = \int_0^\pi f d\mu, \quad \|Q^n f\|_{BV} \leq \delta^n, \quad \text{for some } \delta \in (0, 1).$$

An immediate consequence is exponential decay of correlation for  $f \in BV$  and  $g \in L^\infty$ , in the sense that  $|\int_0^\pi f U^n g d\mu - \int_0^\pi f d\mu \int_0^\pi g d\mu| \leq C \delta^n \|f\|_{BV} \|g\|_{L^\infty}$ , for some  $C > 0$  and  $\delta \in (0, 1)$  independent of  $f, g$ , and  $n \geq 1$ .

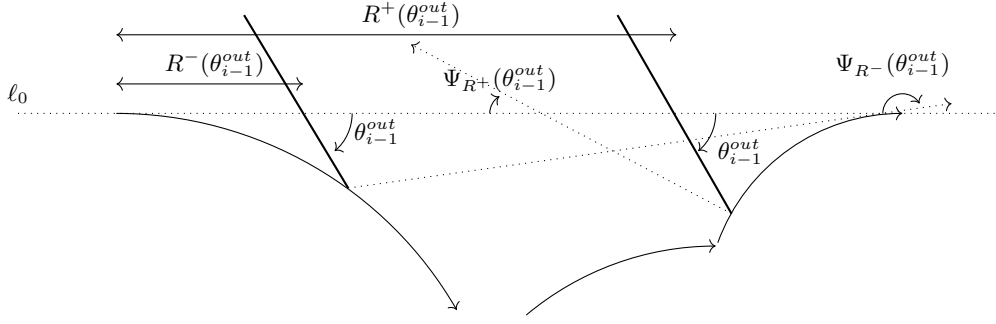

Figure 10: The definition of  $R^+(\theta_{i-1}^{out})$  and  $R^-(\theta_{i-1}^{out})$  illustrated.

## 6.2 Aperiodicity of the associated Markov chain

Let  $\mathcal{I}_i^n(A) = \{\Psi_{R_{i+n-1}} \circ \dots \circ \Psi_{R_i}(\theta_{i-1}^{out}) : \theta \in A, (R_i, \dots, R_{i+n-1}) \in [0, 1]^n\}$ .

**Lemma 6.2.** *For every  $\theta \in (0, 1)$  and  $i \in \mathbb{Z}$ , we have*

$$\bigcup_{n \geq 0} \mathcal{I}_i^n(\{\theta_{i-1}^{out}\}) = (0, \pi).$$

*Proof.* For  $\theta \in (0, \pi)$ , let

$$R^+(\theta) = \inf_{R \leq 1} \{R : \text{the random trajectory in } \mathcal{M}_i \text{ hits the right cheek and then leaves } \mathcal{M}_i\}$$

and

$$R^-(\theta) = \sup_{R \geq 0} \{R : \text{the random trajectory in } \mathcal{M}_i \text{ hits the left cheek and then leaves } \mathcal{M}_i\},$$

see Figure 10. This means that at  $R^+$ , the random trajectory either hits a corner point of the right cheek, or, after a collision with the right cheek, has a grazing collision with the left cheek, and similar for  $R^-$ . By convexity of the right and left cheek, for each  $\theta \in (0, \pi)$ ,

$$\lim_{R \searrow R^+(\theta)} \Psi_R(\theta) < \theta \quad \text{and} \quad \lim_{R \nearrow R^-(\theta)} \Psi_R(\theta) > \theta. \quad (36)$$

Now define recursively

$$\alpha_k = \begin{cases} \theta_{i-1}^{out} & \text{if } k = 0, \\ \lim_{R \searrow R_{i+k}^+(\alpha_{k-1})} \Psi_R(\alpha_{k-1}) & \text{if } k \geq 1, \end{cases} \quad \beta_k = \begin{cases} \theta_{i-1}^{out} & \text{if } k = 0, \\ \lim_{R \nearrow R_{i+k}^-(\beta_{k-1})} \Psi_R(\beta_{k-1}) & \text{if } k \geq 1. \end{cases}$$

Then  $(\alpha_k)_{k \geq 0}$  is decreasing, and since it is bounded below by 0, there is a limit  $L$ , which is a fixed point of the operation  $\theta \mapsto \lim_{R \searrow R^+(\theta)} \Psi_R(\theta)$ . This means by (36) that  $L = 0$ . The same argument shows that  $(\beta_k)_{k \geq 0}$  is increasing to the limit  $\pi$ .

Note that  $(\alpha_1, \beta_1) = \{\Psi_{R_i}(\theta_{i-1}^{out}) : R_i^- < R_i < R_i^+\}$ , and for larger values of  $i$ , there are subsets  $G_j \subset [0, 1]$  for  $R_{i+j-1}$  so that  $(\alpha_k, \beta_k) = \{\Psi_{R_{i+k-1}} \circ \dots \circ \Psi_{R_i}(\theta_{i-1}^{out}) : R_{i+j} \in G_j, 0 \leq j < k\}$ . It follows that

$$\bigcup_{n \geq 0} \mathcal{I}_i^n(\theta_{i-1}^{out}) \supset \bigcup_{k \geq 0} (\alpha_k, \beta_k) = (0, \pi),$$

as required.  $\square$

**Lemma 6.3.** *The Markov chain  $(Y_n)_{n \geq 1}$  defined in (35) is aperiodic.*

*Proof.* We prove aperiodicity by showing that  $(Y_n)_{n \geq 1}$  is indecomposable of all orders. Let  $n \in \mathbb{N}$  be given. For indecomposability of order  $n$ , it is sufficient to prove for any  $A \in \mathcal{A}$  with  $\mu(A) > 0$  and which satisfies  $U^n \mathbb{1}_A(\theta) = 1$  for  $\mu$ -a.e  $\theta \in A$ , that  $\mu(A) = 1$ , see Definition 7.14 from Breiman's book [4]. Let such an  $A$  be given and take  $\theta \in A$ . Then

$$U^n \mathbb{1}_A(\theta) = \nu^{\otimes Z} \left( (R_j)_{j \in \mathbb{Z}} \in [0, 1]^{\mathbb{Z}} : \Psi_{R_{i+n-1}} \circ \cdots \circ \Psi_{R_i}(\theta) \in A \right) = 1,$$

so for  $\nu^{\otimes Z} \times \mu$ -a.e.  $((R_i)_{i \in \mathbb{Z}}, \theta) \in [0, 1]^{\mathbb{Z}} \times A$  we get

$$T^n((R_i)_{i \in \mathbb{Z}}, \theta) \in [0, 1]^{\mathbb{Z}} \times A.$$

Thus, for  $\mu$ -a.e.  $\theta \in A$  we have  $\mathcal{I}^n(\{\theta\}) \subseteq A \cup N$  for some set  $N \in \mathcal{A}$  with  $\mu(N) = 0$ , and likewise for any  $k \in \mathbb{N}$  we get

$$\mathcal{I}^{nk}(\theta) \subseteq A \cup N_k,$$

for some  $N_k \in \mathcal{A}$  with  $\mu(N_k) = 0$ . We have that  $\mathcal{I}^{nk}(\theta)$  is increasing in  $k$  since  $\Psi(0, \theta) = \Psi(1, \theta) = \theta$ , and this implies that  $\mathcal{I}^k(\theta) \subset \mathcal{I}^{nk}(\theta)$ . Therefore, using Lemma 6.2, we get

$$(0, \pi) = \bigcup_{k \geq 1} \mathcal{I}^k(\theta) \subseteq \bigcup_{k \geq 1} \mathcal{I}^{nk}(\theta) \subseteq A \cup \left( \bigcup_{k \geq 1} N_k \right) \subseteq (0, \pi),$$

and this implies that  $\mu(A) = 1$ . □

### 6.3 Estimating $\|Pf\|_{BV}$ when $\sin \tilde{\theta} < \eta$

We start with  $\|Pf\|_{BV}$  of the average transfer operator  $P$  defined in (18).

**Lemma 6.4.** *Assume that  $\sin \tilde{\theta} < \eta$ . Then there exists  $\alpha \in (0, 1)$  so that for all  $f \in BV$ ,  $\|Pf\|_{BV} \leq \alpha \|f\|_{BV}$ .*

*Proof.* **Estimating**  $\left\| Pf \Big|_{\{\sin \tilde{\theta} < \eta\}} \right\|_{\infty}$ .

As in Section 5, averaging over  $R_i$  means that in the formula for transfer operator  $P_{R_i}$  defined in (17) we multiply with  $\nu(p(J_{\xi, \ell}, \tilde{\theta}))$ . Recalling that  $\sin \tilde{\theta} < \eta$  and proceeding similarly to (29),

$$\left\| Pf \Big|_{\{\sin \tilde{\theta} < \eta\}} \right\|_{\infty} \leq \sup_{\theta} \sum_{\xi=W \max\{\frac{1}{\eta}, \frac{1}{C_{\kappa} \sqrt{\sin \theta}}\}}^{\frac{W}{(C_{\kappa} \sin \theta)^2}} \left\| \frac{f(\tilde{\theta}) \sin \tilde{\theta}}{|\Psi'_{R_i}(\tilde{\theta})| \sin \theta} \right\|_{\infty} \nu(p(\xi, \tilde{\theta})) \mathbb{1}_{\xi(\tilde{\theta})=\xi}. \quad (37)$$

Recall that the estimate for the derivative is given in (9). Recall from Lemma 5.2 that in the worst case scenario (left cheek collision),  $\nu(p(J_{\xi, \ell}, \tilde{\theta})) \leq \frac{h^+ |\tan \tilde{\theta}|^2}{2\kappa_{\min} W}$ . Also, recall that  $\sin \tilde{\theta} \sim W/|\xi|$ . Putting these together and using (37), we obtain

$$\begin{aligned} \left\| Pf \Big|_{\{\sin \tilde{\theta} < \eta\}} \right\|_{\infty} &\leq \sup_{\theta} \|f\|_{\infty} \frac{1}{\sin \theta} \sum_{\xi=W \max\{\frac{1}{\eta}, \frac{1}{\sqrt{C_{\kappa} \sin \theta}}\}}^{\frac{W}{(C_{\kappa} \sin \theta)^2}} \frac{\sin^2 \tilde{\theta}}{\kappa_{\min} W} \frac{h^+ |\tan \tilde{\theta}|^2}{2\kappa_{\min} W} \\ &\ll \frac{h^+}{2\kappa_{\min}^2} \|f\|_{\infty} \sup_{\theta} \frac{W^2}{\sin \theta} \sum_{\xi=W \max\{\frac{1}{\eta}, \frac{1}{\sqrt{C_{\kappa} \sin \theta}}\}}^{\frac{W}{(C_{\kappa} \sin \theta)^2}} \frac{1}{\xi^4} \leq \frac{h^+}{3\kappa_{\min}^2 C_{\kappa}^{3/2}} \|f\|_{\infty} \frac{\sqrt{\sin \theta}}{W} < \frac{1}{8}, \end{aligned}$$

provided we take  $W \geq 8h^+ / (3\kappa_{\min}^2 C_{\kappa}^{3/2})$ .

**Estimating**  $\text{Var} \left( Pf \Big|_{\{\sin \tilde{\theta} < \eta\}} \right)$ . For this part we proceed as in Subsection 5.1.4 and we only sketch the argument. Here the calculations are easier due to the absence of  $e^{itX} - 1$ .

In short, (30) and (31) are replaced by

$$\mathrm{Var}_\theta(Pf|_{\{\sin \tilde{\theta} < \eta\}}) \leq \sum_{|\xi| \geq \xi_\eta} \sum_{\ell \in \{L, R, D\}} \frac{C_p W}{\xi^2} \max_{R_i \in p(\xi, \ell)} \mathrm{Var}_\theta \left( \frac{f(\tilde{\theta})}{|\Psi'_{R_i}(\tilde{\theta})|} \frac{\sin \tilde{\theta}}{\sin \theta} \mathbb{1}_{J_{\xi, \ell}}(\tilde{\theta}) \right) \quad (38)$$

with

$$\begin{aligned} \mathrm{Var}_\theta \left( \frac{f(\tilde{\theta})}{|\Psi'_{R_i}(\tilde{\theta})|} \frac{\sin \tilde{\theta}}{\sin \theta} \mathbb{1}_{J_{\xi, \ell}}(\tilde{\theta}) \right) &= \mathrm{Var}_\theta \left( \frac{1}{\sin \theta} \Big|_{\Psi_{R_i}(J_{\xi, \ell})} \right) \sup_{\tilde{\theta} \in J_{\xi, \ell}} \left| \frac{f(\tilde{\theta})}{|\Psi'_{R_i}(\tilde{\theta})|} \sin \tilde{\theta} \mathbb{1}_{J_{\xi, \ell}}(\tilde{\theta}) \right| \\ &\quad + \sup_{\theta \in \Psi_{R_i}(J_{\xi, \ell})} \frac{1}{\sin \theta} \mathrm{Var}_{\tilde{\theta}} \left( \frac{f(\tilde{\theta})}{|\Psi'_{R_i}(\tilde{\theta})|} \sin \tilde{\theta} \mathbb{1}_{J_{\xi, \ell}}(\tilde{\theta}) \right) \\ &= V_1(\xi, f, W) + V_2(\xi, f, W). \end{aligned} \quad (39)$$

For  $V_1$  we just need to recall that  $\mathrm{Var}_\theta \left( \frac{1}{\sin \theta} \Big|_{\Psi_{R_i}(J_{\xi, \ell})} \right) \leq \sup_{\theta \in \Psi_{R_i}(J_{\xi, \ell})} \frac{1}{\sin \theta}$  by the proof of Lemma 5.3 (first lines below (31)). Hence, the sums over terms with  $V_1(\theta, f, W)$  can be dealt with similarly to estimating  $\|Pf|_{\{\sin \tilde{\theta} < \eta\}}\|_\infty$ , which gives another term strictly less than  $1/8$ , or similarly to estimating  $I$  inside the proof of Lemma 5.3.

For  $V_2$ , we proceed as in estimating  $II$  inside the proof of Lemma 5.3. The absence of the factor  $e^{itX} - 1$  much simplifies the calculation. More precisely,

$$V_2(\xi, f, W) \leq \sup_{\theta} \left( \frac{\mathrm{Var}(f)}{\sin \theta} \left| \frac{f(\tilde{\theta}) \sin \tilde{\theta}}{|\Psi'_{R_i}|} \right| + \frac{\|f\|_\infty}{\sin \theta} \mathrm{Var}_{\tilde{\theta}} \left( \frac{\sin \tilde{\theta}}{|\Psi'_{R_i}|} \mathbb{1}_{J_{\xi, \ell}} \right) \right). \quad (40)$$

From Corollary 4.3 we have  $\mathrm{Var}_{\tilde{\theta}} \left( \frac{\sin \tilde{\theta}}{|\Psi'_{R_i}|} \mathbb{1}_{J_{\xi, \ell}} \right) \leq C|\xi|^{-5/2}$  and for left cheek collisions, we have  $|\Psi'_{R_i}(\tilde{\theta})| \leq \frac{\sin^2 \tilde{\theta}}{W \kappa_{\min}}$  and  $\sin \theta \geq \sin^2 \tilde{\theta} / C_\kappa^2 \sim W^2 / (C_\kappa \xi)^2$ . Therefore

$$V_2(\xi, f, W) \leq \frac{C_\kappa^2}{\kappa_{\min} W |\xi|} \mathrm{Var}(f) + \frac{C_\kappa^2}{W^2 |\xi|^{1/2}} \|f\|_\infty.$$

Taking the sum over all relevant  $(\xi, \ell)$  and recalling that  $\xi_\eta \sim W/\eta$ , we find

$$\begin{aligned} \sum_{|\xi| > \xi_\eta} \sum_{\ell \in \{L, R, D\}} \frac{C_p W}{\xi^2} \max_{R_i \in p(\xi, \ell)} V_2(\xi, f, W) &\leq 3C_p \sum_{|\xi| > \xi_\eta} \frac{C_\kappa^2}{\kappa_{\min} |\xi|^3} \mathrm{Var}(f) + \frac{C_\kappa^2}{W |\xi|^{5/2}} \|f\|_\infty \\ &\leq \frac{3C_p C_\kappa^2 \eta^2}{\kappa_{\min} W^2} \|f\|_{BV} < \frac{1}{8}, \end{aligned}$$

for  $W > 2C_\kappa \eta \sqrt{6C_p / \kappa_{\min}}$ . The conclusion follows by adding the sums over  $V_1$  and  $V_2$ .  $\square$

#### 6.4 Estimating $\|Pf\|_{BV}$ when $\sin \theta \geq \eta$

In this section we proceed as in Subsection 5.2 without the presence of the displacement  $X$ .

**Lemma 6.5.** *Let  $\eta > 0$  be as in Lemma 4.1. There exists  $\alpha \in (0, 1)$  and  $C, C' > 0$  so that*

$$\mathrm{Var}_\theta \left( P_{R_i} f|_{\{\sin \tilde{\theta} \geq \eta\}} \right) \leq \alpha \mathrm{Var}(f) + C \|f\|_\infty, \quad \left\| \left( P_{R_i} f|_{\{\sin \tilde{\theta} \geq \eta\}} \right) \right\|_\infty \leq C' \|f\|_\infty.$$

*Proof.* If  $\theta \mapsto \Psi_{R_i}^{-1}(\theta) = \tilde{\theta} \in J_{\xi, \ell}$  refers to a single monotone branch of  $\Psi_{R_i}^{-1}$ , then  $\mathrm{Var}_\theta(f \circ \Psi_{R_i}^{-1}) =$



$\text{Var}_\theta(f|_{I_{\xi,\ell}})$ . Recall from Lemma 3.4 that  $\sin \tilde{\theta} \geq \eta$  implies that  $\sin \theta \geq \eta^2/C_\kappa^2$ . Compute that

$$\begin{aligned}
\text{Var}_\theta \left( P_{R_i} f |_{\{\sin \tilde{\theta} \geq \eta\}} \right) &= \text{Var}_\theta \left( \frac{1}{\sin \theta} \sum_{\ell \in \Lambda_\eta} \frac{f \circ \Psi_{R_i}^{-1}(\theta) \cdot \sin(\Psi_{R_i}^{-1}(\theta))}{|\Psi'_{R_i}(\Psi_{R_i}^{-1}(\theta))|} \mathbb{1}_{J_{\xi,\ell}}(\Psi_{R_i}(\theta)) \right) \\
&\leq \left\| \frac{1}{\sin \theta} |_{\{\sin \theta \geq \eta\}} \right\|_\infty \sum_{\ell \in \Lambda_\eta} \text{Var}_\theta \left( \frac{f(\tilde{\theta}) \cdot \sin(\tilde{\theta})}{|\Psi'_{R_i}(\tilde{\theta})|} \mathbb{1}_{J_{\xi,\ell}}(\tilde{\theta}) \right) \\
&\quad + \text{Var} \left( \frac{1}{\sin \theta} |_{\sin \theta \geq \eta} \right) \left\| \sum_{\ell \in \Lambda_\eta} \frac{f(\tilde{\theta}) \cdot \sin(\tilde{\theta})}{|\Psi'_{R_i}(\tilde{\theta})|} \mathbb{1}_{J_{\xi,\ell}}(\tilde{\theta}) \right\|_\infty \\
&\leq \frac{C_\kappa^2}{\eta^2} \sum_{\ell \in \Lambda_\eta} \left( \text{Var}_\theta(f|_{J_{\xi,\ell}}) \left\| \frac{\sin(\tilde{\theta})}{|\Psi'_{R_i}(\tilde{\theta})|} \mathbb{1}_{J_{\xi,\ell}}(\tilde{\theta}) \right\|_\infty \right. \\
&\quad \left. + \|f|_{J_{\xi,\ell}}\|_\infty \text{Var}_\theta \left( \frac{\sin(\tilde{\theta})}{|\Psi'_{R_i}(\tilde{\theta})|} \mathbb{1}_{J_{\xi,\ell}}(\tilde{\theta}) \right) \right) \\
&\quad + \frac{2C_\kappa^2}{\eta^2} \|f\|_\infty \sum_{\ell \in \Lambda_\eta} \left\| \frac{\sin(\tilde{\theta})}{|\Psi'_{R_i}(\tilde{\theta})|} \mathbb{1}_{J_{\xi,\ell}}(\tilde{\theta}) \right\|_\infty \\
&\leq \frac{C}{2\eta^2 W} \sum_{\ell \in \Lambda_\eta} \text{Var}(f|_{J_{\xi,\ell}}) + \frac{2NW}{\eta^3} \frac{C}{W} \|f\|_\infty + \frac{NW}{\eta^3} \frac{C}{W} \|f\|_\infty \\
&\leq \frac{C}{2\eta^2 W} \text{Var}(f) + \frac{3NC}{2\eta^3} \|f\|_\infty.
\end{aligned}$$

By taking  $W > 3C/(2\eta^2)$ , this gives a Lasota-Yorke inequality for this part of the variation with  $\alpha = \frac{1}{3}$ , already for the non-averaged transfer operator. Averaging cannot undo this, so we have  $\text{Var}_\theta \left( P f |_{\{\sin \tilde{\theta} \geq \eta\}} \right) \leq \frac{1}{3} \text{Var}(f) + C' \|f\|_\infty$  for some  $C' > 0$ . This proves the statement on the variation. The estimate for the infinity norm is simpler and omitted.  $\square$

## 6.5 Proof of Proposition 6.1

By Lemmas 6.4 and 6.5,  $\text{Var}_\theta(Pf) \leq \alpha \text{Var}(f) + C \|f\|_\infty$ , and  $\|Pf\|_\infty \leq C_2 \|f\|_\infty$ , for some  $C, C_2 > 0$ . Repeated applications of these inequalities gives that  $\text{Var}_\theta(P^n f) \leq \alpha^n \text{Var}(f) + C_0 \|f\|_\infty$  for some  $C_0 > 0$ . Therefore  $\|P^n f\|_{BV} \leq \alpha^n \text{Var}(f) + C_1 \|f\|_\infty < \alpha^n \|f\|_{BV} + C_1 \|f\|_\infty$ , for some  $C_1 > 0$ , as desired.

## 7 Proof of Theorem 1.1

Recall that  $X(\theta) = W/\tan \theta$ , that  $\mathbb{E}_\mu(X) = 0$  by the symmetry of  $d\mu = \frac{1}{2} \sin \theta d\theta$ , and that  $S_n X := \sum_{i=0}^{n-1} X_i$  where  $X_i = X \circ (\Psi_{R_i} \circ \dots \circ \Psi_{R_0})$ .

In the rest of the section we show that for all  $t \in \mathbb{R}$ , as  $n \rightarrow \infty$

$$\mathbb{E}_{\nu^{\otimes \mathbb{Z}} \times \mu} \left( e^{it \frac{S_n X}{\sqrt{n \log n}}} \right) \rightarrow e^{-\frac{W^2}{2} t^2}. \quad (41)$$

Provided (41) holds, the conclusion of Theorem 1.1 follows by the Levy Continuity Theorem. This means that the Gaussian random variable has mean 0 and variance  $W$ .

We need to study the RHS of (41) relating to the behaviour of  $P_t$ , which is Nagaev's method. By, for instance, repeating word by word the argument used in the proof of [3, Lemma 3.7], we obtain

$$\mathbb{E}_{\nu^{\otimes \mathbb{Z}} \times \mu} \left( e^{it \frac{S_n X}{\sqrt{n \log n}}} f \right) = \int_{(0,\pi)} P_{\frac{t}{\sqrt{n \log n}}}^n f d\mu. \quad (42)$$

We record the following easy lemma, which shows that the displacement  $X(\theta) = W/\tan(\theta)$  barely fails to be  $L^2(\mu)$ .

**Lemma 7.1.** *The measures  $\mu(\theta : X(\theta) > N) = \frac{W^2}{4N^2}(1 + o(1))$  and  $\mu(\theta : X(\theta) < -N) = \frac{W^2}{4N^2}(1 + o(1))$  as  $N \rightarrow \infty$ .*

*Proof.* For  $N > 0$  given, it holds that  $X(\theta) = W/\tan \theta > N$  if and only if  $0 < \theta < \arctan(W/N)$ . Therefore

$$\mu(\{\theta : X(\theta) > N\}) = \int_0^\pi \mathbb{1}_{(N, \infty)}(X(\theta)) d\mu = \int_0^{\arctan(W/N)} \frac{1}{2} \sin \theta d\theta = \frac{1}{2} \left( 1 - \cos \arctan \left( \frac{W}{N} \right) \right).$$

Using a Taylor approximation as  $N \rightarrow \infty$ , we find that

$$\cos \arctan \left( \frac{W}{N} \right) = \frac{1}{\sqrt{1 + \frac{W^2}{N^2}}} = 1 - \frac{W^2}{2N^2}(1 + o(1)),$$

so  $\mu(\{\theta : X(\theta) > N\}) = \frac{W^2}{4N^2}(1 + o(1))$ . The statement on  $\mu(\{\theta : X(\theta) < -N\})$  follows likewise.  $\square$

## 7.1 Spectral decomposition for $P_t$

Repeating the steps of proof of Proposition 6.1, we can show that the average perturbed operator  $P_t$ ,  $t \in \mathbb{R}$  also satisfies the inequalities  $\|P_t^n f\|_{BV} \leq \alpha^n \|f\|_{BV} + C \|f\|_\infty$  and  $\|P_t^n f\|_\infty \leq C' \|f\|_\infty$  for some  $\alpha \in (0, 1)$  and  $C, C' > 0$ . By Proposition 5.1, the family of operators  $(P_t)$ ,  $t \in \mathbb{R}$ , is continuous, when regarded as operators acting on  $BV$ . As a consequence, the associated eigenfamilies are also continuous in  $t$ . That is, the family of dominating eigenvalues  $\lambda_t$  with corresponding eigenprojector operators  $\Pi_t$  and eigenvectors  $v_t$  are continuous in  $t$  (with the same continuity bound as that of Proposition 5.1.) The family of eigenvalues  $\lambda_t$  is well-defined for  $t \in B_\varepsilon(0)$ .

Recall the spectral decomposition for  $P$  in Subsection 6.1. Standard arguments for smooth perturbation of linear operators (see [1, 11]) ensure that for all  $|t| < \varepsilon$ ,

$$P_t^n = \lambda_t^n \Pi_t + Q_t^n, \quad \Pi_t Q_t = Q_t \Pi_t = 0 \quad \text{and} \quad \|Q_t^n f\|_{BV} \leq \delta^n \quad \text{for some } \delta \in (0, 1). \quad (43)$$

## 7.2 Asymptotics of the dominating eigenvalue $\lambda_t$

Using Lemma 7.1 and Proposition 5.1 we obtain the asymptotics of  $\lambda_t$ .

**Lemma 7.2.**  $1 - \lambda_t = \frac{W^2}{2} t^2 \log(1/|t|)(1 + o(1))$  as  $t \rightarrow 0$ .

*Proof.* Write  $v_t$  for the eigenfunction of  $\lambda_t$ . Note that

$$1 - \lambda_t = \int (1 - e^{itX}) v_0 d\mu + \int (1 - e^{itX})(v_t - v_0) d\mu.$$

Here  $v_0 \equiv 1$  is the eigenvector associated with the eigenvalue  $\lambda_0 = 1$ . From here onward the argument is standard, see [2]. In particular, the first part of the calculations used in [2, Proof of Theorem 3.1] shows that

$$\int (1 - e^{itX}) v_0 d\mu = \int (1 - e^{itX} + itX) v_0 d\mu = \frac{L(1/|t|)}{2} t^2 (1 + o(1)),$$

for  $L(1/t) := \int_{-1/|t|}^{1/|t|} u^2 d\mathbb{P}(u)$ . Here  $\mathbb{P}(u) = \mu(\theta : X(\theta) < u)$ , so the tail estimates of Lemma 7.1 and integration by parts give

$$\begin{aligned} L(1/|t|) &= \int_{-1/|t|}^{1/|t|} u^2 d\mathbb{P}(u) = \int_{-1/|t|}^0 u^2 d\mathbb{P}(u) - \int_0^{1/|t|} u^2 d(1 - \mathbb{P}(u)) \\ &= - \int_{-1/|t|}^0 2u\mathbb{P}(u) du + [u^2\mathbb{P}(u)]_{-1/|t|}^0 + \int_0^{1/|t|} 2u(1 - \mathbb{P}(u)) du - [u^2(1 - \mathbb{P}(u))]_0^{1/|t|} \\ &\sim - \int_{-1/|t|}^0 2u \max \left\{ \frac{W^2}{4u^2}, \frac{1}{2} \right\} du - \frac{W^2}{4} + \int_0^{1/|t|} 2u \max \left\{ \frac{W^2}{4}, \frac{1}{2} \right\} du - \frac{W^2}{4} \\ &\sim W^2 \log(1/|t|) + O(W^2) = W^2 \log(1/|t|)(1 + o(1)), \end{aligned}$$

where  $\sim$  indicates factors  $1 + o(1)$  as  $t \rightarrow 0$ . By Proposition 5.1 and standard perturbation theory of linear operators,  $\|v_t - v_0\|_{BV} = O(|t|)$ . Since  $BV \subset L^\infty$ ,

$$\left| \int (1 - e^{itX})(v_t - v_0) d\mu \right| \leq |t| \|v_t - v_0\|_\infty \int |X| d\mu \ll |t| \|v_t - v_0\|_{BV} \ll t^2.$$

and the conclusion follows.  $\square$

### 7.3 Proof of (41)

By Lemma 7.2,  $\lambda_t^n = e^{-n \frac{W^2}{2} t^2 \log(1/|t|)(1+o(1))}$ , as  $t \rightarrow 0$ . By Proposition 5.1,  $\|\Pi_t - \Pi_0\|_{BV} = O(|t|)$ . Combining this with (43), we get  $P_t^n f = e^{-n \frac{W^2}{2} t^2 \log(1/|t|)(1+o(1))} \int f d\mu(1 + o(1))$ .

Recalling (42), we get that for any  $t \in \mathbb{R}$ , as  $n \rightarrow \infty$ ,

$$\mathbb{E}_{\nu \otimes \mathbb{Z} \times \mu} \left( e^{it \frac{S_n \bar{X}}{\sqrt{n \log n}}} f \right) = e^{-\frac{n}{n \log n} \frac{W^2}{2} t^2 \log(n/|t|)(1+o(1))} \int f d\mu(1 + o(1)) \rightarrow e^{-\frac{W^2}{2} t^2} \int f d\mu,$$

as required.

## References

- [1] J. Aaronson, M. Denker. *Local limit theorems for partial sums of stationary sequences generated by Gibbs-Markov maps*. Stoch. Dyn. **1** (2001) 193–237.
- [2] J. Aaronson, M. Denker. *A local limit theorem for stationary processes in the domain of attraction of a normal distribution*. In N. Balakrishnan, I.A. Ibragimov, V.B. Nevzorov, eds., Asymptotic methods in probability and statistics with applications. International conference, St. Petersburg, Russia, 1998, Basel: Birkhäuser, (2001) 215–224.
- [3] R. Aimino, M. Nicol, S. Vaienti. *Annealed and quenched limit theorems for random expanding dynamical systems*. Probab. Theory Relat. Fields **162** (2015) 233–274.
- [4] L. Breiman, *Probability*. Society for Industrial and Applied Mathematics; Reprint Edition (1. May 1992).
- [5] N. Chernov, R. Markarian. *Chaotic billiards*. Mathematical Surveys and Monographs, Amer. Math. Soc. **127** (2006).
- [6] D. Dragičević, G. Froyland, C. González-Tokman and S. Vaienti. *A spectral approach for quenched limit theorems for random expanding dynamical systems*. Comm. Math. Phys. **360** (2018) 1121–1187.
- [7] D. Dragičević, G. Froyland, C. González-Tokman and S. Vaienti. *A spectral approach for quenched limit theorems for random hyperbolic dynamical systems*. Trans. AMS **373** (2020) 629–664.
- [8] R. Feres, G. Yablonski, *Knudsen’s cosine law and random billiards*. Chem. Eng. Sci. **59** (2002) 1541–1556.
- [9] R. Feres, H.-K. Zhang. *The spectrum of the billiard Laplacian of family of random billiards*. Journ. Stat. Phys. **141** (2010) 1039–1054.
- [10] R. Feres, H.-K. Zhang. *Spectral gap for a class of random billiards*. Commun. Math. Phys. **313** (2012) 479–515.
- [11] H. Hennion, L. Hervé. *Limit theorems for Markov chains and stochastic properties of dynamical systems by quasicompactness*. Lect. Notes in Math. **1766**, (2001), Springer-Verlag.
- [12] C.T. Ionescu-Tulcea, G. Marinescu. *Théorie ergodique pour des classes d’opérations non complètement continues*. Ann. Math., **52** (1950) 140–147.
- [13] Y. Kifer. *Thermodynamic formalism for random transformations revisited*. Stoch. Dyn., **8** (2008) 77–102.
- [14] D. Szász, T. Varjú. *Limit laws and recurrence for the planar Lorentz process with infinite horizon*. J. Stat. Phys. **129** (2007) no. 1, 59–80.