

“© 2024 IEEE. Personal use of this material is permitted. Permission from IEEE must be obtained for all other uses, in any current or future media, including reprinting/republishing this material for advertising or promotional purposes, creating new collective works, for resale or redistribution to servers or lists, or reuse of any copyrighted component of this work in other works.”

Constraint-Driven Multi-USV Coverage Path Generation for Aquatic Environmental Monitoring

Yo Toyomoto, *Student Member, IEEE*, Toshiyuki Oshima, *Student Member, IEEE*, Kosei Oishi, José M. Maestre, *Senior Member, IEEE*, and Takeshi Hatanaka, *Senior Member, IEEE*

Abstract—In this article, we address aquatic environmental monitoring using a fleet of unmanned surface vehicles (USVs). Specifically, we develop an online path generator that provides either of circular or elliptic paths based on the real-time feedback so that the USVs efficiently sample the sensor data over given aquatic environment. To this end, we begin by formulating a novel online path generation problem for a group of Dubins vehicles in the form of cost minimization based on the formulation of persistent coverage control. We then transform the cost minimization into a constraint-based specification so that a prescribed performance level is certified. An online coverage path generator is then designed based on the so-called constraint-based control in order to meet the performance certificate together with additional constraints inherent in the parameters that specify the paths. It is also shown there that the present constraint-based approach allows one to drastically reduce the computational complexity stemming from combinations of binary variables corresponding to the turning directions of the USVs. The present coverage path generator is finally demonstrated through simulations and experiments on an original testbed of multiple USVs.

Index Terms—coverage control, aquatic environmental monitoring, constraint-based control, unmanned surface vehicles

I. INTRODUCTION

Aquatic environmental monitoring with unmanned surface vehicles (USVs) or underwater vehicles equipped with external sensors is interesting for a variety of applications where different types of variables need to be monitored [1]. The literature includes heterogeneous examples such as the estimation of the thickness of lava eruptions by performing near-bottom magnetic surveys at the seafloor [2], the detection of plankton-rich waters by measuring chlorophyll density [3], the detection of pollution sources [4], and the generation of environmental maps of variables of interest (e.g., pH, temperature, dissolved oxygen, turbidity, etc.) [5], [6]. See also [7] for a specific survey on marine environmental applications that include the monitoring of multiple physical, biochemical, and ecosystem features.

Given the large extension of the areas that need to be covered, it is common to rely on a fleet of vehicles, which needs to be coordinated to maximize the efficiency of the operations. Typically, this involves the optimization of some type of criterion, e.g., the quality of the state estimation

[8], the performance of a control system with robots in the loop [9], metrics related to the entropy of the information gathered [10], or some type of utility function encoding optimal coverage and sensing policies, as in coverage control [11]. As pointed out by [12], which surveys source localization methods, the strategies followed by these multi-agent systems have strong commonalities with those used by nature, e.g., in chemotaxis and infotaxis processes. Moreover, some of the methods proposed are directly inspired in biology, e.g., the optimal coverage of dynamic pollutant profiles by mimicking bacterial swarms [13].

From methods available in the literature, we are especially interested in coverage control, which distributes a group of mobile sensors over the environment for efficient data sampling by following the gradient over an objective function [11]. From this basic setup, some variations have been proposed. For example, persistent coverage control stimulates the mobile sensors to continuously patrol the environment rather than forming a stationary configuration [14]–[16]. Other recent advances in coverage control include data-driven policies and dealing with unknown event density functions [17]–[19]. Finally, a significant topic in this context is that of constraints, which can also be accounted for by means of constraint-based control [20]. In this way, the coverage control policy can be aware of issues such as the battery levels—essential for long-duration autonomy of the robots [21]—, obstacles, and performance guarantees [15], [22], [23].

Despite these advances, most existing solutions assume a fully actuated kinematic model for the mobile robots, and cannot be applied to water vehicles having various motion constraints. The coverage control for robots with motion constraints similar to USVs has been investigated in the literature. The papers [24]–[26] considered a unicycle model with a nonholonomic constraint such that the lateral linear body velocity is constrained to be zero. While the linear body velocity in the forward direction was assumed to be fully controllable in these publications, most USVs do not have braking systems and can only generate thrust in the forward direction. In view of these hardware constraints, assuming a constant forward speed would be more realistic in many cases. To deal with this issue, some authors consider simplified models such as that of the Dubins vehicle, where constant forward speed is assumed [25], [27]. Coverage-like problems with motion constraints have also been investigated within the framework of the traveling salesman problem [28] and coverage path planning [29].

Additionally, the kinematic vehicle models assumed in the

Y. Toyomoto, T. Oshima, K. Oishi, and T. Hatanaka (corresponding author) are with School of Engineering, Tokyo Institute of Technology, 2-12-1 Ookayama, Meguro-ku, Tokyo 152-8550, Japan (e-mail: {toyomoto@hfg., oshima.t@hfg., oishi@hfg. hatanaka}@sc.e.titech.ac.jp). J.M. Maestre is with Systems and Automation Engineering Department, University of Sevilla, Camino de los Descubrimientos sn., 41092, Sevilla, Spain (e-mail: pepe-maestre@us.es).

above papers allow instantaneous velocity changes, but USVs may find problems to follow the velocities generated by coverage controllers due to their greater inertia. Another issue is that water vehicles may suffer significant disturbances due to currents, waves, and wind. For these reasons, in marine craft control it is common to employ a hierarchical architecture composed of control layers for guidance, navigation, and control [30]. Indeed, multiple works follow a backstepping approach [31], [32], where the overall control problem is decoupled into a high-level problem that generates ideal paths to follow and a low-level problem that makes USVs follow the path while rejecting disturbances. That is, the fleet trajectory design is decoupled from the individual trajectory tracking problem, as happens, for example, in [33]. With this in mind, it is not surprising that most results on coverage control with USVs focus on coverage path planning [34]–[36], leaving path following to low-level controllers. Nevertheless, even in these simpler setups, there are challenges to solve. For example, it is difficult to update the paths flexibly under real situations because path planning is executed in a different layer. In addition, the path-planning approach generates only a finite-length path, which may not be suitable for persistent monitoring of the aquatic environment.

In this article, we consider an online coverage path generation with real-time feedback on the states of the USVs. Specifically, we deal with circular and elliptic paths as the most basic path shapes. We then formulate a novel online optimal path generation problem corresponding to each path shape, which is based on the formulation of persistent coverage control [14]–[16]. To guarantee coverage performance for the path, we transform the specification for minimizing costs into a constraint-based specification. It is then pointed out that the problem may suffer from a combinatorial explosion associated with binary variables corresponding to the turning directions of the USVs. To address this issue, we present a more conservative scheme to reduce computational complexity, which is also shown to provide a partially distributed structure. We then present a partially distributed constraint-based control as in [15], [21]–[23] to meet the performance constraint together with constraints that parameters of the path are inherently required to satisfy. The proposed online coverage path generator is then demonstrated with an ideal mathematical model over a wide area free from the space constraints. We finally implement a hierarchical control architecture including the present coverage path generator on an experimental testbed, and demonstrate that the path generator works even in the presence of various uncertainties in the real physical world.

In summary, the contributions of this article are:

- 1) A novel online coverage path generation problem is presented, which generates persistently patrolling behavior, differently from offline coverage path planning.
- 2) To the best of the authors' knowledge, this article is the first to apply the concept of constraint-based control to the high-level path generation. Indeed, the constraint-based control is generally used as low-level safe control.
- 3) It is revealed that the possible computational explosion stemming from combinations of binary decision variables can be avoided by giving the specification as a

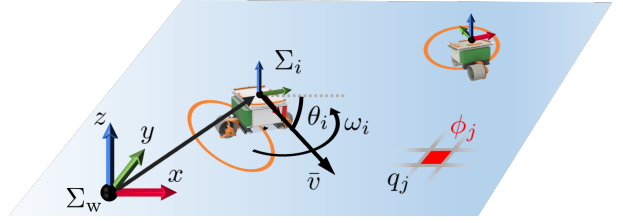

Fig. 1: USVs and environmental settings.

constraint rather than cost minimization.

- 4) The proposed path generator is demonstrated through simulations and also experiments on a real testbed.

Finally, notice that a very preliminary version of this work was presented in conference [37]. The current article presents a refined version of the proposed framework and also original simulations on elliptic paths and experiments.

II. PROBLEM FORMULATION

Let us consider a fleet of n USVs with identifiers $i = 1, 2, \dots, n$ located on a 2D plane. We denote the body frame of USV i as Σ_i , which is arranged to make the origin as the center of gravity and the x -axis parallel to the bow direction as illustrated in Fig. 1.

The position coordinates of the origin and rotation angle of Σ_i relative to the world frame Σ_w are denoted by $p_i \in \mathbb{R}^2$ and $\theta_i \in \mathbb{S}^1$, respectively. We suppose that the motion of USV i obeys so-called Dubins vehicle model

$$\begin{bmatrix} \dot{p}_i \\ \dot{\theta}_i \end{bmatrix} = \begin{bmatrix} \cos \theta_i & 0 \\ \sin \theta_i & 0 \\ 0 & 1 \end{bmatrix} \nu_i, \quad \nu_i = \begin{bmatrix} \bar{v} \\ \omega_i \end{bmatrix}, \quad (1)$$

where $\bar{v} \in \mathbb{R}$ is a constant linear body velocity and $\omega_i \in \mathbb{R}$ is the angular body velocity that is assumed to be controllable.¹ In other words, the USVs are assumed to be controlled by local controllers, designed *a priori*, so that $\dot{\theta}_i$ follows the reference velocity ω_i .

Suppose that USVs are equipped with external sensors to monitor the aquatic environment that is modeled by a subset of the 2D plane. We assign m observation points on the subset whose position coordinates in Σ_w are denoted by $q_j \in \mathbb{R}^2$, with $j = 1, 2, \dots, m$. The collection of q_j for all $j = 1, 2, \dots, m$ is denoted by \mathcal{Q} . Similar to coverage control, we define the sensing performance function $f(p_i, q_j)$, which quantifies the quality of the data associated with point q_j acquired by USV i at p_i . The function value $f(p_i, q_j)$ is assumed to increase as the distance between p_i and q_j decreases: specifically, we consider the function

$$f(p_i, q_j) = \exp \left\{ -\frac{\|p_i - q_j\|^2}{2\sigma^2} \right\}, \quad (2)$$

where $\sigma > 0$ denotes a tuning parameter.

Let us assign an importance index $\phi_j \geq 0$ to each point q_j , quantifying its relative importance so that USVs are required

¹Assuming controllable linear velocities is also conceivable, but we take the present formulation since most USVs do not have braking mechanisms.

to monitor observation points with a higher index. According to persistent coverage control, we update the index ϕ_j by

$$\dot{\phi}_j = \left[\bar{\delta} - \underline{\delta} \max_{i=1,2,\dots,n} f(p_i, q_j) \phi_j \right]_{\phi_j}^{[\underline{\phi}, \bar{\phi}]}, \quad (3)$$

where $\bar{\delta}, \underline{\delta}$ are positive scalars and the operator

$$[a]_{\phi_j}^{[\underline{\phi}, \bar{\phi}]} = \begin{cases} 0, & \text{if } a > 0 \text{ and } \phi_j = \bar{\phi} \\ 0, & \text{if } a < 0 \text{ and } \phi_j = \underline{\phi} \\ a, & \text{otherwise} \end{cases}$$

is introduced to limit ϕ_j within a specified range $[\underline{\phi}, \bar{\phi}]$, assuming that $\phi_j(0) \in [\underline{\phi}, \bar{\phi}]$. Similarly to [14]–[16], we suppose that the update of the importance indices ϕ_j in (3) is executed by a central computer.

In this article, we design an online path generator to efficiently sample data on all points q_j ($j = 1, 2, \dots, m$), assuming two types of closed paths, namely circular and elliptic paths, so as to reduce the number of parameters that characterize the path.

A. Circular Path Generation Problem

Let us first consider the circular path:

$$\mathcal{P}_c(c_i, r_i) = \{p \in \mathbb{R}^2 \mid \|p - c_i\|^2 = r_i^2\}, \quad (4)$$

where $c_i \in \mathbb{R}^2$ is the center of the circle and $r_i > 0$ is the radius. Each USV i updates these parameters in real time to define its path to follow.

We present next the constraints that path $\mathcal{P}_c(c_i, r_i)$ must satisfy. First, p_i must be located on the path. Additionally, the path at p_i must be tangent with the bow direction so that USV i follows the path while satisfying the nonholonomic constraint in (1). Denoting $\mathbf{e}_1 = [1 \ 0]^\top$ and $\mathbf{e}_2 = [0 \ 1]^\top$, these constraints are formulated as

$$\|p_i(t) - c_i\|^2 = r_i^2, \quad (5a)$$

$$\frac{\mathbf{e}_1^\top (p_i(t) - c_i)}{\mathbf{e}_2^\top (p_i(t) - c_i)} = \frac{\sin \theta_i(t)}{\cos \theta_i(t)}, \quad (5b)$$

respectively. Solving the quadratic equation (5a) together with (5b) for c_i yields two solutions, which correspond to the right-hand turning path, denoted by r, and left-hand one, denoted by l, as illustrated in Fig. 2. Thus, the turning direction becomes another decision variable for each USV i , which is denoted by $X_i \in \mathcal{X}_i = \{r, l\}$. Notice that once the turning direction $X_i \in \mathcal{X}_i$ is fixed, we can eliminate the variable c_i by solving (5) in advance. Specifically, given $z_i(t) = [p_i^\top(t) \ \theta_i(t)]^\top$, the center c_i meeting (5) is given by

$$c_i^r(r_i; z_i(t)) = p_i(t) + r_i \begin{bmatrix} \sin \theta_i(t) \\ -\cos \theta_i(t) \end{bmatrix} \quad (6)$$

when $X_i = r$. Meanwhile, $X_i = l$ yields

$$c_i^l(r_i; z_i(t)) = p_i(t) - r_i \begin{bmatrix} \sin \theta_i(t) \\ -\cos \theta_i(t) \end{bmatrix}. \quad (7)$$

Let us next define a metric to evaluate the circular path $\mathcal{P}_c(c_i, r_i)$. Followed by USV i based on the sensing performance function (2), considering that USV i would sample

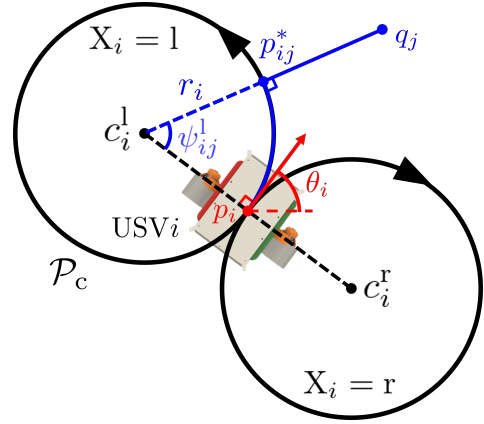

Fig. 2: Two possible circular paths with right-hand and left-hand turning.

the most accurate data on point q_j at the closest point $p_{ij}^*(c_i, r_i) \in \mathcal{P}_c(c_i, r_i)$, which is defined by

$$p_{ij}^*(c_i, r_i) = c_i + \frac{r_i}{\|q_j - c_i\|} (q_j - c_i). \quad (8)$$

Accordingly, the value $f(p_{ij}^*(c_i, r_i), q_j)$ provides a measure on the quality of the path $\mathcal{P}_c(c_i, r_i)$. Nevertheless, the path is changing in real time, so the USV may not actually visit point $p_{ij}^*(c_i, r_i)$. This motivates us to scale $f(p_{ij}^*(c_i, r_i), q_j)$ depending on the time required for the USV at p_i to arrive at $p_{ij}^*(c_i, r_i)$, which is proportional to the arc angle from p_i to $p_{ij}^*(c_i, r_i)$, defined as

$$\psi_{ij}^r(c_i, r_i) = \pi - \varphi_i^r \left(q_j, \frac{\pi}{2} - \theta_i \right), \quad (9)$$

$$\psi_{ij}^l(c_i, r_i) = \pi + \varphi_i^l \left(q_j, -\frac{\pi}{2} - \theta_i \right), \quad (10)$$

depending on the turning direction, where ²

$$\varphi_i^{X_i}(q, \vartheta) = \text{atan2}\{\mathbf{e}_2^\top R_\vartheta(q - c_i^{X_i}), \mathbf{e}_1^\top R_\vartheta(q - c_i^{X_i})\},$$

$$R_\vartheta = \begin{bmatrix} \cos \vartheta & -\sin \vartheta \\ \sin \vartheta & \cos \vartheta \end{bmatrix}, \quad q \in \mathbb{R}^2, \quad \vartheta \in \mathbb{S}^1.$$

In summary, we define a metric associated with the measurement of point q_j along the circular path $\mathcal{P}_c(c_i, r_i)$ as

$$h_{c_i, r_i}^{X_i}(c_i, r_i) := f(p_{ij}^*(c_i, r_i), q_j) \left(2\pi - \psi_{ij}^{X_i}(c_i, r_i) \right), \quad (11)$$

where $X_i \in \mathcal{X}_i$.

Using the function $h_{c_i, r_i}^{X_i}(c_i, r_i)$ and the importance index ϕ_j , we define the metric to evaluate the circular paths as

$$J_c^X(c, r) = \sum_{j=1}^m \max_{i=1, \dots, n} h_{c_i, r_i}^{X_i}(c_i, r_i) \phi_j(t), \quad (12)$$

following the manner of coverage control [11], [14]–[16], where $c = [c_1^\top \ c_2^\top \ \dots \ c_n^\top]^\top$, $r = [r_1 \ r_2 \ \dots \ r_n]^\top$, and $X = (X_i)_{i=1}^n$. Now, since both of the function J_c^X and the constraints (5) are changing in time due to the variations of $\phi_j(t)$ and $z_i(t)$ in real time, it is difficult to maximize J_c^X

²The atan2 function adheres to the IEEE 754 standard.

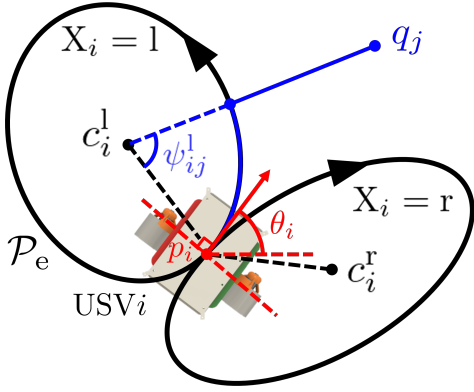

Fig. 3: Two possible elliptic paths with right-hand and left-hand turning.

while meeting (5) instantaneously. Also, the gradient-based methodology in [14] does not provide any performance guarantee. We thus relax the objective and consider the constraint-based specification

$$J_c^X(c, r) \geq \gamma, \quad (13)$$

where $\gamma > 0$ is a prescribed performance level to be certified. The control goal is thus to update c_i , r_i , and X_i for all $i = 1, 2, \dots, n$ so as to satisfy (5) and (13).

B. Elliptic Path Generation Problem

Let us next consider the elliptic path $\mathcal{P}_e(c_i, S_i)$ formulated as below.

$$\mathcal{P}_e(c_i, S_i) = \{p \in \mathbb{R}^2 \mid (p - c_i)^\top S_i^2 (p - c_i) = 1\}, \quad (14)$$

where $c_i \in \mathbb{R}^2$ is the center of the ellipse, and $S_i \in \mathbb{R}^{2 \times 2}$ is a positive-definite symmetric matrix that determines the shape and size of the ellipse. In the sequel, the collection of the elements (1,1), (1,2), and (2,2) of S_i is denoted by $s_i \in \mathbb{R}^3$.

The constraints corresponding to (5) are formulated as:

$$(p_i(t) - c_i)^\top S_i^2 (p_i(t) - c_i) = 1, \quad (15a)$$

$$-\frac{\mathbf{e}_1^\top S_i^2 (p_i(t) - c_i)}{\mathbf{e}_2^\top S_i^2 (p_i(t) - c_i)} = \frac{\sin \theta_i(t)}{\cos \theta_i(t)}, \quad (15b)$$

respectively. Analogous to the analysis in Section II-A, the solution to (15) for c_i yields two alternatives, each corresponding to a turning direction $X_i \in \mathcal{X}_i$, as depicted in Fig. 3. Upon fixing the direction X_i , the center c_i satisfying (15) is uniquely determined as a function of s_i . Specifically, when $X_i = r$, the center c_i meeting (15) for a given $z_i(t)$ is formulated as

$$c_i^r(s_i; z_i(t)) = p_i(t) + \beta(s_i, \theta_i) \begin{bmatrix} \sin \theta_i(t) \\ -\cos \theta_i(t) \end{bmatrix}, \quad (16)$$

where

$$\beta(s_i, \theta_i) = \frac{S_i^{-2}}{\sqrt{\begin{bmatrix} \sin \theta_i(t) \\ -\cos \theta_i(t) \end{bmatrix}^\top S_i^{-2} \begin{bmatrix} \sin \theta_i(t) \\ -\cos \theta_i(t) \end{bmatrix}}}.$$

Meanwhile, when $X_i = l$, it is formulated as

$$c_i^l(s_i; z_i(t)) = p_i(t) - \beta(s_i, \theta_i) \begin{bmatrix} \sin \theta_i(t) \\ -\cos \theta_i(t) \end{bmatrix}. \quad (17)$$

We next define a metric to evaluate the elliptic path $\mathcal{P}_e(c_i, S_i)$. Unlike the circular path, the minimum Euclidean distance between a point and an ellipse $\mathcal{P}_e(c_i, S_i)$ lacks a closed-form expression [39]. Therefore, we use the following Sampson's-like distance d_s to estimate the sensing performance for each point q_j :

$$h_{e,ij}^{X_i}(c_i, s_i) = \exp \left\{ -\frac{d_s^2(c_i, s_i, q_j)}{2\sigma^2} \right\} \left(2\pi - \psi_{ij}^{X_i}(c_i, s_i) \right),$$

$$d_s(c_i, s_i, q_j) = \left| \sqrt{(q_j - c_i)^\top S_i^2 (q_j - c_i) - 1} \right|. \quad (18)$$

The function $\psi_{ij}^{X_i}(c_i, s_i)$ in (18) is introduced to scale the path quality, similarly to the circular path, which is given by

$$\psi_{ij}^r(c_i, s_i) = \pi - \varphi_i^r(q_j, \frac{\pi}{2} - \theta_i), \quad (19)$$

$$\psi_{ij}^l(c_i, s_i) = \pi + \varphi_i^l(q_j, -\frac{\pi}{2} - \theta_i), \quad (20)$$

with

$$\varphi_i^{X_i}(q, \vartheta) = \text{atan2}\{\mathbf{e}_2^\top R_\vartheta S_i (q - c_i^{X_i}), \mathbf{e}_1^\top R_\vartheta S_i (q - c_i^{X_i})\},$$

$$R_\vartheta = \begin{bmatrix} \cos \vartheta & -\sin \vartheta \\ \sin \vartheta & \cos \vartheta \end{bmatrix}, \quad q \in \mathbb{R}^2, \quad \vartheta \in \mathbb{S}^1.$$

Remark that while more precise approximations of the Euclidean distance are available [39], we opt for the present approximation for its computational simplicity.

Using the function $h_{e,ij}^{X_i}(c_i, s_i)$ and the importance index ϕ_j , we define the following metric to evaluate the elliptic paths

$$J_e^X(c, s) = \sum_{j=1}^m \max_{i=1, \dots, n} h_{e,ij}^{X_i}(c_i, s_i) \phi_j(t), \quad (21)$$

where $s = [s_1^\top \ s_2^\top \ \dots \ s_n^\top]^\top$.

Finally, a constraint-based specification corresponding to (13) is expressed as

$$J_e^X(c, s) \geq \gamma, \quad (22)$$

where $\gamma > 0$ is a prescribed performance level to be certified. The control goal is to update c_i , s_i , and X_i for all $i = 1, 2, \dots, n$ so that (15) and (22) are satisfied.

III. ONLINE COVERAGE PATH GENERATION

In this section, we propose a coverage path generator based on the concept of constraint-based control. This method achieves partially distributed coverage performance guarantees with some additional constraints to specify the path size and shape.

A. Circular Coverage Path Generator

Let us first consider the circular path $\mathcal{P}_c(c_i, r_i)$.

We begin by eliminating the variable c_i from the function J_c^X by substituting (6) and (7) into (12) as

$$J_c^X(r; z(t), \phi(t)) = \sum_{j=1}^m \max_{i=1, \dots, n} g_{c,ij}^{X_i}(r_i; z_i(t)) \phi_j(t), \quad (23)$$

$$g_{c,ij}^{X_i}(r_i; z_i(t)) = h_{c,ij}^{X_i}(c_i^{X_i}(r_i; z_i(t)), r_i), \quad (24)$$

where $z(t) = [z_1^\top(t) \ z_2^\top(t) \ \cdots \ z_n^\top(t)]^\top$ and $\phi(t) = [\phi_1(t) \ \phi_2(t) \ \cdots \ \phi_m(t)]^\top$. Accordingly, the constraints (5) and (13) are simplified to a single inequality constraint

$$J_c^X(r; z(t), \phi(t)) \geq \gamma. \quad (25)$$

The goal of this section is thus to determine a pair of r and $X \in \mathcal{X}$ so that the inequality

$$b_c^1(r, X; z(t), \phi(t)) = J_c^X(r; z(t), \phi(t)) - \gamma \geq 0 \quad (26)$$

is satisfied for all time $t \geq 0$, where $\mathcal{X} = \mathcal{X}_1 \times \cdots \times \mathcal{X}_n$.

We further set limits for the path radius r_i as $r_i \in [r_{\min}, r_{\max}]$ with $r_{\max} > r_{\min} > 0$. This constraint can be expressed by inequalities:

$$b_{c,i}^2(r_i) = r_i - r_{\min} \geq 0 \quad (27a)$$

$$b_{c,i}^3(r_i) = r_{\max} - r_i \geq 0 \quad (27b)$$

for all $i = 1, 2, \dots, n$.

Now, the constraint (26) essentially comprises 2^n combinations corresponding to the elements of the set \mathcal{X} , which may cause computational problems. We thus consider an alternative constraint while accepting conservatism. To this end, let us define a Voronoi-like partition of the finite set \mathcal{Q} as

$$\begin{aligned} \mathcal{V}_{c,i}(r, X; z(t)) &= \{q_j \in \mathcal{Q} \\ &g_{c,ij}^{X_i}(r_i; z_i(t)) \geq g_{c,lj}^{X_i}(r_l; z_l(t)) \ \forall l \neq i\}. \end{aligned} \quad (28)$$

Then, (23) is decomposed into

$$J_c^X(r; z(t), \phi(t)) = \sum_{j: q_j \in \mathcal{V}_{c,i}(r, X; z(t))} g_{c,ij}^{X_i}(r_i; z_i(t)) \phi_j(t). \quad (29)$$

We assume that the central computer computes the set $\mathcal{V}_{c,i}$ as well as running (3), since the set may be hard to compute by individual USVs. Then, every USV i receives the set $\mathcal{V}_{c,i}$ in addition to the importance indices ϕ_j for the points q_j included in $\mathcal{V}_{c,i}$.

Now, the set $\mathcal{V}_{c,i}$ received by USV i most recently at time t is denoted by $\mathcal{V}_{c,i}^-(t)$. Then, we obtain the following theorem.

Theorem 1: Define

$$b_{c,i}^1(r_i; z_i(t), \phi(t)) = \max_{X_i \in \mathcal{X}_i} I_{c,i}^{X_i}(r_i; z_i(t), \phi(t)) - \frac{\gamma}{n}, \quad (30)$$

$$I_{c,i}^{X_i}(r_i; z_i(t), \phi(t)) = \sum_{j: q_j \in \mathcal{V}_{c,i}^-(t)} g_{c,ij}^{X_i}(r_i; z_i(t)) \phi_j(t). \quad (31)$$

Suppose now that r_i is selected so that $b_{c,i}^1(r_i; z_i(t), \phi(t)) \geq 0$ holds, and that $X_i \in \mathcal{X}_i$ is determined by

$$X_i = \arg \max_{X_i \in \mathcal{X}_i} I_{c,i}^{X_i}(r_i; z_i(t), \phi(t)) \quad (32)$$

for all $i = 1, 2, \dots, n$. Then, the constraint (26) is satisfied.

Proof: For any $X \in \mathcal{X}$, we have that

$$\begin{aligned} J_c^X(r; z(t), \phi(t)) &\geq \sum_{i=1}^n \sum_{j: q_j \in \mathcal{V}_{c,i}^-(t)} g_{c,ij}^{X_i}(r_i; z_i(t)) \phi_j, \\ &= \sum_{i=1}^n I_{c,i}^{X_i}(r_i; z_i(t), \phi(t)) \end{aligned}$$

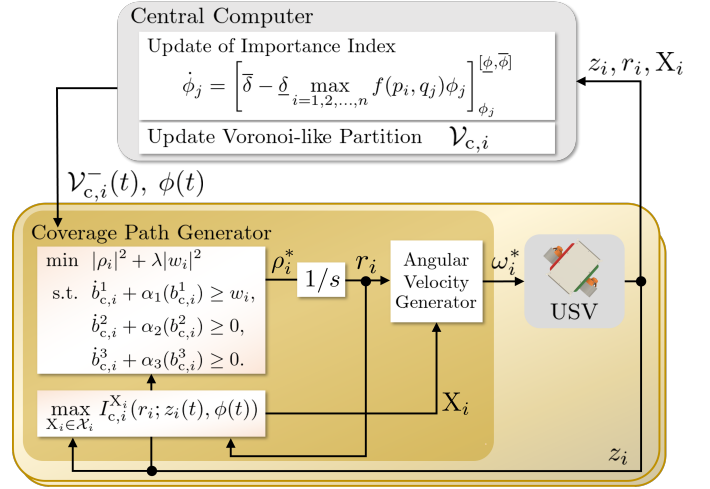

Fig. 4: Control architecture consisting of distributed circular path generators and a central computer.

where equality holds only when $\mathcal{V}_{c,i}^-(t) = \mathcal{V}_{c,i}(r, X; z(t))$ for all $i = 1, 2, \dots, n$ because of (29). Thus, from (32), we have

$$\begin{aligned} b_c^1(r, X; z(t), \phi(t)) &= J_c^X(r; z(t), \phi(t)) - \gamma \\ &\geq \sum_{i=1}^n I_{c,i}^{X_i}(r_i; z_i(t), \phi(t)) - \gamma \\ &= \sum_{i=1}^n b_{c,i}^1(r_i; z_i(t), \phi(t)) \geq 0. \end{aligned}$$

This completes the proof. \blacksquare

The function $b_{c,i}^1$ in (30) includes only X_i , which unlike (26) has two options, r and l , drastically reducing the computational effort for meeting the associated inequality constraints. Consequentially, we take $b_{c,i}^1 \geq 0$ ($i = 1, 2, \dots, n$) instead of (26) at the cost of conservatism. Besides the reduction of the computational effort, the constraint $b_{c,i}^1 \geq 0$ ($i = 1, 2, \dots, n$) allows the partially distributed implementation of the present algorithm. That is, given $\mathcal{V}_{c,i}^-(t)$ from a central computer, the constraint $b_{c,i}^1 \geq 0$ is handled locally by USV i ($i = 1, 2, \dots, n$), and (32) is also locally executed by USV i . The overall control architecture is illustrated in Fig. 4.

Let us now assume that the update rule of r_i is given by $\dot{r}_i = \rho_i$. Then, with slight abuse of notation, we present the following constraint-based controller:

$$\begin{aligned} (\rho_i^*, w_i^*) &= \arg \min |\rho_i|^2 + \lambda |w_i|^2 \text{ subject to:} \\ &b_{c,i}^1 + \alpha_1(b_{c,i}^1) \geq w_i, \\ &b_{c,i}^2 + \alpha_2(b_{c,i}^2) \geq 0, \\ &b_{c,i}^3 + \alpha_3(b_{c,i}^3) \geq 0, \end{aligned} \quad (33)$$

where w_i is a slack variable, $\lambda > 0$ is a penalty parameter for violations on $b_{c,i}^1 \geq 0$, and α_1 , α_2 and α_3 are extended class \mathcal{K} functions. The description in (33) slightly lacks rigor since $b_{c,i}^1$ may not be differentiable in time due to the pointwise maximum in (30). However, the possible nondifferentiability of $b_{c,i}^1$ is treated in the same way as [38] (see Appendix A for more details on the issue). We then determine X_i based on (32). When r_i and X_i are updated, center c_i is computed using either (6) or (7), depending on whether $X_i = r$ or $X_i = l$.

Once a circular path $\mathcal{P}_c(c_i, r_i)$ and turning direction X_i are fixed, the angular velocity to follow the path is uniquely determined by

$$\omega_i^* = \zeta(X_i) \frac{\bar{v}}{r_i}, \quad (34)$$

where $\zeta(X_i) = -1$ if $X_i = r$ and $\zeta(X_i) = 1$ if $X_i = l$.

B. Elliptic Coverage Path Generator

Next, we consider the elliptic path $\mathcal{P}_e(c_i, S_i)$. Similarly to Section III-A, we first eliminate the variable c_i by substituting equations (16) and (17) into (21), yielding

$$J_e^X(s; z(t), \phi(t)) = \sum_{j=1}^m \max_{i=1, \dots, n} g_{e,ij}^{X_i}(s_i; z_i(t)) \phi_j(t), \quad (35)$$

$$g_{e,ij}^{X_i}(s_i; z_i(t)) = h_{e,ij}^{X_i}(c_i^{X_i}(s_i; z_i(t)), s_i). \quad (36)$$

Accordingly, the constraints (15) and (22) are simplified to a single inequality constraint

$$J_e^X(s; z(t), \phi(t)) \geq \gamma. \quad (37)$$

Now the goal is to determine the variables s and X so that the inequality

$$b_e^1(s, X; z(t), \phi(t)) = J_e^X(s; z(t), \phi(t)) - \gamma \geq 0 \quad (38)$$

is satisfied for all time $t \geq 0$.

In order to bound the size of the ellipse, we constrain the eigenvalues of the matrix S_i as

$$1/s_{\max} I_2 \preceq S_i \preceq 1/s_{\min} I_2, \quad (39)$$

where I_2 is the 2-by-2 identity matrix, and $s_{\max} > s_{\min} > 0$. Using the Schur complement, the above matrix inequality constraints are reformulated as the collection of the inequalities as:

$$b_{e,i}^2(s_i) = \frac{1}{s_{\min}} - s_{i1} \geq 0 \quad (40a)$$

$$b_{e,i}^3(s_i) = \frac{1}{s_{\min}} - s_{i3} - \frac{(s_{i2})^2}{1/s_{\min} - s_{i1}} \geq 0 \quad (40b)$$

$$b_{e,i}^4(s_i) = s_{i1} - \frac{1}{s_{\max}} \geq 0 \quad (40c)$$

$$b_{e,i}^5(s_i) = s_{i3} - \frac{1}{s_{\max}} - \frac{(s_{i2})^2}{s_{i1} - 1/s_{\max}} \geq 0 \quad (40d)$$

for all $i = 1, 2, \dots, n$, where $s_i = [s_{i1} \ s_{i2} \ s_{i3}]^\top$.

Similarly to Section III-A, we define the Voronoi-like partition of the finite set \mathcal{Q} as

$$\begin{aligned} \mathcal{V}_{e,i}(s, X; z(t)) &= \{q_j \in \mathcal{Q} \\ &g_{e,ij}^{X_i}(s_i; z_i(t)) \geq g_{e,lj}^{X_l}(s_l; z_l(t)) \ \forall l \neq i\}. \end{aligned} \quad (41)$$

Then, (35) is decomposed into

$$J_e^X(s; z(t), \phi(t)) = \sum_{j: q_j \in \mathcal{V}_{e,i}(s, X; z(t))} g_{e,ij}^{X_i}(s_i; z_i(t)) \phi_j(t) \quad (42)$$

Again, the most recent set $\mathcal{V}_{e,i}$ received by USV i from the central computer at time t is denoted by $\mathcal{V}_{e,i}^-(t)$. Then, we obtain the following theorem.

Theorem 2: Define

$$b_{e,i}^1(s_i; z_i(t), \phi(t)) = \max_{X_i \in \mathcal{X}_i} I_{e,i}^{X_i}(s_i; z_i(t), \phi(t)) - \frac{\gamma}{n}, \quad (43)$$

$$I_{e,i}^{X_i}(s_i; z_i(t), \phi(t)) = \sum_{j: q_j \in \mathcal{V}_{e,i}^-(t)} g_{e,ij}^{X_i}(s_i; z_i(t)) \phi_j(t). \quad (44)$$

Suppose now that s_i is selected so that $b_{e,i}^1(s_i; z_i(t), \phi(t)) \geq 0$ holds, and that $X_i \in \mathcal{X}_i$ is determined by

$$X_i = \arg \max_{X_i \in \mathcal{X}_i} I_{e,i}^{X_i}(s_i; z_i(t), \phi(t)) \quad (45)$$

for all $i = 1, 2, \dots, n$. Then, the constraint (38) is satisfied. The proof is omitted, but notice that this theorem can be proven in the same way as Theorem 1.

Assuming that the update rule of s_i is $\dot{s}_i = \rho_i \in \mathbb{R}^3$, we design the following constraint-based controller:

$$\begin{aligned} (\rho_i^*, w_i^*) &= \arg \min \quad \|\rho_i\|^2 + \lambda |w_i|^2 \text{ subject to:} \\ &b_{e,i}^1 + \alpha_1 (b_{e,i}^1) \geq w_i, \\ &\dot{b}_{e,i}^k + \alpha_k (b_{e,i}^k) \geq 0, \quad (k = 2, 3, 4, 5) \end{aligned} \quad (46)$$

where w_i is a slack variable, $\lambda > 0$ is a penalty parameter for violations on $b_{e,i}^1 \geq 0$, and α_1 and $\alpha_{2, \dots, 5}$ are extended class \mathcal{K} functions. The quadratic programming representation corresponding to (46) is shown in Appendix B. Once s_i is updated by the designed ρ_i , we then update X_i based on (45). When the variables s_i and X_i are updated, the center c_i is computed using either (16) or (17), depending on whether $X_i = r$ or $X_i = l$.

Once an elliptic path $\mathcal{P}_e(c_i, S_i)$ and turning direction X_i are fixed, the angular velocity to follow the path is given by

$$\omega_i^* = \zeta(X_i) \bar{v} \kappa(p_i, c_i, S_i), \quad (47)$$

$$\kappa(p_i, c_i, S_i) = \frac{|r_x r_y|}{r_x^2 \sin^2 \varphi_S + r_y^2 \cos^2 \varphi_S}, \quad (48)$$

$$\varphi_S = \text{atan2}\{\mathbf{e}_2^\top R_{\vartheta_S}(p_i - c_i), \mathbf{e}_1^\top R_{\vartheta_S}(p_i - c_i)\}, \quad (49)$$

where $\kappa(p_i, c_i, S_i)$ represents the curvature of the elliptic path $\mathcal{P}_e(c_i, S_i)$ at p_i , r_x and r_y are the reciprocal number of the eigenvalues of S_i , and ϑ_S is a rotation angle of an eigenvector v_{r_x} , corresponding to an eigenvalue r_x , which is given as $\vartheta_S = \text{atan2}(\mathbf{e}_2^\top v_{r_x}, \mathbf{e}_1^\top v_{r_x})$.

IV. SIMULATION WITH IDEAL MATHEMATICAL MODEL

In this section, we demonstrate the proposed online elliptic path generator for two USVs using an ideal mathematical model (1) with a constant forward velocity $\bar{v} = 0.26\text{m/s}$ ($i = 1, 2$) on Robot Operating System (ROS) 2 [40]. The main motivation for conducting simulations apart from the experiments in the next section is to purely demonstrate the path generator without the environmental space constraints, which are inherent to our experiments. Note that the angular

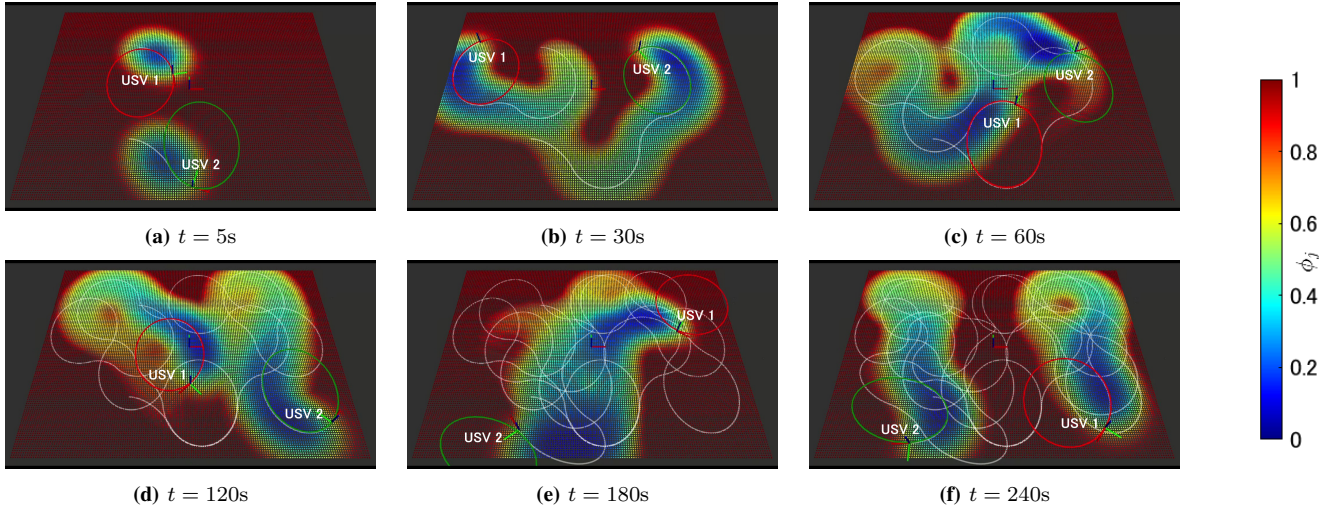

Fig. 5: Snapshots of the simulation. The red and green elliptic paths correspond to USV 1 and USV 2, respectively. White curves show the trajectories of the two USVs recorded after $t = 0$ s.

velocity in (47) is directly applied to each USV as $\omega_i = \omega_i^*$ in the subsequent simulation.

The environment \mathcal{Q} is set to 8×6 m square and discretized into $m = 19200$ cells of equal area. The initial values of the importance indices are set as $\phi_j(0) = 1 \forall j$, and all ϕ_j are upper bounded by $\bar{\phi} = 1$ and lower bounded by $\underline{\phi} = 0$. Parameters in its update law (3) are selected as $\sigma = 0.5$, $\bar{\delta} = 0.02$ and $\underline{\delta} = 0.5$. The prescribed performance level is set to $\gamma = 10.0$. The initial states of the USVs were selected as $p_1(0) = [-1.5 \ 1.5]^\top$ m, $p_2(0) = [-1.5 \ -1.5]^\top$ m, $\theta_i(0) = 0$ ($i = 1, 2$), and the initial states and limitations of the elliptic paths were set to $s_{i1}(0) = 1.0$, $s_{i2}(0) = 0.2$, $s_{i3}(0) = 0.7$, $X_i(0) = r$ ($i = 1, 2$). The parameters s_{\min} and s_{\max} are set as $s_{\min} = 0.5$ m, $s_{\max} = 1.2$ m, respectively. The functions and the penalty parameter in the constraint-based controller (46) are chosen as $\alpha_k(x) = x$ for all $k = 1, 2, \dots, 5$ and $\lambda = 0.1$.

The movie of the simulation is uploaded to <https://youtu.be/DfWwMAWdaZc?si=3H2nfHvnl7wsEAKP>, whose snapshots are shown in Fig. 5. The white curves show the trajectories of the USVs. Since the paths are updated online, the trajectories are no longer the ellipses. The color map of the environment shows the value of the importance index ϕ_j , where red region indicates high values and blue low values. We observe from the movie and the snapshots that both USVs update the elliptic paths so that they pass through the red area.

The time evolution of the functions $b_{e,1}^1$ (red) and $b_{e,2}^1$ (blue) are shown in Fig. 6. We observe from the figure that $b_{e,i}^1 \geq 0$ is satisfied at almost all times. This implies that the present path generator almost certifies the performance guarantee. However, the constraint is violated only at around 160s. In order to further investigate the violation, we show the time evolution of the functions $b_{e,1}^k$ ($k = 2, 3, 4, 5$) for USV 1 in Fig. 7. We see from this figure that $b_{e,1}^5$ is close to the lower limit and the constraint associated with $b_{e,1}^5$ gets active during the period. We conclude from these figures that the constraint violations in Fig. 6 are caused by the relaxation of

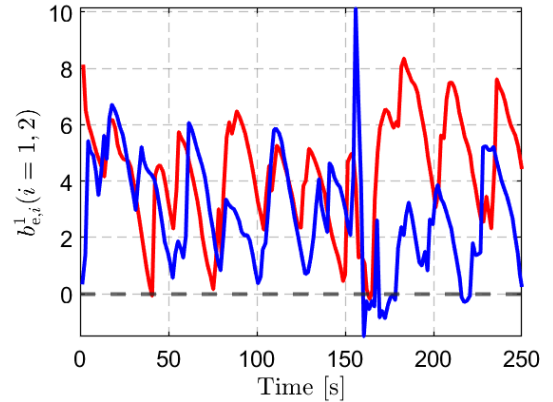

Fig. 6: Time evolution of the functions $b_{e,1}^1$ (red) and $b_{e,2}^1$ (blue).

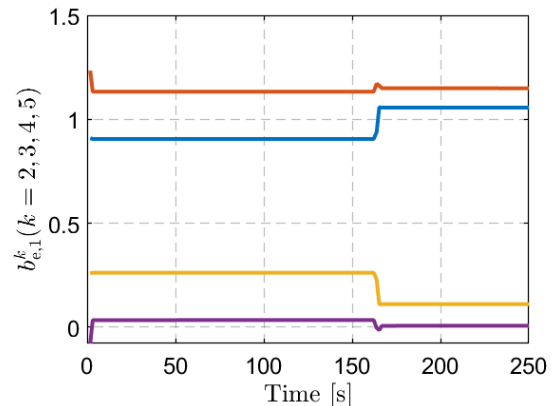

Fig. 7: Time evolution of the functions $b_{e,1}^2$ (cyan), $b_{e,1}^3$ (orange), $b_{e,1}^4$ (yellow), $b_{e,1}^5$ (purple) associated with the elliptic shape and size constraints for USV 1.

the performance constraints to soft constraints in (46).

From these results, we conclude that the present path generator works as expected, at least for an ideal mathematical model (1).

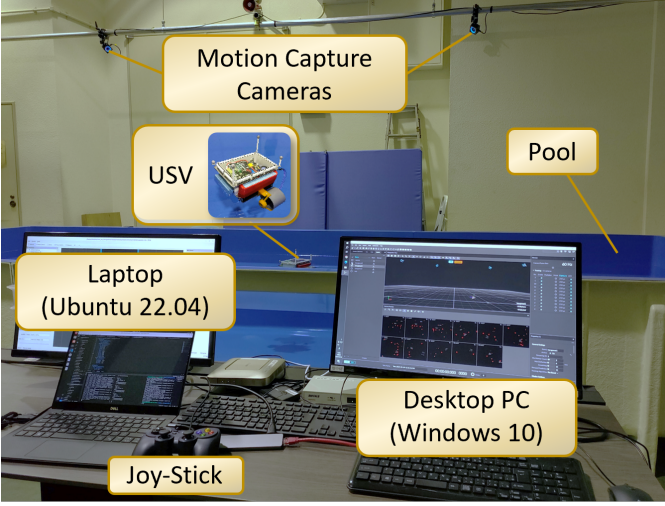

Fig. 8: Overview of the experimental testbed.

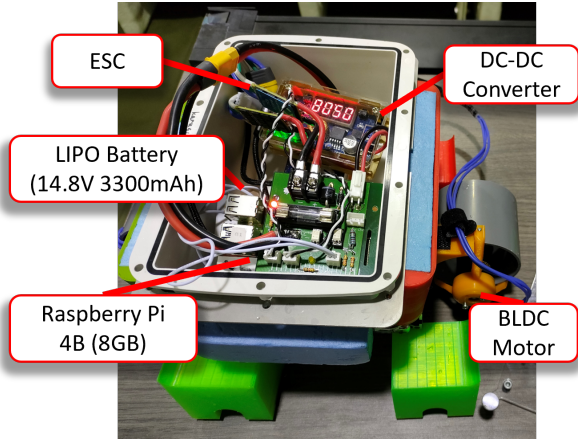

Fig. 9: Internal structure of the USV.

V. EXPERIMENTAL DEMONSTRATION

In this section, we demonstrate the present coverage path generator using multiple experimental USVs in the aquatic control testbed called Robot Zoo Aqua [41]. The overview of the testbed is shown in Fig. 8, where the size of the pool is $5\text{m} \times 1.8\text{m}$.

A. Experimental Testbed

We used USVs whose internal structure is shown in Fig. 9. USV is equipped with two brushless direct current (BLDC) motors facing the rear side which provide propulsion through their electric drive. A lithium polymer battery supplies 14.8V directly to the motors and 5V to a Raspberry Pi 4 via a DC-DC converter. The motors are independently controlled by a control circuit using the Raspberry Pi 4 and an electronic speed controller (ESC) produced by Blue Robotics Inc. The USV launches a ROS 2 program on its onboard Raspberry Pi 4, allowing it to receive velocity commands sent by a laptop PC running on Ubuntu 22.04 and ROS 2 program via the Wi-Fi network.

Eleven motion capture cameras, Optitrack Prime 13X (NaturalPoint Inc.), are mounted above the pool. The motion

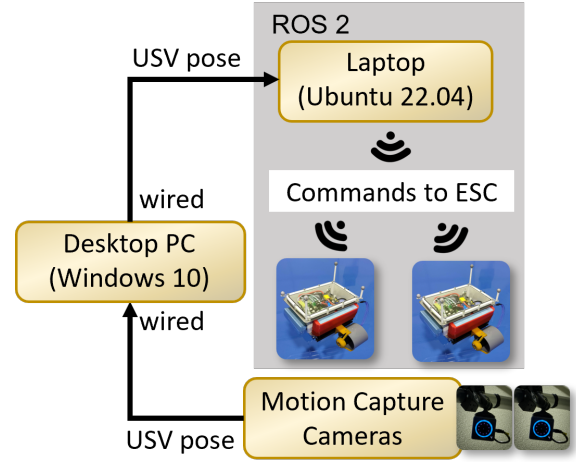

Fig. 10: Schematic of the experimental testbed.

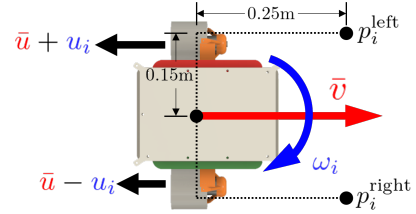

Fig. 11: Ideal physical model of USV.

capture system with the data processing software, Motive (NaturalPoint Inc.), provides the USVs' poses to the laptop in real time using Virtual-Reality Peripheral Network. ROS 2 nodes running on the laptop implement the proposed coverage path generator and the local USV controller to track the path. The resulting command signals are sent to the onboard Raspberry Pi 4. The overall schematic of the experimental system configuration is shown in Fig. 10.

B. Modeling and Local Controller Design

Let us next identify the dynamic model of the USV from the command signal, received from the laptop, to the angular velocity ω_i computed by a numerical differentiation for the rotation angle measured by the motion capture system.

An ideal physical model of the USV is shown in Fig. 11. Let us now denote the pulse widths in microseconds for the right and left BLDC motors by u_i^{right} and u_i^{left} , respectively. In view of (1) assumed in the previous sections, we fixed u_i^{right} and u_i^{left} as:

$$u_i^{\text{right}} = 1500 + 100(\bar{u} - u_i), \quad (50a)$$

$$u_i^{\text{left}} = 1500 + 100(\bar{u} + u_i), \quad (50b)$$

where \bar{u} is a constant specifying the forward velocity \bar{v} , and was set to $\bar{u} = 0.8$.

We conducted identification experiments setting u_i to an M-sequence random signal, and collected two pairs of the input/output data, which are used as training and test data, respectively. We then identified the system through MAT-

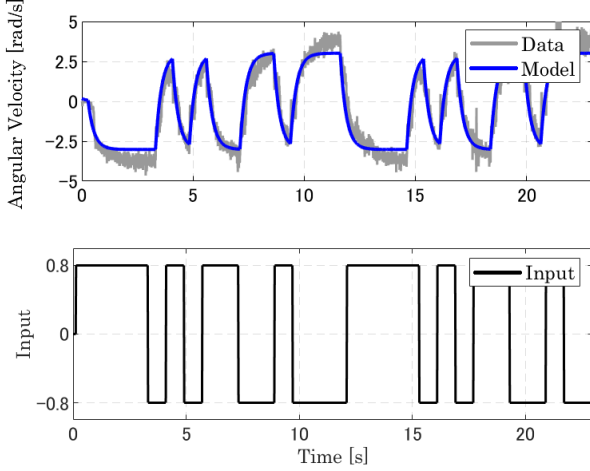

Fig. 12: Time series data of the model outputs (blue), and the actual output data (gray) and the input data (black).

LAB/Simulink System Identification Toolbox (The MathWorks Inc.) by the following first order model:

$$G(s) = -e^{-0.016s} \frac{14.19}{s + 3.766}. \quad (51)$$

The model response and test data are shown in Fig. 12, whose fitting ratio was 63.45%. Note that no significant improvement in accuracy was observed when increasing the model order.

Subsequently, we designed a local control system so that ω_i tracks the reference velocity ω_i^{ref} . For this purpose, we employed the PI (Proportional-Integral) controller

$$u_i = - \left(0.28 + \frac{1.0}{s} \right) (\omega_i^{\text{ref}} - \omega_i),$$

where the gains were tuned so that the gain crossover frequency was equal to 4.0 rad/s. A bigger crossover frequency was prohibited due to the actuator saturation.³ The time response for the step reference $\omega_i^{\text{ref}} = 0.5\text{rad/s}$ is shown in Fig. 13. We see that ω_i successfully tracks to the reference ω_i^{ref} despite the disturbances from the water.

C. Collision Avoidance against Walls

Due to the size limitation of the pool, collisions with the walls can interfere with the experiments. We thus modify the reference angular velocity ω_i^{ref} for the local controller so as to avoid collisions with the walls. Although this is a problem specific to the present testbed, we describe how to avoid collisions since it may be useful in real applications as well.

As shown in Fig. 11, we define two points on the right front and left front, whose position coordinates relative to Σ_i are denoted by $p_i^{\text{right}} = [0.25 \ -0.15]^T \text{m}$ and $p_i^{\text{left}} = [0.25 \ 0.15]^T \text{m}$,

³The actuators suffer from saturation in order to prevent the thrusters from rotating backwards. Specifically, both of u_i^{right} and u_i^{left} in (50) should remain greater than 1500.

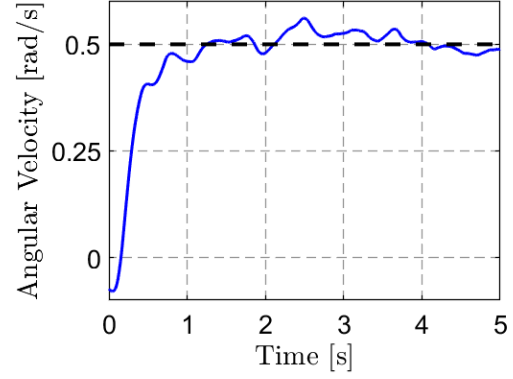

Fig. 13: Time response with reference angular velocity $\omega_i^{\text{ref}} = 0.5\text{rad/s}$, where the blue line shows filtered angular velocity data.

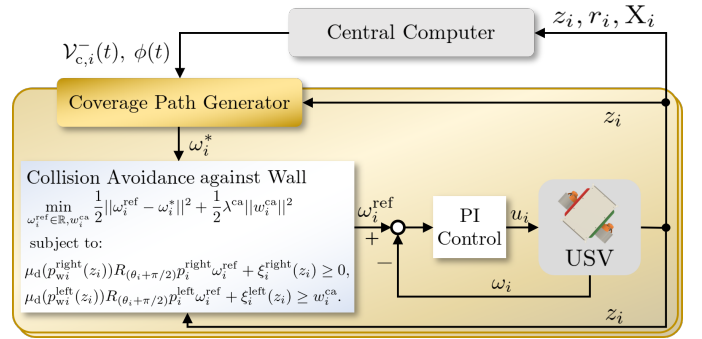

Fig. 14: Block diagram of the control architecture including the low-level PI velocity control and constraint-based control to avoid collisions against walls.

respectively. The coordinates of these points relative to the world frame Σ_w are then given by

$$\begin{aligned} p_{w_i}^{\text{right}}(z_i) &= p_i + R_{\theta_i} p_i^{\text{right}}, \\ p_{w_i}^{\text{left}}(z_i) &= p_i + R_{\theta_i} p_i^{\text{left}}. \end{aligned}$$

The points $p_{w_i}^{\text{right}}$ and $p_{w_i}^{\text{left}}$ then obey the following kinematic model, respectively.

$$\dot{p}_{w_i}^{\text{right}} = \begin{bmatrix} \cos \theta_i \\ \sin \theta_i \end{bmatrix} \bar{v} + R_{(\theta_i + \pi/2)} p_i^{\text{right}} \omega_i, \quad (52)$$

$$\dot{p}_{w_i}^{\text{left}} = \begin{bmatrix} \cos \theta_i \\ \sin \theta_i \end{bmatrix} \bar{v} + R_{(\theta_i + \pi/2)} p_i^{\text{left}} \omega_i. \quad (53)$$

Let us now approximate the set of the position coordinates in Σ_w of all points in the pool as $\mathcal{P} = \{p \in \mathbb{R}^2 \mid \mu(p) \leq 1\}$ with

$$\mu(p) = ((p - c) \odot (p - c))^T P ((p - c) \odot (p - c)),$$

where \odot represents the Hadamard product, c is the center of the pool, and $P \in \mathbb{R}^{2 \times 2}$ is a positive definite matrix that scales and rotates the 4-norm ball. Define candidates of the control barrier functions as

$$\begin{aligned} b_i^{\text{right}}(z_i) &= 1 - \mu(p_{w_i}^{\text{right}}(z_i)), \\ b_i^{\text{left}}(z_i) &= 1 - \mu(p_{w_i}^{\text{left}}(z_i)). \end{aligned}$$

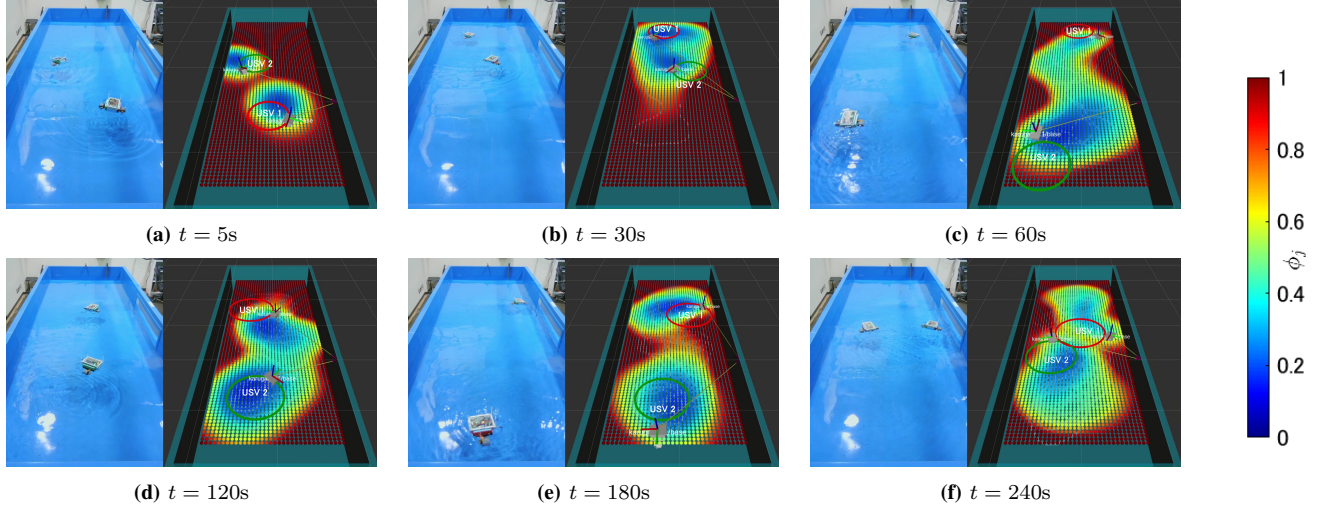

Fig. 15: Snapshots of the experiment at each time. The left side shows moving two real USVs on the experiment pool. The red and green circular paths on the right side, indicate paths corresponding to USVs 1 and 2. White curves show the trajectories of the two USVs after $t = 0$.

Then, the time derivatives of these functions are given as

$$\dot{b}_i^{\text{right}} = \mu_d(p_{w_i}^{\text{right}}) \left(\begin{bmatrix} \cos \theta_i \\ \sin \theta_i \end{bmatrix} \bar{v} + R_{(\theta_i + \pi/2)} p_i^{\text{right}} \omega_i \right)$$

$$\dot{b}_i^{\text{left}} = \mu_d(p_{w_i}^{\text{left}}) \left(\begin{bmatrix} \cos \theta_i \\ \sin \theta_i \end{bmatrix} \bar{v} + R_{(\theta_i + \pi/2)} p_i^{\text{left}} \omega_i \right),$$

$$\mu_d(p) = -4(\mathbf{1}_2 \odot (p - c))^T P((p - c) \odot (p - c))$$

where $\mathbf{1}_2 = [1 \ 1]^T$.

Following the manner of the constraint-based controller [20], we formulate the following linear inequality constraints in ω_i corresponding to $\dot{b}_i^{\text{right}} + \alpha^{\text{right}} b_i^{\text{right}} \geq 0$ and $\dot{b}_i^{\text{left}} + \alpha^{\text{left}} b_i^{\text{left}} \geq 0$, respectively.

$$\mu_d(p_{w_i}^{\text{right}}(z_i)) R_{(\theta_i + \pi/2)} p_i^{\text{right}} \omega_i + \xi_i^{\text{right}}(z_i) \geq 0, \quad (54)$$

$$\mu_d(p_{w_i}^{\text{left}}(z_i)) R_{(\theta_i + \pi/2)} p_i^{\text{left}} \omega_i + \xi_i^{\text{left}}(z_i) \geq 0, \quad (55)$$

where

$$\xi_i^{\text{right}}(z_i) = \mu_d(p_{w_i}^{\text{right}}(z_i)) \begin{bmatrix} \cos \theta_i \\ \sin \theta_i \end{bmatrix} \bar{v} + \alpha^{\text{right}} b_i^{\text{right}}(z_i), \quad (56)$$

$$\xi_i^{\text{left}}(z_i) = \mu_d(p_{w_i}^{\text{left}}(z_i)) \begin{bmatrix} \cos \theta_i \\ \sin \theta_i \end{bmatrix} \bar{v} + \alpha^{\text{left}} b_i^{\text{left}}(z_i), \quad (57)$$

and $\alpha^{\text{right}}, \alpha^{\text{left}}$ were selected as $\alpha^{\text{right}} = \alpha^{\text{left}} = 0.15$. Remark now that meeting both (54) and (55) may be infeasible when the USV approaches the wall perpendicularly. In order to avoid this possible infeasibility, we treat the constraint (55) as a soft constraint. Accordingly, we formulate the constraint-based controller:

$$\min_{\omega_i^{\text{ref}} \in \mathbb{R}, w_i^{\text{ca}}} \frac{1}{2} \|\omega_i^{\text{ref}} - \omega_i^*\|^2 + \frac{1}{2} \lambda^{\text{ca}} \|w_i^{\text{ca}}\|^2 \quad \text{subject to:} \quad (58a)$$

$$\mu_d(p_{w_i}^{\text{right}}(z_i)) R_{(\theta_i + \pi/2)} p_i^{\text{right}} \omega_i^{\text{ref}} + \xi_i^{\text{right}}(z_i) \geq 0, \quad (58b)$$

$$\mu_d(p_{w_i}^{\text{left}}(z_i)) R_{(\theta_i + \pi/2)} p_i^{\text{left}} \omega_i^{\text{ref}} + \xi_i^{\text{left}}(z_i) \geq w_i^{\text{ca}}, \quad (58c)$$

where ω_i^* is computed by the generated path and (34), and λ^{ca} was selected as 200. The overall system architecture including (58) is illustrated in Fig. 14.

D. Experimental Verification

We demonstrate the present control architecture in Fig. 14 for the circular path on the testbed. In the experiment, we employed a $4.5\text{m} \times 1.7\text{m}$ rectangle inside the pool as the area to be monitored with a margin to the wall. The observation points were allocated evenly in grids of 0.05m on each side, resulting in the total number of cells $m = 3060$. The parameter σ in (2) was empirically selected as $\sigma = 0.15$, and the parameters in (3) were set to $\bar{\delta} = 0.04, \underline{\delta} = 0.5, \bar{\phi} = 1$, and $\phi = 0$. The initial values of $\phi_j(0)$ were set to 1 for all $j = 1, 2, \dots, m$. The required performance level was set to $\gamma = 2.0$. Furthermore, the initial values for the circular path were set to $r_i(0) = 0.3\text{m}$ and $X_i(0) = r$ ($i = 1, 2$). The lower and upper limits for the size of r_i were set to $r_{\min} = 0.2\text{m}$ and $r_{\max} = 0.7\text{m}$, respectively. The function and the penalty parameter in the constraint-based controller (33) are chosen as $\alpha_1(x) = \alpha_2(x) = \alpha_3(x) = x$ and $\lambda = 0.1$.

We implemented the proposed control architecture for two USVs under the settings above. The movie of the experiment is uploaded to <https://youtu.be/YuZbbcMRrLU?si=PAqEAuRi-jN2nSwq>, whose snapshots are shown in Fig. 15. We see from the movie and figures that the USVs switch the turning directions X_i and radius r_i so that they are persistently driven to the red regions with high importance indices, while avoiding overlaps of the monitoring areas between the two USVs.

The experimental results are further verified through three types of time responses in Figs. 16–18. First, Fig. 16 shows the evolution of the functions $b_{c,1}^1$ (red) and $b_{c,2}^1$ (blue) on the quality of the paths. We see from this figure that satisfaction of the constraints is more challenging than the simulation of Fig. 6. The USVs occasionally fail to follow the paths determined by solving (33) due to the joint effect of the added wall avoidance behavior and uncertainties in the real physical world. However, we observe that, as expected, the present controller pushes up the functions $b_{c,i}^1$ whenever they become

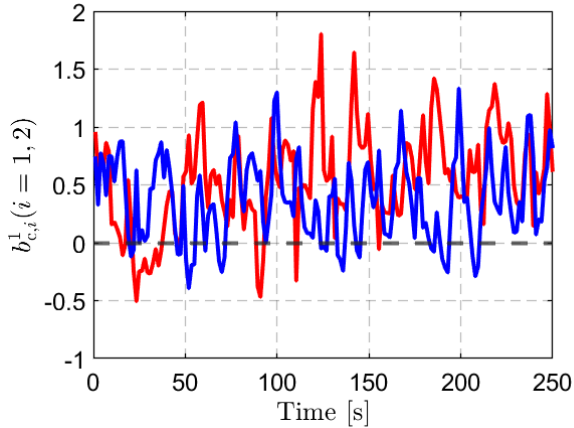

Fig. 16: Time evolution of the functions $b_{c,1}^1$ (red) and $b_{c,2}^1$ (blue).

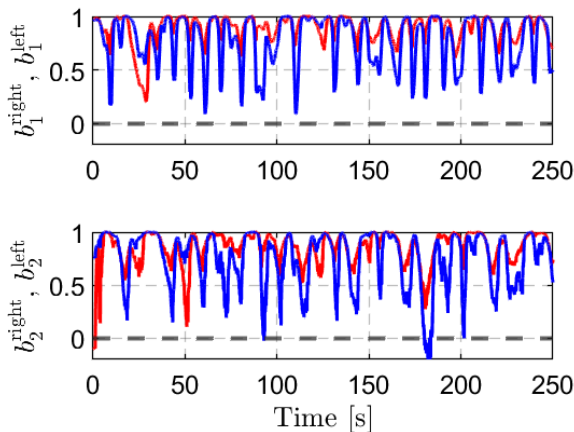

Fig. 17: Time evolution of the functions b_i^{right} (red) and b_i^{left} (blue) for collision avoidance against the wall. The top figure shows the evolution for USV 1 and the bottom shows that for USV 2.

negative, avoiding violations for long periods of time.

As for the wall collision avoidance, Fig. 17 shows the time evolution of b_i^{right} and b_i^{left} for USVs $i = 1, 2$. We see from these figures that the functions b_i^{right} (red) and b_i^{left} (blue) ($i = 1, 2$) are kept positive for almost all time. Only b_2^{left} violates the constraint at around 180s due to the relaxation of the associated constraint (58c) and various uncertainties of the environment and the system model. Nevertheless, we see from the movie that the collisions with the walls actually do not happen throughout the experiment owing to the margin set in the definition of the environment. The movie also shows that the USVs successfully take avoidance actions when they are close to the wall, while giving up the path following.

Let us finally show the actual monitoring performance achieved by the USVs. To this end, we show in Fig. 18 the time evolution of the sum of the overall importance indices, $\sum_{j=1}^m \phi_j$, which is regarded as a reasonable metric for the monitoring performance. It is seen from this figure that it initially decays sharply and then is maintained below 2.1×10^3 . The fact that the performance metric stays at a certain value means that each observation point has been monitored by

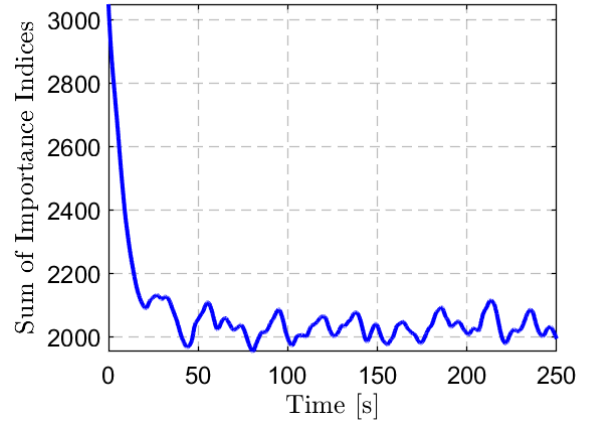

Fig. 18: Time evolution of the summation of all importance indices $\sum_{j=1}^m \phi_j$.

the USVs persistently. It is thus concluded that the present coverage path generator successfully achieves persistent environmental monitoring even in the presence of uncertainties in the physical world. Note however that the relation between the performance level γ for the path generation and the actual environmental monitoring performance remains implicit. A direct evaluation of the latter is left as future work.

VI. CONCLUSION

In this article, we have designed an online coverage circular and elliptic path generator for a group of USVs having constant forward velocities so that they persistently and efficiently monitor the aquatic environment. It has been demonstrated that the constraint-based control not only certifies a prescribed performance level together with additional constraints on the paths but also drastically reduces the computational complexity at the cost of the conservatism, avoiding combinatorial optimization of the turning directions. The proposed coverage path generator is amenable to distributed computation and has been finally demonstrated through simulations and experiments on a testbed of multiple USVs.

Future work should be directed towards an extension to a more generic class of paths and field experiments.

ACKNOWLEDGMENT

This work was supported by project grant Number PID2023-152876OB-I00.

APPENDIX A

QUADRATIC PROGRAM FOR CIRCULAR PATH GENERATION

Given a turning direction $X_i \in \mathcal{X}_i$, we have

$$i_{c,i}^{X_i} = C_i^r(X_i)\rho_i + C_i^z(X_i)\dot{z}_i + (C_i^\phi(X_i))^\top \dot{\phi}_i^-, \quad (59)$$

where

$$C_i^r(X_i) = \sum_{j:q_j \in \mathcal{V}_{c,i}^-(t)} \frac{\partial g_{c,ij}^{X_i}}{\partial r_i} \phi_j,$$

$$C_i^z(X_i) = \sum_{j:q_j \in \mathcal{V}_{c,i}^-(t)} \frac{\partial g_{c,ij}^{X_i}}{\partial z_i} \phi_j,$$

ϕ_i^- is the stack vector of ϕ_j for all $q_j \in \mathcal{V}_{c,i}^-(t)$, and $C_i^\phi(X_i)$ is the stack vector of $g_{c,i,j}^{X_i}$ for all $q_j \in \mathcal{V}_{c,i}^-(t)$. Let us now define the set

$$\mathcal{X}_{c,i}^\epsilon(r_i) = \left\{ X_i \in \mathcal{X}_i \mid \left| \left(\max_{X_i \in \mathcal{X}_i} I_{c,i}^{X_i}(r_i) \right) - I_{c,i}^{X_i}(r_i) \right| \leq \epsilon \right\}, \quad (60)$$

where ϵ is a positive scalar and the dependence of $I_{c,i}^{X_i}$ and $\mathcal{X}_{c,i}^\epsilon$ on $z_i(t)$ and $\phi(t)$ is omitted just for notational simplicity. The constraint that enforces $b_{c,i}^1(r_i) \geq 0$ for all $t \geq 0$ is then given as follows [38].

$$\begin{aligned} \eta_i^r \rho_i + \eta_i^z \dot{z}_i + (\eta_i^\phi)^\top \dot{\phi}_i^- + \alpha_1(b_{c,i}^1) &\geq 0 \\ \forall \eta = [\eta_i^r \ \eta_i^z \ (\eta_i^\phi)^\top] \in \partial_\epsilon b_{c,i}^1(r_i), \end{aligned} \quad (61)$$

where

$$\partial_\epsilon b_{c,i}^1(r_i) = \text{co} \bigcup_{X_i \in \mathcal{X}_{c,i}^\epsilon(r_i)} [C_i^r(X_i) \ C_i^z(X_i) \ (C_i^\phi(X_i))^\top]$$

and co denotes the convex hull. It is not difficult to prove that (61) is equivalent to

$$\begin{aligned} C_i^r(Y_i)\rho_i + C_i^z(Y_i)\dot{z}_i + (C_i^\phi(Y_i))^\top \dot{\phi}_i^- + \alpha_1(b_{c,i}^1) &\geq 0 \\ \forall Y_i \in \mathcal{X}_{c,i}^\epsilon(r_i) \end{aligned} \quad (62)$$

with a finite number of constraints.

In view of the fact that $b_{c,i}^2 + \alpha_2(b_{c,i}^2) \geq 0$ and $b_{c,i}^3 + \alpha_3(b_{c,i}^3) \geq 0$ are equivalent to

$$\rho_i + \alpha_2(b_{c,i}^2) \geq 0, \quad (63a)$$

$$-\rho_i + \alpha_3(b_{c,i}^3) \geq 0, \quad (63b)$$

the controller (33) is reformulated as the following quadratic program:

$$(\rho_i^*, w_i^*) = \arg \min_{\rho_i, w_i} |\rho_i|^2 + \lambda |w_i|^2 \text{ subject to: (63),} \quad (64a)$$

$$\begin{aligned} C_i^r(Y_i)\rho_i + C_i^z(Y_i)\dot{z}_i + (C_i^\phi(Y_i))^\top \dot{\phi}_i^- + \alpha_1(b_{c,i}^1) &\geq w_i \\ \forall Y_i \in \mathcal{X}_{c,i}^\epsilon(r_i) \end{aligned} \quad (64b)$$

Remark 1: Notice that (64) requires $\dot{\phi}_i^-$, namely $\dot{\phi}_j$ for all $q_j \in \mathcal{V}_{c,i}^-(t)$. Two possible implementations for acquiring this information are conceivable. If the position of USV l that gives the minimal $\|p_l - q_j\|$ among all USVs is available for USV i through inter-USV communication, USV i can locally compute $\dot{\phi}_j$ based on (3). Another implementation is that USV i receives $\dot{\phi}_j$ such that $q_j \in \mathcal{V}_{c,i}^-(t)$ together with $\mathcal{V}_{c,i}^-(t)$ and ϕ_j from the central computer.

APPENDIX B

QUADRATIC PROGRAM FOR ELLIPTIC PATH GENERATION

Since the discussions are essentially the same as Appendix A, we present only the quadratic program to be solved by the

elliptic path generator:

$$(\rho_i^*, w_i^*) = \arg \min_{\rho_i, w_i} \|\rho_i\|^2 + \lambda |w_i|^2 \text{ subject to:} \quad (65a)$$

$$\begin{aligned} E_i^s(Y_i)\rho_i + E_i^z(Y_i)\dot{z}_i + (E_i^\phi(Y_i))^\top \dot{\phi}_i^- + \alpha_1(b_{e,i}^1) &\geq w_i \\ \forall Y_i \in \mathcal{X}_{e,i}^\epsilon(s_i), \end{aligned} \quad (65b)$$

$$- [1 \ 0 \ 0] \rho_i + \alpha_2(b_{e,i}^2) \geq 0 \quad (65c)$$

$$- \begin{bmatrix} (s_{i2})^2 & & \\ (1/r_{\min} - s_{i1})^2 & \frac{2s_{i2}}{1/r_{\min} - s_{i1}} & 1 \end{bmatrix} \rho_i + \alpha_3(b_{e,i}^3) \geq 0 \quad (65d)$$

$$[1 \ 0 \ 0] \rho_i + \alpha_4(b_{e,i}^4) \geq 0 \quad (65e)$$

$$\begin{bmatrix} (s_{i2})^2 & & \\ (s_{i1} - 1/r_{\max})^2 & \frac{-2s_{i2}}{s_{i1} - 1/r_{\max}} & 1 \end{bmatrix} \rho_i + \alpha_5(b_{e,i}^5) \geq 0 \quad (65f)$$

where

$$\mathcal{X}_{e,i}^\epsilon(s_i) = \left\{ X_i \in \mathcal{X}_i \mid \left| \left(\max_{X_i \in \mathcal{X}_i} I_{e,i}^{X_i}(s_i) \right) - I_{e,i}^{X_i}(s_i) \right| \leq \epsilon \right\},$$

$$E_i^s(X_i) = \sum_{j:q_j \in \mathcal{V}_{e,i}^-(t)} \frac{\partial g_{e,i,j}^{X_i}}{\partial s_i} \phi_j,$$

$$E_i^z(X_i) = \sum_{j:q_j \in \mathcal{V}_{e,i}^-(t)} \frac{\partial g_{e,i,j}^{X_i}}{\partial z_i} \phi_j,$$

ϕ_i^- is the stack vector of ϕ_j for all $q_j \in \mathcal{V}_{e,i}^-(t)$, and $E_i^\phi(X_i)$ is the stack vector of $g_{e,i,j}^{X_i}$ for all $q_j \in \mathcal{V}_{e,i}^-(t)$.

REFERENCES

- [1] M. Dunbabin and L. Marques. Robots for environmental monitoring: Significant advancements and applications. *IEEE Robotics & Automation Magazine*, vol. 19, no. 1, pp. 24–39, 2012.
- [2] M.A. Tivey, H.P. Johnson, A. Bradley, and D. Yoerger. Thickness of a submarine lava flow determined from near-bottom magnetic field mapping by autonomous underwater vehicle. *Geophysical Research Letters*, vol. 25, no. 6, pp. 805–808, 1998.
- [3] S. Manjanna, A.Q. Li, R.N. Smith, I. Rekleitis, and G. Dudek. Heterogeneous multi-robot system for exploration and strategic water sampling. *Proc. 2018 IEEE International Conference on Robotics and Automation*, pp. 4873–4880, 2018.
- [4] A.M. Barrionuevo, S.Y. Luis, D.G. Reina, and S.L.T. Marín. Informative deep reinforcement path planning for heterogeneous autonomous surface vehicles in large water resources. *IEEE Access*, vol. 12, pp. 71835–71852, 2024.
- [5] D. Madeo, A. Pozzebon, C. Mocenni, and D. Bertoni. A low-cost unmanned surface vehicle for pervasive water quality monitoring. *IEEE Transactions on Instrumentation and Measurement*, vol. 69, no. 4, pp. 1433–1444, 2020.
- [6] A. Anderson, J.G. Martin, N. Bouraqadi, L. Etienne, L. Fabresse, K. Langueh, G. Lozenguez, L. Rajaoarisoa, J.M. Maestre, and E. Duviella. Map meshing impact on the efficiency of nonlinear set-based model predictive control for water quality assessment. *IFAC-PapersOnLine*, vol. 55, no. 33, pp. 105–110, 2022.
- [7] S. Yuan, Y. Li, F. Bao, H. Xu, Y. Yang, Q. Yan, S. Zhong, H. Yin, J. Xu, Z. Huang, and J. Lin. Marine environmental monitoring with unmanned vehicle platforms: Present applications and future prospects. *Science of The Total Environment*, vol. 858, Part 1, 159741, 2023.
- [8] N.B. Rossello, R.F. Carpio, A. Gasparri, and E. Garone. Information-driven path planning for UAV with limited autonomy in large-scale field monitoring. *IEEE Transactions on Automation Science and Engineering*, vol. 19, no. 3, pp. 2450–2460, 2022.
- [9] R. Ranjbar, J.G. Martin, J.M. Maestre, L. Etienne, E. Duviella, and E.F. Camacho. Mobile robot model predictive control approach: Case study of an irrigation canal. *Proc. 2023 8th International Conference on Control and Robotics Engineering*, pp. 211–216, 2023.
- [10] J.G. Martin, J.M. Maestre, and E.F. Camacho. Spatial irradiance estimation in a thermosolar power plant by a mobile robot sensor network. *Solar Energy*, vol. 220, pp. 735–744, 2021.

- [11] J. Cortés, S. Martínez, T. Karatas, and F. Bullo. Coverage control for mobile sensing networks. *IEEE Transactions on Robotics and Automation*, vol. 20, no. 2, pp. 243–255, 2004.
- [12] B. Bayat, N. Crasta, A. Crespi, A.M. Pascoal, and A. Ijspeert. Environmental monitoring using autonomous vehicles: A survey of recent searching techniques. *Current Opinion in Biotechnology*, vol. 45, pp. 76–84, 2017.
- [13] J. Oyekan, H. Hu, and D. Gu. Exploiting bacterial swarms for optimal coverage of dynamic pollutant profiles. *Proc. 2010 IEEE International Conference on Robotics and Biomimetics*, pp. 1692–1697, 2010.
- [14] N. Hübel, S. Hirche, A. Gusrialdi, T. Hatanaka, M. Fujita, and O. Sawodny. Coverage control with information decay in dynamic environments. *IFAC Proceedings Volumes*, vol. 41, no. 2, pp. 4180–4185, 2008.
- [15] H. Dan, T. Hatanaka, J. Yamauchi, T. Shimizu, and M. Fujita. Persistent object search and surveillance control with safety certificates for drone networks based on control barrier functions. *Frontiers in Robotics and AI*, vol. 8, 2021.
- [16] M. Thummalapeta and Y.-C. Liu. Distributed persistent coverage control over importance-based environments with quadrotors. *IFAC-PapersOnLine*, vol. 56, no. 2, pp. 2939–2944, 2023.
- [17] Y.-C. Liu, T.-C. Lin, and M.-T. Lin. Indirect/direct learning coverage control for wireless sensor and mobile robot networks. *IEEE Transactions on Control Systems Technology*, vol. 30, no. 1, pp. 202–217, 2021.
- [18] D. Boskos, J. Cortés, and S. Martínez. Data-driven distributionally robust coverage control by Mobile Robots. *Proc. 62nd IEEE Conference on Decision and Control*, pp. 2030–2035, 2023.
- [19] B. Zheng and L. Liu. Adaptive coverage control for heterogeneous mobile sensor networks in an unknown environment. *Proc. 62nd IEEE Conference on Decision and Control*, pp. 3154–3159, 2023.
- [20] M. Egerstedt. *Robot ecology: Constraint-based design for long-duration autonomy*. Princeton Univ Press, 2021.
- [21] G. Notomista, S.F. Ruf, and M. Egerstedt. Persistification of robotic tasks using control barrier functions. *IEEE Robotics and Automation Letters*, vol. 3, no. 2, pp. 758–763, 2018.
- [22] M. Santos, S. Mayya, G. Notomista, and M. Egerstedt. Decentralized minimum energy coverage control for time-varying density functions. *Proc. 2019 International Symposium on Multi-Robot and Multi-Agent Systems*, pp. 155–161, 2019.
- [23] T. Shimizu, S. Yamashita, T. Hatanaka, K. Uto, M. Mammarella, and F. Dabbene. Angle-aware coverage control for 3D map reconstruction with drone networks. *IEEE Control Systems Letters*, vol. 6, pp. 1831–1836, 2022.
- [24] J. Enright, K. Savla, and E. Frazzoli. Coverage control for nonholonomic agents. *Proc. 47th IEEE Conference on Decision and Control*, pp. 4250–4256, 2008.
- [25] A. Kwok and S. Martínez. Unicycle coverage control via hybrid modeling. *IEEE Transactions on Automatic Control*, vol. 55, no. 2, pp. 528–532, 2010.
- [26] H. Sugahara, R. Ishihara, and A. Kojima. Persistent coverage control for two-wheeled mobile robots in complex geometry environment. *IFAC-PapersOnLine*, vol. 56, no. 2, pp. 11456–11461, 2023.
- [27] Q. Liu, Z. Zhang, N.K. Le, J. Qin, F. Liu, and S. Hirche. Distributed coverage control of constrained constant-speed unicycle multi-agent systems. *IEEE Transactions on Automation Science and Engineering*, early access, 2024.
- [28] K. Savla, E. Frazzoli, and F. Bullo. Traveling salesperson problems for the Dubins vehicle. *IEEE Transactions on Automatic Control*, vol. 53, no. 6, pp. 1378–1391, 2008.
- [29] L. Lin, D. Shi, S. Jin, S. Yang, C. Zhou, Y. Lian, and H. Liu. Exact and heuristic multi-robot Dubins coverage path planning for known environments. *Sensors*, vol. 23, no. 5, 2560, 2023.
- [30] T. Fossen. *Handbook of Marine Craft Hydrodynamics and Motion Control* (2nd ed.). Blackwell, Wiley, 2021.
- [31] C. Wang, S. Xie, C. Huizi, Y. Peng, and D. Zhang. A decoupling controller by hierarchical backstepping method for straight-line tracking of unmanned surface vehicle. *Systems Science & Control Engineering*, vol. 7, no. 1, pp. 379–388, 2019.
- [32] M.L. Castaño and X. Tan. Backstepping-based tracking control of underactuated aquatic robots. *IEEE Transactions on Control Systems Technology*, vol. 31, no. 3, pp. 1179–1195, 2022.
- [33] D.A. Paley, F. Zhang, F., and N.E. Leonard. Cooperative control for ocean sampling: The glider coordinated control system. *IEEE Transactions on Control Systems Technology*, vol. 16, no. 4, pp. 735–744, 2008.
- [34] E. Galceran and M. Carreras. Efficient seabed coverage path planning for ASVs and AUVs. *Proc. 2012 IEEE/RSJ International Conference on Intelligent Robots and Systems*, pp. 88–93, 2012.
- [35] X. Peng-Fei, Y.-X. Ding, and J.-C. Luo. Complete coverage path planning of an unmanned surface vehicle based on a complete coverage neural network algorithm. *Journal of Marine Science and Engineering*, vol. 9, no. 11, 1163, 2021.
- [36] B.-B. Hu, H., T. Zhang, B. Liu, H. Meng and G. Chen. Distributed surrounding control of multiple unmanned surface vessels with varying interconnection topologies. *IEEE Transactions on Control Systems Technology*, vol. 30, no. 1, pp. 400–407, 2022.
- [37] T. Oshima, Y. Toyomoto, and T. Hatanaka. Online Coverage Path Generation for Aquatic Environmental Monitoring with Multiple USVs through Constraint-based Control. *Proc. IEEE Conference on Control Technology and Applications*, 2024 (not yet uploaded).
- [38] P. Gloyfelter, J. Cortés, and M. Egerstedt. Boolean composability of constraints and control synthesis for multi-robot systems via nonsmooth control barrier functions. *Proc. IEEE Conference on Control Technology and Applications*, pp. 897–902, 2018.
- [39] A.Y. Uteshev and M.V. Goncharova. Point-to-ellipse and point-to-ellipsoid distance equation analysis. *Journal of Computational and Applied Mathematics*, vol. 328, pp. 232–251, 2018.
- [40] S. Macenski, T. Foote, B. Gerkey, C. Lalancette, and W. Woodall. *Robot Operating System 2: Design, architecture, and uses in the wild*. Science Robotics, vol. 7, 2022.
- [41] Y. Toyomoto, T. Oshima, and T. Hatanaka. Robot Zoo Aqua: Aquatic Control Testbed of Multiple USVs on Robot Operating System 2 *Proc. SICE Festival 2024 with Annual Conference*, pp. 196–201, 2024.