

Quantifying artificial intelligence through algebraic generalization

Takuya Ito¹, Murray Campbell¹, Lior Horesh¹, Tim Klinger¹, and Parikshit Ram¹

¹Mathematics & Theoretical Computer Science Department, T.J. Watson Research Center, IBM Research
Contact: takuya.ito@ibm.com

ABSTRACT

The rapid development of modern artificial intelligence (AI) systems has created an urgent need for their scientific quantification. While their fluency across a variety of domains is impressive, modern AI systems fall short on tests requiring symbolic processing and abstraction – a glaring limitation given the necessity for interpretable and reliable technology. Despite a surge of reasoning benchmarks emerging from the academic community, no comprehensive and theoretically-motivated framework exists to quantify reasoning (and more generally, symbolic ability) in AI systems. Here, we adopt a framework from computational complexity theory to explicitly quantify symbolic generalization: *algebraic circuit complexity*. Many symbolic reasoning problems can be recast as algebraic expressions. Thus, algebraic circuit complexity theory – the study of algebraic expressions as circuit models (i.e., directed acyclic graphs) – is a natural framework to study the complexity of symbolic computation. The tools of algebraic circuit complexity enable the study of generalization by defining benchmarks in terms of their complexity-theoretic properties (i.e., the difficulty of a problem). Moreover, algebraic circuits are generic mathematical objects; for a given algebraic circuit, an arbitrarily large number of samples can be generated for a specific circuit, making it an optimal testbed for the data-hungry machine learning algorithms that are used today. Here, we adopt tools from algebraic circuit complexity theory, apply it to formalize a science of symbolic generalization, and address key theoretical and empirical challenges for its successful application to AI science and its impact on the broader community.

Introduction

The ability to reason algebraically is often considered a hallmark of human intelligence¹. The recent evolution of modern artificial intelligence (AI) systems and large language models (LLMs) has led to the speculation that these systems may also reason algebraically²⁻⁴. Yet due to challenge of evaluating large models trained on massive pretraining datasets⁵, it is difficult to evaluate whether such models are truly exhibiting algebraic reasoning abilities, or whether they instead regurgitate plausible text from their pretraining data^{6,7}. This ambiguity has led to a deluge of symbolic reasoning benchmarks⁸⁻¹⁷. Despite these efforts, objectively quantifying the complexity of reasoning problems is difficult; most of these experiments are ad hoc, and designed without a framework to quantify complexity. However, approaches in computational complexity theory, a field within theoretical computer science, have made it possible to explicitly measure a problem’s algorithmic difficulty, enabling the design of generalization tests rooted in quantifiable measures of complexity. Here, we adopt a branch of computational complexity theory – *algebraic circuit complexity* – to provide a parsimonious set of problems and approaches to rigorously study symbolic computation in machine learning.

Recently, there has been increased interest in studying AI models through arithmetic and compositional tasks^{9,12,18-27}. Compositional tasks are problems that are generated by recombining a basis set of atomic elements to form a variety of task combinations. (Arithmetic problems are compositional; they are composed of atomic elements (numbers and operators), and can be recomposed to generate novel expressions and problems.) These tasks are good reasoning benchmarks because they require 1) abstraction, 2) logical application of rules or axioms, and 3) precise problem-solving and rigor. Critically, these paradigms have provided reliable ways to elicit failure modes in transformer-based AI models for specific forms of symbolic generalization. For example, a number of studies have demonstrated the difficulty of “length generalization” – generalizing to problems of longer length than seen during training^{19,21,26,28}. Hupkes et al.⁹ and Hupkes et al.²⁹ also introduced various notions (e.g., systematicity and productivity) in an effort to taxonomize different forms of linguistic generalization. While incredibly useful for linguistics, it is unclear how these concepts generically apply beyond natural language processing. By contrast, the formalisms from algebraic circuit complexity theory provide a set of parsimonious mathematical tools that can be applied to quantify symbolic generalization, and are agnostic to specific domains, such as linguistics. Moreover, algebraic circuit complexity theory provides an encompassing theoretical framework for the increasingly popular, yet nascent empirical evaluations in AI systems that use arithmetic tasks^{18,19,21-24,30-35}.

A large class of symbolic problems can be studied with algebraic expressions^{36,37}. Algebraic circuit complexity theory formalizes algebraic expressions as circuit models (i.e., directed acyclic graphs; Fig. 1). This formalization is well-established in computational complexity theory, the branch of theoretical computer science concerned with quantifying the difficulty of computational problems and the resources required to solve them³⁸. Importantly, formalizing computational problems in terms of circuits is the leading approach to empirically quantify their complexity. Unlike other notions of complexity, such as Kolmogorov Complexity in algorithmic information theory (which is incomputable), notions developed in complexity theory for circuits are *explicitly computable* and determined by their shape and structure³⁹. Thus, the tools of algebraic circuit complexity can formalize notions of generalization by defining benchmarks in terms of their circuit properties. Furthermore, algebraic circuits are generic mathematical objects; they can be represented from a variety of mathematical perspectives (geometry, topology, etc.), providing useful interpretations in other domains. Algebraic circuits are therefore well-situated to addressing problems in symbolic machine learning – the problems are computable, large datasets can be straightforwardly generated from circuit specifications, and new models can be developed that address specific failure modes within this framework. In the ensuing sections, we provide a blueprint for the successful adoption of algebraic circuit complexity for machine learning problems; we introduce the core components of algebraic circuits, address how they can be leveraged to study symbolic generalization, and discuss several key open theoretical and empirical challenges.

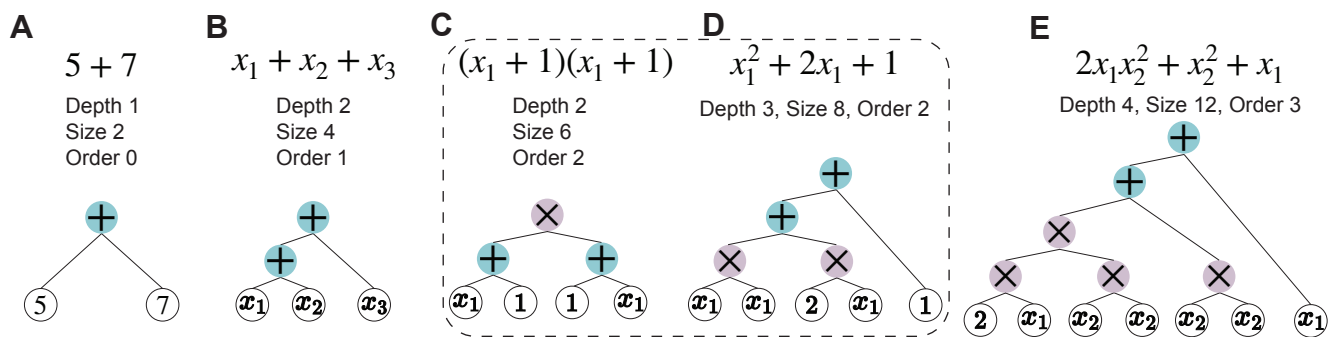

Figure 1. Examples of algebraic expressions represented as circuits. A) A two operand addition circuit (input gates are sampled from a field \mathbb{F}). B) A three operand addition circuit (input gates are sampled from the set of variables $x_i \in X$ rather than \mathbb{F}). C, D) A mathematically equivalent pair of circuits, but represented as C) a factorized expression, and D) its a monomial expansion. Notably, despite their mathematical equivalence, the circuit representations are distinct. E) A polynomial of depth 4 and size 12.

Algebraic circuits

Algebraic circuit complexity studies algebraic expressions as computable circuit models. There has been a significant amount of recent machine learning research studying arithmetic generalization, a key symbolic ability. While important and insightful, most of those studies primarily focus on a restricted set of algebraic problems, which we will illustrate later^{18,19,21,24,33}. Below, we provide definitions of algebraic circuits that will place prior work within a broader mathematical framework. Our goal is to provide the tools to quantify model generalization through circuit complexity, rather than ad hoc goals such as, for example, “length generalization”.

Definition. (For a more formal definition, see Shpilka and Yehudayoff³⁶ or Bürgisser et al.³⁷.) An algebraic circuit C represents a polynomial expression as a directed acyclic graph, comprised of gates v and edges e . Input gates, v_X and $v_{\mathbb{F}}$, are respectively defined as either variables (e.g., $X = \{x_1, \dots, x_n\}$) or elements in a field \mathbb{F} (e.g., \mathbb{R}). Input gates have fan-in (in-degree) of 0. All other gates are operators: a sum gate (v_+) or a product gate (v_\times). Here we restrict the fan-in of operator gates to 2, as is standard³⁶. For our purposes, this ensures that there is the same number of gates in a circuit model with its corresponding representation as a string of tokens, which simplifies downstream analyses (e.g., the analysis in Fig. 6). Operator gates have a fan-out (out-degree) of either 1 or 0. If the fan-out or an operator gate is 0, then it is the output gate of that polynomial.

Properties. An algebraic circuit C has two main complexity measures: size s and depth d (see Table 1 for a summary of all properties). The size s of a circuit refers to the number of edges e in C . The depth d of a circuit refers to the longest path from an input gate to the output gate. We can denote a *sub-circuit* C_v of C , which computes the polynomial f_v rooted at gate v . Another important property of an algebraic circuit is its *degree* (i.e., the degree of a polynomial). The degree of a circuit (or a sub-circuit) can be computed by measuring the degree of the gate v , denoted $\text{deg}(v)$. Elements in a field \mathbb{F} are of degree 0, input variables $x \in X$ have degree 1, the degree of an sum gate (+) is determined by the degrees of its inputs u, v such that $\text{deg}(u + v) = \max(\text{deg}(u), \text{deg}(v))$, and the degree of a product gate (\times) is determined by $\text{deg}(u \cdot v) = \text{deg}(u) + \text{deg}(v)$.

Circuit property	Description
Circuit C	A directed acyclic graph that computes a polynomial.
Size s	The number of edges in C .
Depth d	The longest path from an input gate to an output gate.
$deg(v)$	The degree of a gate v . If v is the output gate, $deg(v)$ is the degree of the polynomial.
Gate $v_{\mathbb{F}}$	An element of a field \mathbb{F} with $deg(v_{\mathbb{F}}) = 0$, and fan-in 0.
Gate v_X	A variable $x_i \in X$ with $deg(v_X) = 1$, and fan-in 0.
Gate v_+	A sum gate with $deg(v_+) = \max(deg(u), deg(v))$ for inputs u and v , and fan-in 2.
Gate v_{\times}	A product gate with $deg(v_{\times}) = deg(u) + deg(v)$ for inputs u and v , and fan-in 2.

Table 1. Key circuit properties and their descriptions.

Figure 1 provides a few simple examples of algebraic circuits. A circuit representation of an algebraic expression provides a concrete algorithm for *computing a polynomial*, with some circuits requiring more computation than others (e.g., determined by size or depth). Furthermore, a circuit description can provide explicit differences in required computation for polynomials that are mathematically equivalent (e.g., see Fig. 1C,D). Such a formalization can be useful to study how different representations of equivalent algebraic expressions can lead to different levels of generalization. The recent studies in arithmetic generalization in AI models focus on the simplest circuit representations of algebraic problems (problems analogous to Fig. 1A, but varying the magnitude of the field elements, e.g., train on small digit numbers, test on large digit numbers). The language of circuit complexity can provide more interesting and flexible ways to investigate generalization across circuit complexity classes.

Towards a science of generalization with algebraic circuits

A recent study concluded that LLMs’ behavior is a function of the problems they are trained to solve²⁵. It is difficult to identify what the “problems” are when the pretraining corpus is natural language text derived from the internet. A theoretically coherent alternative to quantify AI systems is to select problems where 1) difficulty is quantifiable, and 2) arbitrarily large datasets can be systematically generated. Algebraic circuits satisfy both of these constraints.

Though recent papers have demonstrated an increased interest in using arithmetic tasks to quantify generalization, preliminary approaches have been theoretically limited. As alluded to above, many of the recent papers evaluating “length generalization” in arithmetic tasks train on two variable addition (or multiplication), and test on the same circuit class but sample field elements that are larger in magnitude (Fig. 2A)^{19–21,23,26,33,35}. Others focus on a more complex form of generalization, i.e., addition or multiplication on problems with a greater number of variables, which is equivalent to increasing the circuit size and depth (Fig. 2B) (e.g., modular arithmetic task; Deletang et al.³⁰). While useful and informative, both these tests of generalization scratch the surface of generalization metrics that can be devised with algebraic circuits.

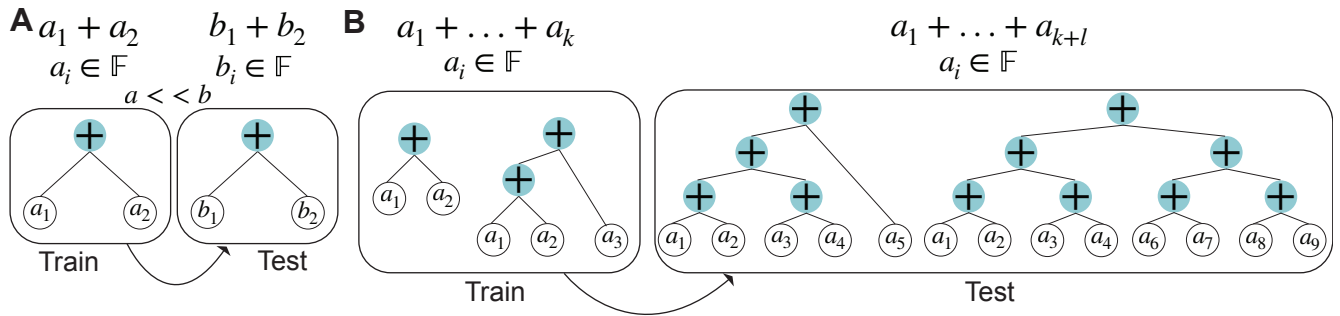

Figure 2. Commonly-used AI evaluations for “length generalization” with arithmetic tasks. A) The predominant form of “length generalization” in transformers is evaluating performance on addition or multiplication problems with larger integers than seen during training^{19–21,23,26,33}. This would be conceptually equivalent to a situation in which the circuit size and depth are fixed, but the sampling of input gates (i.e., field elements) differs across training and testing sets. The notion of length generalization is specific to the context of transformers, given that larger digits require a larger context window. B) Another form of “length generalization” studied in the literature is to generalize to arithmetic problems with more operands (variables) than seen in the training set³⁰. From a circuit complexity perspective, these two approaches are distinct problems.

The importance of learning composable functions

We first define symbolic generalization (Box 1), and consider the importance of learning algebraically (or compositionally). The ability to symbolically generalize is one of the most challenging problems in AI, and is a requirement for robust reasoning and planning. Like algebraic circuits, several prior papers formulated symbolic tasks as computing a path through a directed graph or circuit^{11,13,24}. Importantly, learning a symbolic task requires 1) decomposing and abstracting the individual functions (e.g., nodes) of a circuit, and understanding how they can be recomposed via edges to produce novel circuits (e.g., function composition). Algebra is a natural language to study symbolic generalization as it can be encoded as a circuit, and requires both abstraction and function composition. Moreover, in contrast to other compositional approaches (e.g., regular or context-free grammars; Deletang et al.³⁰, Chomsky⁴⁰), algebraic problems encompass an infinite vocabulary (e.g., \mathbb{R}) with an expressive grammar determined by its axioms, making it well-suited for machine learning algorithms that require many training samples. In the following section, we propose a framework of generalization in terms of algebraic circuits.

Box 1. A formal sketch of symbolic generalization.

Let B be a basis set of elements. Let $U_1 = B$ and $U_{i+1} = \{u \mid (u_1, u_2 \in U_{\leq i}) \ \& \ (u = u_1 \circ u_2)\}$, where \circ stands for any computable composition operator on U_i (akin to production rules in context-free grammars or operations in a field). Then, we define some universe set

$$U = \bigcup_{i \in \mathbb{N}} U_i$$

We define a function (task) T on U such that $T : U \rightarrow R$ (see below for tasks T for algebraic circuits). T is a compositional function, where $\forall u_1, u_2 \in U, T(u_1 \circ u_2) = T(u_1) * T(u_2)$, and $*$ stands for any computable composition on R .

Let D_{train} and D_{test} be distributions over U , and $supp(D_{train}|B)$ and $supp(D_{test}|B)$ to be the support of the basis set elements in D_{train} and D_{test} , respectively. We restrict D_{test} to be a distribution in which $supp(D_{test}|B) \subseteq supp(D_{train}|B)$. Additionally, if a composable function \circ is represented in D_{test} (i.e., $u \in D_{test}$ and $u = b_1 \circ b_2$), then we require that \circ is also represented in D_{train} . We include these as requirements for symbolic generalization; it would be challenging, if not impossible, to generalize to samples in D_{test} if not all basis elements and composition operators were provided in D_{train} .

We define symbolic/compositional generalization as the evaluation of a learned model M (e.g., a neural network) where

$$Pr_{x \sim D_{test}} [M(x) = T(x)] > 1 - \epsilon \quad (1)$$

Here, M is only optimized from samples $x \sim D_{train}$, and ϵ is the evaluation error of M on $x \sim D_{test}$. A *strong form of symbolic generalization over algebraic circuits* would be to satisfy Equation 1 for all valid partitions of D_{train} and D_{test} (with the requisite support of basis sets and composition functions) in U for uniformly small values of ϵ .

For algebraic circuit problems, $T : U \rightarrow R$ can be a function that maps a circuit to: 1) a field element, e.g., $r \in \mathbb{R}$ (in the case of circuit evaluation; Fig. 1); 2) $\{0, 1\}$, in the case of a classification task, such as polynomial identity testing (Fig 3A); 3) another circuit C (i.e., in the case of polynomial expansion or factorization; Fig 3B).

Circuit divergence as a metric of generalization

The language of algebraic circuits provides quantitative metrics to formalize generalization. In particular, generalization of AI systems can be quantified in terms of *circuit divergence* – the divergence of circuit parameters between algebraic circuits employed during training and testing (Fig. 3). In other words, given a model M , we want to characterize its generalization performance $M(C_{test}|\mathcal{C})$, where C_{test} is a test circuit, and $\mathcal{C} = \{C_1, \dots, C_k\}$ is a family of training circuits. We define circuit divergence as the difference between quantifiable circuit properties between train and test distributions. Here, we emphasize five important circuit properties to measure divergences: the sampling of a field \mathbb{F} , the number of variables $|X|$, size s , depth d , and the polynomial degree. By quantifying the properties of circuits in both the training and testing sets, circuit divergence can be explicitly measured along these dimensions. In the following sections, we will provide several examples where tests of generalization can be constructed through the manipulation of circuit divergence.

Generalization benchmarks

In this section, we illustrate the flexibility of algebraic circuits in designing meaningful AI benchmarks. To demonstrate the generality of algebraic circuits, we begin by providing benchmarks that are analogous to popular tests of compositional

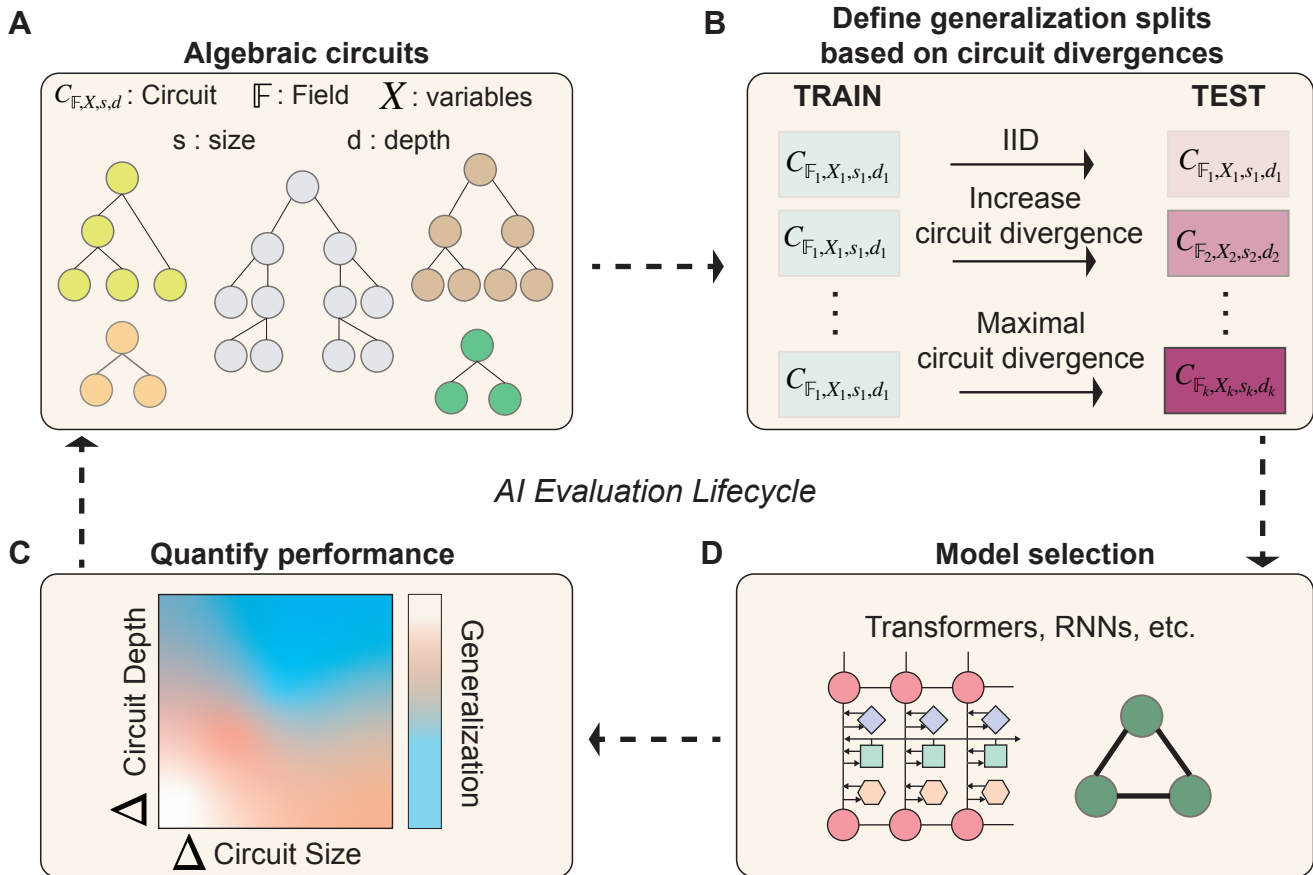

Figure 3. Symbolic capabilities of modern AI systems and architectures can be studied with algebraic circuits. A) A set of problems can be identified (and sampled) from algebraic circuits. B) Given a family of circuits, we can identify circuit divergences – the divergence of different circuit properties, like size and depth – to design train datasets and test datasets to evaluate the algebraic generalization ability of a model. C,D) We can evaluate a model (or set of models) across these dataset splits, and quantify their performance according to circuit divergences. This AI evaluation lifecycle allows us to iterate and refine hypotheses regarding the degree to which a model can generalize to a class of algebraic problems of particular complexity. (Note that circuit divergences can be measured beyond depth and size.)

generalization: systematicity and productivity⁹. We subsequently introduce novel, more challenging problems that can be used to evaluate more general types of symbolic computation and abstraction. Finally, we demonstrate an approach to reformulate tests of algebraic generalization for pretrained LLMs.

Compositional generalization with algebraic circuits

There has been recent interest in using compositional paradigms to study the symbolic ability of machine learning models^{8,9,12,24,41–47}. Here we demonstrate direct links to popular forms of compositional generalization using algebraic circuits.

Systematic compositional generalization and regression. Systematic compositional generalization refers to the ability to recombine known basis elements into novel combinations of fixed sequence size (Fig 4A). This means that test sets of systematicity are limited to novel combinations of the same length as seen during training^{8,9}. The analog in algebraic circuits is to 1) sample a family of circuits \mathcal{C} over a field \mathbb{F} of a fixed size and depth, and 2) to generalize to circuits of the same size and depth, but differentially sampling input gates and/or operators. This can be implemented by choosing different samplers – P_1 and P_2 – that differentially sample gates (Fig 4A). For example, the training set of circuits could be constructed with input gates $a_i \in P_1 \mathbb{F}$, and the testing set of circuits could be constructed with the input gates $b_i \in P_2 \mathbb{F}$. (Note that when samplers choose $b_i \gg a_i$, this is analogous to the common test of “length generalization”; Fig. 2A.)

Interestingly, we note that successful systematic compositional generalization on input gates in algebraic circuit evaluations amounts to learning a distributionally robust regression model (e.g., Zhang et al.⁴⁸, Ghosh et al.⁴⁹). This is because a circuit of specific size and depth (e.g., as shown in Fig. 4A) expresses to a specific polynomial equation. Generalization on a

circuit class to a distribution shift of its input gates (e.g., field elements but not operator gates) would demonstrate successful out-of-distribution generalization.

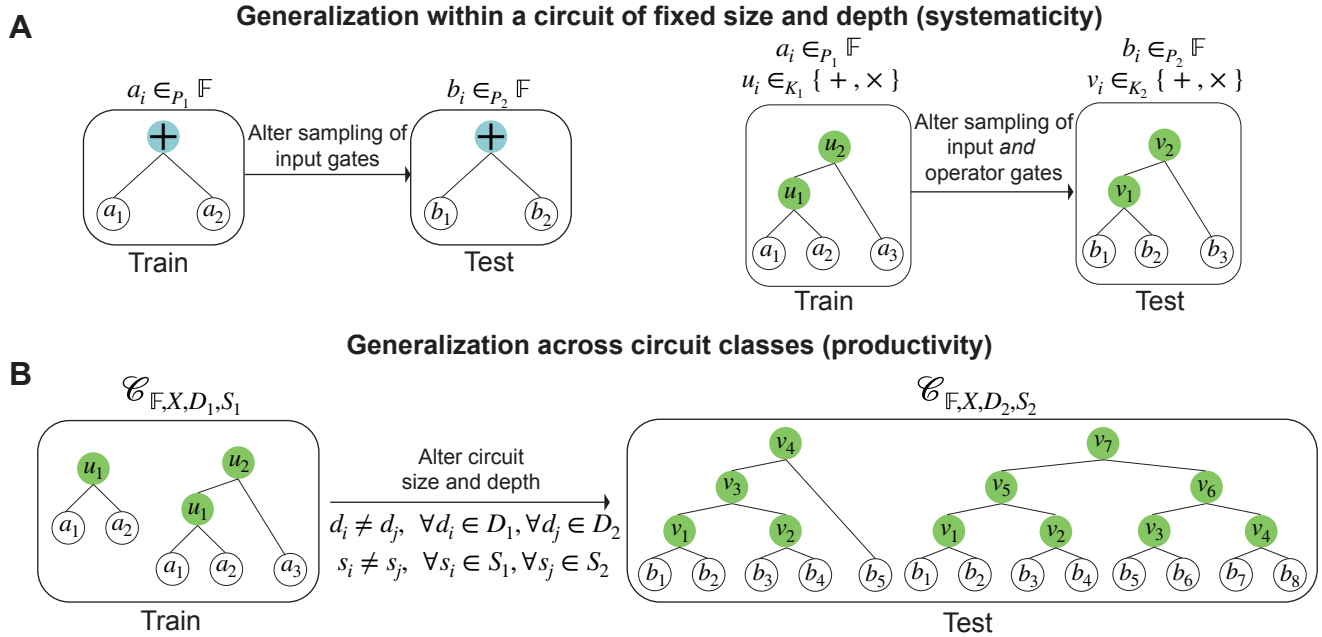

Figure 4. Analogs of common compositional generalization benchmarks in terms of algebraic circuits. A) A simpler form of generalization within an algebraic circuit is generalizing to circuits of the same structure (size and depth), but with a novel combination of gates. The analog of this in compositionality is commonly-referred to as *systematic compositional generalization*⁹. (Learning over circuits of fixed structure can also be viewed as learning a regression model⁴⁸.) On the left, we illustrate an example of a model that is trained on a restricted family of circuits where the input gates are sampled from a field \mathbb{F} with a sampling function P_1 . At test time, the model is required to generalize to circuits of the same circuit class (in terms of size and depth), but where the input gates are sampled using a different sampler P_2 . On the right, both input and operator gates are chosen with separate samplers across train and test circuits, resulting in a more difficult test of systematic compositionality. B) Productive compositional generalization considers partitions of the training and testing sets across circuit sizes and depths. The analog of this in compositionality is commonly-referred to as *productive compositional generalization*. Given a family of circuits $\mathcal{C}_{\mathbb{F},X,D,S}$, where D and S denote a set of depths d_i and size s_i , the primary experimental manipulation is to construct a training set $\mathcal{C}_{\mathbb{F},X,D_1,S_1}$ and testing set $\mathcal{C}_{\mathbb{F},X,D_2,S_2}$ such that there exists no overlap of a specific circuit class $\mathcal{C}_{\mathbb{F},X,d_i,s_i}$ between the training and testing sets.

Productive compositional generalization. Productive compositional generalization refers to the ability to generalize to sequences of longer length. In the context of algebraic circuits, while systematicity focuses on keeping circuit size and depth fixed while manipulating gates, productive generalization focuses on manipulating circuit size and depth (Fig 4B). Thus, evaluating systematic and productive generalization can be studied together; measures of generalization can be quantified in a continuous manner by varying circuit parameters, such as gate samplers (systematicity), size (productivity), and depth (productivity). Understanding how each of these properties interact across training and testing sets will provide a comprehensive quantification of algebraic generalization.

Since algebraic circuits are circuit representations of algebraic expressions, one can ask more generic questions about algebraic polynomials. For example: Given a class of polynomials as a training dataset, what other class of polynomials will this model be able to compute? Such a question goes beyond asking whether a model can systematically or productively generalize. Instead, it addresses a basic question that can leverage other rich mathematical subfields (e.g., geometry, topology) to quantify AI generalization. Algebraic circuits provides a flexible framework to formalize problem complexity beyond existing paradigms in compositional generalization.

Classification tasks: Polynomial identity testing

Prior work studying arithmetic abilities in transformer models have typically focused on computing simple expressions with field elements ($a \in \mathbb{F}$; e.g., $5 + 7 = ?$), rather than variables ($x \in X$; e.g., $2x_1 + x_2 + 7$). Including variables in an algebraic expression increases the polynomial degree ($d \geq 1$), thereby increasing its complexity and the need for abstractions. One

approach to evaluating algebraic circuits with variables is through *polynomial identity testing*, an active area of research in computational complexity theory and computational algebra. Polynomial identity testing evaluates whether two polynomials are equivalent (i.e., $P_1(x_1, \dots, x_n) \equiv P_2(x_1, \dots, x_n)$). Posed another way, one can ask whether $P_1(x_1, \dots, x_n) - P_2(x_1, \dots, x_n) \equiv 0$.

This problem can be naturally formulated as a binary classification task for AI models. Importantly, studying the extent of algebraic generalization by assessing train/test circuit divergences of polynomial identity problems can be rigorously quantified, since each identity problem can be encoded as a circuit (Fig. 5A). The complexity of a polynomial identity testing problem can be scaled up by increasing the size, depth, and/or degree of the test problems. Moreover, machine learning practitioners can leverage existing symbolic programs and solvers to systematically generate large datasets (e.g., SymPy; Meurer et al.⁵⁰). Polynomial identity testing thus provides a unique opportunity to study AI generalization in terms of circuit complexity theory.

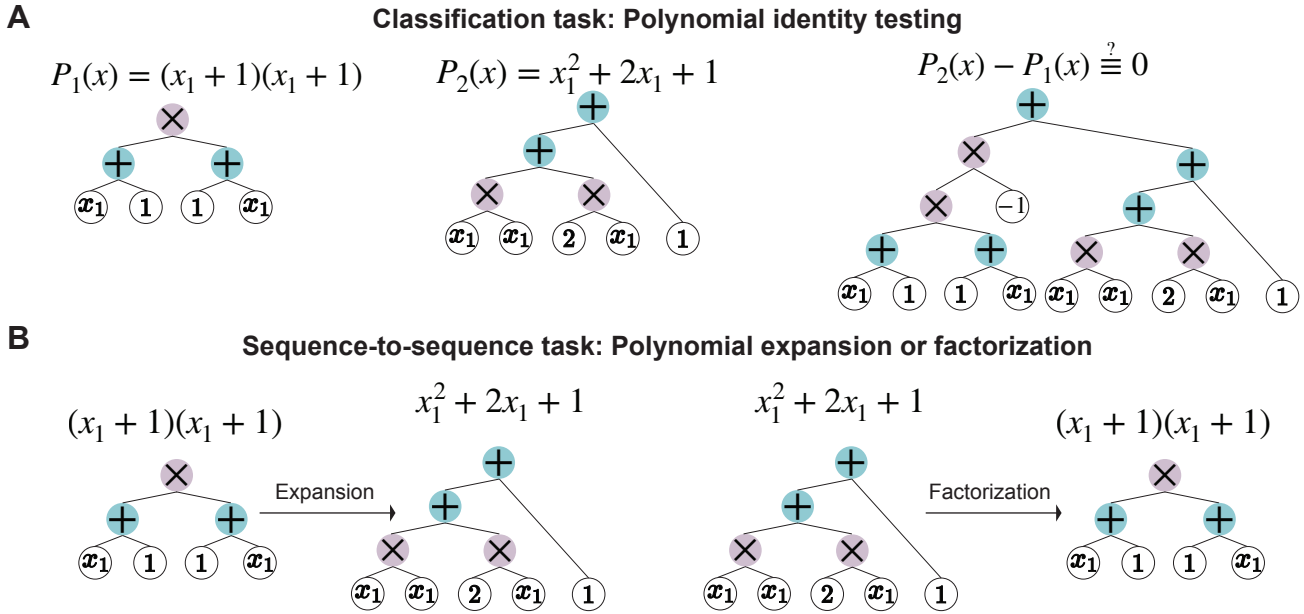

Figure 5. Algebraic problems as machine learning challenges. Prior work that leverages arithmetic problems for machine learning studies are typically limited to evaluating expressions with field elements. We introduce problems that can be evaluated with abstract variables. A) Polynomial identity testing as a machine learning classification task. Polynomial identity testing, an important and active area of research in computational algebra, evaluates whether two polynomials are equivalent. We illustrate two different polynomial expressions, $P_1(x)$ and $P_2(x)$ with distinct circuit representations, yet are mathematically equivalent. To reformulate this as a classification task for machine learning studies, one can ask if $P_2(x) - P_1(x) \equiv 0$ (right). B) Polynomial expansion and/or factorization as a transduction (sequence-to-sequence) task. Common sequence-to-sequence tasks in linguistics ask whether a model can expand a string using a set of rules or a grammar, such as SCAN or PCFG^{8,9}. In algebraic circuits, this is analogous to expanding a polynomial in a factorized representation (left). Given the 1-1 correspondence of polynomials, an additional approach is to take a polynomial in its expanded form (sum of monomials), and generate the factorized representation (right). This provides the ability to evaluate whether an AI system can expand an encoding (expansion), or compress an encoding (factorization).

Sequence-to-sequence tasks: Polynomial expansion or factorization

A wide application of generative models is in sequence-to-sequence transduction tasks. One particularly impactful use case is the development of AI models for code. AI models for code take in code as inputs (e.g., COBOL), and generate a translation of that code (e.g., Java). Despite its potential importance for modernizing many existing codebases, there is significant skepticism as to whether generative models trained with next-token prediction can reliably generate accurate code translations. This is due to the fact that programming languages are not dictated by autoregressive processes, and instead governed by symbolic rules.

Learning on algebraic circuits provides a straightforward framework to evaluate the ability of models to learn sequence-to-sequence tasks that are governed by symbolic rules. For example, the problem of expanding or factorizing a polynomial is a problem that is governed by the axiomatic rules of algebra (Fig. 5B). Like code translation, this task requires transforming one sequence into another while maintaining mathematical equivalence (or for code, algorithmic equivalence). Importantly, there

are explicit tools to describe the complexity with which the translation occurs in algebraic circuits. For example, a polynomial expansion transforms a factorized representation (i.e., compact circuit) to a sum of monomials representation (i.e., larger circuit). In contrast, a polynomial factorization implements the inverse operation, which requires compressing a large circuit to a smaller circuit. While a general interesting question is to ask whether models trained on one type of transformation can learn the other, this formalization has natural implications for understanding how to design AI models for code. In particular, some programming languages may have lower-level syntax (e.g., COBOL) relative to other languages, such as Python or Java. In either case, understanding how lower-level and higher-level encodings of an expression (be they algebraic or programmatic) requires learning useful abstractions and the symbolic rules to translate them. Thus, studying the conditions by which AI models can robustly parse and translate algebraic circuits can shed light on the best strategies to train AI models across different programming languages.

Mechanistic interpretability with algebraic circuits

A major issue in assessing symbolic generalization is the difficulty of interpreting what goes awry when they fail to generalize. This is partly due to the lack of interpretability of many benchmarks, which are often presented in natural language, and where the ground truth algorithms (e.g., circuit diagrams or parse trees) are not known^{14,51}. A more recent set of approaches in characterizing the interpretability of neural network representations rely on the design of carefully constructed tasks that have interpretable task components, such as ground truth parse trees or circuit diagrams^{24,30,52}. Algebraic circuits similarly provide ground truth interpretability. While the input to an AI model might be a string representation of a polynomial, that polynomial’s circuit encoding provides its ground truth encoding. Such an encoding makes it easy to directly compare to the internal representations of a model, such as the attention weights within a transformer (Fig. 6). This makes it possible to ask if the internal representations of a transformer computes the algebraic expression similarly to its computable circuit encoding (the adjacency matrix of the graph) – the normative approach to computing polynomials. More broadly, the distance metric that computes the distance between attention weights and ground truth circuit edges (as shown in Fig. 6) can be used as a regularization term to encourage transformers to learn normative circuit computations, providing algorithmic and step-by-step information to the model. Overall, evaluating AI models on algebraic problems allows practitioners to adjudicate between theoretical models of circuit computation with modern AI computation.

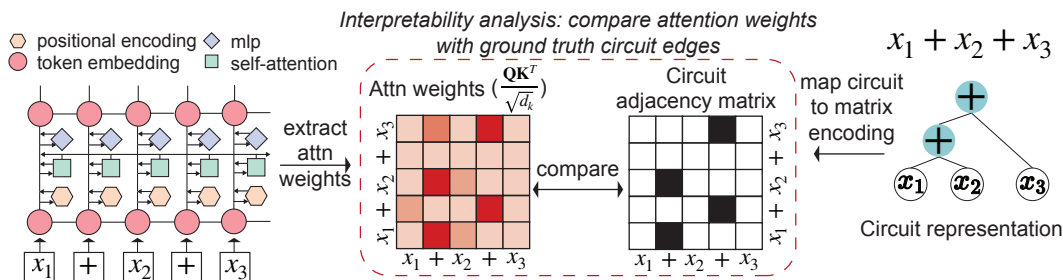

Figure 6. Using an algebraic circuit’s adjacency matrix as a ground truth comparison to interpret transformer attention representations. The transformer’s attention mechanism provides a useful way to peer into the representations of its input tokens (Left). When the input is an algebraic expression (presented as a string of tokens), the attention matrix can be investigated to uncover the relationships between tokens (i.e., operators and operands). On the other hand, an algebraic expression can always be mapped to a ground truth circuit, which can be represented as the adjacency matrix of a circuit (Right). This allows for the direct comparison between attention weights and the ground truth circuit representation (Middle). This distance between the transformer’s attention weights and the ground truth circuit adjacency matrix can also be potentially used as a regularizer to encourage learning circuit representations in attention weights.

Evaluating LLMs with algebraic circuits

We have introduced algebraic circuit tasks within the context of training models from scratch. While it is difficult to evaluate pretrained LLMs with precise levels of certainty due to the obscure nature of the pretraining data and optimization protocols, algebraic tasks can be still repurposed for LLMs. Prior work has demonstrated that LLMs typically fail on mathematical problems which require abstract reasoning on variables^{7,25,53}. Thus, if an LLM calls specific tools (e.g., calculators) which make computing circuits with only field elements too simple (e.g., those illustrated in Fig. 1 and 2, we can replace these with circuits containing variables $x \in X$ (i.e., those of degree ≥ 1)). For example, such tasks can include the aforementioned polynomial identity testing or polynomial expansion/factorization tasks, both of which can be made arbitrarily difficult and use arbitrary sets of variables/tokens.

Given that prior studies have demonstrated poor abstract reasoning abilities of LLMs, it is unlikely that current LLMs will be able to compute arbitrary circuits out-of-the-box. However, recent techniques in prompting LLMs have suggested the ability of LLMs to learn from a few prompts (termed in-context learning)^{31,54–58}. In other words, a few question-answer pairs can be shown to the LLM in the context window, followed by the target problem. This approach naturally offers an approach to measure algebraic generalization across circuit divergence metrics: Given a class of question-answer pairs generated from a specific circuit class, how well can a model generalize to a problem generated from a different complexity class (Fig. 7)? Another approach to systematically evaluate the ability of LLMs to compute circuits is through chain-of-thought prompting. Recent theoretical studies have indicated that leveraging chain-of-thought enables LLMs to solve more challenging problems by enhancing their expressivity and using scratchpads^{59–61}. Practically, inducing chain-of-thought in LLMs provides a way to verify whether LLMs sequentially “reason” through steps that are analogous to ground truth circuit computations (i.e., following the edges from input gates). These experimental approaches provide concrete methods from which to quantify symbolic ability in pretrained LLMs.

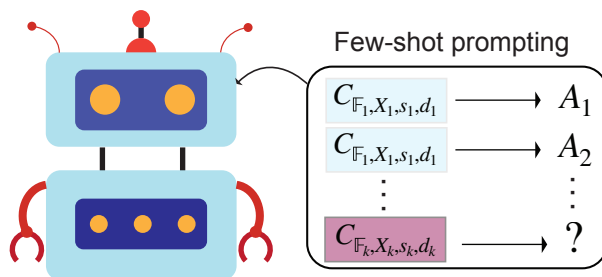

Figure 7. The algebraic generalization capability across circuit divergence metrics can be evaluated through few-shot prompting in LLMs. Given a set of question (left) and answer (right, A_i) pairs sampled from a specific circuit class $C_{\mathbb{F}_1, X_1, s_1, d_1}$ as prompts, we can ask an LLM to what degree it can generalize to algebraic problems sampled from a different circuit class $C_{\mathbb{F}_k, X_k, s_k, d_k}$.

Open theoretical and empirical challenges

Circuits provide a useful formalism to study generalization in AI systems. They are also a leading approach to quantifying the computational complexity of algorithmic problems. However, exactly how formal models of computation are related to AI generalization is broadly unexplored. Here we highlight three primary challenges associated with linking formal models of computation with AI generalization.

Circuit complexity and AI generalization

Algebraic circuit complexity studies the computational resources (in terms of circuit properties) required to evaluate polynomials. Though there are other metrics of complexity, such as Kolmogorov Complexity in algorithmic information theory^{62,63}, this measure of complexity is incomputable, as it requires searching over an infinite number of programs (though there are efforts in approximating Kolmogorov Complexity with alternative methods; Wyeth and Sturtivant³⁹, Johnston et al.⁶⁴, Dingle et al.⁶⁵). Thus, while circuits allow for the explicit computation of a problem, it remains unclear as to whether notions from circuit complexity will elegantly map onto notions of AI generalization. Nevertheless, given the lack of *any* framework to measure complexity in AI for symbolic ability, we believe that providing a general circuit complexity framework from which to design quantitative benchmarks (via circuit divergence measures) will be an important step towards building a science of symbolic generalization (e.g., see also Dziri et al.²⁴, Ram et al.⁶⁶). More broadly, an algebraic circuit approach offers extensive machinery to enable generalization through other algebraic tools, such as minimum spanning/basis sets, their decompositions, and more.

Extending formal models of symbolic computation to natural language and beyond

The types of algebraic problems we presented here are idealized problems that can be straightforwardly mapped to a circuit encoding. However, many real world problems that require algebraic ability are posed in natural language. Thus, applying a circuit complexity-theoretic approach for natural language problems requires parsing natural language into a circuit encoding, adding difficulty to the already challenging problem of generalizing across circuit complexities. It will be important for future work to design frameworks and benchmarks that require tests of algebraic generalization in terms of circuit divergence in natural language settings.

Algebraic representation learning in AI models

The standard approach to training AI models to perform algebraic or compositional tasks is to directly train them with input-output pairs. While algebraic circuits encode a specific algorithm by which to compute that polynomial (i.e., follow the edges from the input gates), it is possible that there are other viable algorithms to compute that polynomial. (For example, it could be possible that an algorithm first factorizes a sum of monomial representation prior to computing that simplified circuit.) More generally, it can be difficult to ascertain the conditions by which a learning system learns a correct and reliable algorithm to solve algebraic problems using only input-output pairs. Naturally, neurosymbolic approaches are often well-suited to learning algebraic and symbolic problems that are algorithmically reliable and sample efficient (e.g., Klinger et al.⁴⁵, Lake et al.⁶⁷, Poesia and Goodman⁶⁸, Trinh et al.⁶⁹). However, designing general purpose neurosymbolic models can be challenging. By contrast, though statistical machine learning models (e.g., transformers) are “general purpose”, the learning process is often obfuscated by learning dynamics that depend on architecture and complex optimization protocols. This makes it difficult to ascertain what computations and algorithms statistical systems learn. However, recent studies in compositional representation learning have suggested that different factors – such as choice of initialization and/or training curriculum – can have a strong influence on whether a model learns compositionally^{41,70–73}. In addition, developing techniques from the field of mechanistic interpretability provide new avenues from which to inspect whether the learned representations in an AI model are faithful to the hypothesized underlying algorithm (e.g., Fig. 6; Olsson et al.⁵⁶, Friedman et al.⁷⁴). Nevertheless, leveraging diverse methods to carefully investigate the algorithms that symbolic and statistical AI models learn will be important for their interpretability, reliability, and overall safety to ensure reliable deployment of AI systems.

Conclusion

Quantifying the algebraic ability of AI systems is difficult due to the lack of a theoretical framework from which to establish meaningful benchmarks. While there has been an increasing number of studies that have employed algebraic and compositional tasks to reliably elicit failure modes of transformers and LLMs, no mathematical framework exists to interpret these findings. Here, we provide a parsimonious framework – algebraic circuit complexity – to evaluate the extent of a model’s algebraic generalization ability in terms of their circuit divergences. In contrast to other formulations of complexity, such as Kolmogorov Complexity, encoding algebraic problems as circuits provides an explicitly computable formulation. The rich expressivity of algebraic problems, the data-rich nature of producing algebraic datasets, and the close links with algebraic circuits to other mathematical fields, makes algebraic circuit complexity a fruitful approach to quantify symbolic generalization in AI systems. We hope this lays the theoretical groundwork for future studies to quantify algebraic generalization in modern AI systems.

Acknowledgements

We thank Marco Carosino for helpful discussions on circuit complexity and symbolic generalization. We acknowledge funding support from the Exploratory Science Councils at IBM Research.

References

1. Gary F. Marcus. *The algebraic mind: Integrating connectionism and cognitive science*. MIT press, 2003.
2. Sébastien Bubeck, Varun Chandrasekaran, Ronen Eldan, Johannes Gehrke, Eric Horvitz, Ece Kamar, Peter Lee, Yin Tat Lee, Yuanzhi Li, Scott Lundberg, Harsha Nori, Hamid Palangi, Marco Tulio Ribeiro, and Yi Zhang. Sparks of Artificial General Intelligence: Early experiments with GPT-4, April 2023. URL <http://arxiv.org/abs/2303.12712>. arXiv:2303.12712 [cs].
3. Jason Wei, Yi Tay, Rishi Bommasani, Colin Raffel, Barret Zoph, Sebastian Borgeaud, Dani Yogatama, Maarten Bosma, Denny Zhou, Donald Metzler, Ed H. Chi, Tatsunori Hashimoto, Oriol Vinyals, Percy Liang, Jeff Dean, and William Fedus. Emergent Abilities of Large Language Models. *Transactions on Machine Learning Research*, June 2022. ISSN 2835-8856. URL https://openreview.net/forum?id=yzkSU5zdwD&utm_source=substack&utm_medium=email.
4. Taylor Webb, Keith J. Holyoak, and Hongjing Lu. Emergent analogical reasoning in large language models. *Nature Human Behaviour*, pages 1–16, July 2023. ISSN 2397-3374. doi: 10.1038/s41562-023-01659-w. URL <https://www.nature.com/articles/s41562-023-01659-w>. Publisher: Nature Publishing Group.
5. Najoung Kim, Tal Linzen, and Paul Smolensky. Uncontrolled Lexical Exposure Leads to Overestimation of Compositional Generalization in Pretrained Models, December 2022. URL <http://arxiv.org/abs/2212.10769>. arXiv:2212.10769 [cs].

6. Rylan Schaeffer, Brando Miranda, and Sanmi Koyejo. Are Emergent Abilities of Large Language Models a Mirage? *Advances in Neural Information Processing Systems*, 36:55565–55581, December 2023. URL https://proceedings.neurips.cc/paper_files/paper/2023/hash/adc98a266f45005c403b8311ca7e8bd7-Abstract-Conference.html.
7. Zhaofeng Wu, Linlu Qiu, Alexis Ross, Ekin Akyürek, Boyuan Chen, Bailin Wang, Najoung Kim, Jacob Andreas, and Yoon Kim. Reasoning or Reciting? Exploring the Capabilities and Limitations of Language Models Through Counterfactual Tasks. In Kevin Duh, Helena Gomez, and Steven Bethard, editors, *Proceedings of the 2024 Conference of the North American Chapter of the Association for Computational Linguistics: Human Language Technologies (Volume 1: Long Papers)*, pages 1819–1862, Mexico City, Mexico, June 2024. Association for Computational Linguistics. doi: 10.18653/v1/2024.naacl-long.102. URL <https://aclanthology.org/2024.naacl-long.102>.
8. Brenden Lake and Marco Baroni. Generalization without Systematicity: On the Compositional Skills of Sequence-to-Sequence Recurrent Networks. In *International Conference on Machine Learning*, pages 2873–2882. PMLR, July 2018. URL <http://proceedings.mlr.press/v80/lake18a.html>. ISSN: 2640-3498.
9. Dieuwke Hupkes, Verna Dankers, Mathijs Mul, and Elia Bruni. Compositionality Decomposed: How do Neural Networks Generalise? *Journal of Artificial Intelligence Research*, 67:757–795, April 2020. ISSN 1076-9757. doi: 10.1613/jair.1.11674. URL <https://www.jair.org/index.php/jair/article/view/11674>.
10. Drew A. Hudson and Christopher D. Manning. GQA: A New Dataset for Real-World Visual Reasoning and Compositional Question Answering. pages 6700–6709. *Proceedings of the IEEE/CVF Conference on Computer Vision and Pattern Recognition*, 2019. URL https://openaccess.thecvf.com/content_CVPR_2019/html/Hudson_GQA_A_New_Dataset_for_Real-World_Visual_Reasoning_and_Compositional_CVPR_2019_paper.html.
11. Guangyu Robert Yang, Igor Ganichev, Xiao-Jing Wang, Jonathon Shlens, and David Sussillo. A Dataset and Architecture for Visual Reasoning with a Working Memory. pages 714–731, 2018. URL https://openaccess.thecvf.com/content_ECCV_2018/html/Guangyu_Robert_Yang_A_dataset_and_ECCV_2018_paper.html.
12. Takuya Ito, Soham Dan, Mattia Rigotti, James Kozloski, and Murray Campbell. On the generalization capacity of neural networks during generic multimodal reasoning. *International Conference on Learning Representations*, 2024. URL <https://openreview.net/forum?id=zyBJodMrn5¬eId=zyBJodMrn5>.
13. Justin Johnson, Bharath Hariharan, Laurens van der Maaten, Li Fei-Fei, C. Lawrence Zitnick, and Ross Girshick. CLEVR: A Diagnostic Dataset for Compositional Language and Elementary Visual Reasoning. In *2017 IEEE Conference on Computer Vision and Pattern Recognition (CVPR)*, pages 1988–1997, Honolulu, HI, July 2017. IEEE. ISBN 978-1-5386-0457-1. doi: 10.1109/CVPR.2017.215. URL <https://ieeexplore.ieee.org/document/8099698/>.
14. Christopher Clark, Kenton Lee, Ming-Wei Chang, Tom Kwiatkowski, Michael Collins, and Kristina Toutanova. BoolQ: Exploring the Surprising Difficulty of Natural Yes/No Questions. In Jill Burstein, Christy Doran, and Tamar Solorio, editors, *Proceedings of the 2019 Conference of the North American Chapter of the Association for Computational Linguistics: Human Language Technologies, Volume 1 (Long and Short Papers)*, pages 2924–2936, Minneapolis, Minnesota, June 2019. Association for Computational Linguistics. doi: 10.18653/v1/N19-1300. URL <https://aclanthology.org/N19-1300>.
15. Najoung Kim and Tal Linzen. COGS: A Compositional Generalization Challenge Based on Semantic Interpretation. In Bonnie Webber, Trevor Cohn, Yulan He, and Yang Liu, editors, *Proceedings of the 2020 Conference on Empirical Methods in Natural Language Processing (EMNLP)*, pages 9087–9105, Online, November 2020. Association for Computational Linguistics. doi: 10.18653/v1/2020.emnlp-main.731. URL <https://aclanthology.org/2020.emnlp-main.731>.
16. Laura Ruis, Jacob Andreas, Marco Baroni, Diane Bouchacourt, and Brenden M Lake. A Benchmark for Systematic Generalization in Grounded Language Understanding. In *Advances in Neural Information Processing Systems*, volume 33, pages 19861–19872. Curran Associates, Inc., 2020. URL <https://proceedings.neurips.cc/paper/2020/hash/e5a90182cc81e12ab5e72d66e0b46fe3-Abstract.html>.
17. Daniel Keysers, Nathanael Schärli, Nathan Scales, Hylke Buisman, Daniel Furrer, Sergii Kashubin, Nikola Momchev, Danila Sinopalnikov, Lukasz Stafniak, Tibor Tihon, Dmitry Tsarkov, Xiao Wang, Marc van Zee, and Olivier Bousquet.

Measuring Compositional Generalization: A Comprehensive Method on Realistic Data. International Conference on Learning Representations, 2020. URL https://openreview.net/forum?id=SygcCnNKwr&utm_campaign=Graph%20Machine%20Learning%20News&utm_medium=email&utm_source=Revue%20newsletter.

18. Keito Kudo, Yoichi Aoki, Tatsuki Kuribayashi, Ana Brassard, Masashi Yoshikawa, Keisuke Sakaguchi, and Kentaro Inui. Do Deep Neural Networks Capture Compositionality in Arithmetic Reasoning? In Andreas Vlachos and Isabelle Augenstein, editors, *Proceedings of the 17th Conference of the European Chapter of the Association for Computational Linguistics*, pages 1351–1362, Dubrovnik, Croatia, May 2023. Association for Computational Linguistics. doi: 10.18653/v1/2023.eacl-main.98. URL <https://aclanthology.org/2023.eacl-main.98>.
19. Sean McLeish, Arpit Bansal, Alex Stein, Neel Jain, John Kirchenbauer, Brian R. Bartoldson, Bhavya Kailkhura, Abhinav Bhatele, Jonas Geiping, Avi Schwarzschild, and Tom Goldstein. Transformers Can Do Arithmetic with the Right Embeddings, May 2024. URL <http://arxiv.org/abs/2405.17399>. arXiv:2405.17399 [cs].
20. Hattie Zhou, Arwen Bradley, Etai Littwin, Noam Razin, Omid Saremi, Joshua M. Susskind, Samy Bengio, and Preetum Nakkiran. What Algorithms can Transformers Learn? A Study in Length Generalization. International Conference on Learning Representations, 2024. URL <https://openreview.net/forum?id=AssIuHnmHX>.
21. Ruoqi Shen, Sebastien Bubeck, Ronen Eldan, Yin Tat Lee, Yuanzhi Li, and Yi Zhang. Positional Description Matters for Transformers Arithmetic. *International Conference on Learning Representations*, 2024. URL <https://openreview.net/forum?id=ZMuPAOY8Oz>.
22. David Saxton, Edward Grefenstette, Felix Hill, and Pushmeet Kohli. Analysing Mathematical Reasoning Abilities of Neural Models. International Conference on Learning Representations, 2019. URL <https://openreview.net/forum?id=H1gR5iR5FX>.
23. Nayoung Lee, Kartik Sreenivasan, Jason D. Lee, Kangwook Lee, and Dimitris Papailiopoulos. Teaching Arithmetic to Small Transformers. International Conference on Learning Representations, October 2023. URL <https://openreview.net/forum?id=dsUB4bst9S>.
24. Nouha Dziri, Ximing Lu, Melanie Sclar, Xiang (Lorraine) Li, Liwei Jiang, Bill Yuchen Lin, Sean Welleck, Peter West, Chandra Bhagavatula, Ronan Le Bras, Jena Hwang, Soumya Sanyal, Xiang Ren, Allyson Ettinger, Zaid Harchaoui, and Yejin Choi. Faith and Fate: Limits of Transformers on Compositionality. *Advances in Neural Information Processing Systems*, 36:70293–70332, December 2023. URL https://proceedings.neurips.cc/paper_files/paper/2023/hash/deb3c28192f979302c157cb653c15e90-Abstract-Conference.html.
25. R. Thomas McCoy, Shunyu Yao, Dan Friedman, Matthew Hardy, and Thomas L. Griffiths. Embers of Autoregression: Understanding Large Language Models Through the Problem They are Trained to Solve, September 2023. URL <http://arxiv.org/abs/2309.13638>. arXiv:2309.13638 [cs].
26. Yongchao Zhou, Uri Alon, Xinyun Chen, Xuezhi Wang, Rishabh Agarwal, and Denny Zhou. Transformers Can Achieve Length Generalization But Not Robustly. International Conference on Learning Representations, April 2024. URL <https://openreview.net/forum?id=DWkWIh3vFJ>.
27. Sania Sinha, Tanawan Prensri, and Parisa Kordjamshidi. A Survey on Compositional Learning of AI Models: Theoretical and Experimental Practices, June 2024. URL <http://arxiv.org/abs/2406.08787>. arXiv:2406.08787 [cs].
28. Amirhossein Kazemnejad, Inkit Padhi, Karthikeyan Natesan Ramamurthy, Payel Das, and Siva Reddy. The Impact of Positional Encoding on Length Generalization in Transformers. *Advances in Neural Information Processing Systems*, 36: 24892–24928, December 2023. URL https://proceedings.neurips.cc/paper_files/paper/2023/hash/4e85362c02172c0c6567ce593122d31c-Abstract-Conference.html.
29. Dieuwke Hupkes, Mario Giulianelli, Verna Dankers, Mikel Artetxe, Yanai Elazar, Tiago Pimentel, Christos Christodoulopoulos, Karim Lasri, Naomi Saphra, Arabella Sinclair, Dennis Ulmer, Florian Schottnann, Khuyagbaatar Batsuren, Kaiser Sun, Koustuv Sinha, Leila Khalatbari, Maria Ryskina, Rita Frieske, Ryan Cotterell, and Zhijing Jin. A taxonomy and review of generalization research in NLP. *Nature Machine Intelligence*, 5(10):1161–1174, October 2023. ISSN 2522-5839. doi: 10.1038/s42256-023-00729-y. URL <https://www.nature.com/articles/s42256-023-00729-y>. Number: 10 Publisher: Nature Publishing Group.

30. Gregoire Deletang, Anian Ruoss, Jordi Grau-Moya, Tim Genewein, Li Kevin Wenliang, Elliot Catt, Chris Cundy, Marcus Hutter, Shane Legg, Joel Veness, and Pedro A. Ortega. Neural Networks and the Chomsky Hierarchy. *International Conference on Learning Representations*, September 2022. URL <https://openreview.net/forum?id=WbxHAzkeQcn>.
31. Hattie Zhou, Azade Nova, Aaron Courville, Hugo Larochelle, Behnam Neyshabur, and Hanie Sedghi. Teaching Algorithmic Reasoning via In-context Learning. *International Conference on Learning Representations*, 2023. URL https://openreview.net/forum?id=6dlC7E1H_9.
32. Anian Ruoss, Grégoire Delétang, Tim Genewein, Jordi Grau-Moya, Róbert Csordás, Mehdi Bennani, Shane Legg, and Joel Veness. Randomized Positional Encodings Boost Length Generalization of Transformers. In Anna Rogers, Jordan Boyd-Graber, and Naoaki Okazaki, editors, *Proceedings of the 61st Annual Meeting of the Association for Computational Linguistics (Volume 2: Short Papers)*, pages 1889–1903, Toronto, Canada, July 2023. Association for Computational Linguistics. doi: 10.18653/v1/2023.acl-short.161. URL <https://aclanthology.org/2023.acl-short.161>.
33. Samy Jelassi, Stéphane d’Ascoli, Carles Domingo-Enrich, Yuhuai Wu, Yuanzhi Li, and François Charton. Length Generalization in Arithmetic Transformers, June 2023. URL <http://arxiv.org/abs/2306.15400>. arXiv:2306.15400 [cs].
34. Cunxiang Wang, Boyuan Zheng, Yuchen Niu, and Yue Zhang. Exploring Generalization Ability of Pretrained Language Models on Arithmetic and Logical Reasoning. In Lu Wang, Yansong Feng, Yu Hong, and Ruifang He, editors, *Natural Language Processing and Chinese Computing*, pages 758–769, Cham, 2021. Springer International Publishing. ISBN 978-3-030-88480-2. doi: 10.1007/978-3-030-88480-2_61.
35. Rodrigo Nogueira, Zhiying Jiang, and Jimmy Lin. Investigating the Limitations of Transformers with Simple Arithmetic Tasks. Mathematical Reasoning in General Artificial Intelligence Workshop, ICLR, April 2021. doi: 10.48550/arXiv.2102.13019. URL <http://arxiv.org/abs/2102.13019>. arXiv:2102.13019 [cs].
36. Amir Shpilka and Amir Yehudayoff. Arithmetic circuits: A survey of recent results and open questions. *Foundations and Trends® in Theoretical Computer Science*, 5(3–4):207–388, 2010. URL <https://www.nowpublishers.com/article/Details/TCS-039>. Publisher: Now Publishers, Inc.
37. Peter Bürgisser, Michael Clausen, and Mohammad A. Shokrollahi. *Algebraic complexity theory*, volume 315. Springer Science & Business Media, 2013. URL https://books.google.com/books?hl=en&lr=&id=9QXtCAAAQBAJ&oi=fnd&pg=PA1&dq=Algebraic+Complexity+Theory+1997&ots=gRS9l_Dwfg&sig=dlgMbE3XVmu4esMG4EEsiPlZMuE.
38. Sanjeev Arora and Boaz Barak. *Computational complexity: a modern approach*. Cambridge University Press, 2009. URL <https://books.google.com/books?hl=en&lr=&id=nGvI7cOuOOQC&oi=fnd&pg=PA9&dq=computational+complexity&ots=Dbc7zGdDry&sig=ZA5nA3Cq8n5hZSkjAxA-cCxvhMc>.
39. Cole Wyeth and Carl Sturtivant. A circuit complexity formulation of algorithmic information theory. *Physica D: Nonlinear Phenomena*, 456:133925, December 2023. ISSN 0167-2789. doi: 10.1016/j.physd.2023.133925. URL <https://www.sciencedirect.com/science/article/pii/S0167278923002798>.
40. N. Chomsky. Three models for the description of language. *IRE Transactions on Information Theory*, 2(3):113–124, September 1956. ISSN 2168-2712. doi: 10.1109/TIT.1956.1056813. URL https://ieeexplore.ieee.org/abstract/document/1056813?casa_token=LWcQlM_dGHMAAAAA:MNPCKIgfJo51aiiygMmnT5YYpGF1Rp9IjQrC3Ca-rwObFAOISwzZ9_IE3ZgmoSUSZ73Lwifzkk. Conference Name: IRE Transactions on Information Theory.
41. Brenden M. Lake and Marco Baroni. Human-like systematic generalization through a meta-learning neural network. *Nature*, pages 1–7, October 2023. ISSN 1476-4687. doi: 10.1038/s41586-023-06668-3. URL <https://www.nature.com/articles/s41586-023-06668-3>. Publisher: Nature Publishing Group.
42. Laura Ruis and Brenden Lake. Improving Systematic Generalization Through Modularity and Augmentation. *arXiv:2202.10745 [cs]*, February 2022. URL <http://arxiv.org/abs/2202.10745>. arXiv: 2202.10745.

43. Santiago Ontanon, Joshua Ainslie, Zachary Fisher, and Vaclav Cvicek. Making Transformers Solve Compositional Tasks. In Smaranda Muresan, Preslav Nakov, and Aline Villavicencio, editors, *Proceedings of the 60th Annual Meeting of the Association for Computational Linguistics (Volume 1: Long Papers)*, pages 3591–3607, Dublin, Ireland, May 2022. Association for Computational Linguistics. doi: 10.18653/v1/2022.acl-long.251. URL <https://aclanthology.org/2022.acl-long.251>.
44. Róbert Csordás, Kazuki Irie, and Juergen Schmidhuber. The Devil is in the Detail: Simple Tricks Improve Systematic Generalization of Transformers. In Marie-Francine Moens, Xuanjing Huang, Lucia Specia, and Scott Wen-tau Yih, editors, *Proceedings of the 2021 Conference on Empirical Methods in Natural Language Processing*, pages 619–634, Online and Punta Cana, Dominican Republic, November 2021. Association for Computational Linguistics. doi: 10.18653/v1/2021.emnlp-main.49. URL <https://aclanthology.org/2021.emnlp-main.49>.
45. Tim Klinger, Qi Liu, Maxwell Crouse, Soham Dan, Parikshit Ram, and Alexander G. Gray. Compositional Program Generation for Systematic Generalization. June 2023. URL <https://openreview.net/forum?id=Wxj9U0ySU-s>.
46. Tomaso Poggio and Maia Fraser. Compositional Sparsity of Learnable Functions. Article, Center for Brains, Minds and Machines (CBMM), February 2024. URL <https://dspace.mit.edu/handle/1721.1/153475>. Accepted: 2024-02-08T15:14:50Z.
47. Parikshit Ram, Tim Klinger, and Alexander G. Gray. What makes Models Compositional? A Theoretical View: With Supplement, May 2024. URL <http://arxiv.org/abs/2405.02350>. arXiv:2405.02350 [cs].
48. Xuhui Zhang, Jose Blanchet, Soumyadip Ghosh, and Mark S. Squillante. A Class of Geometric Structures in Transfer Learning: Minimax Bounds and Optimality. In *Proceedings of The 25th International Conference on Artificial Intelligence and Statistics*, pages 3794–3820. PMLR, May 2022. URL <https://proceedings.mlr.press/v151/zhang22a.html>. ISSN: 2640-3498.
49. Soumyadip Ghosh, Mark Squillante, and Ebisa Wollega. Efficient Generalization with Distributionally Robust Learning. *Advances in Neural Information Processing Systems*, 34:28310–28322, 2021. URL https://proceedings.neurips.cc/paper_files/paper/2021/hash/ee1abc6b5f7c6acb34ad076b05d40815-Abstract.html.
50. Aaron Meurer, Christopher P. Smith, Mateusz Paprocki, Ondřej Čertík, Sergey B. Kirpichev, Matthew Rocklin, AMiT Kumar, Sergiu Ivanov, Jason K. Moore, Sartaj Singh, Thilina Rathnayake, Sean Vig, Brian E. Granger, Richard P. Muller, Francesco Bonazzi, Harsh Gupta, Shivam Vats, Fredrik Johansson, Fabian Pedregosa, Matthew J. Curry, Andy R. Terrel, Štěpán Roučka, Ashutosh Saboo, Isuru Fernando, Sumith Kulal, Robert Cimrman, and Anthony Scopatz. SymPy: symbolic computing in Python. *PeerJ Computer Science*, 3:e103, January 2017. ISSN 2376-5992. doi: 10.7717/peerj-cs.103. URL <https://peerj.com/articles/cs-103>. Publisher: PeerJ Inc.
51. Dan Hendrycks, Collin Burns, Steven Basart, Andy Zou, Mantas Mazeika, Dawn Song, and Jacob Steinhardt. Measuring Massive Multitask Language Understanding. *International Conference on Learning Representations*, October 2020. URL <https://openreview.net/forum?id=d7KBjmI3GmQ>.
52. Jacob Andreas. Measuring Compositionality in Representation Learning. *International Conference on Learning Representations*, September 2018. URL <https://openreview.net/forum?id=HJz05o0qK7>.
53. Marianna Nezhurina, Lucia Cipolina-Kun, Mehdi Cherti, and Jenia Jitsev. Alice in Wonderland: Simple Tasks Showing Complete Reasoning Breakdown in State-Of-the-Art Large Language Models, July 2024. URL <http://arxiv.org/abs/2406.02061>. arXiv:2406.02061 [cs].
54. Stephanie C. Y. Chan, Ishita Dasgupta, Junkyung Kim, Dharshan Kumaran, Andrew K. Lampinen, and Felix Hill. Transformers generalize differently from information stored in context vs in weights. NeurIPS MemARI Workshop, October 2022. doi: 10.48550/arXiv.2210.05675. URL <http://arxiv.org/abs/2210.05675>. arXiv:2210.05675 [cs].
55. Gautam Reddy. The mechanistic basis of data dependence and abrupt learning in an in-context classification task. *International Conference on Learning Representations*, 2024. URL <https://openreview.net/forum?id=aN4Jf6Cx69>.

56. Catherine Olsson, Nelson Elhage, Neel Nanda, Nicholas Joseph, Nova DasSarma, Tom Henighan, Ben Mann, Amanda Askell, Yuntao Bai, Anna Chen, Tom Conerly, Dawn Drain, Deep Ganguli, Zac Hatfield-Dodds, Danny Hernandez, Scott Johnston, Andy Jones, Jackson Kernion, Liane Lovitt, Kamal Ndousse, Dario Amodei, Tom Brown, Jack Clark, Jared Kaplan, Sam McCandlish, and Chris Olah. In-context Learning and Induction Heads, September 2022. URL <http://arxiv.org/abs/2209.11895>. arXiv:2209.11895 [cs].
57. Denny Zhou, Nathanael Schärli, Le Hou, Jason Wei, Nathan Scales, Xuezhi Wang, Dale Schuurmans, Claire Cui, Olivier Bousquet, Quoc V. Le, and Ed H. Chi. Least-to-Most Prompting Enables Complex Reasoning in Large Language Models. International Conference on Learning Representations, September 2022. URL <https://openreview.net/forum?id=WZH7099tgfM>.
58. Jason Wei, Xuezhi Wang, Dale Schuurmans, Maarten Bosma, Fei Xia, Ed Chi, Quoc V. Le, and Denny Zhou. Chain-of-thought prompting elicits reasoning in large language models. *Advances in neural information processing systems*, 35:24824–24837, 2022. URL https://proceedings.neurips.cc/paper_files/paper/2022/hash/9d5609613524ecf4f15af0f7b31abca4-Abstract-Conference.html.
59. Guhao Feng, Bohang Zhang, Yuntian Gu, Haotian Ye, Di He, and Liwei Wang. Towards Revealing the Mystery behind Chain of Thought: A Theoretical Perspective. *Advances in Neural Information Processing Systems*, 36:70757–70798, December 2023. URL https://proceedings.neurips.cc/paper_files/paper/2023/hash/dfc310e81992d2e4cedc09ac47eff13e-Abstract-Conference.html.
60. William Merrill and Ashish Sabharwal. The Expressive Power of Transformers with Chain of Thought. International Conference on Learning Representations, 2024. URL <https://openreview.net/forum?id=NjNGLPh8Wh>.
61. Zhiyuan Li, Hong Liu, Denny Zhou, and Tengyu Ma. Chain of Thought Empowers Transformers to Solve Inherently Serial Problems. International Conference on Learning Representations, 2024. URL <https://openreview.net/forum?id=3EWTEy9MTM>.
62. A. N. Kolmogorov. Three approaches to the quantitative definition of information *. *International Journal of Computer Mathematics*, 2(1-4):157–168, January 1968. ISSN 0020-7160, 1029-0265. doi: 10.1080/00207166808803030. URL <http://www.tandfonline.com/doi/abs/10.1080/00207166808803030>.
63. Ming Li and Paul Vitányi. *An Introduction to Kolmogorov Complexity and Its Applications*. Texts in Computer Science. Springer International Publishing, Cham, 2019. ISBN 978-3-030-11297-4 978-3-030-11298-1. doi: 10.1007/978-3-030-11298-1. URL <http://link.springer.com/10.1007/978-3-030-11298-1>.
64. Iain G. Johnston, Kamaludin Dingle, Sam F. Greenbury, Chico Q. Camargo, Jonathan P. K. Doye, Sebastian E. Ahnert, and Ard A. Louis. Symmetry and simplicity spontaneously emerge from the algorithmic nature of evolution. *Proceedings of the National Academy of Sciences*, 119(11):e2113883119, March 2022. doi: 10.1073/pnas.2113883119. URL <https://www.pnas.org/doi/10.1073/pnas.2113883119>. Publisher: Proceedings of the National Academy of Sciences.
65. Kamaludin Dingle, Chico Q. Camargo, and Ard A. Louis. Input–output maps are strongly biased towards simple outputs. *Nature Communications*, 9(1):761, February 2018. ISSN 2041-1723. doi: 10.1038/s41467-018-03101-6. URL <https://www.nature.com/articles/s41467-018-03101-6>. Publisher: Nature Publishing Group.
66. Parikshit Ram, Tim Klinger, and Alexander G. Gray. How Compositional is a Model? In *International Joint Conference on Artificial Intelligence 2023 Workshop on Knowledge-Based Compositional Generalization*, 2023. URL <https://openreview.net/forum?id=OImyRhNLv3>.
67. Brenden M. Lake, Ruslan Salakhutdinov, and Joshua B. Tenenbaum. Human-level concept learning through probabilistic program induction. *Science*, 350(6266):1332–1338, December 2015. ISSN 0036-8075, 1095-9203. doi: 10.1126/science.aab3050. URL <https://science.sciencemag.org/content/350/6266/1332>. Publisher: American Association for the Advancement of Science Section: Research Article.
68. Gabriel Poesia and Noah D. Goodman. Peano: learning formal mathematical reasoning. *Philosophical Transactions of the Royal Society A: Mathematical, Physical and Engineering Sciences*, 381(2251):20220044, June 2023. doi: 10.1098/rsta.2022.0044. URL <https://royalsocietypublishing.org/doi/10.1098/rsta.2022.0044>. Publisher: Royal Society.

69. Trieu H. Trinh, Yuhuai Wu, Quoc V. Le, He He, and Thang Luong. Solving olympiad geometry without human demonstrations. *Nature*, 625(7995):476–482, January 2024. ISSN 1476-4687. doi: 10.1038/s41586-023-06747-5. URL <https://www.nature.com/articles/s41586-023-06747-5>. Publisher: Nature Publishing Group.
70. Samuel Lippel and Kim Stachenfeld. When does compositional structure yield compositional generalization? A kernel theory, May 2024. URL <http://arxiv.org/abs/2405.16391>. arXiv:2405.16391 [cs, q-bio].
71. Takuya Ito, Tim Klinger, Doug H. Schultz, John D. Murray, Michael Cole, and Mattia Rigotti. Compositional generalization through abstract representations in human and artificial neural networks. *Advances in Neural Information Processing Systems*, October 2022. URL <https://openreview.net/forum?id=177GzUAds8U>.
72. Zhongwang Zhang, Pengxiao Lin, Zhiwei Wang, Yaoyu Zhang, and Zhi-Qin John Xu. Initialization is Critical to Whether Transformers Fit Composite Functions by Inference or Memorizing, May 2024. URL <http://arxiv.org/abs/2405.05409>. arXiv:2405.05409 [cs].
73. Luca Saglietti, Stefano Mannelli, and Andrew Saxe. An Analytical Theory of Curriculum Learning in Teacher-Student Networks. *Advances in Neural Information Processing Systems*, 35:21113–21127, December 2022. URL https://proceedings.neurips.cc/paper_files/paper/2022/hash/84bad835faaf48f24d990072bb5b80ee-Abstract-Conference.html.
74. Dan Friedman, Alexander Wettig, and Danqi Chen. Learning Transformer Programs. *Advances in Neural Information Processing Systems*, 36:49044–49067, December 2023. URL https://proceedings.neurips.cc/paper_files/paper/2023/hash/995f693b73050f90977ed2828202645c-Abstract-Conference.html.