

Data-Driven Analysis of AI in Medical Device Software in China: Deep Learning and Traditional AI Trends Based on Regulatory Data

Yu Han^{1,*}, Aaron Ceross^{2,*}, Sarim Ather³, Jeroen H.M. Bergmann^{1,4}

¹ Institute of Biomedical Engineering, Department of Engineering Science, University of Oxford, Oxford, UK

² Birmingham Law School, University of Birmingham, Birmingham, UK

³ NHS Foundation Trust, University of Oxford, UK

⁴ Department of Technology and Innovation, University of Southern Denmark, Odense, Denmark

* These authors contributed equally to this work.

Corresponding authors: yu.han@eng.ox.ac.uk, a.w.k.ceross@bham.ac.uk

Abstract

Artificial intelligence (AI) in medical device software (MDSW) represents a transformative clinical technology, attracting increasing attention within both the medical community and the regulators. In this study, we leverage a data-driven approach to automatically extract and analyze AI-enabled medical devices (AIMD) from the National Medical Products Administration (NMPA) regulatory database. The continued increase in publicly available regulatory data requires scalable methods for analysis. Automation of regulatory information screening is essential to create reproducible insights that can be quickly updated in an ever changing medical device landscape. More than 4 million entries were assessed, identifying 2,149 MDSW registrations, including 385 standalone applications and 1,764 integrated within medical devices, of which 43 were AI-enabled. It was shown that the leading medical specialties utilizing AIMD include respiratory (20.5%), ophthalmology/endocrinology (12.8%), and orthopedics (10.3%). This approach greatly improves the speed of data extracting providing a greater ability to compare and contrast. This study provides the first extensive, data-driven exploration of AIMD in China, showcasing the potential of automated regulatory data analysis in understanding and advancing the landscape of AI in medical technology.

Index terms: software, data, Software as a Medical Device (SaMD), Software in a medical device (SiMD), AI-in-medical-device (AIMD), regulatory affairs, regulatory science

1 China’s New Generation Artificial Intelligence Development Plan and Effect to Medical Devices

In 2017, China’s State Council released its *New Generation Artificial Intelligence Development Plan*, which set forth a strategic roadmap aimed at positioning the country as a global leader in artificial intelligence (AI) technologies [1]. Within the medical devices sector, China has

Date of Publication	Regulatory Document
08/2015	Guidelines of medical device software registration and review [7]
07/2019	Key Points of Deep Learning Decision-making Assisting Medical Device Software review [8]
07/2021	Guidelines for the classification and designation of artificial intelligence medical software [9]
03/2022	Guidelines of medical device software registration and review[10]
08/2022	Guidelines for the classification and designation of artificial intelligence medical software [11]

Table 1: Chinese regulatory documents for medical device software

emerged as a significant global producer and consumer, leveraging its large-scale manufacturing capabilities and distribution networks [2]. Given the country’s population of 1.41 billion in 2023, the demand for advanced medical technology is substantial [3]. The Chinese medical device market, valued at ¥629 billion RMB (approximately \$88.7 billion USD) in 2019, more than doubled from ¥308 billion RMB in 2015 [4]. China’s long-term strategy emphasizes the integration of AI and machine learning into medical domain, with the goal of enhancing clinical support through improved diagnostics and intervention management [5]. In line with this vision, the National Medical Products Administration (NMPA), China’s regulatory authority for medical products, has enacted several regulations to support the development and oversight of AI-driven medical devices. Table 1 summarizes key regulatory documents issued by the NMPA in relation to AI-based medical device software [6]. The NMPA’s first relevant guidance was issued in 2015, with a more comprehensive regulatory framework established in 2022. These regulations reference a range of national standards, including those governing software risk classification (YY/T 0664-2008), software engineering practices (GB/T 19003-2008), and medical device quality management (YY/T 0287-2003) [6].

Medical Device Software (MDSW) encompasses a broad range of applications that support clinical decisions, offering recommendations for diagnosis, prognosis, monitoring, and treatment. These include advanced tools for analyzing radiology images [12], oncology software supporting genetic analysis [13], ophthalmology solutions for image recognition [14], and systems that assist in general medical decision-making [15]. Increasingly, machine learning (ML) models are deployed in areas like diabetes management [16] and tuberculosis diagnosis [17], with studies showing that computer-aided MDSW can sometimes surpass human accuracy in certain diagnostic tasks, such as detecting tuberculosis and diabetic retinopathy [18, 19].

While prior research has explored the deployment of AI-enabled medical devices (AIMD) in various regulatory landscapes, including notable work on regulatory frameworks and device categorization methods [20], our study introduces an innovative, fully automated approach. By leveraging advanced data science techniques, our methodology filters targeted devices directly from the NMPA regulatory database. This automated system enables rapid, comprehensive identification and analysis of AIMD in under one minute after establishing selection criteria,

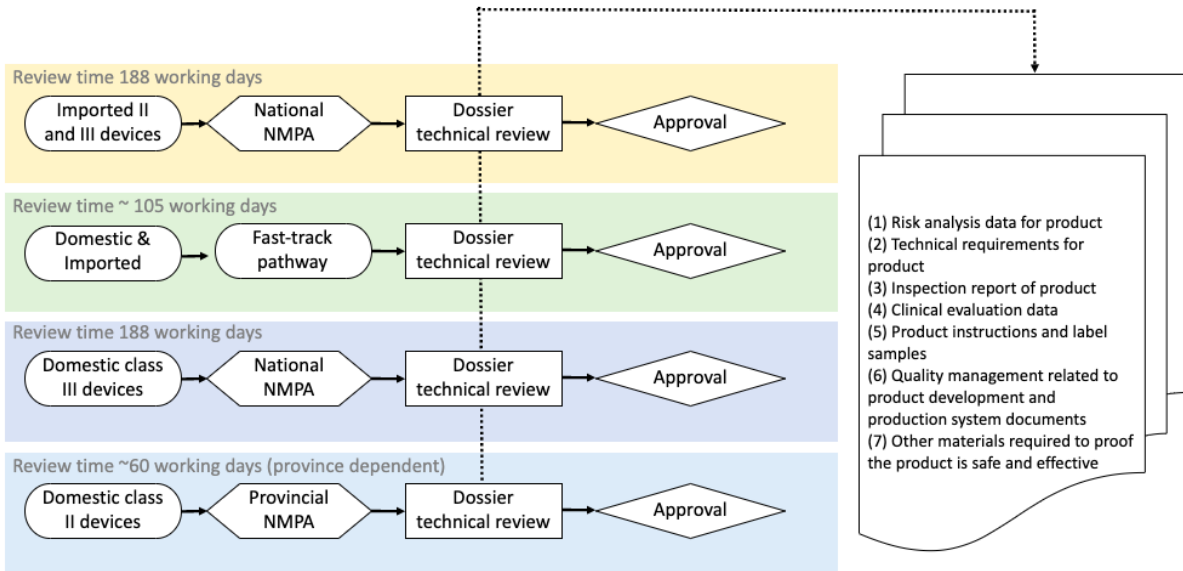

Figure 1: Medical device registration pathways set out by the NMPA. Imported and domestic devices relates to all class II and III devices, for Class I devices, only record-filing is required.

significantly enhancing the efficiency and precision of regulatory data analysis. This automated approach represents a substantial advancement over previous methods, which often involved manual data collection or semi-automated processes, making it a uniquely scalable and efficient solution for regulatory assessment.

China Software Medical Device Registration Process

Figure 1 provides an overview of the medical device registration process administered by the NMPA for various types of devices. The NMPA has also established expedited pathways, including the Innovation Approval [21], Priority Review [22], and Emergency Approval [23] processes. The final version of the “Innovation Approval Procedure for Medical Devices,” published on 5 November 2018, outlines three criteria for fast-track approval: a) The applicant must have completed preliminary research on the product and developed a finalized prototype with comprehensive and traceable research data. b) The primary technical mechanism of the product must be novel, inventive, and hold significant clinical value, meaning that the product’s performance or safety offers distinct advantages over existing alternatives. c) The applicant must either hold the patent for the core technology of the product in China or have obtained the right to use the patent in China through technology transfer [21]. Both domestic and foreign manufacturers are subject to the same application process for innovative device registration.

Unique Device Identification System and Database Background

The Unique Device Identification (UDI) system is a framework proposed by IMDRF and its intention is to adequately identify medical devices from manufacturing through distribution and patient use. Since joining the IMDRF in 2013 [24], China has been adopting and referencing

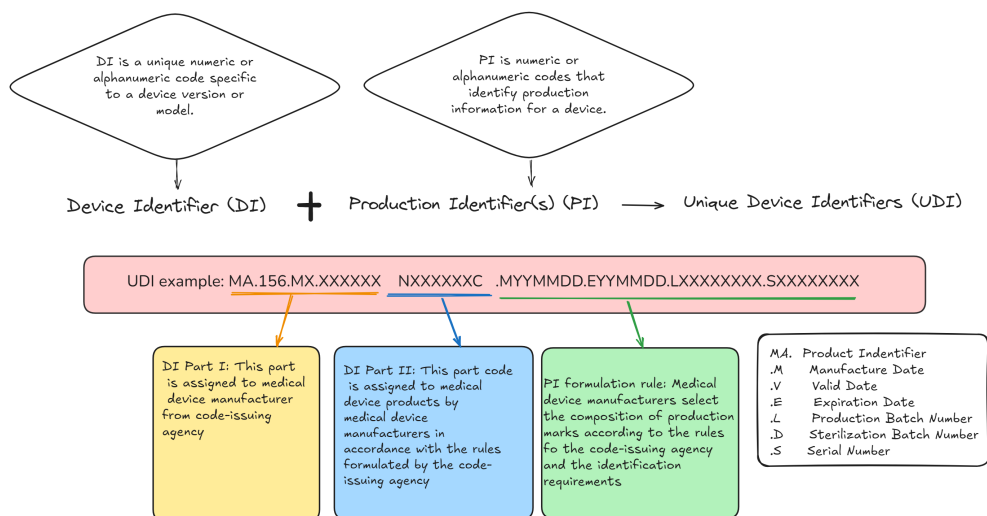

Figure 2: UDI code layout according to YY/T 1630-2018.

international regulatory methods when formulating China regulations. China officially adopted the UDI System in 2019, as outlined by two key documents: (i) Pilot Project Plan for UDI System for Medical Devices (No.56, 2019) [25] and (ii) Rules for Unique Device Identification System (No. 66, 2019) [26]. The NMPA is implementing the adoption of UDI in phases. The strategy is to start with devices that carry the highest risk (Class III) and then proceed to add lower risk devices in each new phase. In January 2021, nine categories of high-risk Class III medical devices were included in the first batch. From June 2022, the second batch of medical devices was included. As of August 2024, there are 4,045,039 products registered with UDI system, with most being general medical devices (96.34%), whilst in vitro medical devices (3.66%) are only making up a small amount of the total registrations[27]. The NMPA’s UDI database is publicly accessible, allowing patients, healthcare providers, and regulatory authorities to quickly access information about a particular medical device.

Figure 2 illustrates the meaning of the number codes in China’s UDI system [28]. A UDI code typically consists of a Device Identifier (UDI-DI) and a Production Identifier (UDI-PI). The UDI-DI refers to a unique numeric or alphanumeric code that is specific to a particular model of medical device and is also used as an access key to information stored in the database. The UDI-PI, on the other hand, identifies the unit of device production with a numeric or alphanumeric code. In China, the UDI-DI is composed of two parts: part I is assigned by the code-issuing agency, while part II is issued by the manufacturer.

Research Aim and Contribution

Our approach utilizes the NMPA’s UDI (Unique Device Identification) database to perform an automated exploratory data analysis (EDA) of medical device software (MDSW), including software as a medical device (SaMD), software in a medical device (SiMD), and AI-enabled medical devices (AIMD). By employing a reproducible, data-driven methodology, our analysis can be completed in under one minute, significantly reducing human bias often present in manual selection processes [20]. This automated approach not only improves accuracy but also fosters

standardization in device registration, aiding the NMPA in refining regulatory guidelines and enhancing data consistency.

The primary objective is to analyze the distribution of MDSW and AI-enabled devices across various medical specialties and applications, examining their origins, the ratio of imported vs. domestic products, and key companies contributing to this field. Our analysis also bridges computer science and medical expertise, providing insights into the most prevalent AI technologies and their medical domain applications, the reasons behind their adoption, and the algorithms commonly used. Additionally, this study demonstrates how, with a deep understanding of regulatory naming conventions, device classification rules, and regulatory principles, computer programs can perform comprehensive AI medical device analysis in seconds—an effective contribution to regulatory science. This approach, with its strong foundation in both regulatory knowledge and computational expertise, offers a scalable solution for automating and accelerating the analysis of other product types, making it a valuable tool for regulatory authorities. Researchers could also utilize the code to conduct other type of medical device research by simply changing product keywords and adjusting product code.

2 Methodology

Definition of MDSW, SiMD, SaMD and AI software

Medical Device Software (MDSW) has seen widespread adoption in China and encompasses both Software as a Medical Device (SaMD) and Software in a Medical Device (SiMD). The International Medical Device Regulators Forum (IMDRF) defines SaMD as software intended for one or more medical purposes, capable of performing these functions without being part of a hardware medical device [29]. Medical purposes, are designed for a range of clinical applications, such as disease diagnosis, prevention, monitoring, treatment, and physiological support, as well as life-sustaining functions and reproductive health management [30]. In China, SaMD can be identified by a six-digit classification code beginning with the number 21, as outlined in the medical device catalogue [31], which is provided in Appendix 1. SaMD functions independently as medical software, while Software-inclusive Medical Devices (SiMD) involve additional components, such as hardware, with the software and hardware working together.

According to NMPA Regulation Guiding Principles for Registration Review of Artificial Intelligence Medical Devices[32], an AI medical device referred to medical device that utilises artificial intelligence technology to achieve its intended use (i.e., medical purposes) by using "medical device data." Medical device data refers to objective data generated by medical devices for medical purposes. This includes medical imaging data generated by medical imaging devices (such as X-ray, CT, MRI, ultrasound, endoscope, optical imaging and so on), physiological parameter data generated by the medical devices (such as ECG, EEG, blood pressure and so on), and in vitro diagnostic data (such as pathological images, microscopic images, invasive blood glucose waveform data and so on). Therefore, an AI medical device refers to a medical device that utilises artificial intelligence technology to process and analyse medical (device) data for medical purposes.

```

MDSW Classification and AI Device Filtering

Step 1: Identify SaMD
SaMD ← FILTER(devices, classification_code STARTS WITH "21-")

Step 2: Identify SiMD
SiMD ← FILTER(devices, "software" IN product_description AND
classification_code NOT STARTS WITH "21-" AND
product_description CONTAINS ("imaging", "surgical", "monitoring",
"measurement", "analysis", "noise reduction", "image enhancement"))

Step 3: Merge MDSW
MDSW ← UNION(SaMD, SiMD)

Step 4: Identify AIMD
AIMD ← FILTER(MDSW, generic_name CONTAINS ("auxiliary diagnosis",
"auxiliary treatment") OR product_description CONTAINS
("AI", "ML", "DL", "CNN", "RNN", "auxiliary diagnosis", "auxiliary treatment"))

Return: MDSW, AIMD

```

Figure 3: Pseudocode for MDSW and AIMD Identification Process

Pre-processing

Description of database

All data analysis was conducted using RStudio (version 2022.12.0, Posit Software, PBC). The exploratory data analysis was performed on the `UDID_FULL_RELEASE_20240801.zip` dataset obtained from the NMPA website [33]. The dataset contains information on medical devices registered with the NMPA UDI system from 2016 to 2024, consisting of approximately 4 million products, each of product labelled with 48 variables, such as product description, version number, generic name, specification, product number, device classification and so on.

Search Strategy

The data was filter using a two-layers strategy [34], as shown in pseudo code in Figure 3 and flowchart in Figure 4. The first layer consisted of filtering out MDSW, which consist of filter out SiMD and SaMD. whilst a second layer was applied to then identify AIMD from first layer result, using keywords shown in Figure 4. After generating the final list, the authors manually filtered it again to remove any devices that did not fall in the AI domain, for example, the devices are not AI-enabled by may provide auxiliary support for the treatment of other diseases.

The filtering process for identifying AI-enabled medical devices (AIMD) was conducted in a structured, multi-stage approach to systematically refine the dataset from the UDI database, which contains approximately 4 million medical devices. First, medical device software (MDSW) was extracted by isolating both Software as a Medical Device (SaMD) and Software in a Medical Device (SiMD). SaMD was identified using the six-digit classification code rule, where codes beginning with “21-” denote standalone software-based medical devices. SiMD, which lacks a specific classification code, was identified using a keyword-based filtering approach applied to product descriptions, ensuring relevance to medical applications. The keywords we adopted included (“software” OR “imaging device” OR “surgical device” OR “monitoring device”

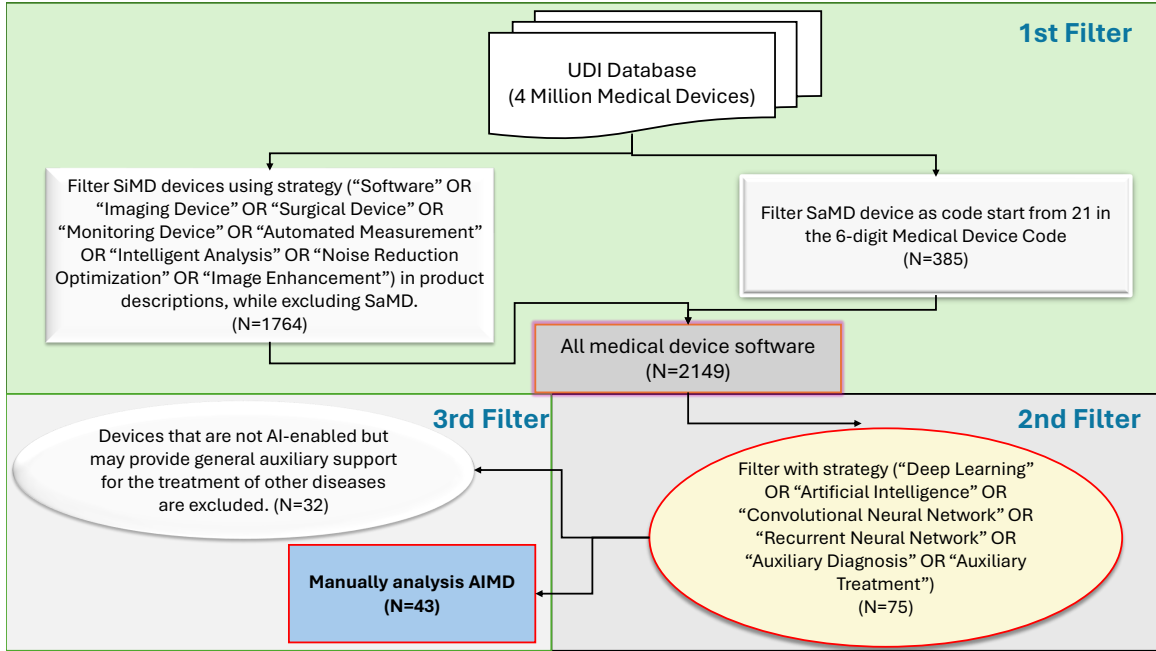

Figure 4: Flowchart for the selection process for the identification of software and AIMD

OR “automated measurement” OR “intelligent analysis” OR “noise reduction optimization” OR “image enhancement”. Devices already categorized as SaMD (21-code rule) were explicitly excluded to prevent misclassification. This process resulted in a total of 2,149 MDSW devices.

To further identify AI-enabled medical devices. According to the Chinese regulation *Guiding principles for naming of medical software* [35], devices which incorporate artificial intelligence must include in their name either the terms (i) Auxiliary diagnosis or (ii) Auxiliary treatment. For example, as indicated in the NMPA regulation, if the radiotherapy contouring software uses non-artificial intelligence technology, it is named "radiotherapy contouring software"; if it uses artificial intelligence technology, it is named "radiotherapy contouring auxiliary decision-making software". So we adopt keywords as searching strategy to filter devices based on the results from first step: an additional filtering layer was applied to the MDSW dataset using strategy: (**“Artificial Intelligence” OR “Machine learning” OR “Deep learning” OR “Reinforcement learning” OR “Auxiliary diagnosis” OR “Auxiliary treatment” OR “Convolutional Neural Network (CNN)” OR “Recurrent Neural Network (RNN)”**). This automated step initially identified 75 candidate AIMD. However, due to regulatory wording, certain false positives emerged, particularly among devices labeled with “Auxiliary Diagnosis” or “Auxiliary Treatment,” which, in some cases, referred to general software support rather than AI-driven functionalities. To refine the dataset, a manual verification step was conducted, eliminating 32 devices that did not exhibit AI functionality, resulting in a final count of 43 AI-enabled medical devices. This structured filtering approach ensured both high precision and recall, effectively distinguishing genuinely AI-enabled medical devices from broader medical software applications.

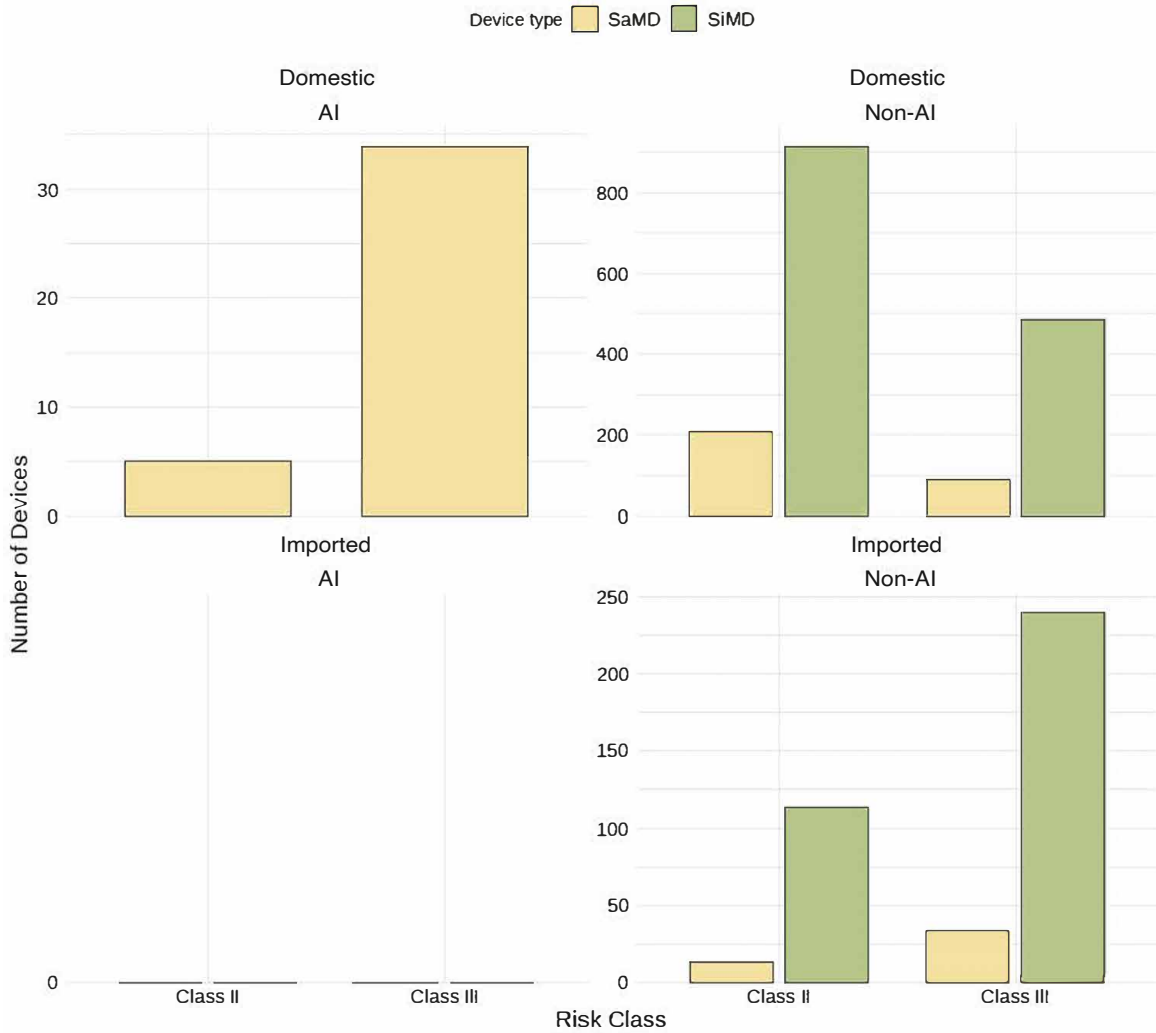

Figure 5: Domestic and Imported SaMD & SiMD Devices: AI vs. Non-AI Distribution. Different scales are applied to each subplot to better illustrate variations across categories.

3 Results

3.1 Devices amount and category

A total of 2,149 MDSW were identified, with 385 classified as SaMD and 1,764 classified as SiMD devices, as shown in Figure 5. The majority of devices are domestic products, with the largest category being domestic SiMD Non-AI devices, comprising over 60% of the total of whole medical software. Imported SiMD non-AI devices constitute approximately 11% of the total. AI-enabled devices are predominantly concentrated in domestic SaMD, making up more than 90% of all AI devices identified. Notably, no SiMD device was found to incorporate AI.

In the filtered device list, we labeled each device register city and province, annotation for AI, non-AI, whether SaMD and SiMD and put into China map as shown in Figure 6, we can see in each province software registration amount in different province of china map.

The analysis of medical device software (MDSW) reveals distinct patterns in the distribution

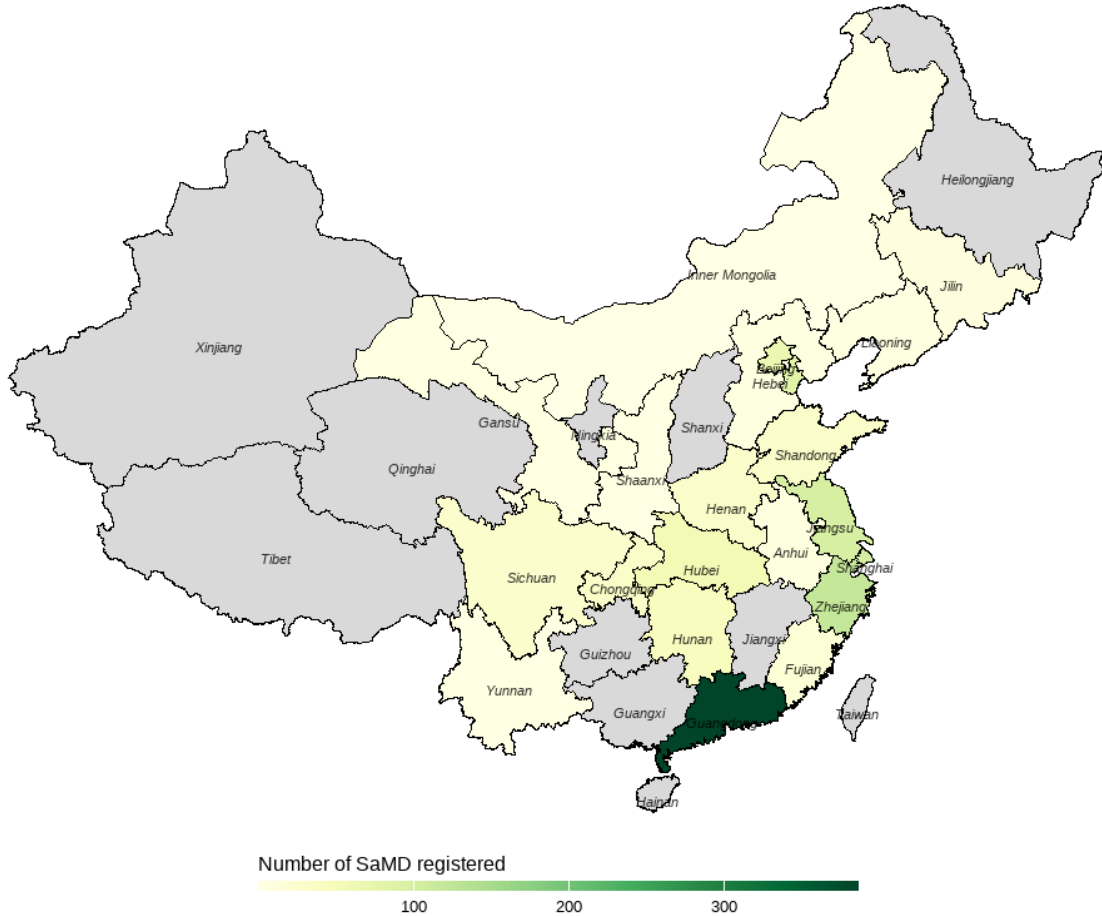

Figure 6: A geographic map of non-foreign medical device software are registration 2020–2024 ($n = 2,149$). The areas include mainland provinces as well as the indication of X_u , which indicates products from the Special Administration Regions.

and classification of Software as a Medical Device (SaMD) and Software in a Medical Device (SiMD). The dataset indicates that SaMD is predominantly domestic, with the majority classified under Class II, suggesting that most standalone software applications in the medical field are moderate-risk solutions rather than high-risk interventions. This aligns with regulatory expectations, as standalone software is often used for decision support, diagnostics, or treatment recommendations, rather than direct intervention in critical medical procedures. In contrast, SiMD is more evenly distributed across domestic and imported categories, with a higher proportion classified as Class III, indicating its integration into high-risk medical equipment.

A key finding is that AI-enabled devices are almost exclusively found in SaMD, with virtually no instances of AI within SiMD. The limited presence of AI in SiMD could be attributed to regulatory constraints, technical integration challenges, or the way information collected and

stored in regulatory system. Additionally, imported SaMD is significantly less common than imported SiMD.

For AI devices, the majority of registrations are for domestic Class III devices, which constitute approximately 70% of the total. This figure includes manufacturers both within and outside of Beijing, as per regulatory requirements mandating that all Class III devices must be registered in Beijing (national level). For Class II devices, the numbers decline progressively, with Guangdong and Hubei each accounting for around 8% of the total registrations. Additional contributions come from Zhejiang (5%), Tianjin (3%), and Jiangsu (2%), with Shanxi and Sichuan provinces each representing 1% of the total registrations.

3.2 Artificial intelligence devices and algorithms in Medical software

The authors cross-checked and validated the machine-filtered information, followed by a manual review to ensure accuracy. This process led to the development of a comprehensive database, which includes 43 AI-enabled devices, as shown in Figure 7. A detailed overview of these devices and their associated algorithms is provided in Appendix 2.

Our approach introduces greater granularity by incorporating the specific anatomical or disease-related focus of AI-enabled medical devices. This distinction is valuable for both manufacturers and patients, as it provides clearer insights into the availability of advanced technologies for specific medical conditions. A medical specialty refers to a distinct branch of medical practice that focuses on a specific group of diseases, organ systems, diagnostic techniques, or therapeutic interventions [36]. Specialties are often defined by the type of medical expertise required, the technology employed, and the patient population served. In the context of AI-enabled medical devices, specialty classification can be based on the primary body system or disease area targeted by the device, rather than solely on its function [37].

The top three medical specialties that use AI-enabled medical devices are respiratory (20.5%), Ophthalmology/Endocrinology (12.8%), and orthopedics (10.3%). Six AI-enabled medical devices (6 out of 43) have successfully utilized the innovation fast track pathway, which is eligible for underscoring the rapid advancement and regulatory approval of cutting-edge technologies in critical medical fields. All six devices are classified as Class III. All devices were registered after 2020, with the majority being registered in 2023 and 2024. This trend indicates that device registration activities are aligned with the regulations outlined in Table 1.

3.3 Artificial intelligence devices and algorithms across different medical domains

We reviewed each device in detail to label their underlying technology. Among the 43 AI-enabled medical devices (AIMD), we found that 32 utilize deep learning (DL), while 11 use traditional AI, as shown in Figure 8.

Deep learning (DL) is applied across a variety of medical specialties, including respiratory imaging, orthopedics, neurology, and the combined fields of ophthalmology and endocrinology, as well as in cardiology, general surgery, and neurosurgery. In contrast, fields such as gastroenterology, obstetrics and gynecology, and otolaryngology tend to rely more on traditional AI techniques. This distribution raises important questions about why certain AI technologies are adopted in specific medical specialties.

Medical imaging techniques vary by machine and medical application. CT provides detailed cross-sectional views of bones, tissues, and blood vessels[38]. MRI captures multi-planar images

without radiation, ideal for diagnosing brain, spine, and musculoskeletal conditions. Ultrasound, using sound waves, is suited for real-time imaging of soft tissues and is portable for bedside use. Endoscopy allows visualization of internal cavities, enabling real-time diagnostics and interventions. Optical imaging, like fundus photography and OCT, is essential in ophthalmology for diagnosing retinal conditions[39].

3.3.1 Deep learning and traditional AI algorithm analysis

Traditional AI, encompasses a wide range of AI techniques and methods, including traditional machine learning algorithms (like decision trees, support vector machines), rule-based systems, and simple statistical models[40]. These techniques are applied to tasks where structured data, such as numerical or categorical data, can be analyzed to classify, predict, or detect patterns. Deep Learning, on the other hand, is a subset of machine learning that focuses on neural networks with multiple layers (also known as deep neural networks). Inspired by the human brain, these networks consist of interconnected layers of artificial neurons that learn to recognize features from raw data inputs through hierarchical abstraction[41]. Deep learning models excel in processing unstructured data, such as images, audio, and text, due to their ability to learn hierarchical representations of data features. Deep learning, with its ability to process large, complex, and unstructured datasets, is particularly suited for specialties including ophthalmology, and neurology, where medical imaging are complex.

3.3.2 Analysis of AI algorithm in certain medical specialty

We extract medical specialties information automatically by identifying the disease location from the generic names. According to the "Rules for Generic Names of Medical Devices" (Order No. 19) [42], characteristic terms describing specific attributes—such as the location of the disease where the software is used—are mandated to be included in the generic name. For example, a device named "Lung Nodule CT Image Auxiliary Detection Software" is classified under respiratory medicine, while "Chronic Glaucoma-like Optic Neuropathy Fundus Image Auxiliary Diagnosis Software" falls under ophthalmology.

We use this data-driven approach to minimize classification bias compared to methods that categorize devices based solely on the technology used. For example, previous work often blurs distinctions by classifying most software that utilize CT scans as radiology, which is not well-structured for future research. [43].

From result, we found that deep learning (DL) is widely used in specialties like respiratory, orthopedics, and neurology. CT scans, with their high resolution and structured data, are ideal for convolutional neural networks (CNNs) [44]. CNNs excel at feature extraction and segmentation, especially in 3D data, making them effective for detecting fractures, tumors, and lung abnormalities in chest, abdomen, and brain imaging.

In respiratory, DL is applied to CT scans and X-rays for tasks like lung cancer detection and pneumonia diagnosis [45], using supervised learning with labeled images. Orthopedics benefits from DL's ability to analyze X-rays, CTs, and MRIs for bone fractures and musculoskeletal conditions [46]. In neurology, DL analyzes brain MRIs to identify tumors, strokes, and Alzheimer's, using supervised learning with labeled data [47]. In gastroenterology, DL is applied to endoscopic images to detect polyps, while traditional AI handles structured data like blood tests [48]. Hepatology and endocrinology similarly rely on traditional AI for analyzing structured clinical data, such as liver function tests and hormone levels, aiding in disease monitoring and treatment

planning [49, 50].

Figure 9 presents a visual representation using a human body diagram, with key medical specialties highlighted and labeled to indicate the specific AI methods and technologies used within each domain. The diagram places these technologies directly near the anatomical regions they impact, offering a more intuitive understanding for readers.

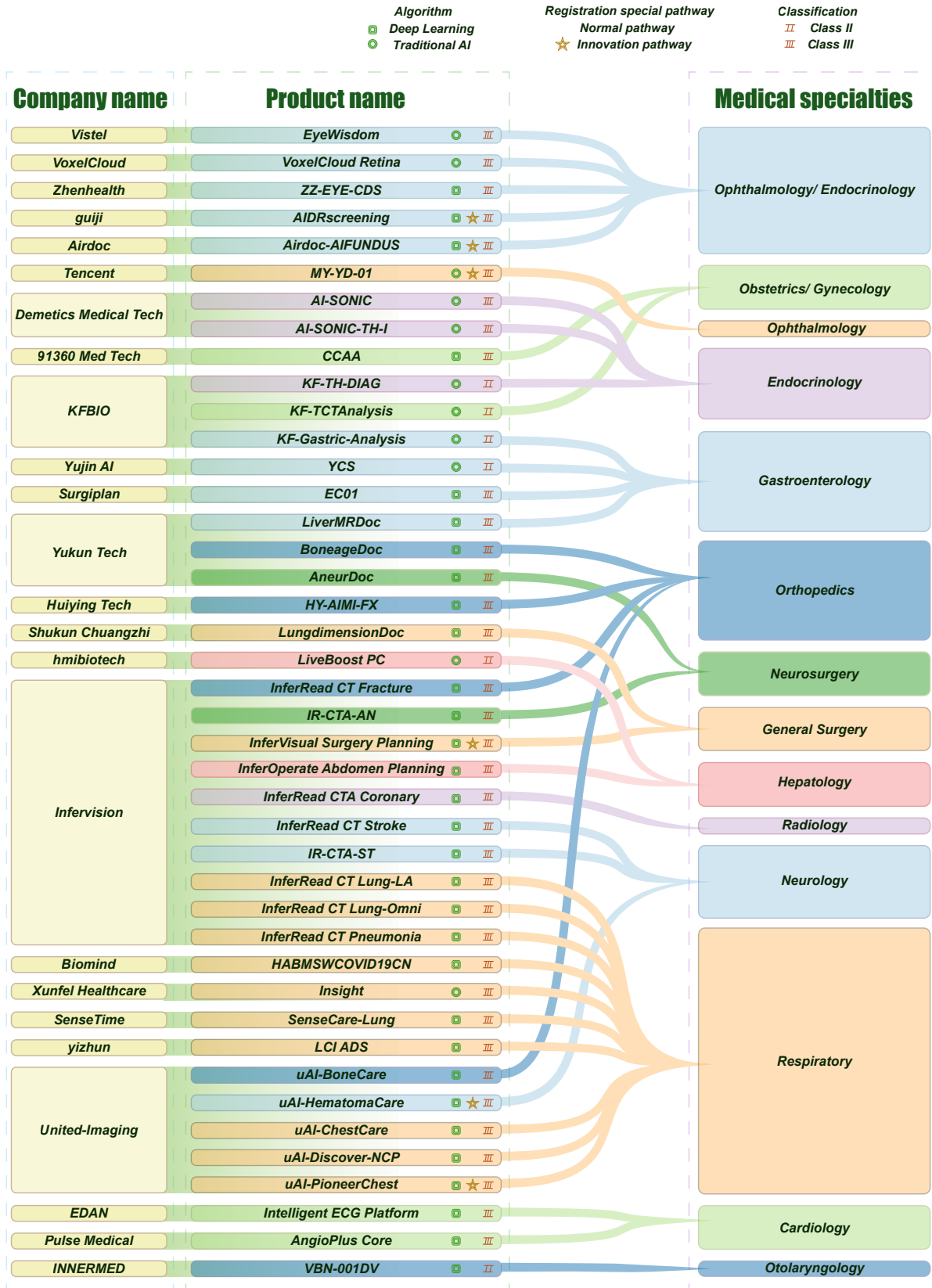

Figure 7: An alluvial diagram illustrating the types of 43 AI medical devices and the risk classifications along with the approval pathways within the NMPA regulatory framework

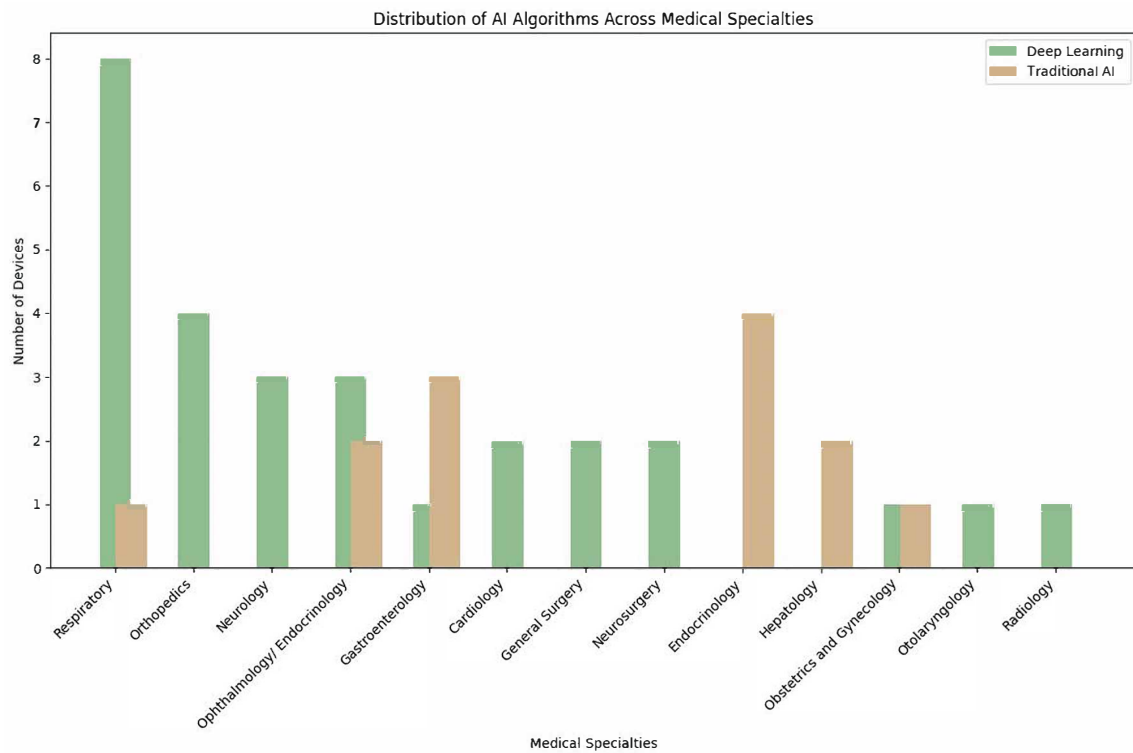

Figure 8: Distribution of AIMD on different medical specialty and algorithm

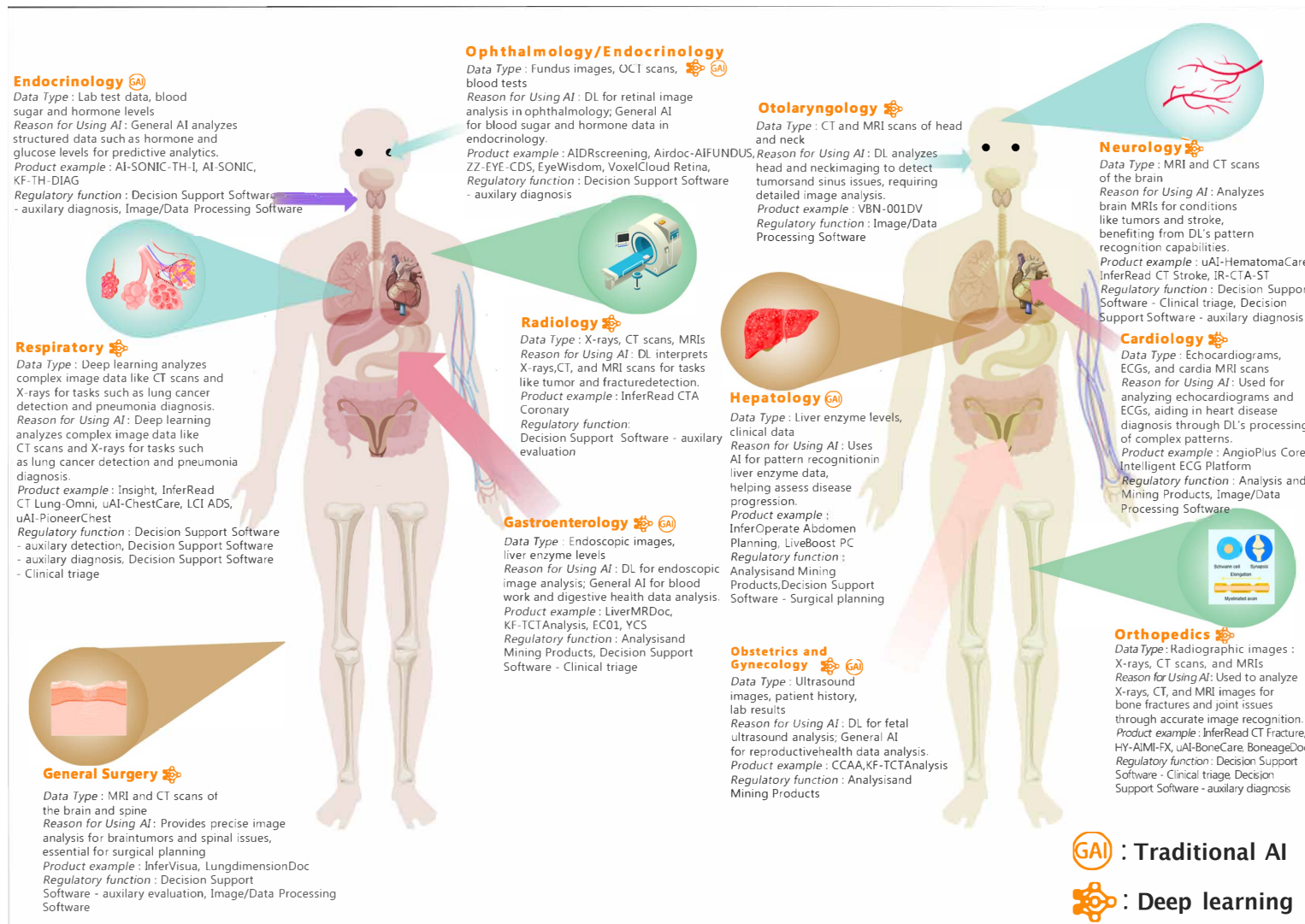

Figure 9: Applications of AI in Different Medical Specialties

3.3.3 Analysis of AI devices

From a functional standpoint, NMPA classifies AI-integrated software into specific functional categories, as outlined in Table 2. Of the 43 devices reviewed, 5 devices fall under the category of Image/Data Processing Software. For instance, INNERMED's VBN-001DV device falls into this category and is classified as Class II, despite incorporating deep learning components. This classification indicates that when the AI algorithm primarily enhances image quality or focuses on segmentation, the NMPA may assign a lower risk classification, reflecting the specific regulatory approach.

30 of the devices fall under the category of Decision Support Software, which is primarily designed to assist medical decision-making. This category can be further classified into subtypes based on functionality: auxiliary detection, auxiliary diagnosis, clinical triage, auxiliary evaluation, and surgical planning. For example, the "CT image-assisted triage software for intracranial hemorrhage" helps diagnose intracranial hemorrhage and supports triage decisions. The Insight, produced by Xunfel Healthcare, is one example. Although it does not utilize deep learning, it aids physicians by providing decision support for lung nodule detection in CT images, and the NMPA has classified it as Class III due to the function. Another device, the AI-SONIC-TH-I by Demetics Medical Tech, offers diagnostic support for thyroid nodule assessment using ultrasound images. Infervision's InferVisual Surgery Planning device provides surgical planning support, including the display, processing, measurement, and analysis of chest CT images. It can automatically identify pulmonary nodules of 4mm and larger, showing their spatial relationship to key anatomical structures—information that thoracic surgeons can use in planning lung surgeries. This device has been granted classification under the innovation pathway, reflecting its advanced functionality in surgical planning support.

5 of these devices are categorized as Analysis and data Mining Products, which are primarily utilized for data analysis and mining. These devices normally process structured data through AI technology to help identify potential risk factors or predict disease progression. The "chronic liver disease risk calculation software" is used to assess the risk of chronic liver disease, supporting early clinical intervention.

The fast-track pathway designation has been awarded to several devices, including uAI-HematomaCare and uAI-PioneerChest from United-Imaging in the areas of neurology and respiratory, respectively; AIDRscreening by Guiji in the field of ophthalmology/endocrinology; MY-YD-01 from Tencent, also in ophthalmology; InferVisual Surgery Planning by Infervision for general surgery; and Airdoc-AIFUNDUS from Airdoc, again in ophthalmology/endocrinology. This trend may underscore the growing importance of ophthalmological AI technologies in China and reflects a global market demand for innovative ophthalmic solutions.

Table 3: Foreign companies with software devices.

Company	Country	Classification	medical specialty
Simemens Healthcare GmbH	USA	III	Radiology
Nucletron B.V.	Nerthland	III	Radiology
Vavian Medical System	USA	III	Radiology
MIM Software	USA	III	Radiology

Table 2: Divide AIMD by software function from NMPA regulation

Category	Description	Number of Devices
Decision Support Software	Devices used for assisting medical decision-making that apply an AI algorithm, such as software for lesion identification and drug dosage calculation.	30
(a) Auxiliary detection	Assists in detecting medical conditions, often using imaging data or other diagnostic inputs.	1
(b) Auxiliary diagnosis	Supports diagnosis processes by providing probabilistic assessments or condition classification.	16
(c) Clinical triage	Aids in triaging patients based on severity, prioritizing care delivery.	10
(d) Auxiliary evaluation	Offers evaluation support, such as predicting treatment outcomes or assessing patient risk factors.	1
(e) Surgical planning	Provides guidance and planning for surgical procedures through image analysis or patient-specific modeling.	2
Image/Data Processing Software	Devices used for medical imaging and data processing using AI algorithms, enabling tasks like image segmentation and fusion.	5
Analysis and Data Mining Products	Devices used to analyze and mine medical-related data, applicable in fields like drug development, medical research, and hospital information management.	5
Medical Assistant Products	Based on electronic health records or patient information, these devices use NLP and other technologies to make logical inferences about the patient’s condition.	-

3.4 International regulatory inconsistency

Table 3 presents the AI-enabled medical devices (AIMD) imported into China from other countries, with the majority originating from the USA. Most of these devices are categorized under radiology, and all are classified as Class III devices, regulated by the National Office in Beijing.

It should be noted that regulatory inconsistency of medical device across countries have been observed during the study. The same medical device could be classified differently in different regions based on the local regulatory environment. It was found that for example, the device that was registered by MIM software, whose Chinese license number is National20153211878, has been classified as class III [51] in China according to product code system (21-01-01). Nonetheless, this same device is classified as class II in USA, according to its USA 510(k) number K103576 [52]. This finding might suggest that more stringent registration requirements exist in China for certain devices. In the USA, a classification II device is typically registered based on a predicate device that has already been approved, and the manufacturer must demonstrate that certain characteristics of the device are the same as those of the predicate device, and that the device will not pose any safety or effectiveness concerns. From a regulatory perspective, a higher classification normally implies more stringent requirements for manufacturers. For example, authorities may require more testing, including even clinical trials. In the case of MIM software, the higher classification (III) in China indicates that clinical evaluation and possibly clinical trials were needed. This is a regulatory challenge manufacturers need to consider when they plan to place their product in a global market.

We have reviewed the regulatory system and compiled a table of official requirements, as shown in Table 4. One key difference is that FDA’s 510(k) pathway allows Class II devices to gain clearance if they demonstrate substantial equivalence to an existing device. In contrast, NMPA often requires clinical evaluation for AI-based medical devices even at Class II, and may classify certain decision-support AI systems as Class III when the FDA considers them Class II. This difference explains why MIM Software’s AI-enabled medical imaging device is classified as Class III in China but only Class II in the U.S.. It reflects the regulatory logic, particularly for decision-support systems that could impact diagnostic outcomes.

To provide a more comprehensive comparison of AI-enabled medical device regulation, we expanded beyond this UDI dataset result to include multiple devices classified by both the FDA and NMPA. This broader dataset allows for a more nuanced analysis beyond a single observation, revealing key regulatory differences between the two agencies. For instance, Aidoc AI for CT stroke detection is Class II (510(k)) in the U.S. [53], yet classified as Class III in China. The FDA’s De Novo pathway, which accommodates novel technologies, was used for Viz.ai’s stroke triage system [54], whereas the NMPA placed it under Class III, treating it as a high-risk device. In contrast, some AI-based radiology solutions, such as Zebra Medical Vision, align in classification across both jurisdictions (Class II under 510(k) in the U.S. and Class II in China) [55]. However, for high-risk AI applications such as HeartFlow’s AI-based CT analysis for coronary artery disease (CAD), both agencies classify the device as Class III, requiring rigorous clinical evidence [56].

These findings highlight that regulatory classification is influenced not only by the nature of the AI algorithm but also by clinical application, national safety policies, and specific regulatory frameworks. While the FDA frequently utilizes predicate-based approvals and the De Novo pathway for novel AI technologies, the NMPA once classify it as III, clinical trials will needed for AI-driven decision-support systems. This regulatory divergence underscores the broader complexities of AI medical device approval, demonstrating that differences are not solely dictated

by technological innovation but are also shaped by jurisdictional risk assessment policies and evolving national regulatory strategies.

Table 4: Comparison of Medical Device Regulatory Frameworks: FDA vs. NMPA

Regulatory Factor	FDA (United States)	NMPA (China)
Regulatory Framework	Medical devices are classified under 21 CFR Parts 800-898	Classified based on the Medical Device Classification Catalogue
Classification System	Three classes: I (low risk), II (moderate risk), III (high risk)	Three classes: I (low risk), II (moderate risk), III (high risk)
Risk-Based Approach	Risk assessment follows intended use and risk to patient safety	Similar risk-based approach, often more stringent for AI-driven decision-support devices
Class I Devices	Low risk: General controls (e.g., bandages, gloves)	Low risk: General controls (e.g., surgical masks)
Class II Devices	Moderate risk: General + special controls (e.g., X-ray systems)	Moderate risk: Requires technical review (e.g., diagnostic ultrasound systems)
Class III Devices	High risk: PMA required	High risk: Technical review + clinical trials
Approval Paths	<ul style="list-style-type: none"> - 510(k) for Class II (demonstrates substantial equivalence to a predicate device) - De Novo for novel moderate-risk devices - PMA (Pre-Market Approval) for Class III high-risk devices 	<ul style="list-style-type: none"> - Class II & III require clinical evidence - Class III demands full clinical trials unless exemptions apply
Clinical Evidence Requirements	<ul style="list-style-type: none"> - Class I: Typically exempt - Class II: Bench testing, software validation, predicate comparison - Class III: Clinical trial data, human factors validation, risk mitigation plans 	<ul style="list-style-type: none"> - Class I: Exempt - Class II: Regulatory testing, clinical evaluation - Class III: Mandatory clinical trials unless explicitly waived
SaMD Regulation	Assessed per device classification and IMDRF SaMD framework	Specific guidance for AI/software under NMPA rules
Foreign Device Registration	Requires approval in origin country or extensive documentation	Requires origin approval + local clinical trials (in some cases)
UDI Implementation	Mandatory UDI for all classes	Gradual UDI adoption; regional variations exist
Harmonization Efforts	Member of IMDRF (International Medical Device Regulators Forum), moving towards global alignment	Member of IMDRF, yet retains national requirements

4 Discussion

The automated method and limitation

The automated search process demonstrated significant efficiency, particularly in processing a vast dataset of 4 million devices. Unlike previous studies [43], our method employed a more structured filtering approach that substantially improved accuracy and reliability. First, we systematically identified software-based devices and applied the 21-code rule to precisely extract Software as a Medical Device (SaMD)—a highly accurate step that is often overlooked by other methodologies without regulatory background author. This rule allowed us to confidently isolate the standalone SaMDs from the broader dataset. Subsequently, we further refined our search by implementing keyword-based filtering on the resulting medical software products, effectively pinpointing AI-enabled medical devices. This automated multi-step approach enabled us to reduce the dataset to a manageable and highly relevant subset while ensuring further rigorous selection process.

A key strength of this study is it is the first study in regulatory science about application of data science methods to map license numbers and automate the filtering of devices, offering a reusable process that contrasts with manual approaches or keyword-based methods used in other studies [20], [43]. using the code, reserachers could use their own keyword strategy and do the analysis at ease.

False positive results and regulatory term

In the final filtering stage, after applying keyword-based identification, we initially identified 75 devices. However, upon manual review, 32 devices were excluded. The removal of these devices was not due to a fundamental flaw in our methodology but rather a result of the regulatory terminology “auxiliary diagnosis” and “auxiliary treatment,” which are explicitly defined within NMPA regulations as inclusion criteria for medical devices. AI-enabled devices frequently incorporate this terminology in their official naming conventions [35]. According to regulatory guidelines, AI is presumed to be involved in auxiliary functions but is not necessarily the primary functional component of the device. It is crucial to distinguish that not all devices labeled with auxiliary functions are genuinely AI-enabled. This relationship follows a logical structure: $A \subseteq B$, but not necessarily $A = B$ —meaning that while all AI-enabled devices for auxiliary diagnosis or treatment are captured, not all devices labeled for auxiliary functions necessarily utilize AI. Consequently, the primary source of false positives in our analysis arises from this regulatory language rather than a limitation in the automated filtering approach. Researchers employing alternative methodologies that do not rely on these specific regulatory terms would likely not encounter this issue. For example, one device manually excluded from our dataset was a red light therapy system. Its product description contained the term “auxiliary treatment,” yet it did not incorporate any AI-based functionality. The description stated: “The red light therapy device consists of hardware and software components, typically including a light radiation source (such as LEDs), a control unit, and a support structure (which may include positioning components). It may also be equipped with light-guiding accessories. By utilizing red light wavelengths to irradiate gynecological areas (some devices may also include infrared wavelengths), it induces photochemical reactions and/or biological stimulation within human tissues, achieving an auxiliary treatment effect.”

Limitations of the Dataset and Why AI is currently absent in SiMDs

One key limitation of this study is that the dataset is derived from the UDI (Unique Device Identification) system, which does not provide a comprehensive representation of the entire medical device industry. The dataset is heavily influenced by how manufacturers choose to report their product information and how regulatory authorities define and enforce reporting requirements. This variability in data entry practices affects the completeness and accuracy of AI-related classifications within regulatory databases. Through this study, we aim to highlight these limitations, providing insights for industry professionals, researchers, and regulatory bodies to enhance AI medical device classification and reporting standards.

Our investigation into medical devices registered within the UDI system—including GE Vivid ultrasound, Canon MRI and CT scanners, and Edwards Lifesciences cardiac surgical monitors—revealed a significant discrepancy between product functionalities and their regulatory descriptions. Canon’s MRI and CT scanners integrate Deep Learning Reconstruction (DLR) and AICE noise reduction algorithms, which enhance image quality and diagnostic accuracy [57]. GE’s MRI systems feature AIR Recon DL, an AI-powered reconstruction technique designed to improve image sharpness while reducing scan times [58], GE Vivid ultrasound systems incorporate AI-based functionalities, including automated segmentation and measurement of left ventricular ejection fraction (LVEF), which enhance cardiac imaging and analysis [59]. Edwards Lifesciences’ cardiac surgical monitors employ the Acumen Hypotension Prediction Index (HPI), which utilizes predictive analytics to forecast hemodynamic instability during surgery [60]. Despite these well-documented AI functionalities, the corresponding UDI records lack explicit references to AI or related terminology such as “deep learning” or “machine learning.”

These findings highlight a gap in the current UDI data entry methods, where AI-enabled features are not systematically labeled in product descriptions. This omission suggests that while AI is increasingly integrated into medical devices, regulatory databases may not yet fully capture or standardize AI-related attributes. As AI adoption in medical imaging and monitoring continues to grow, further refinement in regulatory reporting could improve transparency and facilitate AI-specific assessments within the UDI framework. This partially constitute why in this data analysis, AI is currently absent in SiMDs.

Deep Learning and Traditioanl AI

The classification of devices into deep learning and traditional AI was based on the terminology present in the medical device database and supplemented by expert review.

Devices were classified as deep learning-based if their product descriptions explicitly mentioned terms such as: Deep Learning, CNN, RNN. Traditional AI Classification refer to Devices were classified into this category if they referenced. Artificial Intelligence or Machine Learning without specifying deep learning techniques, other Statistical and rule-based AI models. The classification was not directly provided by the database but was instead inferred from the textual descriptions and keywords found within the dataset.

From data, We observed that deep learning-based devices were more frequently categorized as Class III (high-risk) medical devices, particularly in imaging-related applications. Traditional AI devices, such as rule-based decision support systems, had a broader distribution across Class II and Class III categories. DL devices predominantly used for automated image analysis, segmentation, and real-time diagnostic assistance. Traditional AI devices were more frequently associated with predictive modeling, decision-support systems, and clinical workflow optimization.

Whether DL contribute to higher classification?

In our real data analysis, Analysis of device classification trends indicates that the assignment of Class II or Class III status is primarily determined by intended use and associated risk, complexity of the AI algorithm itself constitute the risk but not the only reason. Higher-risk applications, such as autonomous diagnosis, treatment planning, or real-time monitoring of critical conditions, are more likely to be classified as Class III, irrespective of whether they employ deep learning or rule-based AI. In contrast, lower-risk applications, including non-critical decision support, workflow automation, and basic image enhancement, are typically classified as Class II. While deep learning techniques are more commonly observed in Class III devices, they are also present in Class II applications where the risk to patient safety remains moderate. Similarly, certain high-risk devices classified as Class III do not necessarily rely on deep learning, as advanced diagnostic systems based on traditional AI methods can also pose significant clinical risks.

The data indicate that domestically manufactured Class III AI-enabled SaMDs far outnumber their imported counterparts, whereas the difference in AI-enabled SiMDs between domestic and foreign devices is smaller. This reinforces the point that, while we know certain devices utilize AI, their UDI records often lack explicit indicators or keywords that would allow researchers to identify them. As a result, the absence of clear labeling in regulatory databases may introduce biases in research, highlighting the need for authorities to ensure that the information provided is comprehensive and accurately reflects AI integration.

In the study, we found traditional AI approaches are prevalent in specialties like gastroenterology and endocrinology, where structured data and well-established rules guide clinical decision-making. The interpretability and lower computational demands of traditional AI make it suitable for these fields, whereas deep learning is driving innovation in more complex diagnostic areas.

Fast-track approvals

Among the six fast-track approvals in China, three focus on ophthalmology, reflecting the demand for AI technologies like Guiji's AIDR screening device for diabetic retinopathy. The global market for such diagnostic software is projected to grow steadily, indicating strong market acceptance in China, in line with the New Generation Artificial Intelligence Development Plan [61].

5 Conclusion and Future Work

Benjamins et al.[43] manually reviewed FDA data and identified 64 AI/ML-based medical devices, validating the information through various sources. In comparison, Muehlematter et al.[62] found around 500 AI medical devices in the US and EU databases, though they did not specify their filtering or validation methods. Benjamins et al. also noted issues with the precision of keyword searches, highlighting the need for an AI labelling system for tracking devices.

To leverage data science for better regulatory analysis, a clear device labelling or coding system is essential. While China launched an AI medical device platform in 2019 [63], no aggregated AI medical database has been published. The FDA's has database of approved AI devices which is easier to track the AI devices. [64].

One limitation of this study stems not from our coding but from the NMPA UDI database itself, which compiles registered devices in multiple rounds or batches, potentially leaving some devices out of the dataset. This may account for slight differences between our results and those of previous studies [20]. This limitation affects the representativeness of our findings. Nonetheless,

the NMPA UDI remains the most comprehensive dataset available for Chinese devices to date, highlighting the pressing need for a more complete, AI-focused regulatory database [43].

As AI medical devices raise concerns about ethics, reproducibility, cybersecurity, and bias [65], better tracking and surveillance through dedicated databases are increasingly necessary. Ethical issues such as algorithmic fairness and data privacy, along with potential impacts on the doctor-patient relationship, are significant challenges [66]. While the public has been captivated by AI advancements like ChatGPT [67], the rapid growth of AI-enabled medical devices underscores the need for robust regulation and monitoring.

The fast-evolving field of AI in medical devices calls for a unified global regulatory response [68]. A standardized database and labelling system across regions would help track AI devices, improve patient safety, and streamline the integration of new technologies into healthcare.

Competing interests

The authors declare no competing interests.

DATA AVAILABILITY

The scripts used to carry out the analysis and the resultant data that support the findings in this study are available on: <https://github.com/Oxford-NIL/NMPA-analysis>

References

- [1] State Council of the People’s Republic of China, “Notice of the state council on the new generation artificial intelligence plan,” 2017. [Online]. Available: http://www.gov.cn/zhengce/content/2017-07/20/content_5211996.htm
- [2] W. M. Morrison, *China’s economic rise: history, trends, challenges, and implications for the United States*. Congressional Research Service Washington, DC, 2013.
- [3] worldometer, “China population in 2022.” [Online]. Available: <https://www.worldometers.info/world-population/china-population/>
- [4] Deloitte, “Chinese medical device industry: How to thrive in an increasingly competitive market?” 2021. [Online]. Available: <https://www2.deloitte.com/cn/en/pages/life-sciences-and-healthcare/articles/chinese-medical-device-industry-whitepaper.html>
- [5] J. He, S. L. Baxter, J. Xu, J. Xu, X. Zhou, and K. Zhang, “The practical implementation of artificial intelligence technologies in medicine,” *Nature Medicine*, vol. 25, no. 1, pp. 30–36, 2019.
- [6] Y. Han, A. Ceross, and J. Bergmann, “Regulatory frameworks for ai-enabled medical device software in china: Comparative analysis and review of implications for global manufacturers,” *JMIR AI*, vol. 3, p. e46871, 2024.
- [7] NMPA, “Announcement of the nmpa on issuing the guiding principles for technical review of medical device software registration.” [Online]. Available: <https://www.nmpa.gov.cn/ylqx/ylqxggtg/ylqxqtgg/20150805120001562.html?type=pc&m=>

- [8] Artificial Intelligence Medical Device Innovation and Cooperation Platform, “Key points of deep learning decision-assisting medical device software review.” [Online]. Available: <http://aimd.org.cn/newsinfo/1339997.html?templateId=506998>
- [9] National Medical Products Administration, “Announcement of nmpa on issuing the guiding principles for the classification and definition of artificial intelligence medical software products (no. 47 of 2021),” 2021. [Online]. Available: <https://www.nmpa.gov.cn/xxgk/ggtg/qtggtg/20210708111147171.html?type=pc&m=>
- [10] CCFDIE, “Announcement of the center for device evaluation of the state food and drug administration on the release of the guidelines for the registration and review of medical device software (2022 revision) (2022 no. 9).” [Online]. Available: <https://www.ccfdie.org/cn/yjxx/ylqx/webinfo/2022/03/1648289422496885.htm>
- [11] CIRS, “Notice of the center for device evaluation of the nmpa on issuing the guiding principles for the registration review of artificial intelligence medical devices (no. 8, 2022).” [Online]. Available: <https://www.cirs-group.com/cn/md/gyjqqszxgyfbrgznylqzxcsczdyzdtg-2022nd8h>
- [12] X. Wang, Y. Peng, L. Lu, Z. Lu, M. Bagheri, and R. M. Summers, “Chestx-ray8: Hospital-scale chest x-ray database and benchmarks on weakly-supervised classification and localization of common thorax diseases,” in *IEEE Conference on Computer Vision and Pattern Recognition (CVPR)*, 2017, pp. 3462–3471.
- [13] N. M. Patel, V. V. Micheli, J. M. Snell, S. Balu, A. P. Hoyle, J. S. Parker, M. C. Hayward, D. A. Eberhard, A. H. Salazar, P. McNeillie *et al.*, “Enhancing next-generation sequencing-guided cancer care through cognitive computing,” *The Oncologist*, vol. 23, no. 2, p. 179, 2018.
- [14] D. S. W. Ting, L. R. Pasquale, L. Peng, J. P. Campbell, A. Y. Lee, R. Raman, G. S. W. Tan, L. Schmetterer, P. A. Keane, and T. Y. Wong, “Artificial intelligence and deep learning in ophthalmology,” *British Journal of Ophthalmology*, vol. 103, no. 2, pp. 167–175, 2019.
- [15] P. Szolovits, *Artificial intelligence in medicine*. Routledge, 2019.
- [16] G. P. Forlenza, “Use of artificial intelligence to improve diabetes outcomes in patients using multiple daily injections therapy,” *Diabetes Technology & Therapeutics*, vol. 21, no. S2, pp. S2–4, 2019.
- [17] C. Tzelios and R. R. Nathavitharana, “Can ai technologies close the diagnostic gap in tuberculosis?” *The Lancet Digital Health*, vol. 3, no. 9, pp. e535–e536, 2021.
- [18] Z. Z. Qin, S. Ahmed, M. S. Sarker, K. Paul, A. S. S. Adel, T. Naheyan, R. Barrett, S. Banu, and J. Creswell, “Tuberculosis detection from chest x-rays for triaging in a high tuberculosis-burden setting: an evaluation of five artificial intelligence algorithms,” *The Lancet Digital Health*, vol. 3, no. 9, pp. e543–e554, 2021.
- [19] M. D. Abramoff, P. T. Lavin, M. Birch, N. Shah, and J. C. Folk, “Pivotal trial of an autonomous ai-based diagnostic system for detection of diabetic retinopathy in primary care offices,” *NPJ Digital Medicine*, vol. 1, no. 1, pp. 1–8, 2018.

- [20] Y. Liu, W. Yu, and T. Dillon, “Regulatory responses and approval status of artificial intelligence medical devices with a focus on china,” *npj Digital Medicine*, vol. 7, no. 1, p. 255, 2024.
- [21] NMPA, “Announcement of the state food and drug administration on publishing the special review procedures for innovative medical devices (2018 no. 83).” [Online]. Available: <https://www.nmpa.gov.cn/zhuanti/cxylqx/cxylqxzyxx/20181105160001106.html?type=pc&m=>
- [22] —, “Announcement of the general administration on publishing the priority review and approval procedures for medical devices (no. 168, 2016).” [Online]. Available: <https://www.nmpa.gov.cn/xxgk/ggtg/qtggtg/20161026164001187.html>
- [23] —, “Announcement of the state food and drug administration on issuing the "emergency approval procedures for medical devices" (2021 no. 157).” [Online]. Available: <https://www.nmpa.gov.cn/ylqx/ylqxggtg/20211230171343118.html?type=pc&m=>
- [24] M. Yue, Z. Wenwen, P. Shuo, H. Yiwu, L. Bin, and L. Zhong, “Imdrf interpretation of personalized medical device terms,” *China Pharmaceutical Affairs*, vol. 33, no. 1, pp. 41–44, 2019.
- [25] NMPA, “Pilot project plan for udi system for medical devices (no.56, 2019).” [Online]. Available: <https://www.nmpa.gov.cn/directory/web/nmpa/xxgk/fgwj/gzwj/gzwjylqx/20190703175301499.html>
- [26] —, “Rules for unique device identification system (no. 66, 2019).” [Online]. Available: <https://www.nmpa.gov.cn/ylqx/ylqxggtg/ylqxqtgg/20190827092601750.html>
- [27] N. M. P. Administration, “Medical device udi database,” <https://udi.nmpa.gov.cn/>.
- [28] NMPA, “Yy/t 1630-2018.” [Online]. Available: <https://udi.nmpa.gov.cn/toDetail.html?infoId=66&CatalogId=2>
- [29] Food and Drug Administration, “Software as a medical device.” [Online]. Available: <https://www.fda.gov/medical-devices/digital-health-center-excellence/software-medical-device-samd>
- [30] International Medical Device Regulators Forum (IMDRF), “Software as a Medical Device (SaMD): Key Definitions,” 2013, accessed: 2024-02-01. [Online]. Available: <https://www.imdrf.org/documents/software-medical-device-samd-key-definitions>
- [31] NMPA, “Medical device catalog.” [Online]. Available: <https://www.nmpa.gov.cn/wwwroot/gyx02302/flml.htm>
- [32] National Medical Products Administration, “Announcement of nmpa issuing the guidelines for the classification and definition of artificial intelligence medical software products,” 2021. [Online]. Available: <https://www.nmpa.gov.cn/xxgk/ggtg/qtggtg/20210708111147171.html?type=pc&m=>
- [33] —, “Udi dataset reference.” [Online]. Available: <https://udi.nmpa.gov.cn>
- [34] The National Medical Products Administration, “Unique Device Identifier database,” 2023. [Online]. Available: <https://udi.nmpa.gov.cn/>

- [35] "Medical Equipment" Magazine Issue 15, 2022, "Review points of artificial intelligence software for ct imaging." [Online]. Available: <https://www.ylzbzz.org.cn/index.php?m=content&c=index&a=show&catid=43&id=152>
- [36] J. M. Torpy, A. E. Burke, and R. M. Glass, "Medical specialties," *JAMA*, vol. 298, no. 9, pp. 1120–1120, 2007.
- [37] G. Weisz, "The emergence of medical specialization in the nineteenth century," *Bulletin of the History of Medicine*, vol. 77, no. 3, pp. 536–574, 2003.
- [38] V. Van Ballaer, A. Dubbeldam, E. Muscogiuri, L. Cockmartin, H. Bosmans, W. Coudyzer, J. Coolen, and W. de Wever, "Impact of ultra-high-resolution imaging of the lungs on perceived diagnostic image quality using photon-counting ct," *European Radiology*, vol. 34, no. 3, pp. 1895–1904, 2024.
- [39] A. Greco, L. Meomartino, G. Gnudi, A. Brunetti, and M. Di Giancamillo, "Imaging techniques in veterinary medicine. part ii: Computed tomography, magnetic resonance imaging, nuclear medicine," *European Journal of Radiology Open*, vol. 10, p. 100467, 2023.
- [40] P. Dinesh, A. Vickram, and P. Kalyanasundaram, "Medical image prediction for diagnosis of breast cancer disease comparing the machine learning algorithms: Svm, knn, logistic regression, random forest and decision tree to measure accuracy," in *AIP Conference Proceedings*, vol. 2853, no. 1. AIP Publishing, 2024.
- [41] S. K. Zhou, H. Greenspan, and D. Shen, *Deep learning for medical image analysis*. Academic Press, 2023.
- [42] C. Food and D. Administration, "Rules for the naming of generic names of medical devices," Order No. 19 of the China Food and Drug Administration, 2015, accessed on [insert date of access]. [Online]. Available: <https://www.nmpa.gov.cn/ylqx/ylqxfgwj/ylqxbmgzh/20151221120001127.html>
- [43] S. Benjamens, P. Dhunoo, and B. Meskó, "The state of artificial intelligence-based fda-approved medical devices and algorithms: an online database," *NPJ digital medicine*, vol. 3, no. 1, p. 118, 2020.
- [44] S. Iqbal, A. N. Qureshi, J. Li, and T. Mahmood, "On the analyses of medical images using traditional machine learning techniques and convolutional neural networks," *Archives of Computational Methods in Engineering*, vol. 30, no. 5, pp. 3173–3233, 2023.
- [45] M. A. Thanoon, M. A. Zulkifley, M. A. A. Mohd Zainuri, and S. R. Abdani, "A review of deep learning techniques for lung cancer screening and diagnosis based on ct images," *Diagnostics*, vol. 13, no. 16, p. 2617, 2023.
- [46] V. Bousson, N. Benoist, P. Guetat, G. Attané, C. Salvat, and L. Perronne, "Application of artificial intelligence to imaging interpretations in the musculoskeletal area: Where are we? where are we going?" *Joint Bone Spine*, vol. 90, no. 1, p. 105493, 2023.
- [47] J. Chaki and M. Woźniak, "Deep learning for neurodegenerative disorder (2016 to 2022): A systematic review," *Biomedical Signal Processing and Control*, vol. 80, p. 104223, 2023.

- [48] Y. Takahashi, E. Dungubat, H. Kusano, and T. Fukusato, “Artificial intelligence and deep learning: New tools for histopathological diagnosis of nonalcoholic fatty liver disease/nonalcoholic steatohepatitis,” *Computational and Structural Biotechnology Journal*, vol. 21, pp. 2495–2501, 2023.
- [49] J. M. Schattenberg, N. Chalasani, and N. Alkhouri, “Artificial intelligence applications in hepatology,” *Clinical Gastroenterology and Hepatology*, vol. 21, no. 8, pp. 2015–2025, 2023.
- [50] K. Van Uytfanghe, J. Ehrenkranz, D. Halsall, K. Hoff, T. P. Loh, C. A. Spencer, J. Köhrle, and A. T. F. T. W. Group, “Thyroid stimulating hormone and thyroid hormones (triiodothyronine and thyroxine): an american thyroid association-commissioned review of current clinical and laboratory status,” *Thyroid*, vol. 33, no. 9, pp. 1013–1028, 2023.
- [51] Daohoo, “Medical image processing and radiotherapy planning software for seed implantation medical imaging software (national20153701878).” [Online]. Available: <https://www.daohoogroup.com/zhuceshuju/804.html>
- [52] FDA 510(k) database, “Medical imaging system.” [Online]. Available: <https://www.accessdata.fda.gov/scripts/cdrh/cfdocs/cfpdc/classification.cfm?id=5630>
- [53] Aidoc. (2024) ‘time is brain’: Aidoc releases complete ai package to speed identification and treatment of stroke. Accessed: 2024-XX-XX. [Online]. Available: <https://www.aidoc.com/about/news/aidoc-stroke-package/>
- [54] S. P. Boggs, “Fda approves marketing of clinical decision support software for stroke triage in midst of renewed focus on digital health applications,” 2018, accessed: 2024-XX-XX. [Online]. Available: https://www.squirepattonboggs.com/~media/files/insights/publications/2018/03/ahla-article-fda-approves-marketing-of-clinical-decision-support-software-for-stroke-triage-in-midst-of-renewed-focus-on-digital-health-applications-ahla_hit_alert_3818.pdf
- [55] U.S. Food and Drug Administration (FDA), “Zebra medical vision ltd. - 510(k) premarket notification,” 2020, accessed: 2024-XX-XX. [Online]. Available: <https://www.accessdata.fda.gov/scripts/cdrh/cfdocs/cfpmn/pmn.cfm?ID=K200905>
- [56] HeartFlow, “Heartflow to present latest data on ai-enabled coronary artery disease management at tct 2024,” 2024, accessed: 2024-XX-XX. [Online]. Available: <https://www.heartflow.com/newsroom/heartflow-to-present-latest-on-ai-enabled-coronary-artery-disease-management/>
- [57] Canon Medical Systems, “Aice deep learning reconstruction,” 2024, accessed: February 1, 2025. [Online]. Available: https://anz.medical.canon/products/computed-tomography/aice_dlr
- [58] GE Healthcare, “Air recon dl - magnetic resonance imaging,” 2024, accessed: February 1, 2025. [Online]. Available: <https://www.gehealthcare.com/products/magnetic-resonance-imaging/air-recon-dl>
- [59] —, “Vivid ultrasound systems,” 2024, accessed: February 1, 2025. [Online]. Available: <https://www.gehealthcare.com.au/products/ultrasound/vivid>

- [60] Edwards Lifesciences, “Acumen hypotension prediction index (hpi),” 2024, accessed: February 1, 2025. [Online]. Available: <https://www.edwards.com/healthcare-professionals/products-services/predictive-monitoring/hpi>
- [61] QY Research, “Diabetic retinopathy fundus image-assisted diagnosis software report 2024, global revenue, key companies market share & rank,” 2024, accessed: 2024-10-07. [Online]. Available: <https://cn.qyresearch.com/reports/3318113/diabetic-retinopathy-fundus-image-assisted-diagnosis-software>
- [62] U. J. Muehlematter, P. Daniore, and K. N. Vokinger, “Approval of artificial intelligence and machine learning-based medical devices in the usa and europe (2015–20): a comparative analysis,” *The Lancet Digital Health*, vol. 3, no. 3, pp. e195–e203, 2021.
- [63] AIMD, “ARTIFICIAL INTELLIGENT MEDICAL DEVICE INNOVATION AND COOPERATION PLATFORM.” [Online]. Available: <https://www.aimd.org.cn/>
- [64] U.S. Food and Drug Administration, “Artificial intelligence and machine learning (ai/ml)-enabled medical devices,” 2023, accessed: 2023-10-07. [Online]. Available: <https://www.fda.gov/medical-devices/software-medical-device-samd/artificial-intelligence-and-machine-learning-aiml-enabled-medical-devices>
- [65] S. Dalton-Brown, “The ethics of medical ai and the physician-patient relationship,” *Cambridge Quarterly of Healthcare Ethics*, vol. 29, no. 1, pp. 115–121, 2020.
- [66] A. D. Stern, W. J. Gordon, A. B. Landman, and D. B. Kramer, “Cybersecurity features of digital medical devices: an analysis of fda product summaries,” *BMJ open*, vol. 9, no. 6, p. e025374, 2019.
- [67] T. H. Kung, M. Cheatham, A. Medenilla, C. Sillos, L. De Leon, C. Elepaño, M. Madriaga, R. Aggabao, G. Diaz-Candido, J. Maningo *et al.*, “Performance of chatgpt on usmle: Potential for ai-assisted medical education using large language models,” *PLOS Digital Health*, vol. 2, no. 2, p. e0000198, 2023.
- [68] Y. Han, A. Ceross, and J. Bergmann, “More than red tape: exploring complexity in medical device regulatory affairs,” *Frontiers in Medicine*, vol. 11, p. 1415319, 2024.