

Reducing the Large Set Threshold for the Basu-Oertel Conjecture

Andrés Cristi *

David Salas †

Abstract

In 1960, Grünbaum proved that for any convex body $C \subset \mathbb{R}^d$ and every halfspace H containing the centroid of C , one has that the volume of $H \cap C$ is at least a $\frac{1}{e}$ -fraction of the volume of C . Recently, in 2017, Basu and Oertel conjectured that a similar result holds for mixed-integer convex sets. Concretely, they proposed that for any convex body $C \subset \mathbb{R}^{n+d}$, there should exist a point $\mathbf{x} \in S = C \cap (\mathbb{Z}^n \times \mathbb{R}^d)$ such that for every halfspace H containing \mathbf{x} , one has that

$$\mathcal{H}_d(H \cap S) \geq \frac{1}{2^n} \frac{1}{e} \mathcal{H}_d(S),$$

where \mathcal{H}^d denotes the d -dimensional Hausdorff measure. While the conjecture remains open, Basu and Oertel proved that the above inequality holds true for sufficiently large sets, in terms of a measure known as the *lattice width* of a set. In this work, by following a geometric approach, we improve this result by substantially reducing the threshold at which a set can be considered large. We reduce this threshold from an exponential to a polynomial dependency on the dimension, therefore significantly enlarging the family of mixed-integer convex sets over which the Basu-Oertel conjecture holds true.

1 Introduction

A classic result by Grünbaum [13] states that for every convex body $C \subset \mathbb{R}^d$, and for every halfspace H of \mathbb{R}^d , one has that

$$H \text{ contains the centroid of } C \implies \frac{\text{vol}_d(H \cap C)}{\text{vol}_d(C)} \geq \left(\frac{d}{d+1} \right)^d, \quad (1.1)$$

where $\text{vol}_d(\cdot)$ stands for the usual d -dimensional volume (given by the Lebesgue measure over \mathbb{R}^d). Note that the function $d \mapsto \left(\frac{d}{d+1} \right)^d$ is decreasing and it converges to $\frac{1}{e}$ as d grows to infinity. Thus, the above inequality entails that

$$H \text{ contains the centroid of } C \implies \frac{\text{vol}_d(H \cap C)}{\text{vol}_d(C)} \geq \frac{1}{e}. \quad (1.2)$$

This result, nowadays known as Grünbaum's inequality, (together with the study of general measures over convex sets, see [13, 14]) is at the core of many advances in convex geometry, see,

*EPFL, Lausanne, Switzerland. andres.cristi@epfl.ch

†Instituto de ciencias de la Ingeniería, Universidad de O'Higgins, Rancagua, Chile. david.salas@uoh.cl

e.g., [6, 8–10, 17, 18, 20, 21]. It has also been used in the field of optimization in the study of cutting plane algorithms [19] and randomized algorithms [7, 11, 15]. A particularly interesting application is the study of the information complexity of mixed-integer convex optimization [3–5]: if we want to optimize a linear objective function over a convex body that we can access only via a separation oracle, Grünbaum’s inequality gives a bound on the minimum number of queries to the oracle required to find the solution.

Motivated by its application to mixed-integer convex optimization, Basu and Oertel [5] studied how to extend Grünbaum’s inequality to *mixed-integer convex bodies*, that is, sets of the form $S := C \cap (\mathbb{Z}^n \times \mathbb{R}^d)$, where C is a convex body. Their analysis followed three steps. First, the relative volume of a set $A \subset S$ should be given by

$$\mu(A) = \frac{\sum_{z \in \mathbb{Z}^n} \text{vol}_d(A \cap (\{z\} \times \mathbb{R}^d))}{\sum_{z \in \mathbb{Z}^n} \text{vol}_d(S \cap (\{z\} \times \mathbb{R}^d))}, \quad (1.3)$$

This idea of volume for mixed-integer convex sets can be formalized using Hausdorff measures, see Section 2 below. Second, since the centroid of S can be outside S , they proposed to replace it by a *centerpoint*: a point $\bar{\mathbf{x}} \in S$ is a centerpoint of S if it belongs to the argmax of

$$\mathcal{F}(S) := \max_{\mathbf{x} \in S} \left(\inf \{ \mu(H \cap S) : H \text{ is a halfspace with } \mathbf{x} \in H \} \right). \quad (1.4)$$

We call $\mathcal{F}(S)$ the Basu-Oertel radius of S (we provide an alternative formulation in Section 2.2). Note that Basu and Oertel showed in [5] that S always admits centerpoints, which explains the max operation in the definition of $\mathcal{F}(S)$. Finally, they studied lower bounds for $\mathcal{F}(S)$, in the spirit of Grünbaum’s inequality (1.1).

A worst-case-like example and the Basu-Oertel conjecture: Let $K \subset \mathbb{R}^d$ be a d -dimensional compact cone, $C = [0, 1]^n \times K$ and $S = C \cap (\mathbb{Z}^n \times \mathbb{R}^d) = \{0, 1\}^n \times K$. In this example, one can easily prove the following facts:

- All centerpoints are given by the points (z, c) with $z \in \{0, 1\}^n$ and c the centroid of K .
- for any halfspace H containing a centerpoint (z, c) , one has that

$$\mu(H \cap S) \geq \frac{1}{2^n} \left(\frac{d}{d+1} \right)^d$$

- By taking a halfspace $H = H_n \times H_d$ such that H_n separates z from the other points in $\{0, 1\}^n$ and $H_d \cap K$ is the subcone of K with base passing through the centerpoint, one has that

$$\mu(H \cap S) = \frac{\text{vol}_d(H_d \cap K)}{2^n \text{vol}_d(K)} = \frac{1}{2^n} \left(\frac{d}{d+1} \right)^d.$$

Thus, in this example, $\mathcal{F}(S) = \frac{1}{2^n} \left(\frac{d}{d+1} \right)^d$. This is, however, a kind of worst-case example: since one can isolate the integer variables of $\{0, 1\}^n$ and the volume of all the fibers is the same, one basically is forced to apply Grünbaum’s inequality at one fiber that has a fraction of $\frac{1}{2^n}$ of the total volume. Then, Basu and Oertel conjecture that this is in fact, the worst-scenario.

Conjecture 1 (Basu-Oertel). *Let $C \subset \mathbb{R}^{n+d}$ be a convex body and $S = C \cap (\mathbb{Z}^n \times \mathbb{R}^d)$. Then,*

$$\mathcal{F}(S) \geq \frac{1}{2^n} \frac{1}{e}.$$

The partial results of Basu and Oertel: The main contributions of Basu and Oertel concerning Conjecture 1 are two¹. First, following an approach based on Helly numbers (see, e.g., [3] and the references therein), Basu and Oertel proved in [5] that

$$\forall S \text{ mixed-integer convex body on } \mathbb{Z}^n \times \mathbb{R}^d, \quad \mathcal{F}(S) \geq \frac{1}{2^n(d+1)}. \quad (1.5)$$

While the factor $\frac{1}{2^n}$ was expected after the discussion, the factor $\frac{1}{d+1}$ is only better than the conjectured constant factor $1/e$ for the case $d = 1$.

Secondly, if the set of integer points in \mathbb{Z}^n belonging to the projection of S is large, then Conjecture 1 holds true. The concept of “large set” was measured in terms of the *lattice width* which, for a set $D \subset \mathbb{R}^n$, is defined as

$$\omega(D) = \min_{u \in \mathbb{Z}^n \setminus \{0\}} \left(\max_{z \in D} u^\top z - \min_{z \in D} u^\top z \right). \quad (1.6)$$

For a set C in \mathbb{R}^{n+d} , by denoting $\text{proj}_{\mathbb{R}^n}(C)$ as the (orthogonal) projection of C onto \mathbb{R}^n with the natural identification $\mathbb{R}^{n+d} = \mathbb{R}^n \times \mathbb{R}^d$, we adopt the convention that $\omega(C) = \omega(\text{proj}_{\mathbb{R}^n}(C))$. Properly, the positive result of Basu and Oertel can be summarized in the following result.

Theorem 1.1 ([5, Theorem 3.6]). *There exists a universal constant $\alpha > 0$ such that for every $n, d \in \mathbb{N}$ and every convex body $C \subset \mathbb{R}^{n+d}$ with $\omega(C) > 2cn(n+d)^{5/2}\alpha n^{n+1}$ for some $c \in \mathbb{R}_+$, then*

$$\mathcal{F}(C \cap (\mathbb{Z}^n \times \mathbb{R}^d)) \geq e^{-\frac{1}{c}-1} + e^{-\frac{2}{c}} - 1.$$

In particular, if $c \in \mathbb{R}_+$ is such that $e^{-\frac{1}{c}-1} + e^{-\frac{2}{c}} - 1 \geq 2^{-(n+1)}$, then Conjecture 1 holds true for C .

To get an idea of how large $\omega(C)$ needs to be in the above theorem, we can look at the values of c at which the bound $e^{-\frac{1}{c}-1} + e^{-\frac{2}{c}} - 1$ is non-negative. That is, we can write

$$\begin{aligned} e^{-\frac{1}{c}-1} + e^{-\frac{2}{c}} - 1 \geq 0 &\implies e^{-2/c} \left(e^{1/c-1} + 1 \right) \geq 1 \\ &\implies -\frac{2}{c} + \log(e^{1/c-1} + 1) \geq 0 \implies c \geq 2. \end{aligned}$$

Thus, the threshold given in Theorem 1.1 is quite large: For the bound to be meaningful, it requires the lattice width $\omega(C)$ to be at least $\Omega((n+d)^{5/2}n^{n+2})$.

Our contributions: To the best of our knowledge, Conjecture 1 is still open and the results of [5] described above are the state-of-the-art for it. In our work, we focus on reducing the threshold at which a set is large enough so that Conjecture 1 holds. Our main results are Theorem 4.5 and Corollary 4.7:

- We prove that there exists a universal constant $\alpha > 0$ such that if $\text{proj}_{\mathbb{R}^n}(C)$ contains a ball of radius $k \geq \alpha d^2 n^{3/2}$, then Conjecture 1 holds.

¹The work [5] and the subsequent works [3, 4] are much richer than what we are describing here. To reduce the exposition, we focus our attention only on the elements that are pertinent to Conjecture 1.

- By passing through a unimodular transformation, we deduce a new threshold in terms of the lattice width of the set. We prove that there exists a universal constant $\alpha' > 0$ such that if $\omega(C) \geq \alpha' d^2 n^6$, then Conjecture 1 holds true.

These results improve on Theorem 1.1 by reducing the exponential dependency on n to an explicit polynomial one, and also by reducing the dependency on d from $d^{5/2}$ to d^2 . This enlarges considerably the family of sets where Conjecture 1 holds true and provides further indications that it might be true in general.

The rest of the manuscript is organized as follows. In Section 2 we provide some preliminaries and fix some notation. In Section 3 we present a special proof for the case $n = 1$ and in Section 4 we present the general case and our main results. While it is possible to omit Section 3, we include it since the approach is different from the one we followed in Section 4. Both Section 3 and Section 4 are organized in the same way: we first provide an outline of the proof; Then we present all the elements as technical lemmas; Finally, we provide the main theorems of the section. We finish the work with some final comments.

2 Preliminaries

In what follows, we consider $n, d \in \mathbb{N}$ and we set $C \subset \mathbb{R}^{n+d}$ to be a convex body, that is, a convex compact set with nonempty interior. We denote by $S = C \cap (\mathbb{Z}^n \times \mathbb{R}^d)$ as the mixed-integer set induced by C .

It will be useful to adopt the following convention: We identify \mathbb{R}^{n+d} with $\mathbb{R}^n \times \mathbb{R}^d$. We use the letters z, w to denote elements of \mathbb{R}^n and letters x, y to denote elements of \mathbb{R}^d . We use bold characters \mathbf{x}, \mathbf{y} to denote elements of $\mathbb{R}^n \times \mathbb{R}^d$. Then, for every $\mathbf{x} \in \mathbb{R}^{n+d}$, we write $\mathbf{x} = (z, x) \in \mathbb{R}^n \times \mathbb{R}^d$.

We formalize the notion of volume for general sets using Hausdorff measures. For every $r \geq 0$, we denote by \mathcal{H}_r the r -dimensional Hausdorff measure (see, e.g., [12, Definition 2.1]). When r is an integer, \mathcal{H}_r coincides with the r -dimensional Lebesgue measure over each affine space of dimension r . For any set $K \subset \mathbb{R}^{n+d}$ we denote by $\dim K$ its Hausdorff dimension (see, e.g., [12, Definition 2.2]) which is given as

$$\dim K = \inf\{r > 0 : \mathcal{H}_r(K) = 0\}.$$

When K is a convex set, the $\dim K$ coincides with the dimension of the affine hull of K , $\text{aff}(K)$. So, if K is a convex body and $\dim K = q$, then the usual q -dimensional volume of K coincides $\mathcal{H}_q(K)$. When K is a disjoint union of convex sets (as it is the case of mixed-integer convex sets), then the Hausdorff dimension of K is given by the maximal Hausdorff dimension of its convex components. Thus, in the case where $C \subset \mathbb{R}^{n+d}$ is a convex body and $S = C \cap (\mathbb{Z}^n \times \mathbb{R}^d)$, one has that the measure $\mu(\text{cdot})$ defined in Equation (1.3) coincides with the normalization of \mathcal{H}^d , that is,

$$\forall A \subset S, \quad \mu(A) = \frac{\sum_{z \in \mathbb{Z}^n} \text{vol}_d(A \cap (\{z\} \times \mathbb{R}^d))}{\sum_{z \in \mathbb{Z}^n} \text{vol}_d(S \cap (\{z\} \times \mathbb{R}^d))} = \frac{\mathcal{H}_d(A)}{\mathcal{H}_d(S)}.$$

In general, for every compact set K one has that

$$\mathcal{H}_q(K) = \begin{cases} +\infty & \text{if } q < \dim K, \\ V \in [0, +\infty) & \text{if } q = \dim K, \\ 0 & \text{if } q > \dim K. \end{cases}$$

Thus, the Hausdorff measure \mathcal{H}^q provides a good extension of the q -dimensional volume of an arbitrary compact set. Moreover, the “intrinsic” volume of a set K is given by $\mathcal{H}_{\dim K}(K)$. For further information on Hausdorff measures, we refer the reader to [12].

For a convex set K of dimension $q = \dim K$, we define the centroid of K

$$\mathbf{c}(K) = \frac{1}{\mathcal{H}_q(K)} \int_K x \, d\mathcal{H}_q(x). \quad (2.1)$$

Note that the centroid is a vector in $\text{aff}(K)$ and, since K is convex, it is contained in K . In our context, it is enough to note that for a finite disjoint union of convex sets, the Hausdorff dimension coincides with the maximum of the dimensions of the elements of the union. In particular, if C has at least one interior point $\mathbf{x} = (z, x)$ with $z \in \mathbb{Z}^n$, then $\dim S = d$.

For a set $A \subset \mathbb{R}^p$, we denote by $\text{conv}(A)$ and by $\text{aff}(A)$ the convex and affine hull respectively. We also write $\text{dist}(\cdot, A)$ to denote the distance function to A . If A is convex and closed, we also write proj_A to denote its metric projection.

2.1 Some facts about cones

A set $K \subset \mathbb{R}^p$ (with $p \geq 2$) is said to be a cone if it is given by the convex hull of a point $x \in \mathbb{R}^p$ and a compact convex set B verifying that $x \notin \text{aff}(B)$. In such a case, we write $K = \text{cone}(x, B)$. The height of the cone is given by $h = \text{dist}(x, \text{aff}(B))$. We recall the following facts about cones, that will be used in the sequel.

First, the volume of a cone $K = \text{cone}(x, B)$ with $q = \dim B$ and $q + 1 = \dim K$ is given by

$$\mathcal{H}_{q+1}(K) = \frac{1}{q+1} \cdot h \cdot \mathcal{H}_q(B), \quad (2.2)$$

where h is the height of K .

Now, consider $K' = \text{cone}(x, B')$ as a subcone of K with height $h' < h$: that is, $\text{aff}(B')$ is parallel to $\text{aff}(B)$ with $B' = K \cap \text{aff}(B')$ and $h' = \text{dist}(x, \text{aff}(B))$, see Figure 1. In this case, the volumes of K and K' verify that

$$\mathcal{H}_{q+1}(K') = \left(\frac{h'}{h}\right)^{q+1} \mathcal{H}_{q+1}(K). \quad (2.3)$$

Finally, consider the subcone K' induced by the centroid of K , that is, $K' = \text{cone}(x, B')$, where $B' = K \cap V$ and V is the unique affine space parallel to $\text{aff}(B)$ with $\mathbf{c}(K) \in V$. Then, the height of K' is proportional to the height of K , verifying that $h' = \frac{\dim K}{1 + \dim K} h$. In other words, the centroid of K divides the height in the proportion $1 : \dim K$.

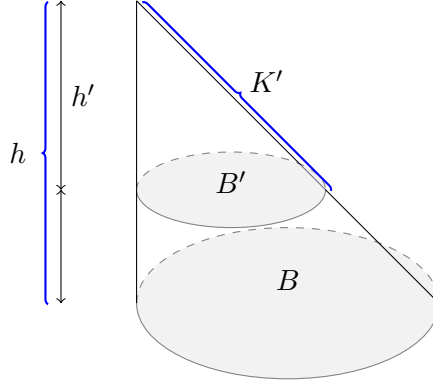

Figure 1: Subcone $K' = \text{cone}(x, B')$ of $K = \text{cone}(x, B)$ with height $h' < h$.

2.2 Basu-Oertel radius

Let $K \subseteq \mathbb{R}^p$. For $x \in K$ and $u \in \mathbb{R}^p \setminus \{0\}$ we define $H(u, x) = \{y \in \mathbb{R}^p : u^\top(y - x) \geq 0\}$. Let $q = \dim K$. We define the *Basu-Oertel radius* of K as

$$\mathcal{F}(K) = \sup_{x \in K} \inf_{u \in \mathbb{R}^p \setminus \{0\}} \frac{\mathcal{H}_q(H(u, x) \cap K)}{\mathcal{H}_q(K)}. \quad (2.4)$$

Note that we consider the $(\dim K)$ -Hausdorff measure of $H(u, x) \cap K$ rather than its volume in its own dimension, to put zero measure on the extreme cases where $H(u, x) \cap K$ has lower dimension. Also note that when K is a mixed-integer convex body, the Basu-Oertel radius is attained by some elements of K , as we discussed in the introduction (see [5]).

3 The case $n = 1$

Throughout this section we consider $n = 1$: that is, $C \subseteq \mathbb{R}^{d+1}$ and $S = C \cap (\mathbb{Z} \times \mathbb{R}^d)$. Without losing any generality, we assume that $\text{proj}_{\mathbb{Z}}(S) = \{0, \dots, k\}$ and that the length of C along the first dimension is k (by replacing C with $\text{conv}(S)$ if necessary). We denote the connected components of S by S_0, \dots, S_k , ordered by increasing integral coordinate. Finally, for $i \in \{0, \dots, k-1\}$, Denote by C_i the section of width 1 of C defined as $C_i = C \cap \{(z, x) \in \mathbb{R}^{d+1} : z \in [i, i+1]\}$.

Our goal is to prove that there exists a universal constant $\alpha > 0$ such that

$$k \geq \alpha d^2 \implies \mathcal{F}(S) \geq \frac{1}{2} \left(\frac{d}{d+1} \right)^d. \quad (3.1)$$

To do so, our strategy can be split in the following steps:

1. First, we prove that the volume of each box C_i is small with respect to $\mathcal{H}_{d+1}(C)$ when k is large. This is Lemma 3.1.
2. We show that for any halfspace H in \mathbb{R}^{d+1} , we can bound $\mathcal{H}_d(H \cap S)$ from below by a factor of $\mathcal{H}_{d+1}(H \cap C)$. We do so using a reference point in $\text{int}(H \cap C)$ and providing outer approximations of boxes $C_i \cap H$ using cones built from the fibers $S_i \cap H$ and the reference

point. To derive the bound, we dismiss the boxes C_i that are too close to the reference point, where the outer approximation is not good enough. This is Lemma 3.2.

3. We provide an upper bound for $\mathcal{H}_d(S)$ in terms of $\mathcal{H}_{d+1}(C)$, with a factor that tends to 1 when $k \rightarrow \infty$. We do so by considering inner approximations using extreme points in the fibers S_0 and S_k , and the fibers S_i . This is Lemma 3.3.
4. Finally, we show that by losing a small fraction of volume, we can move the centroid of C such that its belongs to S . This is Lemma 3.4.

By carefully balancing all these bounds and the errors they carry, we proceed as follows: we take \bar{x} as the moved centroid with integer component (and belongs to the interior of C). We then apply Grünbaum's Inequality (1.1) and the lemmas to show that, for any halfspace H containing the point \bar{x} ,

$$\frac{\mathcal{H}_d(H \cap S)}{\mathcal{H}_d(S)} \geq (1 - \varepsilon_1(k)) \frac{\mathcal{H}_{d+1}(H \cap C)}{\mathcal{H}_{d+1}(C)} \geq \frac{1}{e} - \varepsilon_2(k).$$

For some functions $\varepsilon_1(k)$ and $\varepsilon_2(k)$ that tend to zero when k tends to infinity. We show that we can take $\varepsilon_2(k) = O(d/\sqrt{k})$, which allows us to quantify how large k has to be in order to verify $\frac{1}{e} - \varepsilon_2(k) \geq \frac{1}{2} \left(\frac{d}{d+1}\right)^d$, leveraging from the inequality $\frac{1}{e} > \frac{1}{4} \geq \frac{1}{2} \left(\frac{d}{d+1}\right)^d$.

3.1 Technical Lemmas for the case $n = 1$

In this section, we present the four technical lemmas described in the outline of the proof.

Lemma 3.1. *For every C_i , we have that*

$$\mathcal{H}_{d+1}(C_i) \leq \frac{d+1}{k} \cdot \mathcal{H}_{d+1}(C).$$

Proof. Take a value $z^* \in [i, i+1]$ and consider the vertical hyperplane $M = \{z^*\} \times \mathbb{R}^d$. Define $B_{z^*}^L$ as the stereographic projection of S_i from the origin $(0, 0)$ onto M . That is, $B_{z^*}^L$ is the unique subset of M verifying that

$$S_i = \frac{i}{z^*}(0, 0) + \frac{z^* - i}{z^*} B_{z^*}^L.$$

Similarly, define $B_{z^*}^R$ as the stereographic projection of S_{i+1} from the point $(k, 0)$ on M . That is, $B_{z^*}^R$ is the unique subset of M verifying that

$$S_{i+1} = \frac{k - (i+1)}{k - z^*}(k, 0) + \frac{(i+1) - z^*}{k - z^*} B_{z^*}^R.$$

Let $K_{z^*}^L$ be the cone with base $B_{z^*}^L$ and vertex in $(0, 0)$, and $K_{z^*}^R$ the cone with base $B_{z^*}^R$ and vertex in $(k, 0)$, see Figure 2. By convexity, we have that $C_i \subseteq (K_{z^*}^L \cup K_{z^*}^R) \cap \{(z, x) : z \in [i, i+1]\}$, and $(K_{z^*}^L \cup K_{z^*}^R) \setminus \{(z, x) : z \in [i, i+1]\} \subseteq C$.

Let $\alpha = \mathcal{H}_{d+1}((K_{z^*}^L \cup K_{z^*}^R) \cap \{(z, x) : z \in [i, i+1]\}) - \mathcal{H}_{d+1}(C_i)$. Then,

$$\mathcal{H}_{d+1}(K_{z^*}^L \cup K_{z^*}^R) = \mathcal{H}_{d+1}((K_{z^*}^L \cup K_{z^*}^R) \setminus \{(z, x) : z \in [i, i+1]\}) + \alpha,$$

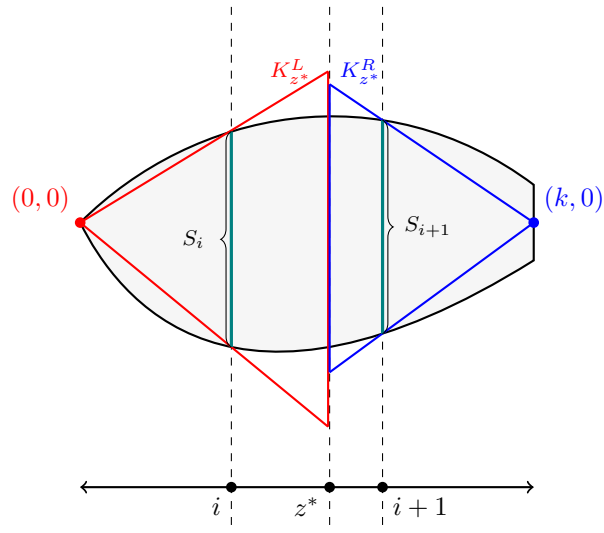

Figure 2: Illustration of $K_{z^*}^L$ and $K_{z^*}^R$. For simplification, the illustration assumes that the segment $[(0,0), (k,0)]$ belongs to the convex set C , but this is not required.

and so, since $\alpha \geq 0$ and $\mathcal{H}_{d+1}(C_i)/\mathcal{H}_{d+1}(C) \leq 1$ we can write

$$\begin{aligned}
\frac{\mathcal{H}_{d+1}(C_i)}{\mathcal{H}_{d+1}(C)} &\leq \frac{\mathcal{H}_{d+1}(C_i) + \alpha}{\mathcal{H}_{d+1}(C) + \alpha} \\
&\leq \frac{\mathcal{H}_{d+1}((K_{z^*}^L \cup K_{z^*}^R) \cap \{(z,x) : z \in [i, i+1]\})}{\mathcal{H}_{d+1}(K_{z^*}^L \cup K_{z^*}^R)} \\
&= \frac{\left(1 - \left(\frac{i}{z^*}\right)^{d+1}\right) \cdot \frac{z^*}{d+1} \cdot \mathcal{H}_d(B_{z^*}^L) + \left(1 - \left(\frac{k-(i+1)}{k-z^*}\right)^{d+1}\right) \cdot \frac{k-z^*}{d+1} \cdot \mathcal{H}_d(B_{z^*}^R)}{\frac{z^*}{d+1} \cdot \mathcal{H}_d(B_{z^*}^L) + \frac{k-z^*}{d+1} \cdot \mathcal{H}_d(B_{z^*}^R)}.
\end{aligned}$$

Note that the function $g(t) = t^{d+1}$ is convex and $g'(1) = d+1$. Therefore

$$\frac{g(1) - g(t)}{d+1} \leq \frac{g'(1)(1-t)}{d+1} = 1-t, \quad \forall t \in \mathbb{R}.$$

applying the above inequality to $t = \frac{i}{z^*}$ and $t = \frac{k-(i+1)}{k-z^*}$, we deduce that

$$\frac{\mathcal{H}_{d+1}(C_i)}{\mathcal{H}_{d+1}(C)} \leq \frac{\left(1 - \frac{i}{z^*}\right) \cdot z^* \cdot \mathcal{H}_d(B_{z^*}^L) + \left(1 - \frac{k-(i+1)}{k-z^*}\right) \cdot (k-z^*) \cdot \mathcal{H}_d(B_{z^*}^R)}{\frac{z^*}{d+1} \cdot \mathcal{H}_d(B_{z^*}^L) + \frac{k-z^*}{d+1} \cdot \mathcal{H}_d(B_{z^*}^R)}.$$

To conclude, notice that $\mathcal{H}_d(B_{z^*}^L)$ and $\mathcal{H}_d(B_{z^*}^R)$ vary continuously as functions of z^* , and when $z^* = i$, by convexity, $B_{z^*}^L \subseteq B_{z^*}^R$, while when $z^* = i+1$ we have that $B_{z^*}^L \supseteq B_{z^*}^R$. Therefore, for some $z^* \in [i, i+1]$, the two bases have the same volume so that we can factorize and cancel them in the previous inequality. We obtain that

$$\frac{\mathcal{H}_{d+1}(C_i)}{\mathcal{H}_{d+1}(C)} \leq \frac{\left(1 - \frac{i}{z^*}\right) \cdot z^* + \left(1 - \frac{k-(i+1)}{k-z^*}\right) \cdot (k-z^*)}{\frac{z^*}{d+1} + \frac{k-z^*}{d+1}} = \frac{d+1}{k}.$$

□

Lemma 3.2. *We have that for every $\ell \geq 1$,*

$$\left(\left(1 + \frac{1}{\ell} \right)^{d+1} - 1 \right) \cdot \frac{\ell}{d+1} \cdot \mathcal{H}_d(H \cap S) \geq \mathcal{H}_{d+1}(H \cap C) - \frac{2\ell \cdot (d+1)}{k} \cdot \mathcal{H}_{d+1}(C).$$

Proof. If $\mathcal{H}_d(H \cap S) = 0$, then $(H \cap C)$ is either empty or must be included in at most one box C_i . In both cases, by Lemma 3.1, $\mathcal{H}_{d+1}(H \cap C) \leq \frac{d+1}{k} \mathcal{H}_{d+1}(C)$ and the desired inequality holds trivially. Thus, let us assume that $\mathcal{H}_d(H \cap S) > 0$.

Consider a point $\bar{\mathbf{x}} = (\bar{z}, \bar{x})$ in $\text{int}(H \cap C)$. For a slice S_i , denote by ℓ_i the distance between $\bar{\mathbf{x}}$ and the hyperplane $M_i = \{i\} \times \mathbb{R}^d$, that is, $\ell_i = |\bar{z} - i|$. Assume S_i is to the right of $\bar{\mathbf{x}}$. We have that $C_i \cap H$ is contained in the section between M_i and M_{i+1} , and the cone with vertex $\bar{\mathbf{x}}$ and base B equal to the stereographic projection of $S_i \cap H$ onto M_{i+1} (that is, B is the unique set of M_{i+1} such that $\text{cone}(\bar{\mathbf{x}}, B) \cap M_i = S_i$). This is because the line between an arbitrary point in $C_i \cap H$ and $\bar{\mathbf{x}}$ must intersect $S_i \cap H$, see Figure 3.

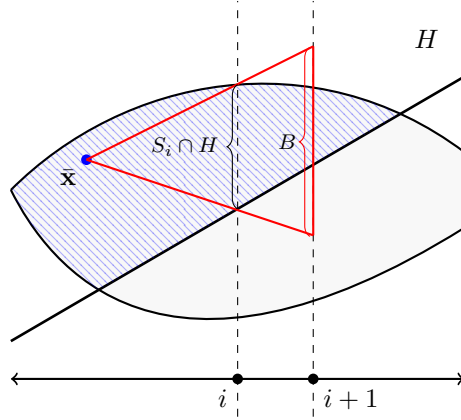

Figure 3: Illustration on how $C_i \cap H$ is contained in $C_i \cap \text{cone}(\bar{\mathbf{x}}, B)$.

Therefore,

$$\mathcal{H}_{d+1}(C_i \cap H) \leq \left(\left(\frac{\ell_i + 1}{\ell_i} \right)^{d+1} - 1 \right) \cdot \frac{\ell_i}{d+1} \cdot \mathcal{H}_d(S_i \cap H).$$

Using the analogous argument, for S_i to the left of $\bar{\mathbf{x}}$, we have that

$$\mathcal{H}_{d+1}(C_{i-1} \cap H) \leq \left(\left(\frac{\ell_i + 1}{\ell_i} \right)^{d+1} - 1 \right) \cdot \frac{\ell_i}{d+1} \cdot \mathcal{H}_d(S_i \cap H).$$

Then, we have that

$$\begin{aligned} \mathcal{H}_{d+1}(H \cap C) - \sum_{i: \ell_i \leq \ell} \mathcal{H}_{d+1}(H \cap C_i) &\leq \sum_{i: \ell_i > \ell} \left(\left(\frac{\ell_i + 1}{\ell_i} \right)^{d+1} - 1 \right) \cdot \frac{\ell_i}{d+1} \cdot \mathcal{H}_d(S_i \cap H) \\ &\leq \left(\left(\frac{\ell + 1}{\ell} \right)^{d+1} - 1 \right) \cdot \frac{\ell}{d+1} \cdot \mathcal{H}_d(S \cap H). \end{aligned}$$

Where the last inequality follows by noting that the map $\varphi : t \mapsto \left(\left(\frac{t+1}{t}\right)^{d+1} - 1\right) \cdot \frac{t}{d+1}$ is non-increasing on $(0, +\infty)$. Indeed, denoting by $g(t) := t^{d+1}$ and recalling that g is convex, we can write

$$\begin{aligned}\varphi'(t) &= \left(\left(\frac{t+1}{t}\right)^{d+1} - 1\right) \frac{1}{d+1} - \left(\frac{t+1}{t}\right)^d \frac{1}{t} \\ &= \left(g\left(\frac{t+1}{t}\right) - g(1)\right) \frac{1}{d+1} - \left(\frac{t+1}{t}\right)^d \frac{1}{t} \\ &\leq g'\left(\frac{t+1}{t}\right) \left(\frac{t+1}{t} - 1\right) \frac{1}{d+1} - \left(\frac{t+1}{t}\right)^d \frac{1}{t} \\ &= \left(\frac{t+1}{t}\right)^d \frac{1}{t} - \left(\frac{t+1}{t}\right)^d \frac{1}{t} = 0.\end{aligned}$$

Noting that $\sum_{i:l_i \leq \ell} \mathcal{H}_{d+1}(H \cap C_i) \leq \sum_{i:l_i \leq \ell} \mathcal{H}_{d+1}(C_i)$ and using Lemma 3.1 for each component of the sum, we obtain the desired bound. \square

Lemma 3.3. *We have that*

$$\left(1 - \left(1 - \frac{2}{k}\right)^{d+1}\right) \cdot \frac{k/2}{d+1} \cdot \mathcal{H}_d(S) \leq \left(1 + \frac{d+1}{k}\right) \cdot \mathcal{H}_{d+1}(C).$$

Proof. Note first that, for any given slice S_i , we have that the cone with base S_i and vertex at any point in C is contained in C . Choose any point $\mathbf{x}_0 := (0, x_0) \in S_0$ and any point $\mathbf{x}_k := (k, x_k)$, and, for every $i \in \{0, \dots, k\}$, let $L_i = \max\{i, k - i\}$. We have that $L_i \geq k/2$ for all i . Now, for every $i \in \{0, \dots, k\}$, consider the set

$$K_i = \begin{cases} \text{cone}(\mathbf{x}_0, S_i) \cap C_{i-1} & \text{if } i > k/2, \\ \text{cone}(\mathbf{x}_k, S_i) \cap C_i & \text{if } i \leq k/2. \end{cases}$$

Note that the sets $\{K_i : i = 0, \dots, k\}$ have pairwise disjoint interior, except for at most one pair. See Figure

Therefore,

$$\begin{aligned}\sum_{i=0}^k \left(1 - \left(1 - \frac{1}{L_i}\right)^{d+1}\right) \cdot \frac{L_i}{d+1} \cdot \mathcal{H}_d(S_i) &= \sum_{i=0}^k \mathcal{H}_{d+1}(K_i) \\ &\leq \mathcal{H}_{d+1}(C) + \max_{0 \leq i \leq k-1} \mathcal{H}_{d+1}(C_i) \\ &\leq \left(1 + \frac{d+1}{k}\right) \cdot \mathcal{H}_{d+1}(C),\end{aligned}$$

where in the last inequality we used Lemma 3.1. Note now that the function $\varphi : t \mapsto \left(1 - \left(1 - \frac{1}{t}\right)^{d+1}\right)$.

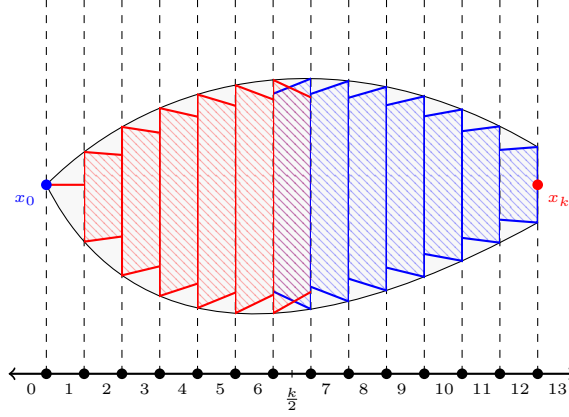

Figure 4: Illustration of Inner Approximation. When k is odd, the box $C_{\lfloor k/2 \rfloor}$ is approximated twice.

$\frac{t}{d+1}$ is nondecreasing on $(0, +\infty)$. Indeed, using again the convexity of $g(t) = t^{d+1}$, we have that

$$\begin{aligned}
\varphi'(t) &= \left(g(1) - g\left(1 - \frac{1}{t}\right) \right) \frac{1}{d+1} - \left(1 - \frac{1}{t}\right)^d \frac{1}{t} \\
&= \left(1 - \left(1 - \frac{1}{t}\right)^{d+1} \right) \frac{1}{d+1} - \left(1 - \frac{1}{t}\right)^d \frac{1}{t} \\
&\geq g' \left(1 - \frac{1}{t}\right) \left(1 - \left(1 - \frac{1}{t}\right) \right) \frac{1}{d+1} - \left(1 - \frac{1}{t}\right)^d \frac{1}{t} \\
&= \left(1 - \frac{1}{t}\right)^d \frac{1}{t} - \left(1 - \frac{1}{t}\right)^d \frac{1}{t} = 0.
\end{aligned}$$

Since $L_i \geq k/2$ for all $i = 1, \dots, k$, we conclude the proof of the lemma. \square

Lemma 3.4. *There is a convex body $C' \subseteq C$ with centroid in $\mathbb{Z} \times \mathbb{R}^d$ and such that*

$$\mathcal{H}_{d+1}(C \setminus C') \leq \frac{2 \cdot (d+2)}{k} \cdot \mathcal{H}_{d+1}(C).$$

Proof. Let $\bar{\mathbf{x}} = (\bar{z}, \bar{x})$ be the centroid of C . Let $\delta = \bar{z} - \lfloor \bar{z} \rfloor$. Replace C by $C - \{\bar{z}\}$ so the centroid is placed in $(0, \bar{x})$. Throughout this proof, we write $\mathcal{H}(\cdot)$ to refer to $\mathcal{H}_{d+1}(\cdot)$ to reduce a bit the overload of notation.

Split C into C_L and C_R by cutting it with the hyperplane $M = \{0\} \times \mathbb{R}^d$. Let z_L be first coordinate of the centroid of C_L and z_R be the first coordinate of the centroid of C_R . We have that

$$z_L \cdot \frac{\mathcal{H}(C_L)}{\mathcal{H}(C)} + z_R \cdot \frac{\mathcal{H}(C_R)}{\mathcal{H}(C)} = 0.$$

For an arbitrary $w > 0$, define the sets $C' = \{(z, x) \in C : z \leq w\}$ and $C'_R = \{(z, x) \in C_R : z \leq w\}$. Let z'_R be the first coordinate of the centroid of C'_R . Note that $C_L = C'_L$. Since it is clear that

$z'_R \leq z_R$, the first coordinate of the centroid of C' can be bounded as follows

$$\begin{aligned}
\bar{z}' &= z_L \cdot \frac{\mathcal{H}(C_L)}{\mathcal{H}(C')} + z'_R \cdot \frac{\mathcal{H}(C'_R)}{\mathcal{H}(C')} \leq z_L \cdot \frac{\mathcal{H}(C_L)}{\mathcal{H}(C')} + z_R \cdot \frac{\mathcal{H}(C'_R)}{\mathcal{H}(C')} \\
&= -z_R \cdot \frac{\mathcal{H}(C_R)}{\mathcal{H}(C')} + z_R \cdot \frac{\mathcal{H}(C'_R)}{\mathcal{H}(C')} \\
&= -z_R \cdot \frac{\mathcal{H}(C_R \setminus C'_R)}{\mathcal{H}(C')} \\
&= -z_R \cdot \frac{\mathcal{H}(C \setminus C')}{\mathcal{H}(C')} \leq -z_R \cdot \frac{\mathcal{H}(C \setminus C')}{\mathcal{H}(C')}.
\end{aligned}$$

That is, the centroid $\mathfrak{c}(C')$ is moved to the left with respect to the original centroid $\mathfrak{c}(C)$, see Figure 5.

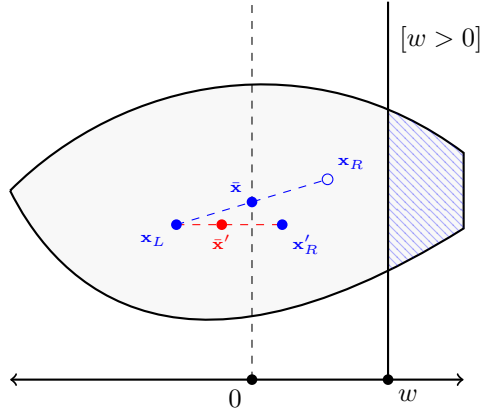

Figure 5: Illustration of the modification of the centroid after cutting a part of C . The old centroid of C_R given by \mathbf{x}_R is moved to the left, to the new point \mathbf{x}'_R . Accordingly, the new centroid of C' , given by \mathbf{x}' , is also moved to the left.

We know that C has length k along the x_1 axis, so without loss of generality, C_R has length at least $k/2$ along the x_1 axis. The smallest possible value of x_R given that C_R has length at least $k/2$ is attained when C_R is a cone, in which case the centroid is at a fraction $1/(d+2)$ of the height. Therefore, $z_R \geq \frac{k}{2(d+2)}$. Then, we have that

$$\mathcal{H}(C \setminus C') > \frac{2 \cdot (d+2)}{k} \cdot \mathcal{H}(C) \implies \bar{z}' < -1.$$

Since the centroid of C' varies continuously with w and for $w = k$ one has that $\bar{z}' = 0$, we can find the value of w for which $\mathcal{H}(C \setminus C') \leq \frac{2 \cdot (d+2)}{k} \cdot \mathcal{H}(C)$ and the first coordinate of the centroid is exactly $-\delta$. Replacing again C and C' by $C + \bar{z}$ and $C' + \bar{z}$ respectively, the centroid of C' is placed at $[\bar{z}]$ and the result follows. \square

3.2 Main result for the case $n = 1$

We can now present our main result for $n = 1$.

Theorem 3.5. *There exists a point $\bar{\mathbf{x}} = (\bar{z}, \bar{x}) \in S$ such that for every halfspace H containing $\bar{\mathbf{x}}$, one has that*

$$\mathcal{H}_d(S \cap H) \geq \left(\left(\frac{d+1}{d+2} \right)^{d+1} - \frac{9d+8}{\sqrt{k}} \right) \mathcal{H}_d(S) \geq \left(\frac{1}{e} - \frac{9d+8}{\sqrt{k}} \right) \mathcal{H}_d(S).$$

In particular, there exists a universal constant $\alpha > 0$ such that if $k \geq \alpha d^2$, then

$$\mathcal{F}(S) \geq \frac{1}{2} \left(\frac{d}{d+1} \right)^d.$$

Sketch of proof of Theorem 3.5. Let $C' \subseteq C$ to be the set guaranteed by Lemma 3.4, and let H be a halfspace that contains its centroid. We have that $\mathcal{H}_{d+1}(C \cap H) \geq \mathcal{H}_{d+1}(C' \cap H) \geq \frac{1}{e} \mathcal{H}_{d+1}(C') \geq \left(\frac{1}{e} - O(d/k) \right) \cdot \mathcal{H}_{d+1}(C)$. Using Lemma 3.2 with $\ell = \sqrt{k}$, we get that

$$\mathcal{H}_d(S \cap H) \geq \mathcal{H}_{d+1}(C \cap H) \cdot \left(1 - O\left(\frac{d}{\sqrt{k}} \right) \right) - O\left(\frac{d}{\sqrt{k}} \right) \cdot \mathcal{H}_{d+1}(C) \geq \left(\frac{1}{e} - O\left(\frac{d}{\sqrt{k}} \right) \right) \cdot \mathcal{H}_{d+1}(C).$$

From Lemma 3.3, we have that $\mathcal{H}_d(S) \leq (1 + O(d/k)) \mathcal{H}_{d+1}(C)$, and therefore, $\frac{\mathcal{H}_d(S \cap H)}{\mathcal{H}_d(S)} \geq \left(\frac{1}{e} - O(d/\sqrt{k}) \right)$. \square

Proof. Let $C' \subseteq C$ be the convex set given by Lemma 3.4, and let (\bar{z}, \bar{x}) the centroid of C' . Since $\bar{z} \in \mathbb{Z}$, we have that $(\bar{z}, \bar{x}) \in S$. Let H be a halfspace that contains (\bar{z}, \bar{x}) . By Lemma 3.2 and Lemma 3.3, we have that for every $\ell \geq 1$,

$$\begin{aligned} & \frac{\mathcal{H}_d(S \cap H)}{\mathcal{H}_d(S)} \\ & \geq \frac{\frac{k/2}{d+1} \cdot \left(1 - \left(1 - \frac{2}{k} \right)^{d+1} \right)}{1 + \frac{d+1}{k}} \cdot \frac{1}{\frac{\ell}{d+1} \cdot \left(\left(1 + \frac{1}{\ell} \right)^{d+1} - 1 \right)} \cdot \frac{\mathcal{H}_{d+1}(H \cap C) - \frac{2\ell \cdot (d+1)}{k} \cdot \mathcal{H}_{d+1}(C)}{\mathcal{H}_{d+1}(C)} \\ & \geq \left(1 - \frac{3d+1}{k} \right) \cdot \frac{1}{\frac{\ell}{d+1} \cdot \left(\left(1 + \frac{1}{\ell} \right)^{d+1} - 1 \right)} \cdot \left(\frac{\mathcal{H}_{d+1}(H \cap C)}{\mathcal{H}_{d+1}(C)} - \frac{2\ell \cdot (d+1)}{k} \right). \end{aligned}$$

We also have that

$$\begin{aligned} \mathcal{H}_{d+1}(H \cap C) & \geq \mathcal{H}_{d+1}(H \cap C') \geq \left(\frac{d+1}{d+2} \right)^{d+1} \cdot \mathcal{H}_{d+1}(C') \\ & \geq \left(\frac{d+1}{d+2} \right)^{d+1} \cdot \left(1 - \frac{2 \cdot (d+2)}{k} \right) \cdot \mathcal{H}_{d+1}(C). \end{aligned}$$

By mixing both inequalities, we deduce that

$$\begin{aligned} & \frac{\mathcal{H}_d(S \cap H)}{\mathcal{H}_d(S)} \\ & \geq \left(1 - \frac{3d+1}{k} \right) \cdot \frac{1}{\frac{\ell}{d+1} \cdot \left(\left(1 + \frac{1}{\ell} \right)^{d+1} - 1 \right)} \cdot \left(\left(\frac{d+1}{d+2} \right)^{d+1} \cdot \left(1 - \frac{2 \cdot (d+2)}{k} \right) - \frac{2\ell \cdot (d+1)}{k} \right). \end{aligned}$$

Note that, by exploiting the convexity of the mapping $t \mapsto x^{d+1}$, we have that

$$1 - \left(1 + \frac{1}{\ell}\right)^{d+1} \leq (d+1) \left(1 + \frac{1}{\ell}\right)^d \frac{1}{\ell},$$

which yields that, assuming that $\ell \geq d$,

$$\frac{\ell}{d+1} \cdot \left(\left(1 + \frac{1}{\ell}\right)^{d+1} - 1 \right) \leq \left(1 + \frac{1}{\ell}\right)^d = \left(1 + \frac{d/\ell}{d}\right)^d \leq e^{d/\ell}.$$

by convexity of the exponential mapping, one can also deduce that $e^{d/\ell} \leq 1 + \frac{d}{\ell}e^{d/\ell}$ and therefore,

$$\frac{\ell}{d+1} \cdot \left(\left(1 + \frac{1}{\ell}\right)^{d+1} - 1 \right) \leq 1 + e \frac{d}{\ell}.$$

Recall that, for every $a, b > 0$ one always has that

$$(1-a)(1-b) \geq 1-a-b \quad \text{and} \quad \frac{1}{1+a} \geq 1-a.$$

Then,

$$\begin{aligned} \left(1 - \frac{3d+1}{k}\right) \cdot \frac{1}{\frac{\ell}{d+1} \cdot \left(\left(1 + \frac{1}{\ell}\right)^{d+1} - 1 \right)} &\geq \left(1 - \frac{3d+1}{k}\right) \cdot \frac{1}{1 + e \frac{d}{\ell}} \\ &\geq \left(1 - \frac{3d+1}{k}\right) \left(1 - e \frac{d}{\ell}\right) \\ &\geq 1 - \frac{3d+1}{k} - \frac{3d}{\ell}. \end{aligned}$$

Assuming now that $\ell \leq k$, we can write

$$\begin{aligned} \frac{\mathcal{H}_d(S \cap H)}{\mathcal{H}_d(S)} &\geq \left(1 - \frac{3d+1}{k} - \frac{3d}{\ell}\right) \left(\left(\frac{d+1}{d+2}\right)^{d+1} \cdot \left(1 - \frac{2 \cdot (d+2)}{k}\right) - \frac{2\ell \cdot (d+1)}{k} \right) \\ &\geq \left(1 - \frac{3d+1}{k} - \frac{3d}{\ell}\right) \left(\left(\frac{d+1}{d+2}\right)^{d+1} - \frac{2 \cdot (d+2)}{k} - \frac{2\ell \cdot (d+1)}{k} \right) \\ &\geq \left(1 - \frac{2(3d+1)}{\min\{k, \ell\}}\right) \left(\left(\frac{d+1}{d+2}\right)^{d+1} - \frac{3\ell(d+2)}{k} \right) \\ &\geq \left(\frac{d+1}{d+2}\right)^{d+1} - \frac{2(3d+1)}{\min\{k, \ell\}} - \frac{3\ell(d+2)}{k}. \end{aligned}$$

By choosing $\ell = \sqrt{k}$, we get that

$$\frac{\mathcal{H}_d(S \cap H)}{\mathcal{H}_d(S)} \geq \left(\frac{d+1}{d+2}\right)^{d+1} - \frac{2(3d+1)}{\sqrt{k}} - \frac{3d+6}{\sqrt{k}} = \left(\frac{d+1}{d+2}\right)^{d+1} - \frac{9d+8}{\sqrt{k}}.$$

The proof of the first part is then completed. Now, for the second part, we need to find the threshold for k such that

$$\begin{aligned} \left(\frac{d+1}{d+2}\right)^{d+1} - \frac{9d+8}{\sqrt{k}} \geq \frac{1}{2} \left(\frac{d}{d+1}\right)^d &\iff \left(\frac{d+1}{d+2}\right)^{d+1} - \frac{1}{2} \left(\frac{d}{d+1}\right)^d \geq \frac{9d+8}{\sqrt{k}} \\ &\iff \sqrt{k} \geq \frac{9d+8}{\left(\frac{d+1}{d+2}\right)^{d+1} - \frac{1}{2} \left(\frac{d}{d+1}\right)^d} \end{aligned}$$

Since the mapping $x \mapsto \frac{x}{x+1}$ is increasing, we can write

$$\left(\frac{d+1}{d+2}\right)^{d+1} - \frac{1}{2} \left(\frac{d}{d+1}\right)^d \leq \left(\frac{d}{d+1}\right)^d \left(\frac{d+1}{d+2} - \frac{1}{2}\right) \leq \left(\frac{d}{d+1}\right)^d \left(\frac{2}{3} - \frac{1}{2}\right) \leq \frac{1}{6e}.$$

Therefore,

$$k \geq (6e(9d+8))^2 \implies \left(\frac{d+1}{d+2}\right)^{d+1} - \frac{9d+8}{\sqrt{k}} \geq \frac{1}{2} \left(\frac{d}{d+1}\right)^d.$$

The universal constant can be taken as $\alpha = (102e)^2$. The proof is then completed. \square

4 The general case

Throughout this section, we consider the general case $n \geq 1$, that is, $C \subseteq \mathbb{R}^{n+d}$ and $S = C \cap (\mathbb{Z}^n \times \mathbb{R}^d)$. We first need to define what “large set” means in this context. For $n = 1$, we said the set C was large if the length of the segment $\text{proj}_{\mathbb{R}}(C)$ was large. Analogously, we will consider C to be large in \mathbb{R}^{n+d} if its projection $\text{proj}_{\mathbb{R}^n}(C)$ contains a ball of large radius. Assuming without loss of generality that $0 \in C$, and denoting by \mathbb{B}_n the Euclidean unit ball in \mathbb{R}^n , let k be such that

$$k\mathbb{B}_n \subset \text{proj}_{\mathbb{R}^n}(C).$$

Our goal is to prove that there exists a universal constant $\alpha > 0$ such that

$$k \geq \alpha d^2 n^{3/2} \implies \mathcal{F}(S) \geq \frac{1}{2^n} \left(\frac{d}{d+1}\right)^d. \quad (4.1)$$

Having already proved our bound for the case $n = 1$, a naive strategy would be to inductively apply the same ideas over the dimensions of \mathbb{R}^n . However, with such an approach, the resulting bound would grow exponentially on n , which we want to avoid. Thus, we depart from the idea of conic approximations but maintain the following key observation: “away from the boundary” of C , any point $z \in \text{proj}_{\mathbb{R}^n}(C)$ verifies that

$$\mathcal{H}_d(C \cap (\{z\} \times \mathbb{R}^d)) \approx \mathcal{H}_{n+d}(C \cap (\{w : \|z - w\|_\infty \leq 1/2\} \times \mathbb{R}^d)) \quad (4.2)$$

In what follows, we will consider the following definitions, illustrated in Figure 6:

- For $z \in \mathbb{R}^n$, we denote the **slice** of C induced by z as $S_z(C) = C \cap (\{z\} \times \mathbb{R}^d)$ (solid blue line inside the set, see Figure 6).

- For $z \in \mathbb{R}^n$, we denote the n -dimensional **box** of z as $\text{Box}_z^n = \{w \in \mathbb{R}^n : \|w - z\|_\infty \leq 1/2\}$ (solid red square over the grid, see Figure 6).
- We denote the **rectangular cut** of C induced by z as $B_z(C) = C \cap (\text{Box}_z^n \times \mathbb{R}^d)$ (volumetric section of the convex body in blue, see Figure 6).

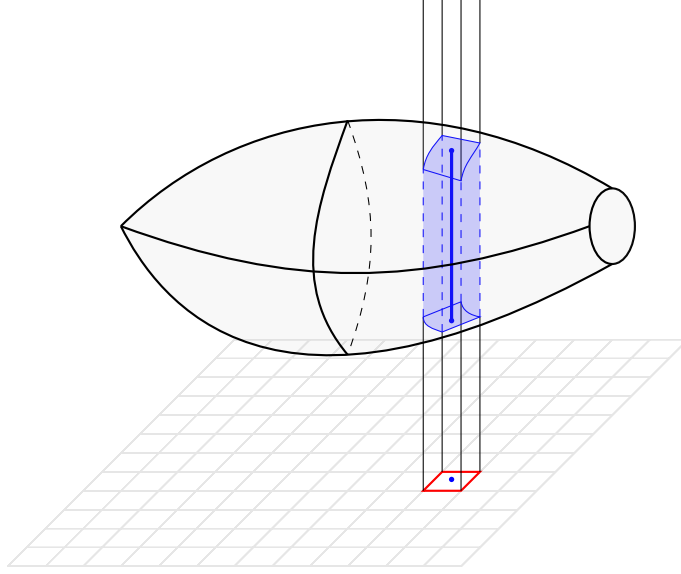

Figure 6: Illustration of slices, boxes and rectangular cut with $n = 2$ and $d = 1$.

With this notation, Equation (4.2) can be written as $\mathcal{H}_d(S_z(C)) \approx \mathcal{H}_{n+d}(B_z(C))$. Our strategy can be split in the following steps:

1. **Approximate volume with slices.** The volume of a convex body that contains a large ball in the projection is well approximated by the measure of its slices. More precisely, if $\text{proj}_{\mathbb{R}^n}(C)$ contains a ball of radius $\Omega(k)$, then $\mathcal{H}_{n+d}(C) = \mathcal{H}_d(C \cap (\mathbb{Z}^n \times \mathbb{R}^d)) \cdot (1 \pm O(dn^{3/4}/k^{1/2}))$ (see Lemma 4.3). We prove this in two steps.
 - (a) Take the set $C_{-\varepsilon} = (1 - \varepsilon) \cdot C$. We have that $\mathcal{H}_{n+d}(C_{-\varepsilon}) = (1 - \varepsilon)^{n+d} \mathcal{H}_{n+d}(C)$, and for every point $z \in \text{proj}_{\mathbb{R}^n}(C_{-\varepsilon})$ the ball of radius εr centered at z is contained in $\text{proj}_{\mathbb{R}^n}(C)$ (a simple consequence of Lemma 4.1).
 - (b) If a point in the projection has a large ball around, then the volume of the corresponding d -dimensional slice approximates well the volume of the $(n + d)$ -dimensional rectangular cut. More precisely, for a point $z \in \text{proj}_{\mathbb{R}^n}(C)$, if a ball of radius r centered at z is contained in $\text{proj}_{\mathbb{R}^n}(C)$, then $\mathcal{H}_{n+d}(B_z(D)) = \mathcal{H}_d(S_z(D)) \cdot (1 \pm O(d\sqrt{n}/r))$. See Lemma 4.2.
2. **Move the centroid.** we can assume the centroid of C is in $\mathbb{Z}^n \cap \mathbb{R}^d$ by losing a small fraction of the volume. More precisely, we can shift C and obtain a new set C' with centroid in $\mathbb{Z}^n \cap \mathbb{R}^d$, so that $\mathcal{H}_{n+d}(C \triangle C') \leq \mathcal{H}_{n+d}(C) \cdot O(\sqrt{n}(n + d)/k)$. See Lemma 4.4.

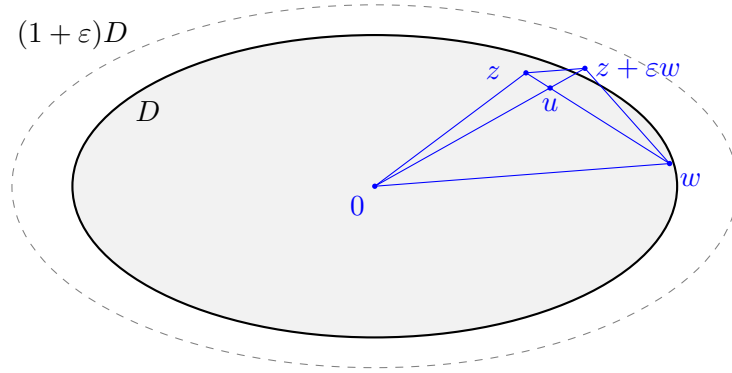

Figure 7: A graphic representation of Lemma 4.1

3. **Cut and use the continuous bound.** If we cut C' with an arbitrary hyperplane passing through its centroid and denote the two sides by A' and B' , then both $\mathcal{H}_{n+d}(A')$ and $\mathcal{H}_{n+d}(B')$ are at least $\mathcal{H}_{n+d}(C')/e$.
4. **Approximate volumes of sides by the slices.** Either $\text{proj}_{\mathbb{R}^n}(A')$ or $\text{proj}_{\mathbb{R}^n}(B')$ must contain a ball of radius $k/2$. In general, if the union of two convex sets contains a ball of radius k , one of them contains a ball of radius $k/2$ [16]. Assume without loss of generality that A' contains the ball. The volumes of C' and A' are well approximated by the slices, so the volume of B' is also well approximated by the slices.

4.1 Technical Lemmas for the general case

Lemma 4.1. *Let $D \subseteq \mathbb{R}^n$ be a convex set that contains the origin. For all $z, w \in D$, and $\varepsilon > 0$, we have that $z + \varepsilon w \in (1 + \varepsilon) \cdot D$.*

Proof. The proof is based on basic Euclidean geometry. If z and w are parallel, the result is immediate. Otherwise, the vectors $0, z, w$, and $z + \varepsilon w$ belong to the two-dimensional plane generated by z and w , so the segments $[0, z + \varepsilon w]$ and $[z, w]$ intersect at a point u . By convexity, we have that $u \in D$. Since $[0, w]$ and $[z, z + \varepsilon w]$ are parallel, by the intercept theorem (sometimes also referred to as Thales' theorem), we have that the ratio between the lengths of these two segments and the ratio between the segments $[0, u]$ and $[u, z + \varepsilon w]$ is the same. Therefore, we conclude that $z + \varepsilon w = (1 + \varepsilon) \cdot u \in (1 + \varepsilon) \cdot D$. See Figure 7. □

Lemma 4.2. *For a convex body $C \subseteq \mathbb{R}^{n+d}$ and a point $z \in \text{proj}_{\mathbb{R}^n}(C)$ such that $\text{proj}_{\mathbb{R}^n}(C)$ contains a ball of radius $r > \sqrt{n}/2$ around z . We have that*

$$\mathcal{H}_d(S_z(C)) \cdot \left(1 - \frac{\sqrt{n}}{2r}\right)^d \leq \mathcal{H}_{n+d}(B_z(C)) \leq \mathcal{H}_d(S_z(C)) \cdot \left(1 + \frac{\sqrt{n}}{2r}\right)^d.$$

Sketch of proof of Lemma 4.2. The volume of $B_z(C)$ can be written as the integral of the (d -dimensional) volume of the slices defined by points $w \in \text{Box}_z^n$. Thus, we compare the volume of

each of these slices $S_w(C)$ with the volume of the slice $S_z(C)$. Any point w in the n -dimensional hypercube is at a distance at most $\sqrt{n}/2$ of z . Because we assumed there is a ball of radius r around z , there is a point $y \in C$ in the same direction as w from z , but at distance r . The stereographic projection of $S_z(C)$ from y on $\{w\} \times \mathbb{R}^d$ is contained in $S_w(C)$. The projection is a rescaled copy of $S_z(C)$, by a factor no smaller than $(1 - (\sqrt{n}/2)/r)$, so $\mathcal{H}_d(S_z(C)) \cdot (1 - (\sqrt{n}/2)/r)^d \leq \mathcal{H}_d(S_w(C))$. Similarly, we can project $S_w(C)$ on $\{z\} \times \mathbb{R}^d$ from the other side, and obtain that $\mathcal{H}_d(S_w(C)) \leq \mathcal{H}_d(S_z(C)) \cdot (1 + (\sqrt{n}/2)/r)^d$. See Figure 8. \square

Proof of Lemma 4.2. Since $B(z, r) \subset \text{proj}_{\mathbb{R}^n}(C)$, we have that the box $\text{Box}_z^n = \{w \in \mathbb{R}^n : \|w - z\|_\infty \leq 1/2\} \subset \text{proj}_{\mathbb{R}^n}(C)$. Then, we have the following formula:

$$\mathcal{H}_{n+d}(B_z(C)) = \int_{w \in \text{Box}_z^n} \mathcal{H}_d(S_w(C)) dw,$$

where dw is the Lebesgue measure in \mathbb{R}^n . Because of this formula, and since $\mathcal{H}_n(\text{Box}_z^n) = 1$, it is enough to bound $\mathcal{H}_d(S_w(C))$ in terms of $\mathcal{H}_d(S_z(C))$.

Take a given $w \in \text{Box}_z^n$. We have that w is at a distance at most $\sqrt{n}/2$ of z . Consider a point $\mathbf{y} \in C$ such that $\text{proj}_{\mathbb{R}^n}(\mathbf{y}) - z$ is in the ray $\mathbb{R}_+(w - z)$, and $\|\text{proj}_{\mathbb{R}^n}(\mathbf{y}) - z\|_2 = r$ (\mathbf{y} is guaranteed to exist due to the inclusion $B(z, r) \subset \text{proj}_{\mathbb{R}^n}(C)$). By convexity, the cone $K_z = \text{cone}(\mathbf{y}, S_z(C))$ is contained in C . Therefore, since $\|w - z\|_2 \leq r$, the intersection of K_z and the affine subspace defined by w is contained in $S_w(C)$ (see Figure 8).

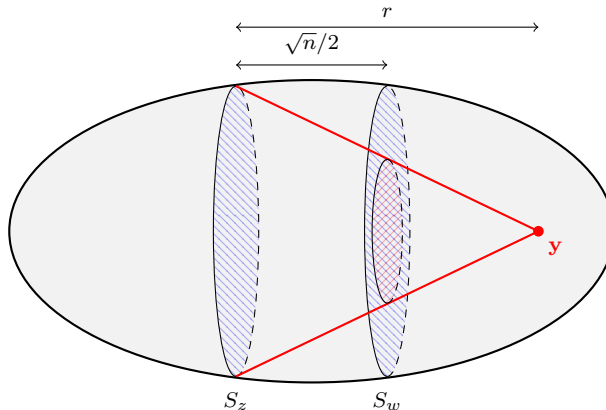

Figure 8: A graphic representation of the procedure used in Lemma 4.2 to compare the volume of two slices.

The cone K_z has height r , and S_w is at distance at most $\sqrt{n}/2$ of the base $S_z(C)$. So, its intersection with the affine subspace defined by w is a rescaled translate of $S_z(C)$, with a rescaling factor no smaller than $(r - \sqrt{n}/2)/r$. Therefore,

$$\mathcal{H}_d(S_z(C)) \cdot \left(\frac{r - \sqrt{n}/2}{r} \right)^d \leq \mathcal{H}_d(S_w(C)).$$

Similarly, there must exist a point $\mathbf{y}' \in C$ such that $\text{proj}_{\mathbb{R}^n}(\mathbf{y}') - z$ points in the exact opposite direction, and $\|\text{proj}_{\mathbb{R}^n}(\mathbf{y}') - z\|_2 = r$. The cone $K' = \text{cone}(\mathbf{y}', S_w(C))$ is contained in C by

convexity, so its intersection with the affine subspace $\{z\} \times \mathbb{R}^d$ is contained in S_z . Therefore, reasoning as above,

$$\mathcal{H}_d(S_w(C)) \cdot \left(\frac{r}{r + \sqrt{n}/2} \right)^d \leq \mathcal{H}_d(S_z(C)).$$

Putting these bounds back in the integral formula, we conclude the proof of the lemma. \square

Lemma 4.3. *Let $C \subseteq \mathbb{R}^{n+d}$ be a convex body such that $\text{proj}_{\mathbb{R}^n}(C)$ contains the (n -dimensional) ball with radius k centered at 0, and let $S = C \cap (\mathbb{Z}^n \times \mathbb{R}^d)$. If $5 \frac{dn^{3/4}}{k^{1/2}} \leq 1$, we have that*

$$\mathcal{H}_{n+d}(C) \cdot \left(1 - 5 \frac{dn^{3/4}}{k^{1/2}} \right) \leq \mathcal{H}_d(S) \leq \mathcal{H}_{n+d}(C) \cdot \left(1 + 5 \frac{dn^{3/4}}{k^{1/2}} \right).$$

Sketch of proof of Lemma 4.3. For an appropriate $\varepsilon > 0$, we define $C_{-\varepsilon} = C \cdot (1 - \varepsilon)$ and $C_{+\varepsilon} = C \cdot (1 + \varepsilon)$. By Lemma 4.1, for every $z \in \text{proj}_{\mathbb{R}^n}(C_{-\varepsilon})$, the ball of radius $k\varepsilon$ centered at z is contained in $\text{proj}_{\mathbb{R}^n}(C)$. Similarly, for every $z \in \text{proj}_{\mathbb{R}^n}(C)$, the ball of radius $k\varepsilon$ centered at z is contained in $\text{proj}_{\mathbb{R}^n}(C_{+\varepsilon})$. For the lower bound, we apply Lemma 4.2 on the slices of $C_{-\varepsilon}$, taking $r = k\varepsilon$ to approximate the slices of C . From this approximation, we lose a factor of $(1 - O(\frac{d\sqrt{n}}{k\varepsilon}))$. On top of that, $\mathcal{H}_{n+d}(C_{-\varepsilon}) = (1 - \varepsilon)^{n+d} \cdot \mathcal{H}_{n+d}(C)$, so in total, we lose a factor $(1 - O(\frac{d\sqrt{n}}{k\varepsilon} + \varepsilon(n+d)))$. Analogously, using C and $C_{+\varepsilon}$ this time, we get an upper bound where we lose a factor $(1 + O(\frac{d\sqrt{n}}{k\varepsilon} + \varepsilon(n+d)))$. Taking $\varepsilon = 1/(n^{1/4}k^{1/2})$, we get the bounds of the lemma. \square

Proof of Lemma 4.3. Let $\varepsilon = 1/(n^{1/4}k^{1/2})$ and define $C_{-\varepsilon} = C \cdot (1 - \varepsilon)$. By Lemma 4.1, for every $z \in \text{proj}_{\mathbb{R}^n}(C_{-\varepsilon})$, the ball of radius $k\varepsilon$ centered at z is contained in $\text{proj}_{\mathbb{R}^n}(C)$. Denote by $\text{Int}(\cdot) = \mathbb{Z}^n \cap \text{proj}_{\mathbb{R}^n}(\cdot)$. By Lemma 4.2, for every $z \in \text{Int}_n(C_{-\varepsilon})$, we can approximate $\mathcal{H}_d(S_z(C))$ with $\mathcal{H}_{n+d}(B_z(C))$. Therefore, we have that

$$\begin{aligned} \mathcal{H}_d(S) &= \sum_{z \in \text{Int}(C)} \mathcal{H}_d(S_z(C)) \\ &\geq \sum_{z \in \text{Int}(C_{-\varepsilon})} \mathcal{H}_d(S_z(C)) \\ &\geq \left(1 - \frac{\sqrt{n}}{2k\varepsilon} \right)^d \sum_{z \in \text{Int}(C_{-\varepsilon})} \mathcal{H}_{n+d}(B_z(C)) \\ &= \left(1 - \frac{\sqrt{n}}{2k\varepsilon} \right)^d \cdot \mathcal{H}_{n+d} \left(\bigcup_{z \in \text{Int}(C_{-\varepsilon})} B_z(C) \right). \end{aligned}$$

We would like to conclude the lower bound here by replacing with $\mathcal{H}_{n+d}(C_{-\varepsilon})$. However, there might be points in $C_{-\varepsilon}$ that are not covered by any box B_z . Let \mathbf{y} be such a point. In that case, $\text{proj}_{\mathbb{R}^n}(\mathbf{y})$ at a distance at most $w \in \sqrt{n}/2$ of a point in $\mathbb{Z}^n \setminus C_{-\varepsilon}$, which must be at a distance at least $(1 - \varepsilon)k$ of the origin. Thus, the point $\text{proj}_{\mathbb{R}^n}(\mathbf{y})$ is at distance at least $(1 - \varepsilon)k - \sqrt{n}/2$ of the origin. Since by hypothesis $\varepsilon k = k^{1/2}n^{-1/4} \geq \sqrt{n}/(5d) \geq \sqrt{n}/2$, the latter reasoning yields

that $\text{proj}_{\mathbb{R}^n}(\mathbf{y}) \notin C_{-2\varepsilon} = (1 - 2\varepsilon)C$. We deduce that $(1 - 2\varepsilon)C \subset \bigcup_{z \in \text{Int}(C_{-\varepsilon})} B_z(C)$. Recalling that for any $a, b \geq 0$ one has that $(1 - a)(1 - b) \geq 1 - a - b$ and $(1 - a)^b \geq 1 - ab$, we can write

$$\begin{aligned}
\mathcal{H}_d(S) &\geq \left(1 - \frac{\sqrt{n}}{2k\varepsilon}\right)^d \cdot \mathcal{H}_{n+d}(C_{-2\varepsilon}) \\
&= \left(1 - \frac{\sqrt{n}}{2k\varepsilon}\right)^d \cdot (1 - 2\varepsilon)^{n+d} \cdot \mathcal{H}_{n+d}(C) \\
&\geq \left(1 - \frac{\sqrt{n}}{2k\varepsilon} - 2(n + d)\varepsilon\right) \cdot \mathcal{H}_{n+d}(C) \\
&= \left(1 - \frac{dn^{3/4}}{2k^{1/2}} - 2\frac{(n + d)}{n^{1/4}k^{1/2}}\right) \cdot \mathcal{H}_{n+d}(C) \\
&\geq \left(1 - \frac{dn^{3/4}}{2k^{1/2}} - 2\frac{dn}{n^{1/4}k^{1/2}}\right) \cdot \mathcal{H}_{n+d}(C) \geq \left(1 - 3\frac{dn^{3/4}}{k^{1/2}}\right) \cdot \mathcal{H}_{n+d}(C),
\end{aligned}$$

For the upper bound we define $C_{+\varepsilon} = (1 + \varepsilon) \cdot C$. We have that

$$\begin{aligned}
\mathcal{H}_d(S) &= \sum_{z \in \text{Int}(D)} \mathcal{H}_d(S_z(C)) \\
&\leq \sum_{z \in \text{Int}(D)} \mathcal{H}_d(S_z(C_{+\varepsilon})).
\end{aligned}$$

The inequality holds because if the origin is contained in C , then $C \subseteq C_{+\varepsilon}$, and therefore, for all $z \in \mathbb{Z}^n$, $S_z(C) \subseteq S_z(C_{+\varepsilon})$. Now, for every $z \in \text{Int}(C)$, the ball of radius $k\varepsilon$ and center in z is contained in $C_{+\varepsilon}$, so we can apply Lemma 4.2. Consider the following facts:

1. $(n + d)\varepsilon \leq nd\varepsilon = \frac{dn^{3/4}}{k^{1/2}} \leq \frac{1}{5} \leq \frac{1}{2}$.
2. $\frac{d\sqrt{n}}{2k\varepsilon} = \frac{dn^{3/4}}{2k^{1/2}} \leq \frac{1}{10} \leq \frac{1}{2}$.
3. For any $a, b > 0$ one has that if $a \leq 1/2$, then $\frac{1}{1-a} \leq (1 + 2a)$.
4. For any $a, b > 0$ one has that if $ab \leq 1$, then $(1 + a)^b \leq 1 + 2ab$. This is because $(1 + a)^b \leq e^{ab}$, and by the convexity of e^x , we have that $e^x \leq 1 + (e - 1)x$ for all $x \in [0, 1]$.

Then, we can write,

$$\begin{aligned}
\mathcal{H}_d(S) &\leq \frac{1}{\left(1 - \frac{\sqrt{n}}{2k\varepsilon}\right)^d} \sum_{z \in \text{Int}(C)} \mathcal{H}_{n+d}(B_z(C_{+\varepsilon})) \\
&= \frac{1}{\left(1 - \frac{\sqrt{n}}{2k\varepsilon}\right)^d} \cdot \mathcal{H}_{n+d} \left(\bigcup_{z \in \text{Int}(C)} B_z(C_{+\varepsilon}) \right) \\
&\leq \frac{1}{\left(1 - \frac{\sqrt{n}}{2k\varepsilon}\right)^d} \cdot \mathcal{H}_{n+d}(C_{+\varepsilon}) \\
&= \frac{(1 + \varepsilon)^{n+d}}{\left(1 - \frac{\sqrt{n}}{2k\varepsilon}\right)^d} \cdot \mathcal{H}_{n+d}(C) \\
&\leq \left(\frac{1}{\left(1 - \frac{d\sqrt{n}}{2k\varepsilon}\right)} + \frac{2(n+d)\varepsilon}{\left(1 - \frac{d\sqrt{n}}{2k\varepsilon}\right)} \right) \mathcal{H}_{n+d}(C) \\
&\leq \left(1 + 2\frac{d\sqrt{n}}{2k\varepsilon} + 4(n+d)\varepsilon \right) \mathcal{H}_{n+d}(C) \leq \left(1 + 5\frac{dn^{3/4}}{k^{1/2}} \right) \cdot \mathcal{H}_{n+d}(C).
\end{aligned}$$

The result follows. \square

Lemma 4.4. *Let $C \subseteq \mathbb{R}^{n+d}$ be a convex body such that $\text{proj}_{\mathbb{R}^n}(C)$ contains a ball of radius $k > n$. There exists a vector \mathbf{x} such that the centroid of $C + \mathbf{x}$ is in $\mathbb{Z}^n \times \mathbb{R}^d$ and such that*

$$\mathcal{H}_{n+d} \left((C + \mathbf{x}) \setminus C \right) \leq \left(\left(1 + \frac{\sqrt{n}}{2k} \right)^{n+d} - 1 \right) \cdot \mathcal{H}_{n+d}(C).$$

Proof. Without losing any generality, assume that the ball of radius k in $\text{proj}_{\mathbb{R}^n}(C)$ is centered in the origin. Let (z, x) be the centroid of C . There must be a point $z' \in \mathbb{Z}^n$ at distance at most $\sqrt{n}/2$ of z . Thus, $z'' = \frac{2k}{\sqrt{n}}(z' - z)$ is at a distance at most k of the origin, and therefore, it is in $\text{proj}_{\mathbb{R}^n}(C)$. That means there is $x'' \in \mathbb{R}^d$ such that $\mathbf{x}'' = (z'', x'') \in C$. We shift C by $\frac{\sqrt{n}}{2k}\mathbf{x}''$, so the projection of the centroid of the shifted set is z' .

Since 0 and \mathbf{x}'' are in C , Lemma 4.1 implies that $C + \frac{\sqrt{n}}{2k}\mathbf{x}'' \subseteq (1 + \frac{\sqrt{n}}{2k}) \cdot C$, and therefore, $(C + \frac{\sqrt{n}}{2k}\mathbf{x}'') \setminus C \subseteq \left((1 + \frac{\sqrt{n}}{2k}) \cdot C \right) \setminus C$. The result follows. \square

4.2 Main result for the general case

We now present our main result.

Theorem 4.5. *Let $C \subseteq \mathbb{R}^{n+d}$ be a convex body such that $\text{proj}_{\mathbb{R}^n}(C)$ contains a ball of radius k . There is a point $\mathbf{x} \in S = C \cap (\mathbb{Z}^n \times \mathbb{R}^d)$ such that for every halfspace H that contains \mathbf{x} ,*

$$\mathcal{H}_d(S \cap H) \geq \left(\frac{1}{e} - 11\frac{dn^{3/4}}{k^{1/2}} \right) \cdot \mathcal{H}_d(S).$$

In particular, there exists a universal constant $\alpha > 0$ such that if $k \geq \alpha d^2 n^{3/2}$, then

$$\mathcal{F}(S) \geq \frac{1}{2^n} \left(\frac{d}{d+1} \right)^d.$$

Proof. Let $C' = C + \mathbf{x}$, where \mathbf{x} is the vector guaranteed to exist by Lemma 4.4 so that the centroid of C' is in $S' = C' \cap (\mathbb{Z}^n \times \mathbb{R}^d)$. Let H be an arbitrary affine halfspace defined by affine hyperplane that passes through the centroid of C' . Let $A' = C' \cap H$, $A = C \cap H$, $B' = C' \setminus H$, and $B = C \setminus H$. Without losing any generality, we assume that all these sets are full dimensional. We have that $\mathcal{H}_{n+d}(A') \geq (1/e) \cdot \mathcal{H}_{n+d}(C')$ and $\mathcal{H}_{n+d}(B') \geq (1/e) \cdot \mathcal{H}_{n+d}(C')$. Either $\text{proj}_{\mathbb{R}^n}(A)$ or $\text{proj}_{\mathbb{R}^n}(B)$ contains a ball of radius $k/2$. Since we will prove the same lower bound for both sides, let us assume that $\text{proj}_{\mathbb{R}^n}(A)$ contains a ball of radius $k/2$. By Lemma 4.3 and the fact that $(1-a)(1-b) \geq 1-a-b$ for every $a, b \geq 0$, we have that

$$\begin{aligned} \mathcal{H}_d(A \cap (\mathbb{Z}^n \times \mathbb{R}^d)) &\geq \mathcal{H}_{n+d}(A) \cdot \left(1 - 5 \frac{dn^{3/4}}{k^{1/2}} \right) \\ &\geq (\mathcal{H}_{n+d}(A') - \mathcal{H}_{n+d}(C' \setminus C)) \cdot \left(1 - 5 \frac{dn^{3/4}}{k^{1/2}} \right) \\ &\geq \mathcal{H}_{n+d}(C) \left(\frac{1}{e} - \frac{\sqrt{n}(n+d)}{k} \right) \cdot \left(1 - 5 \frac{dn^{3/4}}{k^{1/2}} \right) \\ &\geq \frac{1}{e} \mathcal{H}_{n+d}(C) \left(1 - \frac{e}{5} \cdot d \frac{n^{3/4}}{k^{1/2}} \right) \cdot \left(1 - 5 \frac{dn^{3/4}}{k^{1/2}} \right) \\ &\geq \mathcal{H}_{n+d}(C) \cdot \frac{1}{e} \cdot \left(1 - 6 \frac{dn^{3/4}}{k^{1/2}} \right), \end{aligned}$$

where in the third inequality we applied Lemma 4.4, and then the assumption that $5 \frac{dn^{3/4}}{k^{1/2}} \leq 1$, so $\frac{\sqrt{n}(n+d)}{k} \leq d \frac{n^{3/4}}{k^{1/2}} \cdot \frac{n^{3/4}}{k^{1/2}} \leq \frac{1}{5} \cdot d \frac{n^{3/4}}{k^{1/2}}$.

On the other hand,

$$\begin{aligned} \mathcal{H}_d(B \cap (\mathbb{Z}^n \times \mathbb{R}^d)) &= \mathcal{H}_d(S) - \mathcal{H}_d(A \cap (\mathbb{Z}^n \times \mathbb{R}^d)) \\ &\geq (\mathcal{H}_{n+d}(C) - \mathcal{H}_{n+d}(A)) \cdot \left(1 - 6\sqrt{2} \frac{dn^{3/4}}{k^{1/2}} \right) \\ &= \mathcal{H}_{n+d}(B) \cdot \left(1 - 5 \frac{dn^{3/4}}{k^{1/2}} \right) \\ &\geq (\mathcal{H}_{n+d}(B') - \mathcal{H}_{n+d}(C' \setminus C)) \cdot \left(1 - 5 \frac{dn^{3/4}}{k^{1/2}} \right) \\ &\geq \mathcal{H}_{n+d}(C) \cdot \frac{1}{e} \cdot \left(1 - 6 \frac{dn^{3/4}}{k^{1/2}} \right). \end{aligned}$$

Now, directly by Lemma 4.3,

$$\mathcal{H}_d(S) \leq \mathcal{H}_{n+d}(C) \cdot \left(1 + 5 \frac{dn^{3/4}}{k^{1/2}}\right).$$

Therefore,

$$\begin{aligned} \frac{\min\{\mathcal{H}_d(A \cap (\mathbb{Z}^n \times \mathbb{R}^d)), \mathcal{H}_d(B \cap (\mathbb{Z}^n \times \mathbb{R}^d))\}}{\mathcal{H}_d(S)} &\geq \frac{1}{e} \cdot \frac{1 - 6 \frac{dn^{3/4}}{k^{1/2}}}{1 + 5 \frac{dn^{3/4}}{k^{1/2}}} \\ &\geq \frac{1}{e} \cdot \frac{\left(1 - 6 \frac{dn^{3/4}}{k^{1/2}}\right) \left(1 - 5 \frac{dn^{3/4}}{k^{1/2}}\right)}{\left(1 + 5 \frac{dn^{3/4}}{k^{1/2}}\right) \left(1 - 5 \frac{dn^{3/4}}{k^{1/2}}\right)} \\ &\geq \frac{1}{e} \cdot \left(1 - 11 \frac{dn^{3/4}}{k^{1/2}}\right). \end{aligned}$$

The second part of the proof follows very similar to what we did at the end of the proof of Theorem 3.5. Indeed, if $k \geq \alpha d^2 n^{3/2}$, we get that

$$\mathcal{F}(S) \geq \frac{1}{e} \left(1 - \frac{11}{\sqrt{\alpha}}\right).$$

We can choose $\alpha = \left(\frac{44}{4-e}\right)^2$ so $\frac{1}{e} \left(1 - \frac{11}{\sqrt{\alpha}}\right) \geq \frac{1}{4} \geq \frac{1}{2^n} \left(\frac{d}{d+1}\right)^d$. \square

4.3 A new threshold for the lattice width

Here we discuss the relation between the condition of our result, that the projection contains a ball of large radius, and the condition of large lattice width in the result of Basu and Oertel. We show that if the lattice width of a convex set is large, after an appropriate transformation, its projection in \mathbb{R}^n contains a large ball, and therefore, we can reinterpret our bound in terms of the lattice width.

Here, $\text{Flt}(n)$ is the flatness constant in dimension n , which is defined as the supremum of the lattice width of convex sets contained in $\mathbb{R}^n \setminus \mathbb{Z}^n$. It is known that $\text{Flt}(n) \leq n^{5/2}$ [2, Section 7.4, Theorem 8.3].

Proposition 4.6. *Given a convex body $K \subseteq \mathbb{R}^n$ there is an unimodular linear transformation $L : \mathbb{R}^n \rightarrow \mathbb{R}^n$ such that $L(K)$ contains a ball of radius $\omega(K)/(2n^2 \text{Flt}(n)) \geq \omega(K)/(2n^{9/2})$.*

Proof. Let Δ_n be the n -dimensional standard simplex in \mathbb{R}^n , that is, $\Delta_n = \text{conv}\{\mathbf{0}, \mathbf{e}_1, \dots, \mathbf{e}_n\}$. Averkov et al. [1, Theorem 2.1] showed that a convex set $K \subseteq \mathbb{R}^n$ always contains a unimodular copy of $\frac{\omega(C)}{2n \text{Flt}(n)} \cdot \Delta_n$, i.e., there is an affine unimodular transformation such that the image of C contains $\frac{\omega(C)}{2n \text{Flt}(n)} \cdot \Delta_n$. It is a well-known fact that the standard simplex Δ_n contains a ball of radius $1/n$, and therefore, the image of C contains a ball of radius $\frac{\omega(C)}{2n^2 \text{Flt}(n)}$. \square

A unimodular linear transformation in \mathbb{R}^n is a linear transformation that is invertible over the integers, i.e., it identifies points in \mathbb{Z}^n with points in \mathbb{Z}^n . If we extend L , the linear transformation of the proposition, to \mathbb{R}^{n+d} using the identity in \mathbb{R}^d , we obtain an invertible linear transformation $\bar{L} = (L, \text{Id})$ that preserves all the volumes in $\mathbb{Z}^n \times \mathbb{R}^d$. This means that we can effectively work with $\bar{L}(C \cap \mathbb{Z}^n \times \mathbb{R}^d)$ instead of $C \cap \mathbb{Z}^n \times \mathbb{R}^d$, and any conclusion about the volume also holds for $C \cap \mathbb{Z}^n \times \mathbb{R}^d$. Thus, we obtain the following as a consequence of our theorem.

Corollary 4.7. *Let $C \subseteq \mathbb{R}^{n+d}$ be a convex body. There is a point $\mathbf{x} \in S = C \cap (\mathbb{Z}^n \times \mathbb{R}^d)$ such that for every halfspace H that contains \mathbf{x} ,*

$$\mathcal{H}_d(H \cap S) \geq \left(\frac{1}{e} - 11\sqrt{2} \frac{dn^{7/4} \sqrt{\text{Flt}(n)}}{\sqrt{\omega(C)}} \right) \cdot \mathcal{H}_d(S).$$

In particular, there is a universal constant $\alpha > 0$ such that if $\omega(C) \geq \alpha d^2 n^6$, then

$$\mathcal{F}(S) \geq \frac{1}{2^n} \left(\frac{d}{d+1} \right)^d.$$

5 Final comments and perspectives

We provided new thresholds for large sets such that Basu-Oertel Conjecture (Conjecture 1) holds true. The first one is based on the idea that a large set should contain a large ball, and the second one is based on the concept of lattice width, as in Theorem 1.1. In both cases, our thresholds are polynomial: for the radius of the ball the threshold is $\Omega(d^2 n^{3/2})$, and for the lattice width (of the projection to the integer variables) the threshold is $\Omega(d^2 n^6)$.

We believe that Basu-Oertel Conjecture holds in general, and not only for large sets. However, this has proven to be a very challenging problem.

Acknowledgements. The first and second author were partially funded by the Center of Mathematical Modeling (CMM), FB210005, BASAL funds for centers of excellence (ANID-Chile). The second author was partially funded by the project FONDECYT 11220686 (ANID-Chile). The second author wishes to thank A. Basu for his lectures and useful discussions during the conference IPCO 2023, that motivated this research. This research was conducted during the post-doctoral fellowship of the first author at the Center of Mathematical Modeling (CMM).

References

- [1] Gennadiy Averkov, Johannes Hofscheier, and Benjamin Nill. Generalized flatness constants, spanning lattice polytopes, and the Gromov width. *Manuscripta Math.*, 170(1-2):147–165, 2023.
- [2] Alexander Barvinok. *A course in convexity*, volume 54 of *Graduate Studies in Mathematics*. American Mathematical Society, Providence, RI, 2002.
- [3] Amitabh Basu. Complexity of optimizing over the integers. *Math. Program.*, 200(2):739–780, 2023.

- [4] Amitabh Basu, Hongyi Jiang, Phillip Kerger, and Marco Molinaro. Information complexity of mixed-integer convex optimization. *Math. Program.*, 2024.
- [5] Amitabh Basu and Timm Oertel. Centerpoints: a link between optimization and convex geometry. *SIAM J. Optim.*, 27(2):866–889, 2017.
- [6] Alexandre Belloni and Robert M. Freund. On the symmetry function of a convex set. *Math. Program.*, 111(1-2):57–93, 2008.
- [7] Dimitris Bertsimas and Santosh Vempala. Solving convex programs by random walks. *J. ACM*, 51(4):540–556, 2004.
- [8] Sergey G. Bobkov. Convex bodies and norms associated to convex measures. *Probab. Theory Related Fields*, 147(1-2):303–332, 2010.
- [9] Károly J. Böröczky and Martin Henk. Cone-volume measure and stability. *Adv. Math.*, 306:24–50, 2017.
- [10] Patryk Brzezinski. Volume estimates for sections of certain convex bodies. *Math. Nachr.*, 286(17-18):1726–1743, 2013.
- [11] F. Dabbene, P. S. Shcherbakov, and B. T. Polyak. A randomized cutting plane method with probabilistic geometric convergence. *SIAM J. Optim.*, 20(6):3185–3207, 2010.
- [12] Lawrence C. Evans and Ronald F. Gariepy. *Measure theory and fine properties of functions*. Textbooks in Mathematics. CRC Press, Boca Raton, FL, revised edition, 2015.
- [13] B. Grünbaum. Partitions of mass-distributions and of convex bodies by hyperplanes. *Pacific J. Math.*, 10:1257–1261, 1960.
- [14] Branko Grünbaum. Measures of symmetry for convex sets. In *Proc. Sympos. Pure Math., Vol. VII*, pages 233–270. Amer. Math. Soc., Providence, RI, 1963.
- [15] Simai He, Zhi-Quan Luo, Jiawang Nie, and Shuzhong Zhang. Semidefinite relaxation bounds for indefinite homogeneous quadratic optimization. *SIAM J. Optim.*, 19(2):503–523, 2008.
- [16] Vladimir Kadets. Coverings by convex bodies and inscribed balls. *Proc. Amer. Math. Soc.*, 133(5):1491–1495, 2005.
- [17] B. Klartag. A central limit theorem for convex sets. *Invent. Math.*, 168(1):91–131, 2007.
- [18] László Lovász and Santosh Vempala. The geometry of logconcave functions and sampling algorithms. *Random Structures Algorithms*, 30(3):307–358, 2007.
- [19] A. S. Nemirovsky and D. B. Yudin. *Problem complexity and method efficiency in optimization*. Wiley-Interscience Series in Discrete Mathematics. John Wiley & Sons, Inc., New York, 1983.
- [20] M. Stephen and N. Zhang. Grünbaum’s inequality for projections. *J. Funct. Anal.*, 272(6):2628–2640, 2017.
- [21] Matthew Stephen and Vlad Yaskin. Applications of Grünbaum-type inequalities. *Trans. Amer. Math. Soc.*, 372(9):6755–6769, 2019.