

# Highlights

## Upgrade of the Diagnostic Neutral Beam Injector for the RFX-mod2 experiment

Marco Barbisan<sup>1</sup>, Marco Boldrin<sup>1</sup>, Luca Cinnirella<sup>1</sup>, Bruno Laterza, Alberto Maistrello<sup>1</sup>, Lionello Marrelli<sup>1</sup>, Federico Molon<sup>1</sup>, Simone Peruzzo<sup>1</sup>, Cesare Taliercio<sup>1</sup>, Marco Valisa<sup>1</sup>, Enrico Zampiva<sup>1</sup>

arXiv:2411.13373v1 [physics.plasm-ph] 20 Nov 2024

- A Diagnostic Neutral Beam Injector (DNBI), in combination with optical diagnostics, can provide crucial measurements for Reversed Field Pinch Plasmas.
- The DNBI at the RFX-mod2 experiment is in phase of extraordinary maintenance and upgrade.
- New circuits and devices were tested.
- The electrical systems and the control system are being redesigned in order to be more reliable and robust.

# Upgrade of the Diagnostic Neutral Beam Injector for the RFX-mod2 experiment

Marco Barbisan<sup>a,\*</sup>, Marco Boldrin<sup>b</sup>, Luca Cinnirella<sup>c</sup>, Bruno Laterza<sup>b</sup>, Alberto Maistrello<sup>b</sup>, Lionello Marrelli<sup>a,b</sup>, Federico Molon<sup>b</sup>, Simone Peruzzo<sup>a</sup>, Cesare Taliercio<sup>a,b</sup>, Marco Valisa<sup>a,b</sup>, Enrico Zampiva<sup>a,b</sup>

<sup>a</sup>Istituto per la Scienza e la Tecnologia dei Plasmi (ISTP), C.so Stati Uniti, 4, Padova, 35127, Veneto, Italy

<sup>b</sup>Consorzio RFX (CNR, ENEA, INFN, Università di Padova, Acciaierie Venete SpA), C.so Stati Uniti, 4, Padova, 35127, Veneto, Italy

<sup>c</sup>Centro Ricerche Fusione (CRF), Università degli studi di Padova, C.so Stati Uniti, 4, Padova, 35127, Veneto, Italy

---

## Abstract

Diagnostic Neutral Beam Injectors (DNBI), through the combined use of Charge Exchange Recombination Spectroscopy (CHERS) and Motional Stark effect diagnostics (MSE), are a well-known tool to access important information about magnetically confined plasmas, such as radial profiles of ion temperature, ion flow, impurity content and intensity and direction of the magnetic field. For this purpose, a DNBI was installed and operated in the RFX-mod experiment, which was designed to confine plasma mainly through the Reversed Field Pinch configuration. The DNBI, designed and built by the Budker Institute of Plasma Physics, was based on a source of positive hydrogen ions, accelerated to 50 keV and for an equivalent neutral beam current of about 5 A at the source. The beam could be modulated and the maximum overall duration was 50 ms.

With the upgrade of RFX-mod to the present RFX-mod2 machine, the DNBI is being renovated to solve several plant faults and improve the overall reliability of the system. The 50 kV power supply is being improved, as well as the power supplies in the high voltage deck and its insulation transformer. The control system, originally based on CAMAC technology, was redesigned to be fully replaced. This contribution reviews the technical criticalities emerged in the DNBI check-up and the new solutions adopted to make the DNBI operative and more reliable.

*Keywords:* Neutral beam injector, reversed field pinch, Charge eXchange Recombination Spectroscopy, Motional Stark Effect

---

## 1. Introduction

The injection of a neutral beam into a magnetic confined plasma is a well established technique to probe several plasma properties. Thanks to the charge-exchange processes between beam particles and fully ionized impurity atoms, these particles can emit line radiation. This light is collected by the lines of sight of the Charge eXchange Recombination Spectroscopy diagnostic (CXRS), which can measure the plasma impurity concentration (from spectral line intensities), the impurity flow (from the line Doppler shift) and the impurity temperature (from line broadening). [1, 2] The beam-plasma interactions also cause the beam particles to emit  $H_{\alpha}/D_{\alpha}$  radiation; these fast particles, being immersed in the confining magnetic field, experience an electric field  $\mathbf{E} = \mathbf{v} \times \mathbf{B}$ , that in turn causes the Stark splitting of the Doppler Shifted  $H_{\alpha}/D_{\alpha}$  lines. The Motional Stark Effects (MSE) analyzes the wavelength separation of the Stark components to retrieve the intensity of  $\mathbf{B}$ , while the identification of the polarization direction of the Stark components allows to measure the direction of  $\mathbf{B}$ . [3–6]

Diagnostic Neutral Beam Injectors (DNBI), together with the CXRS and MSE diagnostics, have been extensively used in tokamak experiments, while less experimentation was carried out in Reversed Field Pinch (RFP) machines.[7–10] Being able

to probe the magnetic field in the plasma core would be especially beneficial in reconstructing the complex  $\mathbf{B}$  RFP maps, that would otherwise rely on the only edge measurements. [11] For this reason, the RFX-mod RFP experiment [12] in Consorzio RFX (Padua) was equipped in 2005 with a DNBI (figure 1), designed, built and procured by the Budker Institute for Nuclear Physics (BINP, Novosibirsk). The DNBI, based on an arc-discharge positive ion source could produce a 50 keV, 2 A neutral beam of maximum duration 50 ms and maximum divergence 0.5°; the beam current could be modulated up to a maximum frequency of 250 Hz, to discriminate the beam-induced emissions from the background ones. [13]

With the ongoing upgrade of the RFX-mod experiment to the new RFX-mod2 [14–16], the DNBI requires extraordinary maintenance and an upgrade of several plants. The main issues are the following:

- The insulation transformer, powering the ion-source-related devices at 50 kV potential, is faulty.
- Several power and high voltage devices are aged and unsafe.
- The control and data acquisition system is based on an obsolete technology (CAMAC).[17]
- The DNBI cryopumps, working in open cycle for He, are not economically sustainable.
- Severe beam losses were observed in the DNBI-torus chamber duct during plasma operation.

The solution of these issue is part of the NEFERTARI project

---

\*Corresponding author

Email address: marco.barbisan@istp.cnr.it (Marco Barbisan)

(New Equipment For the Experimental Research and Technological Advancement of the RFX Infrastructure). Due to geopolitical criticalities it has been impossible to collaborate with BINP, the project team has then started to fix and upgrade the DNBI in-house. Other laboratories in Europe, hosting BINP-developed DNBI [18–20], are affected by the same situation. The paper shares the experimental tests and the design activities on the DNBI electrical plants, that are being carried out in ISTP (Istituto per la Scienza e Tecnologia dei Plasmi) and Consorzio RFX to have an operative, safer and more robust DNBI, but also as a part of a more collective effort to keep several DNBI in Europe into operation.

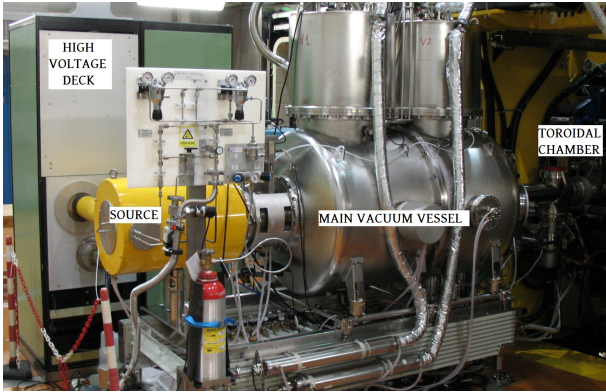

Figure 1: A view of the DNBI installed in RFX-mod.

## 2. Electrical tests

The DNBI power plants can be divided in two main groups: those required to generate the 50 kV acceleration potential difference for the positive ions, and those required to operate the ion source. Given the high electric power to be released for a short time (eg. more than 250 kW for the only 50 kV system), both systems rely on the slow (about 7 min.) loading of banks of capacitors, which are partially discharged at the moment of the plasma and beam extraction pulses.

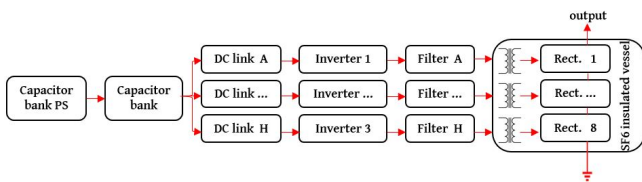

Figure 2: Conceptual scheme of the 50 kV power supply.

### 2.1. High voltage tests

The scheme of the 50 kV generation system is represented in figure 2. The capacitor bank, 150 mF loaded at 830 V, is partially discharged through eight DC links, who regulate the input voltage for eight inverters. The filtered outputs are transferred to step-up transformers, followed by rectifiers and filters, connected in series to reach 50 kV. Transformers, rectifiers and

filters are contained in a vessel, filled with SF<sub>6</sub> at the absolute pressure of 1.7 bar. The high voltage output is determined by the voltage outputs of the DC links.

The restoration of this system involved several activities: a slow reforming of the electrolytic capacitors, the restoration of the power supply to load the capacitor bank, a careful check of all wirings between boards and racks, progressive load tests on each DC-link and inverter, and finally SF<sub>6</sub> leak tests and replacement of the gas inside the power supply vessel. Before coupling the inverter and filters to the respective step-up transformers, their output was tested one by one on a 150 Ω resistive load (max. 1 kW transient, 50 W steady state). The peak-to-peak AC output voltage of the eight inverters is shown in figure 3 as a function of the DC link analog control input. Two sets among the eight ones gave an output voltage about 30 % lower than the other ones; wiring losses on the analog input line and different internal settings of the control boards were excluded as possible causes of this issue. The overall aging of the electronics is considered responsible of the issue; this suggests to at least replace the low voltage control electronics, and make its design more robust. The DNBI cabinets are placed in same hall of the RFX-mod2 toroidal chamber: frequent repairs would not be tolerated during experimental sessions.

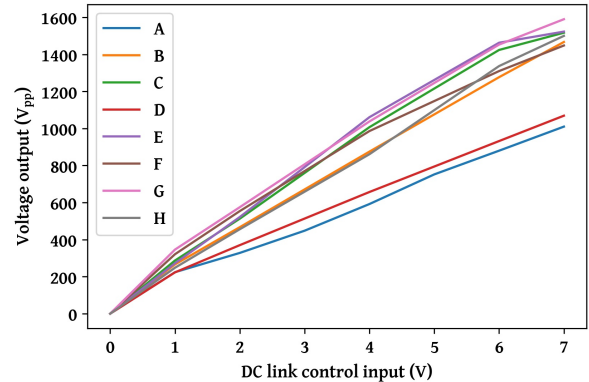

Figure 3: Peak-to-peak voltage output of each inverter line for 50 kV generation, as a function of the analog control input. Measurements are performed on a 150 Ω resistive load.

In the unavailability of a resistor to mimic the acceleration system load (50 kV, about 5 A), the high voltage output of the entire system was tested on the resistive divider (bottom right corner of figure 5) which is used to derive the potential of the second grid. The total resistance of the divider amounts to 55 kΩ. In these conditions, the entire system was successfully able to reach the output voltage of 50 kV for at least 50 ms. 0 %-100 % output modulation tests were performed, showing a rise/fall time below 1 ms, which is adequate for the DNBI operation.

### 2.2. IGBT control

Insulated-Gate Bipolar Transistors (IGBTs) are the core of DC links and inverters. To manage the IGBT switching, a 160 kHz clock signal is generated in the main control board. In every group of 8 digital pulses, every pulse is sequentially sent

to the controller a different DC link-Inverter line; the received pulses set the frequency (20 kHz) of the IGBT switching. This method allows to minimize the overall high voltage ripple. The aging of electronics and the documentation of past operational issues suggested to redesign the control boards for the DC link-inverter lines. To have a more inspectable system, the core of the new control boards will be an Espressif ESP32-C3 microcontroller, which will be able to communicate with the control system in Modbus standard. [21] Main duty of the microcontroller will be to retransmit the clock pulse to the IGBT drivers, adjusting the duty cycle as a function of an analog control waveform and of an opto-isolated analog feedback from the DC link. Both analog inputs will be acquired by a Microchip MCP3202 ADC (12 bit, 100 kS/s total).[22] The duty cycle will determine the DC link output voltage; the microcontroller should be able to adjust it in between every 20 kHz pulse. Bench tests verified that the output pulse from the microcontroller has a delay between 50 ns and 100 ns with respect to the input pulse; moreover, the jitter of the output pulse is less than 50 ns. These values are considered adequate.

The microcontroller is supposed to control the IGBTs of the original DNBI (Semikron SKM200GB128D [23]) through a gate driver, which should provide adequate insulation between control and IGBT and manage IGBT protection systems. The original driver (Powerex M57962L [24]) will be substituted by the Texas Instruments ISO5451 [25], featuring a better short propagation delay (76 ns vs 1.0  $\mu$ s), a better insulation voltage (5700  $V_{RMS}$  vs 2500  $V_{RMS}$  AC) and an insulated fault pin. For a preliminar test, the driver interfaced the microcontroller and an IGBT according to the recommended scheme in figure 10-3 of ref. [25]. The controlled IGBT could successfully drive a 80 A current (foreseen in the DNBI devices) on a 0.24  $\Omega$  resistive load, and repeatedly open the circuit. A 37.5  $\Omega$  resistor was put in parallel to the collector and the emitter of the IGBT, to limit overvoltages when the IGBT opened the load circuit. The desaturation and active Miller clamp protection features of the ISO5451 were successfully tested.

### 2.3. Magnetic field survival tests

The DNBI is equipped with several lab-built low voltage power supplies, that serve control and power devices. To improve the overall reliability and maintainability of the system, these power supplies will be substituted with commercial DC-DC converters. These devices, as well as their predecessors, could be affected by the magnetic fields around the RFX-mod2 machine: they all employ toroidal magnetic cores, that could get saturated. Significant variations in the available voltage or current may lead to unpredictable behaviour of the main DNBI devices; moreover, identifying these issues during the short RFX-mod2 pulses (around 1 s) and with limited access to the hall may increase the unavailability of the DNBI in case of electric faults.

To prevent this risk, several commercial DC-DC converters, listed in table 1, were tested at 130 mT, i.e. twice the magnetic field intensity expected at the position of these devices. The converters were tested at about 2/3 of their respective maximum output load, with the magnetic field at three possible or-

thogonal axes. The converter 1 proved to stand 130 mT at 10 magnetic field pulses, 2 s long, or at a single 10 s magnetic field pulse (time was limited due to the heating on the coil used to produce the field). These times are relatively long compared to the DNBI operation: the plasma phase should last 100 ms, the beam phase 50 ms. It was experimentally determined that the converter 1 can reliably switch on only if powered before the beginning of a magnetic field pulse. All the other converters stopped working under magnetic field, some in reversible ways, while others were permanently damaged. Enclosing the converters 2-7 in transformer core foils improved their resistance to intermediate magnetic field intensities, but not allowed them to properly work along all three possible magnetic field directions.

Table 1: DC-DC converters tested at 130 mT magnetic field.

#	Model	Ref.
1	TRACO POWER TEN 5-2423	[26]
2	TRACO POWER THM 3-0523	[27]
3	TEXAS INSTR. DCP022405DP	[28]
4	MURATA NMA1212SC	[29]
5	MURATA CRE1S0505S3C	[30]
6	TEXAS INSTR. DCP010505DBP	[31]
7	MURATA MGJ2D151505MPC-R7	[32]

## 3. Upgrade of electrical systems

### 3.1. HVD power transfer

As anticipated in sec. 1, the DNBI ion source is held at 50 kV, therefore all the devices serving it are enclosed in a High Voltage Deck (HVD) and powered through an insulation transformer. All this is installed inside a cabinet close to the ion source, together with the HV components required to derive the 2<sup>nd</sup> grid extraction potential, to measure grids currents, to detect and protect from breakdowns and overvoltages (figure 5). The main issue with the present instrumentation is the faulty insulation transformer. As schematized in figure 4, there are actually three insulation transformers inside the oil container; they are served by DC link-inverter couples, which drain charge from a common capacitor bank. The outputs of two insulation transformers power the arc current power supply, necessary to ignite and sustain the plasma. The third insulation transformer powers the auxiliary power supplies, eg. for the axial magnetic field in the source, or for the input gas valves.

Inspectioning and repairing a custom triple insulation transformer may have uncertain results; replacing it in the present form would be unlikely and expensive (scarcity of manufacturers in the market). It was then decided to change the powering scheme of the HVD. As shown in figure 4, the new scheme foresees a simple single-phase 100 kV insulation transformer. Inside the HVD, it will directly serve the low power auxiliary power supplies, as well as a commercial 500 V DC power supply. The capacitor bank will be moved inside the HVD and kept loaded by this power supply. The capacitor bank will in turn serve the arc current power supply. As evident from figure 4, this solution will allow not only to substitute the insulation

### Power supplies for the High Voltage Deck – present configuration

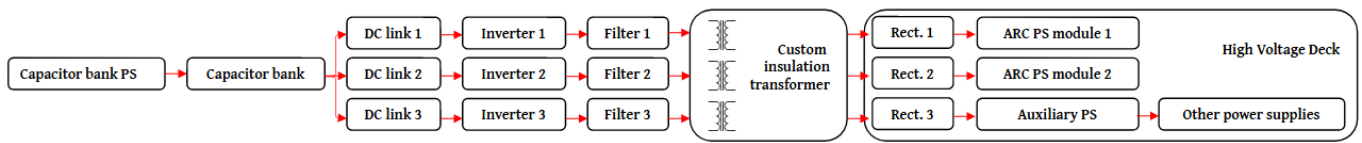

### A simplified and more robust upgrade

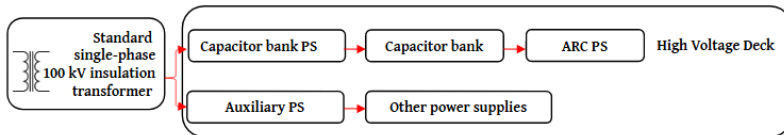

Figure 4: Conceptual schemes of the present and future HVDs.

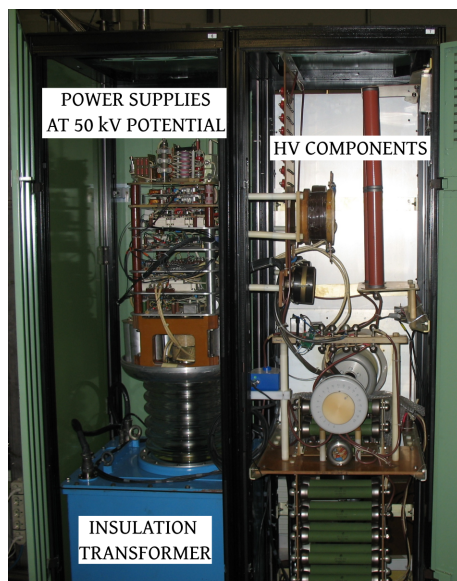

Figure 5: Present HVD layout.

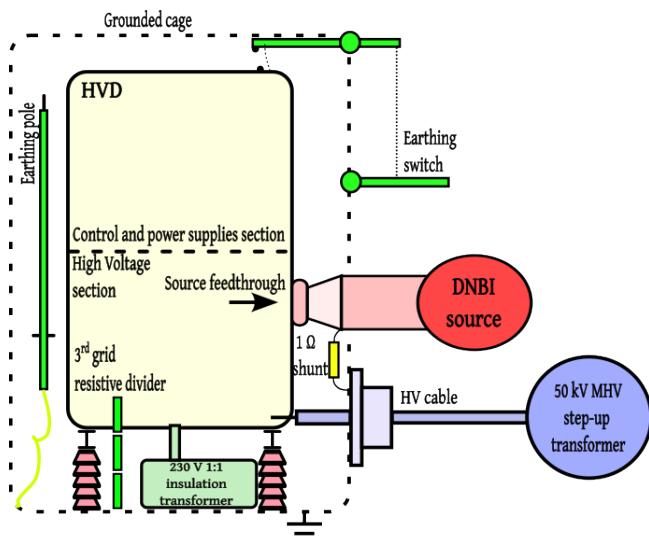

Figure 6: Conceptual design for the new HVD.

transformer, but also to greatly simplify the electrical plants, hopefully making them more robust and reliable.

Figure 6 shows a preliminar layout of the new HVD. A commercial cabinet is kept at 50 cm height from the ground. The insulation transformer will be installed in between. The 50 kV output will be linked to the chassis of the cabinet, and used for all HV components; these will be completely rearranged and substituted, because of the number of unexpected arcs occurred during HV tests. The ion source inputs will be routed through coaxial pipes. While the HV components will be hosted in the lower part of the HVD, the remaining devices (control and data acquisition, capacitor bank, arc power supply, etc.) will stay in the upper half, protected by arcs and related electromagnetic interference by a metal shield. At last, the whole HVD will be made inaccessible by a grounded cage.

### 3.2. Arc current power supply

The arc power supply, schematized in figure 7, is required to initiate and sustain the plasma. The maximum output ratings are 150 V, 500 A; the arc ignition is expected to require less than 2 kV. The ignition pulse will be provided by a dedicated 2 nF - 5 kV capacitor kept in charge by a power supply; the capacitor discharge will be triggered by a series of thyristors. A 2 kΩ resistor will limit the discharge current. The main arc current will instead be derived from the charge of the capacitor bank in the HVD. A DC link will tailor the output according the analog waveform given by the acquisition system, and according to the feedback on the output current provided by a shunt resistor.

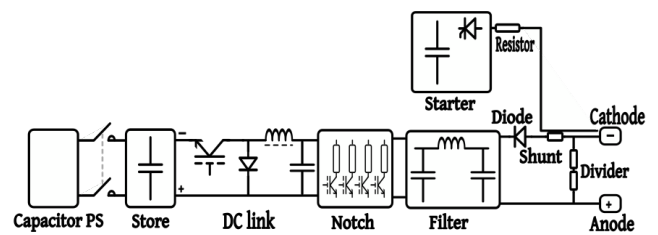

Figure 7: Conceptual design of the arc power supply.

In case of breakdowns in the beam acceleration system, the acceleration voltage will be totally zeroed for few milliseconds.

Similarly, the arc current output will have to be notched to a minimum value, in order to not stop the arc. For a robust control of the notch, the current reduction factor will be set by four digital inputs, triggering four notch systems, each one adding a lower and lower resistance in parallel to the output. A LCR net will finally filter the arc current output. The arc voltage will be measured through a resistive divider, while a diode will prevent current inversions from entering the power supply (eg. the ignition pulse).

#### 4. Upgrade of the control system

The present control and data acquisition (CODAQ) system is based on the obsolete CAMAC standard [17], which is not reliably maintainable anymore. The new CODAC will be composed by two subsystems. The first one will be based on a PLC, for slow (about 10 S/s) analog and digital inputs/outputs and especially for all signals involved in machine or human safety. The PLC will also manage the pumping system, which was separately controlled by a  $\mu$ PLC SIEMENS “LOGO! 12/24RC” [33] alongside the CAMAC devices. The devices composing the new PLC system are schematized in figure 8. The PLC will be hosted in the cabinets at ground potential, together with a touch panel for the inspection of system data or for the manual operation of plants during preliminary tests or maintenance operations. The PLC will be connected via optical fiber to a peripheral in the HVD, for the inputs/outputs of the devices at 50 kV potential.

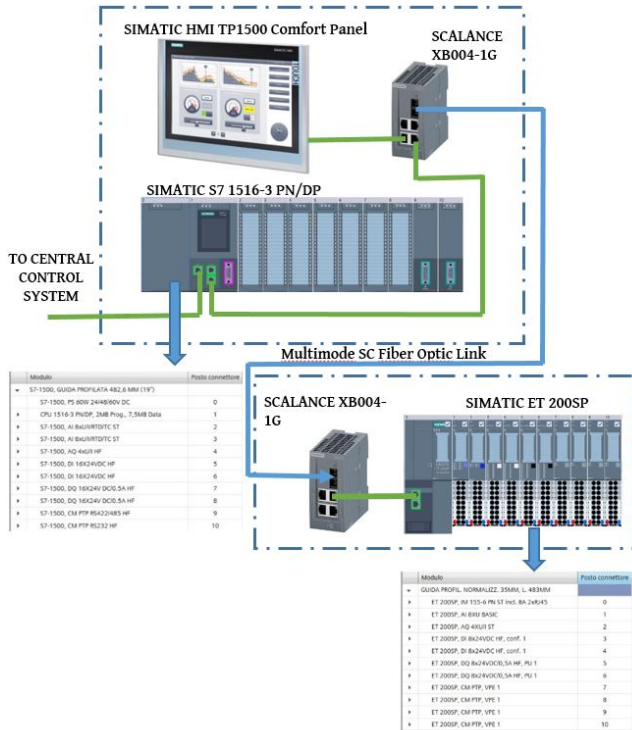

Figure 8: PLC control for the upgraded DNBI. [34–37]

The second subsystem will be instead devoted to fast data acquisition (DAQ) and for fast analog and digital outputs. Fol-

lowing a similar scheme with respect to the PLC, a D-tAcq ACQ2106 modular data acquisition system will be used for the signals in the ground cabinets, while a D-tAcq ACQ1002R will be installed in the HVD, with data transfer via fiber optic link. [38, 39] These devices will allow an easy integration of data storage in the MDSplus software, which was adopted in the whole RFX-mod machine as well as in RFX-mod2.[40] DAQ analog inputs and outputs will have 16 bit resolution; both analog and digital inputs/outputs will be sampled at 1 MS/s. At last, an overview of the number of signals to be handled in the DNBI is provided in table 2.

Table 2: Input and outputs for the control and data acquisition system.

	DAQ GND	DAQ HV	PLC GND	PLC HV
RS232, Modbus, etc.	1	0	10	6
Analog Input, slow	16	0	9	2
Analog input, fast	7	9	0	0
Analog output, slow	0	0	3	2
Analog output, fast	2	2	0	0
Digital Input, slow	0	0	55	11
Digital input, fast	3	0	1	0
Digital output, slow	0	0	22	14
Digital output, fast	3	3	0	0

#### 5. Conclusions

Diagnostic Neutral Beam Injectors are fundamental to retrieve several properties of the plasma core by means of spectroscopy. Given the impossibility of refurbishing the RFX-mod2 DNBI from its manufacturer, the paper has shown how the new DNBI design will solve the issues of those plants that cannot be substituted or kept maintained. The new design of the entire HVD and relative powering system will be more robust, safe and maintainable. The new control system will be maintainable and better interfaceable with the present hardware and software. As final remark, the authors wish that future geo-political conditions will re-establish peace and international freedom in research communications.

#### Data availability

The data and python code to generate figure 3 and the source code to test the ESP32-C3 microcontrollers are available at ref. [41].

#### Acknowledgements

This work has been funded by the European Union - NextGenerationEU. Views and opinions expressed are however those of the author(s) only and do not necessarily reflect those of the European Union or the European Commission. Neither the European Union nor the European Commission can be held responsible for them.

The authors thank L. Baseggio, D. Fasolo, M. Fincato, L. Franchin, G. Passalacqua and E. Zerbetto for their support in the activities of the project.

## References

- [1] P.G. Carolan, B.P. Duval, A.R. Field, S.J. Fielding, N.C. Hawkes, N.J. Peacock et al., *Charge-exchange-excited line radiation in a tokamak (ASDEX) with neutral-particle-beam injection*, *Phys. Rev. A* **35** (1987) 3454.
- [2] R.C. Isler, *An overview of charge-exchange spectroscopy as a plasma diagnostic*, *Plasma Physics and Controlled Fusion* **36** (1994) 171.
- [3] D. Wróblewski, L.K. Huang and H.W. Moos, *Scanning polarimeter for measurement of the poloidal magnetic field in a tokamak*, *Review of Scientific Instruments* **59** (1988) 2341.
- [4] F.M. Levinton, R.J. Fonck, G.M. Gammel, R. Kaita, H.W. Kugel, E.T. Powell et al., *Magnetic field pitch-angle measurements in the PBX-M tokamak using the motional stark effect*, *Phys. Rev. Lett.* **63** (1989) 2060.
- [5] B.C. Stratton, D. Long, R. Palladino and N.C. Hawkes, *Instrumentation for the joint European torus motional Stark effect diagnostic*, *Review of Scientific Instruments* **70** (1999) 898.
- [6] R. Wolf, A. Bock, O. Ford, R. Reimer, A. Burckhart, A. Dinklage et al., *Motional Stark Effect measurements of the local magnetic field in high temperature fusion plasmas*, *Journal of Instrumentation* **10** (2015) P10008.
- [7] L. Carraro, M.E. Puiatti, F. Sattin, P. Scarin and M. Valisa, *Requirements for an active spectroscopy diagnostic with neutral beams on the RFX reversed field pinch*, *Review of Scientific Instruments* **70** (1999) 861.
- [8] M. Kuldkepp, M.J. Walsh, P.G. Carolan, N.J. Conway, N.C. Hawkes, J. McCone et al., *Motional Stark effect diagnostic pilot experiment for MAST*, *Review of Scientific Instruments* **77** (2006) 10E905.
- [9] J. Ko, D.J. Den Hartog, K.J. Caspary, E.A. Den Hartog, N.A. Pablant and H.P. Summers, *Two-point motional Stark effect diagnostic for Madison Symmetric Torus*, *Review of Scientific Instruments* **81** (2010) 10D702.
- [10] D.D. Hartog, J. Ambuel, M. Borchardt, K. Caspary, E.D. Hartog, A. Falkowski et al., *Advances in time-resolved measurement of magnetic field and electron temperature in low-magnetic-field plasmas*, *Fusion Science and Technology* **59** (2011) 124.
- [11] F. Bonomo, D. Bonfiglio, P. Piovesan, L. Piron, B. Zaniol, S. Cappello et al., *Flow measurements and modelling in helical RFX-mod equilibria*, *Nuclear Fusion* **51** (2011) 123007.
- [12] M. Zuin, S.D. Bello, L. Marrelli, M. Puiatti, P. Agostinetti, M. Agostini et al., *Overview of the RFX-mod fusion science activity*, *Nuclear Fusion* **57** (2017) 102012.
- [13] S.A. Korepanov, G.F. Abdrashitov, D. Beals, V.I. Davydenko, P.P. Deichuli, R. Granetz et al., *Neutral beam injector for active plasma spectroscopy*, *Review of Scientific Instruments* **75** (2004) 1829.
- [14] L. Marrelli, R. Cavazzana, D. Bonfiglio, M. Gobbin, G. Marchiori, S. Peruzzo et al., *Upgrades of the RFX-mod reversed field pinch and expected scenario improvements*, *Nuclear Fusion* **59** (2019) 076027.
- [15] S. Peruzzo, M. Bernardi, G. Berton, R. Cavazzana, S. Dal Bello, M. Dalla Palma et al., *Technological challenges for the design of the RFX-mod2 experiment*, *Fusion Engineering and Design* **146** (2019) 692.
- [16] D. Terranova, M. Agostini, F. Auremma, M. Gobbin, G. Marchiori, L. Pigatto et al., *RFX-mod2 as a flexible device for reversed-field-pinch and low-field tokamak research*, *Nuclear Fusion* **64** (2024) 076003.
- [17] D. Horelick and R.S. Larsen, *CAMAC: a modular standard*, *IEEE Spectrum* **13** (1976) 50.
- [18] J. Wood, B. Lomanowski, E. Delabie, H. Willett, M. Sertoli and J. Varje, *Characterisation of ion temperature and toroidal rotation on the ST40 tokamak*, *Journal of Instrumentation* **18** (2023) C03019.
- [19] A. Listopad, Y. Andrebe, P. Blanchard, S. Coda, F. Dolizy, J. Dubray et al., *Present status of heating neutral beam injection system at TCX*, in *submitted to Fus. Eng. Des.*, 2024.
- [20] I. Mysiura, K. Bogar, O. Ficker, F. Jaulmes, M. Komm, J. Varju et al., *80 keV 1 MW NBI on COMPASS tokamak: the results and operational experience*, in *submitted to Fus. Eng. Des.*, 2024.
- [21] Espressif Systems (Shanghai) Co., Ltd., *ESP32-C3 Series*, Version 1.9 ed., 8, 2024.
- [22] Microchip Technology Inc., *MCP3202 - 2.7V Dual Channel 12-Bit A/D Converter with SPI Serial Interface*, DS21034F ed., 2, 2011.
- [23] Semikron Danfoss GmbH, *SKM 200 GB 128 D datasheet*, 011114 ed.
- [24] Powerex Inc., *M57962L datasheet*, pp. 151-152 ed.
- [25] Texas Instruments Inc., *ISO5451 High-CMTI 2.5-A and 5-A Isolated IGBT, MOSFET Gate Driver With Active Protection Features*, SLLSE01D ed., 5, 2023.
- [26] Traco Electronic AG, *DC/DC Converters - TEN 5 Series*, 6 Watt, 4, 2023.
- [27] Traco Electronic AG, *DC/DC Medical Converter - THM 3 Series*, 3 Watt, 8, 2024.
- [28] Texas Instruments Inc., *DCP02 Series, 2-W, 1000-V<sub>RMS</sub> Isolated, Unregulated DC/DC Converter Modules*, 8, 2024.
- [29] Murata Manufacturing Co., Ltd., *NMA 5V, 12V & 15V Series*, KDC\_NMA.001 ed., 2023.
- [30] Murata Manufacturing Co., Ltd., *CRE1 Series*, KDC\_CRE1.F01 ed., 2023.
- [31] Texas Instruments Inc., *DCP01 Series, 1-W, 1000-V<sub>RMS</sub> Isolated, Unregulated DC/DC Converter Modules*, 9, 2020.
- [32] Murata Manufacturing Co., Ltd., *MGJ2 Surface Mount Series*, KDC\_MGJ2SM.E01 ed., 2024.
- [33] Siemens AG, *Logo! manual*, A5E00228550-01 ed., 6, 2003.
- [34] Siemens AG, *SIMATIC S7-1500 CPU 1516-3 PN/DP (6ES7516-3AN01-0AB0)*, A5E03461313-AD ed., 9, 2016.
- [35] Siemens AG, *SIMATIC ET 200SP distributed I/O system*, A5E03576849-01 ed., 3, 2012.
- [36] Siemens AG, *6AV2124-0QC02-0AX1*, 10, 2024.
- [37] Siemens AG, *6GK5004-1GL10-1AB2*, 11, 2018.
- [38] D-tAcq Solutions Ltd., *6-Site D-TACQ ELF/FMC Carrier with High-Speed Comms*, 1401-5004-001 Rev. 2 ed., 9, 2023.
- [39] D-tAcq Solutions Ltd., *ACQ1001/ACQ1002 1 and 2-Site D-TACQ ELF/FMC Carriers*, 1401-5003-001-Rev6 ed., 9, 2023.
- [40] G. Martini, P. Barbato, N. Ferron, A. Luchetta, G. Manduchi, A. Rigoni et al., *Control and Data Acquisition System Upgrade in RFX-mod2*, in *Proc. 19th Int. Conf. Accel. Large Exp. Phys. Control Syst. (ICALPECS'23)*, no. 19 in International Conference on Accelerator and Large Experimental Physics Control Systems, pp. 607-611, JACoW Publishing, Geneva, Switzerland, 02, 2024, DOI.
- [41] M. Barbisan, M. Boldrin, L. Cinnirella, B. Laterza, A. Maistrello, L. Marrelli et al., *Data for "Upgrade of the Diagnostic Neutral Beam Injector for the RFX-mod2 experiment"*, *Zenodo* (2024) .

© 2024. This manuscript version is made available under the CC-BY-NC-ND 4.0 license <https://creativecommons.org/licenses/by-nc-nd/4.0/>