

Hilbert Subspace Ergodicity

Leonard Logarić,^{1,2,*} John Goold,^{1,2,3,†} and Shane Dooley^{4,2,‡}

¹*Department of Physics, Trinity College Dublin, Dublin 2, Ireland*

²*Trinity Quantum Alliance, Unit 16, Trinity Technology and Enterprise Centre, Pearse Street, Dublin 2, D02 YN67, Ireland*

³*Algorithmiq Limited, Kanavakatu 3C 00160 Helsinki, Finland*

⁴*Dublin Institute for Advanced Studies, School of Theoretical Physics, 10 Burlington road, Dublin, D04 C932, Ireland*

(Dated: November 22, 2024)

Ergodicity has been one of the fundamental concepts underpinning our understanding of thermalisation in isolated systems since the first developments in classical statistical mechanics. Recently, a similar notion has been introduced for quantum systems, termed Complete Hilbert Space Ergodicity (CHSE), in which the evolving quantum state explores all of the available Hilbert space. This contrasts with the Eigenstate Thermalisation Hypothesis (ETH), in which thermalisation is formulated via the properties of matrix elements of local operators in the energy eigenbasis. In this work we explore how ETH-violation mechanisms, including quantum many-body scars and Hilbert space fragmentation can affect Complete Hilbert Space Ergodicity. We find that the presence of these mechanisms leads to CHSE in decoupled subspaces, a phenomenon we call Hilbert Subspace Ergodicity, and which represents a protocol for constructing t -designs in subspaces.

I. INTRODUCTION

One of the key developments in statistical physics has been the introduction of ergodicity. A classical system is deemed to be ergodic if all of the available points in phase space are explored with equal probability over long timescales [1]. Such a notion however, *appears* to be inconsistent with dynamics of closed quantum systems, due to the constraints imposed by their unitary evolution. This has spurred significant research interest into how thermalisation can be understood in isolated quantum systems. The most widely accepted framework in this area is the eigenstate thermalisation hypothesis (ETH) [2–5]. The ETH states that the apparent thermalisation of quantum systems occurs due to the fact that eigenstates of large, generic many body systems appear indistinguishable from thermal states at the level of local observables. The formulation of ETH also led to the exploration of different forms of ETH-violation, which can be subdivided into *strong* and *weak ETH-violation*. The former include systems which exhibit integrability [6], many-body localisation (MBL) [7, 8], or strong Hilbert space fragmentation (HSF) [9–12], while the latter refer to systems with quantum many-body scars (QMBS) or weak HSF [13–19]. Both phenomena have also been investigated in digital quantum circuits [12, 20, 21], as these have been rising to prominence both due to their usage to probe interesting physical phenomena [22–25], as well as fascinating systems on their own [26–28].

In contrast to ETH, recently Pilatewski et al. [29] introduced the concept of Complete Hilbert Space Ergodicity (CHSE). This notion of ergodicity is defined at a dynamical level, and refers to the phenomenon by which

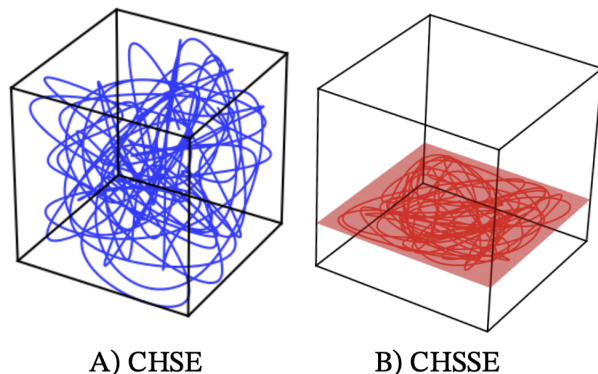

FIG. 1. Schematic representation for Complete Hilbert Space Ergodicity (A) vs. Complete Hilbert Space Ergodicity in a Sub-space (B). In the former, the system explores all of the available D -dimensional Hilbert space, represented by a 3-dimensional box. In the latter however, the system can only explore a B -dimensional subspace of the full Hilbert space, represented by a 2-dimensional horizontal slice. In the long time limit, the system represented in (A) will explore all regions within the box with equal probability, whereas the system in (B) will explore just the shaded surface.

any initial state will explore all other states within the Hilbert space with “equal probability” in the long time limit. This opens up several research questions. All examples of CHSE so far are for dynamics with global unitaries: does it persist when the dynamics have a local character, e.g., in local circuit models? What is the effect of ETH-violating mechanisms on the dynamics of the systems which would otherwise exhibit CHSE? What is the effect of symmetries?

We aim to answer these questions by analysing the dynamical properties of simple circuit models, composed of 2-local quantum gates, and showing the consequences of the presence of scars, fragmentation and symmetries. It

* logaric@tcd.ie

† gooldj@tcd.ie

‡ dooleysh@gmail.com

is accepted that in scarred and fragmented models certain initial states do not thermalise, and it immediately follows that such models cannot exhibit CHSE. However, the implications on the “thermalising” subspaces are not self-evident. Our main finding is that, in the presence of non-local conserved quantities, generic aperiodically driven systems can display CHSE within different subspaces, which we call Hilbert Subspace Ergodicity, schematically depicted in Fig. 1.

This paper is outlined as follows. In Section II we provide a brief overview of the ETH and two ETH-violation mechanisms, QMBS and Hilbert space fragmentation. We also outline the notion of complete Hilbert space ergodicity. Section III describes in detail the introduced notion of Complete Hilbert Subspace Ergodicity. In Section IV we present the model used for all our numerical evidence, and in Sec. V we show that it exhibits CHSE in the absence of any conserved quantities. We demonstrate the effects of scars in an otherwise CHSE system in Section VI, and the effects of fragmentation in Section VII. For completeness, we also cover the effect of symmetries in Section VIII. Finally, in Section IX we give a brief overview of results and their implications, as well as discuss potential avenues for future research.

II. BACKGROUND

A. Complete Hilbert Space Ergodicity

Suppose that a state $|\psi(0)\rangle$ in a D -dimensional Hilbert space undergoes unitary dynamics, $|\psi(t)\rangle = \hat{U}(t)|\psi(0)\rangle$. For concreteness, we assume discrete-time dynamics where $|\psi(t)\rangle = \hat{U}_t|\psi(t-1)\rangle$ propagates the system forward one time-step from $t-1$ to t and $\hat{U}(t) = \hat{U}_t\hat{U}_{t-1}\dots\hat{U}_1$. In analogy with the classical notion of ergodicity, CHSE means that given sufficient evolution time the quantum dynamics explores all of its available Hilbert space with equal likelihood. To be precise about the idea of “equal likelihood”, one must introduce a measure on the Hilbert space. The natural choice is the unique measure $d\phi$ that is invariant with respect to all unitary transformations, called the Haar measure. More formally then, CHSE means that [29]:

$$\lim_{T \rightarrow \infty} \frac{1}{T} f(|\psi(t)\rangle\langle\psi(t)|) = \int d\phi f(|\phi\rangle\langle\phi|), \quad (1)$$

for any initial state $|\psi(0)\rangle$ and for any integrable function f . In other words, if the system is CHSE then the long-time average of any observable quantity is indistinguishable from its Haar average.

In practice one cannot test Eq. 1 for all integrable functions f and it is more convenient to restrict to polynomial functions of degree k , which can always be computed using a limited set of moments. Following Ref. [29], we define the k 'th moment of the ensemble of states in the

timeseries $\{|\psi(t)\rangle\}_{t=0}^{T-1}$ as:

$$\hat{\rho}_T^{(k)} = \frac{1}{T} \sum_{t=0}^{T-1} (|\psi(t)\rangle\langle\psi(t)|)^{\otimes k}, \quad (2)$$

and the k 'th moment of the Haar ensemble of states as:

$$\hat{\rho}_{\text{Haar}}^{(k)} = \int d\phi (|\phi\rangle\langle\phi|)^{\otimes k}. \quad (3)$$

We note that the k 'th moment of the Haar ensemble can be computed exactly and has a closed form expression [30]:

$$\hat{\rho}_{\text{Haar}}^{(k)} = \frac{\sum_{\pi \in \mathcal{S}_k} \sum_{\alpha_1, \dots, \alpha_k} |\alpha_1, \alpha_2, \dots, \alpha_k\rangle\langle\alpha_{\pi(1)}, \dots, \alpha_{\pi(k)}|}{D(D+1)\dots(D+k-1)} \quad (4)$$

where \mathcal{S}_k is the permutation group of order k and $\{|\alpha_i\rangle\}_{i=1}^D$ is an orthonormal basis for the Hilbert space of dimension D .

We denote the Hilbert-Schmidt distance between $\hat{\rho}_T^{(k)}$ and $\hat{\rho}_{\text{Haar}}^{(k)}$ as:

$$\Delta_T^{(k)} = D_{HS}(\hat{\rho}_{\text{Haar}}^{(k)}, \hat{\rho}_T^{(k)}) = \|\hat{\rho}_{\text{Haar}}^{(k)} - \hat{\rho}_T^{(k)}\|_2^2, \quad (5)$$

where $\|\hat{X}\|_2 = \sqrt{\text{Tr}(\hat{X}^\dagger \hat{X})}$ is the Hilbert-Schmidt matrix norm [31]. Note that when originally introduced in Ref. [29], the CHSE was probed using the trace distance as a metric in Eq. 5. However, since the Hilbert-Schmidt distance can be used to upper bound the trace distance [32] and is significantly computationally cheaper to compute we will use the former. Now, the system is CHSE if $\Delta_\infty^{(k)} = 0$ for all k and for all initial states $|\psi(0)\rangle$.

Furthermore, in the case of a time-independent Hamiltonian, one can show that for $k \geq 2$ the trace distance to the Haar moments cannot be lower than [29]:

$$B(D) \equiv (D+1)^{-1} - (2D(D+1))^{-\frac{1}{2}}, \quad (6)$$

which one can adapt for the Hilbert-Schmidt distance. Since $D_{\text{Tr}}(\rho, \sigma)^2 \leq \frac{D}{4} D_{HS}(\rho, \sigma)$, we have that the lower bound for the Hilbert-Schmidt distance is:

$$\Delta_T^{(k)} \geq \frac{4B^2}{D}, \quad (7)$$

for time-independent Hamiltonian dynamics.

Another quantity to probe CHSE is the *ensemble entropy*, recently introduced in Ref. [33]. The key idea is to directly compare the states sampled by time evolution to states sampled from the Haar distribution. An ensemble is a collection of pure quantum states with associated probabilities:

$$\mathcal{E} = \{p_j, |\Psi_j\rangle\}, \quad (8)$$

where j can be a discrete value (corresponding to, for example, different measurement outcomes) or a continuous

one (such as time). In the case of discretised probability distributions we will use index j to refer to the different states, but in case of continuous variables we will use Ψ itself as the variable and write the ensemble as: $\mathcal{E} = \{P(\Psi), |\Psi\rangle\}$

We will denote the Haar ensemble as $\mathcal{E}_{Haar} = \{P^H(\Psi), |\Psi\rangle\}$, which will be the reference ensemble to compute the ensemble entropy. In the case of a discretised version of the Haar ensemble, we will use the notation $\mathcal{E}_{Haar} = \{p_j^H, |\Psi_j\rangle\}$. The ensemble generated by some aperiodic time evolution, also called the temporal ensemble, will be denoted as $\mathcal{E}_T = \{P^T(\Psi), |\Psi\rangle\}$ for the continuous version, and as $\mathcal{E}_T = \{p_j^T, |\Psi_j^T\rangle\}$ for discretised one. The ensemble entropy for this generated temporal ensemble, is then defined as the negative of the Kullback-Leibler divergence:

$$\text{Ent}(\mathcal{E}_T|\mathcal{E}_{Haar}) = - \int d\Psi P^T(\Psi) \log_2 \left(\frac{P^T(\Psi)}{P^H(\Psi)} \right). \quad (9)$$

This quantity contains information about the Hilbert-Schmidt distances for different moments k : if we confirm that the ensemble entropy is close to 0, that immediately implies that the moments will also be close to zero for any k . In practice, when numerically evaluating this measure we are using a finite set of states generated by the time evolution, $\{|\psi(t)\rangle\}_{t=0}^{T-1}$, which demands a discretisation of Eq. (9), replacing the integral with a discrete summation over a finite set of states and associated probabilities, which we term as discretised ensemble entropy (DEE):

$$\text{DEE}(\mathcal{E}_T|\mathcal{E}_{Haar}) = - \sum_{j=1}^M p_j^T \log_2 \left(\frac{p_j^T}{p_j^H} \right). \quad (10)$$

Further details about how we obtained the discretisation of the Haar ensemble and the numerical calculation can be found in the Appendix, Sec. C.

B. Quantum Many-Body Scars and Hilbert Space Fragmentation

One of the most important concepts to understand thermalisation of closed quantum systems is the eigenstate thermalisation hypothesis (ETH) [2–5]. This phenomenon has been extensively studied and verified both numerically [34, 35] and experimentally [36–39].

However, in a seminal experiment performed on a 51-qubit array of Rydberg atoms, it was found that thermalisation fails when the system is initialised in specific initial states [40]. The reason for the failure to thermalise is that the special initial states have a significant overlap with a small subset of ETH-violating eigenstates called quantum many body scars (QMBS) [13]. Since the first experiment, several more experiments have found evidence of QMBS in different systems [41, 42]. Also, a large amount of theoretical work has uncovered QMBS

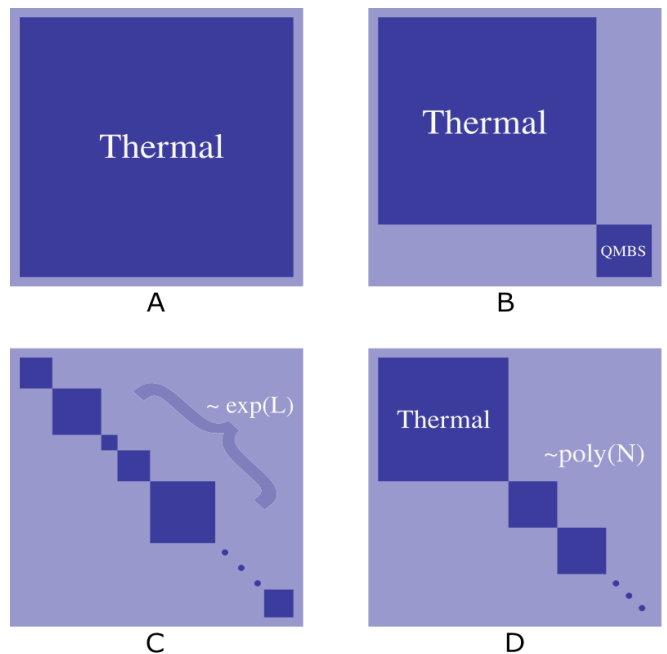

FIG. 2. Schematic representation of the dynamically decoupled Krylov subspaces for chaotic systems (A), systems with QMBS (B), Hilbert space fragmentation (C), and conventional symmetries (D). **A**: In the case of chaotic systems, all states are thermal. **B**: For scarred systems, the majority of the states are thermal, while there is a vanishingly small number of QMBS states, with respect to system size. **C**: For systems with Hilbert space fragmentation, the number of decoupled subspaces scales exponentially with system size. The fundamental difference between systems with fragmentation and symmetries (**D**), is that in the former the number of decoupled subspaces is exponential in system size, while in the latter it is constant or at most polynomial.

in various models, and laid the foundations for several scarring mechanisms [11]. Two of the most prominent approaches to encapsulate a wide range of scarred models are the projector-embedding [43] and the Spectrum Generating Algebra (SGA) formalisms [44].

Another mechanism of ETH-violation is the so-called Hilbert space fragmentation (HSF), first explicitly identified in fracton models [9, 45, 46]. In models with HSF, the Hilbert space “shatters” into exponentially many fragments, with respect to system size. Based on the scaling of the dimensions of these fragments, one can further distinguish between *strong* and *weak* fragmentation, which lead to *strong* and *weak* ETH-violation, respectively. Since weak HSF is very similar to QMBS in many aspects, it raised questions about the fundamental differences between these two phenomena. Ultimately, both of these mechanisms came to be understood within the framework of commutant algebras [10, 47].

Common to both QMBS and HSF is the property that, starting from simple-to-prepare initial states, the dynamics can fail to lead to thermalisation. This is because some simple initial states can be prepared that exist entirely

in a disconnected, non-thermal subspace: in the case of models with QMBS, the scar states are effectively decoupled from the rest of the spectrum, and in models with HSF, there are exponentially many of these decoupled subspaces. This is schematically depicted in Fig. 2. Therefore both the Hamiltonian \hat{H} and its corresponding unitary \hat{U} will have a block diagonal structure. We will refer to these dynamically decoupled subspaces, represented by the different “blocks”, as Krylov subspaces \mathcal{K}_α . They are defined through the time evolution from different simple-to-prepare initial states $|\psi_\alpha\rangle$ (e.g., computational basis states) [10]:

$$\mathcal{K}_\alpha \equiv \text{span}_t \{ \hat{U}^t |\psi_\alpha\rangle \} \quad (11)$$

Note that the time evolution of different initial states may generate the same subspace. Therefore the full Hilbert space can be expressed as:

$$\mathcal{H} = \bigoplus_{\alpha=1}^{\mathcal{N}_\mathcal{K}} \mathcal{K}_\alpha, \quad (12)$$

where $\mathcal{N}_\mathcal{K}$ is the number of unique Krylov subspaces.

The number of distinct Krylov subspaces $\mathcal{N}_\mathcal{K}$ distinguishes between QMBS and HSF, while the size of the largest subspace, D_{max} , distinguishes between *strong* and *weak* fragmentation. If we have a constant, or polynomial number of Krylov subspaces, the system contains QMBS. If however the number of Krylov subspaces is exponential in system size, we can conclude the system exhibits HSF. Furthermore, if the dimension of the largest subspace, D_{max} , is a non-vanishing fraction of the total Hilbert space dimension, $\lim_{N \rightarrow \infty} (D_{max}/\dim(\mathcal{H})) > 0$, it is an instance of weak fragmentation, whereas if this fraction is vanishing, $\lim_{N \rightarrow \infty} (D_{max}/\dim(\mathcal{H})) = 0$, it is an example of strong fragmentation [9]. Signatures of strong and weak violation of the ETH can also be observed in the growth of the bipartition entanglement entropy and the decay of the infinite temperature autocorrelator, which are discussed in more detail in the Appendices E, D.

III. COMPLETE HILBERT SUBSPACE ERGODICITY (CHSSE)

The original notion of CHSE was introduced for generic aperiodic drives without any conserved quantities. However, in the presence of (local or non-local) conserved quantities the Hilbert space may decouple into several Krylov subspaces \mathcal{K}_α . Because of this decoupling, it will be impossible to exhibit CHSE in the full Hilbert space. However, the system may still “explore” the subspaces with equal probability, which we term Complete Hilbert Subspace Ergodicity (CHSSE).

Consider some finite, D -dimensional Hilbert space. The dynamics of this system is governed either by some time dependent Hamiltonian $\hat{H}(t)$, with $t \in \mathbb{R}$, or a sequence of unitary operations \hat{U}_t , with $t \in \mathbb{N}$. The Hamiltonian or sequence of unitaries splits into $\mathcal{N}_\mathcal{K}$ dynamically

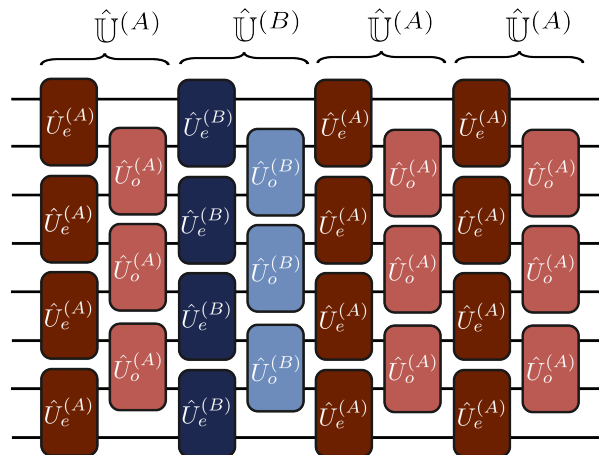

FIG. 3. The first 4 timesteps of our brickwork circuit for $N = 8$. The aperiodic sequence of unitaries $\hat{U}^{(A)}\hat{U}^{(A)}\hat{U}^{(B)}\hat{U}^{(A)}$ is determined through the Fibonacci word.

disconnected Krylov subspaces \mathcal{K}_α , but is otherwise completely generic. A system will display CHSSE provided that, starting in any initial state in some Krylov subspace subspace, $|\psi(t=0)\rangle \in \mathcal{K}_\alpha$, the k -th moment of the temporal ensemble, $\hat{\rho}_T^{(k)}$, will converge to the k -th moment of the Haar ensemble in the \mathcal{K}_α subspace, defined as:

$$\begin{aligned} \hat{\rho}_{\mathcal{K}_\alpha\text{-Haar}}^{(k)} &= \int_{|\phi\rangle \in \mathcal{K}_\alpha} d\phi (|\phi\rangle\langle\phi|)^{\otimes k} \\ &= \frac{\sum_{\pi \in \mathcal{S}_k} \sum_{\{\beta_i\}} |\beta_1, \dots, \beta_k\rangle\langle\beta_{\pi(1)}, \dots, \beta_{\pi(k)}|}{D'_\alpha (D'_\alpha + 1) \dots (D'_\alpha + k - 1)}, \end{aligned} \quad (13)$$

where π are permutation operators belonging to the permutation group \mathcal{S}_k , $D'_\alpha = \dim(\mathcal{K}_\alpha)$ and β_i label different basis states in the Krylov subspace. Note that in this case $d\phi$ is the unique unitary-invariant measure in the \mathcal{K}_α subspace. For time-independent Hamiltonian dynamics, due to the constraint of energy conservation (and the commutant algebra set), we again have a lower bound on the trace distance (and consequently also Hilbert Schmidt distance) between the k 'th moments of the temporal ensemble and the Haar ensemble in the decoupled subspaces. By the same argument as in Ref. [29], the bound on the trace distance between the $k \geq 2$ moments of the temporal ensemble generated by some initial state $|\psi_\alpha\rangle \in \mathcal{K}_\alpha$ and $\hat{\rho}_{\mathcal{K}_\alpha\text{-Haar}}^{(k)}$ will be $B(D'_\alpha)$.

IV. SETUP

In order to investigate the potential effects of the presence of scars and fragmentation on CHSE, we consider a chain of N qudits, labelled by $i \in \{0, 1, 2, \dots, N-1\}$, each with local Hilbert space dimension d . The chain of qudits evolves dynamically by a “brickwork” quantum circuit, made up of layers of two-qubit nearest-neighbour unitaries. We choose our brickwork circuit

so that each timestep is completely specified by the two “bricks” $\hat{U}_e = \exp(i\hat{H}_e)$ and $\hat{U}_o = \exp(i\hat{H}_o)$, where \hat{U}_e makes up the even layer $\hat{U}_e = \hat{U}_e \otimes \hat{U}_e \otimes \dots$ of the brickwork, and \hat{U}_o makes up the odd layer $\hat{U}_o = \mathbb{1} \otimes \hat{U}_o \otimes \hat{U}_o \otimes \dots$ (see Fig. 3 for an illustration). The system is then propagated forward one step in time by a unitary operator of the form:

$$\hat{U} = \hat{U}_o \hat{U}_e. \quad (14)$$

However, to generate CHSE, our circuit cannot be periodic in time. So, we introduce two different unitary propagators: $\hat{U}^{(A)}$ [specified by the local unitary bricks $\hat{U}_e^{(A)}$, $\hat{U}_o^{(A)}$] and $\hat{U}^{(B)}$ [specified by the bricks $\hat{U}_e^{(B)}$, $\hat{U}_o^{(B)}$]. We can apply these two different unitaries in a sequence that is deterministic but also completely aperiodic, through the Fibonacci word W_j , which is defined recursively [29]. We set two initial words $W_0 = 1$, $W_1 = 0$, and then construct longer words using the rule $W_{j+1} = W_j W_{j-1}$. This rule can be repeated infinitely many times to give W_∞ . Using W_∞ we then implement the discrete time evolution as a sequence of unitaries $\hat{U}^{(A)}$ or $\hat{U}^{(B)}$: at a given time t we apply $\hat{U}^{(A)}$ if the t -th symbol in W_∞ is 0, and $\hat{U}^{(B)}$ if it is 1. The resulting unitary then has the form:

$$\hat{U}(t) = \dots \hat{U}^{(B)} \hat{U}^{(A)} \hat{U}^{(B)} \hat{U}^{(A)} \hat{U}^{(B)} \hat{U}^{(A)} \hat{U}^{(B)} \hat{U}^{(A)}. \quad (15)$$

The brickwork circuit with this aperiodic sequence of gates will be used throughout this work. For the system to exhibit scars or fragmentation, below we impose specific constraints on the local bricks $\hat{U}_e^{(A)}$, $\hat{U}_o^{(A)}$, $\hat{U}_e^{(B)}$ and $\hat{U}_o^{(B)}$.

In Ref. [29] it was shown that for $\hat{U}^{(A)}$ and $\hat{U}^{(B)}$ without the local structure discussed above (e.g., they are generic global unitaries on the entire Hilbert space), this Fibonacci driving leads to CHSE. Next, we will verify that the model is still CHSE, even when the unitaries $\hat{U}^{(A)}$ and $\hat{U}^{(B)}$ have the local structure illustrated in Fig. 3.

V. CHSE IN A BRICKWORK MODEL WITH GENERIC LOCAL UNITARIES

First, we would like to show that our circuit model (as illustrated in Fig. 3) is CHSE for generic instances of the local unitary bricks. We provide a detailed argument in A, and in this section we provide numerical evidence. To show this, we consider a simple instance of the model: we use $N = 4$ qubits ($d = 2$) with open boundary conditions. The dynamics are defined by the four local unitary bricks $\{\hat{U}_e^{(A)}, \hat{U}_o^{(A)}, \hat{U}_e^{(B)}, \hat{U}_o^{(B)}\}$. Each of the local unitaries is created using a random Hermitian generator $\hat{H}_{o/e}^{(A/B)}$, where the real and imaginary parts of the matrix elements are sampled uniformly from the interval $[0, 1)$, and then constructing the unitary as

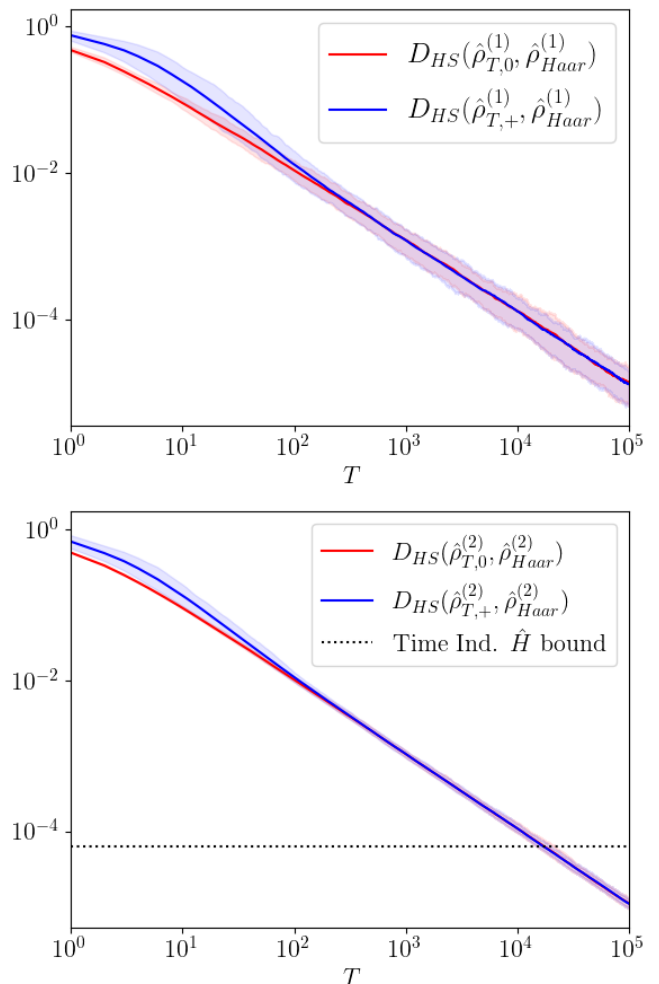

FIG. 4. Hilbert Schmidt distance between the Haar moments and the temporal ensemble moments for $k = 1$ (TOP) and $k = 2$ (BOTTOM). The results are averaged over 100 different instances of $\{\hat{U}^{(A)}, \hat{U}^{(B)}\}$, with the lines corresponding to the average distances, and the shaded areas represent the 10-90th percentile range. The red plot corresponds to the initial state $|\psi(0)\rangle = |0\rangle^{\otimes N}$, and the blue one to $|\psi(0)\rangle = |+\rangle^{\otimes N}$. The dotted line in the lower plot for $k = 2$ represents the lower bound for time independent Hamiltonians, and is surpassed for both initial states.

$\hat{U}_{o/e}^{(A/B)} = \exp(-i\hat{H}_{o/e}^{(A/B)})$. We sample over 100 different instances of the circuit, using different sets of local unitaries, $\{\hat{U}_e^{(A)}, \hat{U}_o^{(A)}, \hat{U}_e^{(B)}, \hat{U}_o^{(B)}\}$, for each of them.

We then compute the Hilbert-Schmidt distances to the Haar moments for $k = 1, 2$, using two different initial states: $|\psi(0)\rangle = |0\rangle^{\otimes N}$ and $|\psi(0)\rangle = |+\rangle^{\otimes N}$. At each time-step we compute the first and second moments of the temporal ensemble, $\hat{\rho}_{T,0/+}^{1/2}$, where the second subscript denotes the corresponding initial state.

The results are presented in Fig. 4. As a first check, for $k = 1$ we observe that the ensembles generated from both the $|\psi(0)\rangle = |0\rangle^{\otimes N}$ and the $|\psi(0)\rangle = |+\rangle^{\otimes N}$ initial states converge to the first moment of the Haar ensemble.

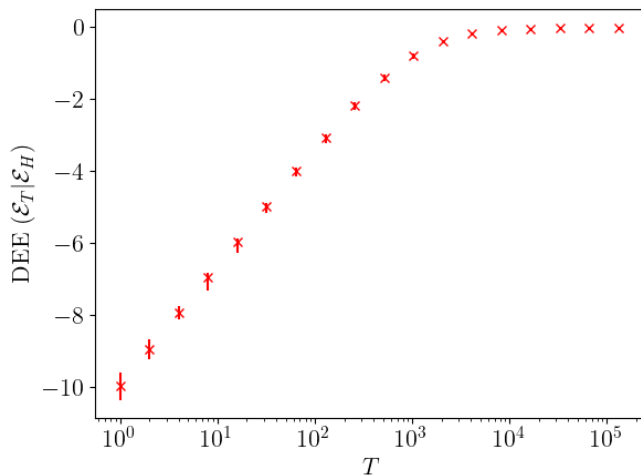

FIG. 5. Discretised ensemble entropy for the dynamics generated by a generic brickwork circuit. Note that we have computed it for the initial state $|0\rangle^{\otimes N}$, and for a single instance of $\{\hat{U}^{(A)}, \hat{U}^{(B)}\}$. We compute the DEE using 100 different instances of sets of reference states $\{|\psi_j\rangle\}$, with $M \approx 1000$ states in each set. The error bars represent the spread between minimum and maximum values, and the crosses display the mean. The discretised ensemble entropy is converging to 0 as the number of states generated by the dynamics, T , is increased.

ble. For both initial states we also observe a power law decay of the distances, $\Delta_T^k \sim T^{-1/2}$, which was already observed in Ref. [29]. These results for $k = 1$ are not particularly surprising, since any Floquet driving without energy conservation will “heat up” any initial state to the infinite temperature state $\hat{\rho} = \frac{1}{D}\hat{\mathbb{I}}$, which is equal to the first Haar moment: $\hat{\rho}_{Haar}^{(1)} = \int d\phi |\phi\rangle\langle\phi| = \frac{1}{D}\hat{\mathbb{I}}$. To numerically investigate CHSE we should check the distance between $\hat{\rho}_T^{(k)}$ and $\hat{\rho}_{Haar}^{(k)}$ for higher moments $k > 1$.

Comparing the $k = 2$ moments of the temporal and Haar ensembles in Fig. 4, we again see strong evidence for CHSE. Both initial states give very similar long time behaviour, overlapping almost perfectly for times $T > 10^2$. Interestingly, they display even smaller variation between the different instances of the model than for the $k = 1$ moment, with all of the results in the 10 – 90 percentile range strongly concentrated around the mean values. It is clear that the distances to the Haar moment go below the bound for time-independent Hamiltonians (Eq. 7) [29].

For conclusive evidence that these models do exhibit CHSE one would have to go to higher moments $k > 2$ and longer times T . However, our numerical results for $k = 2$, together with the argument in A, strongly suggest CHSE for generic 2-local brickwork circuit models. To corroborate this further beyond the $k = 2$ moment, we also compute the DEE for the initial state $|0\rangle^{\otimes N}$, shown in Fig. 5. The DEE converges to 0 with increasing temporal set size T , as expected for CHSE. This evidence for CHSE in the brickwork circuit is our first result.

VI. CHSSE THROUGH QUANTUM MANY-BODY SCARS

To investigate the effect of ETH-violation on a model which is otherwise CHSE, we first embed QMBS in the brickwork circuit model described in the previous section. To do this we employ the projector embedding method, which was first developed for time-independent Hamiltonian models [43] and later adapted for quantum circuits [20]. The key step is to modify the two-qudit gates, $\hat{U}_{e/o}^{A/B}$, so that they instead are of the form:

$$\hat{U}_{e/o}^{(A/B)} = \exp\{i\hat{P}\hat{H}_{e/o}^{(A/B)}\hat{P}\}, \quad (16)$$

where \hat{P} are two-qudit projectors, i.e., $d^2 \times d^2$ matrices for which $\hat{P}^2 = \hat{P}$. The main idea of the projectors is to ensure that the unitaries act trivially on a set of chosen target states, while evolving the states outside of this set by some complex dynamics.

The projector on the full Hilbert space, corresponding to the local projector \hat{P} acting on the neighbouring sites n and $n + 1$, is denoted $\hat{\mathbb{P}}_{n,n+1} \equiv \hat{\mathbb{I}}_{0,n-1} \otimes \hat{P} \otimes \hat{\mathbb{I}}_{n+2,N-1}$, where $\hat{\mathbb{I}}_{i,j}$ is the identity acting on all qudits in the range $i, i + 1, \dots, j - 1, j$. The set of target states then consists of all the states that are simultaneously annihilated by all projectors:

$$\mathcal{T} = \{|\psi_{S_i}\rangle : \hat{\mathbb{P}}_{n,n+1}|\psi_{S_i}\rangle = 0, \forall n\}. \quad (17)$$

This protocol of embedding QMBS in a circuit model effectively creates dynamically disconnected subspaces. In case the model supports L scar states, the full Hilbert space, \mathcal{H}_F , will consist of $L + 1$ disconnected subspaces, where L of those will be scar subspaces containing a single state, $\mathcal{H}_{S_i} = \{|\psi_{S_i}\rangle\langle\psi_{S_i}|\}$, such that:

$$\mathcal{H}_F = \mathcal{H}_N \oplus \bigoplus_{i=1}^L \mathcal{H}_{S_i} = \mathcal{H}_N \oplus \mathcal{H}_S, \quad (18)$$

where we have collected all the scar states into \mathcal{H}_S for brevity, and the \mathcal{H}_N contains all of the non-scar states. Note that in this specific circuit construction, all the QMBS are not interacting between themselves, but one could easily construct non-product QMBS by using another layer of unitaries corresponding to classical cellular automata [48].

This embedding process will not only ensure that the scar states do not thermalize (in any framework, neither CHSE nor ETH). However, it will not impact just the states in \mathcal{H}_S , but the evolution of states in \mathcal{H}_N as well. Since the two subspaces are disconnected by construction, the k -th moment of the temporal ensemble, $\hat{\rho}_T^{(k)}$, generated by the dynamics starting from any initial state $|\phi_0\rangle \in \mathcal{H}_N$ will not be converging to $\hat{\rho}_{Haar}^{(k)}$ in the full Hilbert space. However, since the used unitaries $\hat{U}^{(A/B)}$ are quite generic, we expect it to converge to the Haar averaged state in the non-scar subspace, exhibiting CHSSE within it, as described in Sec. III

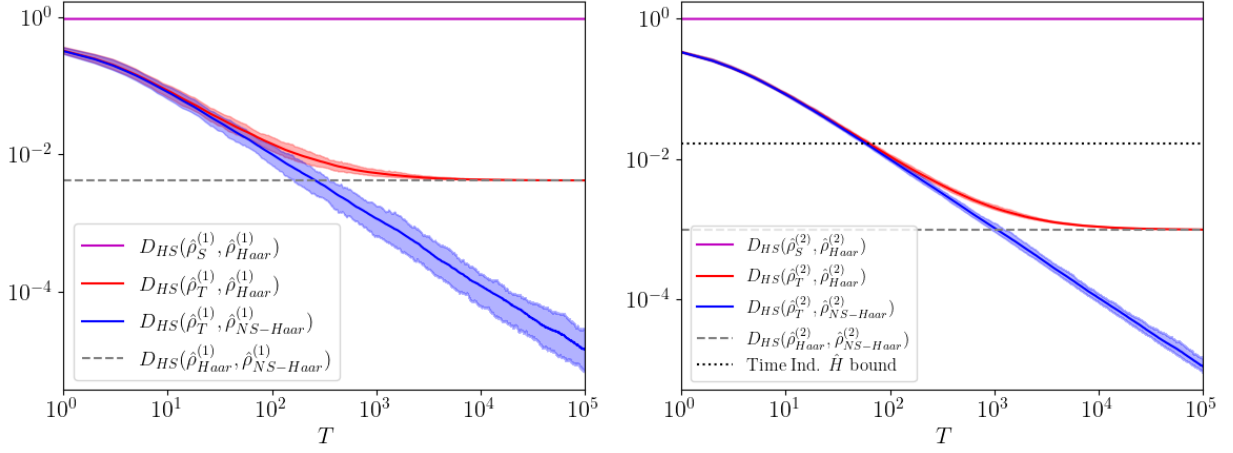

FIG. 6. Effect of embedding a single QMBS into a brickwork model which otherwise displays CHSE. The results are obtained by using 100 different instances of $\{\hat{U}^{(A)}, \hat{U}^{(B)}\}$ LEFT: Distance between the first moments of the temporal ensembles and the Haar ensemble. RIGHT: Distance between the second moments of the temporal ensembles and the Haar ensemble. The violet, constant line represents the results for the initial scar state, $|S_1\rangle = |0\rangle^{\otimes N}$. Since it is invariant under the applied unitaries, the generated first ($\hat{\rho}_S^{(1)}$) and second ($\hat{\rho}_S^{(2)}$) are constant, and so is their distance to the respective Haar moments. The red line represents the average distance between the moments of the temporal ensemble and Haar ensemble for the $|1\rangle^{\otimes N}$ initial state, and the shaded region represents the 10-90 percentile region. We clearly see that for both first and second moments, this distance is bounded from below. Due to the separation of the scar and non-scar subspaces, this is expected, as any initial state in the latter cannot explore all of Hilbert space. The dashed line represents the distances between the full Hilbert space Haar ensemble and non-scar subspace ensemble for first and second moments, and clearly gives the lower bound achievable for the non-scar initial states. This is further evidenced by the distance between the generated temporal ensemble and non-scar subspace Haar ensemble for first (left) and second (right) moments, shown in the blue plots. Note that again the line is the average over 100 iterations and the shaded areas represent the 10 - 90 percentile. This distance clearly becomes arbitrarily small in the long time limit for both $k = 1$ and $k = 2$, thus indicating that the models display CHSSE in the non-scar subspace.

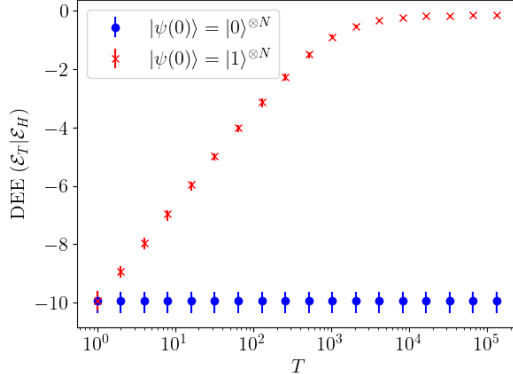

FIG. 7. Discretised ensemble entropy for the dynamics generated by a brickwork circuit with a single embedded scar. Note that we have computed it for the initial scar state $|0\rangle^{\otimes N}$ [blue] as well as a state outside the scar subspace $|1\rangle^{\otimes N}$ [red]. We use a single instance of $\{\hat{U}^{(A)}, \hat{U}^{(B)}\}$. The DEE is computed using 100 different instances of sets of reference states $\{|\psi_j\rangle\}$, with $M \approx 1000$ states in each set. The error bars represent the spread between minimum and maximum values, and the crosses/dots display the mean. Since the scar state is unaffected by the dynamics the DEE is constant, saturated close to the minimum value of $-\log_2 M$. However, the non-scar initial state is saturating around -0.1 , due to inability to sample any overlaps with the scar state.

In order to demonstrate the effect of embedding scars into the system, we again consider a simple setup of $N = 4$ qubits. For the construction of local unitaries, we again generate four different Hermitian operators for each of the 100 different instances, in the same manner as in Sec. V. However, the local unitaries are modified, as described in Eqn. (16). The used local projector is:

$$\hat{P} = \hat{\mathbb{I}} - |00\rangle\langle 00|, \quad (19)$$

which ensures that any of the use 2-local unitaries leaves the $|00\rangle$ state invariant. The use of this projector leads to a single scar, $|S_1\rangle = |0\rangle^{\otimes N}$. The scar state will be invariant under the action of both $\hat{U}^{(A)}$ and $\hat{U}^{(B)}$, whereas any other, non-overlapping, state will undergo highly non-trivial dynamics.

In order to verify this, we perform the time evolution and obtain the temporal ensemble with two different initial states, the scar state $|S_1\rangle = |0\rangle^{\otimes N}$ and a state in the non-scar subspace $|\psi_{NS}\rangle = |1\rangle^{\otimes N}$. For the former we compute the distance for the $k = 1, 2$ moments with respect to the Haar moments for the full Hilbert space. For the non-scar initial state we compute the same metrics, but we also compute the distance with respect to the the first and second moments of the Haar ensemble in the non-scar subspace, denoted as $\hat{\rho}_{NS-Haar}^{(k)}$. The results are displayed in Fig. 6.

From the plots we can clearly see the difference in the dynamics for an initial scar state and non-scar state. For the $|0\rangle^{\otimes N}$ scar we clearly see that it is not affected by any of the unitaries in the sequence, therefore $|\psi(t)\rangle = |0\rangle^{\otimes N}$ and the two moments for the temporal ensemble will be constant as well: $\hat{\rho}_S^{(1)} = |0\rangle^{\otimes N}\langle 0|^{\otimes N}$, $\hat{\rho}_S^{(2)} = [|0\rangle^{\otimes N}\langle 0|^{\otimes N}]^{\otimes 2}$. Therefore the distances between these moments and the Haar moments $\hat{\rho}_{Haar}^{(k=1,2)}$ will be constant, as demonstrated.

For the non-scar state $|1\rangle^{\otimes N}$ we see that the generated first and second moments of the temporal ensemble, $\hat{\rho}_T^{k=1,2}$, are clearly getting closer to the respective moments of the Haar ensemble. However, due to the separation of the scar subspace, this initial state will be constrained to exploring only the non-scar subspace. This becomes evident when comparing it to the Haar ensembles for the two moments. We see that the distances are clearly bounded by the moments of the Haar ensembles in the non-scar subspace. When comparing the generated temporal ensembles to the subspace Haar ensembles we see that they become arbitrarily small, and effectively reproduce the behaviour observed for a CHSE model, as shown in Fig. 4. The observed results for the time evolution of $\Delta^{(1)}$ and $\Delta^{(2)}$ can be directly related to the commutant algebra of the constructed model, which is described in more detail in the Appendix, Sec. B. We also compute the discretised ensemble entropy starting in the scar as well as a non-scar state, displayed in Fig. 7. We can clearly see that the DEE is independent of temporal sample size for the initial scar state. However, starting in a non-scar state the DEE is converging to ~ -0.1 for increasing T .

Note that, the presence of CHSSE in the non-scar subspace also directly implies that the constructed states are forming t -designs within that subspace [29, 49]. However, as demonstrated by the numerical results, the convergence rates to form t -designs are rather slow.

Here we have considered the simple example of a single scar, but the obtained results can be relatively easily generalised to different numbers of scars. The only difference would be that the non-scar subspace would become smaller as the size of the scarred subspace is increased. We provide further numerical evidence for these examples in the Appendix, Sec. H.

VII. CHSSE THROUGH HILBERT SPACE FRAGMENTATION

Another known mechanism of ETH-violation is HSF. Here we modify the model presented in Sec. IV such as to observe *strong* Hilbert space fragmentation. In the distinction between weak and strong violation of ETH discussed in the introduction, this mechanism corresponds to strong ETH-violation, due to exponentially many vanishingly small subspaces.

A known model that displays strong Hilbert space frag-

mentation for local Hilbert space dimension $d \geq 3$ is the so-called pair-flip model [50], which was originally studied as a Hamiltonian model, but can also be implemented as a gate model. In this picture, the local unitary bricks have the form:

$$\hat{U}^{PF} = \sum_{a,b} U_{ab}^{PF} |aa\rangle\langle bb| + \sum_{a \neq b} e^{i\phi_{ab}} |ab\rangle\langle ab|, \quad (20)$$

where U_{ab}^{PF} are elements of a Haar random unitary drawn from $U(d)$ and ϕ_{ab} are random phases drawn uniformly from $[0, 2\pi)$. Effectively, this model has the constraint that two neighbouring sites can change their state if and only if they are in the same state, as seen in the first term. The second term implements an arbitrary phase on pairs of states where two sites differ, in order to break any undesirable symmetries.

The condition that states are allowed to flip only if one of their neighbours is in the same state imposes a strong constraint on what parts of the Hilbert space are available to any initial state. Suppose we have a chain of N qudits with local Hilbert space dimension d . If the chain is initialised in a product state where none of the neighbouring sites are in the same state, it cannot transition to any other product state, but can only acquire a time dependent phase, and the dynamics becomes trivial. The number of such states is $d(d-1)^{N-1}$, i.e. there are $d(d-1)^{N-1}$ subspaces of dimension 1. Counting the total number of subspaces and their respective dimensions is highly non-trivial and we refer the reader to Refs. [10, 12, 50]. It can be shown that the number of disconnected subspaces in the pair flip model with $d > 2$ is:

$$\mathcal{N}_{\mathcal{K}}(N, d) = \frac{(d-1)^{N+1} - 1}{d-2}, \quad (21)$$

which is exponential in system size N , but still exponentially smaller than the total Hilbert space dimension $D = d^N$. Importantly, it can also be shown that the size of the largest subspace for even number of sites N is:

$$|\mathcal{K}_0(N, d)| = d^N \left(1 + \frac{1}{2} \sum_{j=1}^{N/2} d^{-2j} \binom{1/2}{j} (-1)^j (2\sqrt{d-1})^{2j}\right), \quad (22)$$

which is an exponentially vanishing fraction of the total Hilbert space, i.e. $\lim_{N \rightarrow \infty} (|\mathcal{K}_0(N, d)|/d^N) = 0$. Since the ratio of the dimension of the largest Krylov subsector vs the dimension of the full Hilbert space tends to 0, this is a form of *strong* Hilbert space fragmentation.

As seen in the discussion about a scarred system in VI, the scar subspace remained stationary, while a state in the non-scar subspace was displaying CHSSE, exploring all of the available Hilbert space. This gives us good intuition on the consequences of fragmentation. In the case of fragmented models, set up in way analogous to universal models with CHSE, we expect to see CHSSE for each of the initial states in their Krylov subspaces.

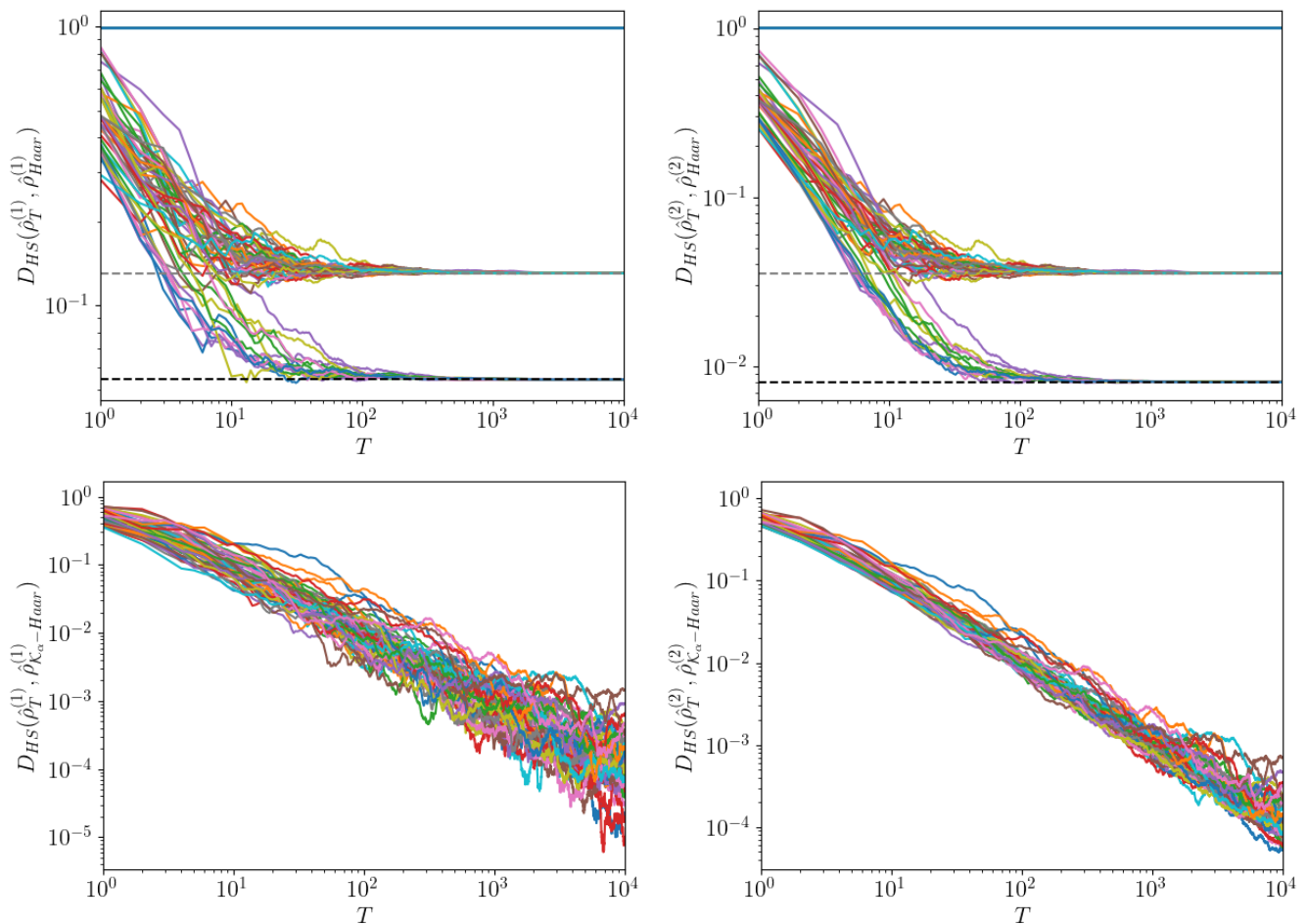

FIG. 8. TOP: Hilbert Schmidt distance between the first (LEFT) and second (RIGHT) moments of the Haar ensemble, and the temporal ensemble generated by the Fibonacci layered pair-flip model, with $N = 4$, $d = 3$. We test all possible initial computational basis states to generate the temporal ensembles with a single instance of $\{\hat{U}^{(A)}, \hat{U}^{(B)}\}$. For the frozen states, the distance to the first Haar moment stays constant, at around $\mathcal{O}(1)$. The 42 states belonging to 7-dimensional subspaces decay and eventually saturate at the distance between the full Hilbert space Haar moments, and the Haar moments in a 7-dimensional subspace (grey dashed line). The states belonging to the largest, 15-dimensional Krylov subspace on the other hand saturate at a lower bound (black dashed line), due to the larger subspace. BOTTOM: Hilbert Schmidt distance the temporal ensemble and the subspace-restricted Haar ensemble for the first (LEFT) and second (RIGHT) moments. We test all initial computational basis states, apart from the frozen ones. All of the initial states are converging to the $\hat{\rho}_{K_\alpha}^{(k)}$ in their respective subspaces, thus displaying CHSSE in them.

In order to verify this we perform numerics analogous to the ones performed for models in Secs. V and VI.

We consider a system of $N = 4$ qutrits, $d = 3$. For these parameters, due to the constraints of the pair-flip model [12], we expect 24 frozen states, 6 distinct 7-dimensional subspaces, and one 15-dimensional subspace. The system undergoes dynamics defined by applying two global unitaries, $\hat{U}^{(A)}$ and $\hat{U}^{(B)}$. These are defined as a combination of an even and odd layers of 2-local unitaries as defined in (14). All of the individual local unitaries have the form as displayed in Eq. (20), but with different values for the free parameters $\{U_{ab}^{PF}, \phi_{ab}\}$ for each of the four bricks $\{\hat{U}_e^{(A)}, \hat{U}_o^{(A)}, \hat{U}_e^{(B)}, \hat{U}_o^{(B)}\}$ in our brickwork circuit.

We first construct the temporal ensembles for all 81 distinct initial computational basis states, and compare the first and second moments to the Haar ensemble, as shown in Fig. 8. Analogously to the QMBS state, the frozen states lead to a temporal ensemble for which all moments stay at a distance of $\mathcal{O}(1)$ with respect to the Haar ensemble. However, the rest of the computational basis states exhibit CHSSE in their respective subspaces, as demonstrated by their convergence to the subspace bounds. Note that the larger the subspace, the lower the bound that the temporal ensembles will converge to. Similarly, the fragmentation of the Hilbert space can also be observed in the DEE as a function of time, displayed in Fig. 9, where we only used the initial state $|0\rangle^{\otimes N}$, which belongs to the largest Krylov subspace. The DEE

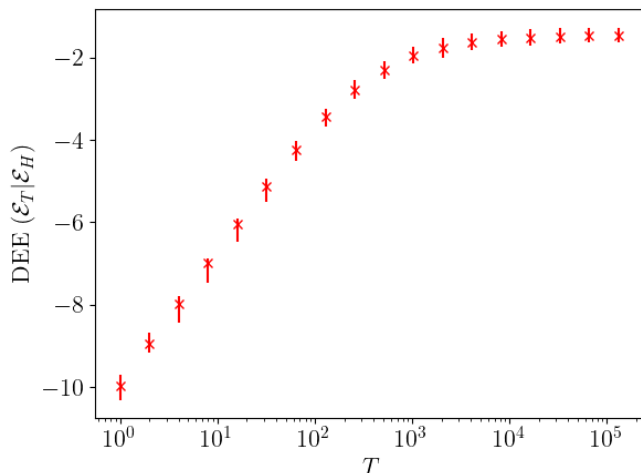

FIG. 9. Discretised ensemble entropy for the dynamics generated by a brickwork circuit with the pair-flip unitary. Note that we have computed it for the initial state $|0\rangle^{\otimes N}$, which belongs to the largest, 15-dimensional subspace. We use a single instance of $\{\hat{U}^{(A)}, \hat{U}^{(B)}\}$. The DEE is computed using 100 different instances of sets of reference states $\{|\psi_j\rangle\}$, with $M \approx 1000$ states in each set. The lines represent the spread between minimum and maximum values, and the crosses display the mean. In contrast to a generic brickwork circuit, the DEE in a fragmented model saturates well below 0, demonstrating the absence of ergodicity over the full Hilbert space.

is converging to approximately -2 , as expected due to the inability to sample many states in the full Hilbert space.

VIII. ROLE OF SYMMETRIES

Note that, in the ETH framework, the presence of a few local symmetries in a model is generally not classified as an ETH-violation mechanism, as we still observe thermal behaviour within the symmetry subsectors. However, to complete the picture, we also demonstrate the effect of local symmetries on an otherwise CHSE model. In order to showcase that, we again use the 2-local unitaries as defined in Eqn. (20), but in a system with $d = 2$. As any operator can only flip neighboring sites from $|00\rangle$ to $|11\rangle$ (and vice versa), one can deduce that in this case the model will have a global $U(1)$ symmetry, corresponding to the staggered magnetisation, \hat{M}_S :

$$\hat{M}_S = \sum_{j=1}^N (-1)^j |\alpha\rangle_j \langle \alpha|_j. \quad (23)$$

Therefore, for system size N , we will get a splitting into $N + 1$ subspaces, with dimensions $\binom{N}{j}$, where $j = 0, 1, \dots, N$ labels the different subspaces. We perform similar numerical simulations as for the models in Sec. VI, VII, with $N = 4$ and up to $T = 10^4$. The results are

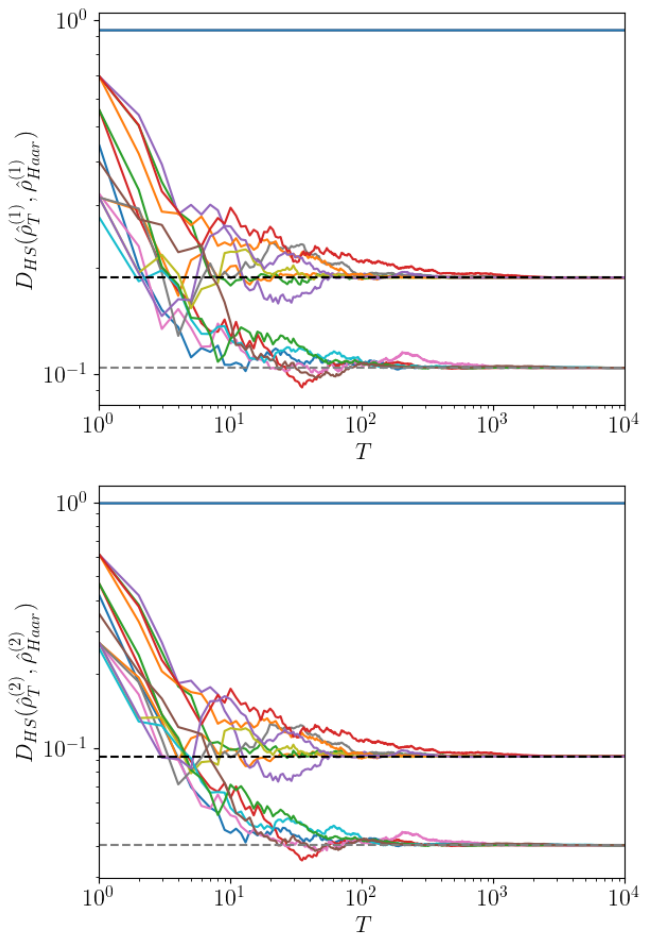

FIG. 10. Hilbert Schmidt distance between the first (TOP) and second (BOTTOM) moments of the Haar ensemble, and the temporal ensemble generated by the Fibonacci layered pair-flip model, with $N = 4$, $d = 2$, for a single instance of $\{\hat{U}^{(A)}, \hat{U}^{(B)}\}$. We test all possible initial product states to generate the temporal ensembles. For the two invariant states, the distance to the first Haar moment stays constant, at around $\mathcal{O}(1)$. The 8 states belonging to 4-dimensional subspaces decay and eventually saturate at the distance between the full Hilbert space Haar moments, and the Haar moments in a 4-dimensional subspace (grey dashed line). The states belonging to the largest, 6-dimensional Krylov subspace on the other hand saturate at a lower bound (black dashed line), due to the larger available subspace.

displayed in Figs. 10 and 11. This effect can also be observed in the DEE as a function of T for a state belonging to the largest symmetry subspace, as shown in Fig. 12. The DEE saturates to a bound set by the size of the largest subspace in the long T limit. Additional numerical results are presented in the Appendix, Sec. F. Similarly to the fragmented case, we observe almost perfect convergence to the Haar moments in symmetry subspaces. This indicates that starting in any initial state belonging to a symmetry subsector, we will form t -designs within that subspace for sufficiently long times.

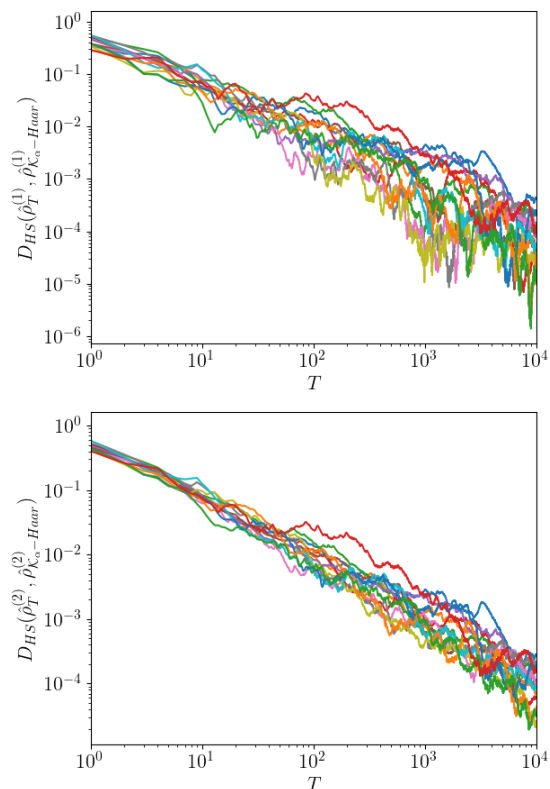

FIG. 11. Hilbert Schmidt distance the temporal ensemble and the subspace-restricted Haar ensemble for the first (TOP) and second (BOTTOM) moments. We test all possible initial computational basis states, apart from the frozen ones. All of the initial states are converging to the $\rho_{\mathcal{K}_\alpha}^{(k)}$ in their respective subspaces, thus displaying CHSSE in them.

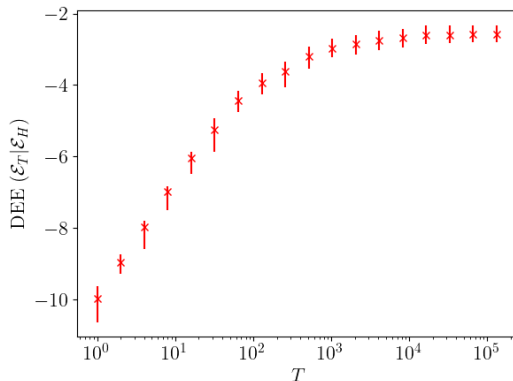

FIG. 12. Discretised ensemble entropy for the dynamics generated by a brickwork circuit with a $U(1)$ symmetry corresponding to the staggered magnetisation. Note that we have computed it for the initial state $|0\rangle^{\otimes N}$, belonging to the largest symmetry subspace, and for a single instance of $\{\hat{U}^{(A)}, \hat{U}^{(B)}\}$. We compute the DEE using 100 different instances of sets of reference states $\{|\psi_j\rangle\}$, with $M \approx 1000$ states in each set. The lines represent the spread between minimum and maximum values, and the crosses display the mean. We notice the DEE saturating well below the 0 bound expected for completely Hilbert space ergodic dynamics.

IX. CONCLUSION

Complete Hilbert Space Ergodicity has extended the notion of ergodicity from classical to certain quantum systems undergoing aperiodic dynamics. It can thus be seen as complementary to the ETH, which has been conceptually crucial for our understanding of thermalisation in Hamiltonian and Floquet systems. Through many experiments and numerical demonstrations, different ETH violating mechanisms have been identified, including QMBS and HSF.

In this work, we presented the effects of these ergodicity breaking mechanisms on systems which otherwise display CHSE. In both scarred and fragmented models, the presence of non-local conserved quantities, leads to a decoupling between different subspaces of the full Hilbert space. Thus, different initial states are constrained to their respective subspaces, and we do not observe CHSE in the full Hilbert space, but we do observe CHSE in their respective Krylov subspaces. The scarring and fragmentation mechanisms in the considered aperiodic models may also be detected via the same measures that have been used to verify their presence in Hamiltonian and Floquet models, such the growth of bipartite entanglement entropy and the decay of the autocorrelator.

The presented work opens up further avenues and questions for future research. We observe that one can construct Haar ensembles in some designated subspaces, This protocol could be adapted to construct them in decoherence free subspaces, akin to the prescription described in [51]. The constructed t -designs could have practical applications in fault tolerant quantum computers. Unfortunately, we observe that the temporal ensembles approximate Haar ensembles only at late times. Hence, it remains an important open problem to investigate the convergence rates for the different k -moments.

ACKNOWLEDGMENTS

We acknowledge helpful conversations Alessandro Summer, Alex Nico-Katz, Federica Maria Surace, and Nathan Keenan. J.G. and L.L. acknowledge financial support by Microsoft Ireland. J.G. is supported by a SFI-Royal Society University Research Fellowship. S.D. acknowledges support through the SFI-IRC Pathway Grant 22/PATH-S/10812.

- [1] Ludwig Boltzmann, *Vorlesungen über Gastheorie* (Leipzig, J. A. Barth, 1896).
- [2] J. M. Deutsch, “Quantum statistical mechanics in a closed system,” *Phys. Rev. A* **43**, 2046–2049 (1991).
- [3] Mark Srednicki, “Chaos and quantum thermalization,” *Physical Review E* **50**, 888–901 (1994).
- [4] Marcos Rigol, Vanja Dunjko, and Maxim Olshanii, “Thermalization and its mechanism for generic isolated quantum systems,” *Nature* **452**, 854–858 (2008).
- [5] Joshua M Deutsch, “Eigenstate thermalization hypothesis,” *Reports on Progress in Physics* **81**, 082001 (2018).
- [6] Pasquale Calabrese, Fabian H.L. Essler, and Giuseppe Mussardo, “Introduction to ‘quantum integrability in out of equilibrium systems’,” *J. Stat. Mech.*, 064001 (2016).
- [7] Rahul Nandkishore and David A Huse, “Many-body localization and thermalization in quantum statistical mechanics,” *Annu. Rev. Condens. Matter Phys.* **6**, 15 (2015).
- [8] Dmitry A. Abanin, Ehud Altman, Immanuel Bloch, and Maksym Serbyn, “Colloquium: Many-body localization, thermalization, and entanglement,” *Rev. Mod. Phys.* **91**, 021001 (2019).
- [9] Pablo Sala, Tibor Rakovszky, Ruben Verresen, Michael Knap, and Frank Pollmann, “Ergodicity breaking arising from hilbert space fragmentation in dipole-conserving hamiltonians,” *Physical Review X* **10** (2020), 10.1103/physrevx.10.011047.
- [10] Sanjay Moudgalya and Olexei I. Motrunich, “Hilbert space fragmentation and commutant algebras,” *Physical Review X* **12** (2022), 10.1103/physrevx.12.011050.
- [11] Sanjay Moudgalya, B Andrei Bernevig, and Nicolas Regnault, “Quantum many-body scars and hilbert space fragmentation: a review of exact results,” *Rep. Prog. in Phys.* **85**, 086501 (2022).
- [12] Yiqiu Han, Xiao Chen, and Ethan Lake, “Exponentially slow thermalization and the robustness of hilbert space fragmentation,” (2024), arXiv:2401.11294 [quant-ph].
- [13] C. J. Turner, A. A. Michailidis, D. A. Abanin, M. Serbyn, and Z. Papić, “Weak ergodicity breaking from quantum many-body scars,” *Nat. Phys.* **14**, 745 (2018).
- [14] Zlatko Papić, “Weak ergodicity breaking through the lens of quantum entanglement,” in *Entanglement in Spin Chains: From Theory to Quantum Technology Applications* (Springer, New York, 2022) pp. 341–395.
- [15] Anushya Chandran, Thomas Iadecola, Vedika Khemani, and Roderich Moessner, “Quantum many-body scars: A quasiparticle perspective,” *Annu. Rev. Condens. Matter Phys.* **14**, 443 (2023).
- [16] Maksym Serbyn, Dmitry A. Abanin, and Zlatko Papić, “Quantum many-body scars and weak breaking of ergodicity,” *Nature Physics* **17**, 675–685 (2021).
- [17] Jean-Yves Desaulles, Francesca Pietracaprina, Zlatko Papić, John Goold, and Silvia Pappalardi, “Extensive multipartite entanglement from su(2) quantum many-body scars,” *Phys. Rev. Lett.* **129**, 020601 (2022).
- [18] Shane Dooley, “Robust quantum sensing in strongly interacting systems with many-body scars,” *PRX Quantum* **2**, 020330 (2021).
- [19] Shane Dooley, Silvia Pappalardi, and John Goold, “Entanglement enhanced metrology with quantum many-body scars,” *Phys. Rev. B* **107**, 035123 (2023).
- [20] Leonard Logarić, Shane Dooley, Silvia Pappalardi, and John Goold, “Quantum many-body scars in dual-unitary circuits,” *Phys. Rev. Lett.* **132**, 010401 (2024).
- [21] Bárbara Andrade, Utso Bhattacharya, Ravindra W. Chhajlany, Tobias Graß, and Maciej Lewenstein, “Observing quantum many-body scars in random quantum circuits,” *Physical Review A* **109** (2024), 10.1103/physreva.109.052602.
- [22] Joseph Vovrosh and Johannes Knolle, “Confinement and entanglement dynamics on a digital quantum computer,” *Scientific Reports* **11** (2021), 10.1038/s41598-021-90849-5.
- [23] Stasja Stanisic, Jan Lukas Bosse, Filippo Maria Gambetta, Raul A. Santos, Wojciech Mruczkiewicz, Thomas E. O’Brien, Eric Ostby, and Ashley Montanaro, “Observing ground-state properties of the fermi-hubbard model using a scalable algorithm on a quantum computer,” *Nature Communications* **13** (2022), 10.1038/s41467-022-33335-4.
- [24] Alessandro Summer, Cecilia Chiaracane, Mark T. Mitchison, and John Goold, “Calculating the many-body density of states on a digital quantum computer,” *Phys. Rev. Res.* **6**, 013106 (2024).
- [25] Nathan Keenan, Niall F. Robertson, Tara Murphy, Sergiy Zhuk, and John Goold, “Evidence of kardar-parisi-zhang scaling on a digital quantum simulator,” *npj Quantum Information* **9** (2023), 10.1038/s41534-023-00742-4.
- [26] Bruno Bertini, Pavel Kos, and Tomaž Prosen, “Exact spectral form factor in a minimal model of many-body quantum chaos,” *Phys. Rev. Lett.* **121**, 264101 (2018).
- [27] Bruno Bertini, Pavel Kos, and Tomaž Prosen, “Exact correlation functions for dual-unitary lattice models in 1 + 1 dimensions,” *Phys. Rev. Lett.* **123**, 210601 (2019).
- [28] Alessandro Summer, Alex Nico-Katz, Shane Dooley, and John Goold, “Anomalous transport in u(1)-symmetric quantum circuits,” (2024), in preparation.
- [29] Saúl Pilatowsky-Cameo, Ceren B. Dag, Wen Wei Ho, and Soonwon Choi, “Complete Hilbert-space ergodicity in quantum dynamics of generalized Fibonacci drives,” (2023), arXiv:2306.11792 [quant-ph].
- [30] Aram W. Harrow, “The church of the symmetric subspace,” (2013), arXiv:1308.6595 [quant-ph].
- [31] We note that Ref. [29] used the trace distance instead of the Hilbert-Schmidt distance in Eq. 5. The trace distance has the advantage of a clear operational meaning in quantum state discrimination. However, to calculate it requires matrix diagonalisation while the Hilbert-Schmidt distance does not, and is easier to calculate numerically.
- [32] Patrick J. Coles, M. Cerezo, and Lukasz Cincio, “Strong bound between trace distance and hilbert-schmidt distance for low-rank states,” *Physical Review A* **100** (2019), 10.1103/physreva.100.022103.
- [33] Daniel K. Mark, Federica Surace, Andreas Elben, Adam L. Shaw, Joonhee Choi, Gil Refael, Manuel Endres, and Soonwon Choi, “A maximum entropy principle in deep thermalization and in hilbert-space ergodicity,” (2024), arXiv:2403.11970 [quant-ph].
- [34] Marlon Brenes, Tyler LeBlond, John Goold, and Marcos Rigol, “Eigenstate thermalization in a locally perturbed

- integrable system,” *Phys. Rev. Lett.* **125**, 070605 (2020).
- [35] R. Steinigeweg, J. Herbrych, and P. Prelovšek, “Eigenstate thermalization within isolated spin-chain systems,” *Physical Review E* **87** (2013), 10.1103/physreve.87.012118.
- [36] S. Trotzky, Y-A. Chen, A. Flesch, I. P. McCulloch, U. Schollwöck, J. Eisert, and I. Bloch, “Probing the relaxation towards equilibrium in an isolated strongly correlated one-dimensional bose gas,” *Nature Physics* **8**, 325–330 (2012).
- [37] Govinda Clos, Diego Porras, Ulrich Warring, and Tobias Schaetz, “Time-resolved observation of thermalization in an isolated quantum system,” *Physical Review Letters* **117** (2016), 10.1103/physrevlett.117.170401.
- [38] Adam M. Kaufman, M. Eric Tai, Alexander Lukin, Matthew Rispoli, Robert Schittko, Philipp M. Preiss, and Markus Greiner, “Quantum thermalization through entanglement in an isolated many-body system,” *Science* **353**, 794–800 (2016).
- [39] Yijun Tang, Wil Kao, Kuan-Yu Li, Sangwon Seo, Krishnanand Mallayya, Marcos Rigol, Sarang Gopalakrishnan, and Benjamin L. Lev, “Thermalization near integrability in a dipolar quantum newton’s cradle,” *Physical Review X* **8** (2018), 10.1103/physrevx.8.021030.
- [40] Hannes Bernien, Sylvain Schwartz, Alexander Keesling, Harry Levine, Ahmed Omran, Hannes Pichler, Soonwon Choi, Alexander S. Zibrov, Manuel Endres, Markus Greiner, Vladan Vuletić, and Mikhail D. Lukin, “Probing many-body dynamics on a 51-atom quantum simulator,” *Nature* **551**, 579–584 (2017).
- [41] Pengfei Zhang, Hang Dong, Yu Gao, Liangtian Zhao, Jie Hao, Jean-Yves Desaulles, Qiujiang Guo, Jiachen Chen, Jinfeng Deng, Bobo Liu, Wenhui Ren, Yunyan Yao, Xu Zhang, Shibo Xu, Ke Wang, Feitong Jin, Xuhao Zhu, Bing Zhang, Hekang Li, Chao Song, Zhen Wang, Fangli Liu, Zlatko Papić, Lei Ying, H. Wang, and Ying-Cheng Lai, “Many-body hilbert space scarring on a superconducting processor,” *Nature Physics* **19**, 120–125 (2022).
- [42] Guo-Xian Su, Hui Sun, Ana Hudomal, Jean-Yves Desaulles, Zhao-Yu Zhou, Bing Yang, Jad C. Halimeh, Zhen-Sheng Yuan, Zlatko Papić, and Jian-Wei Pan, “Observation of many-body scarring in a bose-hubbard quantum simulator,” *Physical Review Research* **5** (2023), 10.1103/physrevresearch.5.023010.
- [43] Naoto Shiraishi and Takashi Mori, “Systematic construction of counterexamples to the eigenstate thermalization hypothesis,” *Phys. Rev. Lett.* **119**, 030601 (2017).
- [44] Sanjay Moudgalya, Nicolas Regnault, and B. Andrei Bernevig, “ η -pairing in hubbard models: From spectrum generating algebras to quantum many-body scars,” *Phys. Rev. B* **102**, 085140 (2020).
- [45] Shriya Pai, Michael Pretko, and Rahul M. Nandkishore, “Localization in fractonic random circuits,” *Phys. Rev. X* **9**, 021003 (2019).
- [46] Vedika Khemani, Michael Hermele, and Rahul Nandkishore, “Localization from hilbert space shattering: From theory to physical realizations,” *Phys. Rev. B* **101**, 174204 (2020).
- [47] Sanjay Moudgalya and Olexei I. Motrunich, “Exhaustive characterization of quantum many-body scars using commutant algebras,” (2022), arXiv:2209.03377 [cond-mat.str-el].
- [48] Thomas Iadecola and Sagar Vijay, “Nonergodic quantum dynamics from deformations of classical cellular automata,” *Physical Review B* **102** (2020), 10.1103/physrevb.102.180302.
- [49] Yoshifumi Nakata, Da Zhao, Takayuki Okuda, Eiichi Bannai, Yasunari Suzuki, Shiro Tamiya, Kentaro Heya, Zhiguang Yan, Kun Zuo, Shuhei Tamate, Yutaka Tabuchi, and Yasunobu Nakamura, “Quantum circuits for exact unitary t -designs and applications to higher-order randomized benchmarking,” *PRX Quantum* **2**, 030339 (2021).
- [50] Libor Caha and Daniel Nagaj, “The pair-flip model: a very entangled translationally invariant spin chain,” (2018), arXiv:1805.07168 [quant-ph].
- [51] He-Ran Wang, Dong Yuan, Shun-Yao Zhang, Zhong Wang, Dong-Ling Deng, and L.-M. Duan, “Embedding quantum many-body scars into decoherence-free subspaces,” *Phys. Rev. Lett.* **132**, 150401 (2024).
- [52] Seth Lloyd, “Almost any quantum logic gate is universal,” *Phys. Rev. Lett.* **75**, 346–349 (1995).
- [53] Don N. Page, “Average entropy of a subsystem,” *Phys. Rev. Lett.* **71**, 1291–1294 (1993).

Appendix A: Universality of Local Hamiltonians and Brickwork Circuits

1. Universality of k -local Hamiltonians

Suppose we have a quantum system with L sites, with a d -dimensional qudit at each site, resulting in a D -dimensional Hilbert space \mathcal{H} , with $D = d^L$. Now we can apply one of two k -local Hamiltonians at a time, either \hat{H}_A or \hat{H}_B , which we can write as:

$$\hat{H}_X = \sum_{j=0}^L \hat{h}_{X,j}, \quad (\text{A1})$$

where $X = A, B$, and $\hat{h}_{X,j}$ are local operators centered at site j . We also assume that we can apply them for some predetermined, arbitrary time $\tau_{A/B}$, which will result in the unitary $\hat{U}_X = e^{-i\tau_X \hat{H}_X}$. The set $\{\hat{U}_A, \hat{U}_B\}$ will be universal (i.e. we can construct any unitary $\hat{U}_C \in U(D)$ up to arbitrary precision ϵ by applying the two universal gates in some sequence, $\|\prod_{i=\{A,B\}} \hat{U}_i - \hat{U}_C\| \leq \epsilon$, where $\|\dots\|$ denotes the trace norm), provided that [52]:

1. The Hamiltonians \hat{H}_A and \hat{H}_B don't share any eigenstates and/or symmetries.
2. Eigenphases of \hat{U}_X are irrational multiples of π .

We assume that the first condition is satisfied, as generic Hamiltonians (with arbitrary terms $\hat{h}_{X,j}$) will have different eigenstates and will not contain any symmetries. The second condition can be guaranteed, by using a suitable choice of the evolution times τ_X .

For each of the two Hamiltonians, we can label the eigenenergies as $E_j, j = 1, 2, \dots, D$. Then, the eigenphases of the corresponding unitary will be $\phi_j = \tau E_j$. Now, the eigenenergies could be either rational or irrational numbers, but in either case there will exist a time τ which will make all of the ϕ_j irrational multiples of π . Hence, we can make the unitaries \hat{U}_A, \hat{U}_B universal by a suitably choosing the evolution times τ_A and τ_B .

2. Universality of Brickwork circuits

Now, building upon the previous argument, we can construct a similar argument for the universality of unitaries corresponding to one odd and one even layer in a brickwork layer, as described in Eqn. 14. Suppose we have a 2-local Hamiltonian, \hat{H} , acting on an open chain of L qudits. All of the terms in the Hamiltonian act only on nearest neighbours, so we can decompose it as $\hat{H} = \sum_{i=0,2,4,\dots}^{L-2} \hat{g}_{i,i+1}^e + \sum_{i=1,3,\dots}^{L-3} \hat{g}_{i,i+1}^o$. Now, we let the system evolve for some time $\tau = \eta\delta$, where η is an arbitrary number of order $\mathcal{O}(1)$ and δ is a parameter which can be arbitrarily small, and we will set it to be

of the form $10^{-a}, a \in \mathbb{Z}^+$. This will result in the unitary $\hat{U} = e^{-i\tau'\delta\hat{H}} = e^{-i\eta\delta\hat{H}}$. Now, by the argument in section above we can always set η such that the eigenphases of \hat{U} will be irrational multiples of π .

Writing the terms in the exponent as: $\eta\delta\hat{g}_{i,i+1}^{o/e} = \hat{h}_{i,i+1}^{o/e}$, we can identify the \hat{U}_t in Eqn. 14 as a trotterization of some 2-local Hamiltonian, with a single timestep. Hence, the two unitaries are identical up to Trotter error: $\hat{U} = \hat{U} + \mathcal{O}(\eta^2\delta^2)$. Therefore we can make the error arbitrarily small, by tuning the δ parameter.

Appendix B: Commutant algebras

Given some Hamiltonian $\hat{H} = \sum_j \alpha_j \hat{h}_j$ consisting of local terms \hat{h}_j (or similarly, a unitary composed of local gates $\hat{U} = \prod_j e^{i\alpha_j \hat{h}_j}$), the commutant algebra (\mathcal{C}) is the set of Hermitian operators \hat{c}_k , which commute with each individual term in the Hamiltonian \hat{H} :

$$[\hat{h}_j, \hat{c}_k] = 0 \forall j. \quad (\text{B1})$$

Together with the commutant algebra, we also define the so-called bond algebra ($\mathcal{A} \equiv \langle\langle \hat{H} \rangle\rangle$), which is the associative algebra obtained by taking linear combinations with complex coefficients of arbitrary products of all the terms in \hat{H} and the identity operator \mathbb{I} (note that we can always include the identity in a given Hamiltonian by using an energy off-set, which does not change the dynamics). It is called the ‘‘bond algebra’’ since taking sums and products of the local \hat{h}_j will result in longer and longer strings of operators, thus creating bonds.

We use $\mathcal{L}(\mathcal{H})$ to denote the set of all linear operators on \mathcal{H} . Then \mathcal{A}, \mathcal{C} will be subsets of $\mathcal{L}(\mathcal{H})$ and most importantly centralizers of each other [10]. Due to this fact, the irreducible representations of \mathcal{A}, \mathcal{C} can be used to construct a virtual bipartition of the Hilbert space: $\mathcal{H} = \bigoplus_{\lambda} \mathcal{H}_{\lambda}^{(\mathcal{A})} \otimes \mathcal{H}_{\lambda}^{(\mathcal{C})}$. There exists a basis, in which the operators $\hat{h}_{\mathcal{A}} \in \mathcal{A}, \hat{h}_{\mathcal{C}} \in \mathcal{C}$ can be written as:

$$\begin{aligned} \hat{h}_{\mathcal{A}} &= \bigoplus_{\lambda} (\hat{M}_{D_{\lambda}}^{\lambda}(\hat{h}_{\mathcal{A}}) \otimes \hat{\mathbb{I}}_{d_{\lambda}}), \\ \hat{h}_{\mathcal{C}} &= \bigoplus_{\lambda} \hat{\mathbb{I}}_{D_{\lambda}} \otimes (\hat{M}_{d_{\lambda}}^{\lambda}(\hat{h}_{\mathcal{C}})), \end{aligned} \quad (\text{B2})$$

where D_{λ} and d_{λ} are the representations of irreps of \mathcal{A} and \mathcal{C} , $\hat{M}_{D_{\lambda}}^{\lambda}(\hat{h}_{\mathcal{A}})$ and $\hat{M}_{d_{\lambda}}^{\lambda}(\hat{h}_{\mathcal{C}})$ are the D_{λ} and d_{λ} dimensional matrix representations of the operators in the arguments. As such, this is just a matrix representation of the operators in the basis in which all the operators in \mathcal{A} and \mathcal{C} are block diagonal. Note that the dimensions of \mathcal{A}, \mathcal{C} are the dimensions of the subspaces of matrices used in (B2):

$$\dim(\mathcal{A}) = \sum_{\lambda} D_{\lambda}^2, \quad \dim(\mathcal{C}) = \sum_{\lambda} d_{\lambda}^2, \quad \dim(\mathcal{H}) = \sum_{\lambda} D_{\lambda} d_{\lambda} \quad (\text{B3})$$

1. Commutant algebra of the QMBS model

In Sec. VI, all of the 2-local unitaries have the form as written in Eqn. 16. By construction, all of the target states, $\{|\psi_{S_i}\rangle\}$ commute with the 2-local unitaries used to construct the circuit model, i.e.:

$$[\hat{U}_{t,e/o}^{n,n+1}, |\psi_{S_i}\rangle\langle\psi_{S_i}|] = 0, \quad (\text{B4})$$

where the gates have the form: $\hat{U}_{t,e/o}^{n,n+1} = \exp\{i\hat{P}^{n,n+1}\hat{H}_{t,e/o}^{n,n+1}\hat{P}^{n,n+1}\}$, and $|\psi_{S_i}\rangle$ are the states that simultaneously annihilated by all the projectors. This immediately implies that the commutant algebra of this model consists of the projectors corresponding to each of the scar states and the identity:

$$\mathcal{C}_{\text{QMBS}} = \{|\psi_{S_i}\rangle\langle\psi_{S_i}|, \hat{\mathbb{I}}\}. \quad (\text{B5})$$

More concretely, in the case of a single scar, we will have two operators in the commutant algebra, $\dim(\mathcal{C}) = 2$, implying that we have two distinct λ values with $d_\lambda = 1$ for both. Note that due to the fact that the scar subspace is 1-dimensional, we can immediately read off that $D_{\lambda_1} = 1$, $D_{\lambda_2} = \dim(\mathcal{H}) - 1$. Hence, we will have one 1-dimensional subspace corresponding to the scar state, and one $\dim(\mathcal{H}) - 1$ dimensional, thermal subspace.

2. Commutant algebra of the Pair-flip model

Note that we can again relate this to the structure of the commutant algebra of the pair-flip circuit model. For a more in depth discussion see [47], where they provide an in-depth diagrammatic model and explanation. Now, in order to construct the commutant algebras, we define the following operators:

$$\hat{N}_i^\alpha = |\alpha\rangle\langle\alpha|_i, \hat{N}^\alpha = \sum_j (-1)^j \hat{N}_j^\alpha, \quad (\text{B6})$$

where we can think of \hat{N}_i^α as the ‘‘counting operator’’ determining whether the state at site i is $|\alpha\rangle$ or not. It is easy to verify that \hat{N}^α commutes with the pair flip unitaries of Eqn. 20, thus implying the existence of a $U(1)$ symmetry due to (slightly modified) particle number conservation.

However, due to the observation that we get exponentially many subspaces, there should also exist other conserved quantities which are linearly independent of \hat{N}^α . Firstly, we will denote the ‘‘flip’’ part of the unitary as:

$$\hat{F}_{ij}^{\alpha\beta} = U_{ab}^{PF} |aa\rangle_{ij} \langle bb|_{ij}. \quad (\text{B7})$$

Now we can extend to previously found commuting operators by observing that:

$$[\hat{N}_i^\sigma \hat{N}_j^\tau, \hat{F}_{ij}^{\alpha\beta}] = 0, \text{ for } \sigma \neq \tau, 1 \leq \alpha, \beta, \sigma, \tau \leq d, \quad (\text{B8})$$

where the last two constraints are trivial, just making sure we don’t overcount the operators. Now, using this expression we can construct higher order operators that commute with the pair flip unitaries:

$$\hat{N}^{\alpha_1, \dots, \alpha_k} \equiv \sum_{j_1 < j_2 < \dots < j_k} (-1)^{\sum_{i=1}^k j_i} \hat{N}_{j_1}^{\alpha_1} \dots \hat{N}_{j_k}^{\alpha_k}. \quad (\text{B9})$$

However, note that not all of the distinct operators encapsulated by Eqn. (B9). For even system sizes N , the operators with odd k can be expressed as a linear combination of the operators with even k . The total number of linearly independent operators in \mathcal{C} is then:

$$\dim(\mathcal{C}) = \begin{cases} \frac{(d-1)^{N+1} - 1}{d-2} & \text{if } d \geq 3 \\ N + 1 & \text{if } d = 2, \end{cases} \quad (\text{B10})$$

showing that the pair-flip model contains a regular symmetry for $d = 2$ and that it should exhibit Hilbert space fragmentation for $d > 2$. This is clearly seen by the numerical results in Sec. VII, VIII, where we observe the Hilbert subspace ergodicity in each of the disconnected subspaces.

Appendix C: Numerical procedure for computing Discretised Ensemble Entropy

In practice, we will end up with a finite set of T states in the temporal ensemble: $|\Psi_0^T\rangle, |\Psi_1^T\rangle, |\Psi_2^T\rangle, \dots, |\Psi_{T-1}^T\rangle$, from which we want to compute an estimator for the discretised ensemble entropy as written in Eqn. (9). One way to do it would be to brute force discretise Hilbert space into different areas, but this would be quite difficult for arbitrarily large Hilbert space dimension. Therefore we perform a randomised sampling procedure to estimate the probabilities, $\{p_j^T, p_j^H\}$ corresponding to the temporal and Haar ensembles:

1. Pick T , M and ϵ , with $\epsilon \in [0, 1)$. T and M should be chosen such that $T \gg M$, in order to minimise the fluctuations in probabilities.
2. Sample T states generated by the time evolution of chosen aperiodic drive, $\{|\Psi_i^T\rangle\}$, as well as T states from the Haar ensemble, $\{|\Psi_j^H\rangle\}$.
3. Sample M states from Haar ensemble, $\{|\Phi_j^R\rangle\}$, which will form a set of reference states used to estimate the probabilities.
4. Remove states from the second set if their overlap is large with any other state, i.e. if $|\langle\Phi_j|\Phi_k\rangle| > 1 - \epsilon$, resulting in M' states. This ‘‘filtering’’ step is performed in order to ensure numerical stability.
5. Now, the filtered second set will form a reference set for the two sets of states $\{|\Psi_i^T\rangle\}$ and $\{|\Psi_i^H\rangle\}$. We will ‘‘bin’’ the states from these two sets into

M' bins, depending on which state they have the largest overlap with. I.e., we will assign the i -th state state from the temporal / Haar ensemble to the bin j which maximises the overlap $|\langle \Psi_i^{T/H} | \Phi_j \rangle|$, giving two sets of counts, n_j^T and n_j^H .

6. This will give us two sets of probabilities for the temporal and discretised haar ensembles as: $p_j^T = n_j^T / \sum_{j=1}^{M'} n_j^T$ and $p_j^H = n_j^H / \sum_{j=1}^{M'} n_j^H$. Using these in Eqn. (10) we obtain the discretised ensemble entropy estimate.

Note that the discretised ensemble entropy in Eqn. (10) is a good proxy for the ensemble entropy in Eqn. (9), but there are some minor distinctions. Both quantities are upper bounded by 0, but the lower bounds differ. The latter is not bounded from below and can in principle tend to $-\infty$, whereas the former has a finite lower bound. The lower bound can be reached in the case of a scar, which remains unchanged throughout the time evolution and thus always has maximum overlap with the same reference state, $|\Phi_{k'}\rangle$, for some k' . This gives the minimum attainable value for DEE:

$$\sum_{j=1}^{M'} \delta_{j,k'} \log_2 \left(\frac{\delta_{j,k'}}{p_j^H} \right) \approx \sum_{j=1}^{M'} \delta_{j,k'} \log_2 \left(\frac{\delta_{j,k'}}{1/M'} \right) = -\log_2(M'), \quad (\text{C1})$$

where we used the approximation that all the probabilities associated with the reference ensemble are equally likely. Note that the same argument can be extended to the case where we are sampling Haar states within a larger subspace, as for example in the case of symmetries or fragmentation. In case the initial state is constrained to a B -dimensional subspace, the dynamics will generate states in the same $\frac{B}{D}M = K$ bins. Hence, in the large T limit the DEE will converge to approximately:

$$\sum_{j=1}^K \frac{1}{K} \log_2 \left(\frac{M}{K} \right), \quad (\text{C2})$$

which agrees with the large T limit observed in Figs. 9, 12.

Note that, for a finite set of bins M' , one can construct dynamics which are not really Hilbert space ergodic, but are just cyclically orbiting between some states belonging to each of the M' regions of Hilbert space. Therefore we also perform averaging over different choices of the reference states $\{|\Psi_j^R\rangle\}$. In case the estimates of DEE for all different reference sets agree, one can infer that the dynamics indeed exhibits Hilbert (sub-)space ergodicity.

Appendix D: Decay of autocorrelation functions

The second quantity which is relevant for the diagnosis of scars and fragmentation is the infinite temperature

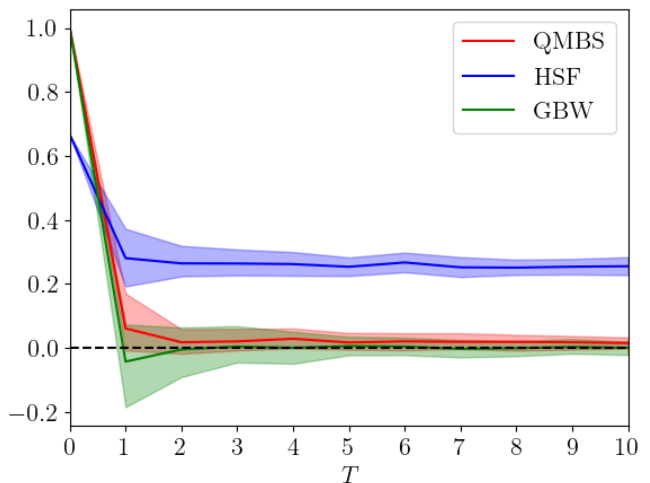

FIG. 13. Comparison of the decay of the infinite temperature autocorrelator \mathcal{A} , as defined in Eqn. (D1), for the generic brickwork model (GBW), scarred model (QMBS), and the model with Hilbert space fragmentation (HSF). The local observable used to compute the autocorrelator for QMBS and GBW is $\hat{\sigma}_{N/2}^z$, and the one for HSF is $\hat{S}_{N/2}^z$, where $\hat{S}^z = |1\rangle\langle 1| - |-1\rangle\langle -1|$. We observe that in the GBW the autocorrelator decays to almost exactly 0, while for the QMBS it decays almost to 0. Note that this small deviation is exponentially small in systems size and would vanish in the thermodynamic limit. In the case of HSF however, the autocorrelation function saturates to a finite bound of $1/3$, which is independent of system size, and indicates strong ergodicity breaking.

autocorrelator for a local operator \hat{O} , defined as:

$$\mathcal{A}(\hat{O}, t) = \text{Tr} \left[\frac{1}{D} \hat{\mathbb{I}} \hat{O}(t) \hat{O}(0) \right], \quad (\text{D1})$$

where $\hat{O}(t) \equiv \hat{U}(t)^\dagger \hat{O} \hat{U}(t)$, and $\frac{1}{D} \hat{\mathbb{I}}$ represents the infinite temperature state. For a scarred model, this quantity should decay to almost 0 with time as the scars represent a vanishing fraction of the Hilbert space, whereas a model exhibiting strong HSF will decay to a constant non-zero value, which is bounded from below by the Mazur bound [10].

In Fig. 13, we see the decay of the autocorrelator for the HSF model presented in this section, contrasted with the models presented in Sec. V and Sec. VI. Note that, due to different dimensions of the local Hilbert spaces, we use the local observable $\hat{S}^z = |1\rangle\langle 1| + |0\rangle\langle 0| - |-1\rangle\langle -1|$ for the former model, and the usual Pauli Z operator for the latter two. The results are congruent with Hamiltonian models that display fragmentation. The autocorrelator quickly decays to a finite bound of $1/3$ and stays well above the long time values for the QMBS, which saturates at a very small finite value, and generic brickwork (GBW) models which saturate at exactly 0.

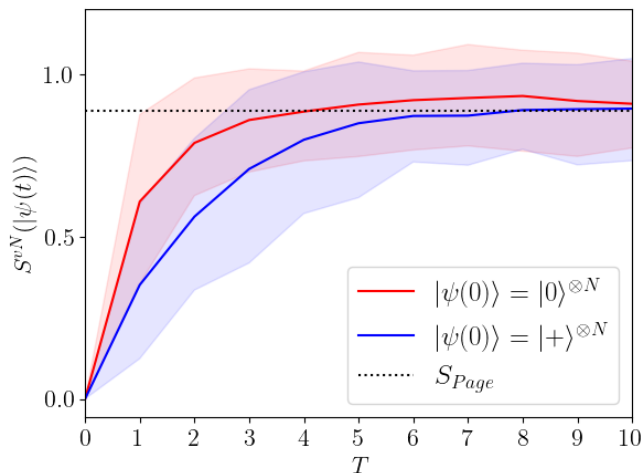

FIG. 14. Growth of bipartition entanglement entropy for the generic brickwork model, starting from two initial states: $|\psi(0)\rangle = |0\rangle^{\otimes N}$ and $|\psi(0)\rangle = |+\rangle^{\otimes N}$. The results are averaged over 100 different instances, with the lines corresponding to the average distances, and the shaded areas represent the 10-90th percentile range. Both initial states eventually saturate around the Page entropy, $S_{\text{Page}} = \frac{1}{2}N\ln(d) - \frac{1}{2}$.

Appendix E: Growth of bipartite entanglement entropy for the presented models

Bipartite entanglement entropy is frequently used quantity to detect the presence of ETH-violating eigenstates. For a chain of N qudits, the bipartition entanglement entropy is defined as:

$$S(|\psi(t)\rangle) = -\text{Tr}[\hat{\rho}_A(t)\log(\hat{\rho}_A(t))], \quad (\text{E1})$$

where $\hat{\rho}_A(t) = \text{Tr}_{0,(N/2)-1}|\psi(t)\rangle\langle\psi(t)|$ is the reduced density matrix of the time evolved state obtained by tracing out the first $N/2$ qudits of the system. In the case of an ergodic system with scars, and starting in a non-scar initial state $|\psi_0\rangle$, we expect the bipartition entanglement entropy to approach the Page value [53].

We first compute the growth of bipartition entanglement entropy for two the generic brickwork model, discussed in Sec. V, with the results displayed in Fig. 14. For both chosen initial states, $|0\rangle^{\otimes N}$ and $|+\rangle^{\otimes N}$, the bipartite entanglement initially grows quickly and reaches the Page entropy, $S_{\text{Page}} = \frac{1}{2}N\ln(d) - \frac{1}{2}$.

The results corresponding to the scarred model, presented in Sec. VI, are displayed in Fig. E. Starting in a scar state leads to no entanglement growth, whereas the entanglement entropy for the chosen non-scar state quickly grows and saturates around the Page value. These results are consistent with Hamiltonian and Floquet models which obey the ETH and contain a vanishingly small fraction of scars [16].

Finally, the effects of fragmentation can also be seen in the growth of bipartite entanglement entropy, displayed in Fig. 16. If the system is initialised in one of the frozen

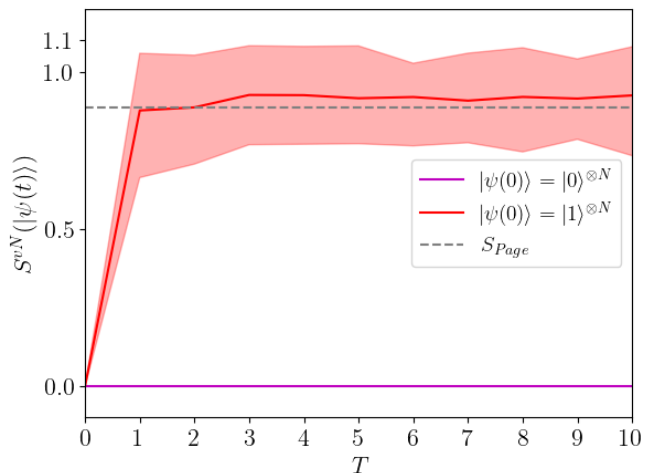

FIG. 15. Time evolution of bipartite entanglement entropy for the initial scar state $|S_1\rangle$ and non-scar state $|1\rangle^{\otimes N}$. For the scar state (violet) the entanglement entropy stays at 0, which is expected for a product state. But for the non-scar state (red), the entanglement entropy instantaneously grows to the Page entropy, $S_{\text{Page}} = \frac{1}{2}N\ln(d) - \frac{1}{2}$, which is the expected entanglement entropy for a Haar random state. Note that the line represents the average over the 100 iterations and the shaded region represents the 10-90 percentiles.

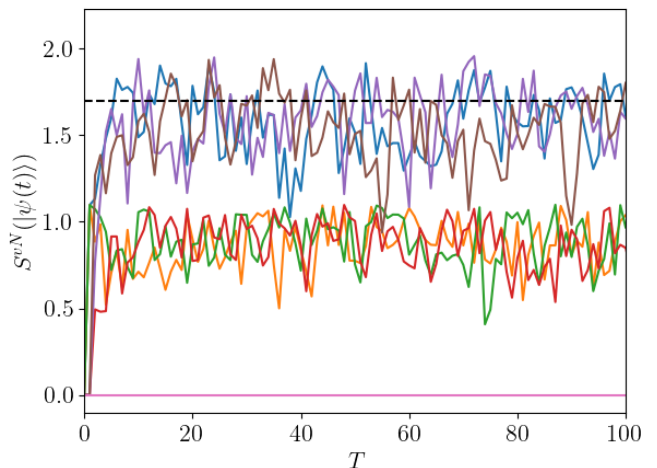

FIG. 16. Growth of bipartite entanglement entropy for a set of chosen initial states. For the frozen states (pink), S^{vN} stays at 0 for all times t . When starting in states belonging to the largest, 15-dimensional subspace (blue, purple, brown), the entanglement entropy quickly achieves, and oscillates around the Page value (dashed black line). The states belonging to 7-dimensional subspaces (red, green, orange), oscillate close around half of the Page value.

states, it remains in the frozen state for all times, and therefore the entanglement entropy stays at 0. On the other hand, if the system is initialised in any state in the largest subspace, it will quickly increase to the Page value and oscillate around it.

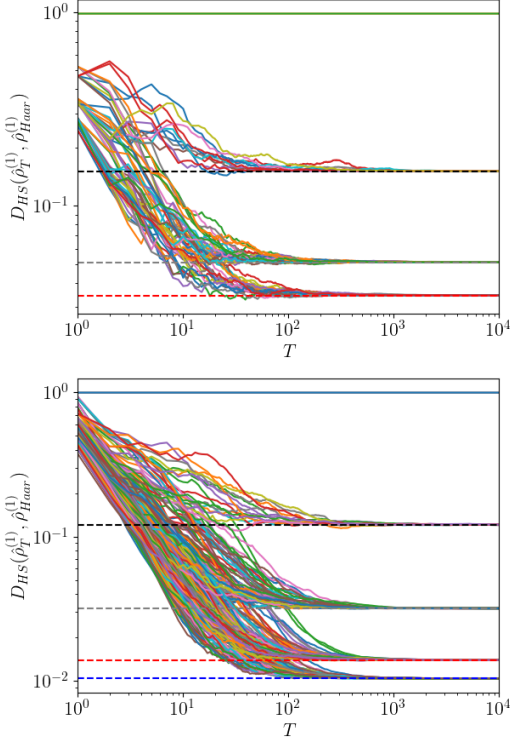

FIG. 17. Hilbert Schmidt distance between the first moments of the Haar ensemble, and the temporal ensemble generated by the Fibonacci layered pair-flip model, with $d = 2$, $N = 6$ (TOP) and $N = 8$ (BOTTOM). We test all possible initial product states to generate the temporal ensembles. The dashed lines represent the bounds imposed by different subspaces, and we observe convergence of each of the initial states to their respective bounds.

Appendix F: Additional results for symmetries

In the main text we considered the simple example of a $U(1)$ symmetry present in the pair-flip model, and we presented results for $N = 4$, for the two moments $k = 1, 2$. Here we present additional results for greater system sizes ($N = 6, 8$), but only computing the distance to the first Haar moment. In Fig. 17 we again observe that the distances of the different moments are converging to the bounds imposed by the subspace sizes.

Appendix G: Additional Results for HSF

In Sec. VII of the main text we considered the pair-flip model with $d = 3$ and $N = 4$, for the two moments $k = 1, 2$. Here we present additional results for $N = 5, 6$, but only computing the distance to the first Haar moment. In Fig. 18 we again observe that the distances of the different moments are converging to the bounds imposed by the subspace sizes.

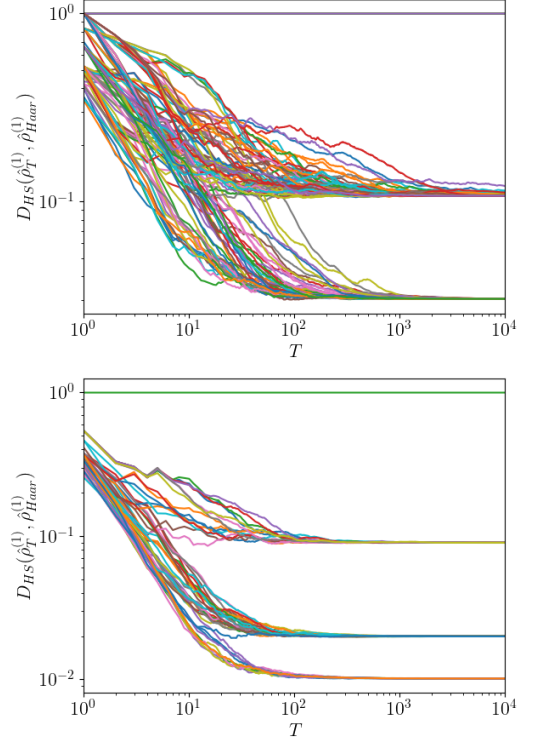

FIG. 18. Hilbert Schmidt distance between the first moments of the Haar ensemble, and the temporal ensemble generated by the Fibonacci layered pair-flip model, with $d = 3$, $N = 5$ (TOP) and $N = 6$ (BOTTOM). We test half of all possible initial product states for $N = 5$ and 50 initial product states for $N = 6$ to generate the temporal ensembles.

Appendix H: Embedding Multiple Scars

In the main part of our work we presented the simplest example of a single scar in a model with $N = 4$, $d = 2$. However, it is relatively straightforward to extend the presented results to other cases. For this purpose, we here consider a model with $N = 4$ qutrits ($d = 3$). We again perform simulations with the birckwork model, where the 2-local unitaries have the form presented in Eqn. (16). We use four different projectors:

$$\begin{aligned}
 \hat{P}_1 &= \hat{\mathbb{I}} - |00\rangle\langle 00|, \hat{P}_2 = \hat{\mathbb{I}} - |00\rangle\langle 00| - |11\rangle\langle 11| \\
 \hat{P}_{\text{exp}} &= \hat{\mathbb{I}} - |00\rangle\langle 00| - |11\rangle\langle 11| - |01\rangle\langle 01| - |10\rangle\langle 10| \\
 \hat{P}_{\text{lin}} &= \hat{\mathbb{I}} - |00\rangle\langle 00| - |11\rangle\langle 11| - |\Phi_{-}\rangle\langle \Phi_{-}| \\
 &|\Phi_{-}\rangle \equiv |+-\rangle - |-+\rangle, |\pm\rangle = |0\rangle \pm |1\rangle.
 \end{aligned} \tag{H1}$$

Now, using \hat{P}_1 in the embedding procedure will result in a single scar, \hat{P}_2 in two scars, \hat{P}_{exp} in 2^N scars and \hat{P}_{lin} will give a linear number, $N + 1$, of scars. We perform numerical simulations for all four cases, for times up to 10^4 and compare the first moments to the Haar ensemble. The results are presented in Fig. 19.

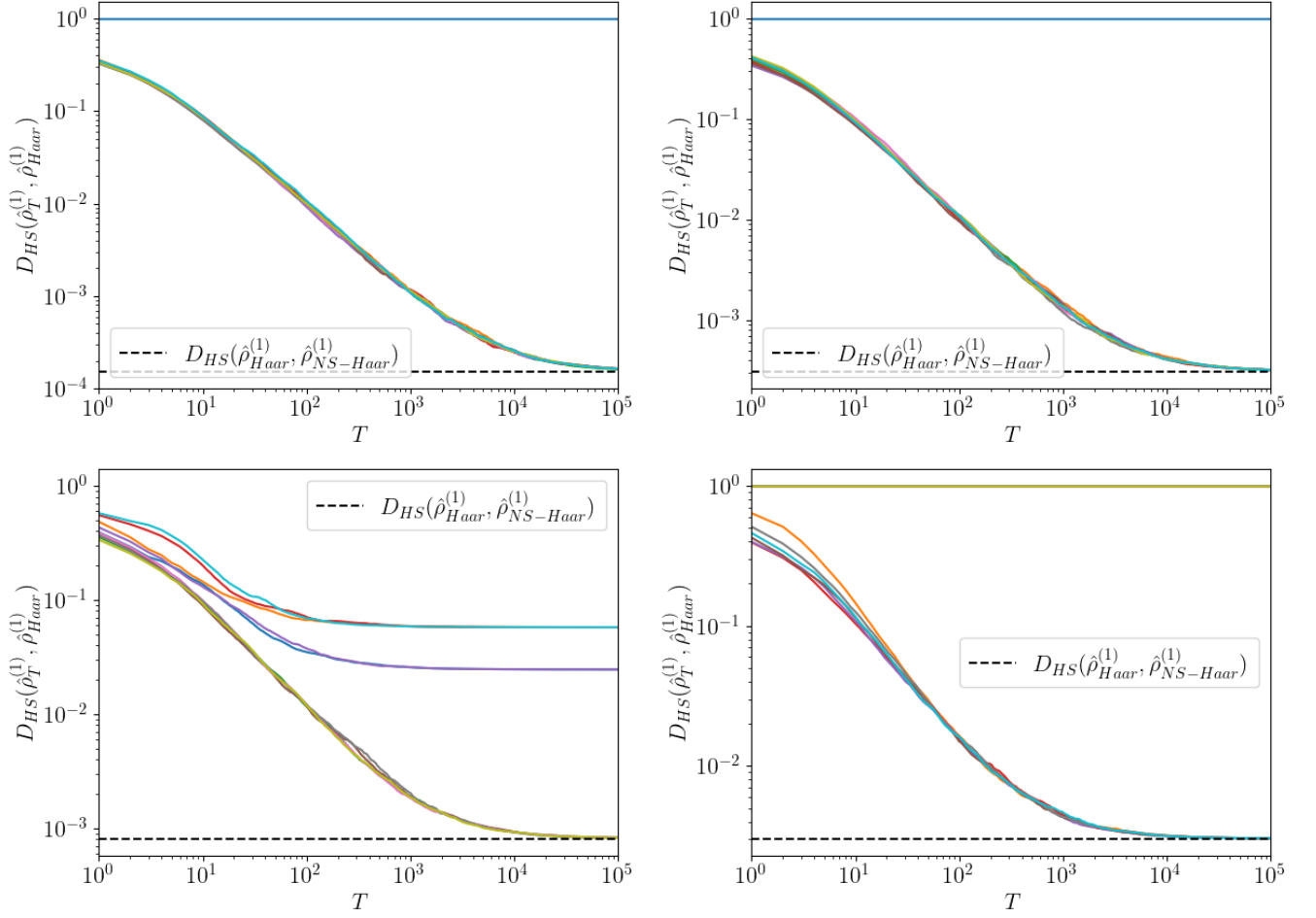

FIG. 19. Results comparing the distances between the Haar ensemble and temporal ensemble, with $k = 1$, for the local unitaries of the form $\hat{U} = \exp[i\hat{P}\hat{H}\hat{P}]$. We employ four different projectors \hat{P}_1 , \hat{P}_2 , \hat{P}_{lin} and \hat{P}_{exp} , as defined in Eqn. (H1). The results for the different projectors are displayed in that respective order, top to bottom. Note that increasing the number of embedded scars also leads to a decrease in the available space to explore for the other states. Therefore, a greater number of QMBS directly leads to lower bound on the distance, which can be observed from the results. Note that in the linear scar case, the QMBS states are not computational basis states, therefore they are affected by the actions of the local unitaries.