

# About Time: Advances, Challenges, and Outlooks of Action Understanding

Alexandros Stergiou · Ronald Poppe

the date of receipt and acceptance should be inserted later

**Abstract** We have witnessed impressive advances in video action understanding. Increased dataset sizes, variability, and computation availability have enabled leaps in performance and task diversification. Current systems can provide coarse- and fine-grained descriptions of video scenes, extract segments corresponding to queries, synthesize unobserved parts of videos, and predict context. This survey comprehensively reviews advances in uni- and multi-modal action understanding across a range of tasks. We focus on prevalent challenges, overview widely adopted datasets, and survey seminal works with an emphasis on recent advances. We broadly distinguish between three temporal scopes: (1) recognition tasks of actions observed in full, (2) prediction tasks for ongoing partially observed actions, and (3) forecasting tasks for subsequent unobserved action. This division allows us to identify specific action modeling and video representation challenges. Finally, we outline future directions to address current shortcomings.

**Keywords** Action Understanding · Action Recognition · Action Prediction · Action Anticipation

## 1 Introduction

For decades, analyzing human actions in videos has been of particular interest to the computer vision community. Videos are prominent in both our social and

professional lives. Over time, the analysis of actions has shifted from the well-understood task of action recognition towards the fundamental and broader area of action understanding. Shown in Figure 1, action understanding now includes diverse tasks based on prediction and anticipation with multimodal inputs. The unique challenges and novel computation paradigms are the core focus of our survey.

In developmental psychology, action understanding has been explored across several psychological aspects (Thompson et al 2019):

**The ability to understand the action performed** relates to differentiating between analogous actions (Gallese et al 1996; Jeannerod 1994) and conceptualizing *how* an action is performed (Spunt et al 2011).

**Determining the goal of the action** has been studied in the context of immediate goals (Calvo-Merino et al 2005; Kohler et al 2002; Rizzolatti et al 2001) in relation to motor functions for the execution of actions and the sensory perception of actions performed by others.

**Determining the actor's intention** refers to identifying high-level goals and motivations to perform actions (Kilner 2011). Intentions have been defined as the sequential grouping of individual actions (Fogassi et al 2005) and their abstract associated target (Uithol et al 2011).

### 1.1 Taxonomy of this survey

Inspired by the cognitive aspects of action understanding, we define three broad *temporal scopes* to group seminal machine vision action understanding tasks. We visualize action sequence progression in Figure 2 with a currently (partially) performed action followed by a subsequent action. Tasks that require an action to be

---

A. Stergiou  
Faculty of Electrical Engineering, Mathematics and Computer Science at the University of Twente, Drienerlolaan 5, 7522 NB Enschede, The Netherlands

R. Poppe  
Department of Information and Computing Sciences at Utrecht University, Princetonplein 5, 3584 CC Utrecht, The Netherlands

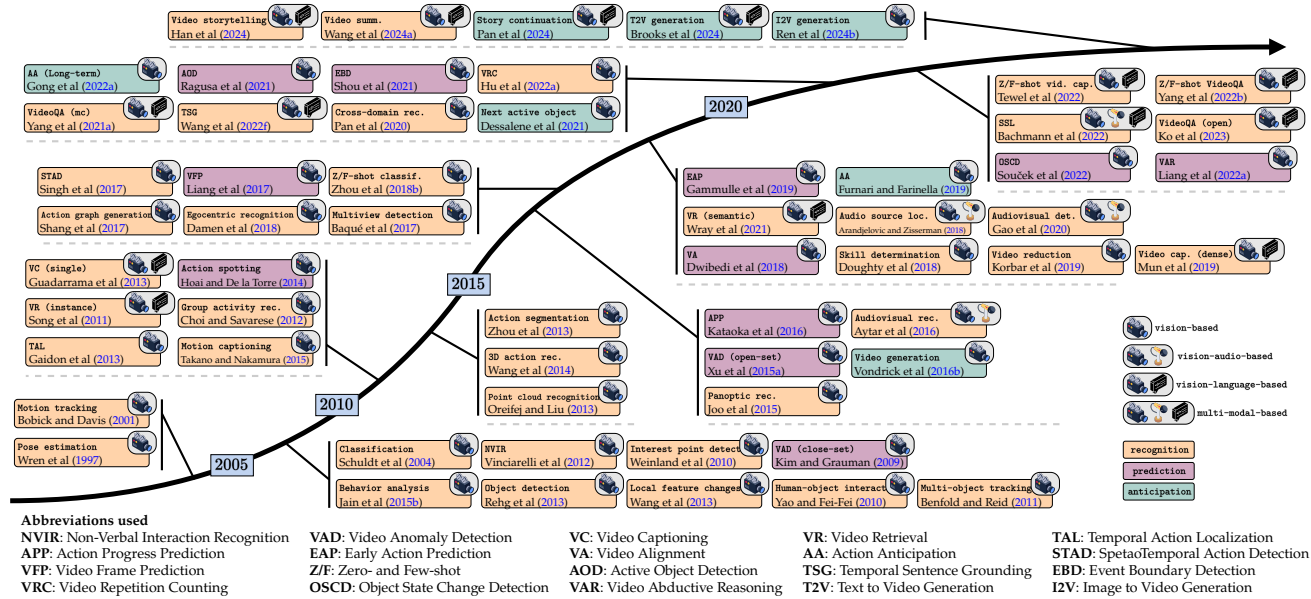

Fig. 1. **Action understanding historical overview.** We present popular tasks across time periods. Landmark papers are selected by their relevance to the period’s trends. Most tasks remain popular today.

observed in full are broadly referred to as **recognition** tasks and infer information such as the action categories or high-level semantics. **Predictions** about the ongoing actions are made from partial observations of actions *not yet completed*. **Forecasting** tasks use the currently observed action(s) to reason about future actions *not yet observed*. We discuss relevant previous surveys for each of these three temporal scopes and overview their focus in Table 1.

**Recognition.** Early works on action recognition have primarily focused on motion modeling. Aggarwal et al (1994) used a taxonomy of rigidness and subsequently (Aggarwal et al 1998) introduced subdivisions based on prior knowledge of the object’s shape. Cedras and Shah (1995) and later Moeslund and Granum (2001) discussed temporal modeling approaches in the context of classification and tracking. As overviewed by Buxton (2003), tracking has also been applied to more complex tasks such as behavior analysis or non-verbal human interactions. Subsequent overviews were more task-oriented, focusing on action classification and localization (Weinland et al 2011), behavior understanding (Chaaroui et al 2012), and surveillance applications (Vishwakarma and Agrawal 2013) emerged based on later advancements. Simultaneously, Turaga et al (2008) and Poppe (2010) discussed approaches addressing atomic actions and group activities. Herath et al (2017) provided an initial summary of approaches using learned features for action recognition. Following surveys covered adaptations of deep learning approaches

for topics such as depth-based motion recognition (Wang et al 2018d), activity recognition (Beddiar et al 2020), human-human interactions (Stergiou and Poppe 2019), and pose estimation (Zheng et al 2020a). Sun et al (2022b) reviewed approaches across modalities, combining motion features, audio, and vision. More recently, Selva et al (2023) discussed attention-based approaches for video tasks while Schiappa et al (2023) focused on self-supervised (SSL) approaches. Madan et al (2024) presented a comprehensive overview of language-enabled action understanding models, focusing on video foundation models.

**Prediction.** Recent advancements in action recognition have also sparked interest in predictive tasks from partial observations. Rasouli (2020) discussed four main domains of predictive models including video, action, trajectory, and motion prediction. Kong and Fu (2022) described recent action recognition and prediction advancements. They focused on applications in domains such as robot vision, surveillance, and driver behavior prediction. The surveys of Dhiman and Vishwakarma (2019) and Ramachandra z et al (2020) overviewed predictive methods specifically for anomaly detection.

**Forecasting.** Action forecasting tasks have become prevalent parts of action understanding research. Rodin et al (2021) discussed future action anticipation in egocentric videos. Zhong et al (2023b) overviewed short and long-term action anticipation methods. Hu et al (2022c) provided a review of online and anticipation works. Recently, Plizzari et al (2024) discussed

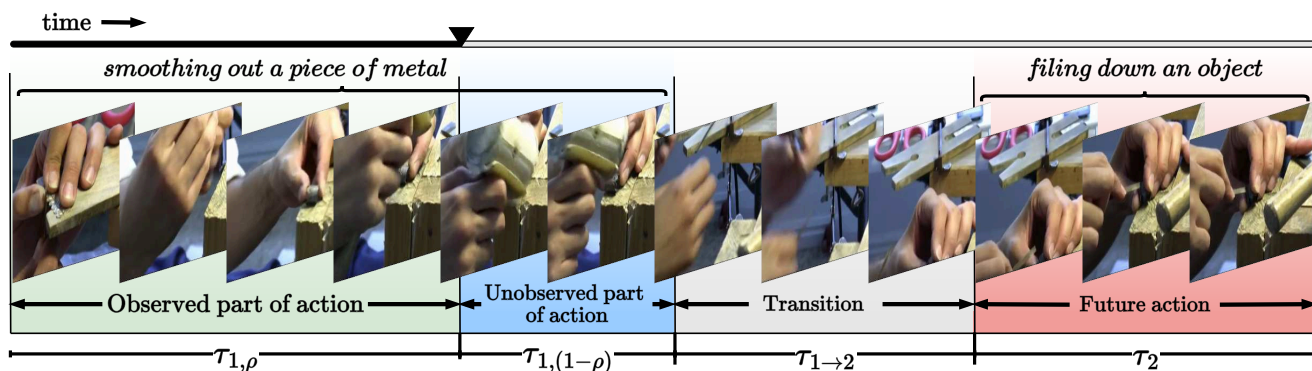

Fig. 2. **Action understanding tasks.** The progress of the video is indicated by the top bar. From the currently performed action of total duration  $\tau_1$ , only the  $\tau_{1,\rho} < \tau_1$  part is readily observable. After a transition period  $0 \leq \tau_{1\to 2}$ , another action is performed with duration  $\tau_2$ . **Action recognition** tasks consider full observations of the action at  $\tau_1$ . **Action prediction** uses only part  $\tau_{1,\rho}$  of the ongoing action. **Action forecasting** uses current action at  $\tau_1$  to predict future actions. Video example sourced from Wang et al (2019b).

challenges in egocentric videos and presented future directions for multiple tasks including forecasting.

Despite their extensive coverage, prior surveys focus on specific aspects of action understanding. As shown in Table 1, a critical overview that holistically explores action understanding is currently missing in the literature.

This survey fills this void by focusing on advancements across a broad range of action understanding tasks. We do this from a temporal perspective. We survey general approaches for modeling actions in videos over the years in Section 2, and discuss common datasets and benchmarks in Section 3. We then detail recognition tasks in Section 4, predictive tasks in Section 5, and forecasting tasks in Section 6. Based on the temporal scopes, we then outline the main challenges and provide future directions in Section 7. We conclude in Section 8.

## 2 Modeling actions in videos

In this section, we define two general groups of approaches for encoding videos without explicitly relating them to tasks. We start with characterizing key challenges in Section 2.1. Approaches discussed in Section 2.2 model spatial and temporal information separately, while works overviewed in Section 2.3 use joint spatiotemporal representations.

### 2.1 Challenges in action representation

The diversity of the video input poses several challenges. **Intra-class variations** in the visual appearance

of actions of the same category across videos can be due to viewpoint, occlusions, background noise, or lighting conditions. The performances and durations of actions can also significantly deviate. Such variations appear across datasets (Grauman et al 2022; Kay et al 2017; Miech et al 2019; Soomro et al 2012). Training/test set instance distribution variance can also significantly impact the performance and overall generalization of the learned semantics. Challenging action instances can be traced to feature representations further from the training set distribution in such cases.

Since action understanding tasks are increasingly semantic, we also face challenges in the diversity and granularity of the target outputs. Interpretation of the visual input, and sometimes the lack of observable information, increasingly requires higher-level understanding. Consequently, the relation between visual input and model output becomes more complex. **Vocabulary limitations** present challenges as action categories are often finite. The generalization of models to *open-set* or *cross-domain* settings primarily depends on the similarity between seen and unseen instances. Limited *inter-class variation* further affects good representation performance of rare coarse-grained concepts of visually similar actions. This issue is more prevalent for tasks that require fine-grained semantic granularities.

### 2.2 Separating visual and temporal information

We first discuss approaches that process visual and temporal information independently.

**Tracking and template matching.** Early works (Bobick and Davis 2001) have applied template matching to

Table 1. **Action understanding surveys through the years.** For each survey, we identify the coverage of temporal scopes (recognition/Rec., prediction/Pred., forecasting/For.), broad objectives (multi-modality/MM, self-supervision/SSL, multi-view/MV), and specific tasks (human interactions/HI, long video understanding/LVU).

Author(s)	Year	#Papers	Temporal Scope			Objectives			Tasks	
			Rec.	Pred.	For.	MM	SSL	MV	HI	LVU
Aggarwal et al (1994)	1994	69	(partially)							
Cedras and Shah (1995)	1995	76	(partially)							
Aggarwal et al (1998)	1998	104	(partially)							
Aggarwal and Cai (1999)	1999	51	(partially)							
Moestlund and Granum (2001)	2001	155	(partially)							
Buxton (2003)	2003	88	(partially)						✓	
Moestlund et al (2006)	2006	424	✓			(partially)				
Yilmaz et al (2006)	2006	160	(partially)	(partially)					(partially)	
Turaga et al (2008)	2008	144	✓			(partially)			✓	
Poppe (2010)	2010	180	✓							
Weinland et al (2011)	2011	153	✓			(partially)		(partially)	✓	
Chaaraoui et al (2012)	2012	123	✓			(partially)		✓	✓	
Metaxas and Zhang (2013)	2013	188						(partially)	✓	
Vishwakarma and Agrawal (2013)	2013	231	✓			(partially)				
Herath et al (2017)	2017	161	✓							
Wang et al (2018d)	2018	182	✓	(partially)		(partially)		(partially)	(partially)	
Dhiman and Vishwakarma (2019)	2019	208			✓	(partially)			(partially)	
Hussain et al (2019)	2019	141	✓			✓		(partially)	✓	
Stergiou and Poppe (2019)	2019	178	✓						✓	
Yao et al (2019)	2019	106	✓							
Zhang et al (2019b)	2019	127	✓							
Beddiar et al (2020)	2020	237	✓		(partially)			(partially)	✓	
Ramachandra et al (2020)	2020	109		✓						
Zheng et al (2020a)	2020	317				✓				
Rasouli (2020)	2020	333		✓						
Pareek and Thakkar (2021)	2021	218	✓			(partially)				
Rodin et al (2021)	2021	156			✓	(partially)		✓		✓
Song et al (2021)	2021	157	✓							
Sun et al (2022b)	2022	503	✓			(partially)	✓			
Kong and Fu (2022)	2022	337	✓	(partially)				✓	(partially)	
Hu et al (2022c)	2022	168	✓		✓				✓	(partially)
Oprea et al (2022)	2022	211	✓	✓						
Schiappa et al (2023)	2023	216	✓				✓	✓		✓
Selva et al (2023)	2023	209	✓							
Wang et al (2023a)	2023	229	✓			(partially)		(partially)		
Zhong et al (2023b)	2023	207	✓		✓	✓	✓	✓		✓
Ding et al (2023)	2023	168	✓					✓		(partially)
Tang et al (2023)	2023	338	✓			✓	✓	(partially)		✓
Plizzari et al (2024)	2024	367	✓		✓	✓	✓	✓	✓	✓
Madan et al (2024)	2024	367	✓			✓	✓		✓	✓
Lai et al (2024)	2024	202		(partially)	✓	✓		✓		✓
Stergiou and Poppe (this survey)	2024	1154	✓	✓	✓	✓	✓	✓	✓	✓

spatially and temporally localize motions. Template-based methods have been explored using local patches (Shechtman and Irani 2005), through correlation filters (Rodriguez et al 2008), and with voxel similarity (Ke et al 2007). Another line of research has considered temporal pattern discovery by directly tracking visual features over time (Cipolla and Blake 1990; Isard and Blake 1998; Rohr 1994).

**Local descriptors.** Template-based approaches can capture the general essence of actions. However, they provide limited flexibility for representing varying degrees of noise, partial occlusions, and viewpoint variations. Motivated by the observation that actions can be characterized through appearance changes over time, approaches have also been designed to associate local feature changes with actions. Mikolajczyk and Uemura (2008) clustered local features to tree representations and related them to action categories. Similarly, pose-

based primitives (Thureau and Hlavác 2008), temporal bins (Nowozin et al 2007), pictorial structures (Tran et al 2012), and graphical structures of the actions (Ni et al 2014) have been explored with local descriptors. Other approaches (Gupta et al 2009; Yao and Fei-Fei 2010) cast action recognition as a two-step structural connectivity task by recognizing parts of objects and understanding actions through pose. Several methods have extended this notion to individual regions (Ikizler-Cinbis and Sclaroff 2010), poselet clusters (Pishchulin et al 2013), decision trees (Rahmani et al 2014), and covariance matrices (Kviatkovsky et al 2014).

**Spatial convolutions.** Convolutions can efficiently extract local patterns from visual inputs. An early application of Convolutional Neural Networks (CNNs) to video (Karpathy et al 2014) temporally fused spatial frame embeddings over pre-defined sets of layers. Others explored the factorization of frame embed-

dings (Sun et al 2015), frame ranking (Fernando et al 2015), pooling (Fernando et al 2016), salient region focus (Girdhar and Ramanan 2017; Zong et al 2021), and relation reasoning between neighboring frames (Zhou et al 2018a). Le et al (2011) spatially convolved videos over combinations of the spatial and temporal dimensions. Seminal efforts focused on single volumes to represent motion (Bilen et al 2016; Chung and Zisserman 2016; Iosifidis et al 2012) or learned the correlation and exclusion between action classes (Hoai and Zisserman 2015). Tran et al (2018) proposed convolutional blocks based on spatial (2D) and temporal (1D) kernels to create more efficient video models. Lin et al (2019) reduced redundancies by shifting features at subsequent frames, while later adaptations also included conditional gates (Sudhakaran et al 2020).

**Temporal recursion.** A parallel line of research has focused on extracting motion patterns with recurrent layers (Ballas et al 2015; Dwibedi et al 2018; Perrett and Damen 2019; Yue-Hei Ng et al 2015; Ullah et al 2017), from the static frame features of spatial CNNs. Several works have jointly encoded frame features and learned changes in appearance over time with Convolutional LSTMs (Donahue et al 2015; Srivastava et al 2015). Similarly, for multi-actor action recognition, Wang et al (2017b) used three individual pathways with LSTMs for person action, group action, and scene recognition.

**Two-stream models.** An alternative group of approaches included a parallel motion-specific stream in spatial CNNs. Two-stream models (Simonyan and Zisserman 2014) encode motion and appearance explicitly with respective optical flow and RGB streams over stacks of frames. Extensions (Feichtenhofer et al 2016) have fused flow and spatial streams at intermediate layers while other approaches used cross-stream connections (Feichtenhofer et al 2017), multiple appearance streams (Tu et al 2018), recurrent layers (Singh et al 2016), or concatenated appearance and motion volumes (Jain et al 2015a; Wang et al 2017c) to share information between the streams. Wang et al (2016b) used a step-based approach that segmented videos into individual snippets, processed them in parallel, and fused class scores from each snippet. Improvements in inference speeds of two-stream models have been achieved with the addition of motion vectors (Zhang et al 2016) or key volume mining (Zhu et al 2016). Although such approaches have established a new research direction in modeling videos, the representation of motion with precomputed motion features limits the capabilities of learned backbones (Sevilla-Lara et al 2019).

### 2.3 Jointly encoding space and time

Time and appearance can also be encoded jointly.

**Part-based representations.** SpatioTemporal Interest Points (STIPs) (Laptev and Lindeberg 2003) extended spatial interest point detection methods (Förstner and Gülch 1987; Harris et al 1988) to the video domain. Liu and Shah (2008); Oikonomopoulos et al (2005) explored salient points based on peaks of activity variation. STIP features have been quantized in histograms of codewords (Schuldt et al 2004). Several approaches have studied action-relevant temporal locations across viewpoints (Yilmaz and Shah 2006) and view-invariant trajectories (Sheikh et al 2005). Dollár et al (2005) proposed modeling periodic motions using sparse distributions of points of interest. This feature extractor prompted subsequent works (Niebles et al 2008) with actions classified through a codebook of features.

**Holistic stochastic representations.** Actions have also been modeled based on global information. Efros et al (2003) created representations for different body parts and regressed towards representations of pre-classified actions. Subsequent works have explored action descriptors focused on object shapes (Gorelick et al 2006; Jia and Yeung 2008), movements (Sun et al 2009), and spatiotemporal salient regions (Wong and Cipolla 2007). They have also extended existing approaches to multiple features and temporal scales (Amer and Todorovic 2012; Liu et al 2008; Zelnik-Manor and Irani 2001; Yang et al 2020b). Later works (Blank et al 2005) adapted and generalized holistic descriptors (Gorelick et al 2006) by concatenating 2D silhouettes to form space-time shapes corresponding to action performances. Sadanand and Corso (2012) similarly proposed a bank of volumetrically pooled features containing high-level representations of the actions.

**3D CNNs.** Orthogonal to hand-crafted features, 2D convolutions have been extended in various ways to 3D spatiotemporal kernels to jointly encode space and time (Baccouche et al 2011; Ji et al 2012; Taylor et al 2010; Tran et al 2015). Subsequent works have demonstrated the potential of adapting image models to video (Hara et al 2018), explored video-specific architectures with spatiotemporal volumes across channels (Chen et al 2018c), and tiled 3D kernels (Hegde et al 2018). They have also used channel-separated convolutions (Jiang et al 2019b; Luo and Yuille 2019; Tran et al 2019), temporal residual connections (Qiu et al 2017), global feature fusion (Qiu et al 2019), resolution reduction (Chen et al 2019; Stergiou and Poppe 2021b), and related appearance to spatiotemporal embeddings (Wang et al 2018c; Zhou et al 2018d). Carreira and Zisserman (2017) integrated 3D convolutions into two-stream models for motion-

implicit appearance representations in the RGB stream and motion-explicit representations in the optical flow stream. Several works have focused on improving the efficiency of action recognition architectures (Feichtenhofer 2020; Kondratyuk et al 2021; Liu et al 2022h). They have used visual context from the scenes of actions, by either scene-type objectives (Choi et al 2019), decoupling scene and motion features (Wang et al 2021a), multi-domain information concatenation (Kapidis et al 2021), or by fusing motion and scene information (Stergiou and Poppe 2021a). To better extract temporal information, Feichtenhofer et al (2019) proposed a dual pathway video model with a slow pathway operating over low frame rates for spatial semantics and a fast pathway with a high frame rate for motion. Similarly, Wang et al (2020a) included a contrastive objective for learning the pace in videos. Xu et al (2019a) explored temporal reasoning by including clip order prediction as an additional task to improve action recognition. The extension of 3D CNNs to longer sequences by segmenting videos with multiple temporal patches has also been attempted (Ji et al 2020; Hussein et al 2019; Varol et al 2017).

**Spatiotemporal attention.** Attention is an effective approach for learning feature correspondences over space and time. Sharma et al (2015) used visual attention to localize action regions from CNN features with recurrent layers. Du et al (2017) attended over spatial features across multiple frames based on their relevance to the action. Similarly, Chen et al (2018b) aggregated and propagated global information by attending over convolution features. Wang et al (2018e) introduced non-local operations with bi-directional attention blocks over convolutions. Another early application of attention (Girdhar et al 2019) was based on region proposals and the creation of feature banks (Wu et al 2019a) in longer videos. The introduction of Vision Transformers (ViTs) (Dosovitskiy et al 2020) that encode visual information through region-based tokenization led to video-based adaptations that explored different spatiotemporal attention configurations (Arnab et al 2021a; Bertasius et al 2021). Others have explored token selection (Bulat et al 2021; Ryoo et al 2021; Zha et al 2021), and the inclusion of contextual information (Kim et al 2021c). Liu et al (2022i) introduced shifted non-overlapping attention windows to share information across patches. Feature hierarchies and latent resolution reductions have led to more compute- (Fan et al 2021; Li et al 2022e) and memory-efficient (Wu et al 2022b) architectures. Recent models such as MViT (Yan et al 2022), Hiera (Ryali et al 2023), UniFormer (Li et al 2022c), and MooG (van Steenkiste et al 2024), improved both performance and capacities of video models. SSL

has also shown great promise with pre-text tasks based on contrastive learning (Chen et al 2020c) or token masking (He et al 2022b). Xing et al (2023) increased the complexity of the contrastive objective with pseudo labels and token mixing from different inputs. Masked autoencoders have also been extended to video data (Feichtenhofer et al 2022; Wei et al 2022a). Subsequent works have explored adaptive token masking (Bandara et al 2023), double masking on both the encoder and decoder (Wang et al 2023d), token fusion (Kim et al 2024b), and teacher-student masked autoencoders (Wang et al 2023f).

**Video-language models.** Recently, language semantics from Large Language Models (LLMs) (Brown et al 2020; Touvron et al 2023) have been used as a supervisory signal for vision tasks (Li et al 2023a; Liu et al 2024a; Radford et al 2021). Initial efforts (Zellers et al 2021) matched frame-level encodings to corresponding LLM embeddings of captions. Other approaches have optimized image-based encodings over frames by pooling spatial tokens (Yu et al 2022a), including cross-modal skip connections (Xu et al 2023a), cross-attending modalities (Alayrac et al 2022), and jointly attending visual and text embeddings (Maaz et al 2023). As static features provide only an appearance-based view, works have also used spatiotemporal Vision-Language models (VLMs) (Piergiovanni et al 2024) and extended the training objective (Lu et al 2024; Zhao et al 2024b) to a two-step SSL pre-training with video-to-text alignment and video masking.

### 3 Video datasets comprising human actions

Significant efforts have been made to collect video datasets for various action understanding tasks. We explore two broad dataset types based on target tasks and use cases. The first set includes general-purpose datasets for pre-training and model evaluation. The second set of datasets has been collected to evaluate models on specific modalities or domains. The sets are discussed in Section 3.1 and Section 3.2, respectively.

#### 3.1 General datasets

The past two decades have seen a significant increase in dataset size, leading to more robust baselines. We present widely-adopted benchmarks chronologically in Table 2. The primary focus of initial benchmarks (Schuldt et al 2004; Gorelick et al 2007) has been the categorization of simple actions such as *walking* and

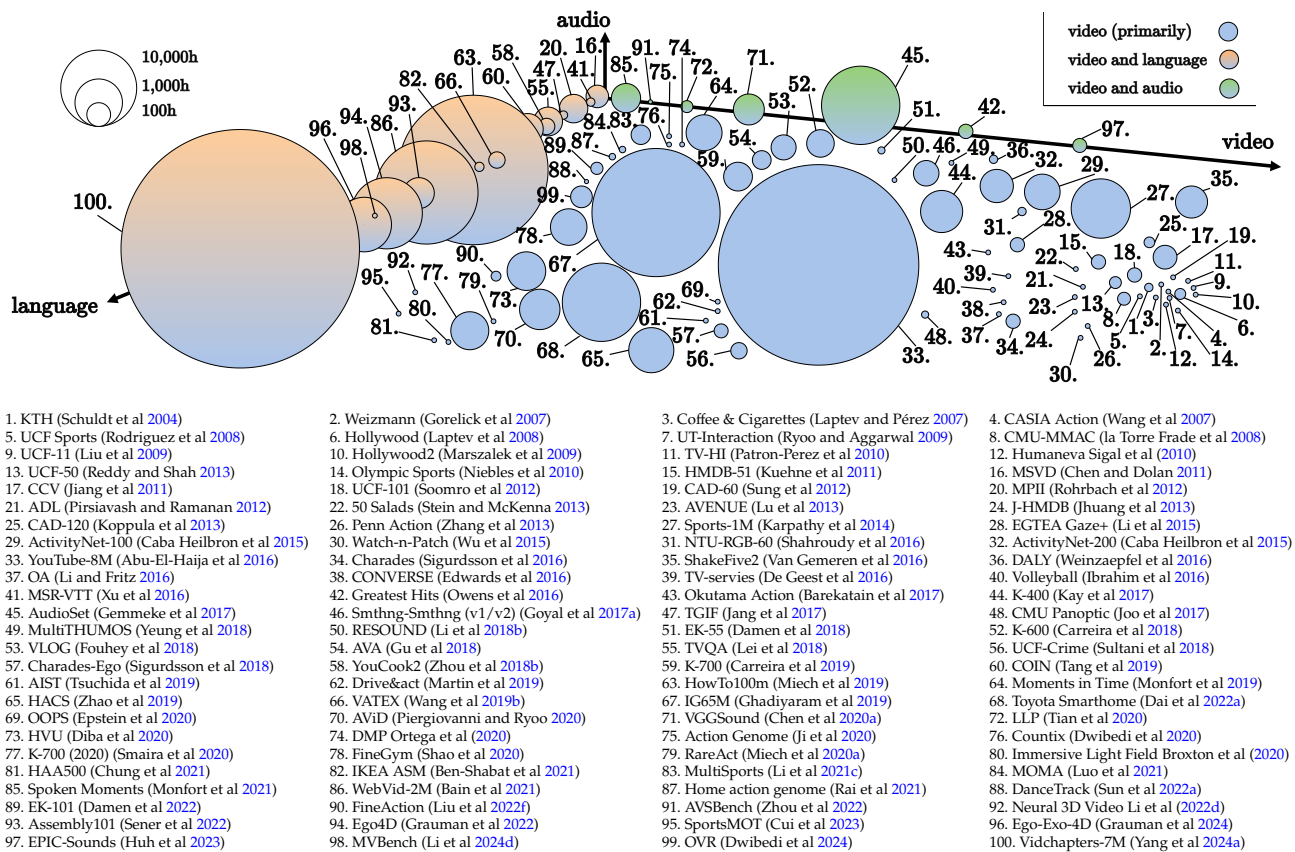

Fig. 3. Datasets compared by total dataset duration and primary modality. Circle sizes correspond to the (approximate) summed duration of all videos in the datasets. Recent datasets (i.e., > 80) have longer total running times and include additional modalities such as language or audio.

*hand waving*. Subsequent datasets predominantly comprised videos from either TV shows/movies (Laptev and Pérez 2007; Laptev et al 2008; Marszalek et al 2009; Patron-Perez et al 2010; Kuehne et al 2011) or sports footage (Rodriguez et al 2008; Liu et al 2009; Reddy and Shah 2013; Niebles et al 2010). Important steps towards establishing large-scale datasets for the video domain were made with the introduction of Sports-1M (Karpathy et al 2014), YouTube-8M (Abu-El-Haija et al 2016), and Kinetics (Carreira and Zisserman 2017) that include web-sourced videos of a diverse range of actions. Evident from their sizes shown in Figure 3, these datasets paved the way as general benchmarks for models that can subsequently be adapted to smaller, more niche datasets such as UCF-101 (Soomro et al 2012) and ActivityNet (Caba Heilbron et al 2015). Despite their size and use in multiple downstream tasks, there is still room to address specific action understanding tasks or modalities supplementary to vision. Domains such as egocentric vision, human-object interaction recognition, and hierarchical

action understanding have gained popularity, prompting the creation of domain-specific datasets. EGTEA Gaze+ (Li et al 2015), EPIC KITCHENS (Damen et al 2022), and later EGO4D (Grauman et al 2022) have been the main benchmarks for egocentric vision. Something-Something (Goyal et al 2017a) and Charades (Sigurdsson et al 2016) have been predominantly used as benchmarks for object-based actions with a greater focus on temporal information. Datasets such as Diving-48 (Li et al 2018b) and FineGym (Shao et al 2020) incorporate semantic hierarchies in their annotations. More recent datasets have focused on tasks related to action recognition including instruction learning (Alayrac et al 2016; Bansal et al 2022; Ben-Shabat et al 2021; Liu et al 2024g; Ohkawa et al 2023; Sener et al 2022; Tang et al 2019), action phase alignment (Sermanet et al 2017), repeating action counting (Dwibedi et al 2020, 2024; Hu et al 2022a; Runia et al 2018; Zhang et al 2020), action completion prediction (Epstein et al 2020), driver behavior recognition (Martin et al 2019; Ortega et al 2020), anomaly detection (Acintoae et al 2022; Liu et al 2018b;

**Table 2. Action understanding datasets.** Works are grouped by year of release (Y). The number of classes, video instances, and actors are denoted with #Cls, Inst, and Act. The average duration per annotation is denoted as AD. Short descriptions per dataset appear in the Context column.

Y Dataset	#Cls/Inst/Act/AD	Context	
2004-2007	KTH (Schuldte et al 2004)	6/2K/25/2.5s	Grayscaled videos of motions
	Weizmann (Gorelick et al 2007)	10/90/8/12s	Low-res. atomic motions
	Coffee&Cigarettes (Laptev and Pérez 2007)	2/245/5/5s	Smoking/drinking in movies
	CASIA Action (Wang et al 2007)	15/1446/24/NA	Outdoor activities
2008-2014	UCF Sports (Rodriguez et al 2008)	9/150/<100/5s	Sports videos
	Hollywood (Laptev et al 2008)	8/475/<100/16s	Actions in movies
	UT-interaction (Ryoo and Aggarwal 2009)	6/90/60/17s	Dyadic human interactions
	CMU-MMAC (la Torre Frade et al 2008)	5/182/43/7m	Multi-view recipe preparations
	UCF-11 (Liu et al 2009)	11/1K/100+/5s	Actions in YouTube videos
	Hollywood2 (Marszalek et al 2009)	12/3K/100+/12s	Actions from movies
	TV-HI (Patron-Perez et al 2010)	4/300/100+/3s	Interactions in TV shows
	UCF-50 (Reddy and Shah 2013)	50/5K/100+/15s	Web-sourced videos
	Olympic Sports (Niebles et al 2010)	16/800/100+/3s	Actions in sports
	HMDB-51 (Kuehne et al 2011)	15/7K/100+/3s	Actions from movies
	CCV (Jiang et al 2011)	20/9K/100+/80s	Web-sourced videos
	UCF-101 (Soomro et al 2012)	101/13K/100+/15s	Action with hierarchies
	CAD-60 (Sung et al 2012)	12/60/<30/45s	Atomic actions in RGB-D
	MPII (Rohrbach et al 2012)	65/5.6K/100+/11m	Web-source actions
2015-2018	ADL (Pirsiavash and Ramanan 2012)	32/436/20/1.3s	Videos of daily activities
	50 Salads (Stein and McKenna 2013)	17/899/25/37s	Salad making videos
	J-HMDB (Jhuang et al 2013)	21/928/100+/1.2s	Videos with joints positions
	CAD-120 (Koppula et al 2013)	12/120/<60/45s	Extension of CAD-60
	Penn Action (Zhang et al 2013)	15/2.3K/100+/2s	Web-sourced atomic actions
	Sports-1M (Karpathy et al 2014)	487/1M/1,000+/9s	Sports actions/activities
	EGTEA Gaze+ (Li et al 2015)	106/15K/32/28s	Egocentric actions w/ gaze
	ActivityNet-100 (Caba Heilbron et al 2015)	100/5K/100+/2m	Untrimmed web videos
	Watch-n-Patch (Wu et al 2015)	21/2K/7/30s.	Daily activities in RGB-D
	NTU-RGB-60 (Shahroudy et al 2016)	60/57K/40/2s.	Multi-sensory actions
	ActivityNet-200 (Caba Heilbron et al 2015)	200/15K/100+/2m	ActivityNet-100 extension
	YouTube-8M (Abu-El-Hajja et al 2016)	NA/8M/NA/NA	Multi-labelled videos
	Charades (Sigurdsson et al 2016)	157/67K/267/30s	Daily activities videos
	ShakeFive2 (Van Gemeren et al 2016)	5/153/33/7s	Interactions with pose data
DAILY (Weinzaepfel et al 2016)	10/510/100+/4m	Untrimmed YouTube videos	
2019-2020	OA (Li and Fritz 2016)	48/480/<100/5s	Ongoing actions
	CONVERSE (Edwards et al 2016)	10/NA/NA/NA	Human interactions
	TV-Series (De Geest et al 2016)	30/6.2K/100+/2s	Actions from TV series
	Volleyball (Ibrahim et al 2016)	6/1.4K/<100/<1s	Group actions in volleyball
	MSR-VTT (Xu et al 2016)	200K/7.1K/1,000+/20s	Video captions
	Okutama Action (Barekatin et al 2017)	12/4.7K/~400/60s	Aerial views of action
	K-400 (Kay et al 2017)	400/306K/1,000+/10s	Web-sourced short actions
	Smthng-Smthng v1 (Goyal et al 2017a)	174/109K/100+/4s	Human actions with objects
	MultiTHUMOS (Yeung et al 2018)	65/39K/100+/3s	Densely labeled actions
	Diving-48 (Li et al 2018b)	48/18K/NA/3s	Diving sequences
	EK-55 (Damen et al 2018)	2,747/40K/35/3s	Egocentric actions in kitchens
	K-600 (Carreira et al 2018)	600/495K/100+/10s	Extension of K-400
	VLOG (Fouhey et al 2018)	30/122K/10.7K/10s	Actions in lifestyle VLOGs
	AVA (Gu et al 2018)	80/430/100+/15m	Localized atomic actions
2019-2020	NTU-RGB-120 (Shahroudy et al 2016)	120/114K/106/2s.	Multi-sensory actions
	Charades-Ego (Sigurdsson et al 2018)	156/7.8K/100+/9s	Daily indoor activities
	Smthng-Smthng v2 (Goyal et al 2017a)	174/221K/100+/4s	Human actions with objects
	K-700 (Carreira et al 2019)	700/650K/1,000+/10s	Extension of K-600
	Moments in Time (Monfort et al 2019)	339/1M/1,000+/3s	Short dynamic scenes
	HACS (Clips) (Zhao et al 2019)	200/1.5M/1,000+/2s	Action over fixed durations
	IG65M (Ghadiyaram et al 2019)	NA/65M/NA/NA	Actions in Instagram videos
	Toyota SmartHome (Dai et al 2022a)	31/16K/18/21m	Senior home activities
	AViD (Piergiiovanni and Ryoo 2020)	887/450K/1,000+/9s	Anonymized videos
	HVU (Diba et al 2020)	3K/572K/1,000+/10s	Hierarchy of semantics
	Action-Genome (Ji et al 2020)	453/10K/100+/1s	Daily home activities
	K-700 (2020) (Smaira et al 2020)	700/647K/1,000+/10s	Update of K-700
	FineGym (Shao et al 2020)	530/33K/100+/10m	Gymnastics videos
	RareAct (Miech et al 2020a)	122/7.6K/100+/10s	Unusual actions
HAA500 (Chung et al 2021)	500/10K/1,000+/2s	Atomic actions	
MultiSports (Li et al 2021c)	4/3.2K/100+/21s	Localized sports actions	
MOMA (Luo et al 2021)	136/12K/100+/10s	Hierarchical actions	
WebVid-2M (Bain et al 2021)	NA/2M/1,000+/4s	Video-image pairs	
HOMAGE (Rai et al 2021)	453/5.7K/40/2s	Extension of (Ji et al 2020)	
EK-100 (Damen et al 2022)	4,053/90K/37/3s	Egocentric actions	
FineAction (Liu et al 2022f)	106/103K/1,000+/7s	Hierarchies for TAL	
EGO4D (Grauman et al 2022)	1000+/9.6K/931/48s	Diverse egocentric videos	
Assembly-101 (Sener et al 2022)	1.3K/4.3K/53/2s	Procedural activities	
Ego-Exo-4D (Grauman et al 2024)	689/5,035/740/5m	Multi-modal multi-view videos	

Lu et al 2013; Sultani et al 2018; Wu et al 2020a), hand-object interactions (Chao et al 2021; Garcia-Hernando et al 2018; Hampali et al 2020; Kwon et al 2021; Moon et al 2020; Mueller et al 2017), and object state change detection in actions (Souček et al 2022).

### 3.2 Domain- and modality-specific datasets

Apart from general-purpose datasets, several benchmarks have been designed to evaluate model capabilities of specific aspects of action understanding. We overview benchmarks in three groups: based on the holistic understanding of scenes from multiple viewpoints, and with supplementary modalities such as language and audio.

**Multi-view.** Initial efforts to compile multi-view videos included a small number of subjects (Sigal et al 2010) or synthetic data (Ionescu et al 2013). High-quality multi-view videos depend highly on the hardware and setup (Wang et al 2023e). CMU panoptic (Joo et al 2017) captured group interactions within a dome with 480 cameras. Interactions included social settings, games, dancing, and musical performances. ZJU-Mocap (Peng et al 2021) comprised dynamic videos of human motions from 20 cameras. The Immersive Light Field dataset (Broxton et al 2020) contains videos with 6 degrees of freedom from a camera rig consisting of 46 action cameras. Multi-view datasets are collected for a variety of target tasks, including 3D video synthesis of human actions and interactions in indoor (Li et al 2022d) and outdoor (Lin et al 2021b; Yoon et al 2020) settings, dance sequence reconstruction (Tsuchida et al 2019), and the dynamic synthesis of indoor spaces in which actions take place (Tschernezki et al 2024).

**Video-language.** In recent years, language has been integrated into vision methods as a natural extension to represent high-level semantics. Commonly, learning to map textual concepts and visual representations in a shared embedding space has been a widely adopted strategy by many video tasks (Amrani et al 2021; Gabeur et al 2020; Liu et al 2019; Miech et al 2020b). Initial video-language datasets (Chen and Dolan 2011; Xu et al 2016) were based on short video snippets and short textual descriptions of actions. More recent efforts also provide multilingual descriptions (Wang et al 2019b). Video question-answering is a popular language-based task (Jang et al 2017; Lei et al 2018; Li et al 2024d; Onicescu et al 2021; Rawal et al 2024; Xiao et al 2021). The order of instructions has been of great interest in longer videos since the introduction of HowTo100M (Miech et al 2019) and YouCook2 (Zhou et al 2018b). Benchmarks have also been proposed for other long-form tasks such as moment retrieval (Rohrbach et al 2015; Song et al 2024; Yang et al 2024a), frame extraction (Li et al 2024a), multi-modal open-ended question answering (Fu et al 2024; Ying et al 2024), and long-term reasoning (Chandrasegaran et al 2024; Fei et al 2024b; Mangalam et al 2023).



**Audio and vision.** Human perception often relies on the inclusion of audio for understanding actions, especially in conditions where appearance may lead to ambiguous predictions. Audioset (Gemmeke et al 2017) is the largest audio-visual action dataset containing 2.1M clips across a long-tail distribution of 527 classes. VGG-Sound (Chen et al 2020a) is another common benchmark with a uniform distribution of 200K videos over 300 classes. Datasets have also been collected for specific tasks such as audio-visual semantic segmentation (Zhou et al 2022), audio-visual video parsing (Tian et al 2020), material sound and action classification (Huh et al 2023; Owens et al 2016), and video captioning (Monfort et al 2021).

The introduction of both general and task-specific datasets has improved the exploration of video tasks and standardized evaluation protocols. Main lines of research and challenges of these tasks are overviewed next.

## 4 Recognizing observed actions

The recognition of actions in videos is a fundamental computer vision research theme. Relevant tasks focus on different aspects of the actions observed in full. We start by discussing approaches for optimizing model inputs in Section 4.1. We then overview popular temporal-based recognition tasks in Section 4.2. Tasks based on the semantic relationships between language and video are discussed in Section 4.3, whereas audio-visual and other multi-modal approaches appear in Section 4.4.

### 4.1 Video reduction methods

Video inputs typically consist of tens to hundreds of highly visually similar frames. The uniform use of all frames can lead to an unsustainable computational burden. However, humans process stimuli selectively (Eagelman 2010). Several recognition approaches in computer vision aim to reduce compute and improve memory utilization by considering inputs selectively.

#### 4.1.1 Challenges

Reducing frame-level redundancies in videos requires a high-level understanding of each temporal segment’s relevance. The distinction and selection of relevant segments directly impact information loss. Long and complex scenes present significant challenges to video reduction methods. This *uneven context inclusion* requires more efficient utilization of the model’s capacity.

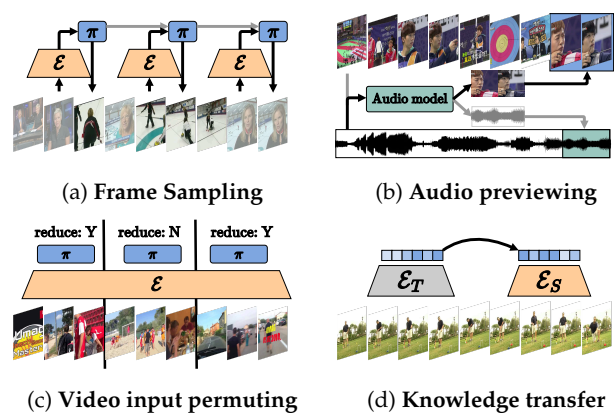

Fig. 4. **Redundancy reduction methods** include (a) selection of task-specific salient frames, (b) use of supplementary modalities such as audio to preview relevant regions to sample from, (c) input permutations to compress irrelevant frames and segments, and (d) using embeddings from a teacher model as targets.

#### 4.1.2 Approaches

Among the most common approaches for reducing redundancies is *frame sampling*. Works on frame sampling rely on policy networks that select frames based on the action’s complexity (Ghodrati et al 2021; Yeung et al 2016), video context correspondence (Wu et al 2019c), or changes in the target class’ probability (Korbar et al 2019). Wang et al (2021b) used a recurrent network to localize action-relevant regions. Subsequent extensions targeted early stopping (Wang et al 2022d) and related local and global features to determine action-relevant patches (Wang et al 2022e). Xia et al (2022b) used pseudo labels obtained by computing the embedding distance to class centroids to distinguish individual frames as salient and non-salient. Other approaches have used reward functions based on predictions from the selected frames (Wu et al 2020d), combined frame-level and video-level predictions (Gowda et al 2021), optimized towards balancing accuracy and number of frames used (Wu et al 2019b), or removed tokens in transformer architectures (Wu et al 2024b).

A related set of approaches has extended unimodal frame sampling with *audio previewing*. Gao et al (2020) used both frame and audio features with a recurrent network to predict the next informative moment in the video. The video resolution used by the model was determined based on discovered informative parts in the audio stream. Similarly, Nugroho et al (2023) used a saliency loss to localize the informative audio segments from which the corresponding video frames can be sampled.

Although coarse frame sampling can be beneficial in short videos, selecting a limited number of frames in longer videos with a broader context can result in information loss. Another line of research thus studies redundancy reduction through *video input permutations*. These works change frame resolutions based on classifier confidence (Meng et al 2020) or quantize frames at different precision (Abati et al 2023; Sun et al 2021b). Zhang et al (2022c) used a two-branch approach for lightweight computations over large, less-relevant segments, and assigned more compute for segments with relevant context similar to (Feichtenhofer et al 2019).

Recent efforts have also used *knowledge distillation* to improve the training efficiency of video model pipelines. Ma et al (2022a) reduced computations by learning to match student network features from videos with reduced resolution to the full-resolution features from a teacher network. Kim et al (2021b) extended this approach by using cross-attention to learn the correspondence between teacher and student features. Distillation approaches have also used non-vision teacher models. Lei et al (2021b) bound language embeddings to sparsely sampled clips from long videos while Xia et al (2022a) used embeddings from textual event-object relations to discover salient frames. Tan et al (2023b) proposed a reconstruction approach for interpolating egocentric video features using embeddings from partial frames and the camera motion for the unobserved frames.

#### 4.1.3 Future outlooks

Context-aware models can significantly improve both processing times and performance. Although most video reduction methods are primarily evaluated on classification or detection, more recent action understanding models have been optimized on multi-task and multi-domain objectives. This makes the discovery of relevant frames more difficult. For example, suppressing background frames is sub-optimal for episodic memory in which specific locations or attributes of objects not directly relevant to a current action need to be inferred. We expect that future redundancy reduction methods will focus more on preserving general scene information rather than ensuring that semantics of objects in the scene are not lost. This can be potentially achieved by discovering informative frames for diverse tasks or distilling scene context in low-memory representations, *e.g.* language embeddings.

## 4.2 Temporal-based tasks

The perception of actions across time is a complex capability of human cognition. Understanding the timing of events is crucial for developing motor memory (Eagleman 2010) for actions such as moving, speaking, and determining the causality of perceived temporal patterns. The importance of processing temporal information efficiently by computer vision systems has been shown through both standard performance metrics and semantic benchmarks (Albanie et al 2020; Stergiou and Deligiannis 2023). We provide a visualization of temporal-based tasks in Figure 5 with the main challenges and task details discussed below.

### 4.2.1 Challenges

For most tasks, action categories are inferred directly without an explicit notion of their complexity based on **levels of abstraction**, *e.g.*, atomic movements, composite motions, singular actions, or general activities. Although some datasets include action hierarchies (Shao et al 2020; Li et al 2018b), these relationships are only used by a handful of existing works (Long et al 2020). Different levels of abstraction typically have different temporal ranges, which require different approaches to process visual inputs. Moreover, there can be substantial temporal variations across class instances. This leads to larger temporal distances between discriminative information in videos, requiring proper extraction and modeling of long-range dependencies. We discuss solutions to cope with these variations in this section.

### 4.2.2 Temporal localization

A well-established video task is the discovery and classification of the actions performed alongside their temporal segments. Temporal Action Localization (TAL) aims to infer the action categories alongside the start and end times of the corresponding locations in untrimmed videos.

Early attempts have used Improved Dense Trajectories (Wang and Schmid 2013) and Fisher vectors (Oneata et al 2013) to model the temporal dynamics of local points in scenes. Shou et al (2016) was one of the first to approach TAL with a joint action proposal and classification objective with a regional CNN. This joint optimization has been adapted with spatial- and temporal-only networks (Lin et al 2018; Paul et al 2018; Wang et al 2017a), regional proposal selection (Chao et al 2018; Xu et al 2017b), and intra-proposal relationships with graph convolutions (Zeng et al 2019) in subsequent works. Shou et al (2017) predicted granularities

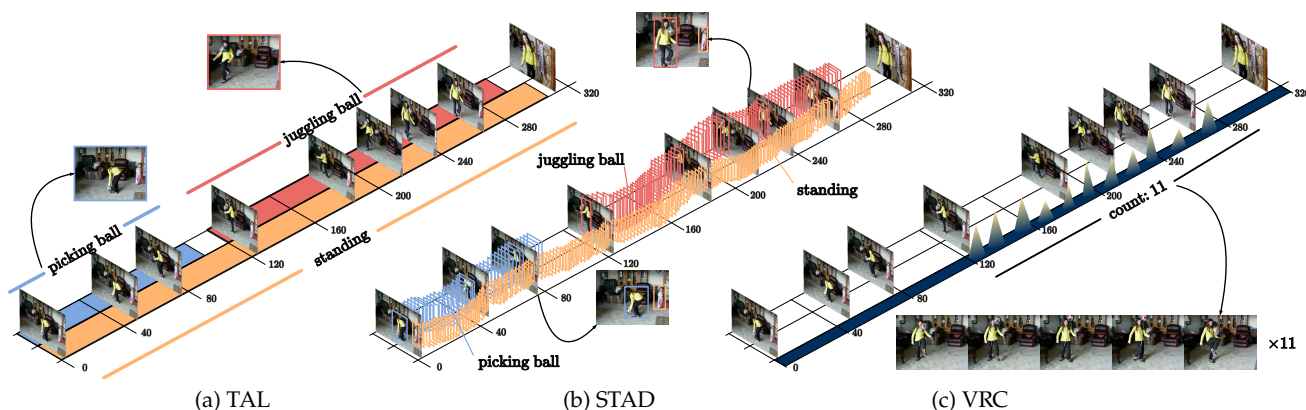

Fig. 5. **Visualization of temporal-based tasks.** (a) Temporal Action Localization (TAL) discovers the start and end times of individual actions. In contrast, (b) Spatio-Temporal Action Detection (STAD) is more complex as it requires temporally and spatially localizing actions with bounding boxes for actors and objects over time. Distinctively, (c) Video Repetition Counting (VRC) is not based on action labels and instead requires counting repetitions of actions or motions in an open-set setting. Video source from (Kay et al 2017).

at a frame level by transposing the temporal resolution of pretrained video encoders. More recent approaches for TAL can be categorized into three broad categories.

**One-stage.** Most similar to the aforementioned methods, one-stage approaches localize and classify actions in a single step by using hierarchical embeddings from feature pyramids (Lin et al 2021a; Liu and Wang 2020; Shi et al 2023; Zhang et al 2022b) or relating relevant video segments (Shou et al 2018; Yang et al 2020c). Recently, Yan et al (2023b) integrated scene semantic context for TAL with the inclusion of vision-language encoders. The start and end frames of an action can often be ambiguous. A set of approaches have relaxed deterministic start-end times objectives either by weighing the training loss with the importance of each frame (Shao et al 2023) or by learning distributions of possible start and end times (Moltisanti et al 2019). These approaches aimed to introduce a variance prior to the typical duration of the action.

**Two-stage.** Two-stage approaches disentangle the optimization into separate parts. Zhai et al (2020) combined proposals from spatial- and temporal-only streams into a fused final prediction. Chen et al (2022a) used long- and short-range temporal information to refine the confidence of the generated action proposals. Huang et al (2019) decoupled classification and localization to two objectives during training with two separate models that use cross-modal connections for exchanging information. Some works have focused on maximizing the embedding difference between representations of frames from action segments and non-relevant frames either with positive and negative instances (Luo et al

2020; Zhang et al 2021a) or by a scoring function (Rizve et al 2023). Methods have also improved the features of backbone encoders with TAL-relevant pretext tasks (Zhang et al 2022a). A number of two-stage methods process videos holistically (Alwassel et al 2021; He et al 2022a; Liu et al 2021d; Qing et al 2021). Alwassel et al (2021) encoded local features over a sliding window using aggregated features from multiple local encoders. The model was optimized with a dual objective for discovering action regions and classifying every segment. Graphs have also been adopted for TAL with Bai et al (2020) using generated candidate proposals for the graph’s start and end edges and their connected nodes. Zhao et al (2021) created a graph of hierarchical features over multiple temporal resolutions. More recent approaches (Nag et al 2023) have formulated proposal prediction as a denoising task with noisy action proposals as input to a diffusion model conditioned on the video. Recent approaches have also used pretrained LLMs for TAL with specific Contrastive Language-Image pretraining (CLIP) query embeddings (Ju et al 2022), video representation masks adapted to the CLIP text encoder space (Nag et al 2022), and CLIP text and visual features that are correlated to foreground masks learned from the video (Phan et al 2024).

**DEtection TRansformers (DETR).** A recent set of methods is based on adapting image-based DETR (Carion et al 2020) to TAL. These approaches rely on transformer encoder-decoders to create regional proposals optimized with bipartite matching. Tan et al (2021b) adapted DETR to video with a matching scheme of multiple positive action proposals to address sparsity

in temporal annotations. Subsequent works have optimized the detection pipeline by either including dense residual connections (Zhao et al 2023) or caching short-term features (Cheng and Bertasius 2022; Hong et al 2022a). Liu et al (2024d) increased the model capacity by training intermediate adapters propagating information to the decoder from intermediate frozen encoder layers. Approaches have also explored training recipes with sparsely updating model layers (Cheng et al 2022), vision-language pretraining distillation (Ju et al 2023), proposal hierarchies (Wu et al 2023a), and end-to-end TAL encoder-decoder optimization (Liu et al 2022e). Works aiming to reduce training requirements have also been based on language embeddings with tuned visual-language projectors (Liberatori et al 2024) and by start/end queries (Aklilu et al 2024).

#### 4.2.3 Spatiotemporal detection

SpatioTemporal Action Detection (STAD) is related to TAL but aims to jointly localize actions temporally and spatially detect action-relevant actors and objects. The main challenge of STAD methods is consistently linking detections and temporal action proposals across frames. Similar to TAL, two general directions can be used to overview relevant literature.

**Two stages.** Building upon the advancements of image-based object detectors (Girshick et al 2014; Girshick 2015), the majority of STAD approaches first detect objects and then temporally localize actions by tracking object candidates (Jain et al 2014; Weinzaepfel et al 2015), ROI-pooling RGB and flow features (Peng and Schmid 2016), refining proposals iteratively (Soomro et al 2015), aligning source and target domain features (Agarwal et al 2020), or using the general action level in the video as context (Mettes et al 2016). Li et al (2018a) built upon prior two-stage detection works and incorporated recurrent proposals to include temporal context. Other approaches that focus on temporal information Singh et al (2017) used the arrow of time with different portions of the video detected at each step. Later benchmarks included longer videos to focus on activity-related tasks (Gu et al 2018) enabling the greater exploration of context with feature banks (Feng et al 2021b; Pan et al 2021a; Tang et al 2020a; Wang and Gupta 2018; Wu et al 2019a, 2022b) and supplementary object information (Arnab et al 2021b; Hou et al 2017; Zhang et al 2019d). Additional information such as keyframe saliency maps (Li et al 2020b; Ulltan et al 2020), hands and poses (Faure et al 2023), actor-object relations (Sun et al 2018), and SSL (Wang et al 2023d) have also been explored. Alwassell et al (2018) analyzed the benefits of two-stage approaches

and showed that they are primarily performant in handling temporal context. However, they also note that a significant limitation of two-stage approaches is that features are computed from backbones trained over auxiliary video tasks, potentially missing specific discriminative information.

**Single-stage.** Drawing inspiration from single-stage object detection methods (Carion et al 2020; Redmon et al 2016; Liu et al 2016), single-stage STAD approaches use an end-to-end trained unified framework for joint localization and detection (Chen et al 2021b; Girdhar et al 2019; Zhu et al 2024b). Ntinou et al (2024) extended the bipartite matching loss from Carion et al (2020) to spatio-temporal tokens. Other approaches used adaptive feature sampling (Wu et al 2023d), conditionally modeled visual features based on motion (Zhao and Snoek 2019), and contrasted different views (Kumar and Rawat 2022). Directly predicting tubelets has also been adopted by recent approaches (Gritsenko et al 2024; Kalogeiton et al 2017; Song et al 2019; Yang et al 2019; Zhao et al 2022). Kalogeiton et al (2017) stacked embeddings from a backbone applied over a sliding window and regressed both classes and tubelets over the entire video. Zhao et al (2022) used an encoder-decoder to generate tubelet queries and cross-attended them to visual features. Gritsenko et al (2024) generated candidate tubelets from condensed query representations cross-attended by features from each frame. Beyond STAD, tubelets have also been used as a self-similarity pretraining objective (Thoker et al 2023) to enforce correspondence of videos from different domains but with similar local motions.

#### 4.2.4 Repetition counting

Video Repetition Counting (VRC) aims to count the number of action repetitions. In contrast to TAL and STAD, VRC is an open-set task and does not require action categories.

Early works on signal periodicity (Thangali and Sclaroff 2005) have decomposed signal repetition with a Fourier analysis (Albu et al 2008; Briassouli and Ahuja 2007; Azy and Ahuja 2008; Cutler and Davis 2000; Pogalin et al 2008). Signal-based works have also used the direction of motion flow over time (Runia et al 2018) to count repetitions. Another set of methods approached VRC as a classification task over a finite set of maximum repetitions. Lu and Ferrier (2004) used dynamic parameters based on the Frobenius norm to classify changes corresponding to action end times. Zhang et al (2021e) fused audio and video representations while Zhang et al (2020) used multiple cycles to refine the repetition count prediction. Li et al (2024h) ex-

Table 3. **SSL methods and video task adaptations.** Three learning paradigms are used to group pre-text tasks.

Learning	Task	Method	Video adaptations <sup>1</sup>
Context-based	Arrow of Time		Benaim et al (2020), Dwibedi et al (2018), Destro and Gygli (2024), Donahue and Elhamifar (2024), Salehi et al (2023), Wei et al (2018), Wu and Wang (2021)
	Jigsaw		Kim et al (2019), Lee et al (2017), Liu et al (2024b), Misra et al (2016), Wang et al (2022a), Xu et al (2019a)
	Colorization		Ali et al (2023), Dhiman et al (2023), Jabri et al (2020), Liu et al (2024h), Vondrick et al (2018), Wu et al (2020b), Zhang et al (2023d)
Contrastive	Negative Samples	MoCo (He et al 2020)	Feichtenhofer et al (2021), Han et al (2020a), Kuang et al (2021), Liu et al (2021c), Ma et al (2021), Pan et al (2021b), Qian et al (2021), Xu and Wang (2021), Yao et al (2021)
		SimCLR (Chen et al 2020c)	Badamdorj et al (2022), Chen et al (2021a), Han et al (2020b), Jenni and Jin (2021), Sun et al (2021a), Wang et al (2020a), Yang et al (2020a), Zhang et al (2021b)
		CPC (Oord et al 2018)	Akbari et al (2021), Bagad et al (2023), Dave et al (2022), Li et al (2021a), Miech et al (2020b), Park et al (2022a), Parthasarathy et al (2023), Yang et al (2021b)
	Clustering	DIM (Hjelm et al 2018)	Bai et al (2022), Cai et al (2022), Feng et al (2023), Gordon et al (2020), Hjelm and Bachman (2020), Nan et al (2021), Sameni et al (2023), Sun et al (2019a)
		SwAV (Caron et al 2020)	Coskun et al (2022), Diba et al (2021), Long and van Noord (2023), Toering et al (2022), Wei et al (2022b), Yan et al (2020)
	Self-Distillation	BYOL (Grill et al 2020)	Escontrela et al (2023), Liu et al (2022g), Morales et al (2022), Recasens et al (2021), Ranasinghe et al (2022), Sarkar et al (2023), Xiong et al (2021), Zhang et al (2022d)
DINO (Caron et al 2021)		Ding et al (2024), Fan et al (2023), Huang et al (2024b), Huang et al (2024a), Ponimatin et al (2023), Teeti et al (2023), Wang et al (2024b)	
Decorrelation	Barlow Twins (Zbontar et al 2021)	Da Costa et al (2022), Peh et al (2024), Zhang et al (2022d), Zhou et al (2023b)	
	VICReg (Bardes et al 2021)	Bardes et al (2023), Sun et al (2023), Yang et al (2023b), Yu et al (2024c)	
Masking	low-level targets	ViT (Dosovitskiy et al 2020)	Girdhar et al (2023a), Lin et al (2022c), Piergiovanni et al (2023)
		MAE (He et al 2022b)	Feichtenhofer et al (2022), Girdhar et al (2023b), Huang et al (2023a), Huang et al (2023b), Ryali et al (2023), Tong et al (2022), Wang et al (2023d), Wu et al (2023c)
	high-level targets	BEiT (Bao et al 2021)	Cheng et al (2023), Fu et al (2021), Li et al (2023f), Tan et al (2021a), Wang et al (2022b)
		data2vec (Baeviski et al 2022)	Li et al (2023c), Lian et al (2023)
	Teacher-based	MaskFeat (Wei et al 2022a)	Feichtenhofer et al (2022), Mizrahi et al (2023), Lin et al (2023a), Pei et al (2024), Stergiou et al (2024), Wang et al (2023f), Woo et al (2023), Zhao et al (2024c)

tracted action query features and classified the queries by their repetitions. In contrast to defining repetition counts as classes, Dwibedi et al (2020) adopted a temporal self-similarity matrix (BenAbdelkader et al 2004; Junejo et al 2010; Körner and Denzler 2013) to discover repetition periodicity. Subsequent methods have investigated embedding similarity matrices at multiple scales (Bacharidis and Argyros 2023; Hu et al 2022a), triplet contrastive losses (Destro and Gygli 2024), and graph representations (Panagiotakis et al 2018). Because embeddings of adjacent frames are highly similar, several recent methods have aimed to limit the discovery of correspondences in repetitions to poses (Ferreira et al 2021; Yao et al 2023), specific frames (Li and Xu 2024; Zhao et al 2024d), visual exemplars (Sinha et al 2024), or language descriptions (Dwibedi et al 2024). VRC remains a challenging task given the open-set nature and the lack of robust baselines in recent large-scale datasets (Dwibedi et al 2024).

#### 4.2.5 Future outlooks

Despite the great progress, using unified systems to generalize across tasks remains challenging. For example, STAD methods (Dai et al 2021; Tirupattur et al 2021) benchmarked on TAL perform lower than TAL-based models as their joint objective of localizing both *when* and *where* actions are performed, is significantly more challenging to optimize. Similarly, despite the task similarities between TAL and VRC, standard TAL methods do not generalize to VRC as action interruptions and out-of-distribution categories cannot be effectively segmented (Hu et al 2022a; Sinha et al 2024). The

recent introduction of unified VLMs for multiple video tasks; e.g. (Wang et al 2024d) and their use as a feature extractor in subsequent works (Chen et al 2024b), has shown a promising direction through the use of SSL. Training recipes typically include multiple stages of contrastive and masking pre-text self-supervision objectives to allow the generalization of the model to multiple tasks. Training on SSL pre-text tasks is a prominent scheme for many video-based models as shown in Table 3. A possible direction of future research can be the unification of downstream objectives through relevant pre-text tasks based on *the arrow of time*, relationships between task-specific embeddings, or clustering embeddings of semantically similar tasks.

#### 4.3 Language semantics in videos

LLMs have achieved great success in Natural Language Processing (NLP), and have consequently been adapted for action understanding tasks. The relationships between learned context-rich semantic space and visual world attributes are useful for tasks such as caption generation (Seo et al 2022; Sun et al 2019b; Wang et al 2024a), inferring scene information (Anderson et al 2018; Cheng et al 2024), understanding the general context in highlight detection (Lei et al 2021a), and instructional video learning (Miech et al 2020b). Beyond their direct applicability to language-based tasks, they can incorporate vision encoders (Ashutosh et al 2023a; Fu et al 2021; Kahatapitiya et al 2024; Song et al 2024; Xu et al 2021; Zellers et al 2021) learning general and semantically-rich representations that can then be

used as feature extractors in downstream tasks. However, notable challenges persist despite the popularity of vision-language semantic similarity pretraining for distilling context into video models.

#### 4.3.1 Challenges

Visual and language information can provide partly complementary perspectives of a video. However, as information from each modality is often heterogeneous, specific representations may not be directly matched through cross-modal correspondence, *e.g.*, due to occluded objects or fine-grained visual details about the performance of the action. Such discrepancies can arise based on domain knowledge specificity or distribution patterns of the available data (Liang et al 2024b). **Modality gap** (Liang et al 2022d), shown in Figure 6, is a phenomenon that arises in VLM training in which embeddings of each modality are represented in distinct low-variance regions in the embeddings space. In VLMs trained with cross-modal information maximization (Bain et al 2021; Lei et al 2021b; Li et al 2020a, 2022a; Zhu and Yang 2020) this effect becomes stronger with the enforcement of strong coordinate restrictions based on positive and negative cross-modal pairs. This is also relevant to difficulties in the **cross-modal context alignment** over local elements for tasks with available ground-truth pairs and global representations for tasks without vision-language pairs. In both cases, aligning language and vision context information at either the word/object level or over groups of instances in the embedding space provides a significant challenge in optimization. For generative tasks, this can also lead to difficulties in **modality specific generation**. Generating semantic-rich data based on relationships from auxiliary modalities with ambiguous correspondence can impact conditional, stochastic, or auto-regressive generation.

#### 4.3.2 Vision-language retrieval

Video retrieval sources relevant videos from a dataset based on an input query in natural language. As shown in Figure 7, research works can be categorized into instance- and semantic-based.

**Instance-based.** Image methods have explored cross-view ranking (Wang et al 2016a), language to visual attention (Torabi et al 2016), or visual features as embedding targets for language encodings (Dong et al 2018). Early adaptation of visual-language approaches to videos have used image-text-video triplets (Otani et al 2016), and related parts of speech to objects and actions (Gabeur et al 2020; Xu et al 2015b).

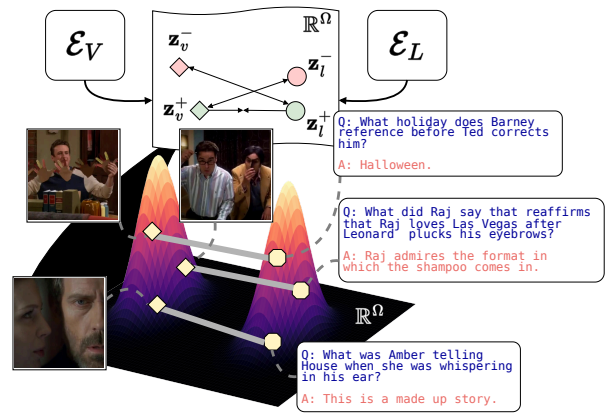

Fig. 6. **VLM modality gap.** Given video encoder  $\mathcal{E}_V$  and text encoder  $\mathcal{E}_L$ , video and text are embedded to  $\mathbf{z}_v^+$  and  $\mathbf{z}_l^+$  in a joint embedding space  $\mathbb{R}^\Omega$ . VLM objectives align both  $\mathbf{z}_v^+$  and  $\mathbf{z}_l^+$ . Contrastive approaches (Chen et al 2020c; Oord et al 2018; Xu et al 2021) additionally maximize the distance between negative vision-language pairs:  $(\mathbf{z}_v^+, \mathbf{z}_l^-)$  and  $(\mathbf{z}_v^-, \mathbf{z}_l^+)$ . Despite high-level semantic similarity, relevant modality-specific information that is not transferable across modalities can lead to a *modality gap* over embeddings. Videos sourced from Lei et al (2018).

In general, instance-based approaches use a binary score function to rank correspondences. Refinements to this objective have been made through visual-language binding with the inclusion of parts-of-speech in target captions (Wray et al 2019) and dual object-text and action-text models (Liu et al 2019; Mithun et al 2018). A number of methods have studied vision-language pretraining approaches (Ge et al 2022b; Lin et al 2022b; Xue et al 2022). Ge et al (2022b) related verbs and nouns to questions and video segments. Xue et al (2022) studied the correspondences between keyframes and all video frames, subsequently contrasting the keyframe-fused video features to language embeddings.

**Semantics-based.** A more challenging task is to retrieve images based on shared semantics to query images (Gordo and Larlus 2017). Semantic-based approaches primarily use triplet losses that contrastively regress between text queries and corresponding positive and negative visual inputs.

Video retrieval works have studied this through either a contrastive objective based on a support set of videos with similar action categories (Patrick et al 2020) or a semantic similarity scoring function for videos from the same category (Wray et al 2021). Recently, Kim et al (2024c) have utilized prior knowledge in retrieving text features based on embedding correspondences to similar visual features. Chun et al (2021) proposed probabilistic representations of visual features



Fig. 7. **Video retrieval tasks.** (a) Instance-based retrieval returns only a *single video* corresponding to a search query. (b) Semantics-based retrieval returns a *ranking score* corresponding to each video’s relevance to the search query. (c) Temporal Sentence Grounding (TSG) receives *video segments from queries* and returns the start and end time per segment. Videos sourced from Xu et al (2016).

to accommodate multi-query relevance. Similarly, Li et al (2023d) created an object-phrase and event-phrase prototype-matching framework to enforce relations between high-level concepts across modalities. Hao and Zhang (2024) employed an uncertainty estimate based on the Wasserstein distance between source and target domains of text-vision pairs.

**Temporal sentence grounding (TSG).** TSG (Regneri et al 2013) localizes moments in videos based on provided natural language queries. Compared to retrieving entire videos, TSG only retrieves relevant segments from a video based on queries. The task closely relates to TAL as also shown by the overlapping works (Gao et al 2017a) jointly exploring the two tasks. However, in contrast to TAL, TSG requires both natural language reasoning between query and answer, and language-vision reasoning with query-video and answer-video relevance. Following Gao et al (2017a), a broad formulation of TSG includes a visual-language semantic alignment between videos and sentences with a regression loss used for temporal sentence localization.

Early approaches have explored region proposals (Chen et al 2018a; Qu et al 2020; Liu et al 2018a), ranking (Escorcía et al 2019), distance-based joint vision-language embeddings (Hendricks et al 2017; Rohrbach et al 2016), and cross-modal graph representations (Liu et al 2022a; Zhang et al 2019a). As the association of visual and text features can be performed at multiple levels of abstraction, subsequent methods have learned correspondences over multiple proposals (Xu et al 2019b), local and global information (Jiang et al 2019a; Mun et al 2020), and word/sentence-level cues (Hao et al 2022). Zhang et al (2021c) used language-guided highlighting by cross-attending text features to multi-resolution video features. Another important aspect of

discovering associations between the two modalities is their conditionality as visual aspects should depend on the descriptions. Approaches have explored step-wise fusion of language key and value tokens (Cao et al 2021), localizing relevant video features based on text embeddings (Yang et al 2022a), matching video segments and text features contrastively (Flanagan et al 2023), and enforcing similarity between sequential tokens (Qian et al 2024). Ge et al (2019) used both instance-based vision-language embeddings and general category representations to calculate an actionness score and location offset. Other approaches have fused context from global and local temporal resolutions (Liu et al 2021a), grounded cues from anchor frames and boundary proposals (Wang et al 2020b), related uni-modal and cross-modal representations (Nan et al 2021), and adopted instance-relevant positional information (Gu et al 2024a).

#### 4.3.3 Video Captioning

A long-standing challenge in computer vision is the generation of high-level descriptions in language. In contrast to retrieval tasks that depend on a fixed vocabulary, captioning is a generative task. Starting from matching a small corpus of words to objects in images (Barnard and Forsyth 2001; Barnard et al 2003), current works in the image domain are capable of generating diverse and detailed image descriptions (Mokady et al 2021; Alayrac et al 2022). Video captioning includes further challenges as the appearance of objects and the context of scenes change throughout the video. Given the temporal extent of videos, captioning tasks can be divided into two categories (Table 4).

Table 4. Video captioning papers grouped by target task and overall approach. Tasks are grouped by the generation of single, or dense captions and the specialization to coherency with visual storytelling. Approach denotes architectural and model choices.

Task	Approach	Works
Single video captioning	CNN+LSTM	Aafaq et al (2019), Chen et al (2017a), Gan et al (2017), Pan et al (2017), Wang et al (2018a), Zheng et al (2020b)
		Trnsf-based
	VLM	Chen et al (2024e), Seo et al (2022)
	Dense video captioning	Region proposals
MIL		Chen and Jiang (2021), Shen et al (2017)
Visual storytelling	VLM	Li et al (2019b), Yu et al (2021), Xiao et al (2022), Han et al (2023b), (Han et al 2023a), (Han et al 2024)

**Single video captioning.** A large number of works have studied the direct extension of image captioning to video with single captions. Given a video clip and a corresponding caption, a general formulation of a single video captioning objective would be the minimization of the log-likelihood of the caption conditioned on the video.

Initial efforts (Guadarrama et al 2013) used semantic hierarchies with word selection through decision tree nodes. Following methods (Aafaq et al 2019; Chen et al 2017a; Gan et al 2017; Pan et al 2017; Wang et al 2018a) used encoder-decoder architectures that combined CNNs’ visual feature extractors and recurrent architectures (RNNs or LSTMs) to generate textual descriptions. To focus on object semantics, Aafaq et al (2019); Zheng et al (2020b) included object detector embeddings. The improved context size of transformers has enabled more recent approaches to explore spatio-temporal dynamics in videos and cross-modal relationships. Transformer approaches have included language supervision over hierarchies (Ye et al 2022) and token masking (Lin et al 2022a; Shen et al 2023b; Yan et al 2023a). Seo et al (2022) used a VLM with the video encoder and language decoder trained jointly on a reconstruction loss. Recently, Chen et al (2024e) explored knowledge distillation from multiple VLM models to generate captions. Majumder et al (2024) jointly learned a viewpoint ranking model for video captioning in multi-view settings.

**Dense video captioning.** Dense video captioning approaches generate multiple captions and temporally ground them to corresponding video segments. This is a significantly more challenging task as distinct video segments need to be localized to generate correspond-

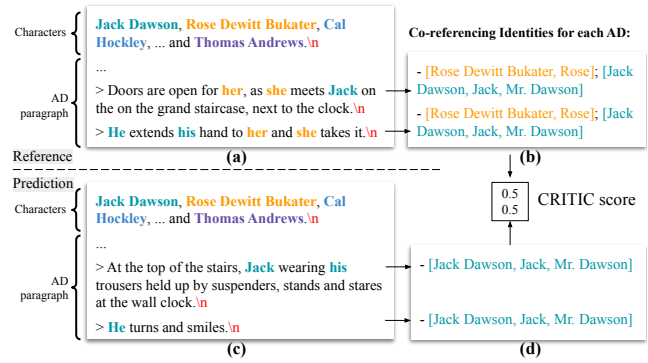

Fig. 8. CRITIC metric for visual storytelling. Identities are obtained from character lists and descriptions fed to a co-referencing model. CRITIC (Han et al 2024) is calculated as the IoU between predicted and reference identities.

ing captions. Early works on event localization (Krishna et al 2017; Li et al 2018c; Shi et al 2019; Wang et al 2018b; Zhou et al 2018c) were based on proposal modules from extracted video features. To learn vision-language correspondence explicitly for regions of interest, Zhou et al (2018c) used proposals as masks for visual and language embeddings. Other approaches improved proposal generation by using their sequential occurrence as a prior (Mun et al 2019), deployed feature clipping based on proposals (Iashin and Rahtu 2020a,b), refined general captions for each proposal (Deng et al 2021), and used unique CLIP properties to generate distinct captions (Perrett et al 2024). Overall, proposal-based methods are optimized on a loss that relates the proposal interval with the ground truth segment, and a captioning loss. As ground truth proposals require exhaustive annotation efforts, more recent works have focused on proposal-free approaches. Shen et al (2017) used Multi-Instance Learning (MIL) in which word instances are assigned to bags. They used a binary objective to separate positive bags in which at least one instance corresponds to a target word and negative bags in which no instance contains the target word. MIL has been a building block in subsequent weakly-supervised approaches (Chen and Jiang 2021). Further works (Yang et al 2023a; Ren et al 2024a) have also used sequence-to-sequence modeling with learnable time tokens for visual-language relations. Mavroudi et al (2023) combined instruction learning to model the sequentially of video captioning. Islam et al (2024) used a two-stage autoregressive approach that first generates dense captions for short clips and then cross-attends them to visual features over longer segments to generate longer captions. Zhou et al (2024) aimed at effi-



ciency improvements by compressing frame-instance visual features to clusters.

**Visual storytelling.** A recently introduced challenging task that is gaining interest is the generation of coherent sentences for sequential videos (Li et al 2019b). To bridge cross-modal semantics, Yu et al (2021) used a coherence loss for past, present, and future frames and contrastively pulled visual and language embeddings closer. A similar contrastive objective was used by (Xiao et al 2022) alongside masking part of the visual input. Han et al (2023b) trained a mapping module to project joint CLIP visual features, audio descriptions, and subtitles to an LLM input space to generate captions. Following efforts proposed additional refinements in the pipeline by injecting visual and caption embeddings over multiple LLM layers (Han et al 2023a), using exemplars (Han et al 2024), and using character-based prompting (Xie et al 2024). The CRITIC metric, shown in Figure 8, was recently introduced by Han et al (2024) to measure the conceptual alignment of the generated sentences.

#### 4.3.4 Video Question Answering (VideoQA)

A widely-used benchmark for VLM models is the utilization of visual context to answer natural language questions (Antol et al 2015; Goyal et al 2017b). In contrast to video captioning, it requires understanding parts of objects and the temporal extent of relevant answers. Depending on the task setting, answers can be obtained from multi-choice QA, or as a global answer in open-end QA.

In a multi-choice QA setting, given a video and a question, the goal is to learn a mapping that returns an answer from a set of possible answers. In open-end QA settings, the answer is instead generated from a model conditioned on the video and question. VQA methods can be divided into two broad groups (Figure 9).

**Scene-graphs.** Early VideoQA approaches were based on either graph representations (Jiang and Han 2020; Tu et al 2014) or on each modality’s heterogeneity. Huang et al (2020a) used object and location-based graph embeddings to relate visual and text features with a cross-modal similarity matrix. Graph representations have also been created from hierarchies of objects and their interactions (Dang et al 2021) as well as over multiple frames (Liu et al 2021b). Alternative approaches defined scales from multiple graph convolution resolutions to relate cross-scale interactions (Guo et al 2021) or from subgraphs to capture static and dynamic scene objects (Cherian et al 2022). Park et al (2021a) created appearance, motion, and question graphs, learning conditionality by propagating nodes

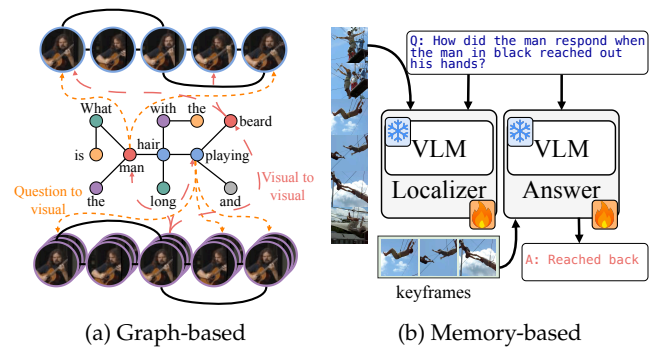

Fig. 9. **VideoQA approaches.** The graph-based approach in (a) is based on the method from Park et al (2021a). The memory-based approach with a two-stage VLM in (b) is based on Yu et al (2023b). Videos sourced from Xiao et al (2021).

across graphs. Graph representations have also been learned contrastively (Xiao et al 2023) from positive and negative pairs of video snippets and answers.

**Multi-modal memory.** Another set of methods aims to memorize relations between visual and text features across time. Initial efforts integrated additional memory modules in LSTMs (Jang et al 2017; Xu et al 2017a; Zeng et al 2017). Attention-based approaches (Ye et al 2017) combined modality-specific memory modules (Fan et al 2019) and memory-sharing modules to cross-attend motion and appearance (Gao et al 2018; Li et al 2019c). Several works (Gao et al 2023; Li et al 2023g; Yang et al 2022b; Xue et al 2023) have used a single model with concatenated language and vision tokens to predict answers to queries. Recent approaches have adapted large VLMs for VideoQA. Yu et al (2023b) used a two-stage dual-VLM to first localize video segments based on the video and question and then used only the selected frames and question to generate the answer. Similarly, Min et al (2024) used a list of generated VLM captions describing scenes in videos as input to an LLM. The question was then passed as a prompt to discover the most relevant answer. However, recent efforts (Xiao et al 2024) have also revealed that VLM-based approaches may produce answers based on spurious language correlations and not the visual context.

#### 4.3.5 Future outlooks

Advancements in VLMs have enabled the recognition of actions based on their correspondence to a large lexical corpus. Building upon this correspondence, retrieval, captioning, and question-answering models have moved beyond single-instance structural representations and toward the discovery of abstract cross-

modal semantics. The increased model capacity provides opportunities for future lines of research.

Most VLMs strongly rely on linguistic associations that may not be relevant in vision instances (Rahmanzadehgervi et al 2024). A possible alternative is to develop unified multi-modal models that tokenize and encode video frames and images in the same manner with positional embeddings also encoding temporal relationships. Initial efforts by Jang et al (2023) and Jin et al (2024) have been promising. Another direction includes a better exploration of the objectives used. The majority of works train models on objectives (Chen et al 2020c; He et al 2020; Oord et al 2018) or using downstream task adapters (Hu et al 2021) which can enforce properties such as feature suppression (Chen et al 2021c) and pretext granularity (Cole et al 2022) despite aiming to maximize correspondence. Crafting better alignment objectives for cross-model representations and semantic relevance can benefit future VLM approaches.

#### 4.4 Audio-visual and multimodal recognition

The recognition of actions or activities has been predominantly studied in the vision domain. In contrast, the auditory recognition of actions from sounds emitted by objects or actors and their interactions is more sparsely researched. This task presents distinct challenges as the sounds emitted by different objects or actions can be similar.

Time-frequency spectrograms have been a popular format for representing audio events in videos. Initial audio-based models have been built following image-based object recognition (Gong et al 2021) or video classification (Kazakos et al 2021) CNNs. Attention-based audio methods have used convolutional features (Gulati et al 2020; Kong et al 2020) or image-pretrained encoders (Koutini et al 2022) to attend over spectrogram patches. Approaches have also explored patch masking (Baade et al 2022; Huang et al 2022), focused on salient sounds (Stergiou and Damen 2023a), and adapted (Liu et al 2022b) or compressed (Feng et al 2024) spectrogram resolutions. More recently, the use of audio has gained attention in multi-modal systems as it can provide supplementary information to both visual features and language context.

##### 4.4.1 Challenges

The use of multiple modalities introduces several challenges. **Learning cross-modal dynamics** is a fundamental challenge of multi-modal models as it aims to preserve heterogeneous properties of modalities

while maintaining interconnectivity between modalities (Liang et al 2022c). Fused embedding spaces (Girdhar et al 2023a, 2022; Piergiovanni et al 2023; Zhu et al 2024a) effectively reduce modality-specific information and instead rely on learning a high level of abstraction, with lower heterogeneity and higher interconnectivity. In contrast, modality-specific embedding spaces (Gong et al 2022b, 2023; Chen et al 2024a; Recasens et al 2021) are learned through cross-modal associations and rely on effectively transferring distribution across modalities, causing higher heterogeneity and lower interconnectivity. These paradigms are affected by **domain-specific noise topologies**. Based on a given task or data distribution, the discriminability of each modality differs. Noise naturally occurs based on environment settings, *e.g.* visual features are more relevant in daylight than in night videos. It can also be observed with instance-based occlusions or sensory imperfections. Such topologies are important when developing reasoning structures over modalities (Gat et al 2021). **Input representation reasoning** can be defined as combining knowledge from the data and the structure of the objective. Compositional relationships between modalities can be established through concept hierarchies, temporal correspondence, or interactive states. Commonly, such structures are not available beforehand and are instead learned in an unsupervised manner.

##### 4.4.2 Audio-visual models

As video and audio signals differ significantly, works have used two-step models to infer predictions. Two-step approaches extract video and audio embeddings first and then fuse either modality-specific predictions (Fayek and Kumar 2020), embeddings from multiple modalities (Xiao et al 2020), or they jointly attend vision and audio features for the final prediction (Gong et al 2022b). More recently, architectures have tokenized and attended audio and vision jointly with multi-modal learnable tokens (Nagrani et al 2021), cross-modal attention (Jaegle et al 2021), and modality gating (Xue and Marculescu 2023). To account for models trained on uni-modal tasks, Lin et al (2023b) proposed cross-modal adapters to combine uni-model embeddings in multi-modal tasks. Exploring the relevant audio and visual features with self-supervision has also been a learning paradigm of significant interest. Common embedding spaces can be useful for discovering correspondences in both uni-modal and cross-modal retrieval (Arandjelovic and Zisserman 2018; Wu and Yang 2021), multi-modal clustering (Hu et al 2019), and sound source separation (Hu et al 2022b; Mo and

Morgado 2023; Zhao et al 2018). Token reconstruction through masking has also been used as a self-supervised pretraining task with a variety of training schemes including concatenating masked tokens (Gong et al 2023), multi-view masking per modality (Huang et al 2023b), fusing a mixture of per-modality masked tokens (Guo et al 2024b), combining modality-specific masked and unmasked embeddings (Georgescu et al 2023), and using multiple masking ratios with siamese networks (Lin and Bertasius 2024).

Variations in the relevance of either visual or auditory signals depend on the instance. A promising direction for integrating this into optimization is gradient blending (Wang et al 2020c) which recalibrates the loss per modality. Other research works have explored multi-audio to single-visual scene correspondence with contrastive learning. This has been done by utilizing joint semantic similarity in both modalities (Morgado et al 2021), using active sampling to diversify the pool of negative samples (Ma et al 2021), and by counterfactual audio and video pairs to enforce a relationship between multiple audio to single visual scenes (Singh et al 2024). Enforcing a similarity constraint between audio and vision steams can also be used to train models on incremental tasks (Pian et al 2023).

#### 4.4.3 Multi-modal models

Video is a natural source of multi-modal data. Apart from visual information, audio or textual descriptions can be used in tandem to provide additional signals for actions and events at different granularities. Multi-modal learning has shown improvements in the generalizability of unsupervised models (Ngiam et al 2011) over varying tasks (Paredes et al 2012). An initial effort by Kaiser et al (2017) aimed to create unified multi-modal representations with modality-specific encoders and modality-binding decoders. A similar mixture-of-expects approach was also presented by Munro and Damen (2020) for unsupervised domain adaptation with a dual cross-domain source-target loss over modality pairs. Dai et al (2022b) used sparse activations to train portions of a unified model on specific modalities and tasks. Multi-modal transformers have introduced joint encoder paradigms. Akbari et al (2021) used modality-specific heads to project outputs from a joint audio-text-video encoder trained with a contrastive loss over modality pairs from Miech et al (2020b). Mixtures of modality-specific encoders and multi-modal head/decoders have also been trained with masked tokens (Zellers et al 2022), cross-modal attention blocks in the encoder (Recasens et al 2023), ensembles of uni-modal teachers (Radevski et al 2023),



Fig. 10. **Early Action Prediction (EAP)**. Only the observable part of a video  $\tau_{1, \rho}$  is used to predict the current action. EAP is challenging as the immediate future is often unpredictable especially when distinguishing between fine-grained actions, e.g., *taking courgette* or *taking carrot*. Video from Damen et al (2022).

and audio-vision projectors on top of LLM heads (Zhang et al 2023a). Zhang et al (2024c) fused features from different modalities to a multi-modal head at different training steps capturing cross-modal associations iteratively during training. Srivastava and Sharma (2024a) included meta tokens to represent modality dimensions and channels to embed modality-specific features in a common space. This was further adjusted (Srivastava and Sharma 2024b) to also cross-attend joint-embedded features and uni-modal features.

#### 4.4.4 Future outlooks

Most current multi-modal models rely on the availability of all modalities at the start. New models are re-trained when additional modalities are added. A promising direction would be to design adaptive models that integrate unseen modalities more efficiently (Ma et al 2022b). This has been explored by recent methods by transferring seen to unseen modality distributions (Wang et al 2023i), cross-attending over unseen modalities (Recasens et al 2023), aligning uni-modal and multi-modal features in training (Zhang et al 2023e), using modality-specific adapters (Lin et al 2023b), and predicting missing modality features with learnable tokens (Kim and Kim 2024). Learning adaptable models that can process inputs in new modalities at inference time not only benefits performance for specific tasks but also enables advancement in more general tasks such as online learning (Bottou 1998), incremental learning (Schlimmer and Fisher 1986; Utgoff 1989), and federated learning (Konečný et al 2016).

## 5 Predictions in ongoing actions

A critical aspect of video models regardless of the downstream task has been their ability to capture temporal information (Huang et al 2018). Learning tem-

poral patterns can enable models to predict what is happening in a video, without seeing the full action or activity. We start by defining methods that provide semantic predictions on the action categories from partial observations in Section 5.1. We then discuss approaches that generate unobserved frames in Section 5.2. States of actions or objects can change at different times during the execution of an action. We explore groups of tasks that predict the states of objects and actions in Section 5.3.

### 5.1 Early action prediction

Early Action Prediction (EAP) assumes predictions made based on the observable part of an *ongoing* action being performed  $\tau_{1,\rho}$  as shown in Figure 10. Several different lines of research have been explored to address relationships between partial action observation and high-level semantics.

#### 5.1.1 Challenges

One of the main challenges that arise from partially observed videos is the **procedural proximity** in the execution of actions. As shown in Figure 10, there can be an overlap in the steps taken to perform similar activities. For the example shown, the difference between *take courgette* and *take carrot* is subtle, without significant motion variations. Instead, the distinction only becomes visually apparent at the end of the action. This challenge relates to the more general problem of **abstracted views** in which deterministic information relevant to the task is not always available. Although such fine-grained predictions may not be available, it is still possible to identify general categories for the actions being performed, e.g., *take <object>*. An **adjustability requirement** is thus introduced as part of EAP to address the intrinsic uncertainty in partial observation.

#### 5.1.2 Approaches

Three main groups of approaches can be identified for EAP. We visualize these groups in Figure 11.

**Probabilistic modeling.** A large portion of the EAP literature has originally been based on probabilistic modeling of action classification from partial observations (Cao et al 2013; Hoai and De la Torre 2014; Li et al 2012; Li and Fu 2014; Ryoo 2011). Ryoo (2011) used a bag of words based on feature distributions. This division into segments has been relevant in subsequent approaches that used sparse coding (Cao et al 2013), max-margin (Hoai and De la Torre 2014), and scoring functions (Li

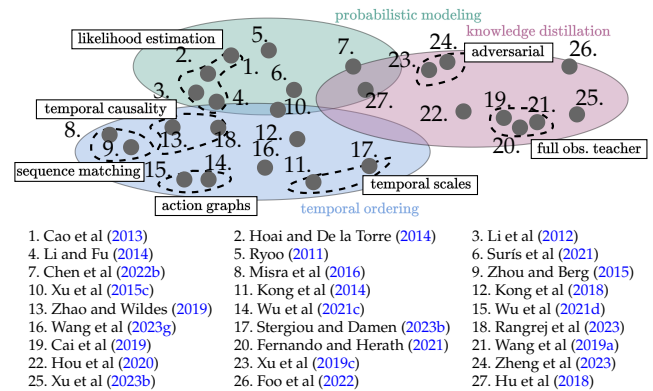

Fig. 11. EAP methods grouped by approach. The three main clusters are colored. Smaller subgroups are denoted with dashed lines. The positioning of the works represents an abstract proximity of the research idea to other seminal works.

et al 2012; Li and Fu 2014) to infer the action likelihood. More recent probabilistic approaches include the use of hyperbolic representations (Suris et al 2021) for hierarchical predictions of actions. The ambiguity of future predictions has also been explored with the generation and subsequent selection of multiple future representations (Chen et al 2022b).

**Temporal ordering.** A different line of works explored EAP based on the temporal evolution of the action. The arrow of time (Pickup et al 2014) can provide a strong signal to associate the procedural understanding of actions with high-level categorical semantics (Misra et al 2016; Zhou and Berg 2015). Xu et al (2015c) formulated EAP with an auto-completion objective, matching candidate futures to a partial action observation query. The predictability of partial observations can be difficult in instances where there are visual similarities in the performance of actions. To address this, approaches have either used multiple temporal scales (Kong et al 2014), created key-value memories of representations (Kong et al 2018), or propagated the features' residuals over time (Zhao and Wildes 2019). More recent approaches have used temporal graph representations (Wu et al 2021c,d), contrastive learning over partial observations of the same action (Wang et al 2023g), or aggregated attention over temporal scales (Stergiou and Damen 2023b), and relevant space-time regions (Rangrej et al 2023).

**Knowledge distillation.** Transferring class knowledge (Park et al 2019) from models trained on the full videos can be an effective technique for refining predictions from partial observations. Cai et al (2019), Fernando and Herath (2021), and Wang et al (2019a) used learned representations of the full observations as targets to optimize for partial observations. Further methods (Hou

et al 2020) have refined this approach with the inclusion of motion sequentiality to learn soft targets and regress model predictions. In a similar effort, (Xu et al 2019c) and (Zheng et al 2023) integrated an adversarial objective for generating representations for the non-observable parts. Similarly, Xu et al (2023b) learned to reconstruct representations of full observations with a masked autoencoder (He et al 2022b). Other works have fine-tuned expert heads for each action category (Foo et al 2022) or learned by focusing on videos with distinct visual features (Hu et al 2018).

### 5.1.3 Future outlooks

Although EAP remains a challenging task to be explored further, some future directions can be envisioned. First, current EAP evaluation protocols are based on fixed-length temporal occlusions of parts of videos. However, this offline evaluation varies significantly from the intended **real-time use** of these systems in which singular models are deployed in video streams. EAP methods should instead be built and evaluated in real-time settings in which factors such as latency and inference speeds are crucial.

A second direction of future research is the exploration of **multi-person action prediction** for group activities. This is a significantly more complex task as it not only requires predicting the intentions of individuals but also general group goals. Such approaches will also have direct application to more general fields such as robotics, security, and augmented reality.

## 5.2 Frame-level prediction

Related to EAP, Video Frame Prediction (VFP) aims to reconstruct future frames of ongoing actions from partial observations. Although high-level semantics such as the level of semantic abstraction to describe the observed action are not learned, VFP still requires relating the consequentiality of motions and intended action to the reconstruction of subsequent frames.

### 5.2.1 Challenges

The **metric-based evaluation** of VFP approaches is done deterministically as VFP aims to predict raw pixel values of future frames. Metrics such as Peak-Signal-to-Noise Ratio (PSNR) and Structural Similarity Index Measure (SSIM) have been widely adopted to quantify VFP performance. However, they do not evaluate the correctness of high-level scene dynamics or the consistency of the scene. A number of image-based statistics adjusted to video (Czolbe et al 2020; Ding et al 2020;

Zhang et al 2018) and video-specific statistics (Hou et al 2022; Li et al 2019a) have targeted such shortcomings by including comparisons in embedding representations between predicted and ground truth frames. The usability of these metrics still leaves room for exploring the robustness of quality validation approaches further.

Similar to EAP, **future scene dynamics predictions are stochastic**, with varying levels of complexity. Most VFP objectives are based on the changes in the pixel distributions between frames without explicit definitions of optimization criteria for a comprehensive understanding of physics or object structures within scenes. This hinders the prediction capabilities over longer temporal windows and complex scenes with fast motions (Ming et al 2024).

### 5.2.2 VFP methods

We identify three groups of VFP approaches.

**Sequential adversarial predictions.** A significant portion of VFP works has been based on sequential frame generation (Castrejon et al 2019; Chaabane et al 2020; Chang et al 2021, 2022; Chen et al 2017b; Guen and Thome 2020; Hwang et al 2019; Jin et al 2020; Liang et al 2017; Villegas et al 2018; Wang et al 2018f; Wu et al 2021b). These approaches use recursion to generate representations or predictions in an autoregressive manner. One line of methods (Chen et al 2017b; Jin et al 2017) focused on the correspondence of objects between frames to guide the generation of the next frames. Castrejon et al (2019) used similar adversarial guidance by fusing context information from previous frames. Additional supervisory signals included motion flow (Liang et al 2017), partial differential equations (Guen and Thome 2020), and embeddings over multiple temporal resolutions (Gao et al 2022b). Another line of approach (Chang et al 2021; Villegas et al 2018; Wang et al 2018f) has included long-term memory connections to discover causalities from frames over longer temporal windows. Park et al (2021b) incorporated time dynamics for VFP with the inclusion of Ordinary Differentiable Equations (ODE). Davtyan et al (2023) used ODE with the previous frame as the initial condition and integrated the vector field from Flow Matching (Lipman et al 2023) to predict the next frame.

**Parallel multi-frame synthesis.** In contrast to the sequential reconstruction of future frames, approaches have also generated multiple future frames in a single step. One of the first efforts for multi-frame prediction (Liu et al 2017b) used a multi-frame per-pixel optical flow vector with further adaptations including multi-

ple scales (Hu et al 2023). Attention-based architectures have also been used for parallelization of frame prediction by introducing encodings of context for frame prediction attended over temporal patches (Tan et al 2023a; Ye and Bilodeau 2023), conditioning the generation based on short-term representation variations (Hu et al 2023; Smith et al 2024), using multiple motion and appearance scales (Zhong et al 2023a), and reducing inference speeds (Ye and Bilodeau 2022; Tang et al 2024). As an extension to spatiotemporal attention, Nie et al (2024) used a triplet module to attend across all dimensions of the video sequentially.

**Probabilistic generation.** A final group of approaches studied the reconstruction of future frames probabilistically. Babaeizadeh et al (2018) and Denton and Fergus (2018) learned a probabilistic variational model on the stochasticity of the video to generate frame predictions. Wang et al (2020d) models the perceptual uncertainty in future frames with a Bayesian framework with different weights assigned to future prediction candidates. Diffusion-based models (Dhariwal and Nichol 2021; Ho et al 2020; Rombach et al 2022) have been applied to a multitude of generative approaches for VFP (Gu et al 2024b; H ppe et al 2024; Shrivastava and Shrivastava 2024; Voleti et al 2022; Ye and Bilodeau 2024; Zhang et al 2024e). These methods gradually transform a complex distribution into unstructured noise and learn to progressively recover the original distribution from noise.

### 5.2.3 Future outlooks

The scarcity of **high-resolution datasets** remains a limiting factor for the performance of VFP models. More varying data distributions in terms of motions in scenes, sharpness, and blur can enable current approaches to learn across diverse video conditions. Recently, efforts (Stergiou 2024; Xue et al 2022) have aimed to provide high-resolution videos for several tasks. Future VFP approaches can benefit from training on these datasets.

A point of improvement for future works is the **inclusion of world knowledge** to enable predictions based on abstractions of the scene dynamics. The recently introduced term *Stochastic Inverse Problems* defines a broad family of problems relating to predictions from partial observations (Spielberg et al 2023; Tewari et al 2023). These approaches aim to permeate knowledge of physical underlying processes throughout training.

## 5.3 State changes

Another set of action prediction tasks includes modeling the state changes in the environment, actions, objects, or execution speeds. Tracking, inferring, and reasoning in these tasks come with new sets of changes. An overview of the tasks' objectives is visualized in Figure 12.

### 5.3.1 Challenges

Understanding the sequentially in videos is a central part of human perception. The translation of this to computer vision tasks remains challenging (de Boer et al 2023). A central challenge relates to the **object state variability** as actions affect the visual appearance of objects in terms of shape, visibility, or perspective. Another set of challenges concerns actions with **non-rigid temporal boundaries**. Actions may not be easily distinguished from backgrounds or their execution may overlap with other actions. This presents **ambiguities in the action progress** as the completion of an action, or part of it, might also involve another action. Finally, the typically weak relation between visual input and the high-level semantic interpretation thereof complicates the training of robust, general models.

### 5.3.2 State-based tasks

We discuss six main tasks based on object and action state changes in their objectives.

**Action Progress Prediction (APP).** Actions can be understood by procedural sets of motions performed towards an intended goal as shown in Figure 12a. Vaina and Jaulent (1991) suggested that understanding the state and progress of the action at different times can provide a holistic understanding of the intent and objective. In machine vision, an initial APP approach (Fathi and Rehg 2013) used local descriptions to model per-frame state changes. (Kataoka et al 2016) used a descriptor to discover transitional actions within activity sequences. Xiong et al (2017) introduced a score function to distinguish between actions based on learned distinctive parts. Becattini et al (2020) used actor and scene context information as an additional supervisory signal for APP. Price et al (2022) expressed the progress of multiple actions through threads of activities that can overlap, a common situation in long procedural videos. Shen and Elhamifar (2024) causally attended videos to define a task graph for APP over each action. More recently, generative approaches (Sou ek et al 2024) using conditional control (Zhang et al 2023c) and procedural knowledge (Ashutosh et al 2023b; Zhou

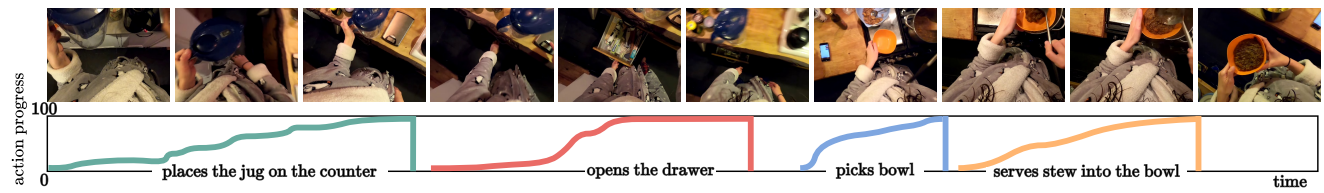

(a) **Action Progress Prediction (APP)**. Given a video stream of a procedural task, estimate the progress of each ongoing action by inferring the time it will take to complete the action performed. Video sourced from Grauman et al (2024).

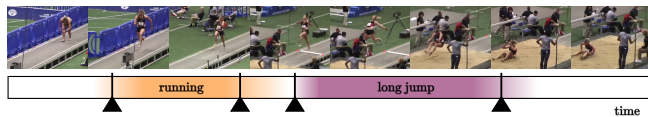

(b) **Event Boundary Detection (EBD)**. Detect the start and end times of ongoing events in video streams. Video sourced from Carreira and Zisserman (2017).

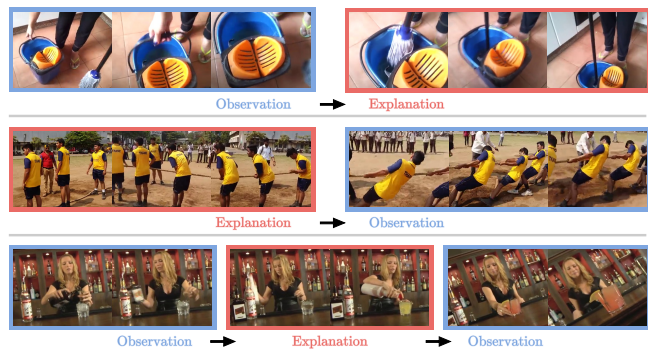

(d) **Visual Abductive Reasoning (VAR)**. Given the observable part of the video in blue, infer a likely explanation in red for what follows before, after, or during the observation. The task requires a high-level understanding of the action or activity performed. Video sourced from Liang et al (2022a).

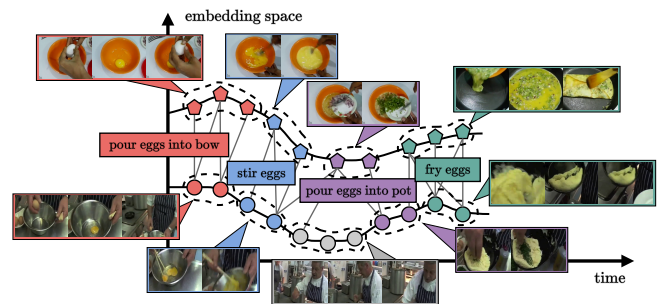

(d) **Video Alignment (VA)**. Find correspondences across video instances with the same action performed and align them such that the execution of the action is synchronized. Video sourced from Tang et al (2019).

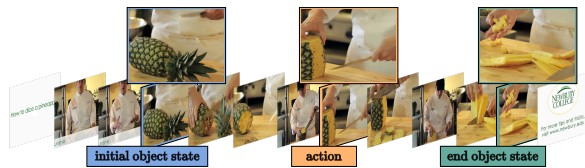

(e) **Object State Change Detection (OSCD)**. State modifying actions such as *cutting* progressively change the visual appearance of objects from an initial state in blue to a final post-action execution state in teal. OSCD identifies the times that these changes occur. Video sourced from Souček et al (2022).

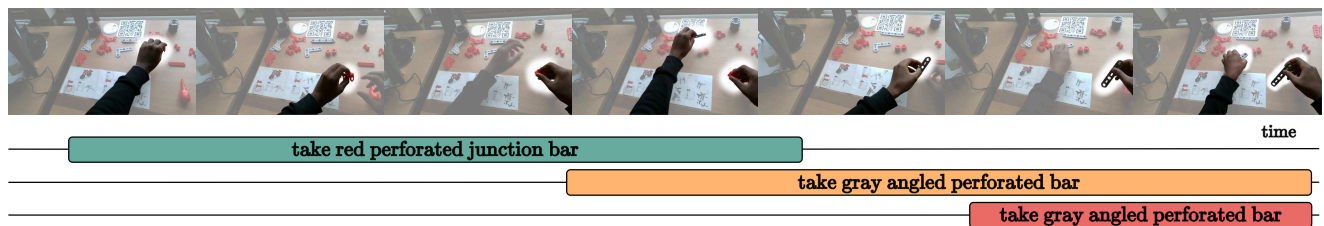

(f) **Active Object Detection (AOD)**. Given a video in which a person interacts with multiple objects, AOD detects the object the person is currently using. Video sourced from (Ragusa et al 2021).

**Fig. 12. Tasks relating to object and action state change.** Each of the presented tasks can involve additional objectives.

et al 2023a) have been used to generate keyframes of changes.

Another line of research works (Heidarivineh et al 2016, 2018) is aimed at localizing the moments that actions are completed. The speed of action completion or state changes in actions has also been studied in the context of skill determination (Doughty et al 2018) or their semantic correspondence to textual adverbs

(Doughty et al 2020; Doughty and Snoek 2022; Moltisanti et al 2023). Scoring approaches (Tang et al 2020b) have been used to study the procedural execution of actions in the context of quality assessment. Adjacent tasks such as video captioning and action classification have also been integrated into multi-task settings (Parmar and Morris 2019).

**Event Boundary Detection (EBD).** Different from the related well-studied task of action localization, EBD (Shou et al 2021) localizes event changes in videos *regardless of the action classes*, shown in Figure 12b. Aakur and Sarkar (2019) proposed a self-supervised objective in which their model is initially trained to reconstruct subsequently observed features. (Shou et al 2021) used a self-similarity metric to determine event boundaries by relating encoded frame features. Further, EBD approaches (Mounir et al 2023) have studied hierarchies of video events. Recently, Eyzaguirre et al (2024) explored the detection of event starts from natural language queries.

**Video Alignment (VA).** As the performance of individual parts of actions can vary, video alignment, shown in Figure 12d, aims to temporally match key moments in the execution of the same action across videos. Initial efforts, motivated by temporal coherence (Goroshin et al 2015; Fernando et al 2017; Zhang et al 2023b), have studied VA based on Canonical Correlation Analysis (CCA) (Andrew et al 2013) or by contrastively creating joint representations from multiple viewpoints (Sermanet et al 2018). Dynamic Time Warping (Sakoe and Chiba 1978) is an algorithm that aligns variable length signals, and it has been adopted for VA (Chang et al 2019; Dvornik et al 2021; Hadji et al 2021). A more recent self-supervision objective (Dwibedi et al 2018) for VA is to train a video model to project per-frame embeddings in pairs of target videos by matching embeddings of one video to the nearest neighbor embeddings of the other. This approach was extended in subsequent works with the inclusion of context from the entire video (Haresh et al 2021), anchor frames to align redundant frames (Liu et al 2022d), embeddings from text (Epstein et al 2021), and regularizers based on the correspondence to repetitions of the same action (Donahue and Elhamifar 2024).

**Visual Abductive Reasoning (VAR).** A key element in action understanding is recovering the intended goal. High-level reasoning of events has initially been considered in hierarchies with rule-based approaches (Hakeem and Shah 2004) or the conditionality of action occurrences across different levels (Albanese et al 2010). Pei et al (2011) detected atomic actions with graph representations to decompose complex events. VAR (Liang et al 2022a), shown in Figure 12d, is the vision-language task that uses characteristics of partial observations as a premise and requires formulating an explanation. Other VAR works have modeled intention by contrastively learning visual and language context (Li et al 2023b), modeling timelines for news story understanding (Liu et al 2023a), and forecasting actions by multi-modal inputs (Zhu et al 2023). Evaluation of

VAR models has also been studied in counterfactual vision-language pairs (Park et al 2022b) similar to text-only tasks (Ippolito et al 2019; Huang et al 2020b).

**Object State Change Detection (OSCD).** Many actions alter the appearance or state of objects. OSCD approaches associate visual changes to changes in the states of objects in the scene, as shown in Figure 12e. Efforts (Alayrac et al 2017; Damen et al 2014; Liu et al 2017a; Zhuo et al 2019) have initially focused on state modifications that do not involve significant appearance changes, *e.g.*, open/close door or fill/empty cup. Hong et al (2021) proposed a reasoning-based approach defining a triplet of complexities for single- and multi-step transformations with additional viewpoint changes. Other reasoning-based approaches include the use of language (Xue et al 2024) and visual exemplars of start and end states (Souček et al 2022). OSCD has also been studied in combination with other tasks including cross-state object segmentation (Yu et al 2023a), cross-action relevance (Alayrac et al 2024), or inspired by state-disentanglement for images (Gouidis et al 2023; Nagarajan and Grauman 2018; Saini et al 2022), generating start and end states by given context and scene prompts (Souček et al 2024; Saini et al 2023).

**Active Object Detection (AOD).** Actions can include multiple objects during their execution. Overlooked in Figure 12f, AOD specifies the objects relevant to the currently performed atomic action. This task has recently gained interest as scenes can often be cluttered (Ragusa et al 2021) or a varying number of objects can be used for a single action (Miech et al 2019). Nagarajan et al (2019) specifically focused on localizing the human-object interaction areas defining focal points of importance during the execution of actions. (Fu et al 2022) introduced a voting module over potential bounding boxes corresponding to the active object. Kim et al (2021a) used a parallelized model to detect instances and subsequently hand-object interactions. Yang and Liu (2024) used scene context from text to define plausible interactions with target objects for AOD.

### 5.3.3 Future outlooks

Similar to recent works in robotics that create goal-based policies (Kun et al 2024; Wang et al 2023c), state-understanding vision models require a holistic understanding of actions given a limited **availability of arbitrary object states**. Conceptually, the execution and changes in objects can be similar for different actions, *e.g.*, mixing a cake mix and whisking eggs. Enforcing better learning objectives in order to improve this semantic correspondence can create more generalizable models with a better understanding of the physi-



cal world. In addition, the inclusion of cues from **supplementary modalities**, such as audio, can improve tasks that require relating parts of videos, as correspondences should be discoverable beyond the visual domain. This also presents the potential for creating general-purpose models based on **abductive reasoning** pre-text objectives that can then be applied to various downstream tasks.

## 5.4 Anomaly detection

Video Anomaly Detection (VAD) is the task of detecting unexpected actions or events in videos that deviate from predictable behaviors. Anomalies are detected through either explicitly classifying a pre-set number of actions in **close-set** settings or learning robust representations of the expected actions in **open-set** settings.

### 5.4.1 Challenges

VAD depends on strict binary annotations of normal and abnormal sequences, with most evaluation benchmarks including **limited definitions**. Even in the open-set settings, robust definitions are required for the target normal sequences. This prevents the creation of models that can estimate correctly unseen normal sequences based on their visual proximity to other actions. Although recent-continual-learning approaches have also been proposed for VAD (Bugarin et al 2024), their applicability remains sparse. Another significant challenge for VAD models relates to their applicability. With their intended use in continuously operating surveillance systems, current approaches only **partially use temporal context** to infer predictions. Only a small number of approaches currently study the long-term effects of actions. Most datasets also only include modest temporal resolutions, limiting the exploration of context over longer time segments.

### 5.4.2 Detecting anomalies in videos

We identify two main approaches for the detection of anomalies in videos.

**Close-set.** Anomalies can be discovered by *close-set* tasks that aim to model both normal and abnormal sequences. Sultani et al (2018) used Multiple Instance Ranking (Dietterich et al 1997) to define positive groups that include videos with at least a single abnormal segment and negative groups of normal videos. The objective is to maximize the score between the assigned positive and negative groups. Subsequent efforts have built upon MIL with learned features (Dubey et al 2019), or pseudo labels (Feng et al 2021a). Approaches

have also aimed to improve upon MIL's reliance on the dominant negative instances. Zhang et al (2019c) integrated inner-group sampling, Pu et al (2024); Zhu and Newsam (2019) used temporal weighting, and Tian et al (2021a) maximized the separability between normal and anomalous representations. With a similar goal, the use of multiple temporal pretext tasks (AlMarri et al 2024; Georgescu et al 2021) and temporal scales (Li et al 2022b) have also been explored. Chen et al (2023) used a contrastive objective between representations of normal and abnormal videos. Clustering approaches have focused on modeling sparsity (Lu et al 2013), enforced high distribution variance between normal and abnormal video representations (Li et al 2021b), combed dense/sparse clusters for normal/abnormal segments (Zaheer et al 2020a), and used pseudo labels for anomalous segments (Zaheer et al 2020b). Another set of methods (Zhong et al 2019; Purwanto et al 2021) has included graph networks to sequentially detect abnormal segments. More recent methods have distinguished between normal and anomalous states with the use of additional modalities such as audio (Wu et al 2020a) and language context (Yang et al 2024b; Zanella et al 2024).

**Open-set.** As close-set solutions can only model abnormalities in labeled data, models cannot effectively generalize to distributions different than those seen during training. This issue has been studied by Zhao et al (2011) and Luo et al (2017) as a sparse-coding (Lee et al 2006) problem in which the model is trained to reconstruct only plausible normal sequences. Abnormalities are then inferred by large reconstruction loss offsets. Temporal regularity can also be modeled with autoencoders as a reconstruction task (Hasan et al 2016). To deal with the scarcity of abnormal sequences during training, a number of autoencoder (AE)-based approaches use pseudo representations to improve the embedding space (Astrid et al 2021b,a). Park et al (2020) learned prototypes of normal sequences which can then be used to contrast query videos. Other works have constrained the representation space of normal sequences by optimizing piecewise linear decision boundaries (Wang and Cherian 2019). Two-stream AE frameworks (Cho et al 2022; Nguyen and Meunier 2019) have been used to separately reconstruct the appearance and motion characteristics of normal sequences. Generative approaches (Micorek et al 2024) have recently focused on the latent space with Gaussian Mixture Models (GMM) and inferred an anomaly score across all noise levels. Fioresi et al (2023) has explored cross-frame mutual information minimization in tandem with a generative objective for privacy preservation. Other privacy-aimed approaches have studied

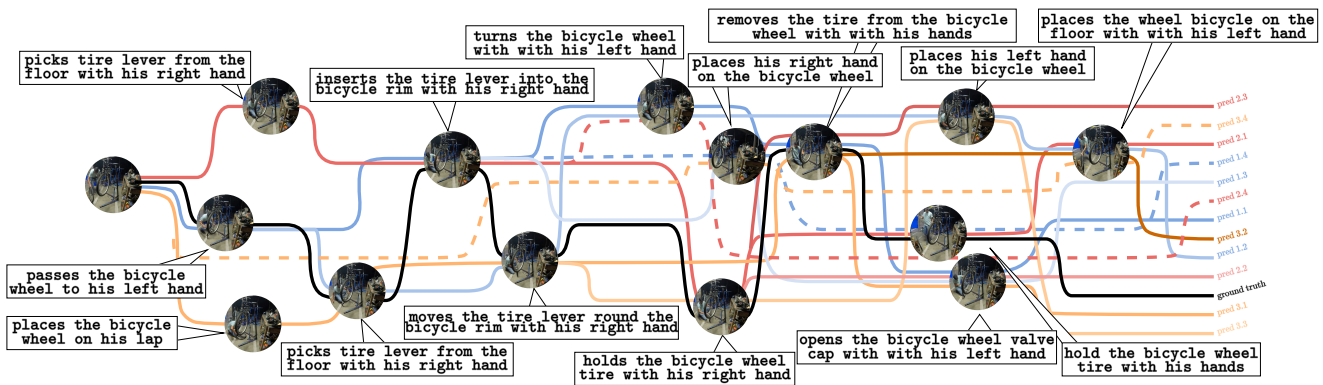

Fig. 13. **Forecasting future actions.** Starting from the observed action, anticipation approaches infer the sequence of probable next actions. Predictions are shown in a narrative chart format similar to Randall (2009). Example selected from Grauman et al (2024).

trajectory-based video anomaly detection. Morais et al (2019) used an RNN to track skeletal points and regressed future locations. The objective of the model was to learn a fixed interpolation for normal sequences with abnormalities captured by the large reconstruction error. Subsequent approaches have used a similar objective to train graph networks (Markovitz et al 2020), probabilistic models (Flaborea et al 2023), and masked autoencoders (Stergiou et al 2024).

#### 5.4.3 Future outlooks

Although great progress has been made, most VAD methods still require adjusting the definitions of normal sequences to update predictions. A direction for future works can be a unified framework that can efficiently adapt predictions through **life-long learning**. Recent works (Yang et al 2024b; Zanella et al 2024) fused frame-wise language descriptions from LLMs without requiring re-training the visual model. This can be an effective strategy for upcoming VAD works. Most VAD approaches are also based on the accuracy of the produced summaries with video-language misalignment directly impacting performance. Potential improvements may explore **in-context learning**. Zhao et al (2024a) showed that progressively increasing task difficulty through prompts can aid the generalization ability of models to unseen visual scenes.

## 6 Future forecasting

The future is often uncertain. As shown in Figure 13, a sequence of steps can lead to multiple possible scenarios. Anticipation models are trained on objectives that require the discovery of domain-specific knowledge to address future anticipation challenges. We dis-

cuss methods for anticipating categorical semantics in Section 6.1. We then explore approaches for generating future actions in videos in Section 6.2.

### 6.1 Action anticipation

Action Anticipation (AA) uses current action(s) performed at  $\tau_1$  to forecast *proceeding actions* at  $\tau_2$ . In contrast to the partial observations for EAP, anticipation tasks only rely on the expected sequence with which actions can be performed. Early works (Kitani et al 2012; Kuehne et al 2014; Koppula and Saxena 2015) have used graphs to model the sequential nature of actions over time. However, to address the long-range dependency limitations of graph-based approaches, works have focused on the procedural execution of actions (Abu Farha et al 2018; Furnari and Farinella 2019; Ke et al 2019), the motion transition intensity between actions (Huang and Kitani 2014), as well as gaze and hand information (Shen et al 2018), while defining future-action objectives with multiple predictions (Furnari et al 2018; Zatsarynna et al 2024). Despite the diversity in approaches, some challenges remain.

#### 6.1.1 Challenges

Anticipation models predict future actions in sequences. Thus, **future action predictions are accumulated** across multiple rounds. As the future may be unpredictable, errors in these predictions will also influence and reduce the quality of subsequent predictions as the sequence’s length increases. Although some models forecast the entire sequence (Gong et al 2022a; Nawhal et al 2022), their temporal context is limited compared to autoregressive approaches.

Current works rely on **fixed anticipation time intervals** in which the intermission time  $\tau_{1 \rightarrow 2}$  remains constant in training and inference. This significantly limits the applicability of methods in real-world scenarios in which the duration of intervals varies, requiring models to adjust predictions based on conditions such as the speed of execution, difficulty of the action, or the actor's expertise. The majority of existing methods are bound to re-training to accommodate such characteristics.

### 6.1.2 Anticipation approaches

We discuss three action- and object-based future anticipation approaches.

**Embedding similarity maximization.** Representations of future actions can be used as targets for learned embeddings. A large number of methods have thus used future embedding reconstruction tasks to infer future action labels. Gao et al (2017b) used a recurrent decoder to regress future embeddings with an additional policy for class predictions over time. Interactions between objects and actors (Sun et al 2019c; Luc et al 2018) have been explored in early works. Subsequent methods aimed to either maximize the similarity between future and current embeddings through memory banks (Liu and Lam 2022), optimize latent representations for intended goals (Roy and Fernando 2022), learn prototypes (Diko et al 2024), or use adversarial representations (Gammulle et al 2019). Other generative approaches use pose information as priors (Villegas et al 2017) or focus on the extrapolation of activity trajectories (Chi et al 2023). Autoregressive approaches have recently shown great promise using either contrastive objectives (Wu et al 2020c), causal attention (Girdhar and Grauman 2021), or audio-visual inputs (Zhong et al 2023c). As future predictions depend on the usefulness of current observations, works have also integrated uncertainty terms in their predictions. Vondrick et al (2016a) regressed towards multiple plausible future embeddings, Abdelsalam et al (2023) grounded the sequentiality of visual embeddings to language, while Guo et al (2024a) defined probabilistic transformer outputs through a top-k prediction loss similar to Furnari et al (2018).

**Long-term anticipation.** The anticipation of the future can also be extended to forecasting multiple upcoming actions over a longer temporal duration. Bokhari and Kitani (2017) used a q-learning framework with reward functions for the activity label, and locations where actions are performed. Nawhal et al (2022) used a two-stage approach to first infer potential labels and then utilize their logits alongside visual features to predict

future action segments. Similarly, Gong et al (2022a) used learnable latent representations for the future embeddings and cross-attended (Jaegle et al 2021; Lee et al 2019) them with the observed video embeddings. Generative approaches have also learned future embeddings from pre-defined temporal states (Piergiovanni et al 2020), logit sequences (Zhao and Wildes 2020), cyclic consistency (Abu et al 2021), or the expected variance in future representations (Mascaró et al 2023; Patsch et al 2024). Recently, Mittal et al (2024) used general language and visual queries to infer prediction through LLMs.

**Next active object.** A recently introduced set of anticipation tasks concerns the study of object-centric future forecasting. Next active object anticipation forecast the objects that will be used in future actions and has been addressed using predictions on the salient regions (Dessalene et al 2021), hand position generated representations (Jiang et al 2021), or autoregressively attending object and visual information (Thakur et al 2024). Other methods may also forecast human-object interaction regions (Liu et al 2020, 2022c; Roy et al 2024), object relations (Roy and Fernando 2021; Zatsarynna et al 2021), or time-to-contact estimates (Mur-Labadia et al 2024).

### 6.1.3 Future outlooks

Despite the great advancements and number of methods for each anticipation task, less-studied aspects that enhance the applicability of current models exist. Primarily, although the intention of these approaches is their **deployment in real-time scenarios**, they are still used and evaluated in offline settings. Aspects such as latency and inference times for these models are largely overlooked with only a limited number of works designing stream-based models (Furnari and Farinella 2022; Girase et al 2023). The application of these models in real-world settings also requires **prediction adjustability** as inferring labels or sentences of a specific semantic hierarchy may not always be possible. Instead, the prediction granularity needs to be both adjusted and subsequently refined given the available video information. A greater research challenge concerns **multi-person anticipation** in which multiple atomic and group actions need to be forecasted. This also includes forecasting actions in social scenarios in which human-human interactions also need to be predicted, possibly with regard to the social context such as interpersonal relations and roles.

## 6.2 Video Generation

Forecasting future actions can be extended from the semantic space to the pixel space. Generating real-world physical phenomena includes a high level of complexity (Finn et al 2016). Capturing simple state transitions of pixels at times does not suffice in learning complex spatiotemporal variations of motions (Wu et al 2021b). Several types of models have been used throughout the years to address complex scene dynamics.

### 6.2.1 Challenges

Generating representative future actions is challenging. We visualize three prevalent challenges in video generation in Figure 14.

**Consistency failures.** Similar to forecasting the semantics of later actions, generative approaches can accumulate errors resulting in a degradation of the frame quality as the video progresses. Methods that either use memory banks (Oshima et al 2024), coarse to fine representations (Yin et al 2023), or generate long sequences in parallel (Zhuang et al 2024) either require long inference times or are computationally expensive.

**Physics failures.** As scene dynamics and characteristics of the real world are learned implicitly by generative models, out-of-distribution actions or motions may not be effectively synthesized. Most of the metrics and objectives used to quantify model performance are based only on the visual quality of the generated video. However, the scene’s realism also extends to feasible motions, actions, and permutations.

**Video-prompt alignment failures.** Conditional generation is a recent research topic of high interest. Text-to-Video (T2V) synthesis relies on binding LLM and noise latent embeddings to control video generation. Misalignments in the joint embedding space will be reflected in the outputs.

### 6.2.2 Methods

We discuss groups of generative video models next.

**Stochastic models.** This group explores future generation by encoding a variance latent. Variational Autoencoders (VAE) (Kingma and Welling 2013) have been used to stochastically generate trajectories (Walker et al 2016) and forecast motions representations (Fragkiadaki et al 2017). In the video domain, Babaeizadeh et al (2018) used the generator network from Finn et al (2016) alongside a probabilistically sampled latent to condition next frame generation by the variance of the previous frame. To improve the learned distribution of the generated outcomes, Denton and Fergus (2018)

used the KL-divergence between generated and previous frame latents to regularize the frame generation and avoid optimization shortcuts that copy previous frames. Yan et al (2018) learned differences between two adjacent views to improve the sampling distribution. Other works aimed to improve the learned variance by the differences between two adjacent views (Franceschi et al 2020) or through adaptive regularization of the reconstruction objective (Chatterjee et al 2021). Several methods have also employed a hierarchical latent to learn multiple levels of features (Castrejon et al 2019; Kumar et al 2020; Saxena et al 2021).

**Adversarially generated short video sequences.** Generative Adversarial Networks (GANs) (Goodfellow et al 2014) are based on an orthogonal objective between a generator network that synthesizes inputs from latent representations and a discriminator network optimized to distinguish between real and generated inputs. Video approaches extended the dimensionality of convolutional and deconvolutional kernels to space and time. An initial effort by Vondrick et al (2016b) was to learn scene dynamics from unlabeled videos with a dual objective of generating static backgrounds and moving foregrounds. Saito et al (2017) used a similar dual objective by first generating temporal adjacent views of latents and a spatial generator for frames. Works have also incorporated stochastic latent embeddings that can be decoded to the entire video (Lee et al 2018), separate spatial and temporal discriminators (Clark et al 2019), recurrent units (Gupta et al 2022; Wang et al 2023j), and spatio-temporal kernel transformations (Luc et al 2020). Menapace et al (2021) created an autoregressive approach to generate frames by conditioning the generation with discrete action labels. Other methods have adapted image-based GANs by generating latent trajectories of frame features (Tian et al 2021b) or shifting frame features across time (Munoz et al 2021). Yu et al (2022b) used spatiotemporal coordinate information from latent representations of motion and video diversity. Fu et al (2023) used a variational-based GAN (Esser et al 2021) to synthesize past or future frames (temporal outpainting) and current frames (inpainting) of videos based on both cues and textual descriptions. The model’s pipeline is shown in Figure 15. A partial video is used alongside a codebook of latents to generate the remaining frames. Stop gradients are used to contrastively update the encoder and codebook. A final frame-wise feature-matching function is used to improve the embedding distance of real and generated frames.

Despite the progress in video generation by adversarial models, instability in training and mode collapse



Fig. 14. **Video generation challenges.** Failure cases in video generation can be attributed to (a) poor continuity between frames with appearance or motion changes that do not correspond to the intended concept, (b) failure to capture real-world physics, and (c) poor video and prompt alignment, causing a mismatch between the generated scene and the given description.

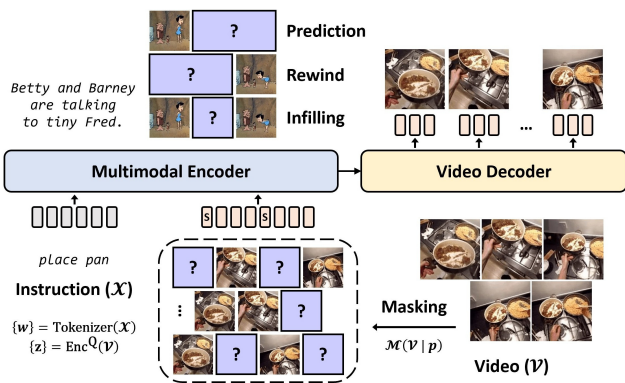

Fig. 15. **Multi-task video generation** model from Fu et al (2023). Based on a partial video and a text prompt used to condition a codebook, a text-condition video VQGAN generates missing frames.

are the primary disadvantages of GANs when generating realistic and diverse videos.

**Probabilistic models for video generation.** Denoising Diffusion Probabilistic Models (DDPMs) (Ho et al 2020; Sohl-Dickstein et al 2015; Song and Ermon 2019) combine two Markov processes with the first (forward) corrupting the input data to noise within a distribution. The second (backward) process reverses this effect by reconstructing an input from the noisy representation. New inputs not in the training data are generated by sampling the prior distribution. Ho et al (2022b) directly extended this formulation to video by extending the original U-Net’s (Salimans et al 2017) dimensionality used in the backward step with space-time kernels. Following works (He et al 2022c; Hong et al 2022b;

Blattmann et al 2023) have moved away from pixel-level diffusion. They instead utilize the semantically rich and lower-dimensional latent space (Rombach et al 2022) with autoencoders to encode and project video inputs and outputs. The computational efficiency of Latent Diffusion Models (LDM) has enabled a new stream of works to improve temporal alignment of frames (Blattmann et al 2023; Yang et al 2023d) and minimize training data requirements (Nikankin et al 2023; Wu et al 2023b). Yu et al (2023c) combined the two approaches by projecting videos to triplane representations. Yu et al (2024b) adapted image-based models by incorporating low-resolution temporal content latents computed as the weighted sum of frames. Both image-based and low-resolution motion-based models are denoised with a similar training objective conditioned on the context vector. Although video context can improve frame generation, the number of frames these models can generate is still limited.

**Text-conditioned generation.** Language embeddings are increasingly used as a prior for video generation. The objective of these methods is to generate videos from textual descriptions based on visual-language correspondence. Dorkenwald et al (2021) used the start and end times as generation-controlling factors. Following methods explored T2V generation based on VQVAE codebooks conditioned on language (Han et al 2022; Yan et al 2021), or language and motion (Hu et al 2022d). As LDM approaches rely on latent representations, unified visual-language embedding spaces can also be used to generate videos. LDM methods include joint conditional generation of images and videos (Gupta et al 2023), shifting latent features for

parameter-free temporal variance (An et al 2023), and concatenating frames in spatial grids (Lee et al 2024). Zeng et al (2024) showed that first generating the start and end action states enables models to effectively generate the transitioning frames limiting the dependence on well-formed textual descriptions. A number of recent works (Fei et al 2024a; Tian et al 2024b; Wang et al 2023h, 2024c; Wei et al 2024; Zhuang et al 2024) have employed adapters on image-based LDMs similar to ControlNet (Zhang et al 2023c). Given a pre-trained model using input latents and frozen parameters, a copy of the block is created with trainable parameters to fuse conditional latents of any modality type. These are integrated into the frozen model with projection or cross-attention layers.

**Generating long sequences.** Generating long videos is challenging as it requires models to learn long-range temporal dynamics. Initial efforts aimed to mitigate reductions in the generation quality over time through hybrid training schemes (Brooks et al 2022) and by concatenating frame-wise codecs over time for frame consistency in generation (Skorokhodov et al 2022). Shen et al (2023a) extended these approaches by using learnable latent vectors to represent motion styles as priors to generate frames. Harvey et al (2022) explored the conditionality between sampled frames for generating 25min videos with fixed backgrounds. Approaches (Ho et al 2022a; Singer et al 2023) have also focused on super-resolution models in tandem with LDMs to generate low-resolution long video sequences which are upsampled to higher resolutions in subsequent steps. Several models have been based on autoregression to accommodate future unpredictability and large video changes. Weissenborn et al (2020) extended the patch-based generation approach of Subscale Pixel Networks (SPNs) (Menick and Kalchbrenner 2019) to spatio-temporal voxels. Ge et al (2022a) used an autoregressive transformer to generate latent representations for the next frames with a VQVAE as a backbone generator. Other auto-regressive VQVAE-based works explored dimension-specific (Wu et al 2021a) and local attention (Liang et al 2022b; Wu et al 2022a). More recently, video generation methods have adapted causal attention encodings fused with previous frame features (Yan et al 2023c; Villegas et al 2022), used cross-attention adapters to include temporal context in image generators (Long et al 2024), and guided the generation with foreground masks (Chang et al 2024).

### 6.2.3 Future outlooks

Despite the recent substantial advancements of generative models, rudimentary challenges still exist that,

in turn, provide opportunities for future approaches. Crucially, despite the high appearance quality of current models, a standardized **evaluation and benchmark method** is missing. Approaches based on T2V generation have been shown to replace or fuse concepts, and generate irrelevant objects using specific low-confidence prompts (Du et al 2023). The scope of current evaluation and benchmark methods (Huang et al 2024b; Liu et al 2024e, 2023b; Saito et al 2020; Unterthiner et al 2019) is limited to primarily comparing the divergence of generated and real data distributions. Such comparisons do not reflect the extent to which the generated video conforms to the query, and how plausible the output is. The design of domain and characteristic-specific objectives is an interesting research direction.

Another point of improvement for future works is the implementation of **generation control based on physical realism**. Although control of the generation process has been explored in many modalities (Zhang et al 2023c), the number of works that aim to impose modality-specific characteristics and dynamics constraints in the generation remains small. Video consistency and physics failure cases highlighted in Figure 14 can be addressed by conditional terms that provide implicit information about the visual world. Such information could also be used explicitly by relying on physics simulations that reason about physical objects in the scene (Liu et al 2024c).

The large capacity of generative models has shown great capabilities in simulating complex scenes. The impact of this has been shown in works that can simulate interactions of actors and objects both in the physical world (Yang et al 2023c) and virtual renderings (Alonso et al 2024; Valevski et al 2024). Understanding aspects of the world to generate video frames aligns with a number of downstream tasks that can enable **generative models to be used as general-purpose models**.

## 7 Research directions to explore

Progress in video understanding is fast-paced. As shown in Figure 16, vision and language, video generation, and anomaly detection tasks have experienced significant interest in recent years. In tandem, well-established problems such as temporal tasks have remained relevant. We provide a look into the future and explore three main directions of progress beyond the continuation of current trends. We envision ways for future models to reason about abstractions in Section 7.1. We then consider the tasks and objectives that future action understanding models will address in

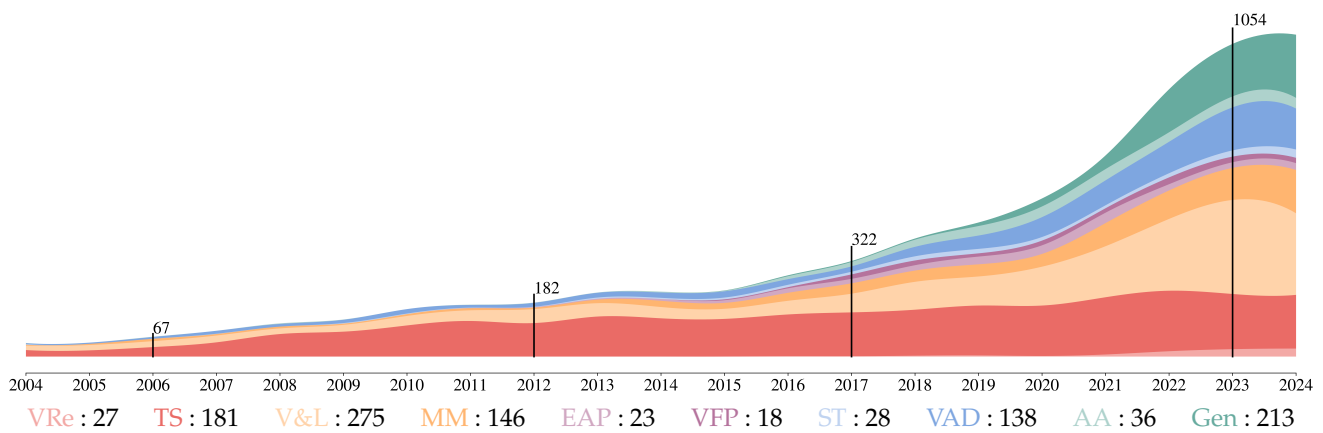

Fig. 16. **Number of action understanding papers per year.** The research focus (bottom to top) includes video reduction approaches **VRe**, temporal tasks **TS**, vision and language methods **V&L**, multimodal models **MM**, early action prediction **EAP**, video frame prediction **VFP**, state-based tasks **ST**, video anomaly detection **VAD**, action anticipation **AA**, and video generation **Gen**. The number of relevant papers is approximated from all works citing influential papers with  $\geq 300$  citations per group\*. Small disparities are expected as recent works may not be included. The increasing research activity in action understanding is evident.

Section 7.2. Finally, we discuss efficiency improvements for training and deployment in Section 7.3.

## 7.1 Reasoning semantics

With the shift from visual to semantic pattern extraction, the notion of abstraction levels will become more central. We explore future directions for interpreting actions, considering intentions and goals, and adapting to unseen scenarios.

### 7.1.1 From action to understanding

Increasingly, action understanding is concerned not only with what is visually depicted but with reasoning about how the depiction is just one out of a multitude of possible perspectives. While action recognition tasks have driven a significant amount of progress on visual representations, future tasks will require more semantic interpretation. When moving from isolated clips of actions to longer episodes depicting behaviors, modeling long-range temporal dependencies becomes more important. Understanding behavior over time requires more than just aggregated interpretations of brief clips. Simultaneously, the distinction between visual observation and interpretation will become weaker, achieving a less deterministic view of action understanding with potentially multiple possible interpretations. Consequently, the automated analysis of videos will shift from objectively measuring or labeling, to a more subjective, context-dependent interpretation. In turn,

this will require novel ways of training and evaluation, for example by including humans (Kaufmann et al 2023).

One perspective on context is to include the intentions of those depicted. Despite VLMs' great progress in learning procedural steps in tasks through natural language-guided embeddings (Li et al 2024f,g; Wu et al 2024a), their reliance on visual information remains partial. Al-Tahan et al (2024) showed that scaling models and data sizes do not offer substantial reasoning performance gains for vision tasks despite strong performance in skill-based tasks. Thus, a new avenue for future approaches is the design of open-world models from multi-level semantics that reflect human intentions and goals. Capturing information about the visual world in a scene may not necessarily require to be associated with language embeddings. Instead, relations could correspond to different pairs or groups of modalities adaptively. Longitudinal data specific to individuals may also be used to tailor the model's understanding of the world based on the user's goals, objectives, intentions, and interactions. Such treatment gives rise to a person- or case-specific perspective, bringing general action understanding to the consumer.

### 7.1.2 Novel problem adaptation

Zero-shot performance has improved significantly over the past years. This is especially evident in language-

\* From Google Scholar as of the 28th of October 2024.

and semantic-based video tasks aided by LLMs' large capacity and context. However, limitations remain in tasks orthogonal to pre-text SSL (Liu et al 2024f). Recent approaches such as modality and probabilistic adapters (Chen et al 2024c; Lin et al 2023b; Sung et al 2022; Upadhyay et al 2023; Lu et al 2024), information gating (Zhang et al 2024a), visual prompt learning (Khattak et al 2023), knowledge distillation (Mistretta et al 2024), and model caching (Zhang et al 2021d) have improved zero-shot downstream task performance by adjusting pre-trained models. However, only a few structural elements or objectives in models explicitly improve zero-shot performance for unseen distinct tasks. Unified models that can be used as mixture of experts controllers (Bao et al 2022; Lin et al 2024; Wang et al 2022c; Yu et al 2024a) are promising to bridge this gap. Sparsely trained models in mixture of experts settings allow for faster inference times with only task-relative sub-models using conditional computations (Bengio et al 2013b; Jacobs et al 1991). When such mixtures can be linked to different levels of abstraction, re-use of models across levels also becomes feasible. The integration of experts can be done regardless of the backbone architecture.

## 7.2 Better task definitions

Training models does not necessarily guarantee that temporal dynamics of videos are learned at a foundational level. Future research may revisit and integrate beneficial properties for representation learning. Additionally, future works can explore performance measurements beyond simple metrics, instead focusing on explanation by observing embedding distributions and feature correspondences.

### 7.2.1 Objectives

Distributions learned from representation-based objectives can be effectively used as priors to downstream tasks (Janocha and Czarnecki 2017; Larochelle et al 2009). Drawing inspiration from (Bengio et al 2013a), a number of widely-accepted target properties are discussed below.

**Temporal and spatial coherence.** Temporally or spatially proximal instances should correspond to similar representations. This notion can be extended to maintain proportional distances across both the pixel and embedding spaces. This coherence prior has been explored in objectives relating to time such as cyclic consistency (Dwibedi et al 2018; Donahue and Elhamifar 2024; Haresh et al 2021), video procedural learning (Chen et al 2022c; Sermanet et al 2018), DTW (Dvornik

et al 2021; Hadji et al 2021), and cross-frame stochasticity (Zhang et al 2023b). These priors can be explored in a more general context as pre-training tasks similar to SSL while being tailored to the nature of videos.

**Abstractions and hierarchies.** Beyond fine-grained categories and semantics, most current works do not explicitly learn levels of abstraction. They are primarily limited to implicit connections between specific types (Li et al 2024e) that often lead to spurious correlations (Chen et al 2020b; Kim et al 2023; Tian et al 2024a) as well as task- and instance-based misalignment (Zhang et al 2024d). Objectives that enforce abstraction hierarchies can potentially mitigate such misalignments. Promising efforts include partial order relations (Alper and Averbuch-Elor 2024), prototype learning (Ramesh et al 2022), hyperbolic representations (Mettes et al 2024), and scene graphs (Li et al 2024b). As models become more polysemantic, the use of natural hierarchies and abstractions is expected to become more prevalent.

**Natural clustering and manifolds.** Local representations tend to preserve similar polysemantic characteristics. Several works have shown that real data are not represented within the totality of the feature space but instead form dense concentrations in specific regions (Genovese et al 2012; Jiang et al 2018; Liang et al 2022d). Using the tangent space of these distributions as a prior has shown promise in vision tasks such as generation (He et al 2023), model explanation (Bordt et al 2023), anomaly detection (Shin et al 2023), and corruption robustness (Chen et al 2022d). However, using the tangent space from real data distributions as an objective-steering prior remains largely an open question for large-scale multi-modal action understanding models.

### 7.2.2 Limitations in performance beyond metrics

Much of the progress in the domain of action understanding originates from comparing model outputs on benchmark data. While reported performance provides insights into the relative merits of models, it does not provide a good understanding of typical failure modes. Recent image-based (Kowal et al 2024a,b; Park et al 2023; Walmer et al 2023) and video-based (Kowal et al 2024a; Stergiou and Deligiannis 2023) visualization approaches provide human-interpretable insights into predictions at the instance level. However, understanding how semantic interpretations of actions are addressed, remains largely unexplored. This limits understanding the generalization ability to novel domains and tasks. Uptake of recent explainable AI trends (Minh et al 2022) into computer vision model development



can prompt the development of better measures for the capabilities and limitations of novel models.

Beyond benchmarking models on tasks and metrically evaluating performance, understanding the distributions and learned correlations provides new research opportunities. In-Context Learning (ICL) (Brown et al 2020; Hoffmann et al 2022) and Chain-of-Thought (CoT) (Wei et al 2022c) prompting are promising directions for LLMs and VLMs. Bansal et al (2023) has shown that LLMs' capabilities are influenced by just a small number of attention or feed-forward layers, which are highly task-specific. Both Baldassini et al (2024); Chen et al (2024d) showed that ICL in VLMs primarily relies on text information. Disparities between target and learned features can occur due to shortcuts learned by models. Common factors that can lead to shortcuts include contrastive loss' multiple local minima (Robinson et al 2021), suppression of visual information by language (Li et al 2023e), and low mutual information between latent representations and real data (Adnan et al 2022). Recently, Bleeker et al (2024) showed that introducing unique information distal to the overall training distribution favors VLMs' reliance on shortcuts for models trained on contrastive objectives. Such insights provide opportunities for exploring objectives and models with better multi-modal and data-varying generalization capabilities.

### 7.3 Efficiency

Model efficiency is essential for real-time application. Given the rapid deployment of models in a multitude of applications, we also highlight privacy risks alongside opportunities for domain specialization.

#### 7.3.1 From research to deployment

The increased variety of action understanding tasks also comes with the potential of improving actual deployment. Current and future models achieve performance and robustness levels that allow them to automate processes such as video data curation and surveillance. Novel applications based on behavior analysis can also benefit from these advances. Moving from benchmarks to the real world requires attention to computational efficiency. While the accuracy of current models is remarkable, performance comes at a cost. The trend of increasing model sizes, partly because of the focus on foundation models, largely prohibits the use of these models in computationally constrained operational settings. Attempts to reduce the computational complexity of trained models through pruning (Iofinova et al 2023), knowledge distillation (Mistretta

et al 2024), or domain-specific adapters (Hu et al 2021) are not without limitations. The generalization performance gap between the currently best-performing models and those that can run on consumer hardware is significant. Several recent works (Dao et al 2022; Gu and Dao 2023; Poli et al 2023) propose novel processing paradigms that have the potential to scale better. Future work should address whether advances in multi-modal training can transfer across both settings and models.

#### 7.3.2 Generalizable priors

Modern models are primarily trained on large-scale uncurated datasets aimed at multi-domain generalization. However, training distributions can include noise or be insufficiently rich for domain-specific datasets. Recent approaches have aimed to reduce training data requirements by including distribution priors at training. Kahana et al (2022) aimed to improve zero-shot performance with a joint objective that matches label distributions while minimizing the divergence to original zero-shot predictions. Gao et al (2022a) utilized multiple levels of abstraction to contrast language and visual semantics and improve training efficiency. Nag et al (2024) used a weakly-supervised approach to refine pseudo-object masks with cross-modal alignment in low-annotation settings. Approaches specifically utilizing priors in videos include concept distillation from normalized language embeddings (Ranasinghe and Ryoo 2023), and motion-specific alignment between video and textual descriptions of movements (Zhang et al 2024b). Distilling learned information to then be used as an optimization prior is a promising route for efficient training by reducing resource requirements. It can also impose a constraint based on the nature of expected motions with potential benefits in model convergence.

#### 7.3.3 Privacy and specialization

Vision-based models are susceptible to attacks that either invert their gradients to reconstruct inputs (Hatamizadeh et al 2022) or discover intermediate representations (Fang et al 2023). Such attacks can compromise potentially proprietary training data, and reveal identifiable information. Inputs and features from VLMs can also be inferred through learnable vision-language triggers (Bai et al 2024a), inference-time adversarial perturbations in frames (Li et al 2024c), backdoor attacks through adversarial patches in training (Carlini and Terzis 2022), and injecting malicious prompts during instruction tuning (Liang et al 2024a). Kariyappa et al (2023) showed that semantics from the

original data can still be recovered even in distributed settings over large batches. Such vulnerabilities can be exploited across downstream tasks. Thus, evaluating model robustness is an important topic that the community should attend to.

The importance of privacy can also be understood through the current shift toward domain-expert sub-models integrated into general-purpose frameworks. Shen et al (2024) showed that LLM specialization on domain-specific tasks significantly improves zero-shot generalization in related domains. Visual instructional tuning (Bai et al 2024b) and evolutionary instruction-based prompting (Luo et al 2024) have also shown promising results for vision-language models. Enhancing video-based models with domain specialization requires further exploration, for example through singular general models of high capacity, or multiple models in holistic frameworks.

## 8 Conclusion

Video action understanding includes a diverse set of tasks. These previously isolated tasks are increasingly overlapping in terms of the deployed models, utilized training data, and used evaluation protocols. To this end, we provide a comprehensive review of the broad domain of video action understanding. We discussed the main challenges, relevant datasets, and seminal works with an emphasis on recent (multi-modal) advancements across tasks, and future research directions. We explicitly included multi-modal advances. We focused on three temporal scopes from which tasks and approaches understand actions performed. We discussed recognition tasks that use complete observations of actions to infer fine- or coarse-grained labels. We then overviewed predictive tasks from partial observations of actions. Finally, we outlined forecasting tasks with anticipation models that infer general scene knowledge and forecast future actions not yet performed. Using time as a stepping stone, we outline current limitations and promising research directions to further advance the scope, robustness, and deployment of action understanding research.

## References

- Aafaq N, Akhtar N, Liu W, Gilani SZ, Mian A (2019) Spatio-temporal dynamics and semantic attribute enriched visual encoding for video captioning. In: CVPR
- Aakur SN, Sarkar S (2019) A perceptual prediction framework for self supervised event segmentation. In: CVPR
- Abati D, Ben Yahia H, Nagel M, Habibian A (2023) Resq: Residual quantization for video perception. In: ICCV
- Abdelsalam MA, Rangrej SB, Hadji I, Dvornik N, Derpanis KG, Fazly A (2023) Gepsan: Generative procedure step anticipation in cooking videos. In: ICCV
- Abu Y, Ke Q, Schiele B, Gall J (2021) Long-term anticipation of activities with cycle consistency. In: DAGM GCPR
- Abu-El-Hajja S, Kothari N, Lee J, Natsev P, Toderici G, Varadarajan B, Vijayanarasimhan S (2016) Youtube-8m: A large-scale video classification benchmark. arXiv:160908675
- Abu Farha Y, Richard A, Gall J (2018) When will you do what?-anticipating temporal occurrences of activities. In: CVPR
- Acsintoae A, Florescu A, Georgescu MI, Mare T, Sumedrea P, Ionescu RT, Khan FS, Shah M (2022) Ubnormal: New benchmark for supervised open-set video anomaly detection. In: CVPR
- Adnan M, Ioannou Y, Tsai CY, Galloway A, Tizhoosh HR, Taylor GW (2022) Monitoring shortcut learning using mutual information. In: ICMLw
- Agarwal N, Chen YT, Dariush B, Yang MH (2020) Unsupervised domain adaptation for spatio-temporal action localization. In: BMVC
- Aggarwal JK, Cai Q (1999) Human motion analysis: A review. CVIU
- Aggarwal JK, Cai Q, Liao W, Sabata B (1994) Articulated and elastic non-rigid motion: A review. In: Workshop on Motion of Non-rigid and Articulated Objects
- Aggarwal JK, Cai Q, Liao W, Sabata B (1998) Nonrigid motion analysis: Articulated and elastic motion. CVIU
- Akbari H, Yuan L, Qian R, Chuang WH, Chang SF, Cui Y, Gong B (2021) Vatt: Transformers for multimodal self-supervised learning from raw video, audio and text. NeurIPS
- Aklilu J, Wang X, Yeung-Levy S (2024) Zero-shot action localization via the confidence of large vision-language models. 241014340
- Al-Tahan H, Garrido Q, Balestriero R, Bouchacourt D, Hazirbas C, Ibrahim M (2024) Unibench: Visual reasoning requires rethinking vision-language beyond scaling. arXiv:240804810
- Alayrac JB, Bojanowski P, Agrawal N, Sivic J, Laptev I, Lacoste-Julien S (2016) Unsupervised learning from narrated instruction videos. In: CVPR
- Alayrac JB, Laptev I, Sivic J, Lacoste-Julien S (2017) Joint discovery of object states and manipulation actions. In: ICCV
- Alayrac JB, Donahue J, Luc P, Miech A, Barr I, Hasson Y, Lenc K, Mensch A, Millican K, Reynolds M, et al (2022) Flamingo: a visual language model for few-shot learning. NeurIPS
- Alayrac JB, Miech A, Laptev I, Sivic J, et al (2024) Multi-task learning of object states and state-modifying actions from web videos. IEEE TPAMI
- Albanese M, Chellappa R, Cuntoor N, Moscato V, Picariello A, Subrahmanian V, Udrea O (2010) Pads: A probabilistic activity detection framework for video data. IEEE TPAMI
- Albanie S, Liu Y, Nagrani A, Miech A, Coto E, Laptev I, Sukthankar R, Ghanem B, Zisserman A, Gabeur V, et al (2020) The end-of-end-to-end: A video understanding pentathlon challenge (2020). arXiv:200800744
- Albu AB, Bergevin R, Quirion S (2008) Generic Temporal Segmentation of Cyclic Human Motion. PR
- Ali MK, Kim D, Kim TH (2023) Task agnostic restoration of natural video dynamics. In: CVPR
- AlMarri S, Zaheer MZ, Nandakumar K (2024) A multi-head approach with shuffled segments for weakly-supervised video anomaly detection. In: WACVw
- Alonso E, Jelley A, Micheli V, Kanervisto A, Storkey A, Pearce T, Fleuret F (2024) Diffusion for world modeling: Visual details matter in atari. arXiv:240512399
- Alper M, Averbuch-Elor H (2024) Emergent visual-semantic hierarchies in image-text representations. In: ECCV

- Alwassel H, Heilbron FC, Escorcia V, Ghanem B (2018) Diagnosing error in temporal action detectors. In: ECCV
- Alwassel H, Giancola S, Ghanem B (2021) Tsp: Temporally-sensitive pretraining of video encoders for localization tasks. In: ICCV
- Amer MR, Todorovic S (2012) Sum-product networks for modeling activities with stochastic structure. In: CVPR
- Amrani E, Ben-Ari R, Rotman D, Bronstein A (2021) Noise estimation using density estimation for self-supervised multimodal learning. In: AAAI
- An J, Zhang S, Yang H, Gupta S, Huang JB, Luo J, Yin X (2023) Latent-shift: Latent diffusion with temporal shift for efficient text-to-video generation. arXiv:230408477
- Anderson P, Wu Q, Teney D, Bruce J, Johnson M, Sünderhauf N, Reid I, Gould S, Van Den Hengel A (2018) Vision-and-language navigation: Interpreting visually-grounded navigation instructions in real environments. In: CVPR
- Andrew G, Arora R, Bilmes J, Livescu K (2013) Deep canonical correlation analysis. In: ICML
- Antol S, Agrawal A, Lu J, Mitchell M, Batra D, Zitnick CL, Parikh D (2015) Vqa: Visual question answering. In: ICCV
- Arandjelovic R, Zisserman A (2018) Objects that sound. In: ECCV
- Arnab A, Dehghani M, Heigold G, Sun C, Lučić M, Schmid C (2021a) Vivit: A video vision transformer. In: ICCV
- Arnab A, Sun C, Schmid C (2021b) Unified graph structured models for video understanding. In: CVPR
- Ashutosh K, Girdhar R, Torresani L, Grauman K (2023a) Hivervl: Learning hierarchical video-language embeddings. In: CVPR
- Ashutosh K, Ramakrishnan SK, Afouras T, Grauman K (2023b) Video-mined task graphs for keystone recognition in instructional videos. NeurIPS
- Astrid M, Zaheer MZ, Lee JY, Lee SI (2021a) Learning not to reconstruct anomalies. In: BMVC
- Astrid M, Zaheer MZ, Lee SI (2021b) Synthetic temporal anomaly guided end-to-end video anomaly detection. In: ICCVw
- Aytar Y, Vondrick C, Torralba A (2016) Soundnet: Learning sound representations from unlabeled video. In: NeurIPS
- Azy O, Ahuja N (2008) Segmentation of Periodically Moving Objects. In: ICPR
- Baade A, Peng P, Harwath D (2022) Mae-ast: Masked autoencoding audio spectrogram transformer. In: Interspeech
- Babaeizadeh M, Finn C, Erhan D, Campbell RH, Levine S (2018) Stochastic variational video prediction. In: ICLR
- Baccouche M, Mamalet F, Wolf C, Garcia C, Baskurt A (2011) Sequential deep learning for human action recognition. In: HBU
- Bacharidis K, Argyros A (2023) Repetition-aware Image Sequence Sampling for Recognizing Repetitive Human Actions. In: ICCVw
- Bachmann R, Mizrahi D, Atanov A, Zamir A (2022) Multimaes: Multi-modal multi-task masked autoencoders. In: ECCV
- Badamdorj T, Roohan M, Wang Y, Cheng L (2022) Contrastive learning for unsupervised video highlight detection. In: CVPR
- Baevski A, Hsu WN, Xu Q, Babu A, Gu J, Auli M (2022) Data2vec: A general framework for self-supervised learning in speech, vision and language. In: ICML
- Bagad P, Tapaswi M, Snoek CGM (2023) Test of time: Instilling video-language models with a sense of time. In: CVPR
- Bai J, Gao K, Min S, Xia ST, Li Z, Liu W (2024a) Badclip: Trigger-aware prompt learning for backdoor attacks on clip. In: CVPR
- Bai S, Ma B, Chang H, Huang R, Chen X (2022) Salient-to-broad transition for video person re-identification. In: CVPR
- Bai Y, Wang Y, Tong Y, Yang Y, Liu Q, Liu J (2020) Boundary content graph neural network for temporal action proposal generation. In: ECCV
- Bai Y, Zhou Y, Zhou J, Goh RSM, Ting DSW, Liu Y (2024b) From generalist to specialist: Adapting vision language models via task-specific visual instruction tuning. arXiv:241006456
- Bain M, Nagrani A, Varol G, Zisserman A (2021) Frozen in time: A joint video and image encoder for end-to-end retrieval. In: ICCV
- Baldassini FB, Shukor M, Cord M, Soulier L, Piwowarski B (2024) What makes multimodal in-context learning work? In: CVPRw
- Ballas N, Yao L, Pal C, Courville A (2015) Delving deeper into convolutional networks for learning video representations. In: ICLR
- Bandara WGC, Patel N, Gholami A, Nikkiah M, Agrawal M, Patel VM (2023) Adamae: Adaptive masking for efficient spatiotemporal learning with masked autoencoders. In: CVPR
- Bansal H, Gopalakrishnan K, Dingliwal S, Bodapati S, Kirchoff K, Roth D (2023) Rethinking the role of scale for in-context learning: An interpretability-based case study at 66 billion scale. In: ACL
- Bansal S, Arora C, Jawahar C (2022) My view is the best view: Procedure learning from egocentric videos. In: ECCV
- Bao H, Dong L, Piao S, Wei F (2021) Beit: Bert pre-training of image transformers. arXiv preprint arXiv:210608254
- Bao H, Wang W, Dong L, Liu Q, Mohammed OK, Aggarwal K, Som S, Piao S, Wei F (2022) Vlmo: Unified vision-language pre-training with mixture-of-modality-experts. NeurIPS
- Baqué P, Fleuret F, Fua P (2017) Deep occlusion reasoning for multi-camera multi-target detection. In: ICCV
- Bardes A, Ponce J, LeCun Y (2021) Vicreg: Variance-invariance-covariance regularization for self-supervised learning. In: ICLR
- Bardes A, Ponce J, LeCun Y (2023) Mc-jepa: A joint-embedding predictive architecture for self-supervised learning of motion and content features. arXiv:230712698
- Barekattain M, Martí M, Shih HF, Murray S, Nakayama K, Matsuo Y, Prendinger H (2017) Okutama-action: An aerial view video dataset for concurrent human action detection. In: IC-CVw
- Barnard K, Forsyth D (2001) Learning the semantics of words and pictures. In: ICCV
- Barnard K, Duygulu P, Forsyth D, De Freitas N, Blei DM, Jordan MI (2003) Matching words and pictures. JMLR
- Becattini F, Uricchio T, Seidenari L, Ballan L, Bimbo AD (2020) Am i done? predicting action progress in videos. TOMM
- Beddard DR, Nini B, Sabokrou M, Hadid A (2020) Vision-based human activity recognition: a survey. MTA
- Ben-Shabat Y, Yu X, Saleh F, Campbell D, Rodriguez-Opazo C, Li H, Gould S (2021) The ikea asm dataset: Understanding people assembling furniture through actions, objects and pose. In: WACV
- BenAbdelkader C, Cutler RG, Davis LS (2004) Gait recognition using image self-similarity. EURASIP
- Benaim S, Ephrat A, Lang O, Mosseri I, Freeman WT, Rubinstein M, Irani M, Dekel T (2020) Speednet: Learning the speediness in videos. In: CVPR
- Benfold B, Reid I (2011) Stable multi-target tracking in real-time surveillance video. In: CVPR
- Bengio Y, Courville A, Vincent P (2013a) Representation learning: A review and new perspectives. IEEE TPAMI
- Bengio Y, Léonard N, Courville A (2013b) Estimating or propagating gradients through stochastic neurons for conditional computation. arXiv:13083432

- Bertasius G, Wang H, Torresani L (2021) Is space-time attention all you need for video understanding? In: ICML
- Bilen H, Fernando B, Gavves E, Vedaldi A, Gould S (2016) Dynamic image networks for action recognition. In: CVPR
- Blank M, Gorelick L, Shechtman E, Irani M, Basri R (2005) Actions as space-time shapes. In: ICCV
- Blattmann A, Rombach R, Ling H, Dockhorn T, Kim SW, Fidler S, Kreis K (2023) Align your latents: High-resolution video synthesis with latent diffusion models. In: CVPR
- Bleeker M, Hendriksen M, Yates A, de Rijke M (2024) Demonstrating and reducing shortcuts in vision-language representation learning. TMLR
- Bobick AF, Davis JW (2001) The recognition of human movement using temporal templates. IEEE TPAMI
- de Boer F, van Gemert JC, Dijkstra J, Pinteá SL (2023) Is there progress in activity progress prediction? In: ICCVw
- Bokhari SZ, Kitani KM (2017) Long-term activity forecasting using first-person vision. In: ACCV
- Bordt S, Upadhyay U, Akata Z, von Luxburg U (2023) The manifold hypothesis for gradient-based explanations. In: CVPRw
- Bottou L (1998) Online algorithms and stochastic approximations. Online learning in neural networks
- Brassouli A, Ahuja N (2007) Extraction and Analysis of Multiple Periodic Motions in Video Sequences. IEEE TPAMI
- Brooks T, Hellsten J, Aittala M, Wang TC, Aila T, Lehtinen J, Liu MY, Efros A, Karras T (2022) Generating long videos of dynamic scenes. NeurIPS
- Brooks T, Peebles B, Holmes C, DePue W, Guo Y, Jing L, Schnurr D, Taylor J, Luhman T, Luhman E, Ng C, Wang R, Ramesh A (2024) Video generation models as world simulators. URL <https://openai.com/research/video-generation-models-as-world-simulators>
- Brown T, Mann B, Ryder N, Subbiah M, Kaplan JD, Dhariwal P, Neelakantan A, Shyam P, Sastry G, Askell A, et al (2020) Language models are few-shot learners. NeurIPS
- Broxton M, Flynn J, Overbeck R, Erickson D, Hedman P, Duvall M, Dourgarian J, Busch J, Whalen M, Debevec P (2020) Immersive light field video with a layered mesh representation. ACM TOG
- Bugarin N, Bugarcic J, Barusco M, Pezze DD, Susto GA (2024) Unveiling the anomalies in an ever-changing world: A benchmark for pixel-level anomaly detection in continual learning. In: CVPRw
- Bulat A, Perez Rua JM, Sudhakaran S, Martinez B, Tzimiropoulos G (2021) Space-time mixing attention for video transformer. NeurIPS
- Buxton H (2003) Learning and understanding dynamic scene activity: a review. IVC
- Caba Heilbron F, Escorcia V, Ghanem B, Carlos Niebles J (2015) Activitynet: A large-scale video benchmark for human activity understanding. In: CVPR
- Cai D, Qian S, Fang Q, Hu J, Ding W, Xu C (2022) Heterogeneous graph contrastive learning network for personalized micro-recommendation. IEEE TMM
- Cai Y, Li H, Hu JF, Zheng WS (2019) Action knowledge transfer for action prediction with partial videos. In: AAAI
- Calvo-Merino B, Glaser DE, Grèzes J, Passingham RE, Haggard P (2005) Action observation and acquired motor skills: an fmri study with expert dancers. Cerebral cortex
- Cao M, Chen L, Shou MZ, Zhang C, Zou Y (2021) On pursuit of designing multi-modal transformer for video grounding. In: EMNLP
- Cao Y, Barrett D, Barbu A, Narayanaswamy S, Yu H, Michaux A, Lin Y, Dickinson S, Mark Siskind J, Wang S (2013) Recognize human activities from partially observed videos. In: CVPR
- Carion N, Massa F, Synnaeve G, Usunier N, Kirillov A, Zagoruyko S (2020) End-to-end object detection with transformers. In: ECCV
- Carlini N, Terzis A (2022) Poisoning and backdooring contrastive learning. In: ICLR
- Caron M, Misra I, Mairal J, Goyal P, Bojanowski P, Joulin A (2020) Unsupervised learning of visual features by contrasting cluster assignments. NeurIPS
- Caron M, Touvron H, Misra I, Jégou H, Mairal J, Bojanowski P, Joulin A (2021) Emerging properties in self-supervised vision transformers. In: ICCV
- Carreira J, Zisserman A (2017) Quo vadis, action recognition? a new model and the kinetics dataset. In: CVPR
- Carreira J, Noland E, Banki-Horvath A, Hillier C, Zisserman A (2018) A short note about kinetics-600. arXiv:180801340
- Carreira J, Noland E, Hillier C, Zisserman A (2019) A short note on the kinetics-700 human action dataset. arXiv:190706987
- Castrejon L, Ballas N, Courville A (2019) Improved conditional vrnn for video prediction. In: ICCV
- Cedras C, Shah M (1995) Motion-based recognition a survey. IVC
- Chaabane M, Trabelsi A, Blanchard N, Beveridge R (2020) Looking ahead: Anticipating pedestrians crossing with future frames prediction. In: WACV
- Chaarouai AA, Climent-Pérez P, Flórez-Revuelta F (2012) A review on vision techniques applied to human behaviour analysis for ambient-assisted living. ESWA
- Chandrasegaran K, Gupta A, Hadzic LM, Kota T, He J, Eyzaguirre C, Durante Z, Li M, Wu J, Fei-Fei L (2024) Hourvideo: 1-hour video-language understanding. In: NeurIPS
- Chang CY, Huang DA, Sui Y, Fei-Fei L, Niebles JC (2019) D3tw: Discriminative differentiable dynamic time warping for weakly supervised action alignment and segmentation. In: CVPR
- Chang M, Prakash A, Gupta S (2024) Look ma, no hands! agent-environment factorization of egocentric videos. NeurIPS
- Chang Z, Zhang X, Wang S, Ma S, Ye Y, Xinguang X, Gao W (2021) Mau: A motion-aware unit for video prediction and beyond. In: NeurIPS
- Chang Z, Zhang X, Wang S, Ma S, Gao W (2022) Strpm: A spatiotemporal residual predictive model for high-resolution video prediction. In: CVPR
- Chao YW, Vijayanarasimhan S, Seybold B, Ross DA, Deng J, Sukthankar R (2018) Rethinking the faster r-cnn architecture for temporal action localization. In: CVPR
- Chao YW, Yang W, Xiang Y, Molchanov P, Handa A, Tremblay J, Narang YS, Van Wyk K, Iqbal U, Birchfield S, et al (2021) Dexycb: A benchmark for capturing hand grasping of objects. In: CVPR
- Chatterjee M, Ahuja N, Cherian A (2021) A hierarchical variational neural uncertainty model for stochastic video prediction. In: ICCV
- Chen C, Ashutosh K, Girdhar R, Harwath D, Grauman K (2024a) Soundingactions: Learning how actions sound from narrated egocentric videos. In: CVPR
- Chen D, Dolan WB (2011) Collecting highly parallel data for paraphrase evaluation. In: ACL
- Chen G, Zheng YD, Wang L, Lu T (2022a) Dcan: improving temporal action detection via dual context aggregation. In: AAAI
- Chen G, Huang Y, Xu J, Pei B, Chen Z, Li Z, Wang J, Li K, Lu T, Wang L (2024b) Video mamba suite: State space model as a versatile alternative for video understanding. arXiv preprint arXiv:240309626
- Chen H, Xie W, Vedaldi A, Zisserman A (2020a) Vggsound: A large-scale audio-visual dataset. In: ICASSP
- Chen H, Huang Z, Hong Y, Wang Y, Lyu Z, Xu Z, Lan J, Gu Z (2024c) Efficient transfer learning for video-language foun-

- ation models. arXiv:24111223
- Chen J, Chen X, Ma L, Jie Z, Chua TS (2018a) Temporally grounding natural sentence in video. In: EMNLP
- Chen L, Yan X, Xiao J, Zhang H, Pu S, Zhuang Y (2020b) Counterfactual samples synthesizing for robust visual question answering. In: CVPR
- Chen L, Lu J, Song Z, Zhou J (2022b) Ambiguosness-aware state evolution for action prediction. IEEE TCSVT
- Chen M, Wei F, Li C, Cai D (2022c) Frame-wise action representations for long videos via sequence contrastive learning. In: CVPR
- Chen M, Wen C, Zheng F, He F, Shao L (2022d) Vita: A multi-source vicinal transfer augmentation method for out-of-distribution generalization. In: AAAI
- Chen P, Huang D, He D, Long X, Zeng R, Wen S, Tan M, Gan C (2021a) Rspnet: Relative speed perception for unsupervised video representation learning. In: AAAI
- Chen S, Jiang YG (2021) Towards bridging event captioner and sentence localizer for weakly supervised dense event captioning. In: CVPR
- Chen S, Chen J, Jin Q (2017a) Generating video descriptions with topic guidance. In: ICMR
- Chen S, Sun P, Xie E, Ge C, Wu J, Ma L, Shen J, Luo P (2021b) Watch only once: An end-to-end video action detection framework. In: ICCV
- Chen S, Han Z, He B, Buckley M, Torr P, Tresp V, Gu J (2024d) Understanding and improving in-context learning on vision-language models. In: ICLRw
- Chen T, Kornblith S, Norouzi M, Hinton G (2020c) A simple framework for contrastive learning of visual representations. In: ICML
- Chen T, Luo C, Li L (2021c) Intriguing properties of contrastive losses. NeurIPS
- Chen TS, Siarohin A, Menapace W, Deyneka E, Chao Hw, Jeon BE, Fang Y, Lee HY, Ren J, Yang MH, et al (2024e) Panda-70m: Captioning 70m videos with multiple cross-modality teachers. In: CVPR
- Chen X, Wang W, Wang J, Li W (2017b) Learning object-centric transformation for video prediction. In: MM
- Chen Y, Kalantidis Y, Li J, Yan S, Feng J (2018b) A<sup>2</sup>-nets: Double attention networks. NeurIPS
- Chen Y, Kalantidis Y, Li J, Yan S, Feng J (2018c) Multi-fiber networks for video recognition. In: ECCV
- Chen Y, Fan H, Xu B, Yan Z, Kalantidis Y, Rohrbach M, Yan S, Feng J (2019) Drop an octave: Reducing spatial redundancy in convolutional neural networks with octave convolution. In: CVPR
- Chen Y, Liu Z, Zhang B, Fok W, Qi X, Wu YC (2023) Mgfn: Magnitude-contrastive glance-and-focus network for weakly-supervised video anomaly detection. In: AAAI
- Cheng F, Bertasius G (2022) Tallformer: Temporal action localization with a long-memory transformer. In: ECCV
- Cheng F, Xu M, Xiong Y, Chen H, Li X, Li W, Xia W (2022) Stochastic backpropagation: A memory efficient strategy for training video models. In: CVPR
- Cheng F, Wang X, Lei J, Crandall D, Bansal M, Bertasius G (2023) Vindlu: A recipe for effective video-and-language pretraining. In: CVPR
- Cheng S, Guo Z, Wu J, Fang K, Li P, Liu H, Liu Y (2024) Ego-think: Evaluating first-person perspective thinking capability of vision-language models. In: CVPR
- Cherian A, Hori C, Marks TK, Le Roux J (2022) (2.5+ 1) d spatio-temporal scene graphs for video question answering. In: AAAI
- Chi Hg, Lee K, Agarwal N, Xu Y, Ramani K, Choi C (2023) Adamsformer for spatial action localization in the future. In: CVPR
- Cho M, Kim T, Kim WJ, Cho S, Lee S (2022) Unsupervised video anomaly detection via normalizing flows with implicit latent features. PR
- Choi J, Gao C, Messou JC, Huang JB (2019) Why can't i dance in the mall? learning to mitigate scene bias in action recognition. NeurIPS
- Choi W, Savarese S (2012) A unified framework for multi-target tracking and collective activity recognition. In: ECCV
- Chun S, Oh SJ, De Rezende RS, Kalantidis Y, Larlus D (2021) Probabilistic embeddings for cross-modal retrieval. In: CVPR
- Chung J, Zisserman A (2016) Signs in time: Encoding human motion as a temporal image. In: ECCVw
- Chung J, Wu Ch, Yang Hr, Tai YW, Tang CK (2021) Haa500: Human-centric atomic action dataset with curated videos. In: ICCV
- Cipolla R, Blake A (1990) The dynamic analysis of apparent contours. In: ICCV
- Clark A, Donahue J, Simonyan K (2019) Adversarial video generation on complex datasets. arXiv:190706571
- Cole E, Yang X, Wilber K, Mac Aodha O, Belongie S (2022) When does contrastive visual representation learning work? In: CVPR
- Coskun H, Zareian A, Moore JL, Tombari F, Wang C (2022) Goca: Guided online cluster assignment for self-supervised video representation learning. In: ECCV
- Cui Y, Zeng C, Zhao X, Yang Y, Wu G, Wang L (2023) Sportsmot: A large multi-object tracking dataset in multiple sports scenes. In: ICCV
- Cutler R, Davis LS (2000) Robust Real-Time Periodic Motion Detection, Analysis, and Applications. IEEE TPAMI
- Czolbe S, Krause O, Cox I, Igel C (2020) A loss function for generative neural networks based on watson's perceptual model. NeurIPS
- Da Costa VGT, Zara G, Rota P, Oliveira-Santos T, Sebe N, Murino V, Ricci E (2022) Unsupervised domain adaptation for video transformers in action recognition. In: ICPR
- Dai R, Das S, Minciullo L, Garattoni L, Francesca G, Bremond F (2021) Pdan: Pyramid dilated attention network for action detection. In: WACV
- Dai R, Das S, Sharma S, Minciullo L, Garattoni L, Bremond F, Francesca G (2022a) Toyota smarhome untrimmed: Real-world untrimmed videos for activity detection. IEEE TPAMI
- Dai Y, Tang D, Liu L, Tan M, Zhou C, Wang J, Feng Z, Zhang F, Hu X, Shi S (2022b) One model, multiple modalities: A sparsely activated approach for text, sound, image, video and code. arXiv:220506126,
- Damen D, Leelasawassuk T, Haines O, Calway A, Mayol-Cuevas WW (2014) You-do, i-learn: Discovering task relevant objects and their modes of interaction from multi-user egocentric video. In: BMVC
- Damen D, Doughty H, Farinella GM, Fidler S, Furnari A, Kazakos E, Moltisanti D, Munro J, Perrett T, Price W, et al (2018) Scaling egocentric vision: The epic-kitchens dataset. In: ECCV
- Damen D, Doughty H, Farinella GM, Furnari A, Kazakos E, Ma J, Moltisanti D, Munro J, Perrett T, Price W, et al (2022) Rescaling egocentric vision: Collection, pipeline and challenges for epic-kitchens-100. IJCV
- Dang LH, Le TM, Le V, Tran T (2021) Hierarchical object-oriented spatio-temporal reasoning for video question answering. In: IJCAI
- Dao T, Fu D, Ermon S, Rudra A, Ré C (2022) Flashattention: Fast and memory-efficient exact attention with io-awareness. NeurIPS
- Dave I, Gupta R, Rizve MN, Shah M (2022) Tclr: Temporal contrastive learning for video representation. CVIU

- Davtyan A, Sameni S, Favaro P (2023) Efficient video prediction via sparsely conditioned flow matching. In: ICCV
- De Geest R, Gavves E, Ghodrati A, Li Z, Snoek CGM, Tuytelaars T (2016) Online action detection. In: ECCV
- Deng C, Chen S, Chen D, He Y, Wu Q (2021) Sketch, ground, and refine: Top-down dense video captioning. In: CVPR
- Denton E, Fergus R (2018) Stochastic video generation with a learned prior. In: ICML
- Dessalene E, Devaraj C, Maynard M, Fermüller C, Aloimonos Y (2021) Forecasting action through contact representations from first person video. IEEE TPAMI
- Destro M, Gygli M (2024) CycleCL: Self-supervised Learning for Periodic Videos. In: WACV
- Dhariwal P, Nichol A (2021) Diffusion models beat gans on image synthesis. NeurIPS
- Dhiman A, Srinath R, Sarkar S, Boregowda LR, Babu RV (2023) Corf: Colorizing radiance fields using knowledge distillation. In: ICCVw
- Dhiman C, Vishwakarma DK (2019) A review of state-of-the-art techniques for abnormal human activity recognition. EAAI
- Diba A, Fayyaz M, Sharma V, Paluri M, Gall J, Stiefelwagen R, Van Gool L (2020) Large scale holistic video understanding. In: ECCV
- Diba A, Sharma V, Safdari R, Lotfi D, Sarfraz S, Stiefelwagen R, Van Gool L (2021) Vi2clr: Video and image for visual contrastive learning of representation. In: ICCV
- Dietterich TG, Lathrop RH, Lozano-Pérez T (1997) Solving the multiple instance problem with axis-parallel rectangles. Artificial intelligence
- Diko A, Avola D, Prenkaj B, Fontana F, Cinque L (2024) Semantically guided representation learning for action anticipation. In: ECCV
- Ding G, Sener F, Yao A (2023) Temporal action segmentation: An analysis of modern techniques. IEEE TPAMI
- Ding K, Ma K, Wang S, Simoncelli EP (2020) Image quality assessment: Unifying structure and texture similarity. IEEE TPAMI
- Ding S, Qian R, Xu H, Lin D, Xiong H (2024) Betrayed by attention: A simple yet effective approach for self-supervised video object segmentation. In: ECCV
- Dollár P, Rabaud V, Cottrell G, Belongie S (2005) Behavior recognition via sparse spatio-temporal features. In: VS-PETS
- Donahue G, Elhamifar E (2024) Learning to predict activity progress by self-supervised video alignment. In: CVPR
- Donahue J, Hendricks LA, Guadarrama S, Rohrbach M, Venugopalan S, Saenko K, Darrell T (2015) Long-term recurrent convolutional networks for visual recognition and description. In: CVPR
- Dong J, Li X, Snoek CGM (2018) Predicting visual features from text for image and video caption retrieval. IEEE TM
- Dorckenwald M, Milbich T, Blattmann A, Rombach R, Derpanis KG, Ommer B (2021) Stochastic image-to-video synthesis using cinns. In: CVPR
- Dosovitskiy A, Beyer L, Kolesnikov A, Weissenborn D, Zhai X, Unterthiner T, Dehghani M, Minderer M, Heigold G, Gelly S, et al (2020) An image is worth 16x16 words: Transformers for image recognition at scale. In: ICLR
- Doughty H, Snoek CGM (2022) How do you do it? fine-grained action understanding with pseudo-adverbs. In: CVPR
- Doughty H, Damen D, Mayol-Cuevas W (2018) Who's better? who's best? pairwise deep ranking for skill determination. In: CVPR
- Doughty H, Laptev I, Mayol-Cuevas W, Damen D (2020) Action modifiers: Learning from adverbs in instructional videos. In: CVPR
- Du C, Li Y, Qiu Z, Xu C (2023) Stable diffusion is unstable. Advances in Neural Information Processing Systems
- Du W, Wang Y, Qiao Y (2017) Recurrent spatial-temporal attention network for action recognition in videos. IEEE T-IP
- Dubey S, Boragule A, Jeon M (2019) 3d resnet with ranking loss function for abnormal activity detection in videos. In: IC-CAIS
- Dvornik M, Hadji I, Derpanis KG, Garg A, Jepson A (2021) Drop-dtw: Aligning common signal between sequences while dropping outliers. NeurIPS
- Dwibedi D, Sermanet P, Tompson J (2018) Temporal reasoning in videos using convolutional gated recurrent units. In: CVPRw
- Dwibedi D, Aytar Y, Tompson J, Sermanet P, Zisserman A (2020) Counting out time: Class agnostic video repetition counting in the wild. In: CVPR
- Dwibedi D, Aytar Y, Tompson J, Zisserman A (2024) Ovr: A dataset for open vocabulary temporal repetition counting in videos. arXiv:240717085
- Eagleman DM (2010) How does the timing of neural signals map onto the timing of perception. Space and time in perception and action
- Edwards M, Deng J, Xie X (2016) From pose to activity: Surveying datasets and introducing converse. CVIU
- Efros A, Berg A, Mori G, Malik J (2003) Recognizing action at a distance. In: ICCV
- Epstein D, Chen B, Vondrick C (2020) Oops! predicting unintentional action in video. In: CVPR
- Epstein D, Wu J, Schmid C, Sun C (2021) Learning temporal dynamics from cycles in narrated video. In: ICCV
- Escontrela A, Adeniji A, Yan W, Jain A, Peng XB, Goldberg K, Lee Y, Hafner D, Abbeel P (2023) Video prediction models as rewards for reinforcement learning. NeurIPS
- Escorcia V, Soldan M, Sivic J, Ghanem B, Russell B (2019) Temporal localization of moments in video collections with natural language. arXiv:190712763
- Esser P, Rombach R, Ommer B (2021) Taming transformers for high-resolution image synthesis. In: CVPR
- Eyzaguirre C, Tang E, Buch S, Gaidon A, Wu J, Niebles JC (2024) Streaming detection of queried event start. In: NeurIPS
- Fan C, Zhang X, Zhang S, Wang W, Zhang C, Huang H (2019) Heterogeneous memory enhanced multimodal attention model for video question answering. In: CVPR
- Fan H, Xiong B, Mangalam K, Li Y, Yan Z, Malik J, Feichtenhofer C (2021) Multiscale vision transformers. In: ICCV
- Fan K, Bai Z, Xiao T, Zietlow D, Horn M, Zhao Z, Simon-Gabriel CJ, Shou MZ, Locatello F, Schiele B, et al (2023) Unsupervised open-vocabulary object localization in videos. In: ICCV
- Fang H, Chen B, Wang X, Wang Z, Xia ST (2023) Gifd: A generative gradient inversion method with feature domain optimization. In: ICCV
- Fathi A, Rehg JM (2013) Modeling actions through state changes. In: CVPR
- Faure GJ, Chen MH, Lai SH (2023) Holistic interaction transformer network for action detection. In: WACV
- Fayek HM, Kumar A (2020) Large scale audiovisual learning of sounds with weakly labeled data. In: IJCAI
- Fei H, Wu S, Ji W, Zhang H, Chua TS (2024a) Dysen-vdm: Empowering dynamics-aware text-to-video diffusion with llms. In: CVPR
- Fei H, Wu S, Ji W, Zhang H, Zhang M, Lee ML, Hsu W (2024b) Video-of-thought: Step-by-step video reasoning from perception to cognition. In: ICML
- Feichtenhofer C (2020) X3d: Expanding architectures for efficient video recognition. In: CVPR
- Feichtenhofer C, Pinz A, Zisserman A (2016) Convolutional two-stream network fusion for video action recognition. In: CVPR
- Feichtenhofer C, Pinz A, Wildes RP (2017) Spatiotemporal multiplier networks for video action recognition. In: CVPR

- Feichtenhofer C, Fan H, Malik J, He K (2019) Slowfast networks for video recognition. In: ICCV
- Feichtenhofer C, Fan H, Xiong B, Girshick R, He K (2021) A large-scale study on unsupervised spatiotemporal representation learning. In: CVPR
- Feichtenhofer C, Li Y, He K, et al (2022) Masked autoencoders as spatiotemporal learners. *NeurIPS*
- Feng J, Erol MH, Chung JS, Senocak A (2024) From coarse to fine: Efficient training for audio spectrogram transformers. In: ICASSP
- Feng JC, Hong FT, Zheng WS (2021a) Mist: Multiple instance self-training framework for video anomaly detection. In: CVPR
- Feng R, Gao Y, Ma X, Tse THE, Chang HJ (2023) Mutual information-based temporal difference learning for human pose estimation in video. In: CVPR
- Feng Y, Jiang J, Huang Z, Qing Z, Wang X, Zhang S, Tang M, Gao Y (2021b) Relation modeling in spatio-temporal action localization. In: CVPRw
- Fernando B, Herath S (2021) Anticipating human actions by correlating past with the future with jaccard similarity measures. In: CVPR
- Fernando B, Gavves E, Oramas JM, Ghodrati A, Tuytelaars T (2015) Modeling video evolution for action recognition. In: CVPR
- Fernando B, Gavves E, Oramas J, Ghodrati A, Tuytelaars T (2016) Rank pooling for action recognition. *IEEE TPAMI*
- Fernando B, Bilen H, Gavves E, Gould S (2017) Self-supervised video representation learning with odd-one-out networks. In: CVPR
- Ferreira B, Ferreira PM, Pinheiro G, Figueiredo N, Carvalho F, Menezes P, Batista J (2021) Deep Learning Approaches for Workout Repetition Counting and Validation. *PRL*
- Finn C, Goodfellow I, Levine S (2016) Unsupervised learning for physical interaction through video prediction. *NeurIPS*
- Fioresi J, Dave IR, Shah M (2023) Ted-spad: Temporal distinctiveness for self-supervised privacy-preservation for video anomaly detection. In: ICCV
- Flaborea A, Collorone L, Di Melendugno GMD, D'Arrigo S, Prenkaj B, Galasso F (2023) Multimodal motion conditioned diffusion model for skeleton-based video anomaly detection. In: ICCV
- Flanagan K, Damen D, Wray M (2023) Learning temporal sentence grounding from narrated egovideos. In: *BMVC*
- Fogassi L, Ferrari PF, Gesierich B, Rozzi S, Chersi F, Rizzolatti G (2005) Parietal lobe: from action organization to intention understanding. *Science*
- Foo LG, Li T, Rahmani H, Ke Q, Liu J (2022) Era: Expert retrieval and assembly for early action prediction. In: ECCV
- Förstner W, Gülch E (1987) A fast operator for detection and precise location of distinct points, corners and centres of circular features. In: *ICFPPD*
- Fouhey DF, Kuo Wc, Efros AA, Malik J (2018) From lifestyle vlogs to everyday interactions. In: CVPR
- Fragkiadaki K, Huang J, Alemi A, Vijayanarasimhan S, Ricco S, Sukthankar R (2017) Motion prediction under multimodality with conditional stochastic networks. *arXiv:170502082*
- Franceschi JY, Delasalles E, Chen M, Lamprier S, Gallinari P (2020) Stochastic latent residual video prediction. In: *ICML*
- Fu C, Dai Y, Luo Y, Li L, Ren S, Zhang R, Wang Z, Zhou C, Shen Y, Zhang M, et al (2024) Video-mme: The first-ever comprehensive evaluation benchmark of multi-modal llms in video analysis. *arXiv:240521075*
- Fu Q, Liu X, Kitani KM (2022) Sequential decision-making for active object detection from hand. In: CVPR
- Fu TJ, Li L, Gan Z, Lin K, Wang WY, Wang L, Liu Z (2021) Violet: End-to-end video-language transformers with masked visual-token modeling. *arXiv:211112681*
- Fu TJ, Yu L, Zhang N, Fu CY, Su JC, Wang WY, Bell S (2023) Tell me what happened: Unifying text-guided video completion via multimodal masked video generation. In: CVPR
- Furnari A, Farinella GM (2019) What would you expect? anticipating egocentric actions with rolling-unrolling lstms and modality attention. In: ICCV
- Furnari A, Farinella GM (2022) Towards streaming egocentric action anticipation. In: *ICPR*
- Furnari A, Battiato S, Maria Farinella G (2018) Leveraging uncertainty to rethink loss functions and evaluation measures for egocentric action anticipation. In: *ECCVw*
- Gabeur V, Sun C, Alahari K, Schmid C (2020) Multi-modal transformer for video retrieval. In: *ECCV*
- Gaidon A, Harchaoui Z, Schmid C (2013) Temporal localization of actions with actoms. *IEEE TPAMI*
- Gallese V, Fadiga L, Fogassi L, Rizzolatti G (1996) Action recognition in the premotor cortex. *Brain*
- Gammulle H, Denman S, Sridharan S, Fookes C (2019) Predicting the future: A jointly learnt model for action anticipation. In: *ICCV*
- Gan Z, Gan C, He X, Pu Y, Tran K, Gao J, Carin L, Deng L (2017) Semantic compositional networks for visual captioning. In: *CVPR*
- Gao D, Zhou L, Ji L, Zhu L, Yang Y, Shou MZ (2023) Mist: Multi-modal iterative spatial-temporal transformer for long-form video question answering. In: *CVPR*
- Gao J, Sun C, Yang Z, Nevatia R (2017a) Tall: Temporal activity localization via language query. In: *ICCV*
- Gao J, Yang Z, Nevatia R (2017b) Red: Reinforced encoder-decoder networks for action anticipation. *arXiv:170704818*
- Gao J, Ge R, Chen K, Nevatia R (2018) Motion-appearance co-memory networks for video question answering. In: *CVPR*
- Gao R, Oh TH, Grauman K, Torresani L (2020) Listen to look: Action recognition by previewing audio. In: *CVPR*
- Gao Y, Liu J, Xu Z, Zhang J, Li K, Ji R, Shen C (2022a) Pyramidclip: Hierarchical feature alignment for vision-language model pretraining. *NeurIPS*
- Gao Z, Tan C, Wu L, Li SZ (2022b) Simvp: Simpler yet better video prediction. In: *CVPR*
- Garcia-Hernando G, Yuan S, Baek S, Kim TK (2018) First-person hand action benchmark with rgb-d videos and 3d hand pose annotations. In: *CVPR*
- Gat I, Schwartz I, Schwing A (2021) Perceptual score: What data modalities does your model perceive? *NeurIPS*
- Ge R, Gao J, Chen K, Nevatia R (2019) Mac: Mining activity concepts for language-based temporal localization. In: *WACV*
- Ge S, Hayes T, Yang H, Yin X, Pang G, Jacobs D, Huang JB, Parikh D (2022a) Long video generation with time-agnostic vqgan and time-sensitive transformer. In: *ECCV*
- Ge Y, Ge Y, Liu X, Li D, Shan Y, Qie X, Luo P (2022b) Bridging video-text retrieval with multiple choice questions. In: *CVPR*
- Gemmeke JF, Ellis DP, Freedman D, Jansen A, Lawrence W, Moore RC, Plakal M, Ritter M (2017) Audio set: An ontology and human-labeled dataset for audio events. In: *ICASSP*
- Genovese CR, Perone Pacifico M, Verdinelli I, Wasserman L, et al (2012) Minimax manifold estimation. *JMLR*
- Georgescu MI, Barbalau A, Ionescu RT, Khan FS, Popescu M, Shah M (2021) Anomaly detection in video via self-supervised and multi-task learning. In: *CVPR*
- Georgescu MI, Fonseca E, Ionescu RT, Lucic M, Schmid C, Arnab A (2023) Audiovisual masked autoencoders. In: *ICCV*
- Ghadiyaram D, Tran D, Mahajan D (2019) Large-scale weakly-supervised pre-training for video action recognition. In: *CVPR*

- Ghodrati A, Bejnordi BE, Habibian A (2021) Frameexit: Conditional early exiting for efficient video recognition. In: CVPR
- Girase H, Agarwal N, Choi C, Mangalam K (2023) Latency matters: Real-time action forecasting transformer. In: CVPR
- Girdhar R, Grauman K (2021) Anticipative video transformer. In: ICCV
- Girdhar R, Ramanan D (2017) Attentional pooling for action recognition. NeurIPS
- Girdhar R, Carreira J, Doersch C, Zisserman A (2019) Video action transformer network. In: CVPR
- Girdhar R, Singh M, Ravi N, Van Der Maaten L, Joulin A, Misra I (2022) Omnivore: A single model for many visual modalities. In: CVPR
- Girdhar R, El-Nouby A, Liu Z, Singh M, Alwala KV, Joulin A, Misra I (2023a) Imagebind: One embedding space to bind them all. In: CVPR
- Girdhar R, El-Nouby A, Singh M, Alwala KV, Joulin A, Misra I (2023b) Omnimae: Single model masked pretraining on images and videos. In: CVPR
- Girshick R (2015) Fast r-cnn. In: ICCV
- Girshick R, Donahue J, Darrell T, Malik J (2014) Rich feature hierarchies for accurate object detection and semantic segmentation. In: CVPR
- Gong D, Lee J, Kim M, Ha SJ, Cho M (2022a) Future transformer for long-term action anticipation. In: CVPR
- Gong Y, Chung YA, Glass J (2021) Psla: Improving audio tagging with pretraining, sampling, labeling, and aggregation. IEEE/ACM TASLP
- Gong Y, Liu AH, Rouditchenko A, Glass J (2022b) Uavm: Towards unifying audio and visual models. IEEE SPL
- Gong Y, Rouditchenko A, Liu AH, Harwath D, Karlinsky L, Kuehne H, Glass J (2023) Contrastive audio-visual masked autoencoder. In: ICLR
- Goodfellow I, Pouget-Abadie J, Mirza M, Xu B, Warde-Farley D, Ozair S, Courville A, Bengio Y (2014) Generative adversarial nets. NeurIPS
- Gordo A, Larlus D (2017) Beyond instance-level image retrieval: Leveraging captions to learn a global visual representation for semantic retrieval. In: CVPR
- Gordon D, Ehsani K, Fox D, Farhadi A (2020) Watching the world go by: Representation learning from unlabeled videos. arXiv:200307990
- Gorelick L, Galun M, Sharon E, Basri R, Brandt A (2006) Shape representation and classification using the poisson equation. IEEE TPAMI
- Gorelick L, Blank M, Shechtman E, Irani M, Basri R (2007) Actions as space-time shapes. IEEE TPAMI
- Goroshin R, Bruna J, Tompson J, Eigen D, LeCun Y (2015) Unsupervised learning of spatiotemporally coherent metrics. In: ICCV
- Gouidis F, Patkos T, Argyros A, Plexousakis D (2023) Leveraging knowledge graphs for zero-shot object-agnostic state classification. arXiv:230712179
- Gowda SN, Rohrbach M, Sevilla-Lara L (2021) Smart frame selection for action recognition. In: AAAI
- Goyal R, Ebrahimi Kahou S, Michalski V, Materzynska J, Westphal S, Kim H, Haenel V, Fruend I, Yianilos P, Mueller-Freitag M, et al (2017a) The "something something" video database for learning and evaluating visual common sense. In: ICCV
- Goyal Y, Khot T, Summers-Stay D, Batra D, Parikh D (2017b) Making the v in vqa matter: Elevating the role of image understanding in visual question answering. In: CVPR
- Grauman K, Westbury A, Byrne E, Chavis Z, Furnari A, Girdhar R, Hamburger J, Jiang H, Liu M, Liu X, et al (2022) Ego4d: Around the world in 3,000 hours of egocentric video. In: CVPR
- Grauman K, Westbury A, Torresani L, Kitani K, Malik J, Afouras T, Ashutosh K, Baiyya V, Bansal S, Boote B, et al (2024) Ego4d: Understanding skilled human activity from first- and third-person perspectives. In: CVPR
- Grill JB, Strub F, Altché F, Tallec C, Richemond P, Buchatskaya E, Doersch C, Avila Pires B, Guo Z, Gheshlaghi Azar M, et al (2020) Bootstrap your own latent-a new approach to self-supervised learning. NeurIPS
- Gritsenko AA, Xiong X, Djonlagic J, Dehghani M, Sun C, Lucic M, Schmid C, Arnab A (2024) End-to-end spatio-temporal action localisation with video transformers. In: CVPR
- Gu A, Dao T (2023) Mamba: Linear-time sequence modeling with selective state spaces. arXiv preprint arXiv:2312.00752
- Gu C, Sun C, Ross DA, Vondrick C, Pantofaru C, Li Y, Vijayanarasimhan S, Toderici G, Ricco S, Sukthankar R, et al (2018) Ava: A video dataset of spatio-temporally localized atomic visual actions. In: CVPR
- Gu X, Fan H, Huang Y, Luo T, Zhang L (2024a) Context-guided spatio-temporal video grounding. In: CVPR
- Gu X, Wen C, Ye W, Song J, Gao Y (2024b) Seer: Language instructed video prediction with latent diffusion models. In: ICLR
- Guadarrama S, Krishnamoorthy N, Malkarnenkar G, Venugopalan S, Mooney R, Darrell T, Saenko K (2013) Youtube2text: Recognizing and describing arbitrary activities using semantic hierarchies and zero-shot recognition. In: ICCV
- Guen VL, Thome N (2020) Disentangling physical dynamics from unknown factors for unsupervised video prediction. In: CVPR
- Gulati A, Qin J, Chiu CC, Parmar N, Zhang Y, Yu J, Han W, Wang S, Zhang Z, Wu Y, et al (2020) Conformer: Convolution-augmented transformer for speech recognition. Interspeech
- Guo H, Agarwal N, Lo SY, Lee K, Ji Q (2024a) Uncertainty-aware action decoupling transformer for action anticipation. In: CVPR
- Guo Y, Sun S, Ma S, Zheng K, Bao X, Ma S, Zou W, Zheng Y (2024b) Crossmae: Cross-modality masked autoencoders for region-aware audio-visual pre-training. In: CVPR
- Guo Z, Zhao J, Jiao L, Liu X, Li L (2021) Multi-scale progressive attention network for video question answering. In: ACL
- Gupta A, Kembhavi A, Davis LS (2009) Observing human-object interactions: Using spatial and functional compatibility for recognition. IEEE TPAMI
- Gupta A, Yu L, Sohn K, Gu X, Hahn M, Fei-Fei L, Essa I, Jiang L, Lezama J (2023) Photorealistic video generation with diffusion models. arXiv:2312.06662
- Gupta S, Keshari A, Das S (2022) Rv-gan: Recurrent gan for unconditional video generation. In: CVPR
- Hadji I, Derpanis KG, Jepson AD (2021) Representation learning via global temporal alignment and cycle-consistency. In: CVPR
- Hakeem A, Shah M (2004) Ontology and taxonomy collaborated framework for meeting classification. In: ICPR
- Hampali S, Rad M, Oberweger M, Lepetit V (2020) Honnotate: A method for 3d annotation of hand and object poses. In: CVPR
- Han L, Ren J, Lee HY, Barbieri F, Olszewski K, Minaee S, Metaxas D, Tulyakov S (2022) Show me what and tell me how: Video synthesis via multimodal conditioning. In: CVPR
- Han T, Xie W, Zisserman A (2020a) Memory-augmented dense predictive coding for video representation learning. In: ECCV
- Han T, Xie W, Zisserman A (2020b) Self-supervised co-training for video representation learning. NeurIPS



- Han T, Bain M, Nagrani A, Varol G, Xie W, Zisserman A (2023a) Autoad ii: The sequel-who, when, and what in movie audio description. In: ICCV
- Han T, Bain M, Nagrani A, Varol G, Xie W, Zisserman A (2023b) Autoad: Movie description in context. In: CVPR
- Han T, Bain M, Nagrani A, Varol G, Xie W, Zisserman A (2024) Autoad iii: The prequel-back to the pixels. In: CVPR
- Hao J, Sun H, Ren P, Wang J, Qi Q, Liao J (2022) Query-aware video encoder for video moment retrieval. Neurocomputing
- Hao X, Zhang W (2024) Uncertainty-aware alignment network for cross-domain video-text retrieval. NeurIPS
- Hara K, Kataoka H, Satoh Y (2018) Can spatiotemporal 3d cnns retrace the history of 2d cnns and imagenet? In: CVPR
- Hareesh S, Kumar S, Coskun H, Syed SN, Konin A, Zia Z, Tran QH (2021) Learning by aligning videos in time. In: CVPR
- Harris C, Stephens M, et al (1988) A combined corner and edge detector. In: AVC
- Harvey W, Naderiparizi S, Masrani V, Weilbach C, Wood F (2022) Flexible diffusion modeling of long videos. NeurIPS
- Hasan M, Choi J, Neumann J, Roy-Chowdhury AK, Davis LS (2016) Learning temporal regularity in video sequences. In: CVPR
- Hatamizadeh A, Yin H, Roth HR, Li W, Kautz J, Xu D, Molchanov P (2022) Gradvit: Gradient inversion of vision transformers. In: CVPR
- He B, Yang X, Kang L, Cheng Z, Zhou X, Shrivastava A (2022a) Asm-loc: Action-aware segment modeling for weakly-supervised temporal action localization. In: CVPR
- He K, Fan H, Wu Y, Xie S, Girshick R (2020) Momentum contrast for unsupervised visual representation learning. In: CVPR
- He K, Chen X, Xie S, Li Y, Dollár P, Girshick R (2022b) Masked autoencoders are scalable vision learners. In: CVPR
- He Y, Yang T, Zhang Y, Shan Y, Chen Q (2022c) Latent video diffusion models for high-fidelity video generation with arbitrary lengths. arXiv:221113221
- He Y, Murata N, Lai CH, Takida Y, Uesaka T, Kim D, Liao WH, Mitsufuji Y, Kolter JZ, Salakhutdinov R, et al (2023) Manifold preserving guided diffusion. NeurIPS
- Hegde K, Agrawal R, Yao Y, Fletcher CW (2018) Morph: Flexible acceleration for 3d cnn-based video understanding. In: MICRO
- Heidarvinchek F, Mirmehdi M, Damen D (2016) Beyond action recognition: Action completion in rgb-d data. In: BMVC
- Heidarvinchek F, Mirmehdi M, Damen D (2018) Action completion: A temporal model for moment detection. In: BMVC
- Hendricks LA, Wang O, Shechtman E, Sivic J, Darrell T, Russell B (2017) Localizing moments in video with natural language. In: ICCV
- Herath S, Harandi M, Porikli F (2017) Going deeper into action recognition: A survey. IVC
- Hjelm RD, Bachman P (2020) Representation learning with video deep infomax. arXiv:200713278
- Hjelm RD, Fedorov A, Lavoie-Marchildon S, Grewal K, Bachman P, Trischler A, Bengio Y (2018) Learning deep representations by mutual information estimation and maximization. In: ICLR
- Ho J, Jain A, Abbeel P (2020) Denoising diffusion probabilistic models. NeurIPS
- Ho J, Chan W, Saharia C, Whang J, Gao R, Gritsenko A, Kingma DP, Poole B, Norouzi M, Fleet DJ, et al (2022a) Imagen video: High definition video generation with diffusion models. arXiv:221002303
- Ho J, Salimans T, Gritsenko A, Chan W, Norouzi M, Fleet DJ (2022b) Video diffusion models. In: NeurIPS
- Hoai M, De la Torre F (2014) Max-margin early event detectors. IJCV
- Hoai M, Zisserman A (2015) Improving human action recognition using score distribution and ranking. In: ACCV
- Hoffmann J, Borgeaud S, Mensch A, Buchatskaya E, Cai T, Rutherford E, de Las Casas D, Hendricks LA, Welbl J, Clark A, et al (2022) An empirical analysis of compute-optimal large language model training. NeurIPS
- Hong J, Zhang H, Gharbi M, Fisher M, Fatahalian K (2022a) Spotting temporally precise, fine-grained events in video. In: ECCV
- Hong W, Ding M, Zheng W, Liu X, Tang J (2022b) Cogvideo: Large-scale pretraining for text-to-video generation via transformers. arXiv:220515868
- Hong X, Lan Y, Pang L, Guo J, Cheng X (2021) Transformation driven visual reasoning. In: CVPR
- Höppe T, Mehrjou A, Bauer S, Nielsen D, Dittadi A (2024) Diffusion models for video prediction and infilling. IEEE TMLR
- Hou J, Wu X, Wang R, Luo J, Jia Y (2020) Confidence-guided self refinement for action prediction in untrimmed videos. IEEE T-IP
- Hou Q, Ghildyal A, Liu F (2022) A perceptual quality metric for video frame interpolation. In: ECCV
- Hou R, Chen C, Shah M (2017) Tube convolutional neural network (t-cnn) for action detection in videos. In: ICCV
- Hu D, Nie F, Li X (2019) Deep multimodal clustering for unsupervised audiovisual learning. In: CVPR
- Hu EJ, Shen Y, Wallis P, Allen-Zhu Z, Li Y, Wang S, Wang L, Chen W (2021) Lora: Low-rank adaptation of large language models. arXiv:210609685
- Hu H, Dong S, Zhao Y, Lian D, Li Z, Gao S (2022a) Transrac: Encoding multi-scale temporal correlation with transformers for repetitive action counting. In: CVPR
- Hu JF, Zheng WS, Ma L, Wang G, Lai J, Zhang J (2018) Early action prediction by soft regression. IEEE TPAMI
- Hu X, Chen Z, Owens A (2022b) Mix and localize: Localizing sound sources in mixtures. In: CVPR
- Hu X, Dai J, Li M, Peng C, Li Y, Du S (2022c) Online human action detection and anticipation in videos: A survey. Neurocomputing
- Hu X, Huang Z, Huang A, Xu J, Zhou S (2023) A dynamic multi-scale voxel flow network for video prediction. In: CVPR
- Hu Y, Luo C, Chen Z (2022d) Make it move: controllable image-to-video generation with text descriptions. In: CVPR
- Huang B, Zhao Z, Zhang G, Qiao Y, Wang L (2023a) Mgmoe: Motion guided masking for video masked autoencoding. In: ICCV
- Huang D, Chen P, Zeng R, Du Q, Tan M, Gan C (2020a) Location-aware graph convolutional networks for video question answering. In: AAAI
- Huang DA, Kitani KM (2014) Action-reaction: Forecasting the dynamics of human interaction. In: ECCV
- Huang DA, Ramanathan V, Mahajan D, Torresani L, Paluri M, Fei-Fei L, Niebles JC (2018) What makes a video a video: Analyzing temporal information in video understanding models and datasets. In: CVPR
- Huang PY, Xu H, Li J, Baevski A, Auli M, Galuba W, Metzger F, Feichtenhofer C (2022) Masked autoencoders that listen. NeurIPS
- Huang PY, Sharma V, Xu H, Ryali C, Li Y, Li SW, Ghosh G, Malik J, Feichtenhofer C, et al (2023b) Mavil: Masked audio-video learners. In: NeurIPS
- Huang S, Suri S, Gupta K, Rambhatla SS, Lim Sn, Shrivastava A (2024a) Uvis: Unsupervised video instance segmentation. In: CVPR
- Huang Y, Dai Q, Lu Y (2019) Decoupling localization and classification in single shot temporal action detection. In: ICME

- Huang Y, Zhang Y, Elachqar O, Cheng Y (2020b) Inset: Sentence infilling with inter-sentential transformer. In: ACL
- Huang Z, He Y, Yu J, Zhang F, Si C, Jiang Y, Zhang Y, Wu T, Jin Q, Chanpaisit N, et al (2024b) Vbench: Comprehensive benchmark suite for video generative models. In: CVPR
- Huh J, Chalk J, Kazakos E, Damen D, Zisserman A (2023) Epic-sounds: A large-scale dataset of actions that sound. In: ICASSP
- Hussain Z, Sheng M, Zhang WE (2019) Different approaches for human activity recognition: A survey. arXiv:190605074
- Hussein N, Gavves E, Smeulders AW (2019) Timeception for complex action recognition. In: CVPR
- Hwang JJ, Ke TW, Shi J, Yu SX (2019) Adversarial structure matching for structured prediction tasks. In: CVPR
- Iashin V, Rahtu E (2020a) A better use of audio-visual cues: Dense video captioning with bi-modal transformer. In: BMVC
- Iashin V, Rahtu E (2020b) Multi-modal dense video captioning. In: CVPRw
- Ibrahim MS, Muralidharan S, Deng Z, Vahdat A, Mori G (2016) A hierarchical deep temporal model for group activity recognition. In: CVPR
- Ikizler-Cinbis N, Sclaroff S (2010) Object, scene and actions: Combining multiple features for human action recognition. In: ECCV
- Iofinova E, Peste A, Alistarh D (2023) Bias in pruned vision models: In-depth analysis and countermeasures. In: CVPR
- Ionescu C, Papava D, Olaru V, Sminchisescu C (2013) Human3.6m: Large scale datasets and predictive methods for 3d human sensing in natural environments. IEEE TPAMI
- Iosifidis A, Tefas A, Pitas I (2012) View-invariant action recognition based on artificial neural networks. IEEE TNNLS
- Ippolito D, Grangier D, Callison-Burch C, Eck D (2019) Unsupervised hierarchical story infilling. In: WNU
- Isard M, Blake A (1998) Condensation—conditional density propagation for visual tracking. IJCV
- Islam MM, Ho N, Yang X, Nagarajan T, Torresani L, Bertasius G (2024) Video recap: Recursive captioning of hour-long videos. In: CVPR
- Jabri A, Owens A, Efros A (2020) Space-time correspondence as a contrastive random walk. NeurIPS
- Jacobs RA, Jordan MI, Nowlan SJ, Hinton GE (1991) Adaptive mixtures of local experts. Neural computation
- Jaegle A, Gimeno F, Brock A, Vinyals O, Zisserman A, Carreira J (2021) Perceiver: General perception with iterative attention. In: ICML
- Jain A, Tompson J, LeCun Y, Bregler C (2015a) Modeep: A deep learning framework using motion features for human pose estimation. In: ACCV
- Jain M, Van Gemert J, Jégou H, Bouthemy P, Snoek CGM (2014) Action localization with tubelets from motion. In: CVPR
- Jain M, van Gemert JC, Snoek CGM (2015b) What do 15,000 object categories tell us about classifying and localizing actions. In: CVPR
- Jang J, Kong C, Jeon D, Kim S, Kwak N (2023) Unifying vision-language representation space with single-tower transformer. In: AAAI
- Jang Y, Song Y, Yu Y, Kim Y, Kim G (2017) Tgif-qa: Toward spatio-temporal reasoning in visual question answering. In: CVPR
- Janocha K, Czarnecki WM (2017) On loss functions for deep neural networks in classification. TFML
- Jeannerod M (1994) The representing brain: Neural correlates of motor intention and imagery. BBS
- Jenni S, Jin H (2021) Time-equivariant contrastive video representation learning. In: ICCV
- Jhuang H, Gall J, Zuffi S, Schmid C, Black MJ (2013) Towards understanding action recognition. In: ICCV
- Ji J, Krishna R, Fei-Fei L, Niebles JC (2020) Action genome: Actions as compositions of spatio-temporal scene graphs. In: CVPR
- Ji S, Xu W, Yang M, Yu K (2012) 3d convolutional neural networks for human action recognition. IEEE TPAMI
- Jia K, Yeung DY (2008) Human action recognition using local spatio-temporal discriminant embedding. In: CVPR
- Jiang B, Huang X, Yang C, Yuan J (2019a) Cross-modal video moment retrieval with spatial and language-temporal attention. In: ICMR
- Jiang B, Wang M, Gan W, Wu W, Yan J (2019b) Stm: Spatiotemporal and motion encoding for action recognition. In: ICCV
- Jiang H, Kim B, Guan M, Gupta M (2018) To trust or not to trust a classifier. NeurIPS
- Jiang J, Nan Z, Chen H, Chen S, Zheng N (2021) Predicting short-term next-active-object through visual attention and hand position. Neurocomputing
- Jiang P, Han Y (2020) Reasoning with heterogeneous graph alignment for video question answering. In: AAAI
- Jiang YG, Ye G, Chang SF, Ellis D, Loui AC (2011) Consumer video understanding: A benchmark database and an evaluation of human and machine performance. In: ICMR
- Jin B, Hu Y, Tang Q, Niu J, Shi Z, Han Y, Li X (2020) Exploring spatial-temporal multi-frequency analysis for high-fidelity and temporal-consistency video prediction. In: CVPR
- Jin S, Choi H, Noh T, Han K (2024) Integration of global and local representations for fine-grained cross-modal alignment. In: ECCV
- Jin X, Li X, Xiao H, Shen X, Lin Z, Yang J, Chen Y, Dong J, Liu L, Jie Z, et al (2017) Video scene parsing with predictive feature learning. In: ICCV
- Joo H, Liu H, Tan L, Gui L, Nabbe B, Matthews I, Kanade T, Nobuhara S, Sheikh Y (2015) Panoptic studio: A massively multiview system for social motion capture. In: ICCV
- Joo H, Simon T, Li X, Liu H, Tan L, Gui L, Banerjee S, Godisart TS, Nabbe B, Matthews I, Kanade T, Nobuhara S, Sheikh Y (2017) Panoptic studio: A massively multiview system for social interaction capture. IEEE TPAMI
- Ju C, Han T, Zheng K, Zhang Y, Xie W (2022) Prompting visual-language models for efficient video understanding. In: ECCV
- Ju C, Zheng K, Liu J, Zhao P, Zhang Y, Chang J, Tian Q, Wang Y (2023) Distilling vision-language pre-training to collaborate with weakly-supervised temporal action localization. In: CVPR
- Junejo IN, Dexter E, Laptev I, Perez P (2010) View-independent action recognition from temporal self-similarities. IEEE TPAMI
- Kahana J, Cohen N, Hoshen Y (2022) Improving zero-shot models with label distribution priors. arXiv:221200784
- Kahatapitiya K, Arnab A, Nagrani A, Ryoo MS (2024) Victr: Video-conditioned text representations for activity recognition. In: CVPR
- Kaiser L, Gomez AN, Shazeer N, Vaswani A, Parmar N, Jones L, Uszkoreit J (2017) One model to learn them all. arXiv:170605137
- Kalogeiton V, Weinzaepfel P, Ferrari V, Schmid C (2017) Action tubelet detector for spatio-temporal action localization. In: ICCV
- Kapidis G, Poppe R, Veltkamp RC (2021) Multi-dataset, multitask learning of egocentric vision tasks. IEEE TPAMI
- Kariyappa S, Guo C, Maeng K, Xiong W, Suh GE, Qureshi MK, Lee HHS (2023) Cocktail party attack: Breaking aggregation-based privacy in federated learning using independent component analysis. In: ICML
- Karpathy A, Toderici G, Shetty S, Leung T, Sukthankar R, Fei-Fei L (2014) Large-scale video classification with convolutional

- neural networks. In: CVPR
- Kataoka H, Miyashita Y, Hayashi M, Iwata K, Satoh Y (2016) Recognition of transitional action for short-term action prediction using discriminative temporal cnn feature. In: BMVC
- Kaufmann T, Weng P, Bengs V, Hüllermeier E (2023) A survey of reinforcement learning from human feedback. arXiv:231214925
- Kay W, Carreira J, Simonyan K, Zhang B, Hillier C, Vijayanarasimhan S, Viola F, Green T, Back T, Natsev P, et al (2017) The kinetics human action video dataset. arXiv:170506950
- Kazakos E, Nagraani A, Zisserman A, Damen D (2021) Slow-fast auditory streams for audio recognition. In: ICASSP
- Ke Q, Fritz M, Schiele B (2019) Time-conditioned action anticipation in one shot. In: CVPR
- Ke Y, Sukthankar R, Hebert M (2007) Spatio-temporal shape and flow correlation for action recognition. In: CVPR
- Khattak MU, Rasheed H, Maaz M, Khan S, Khan FS (2023) Maple: Multi-modal prompt learning. In: CVPR
- Kilner JM (2011) More than one pathway to action understanding. *Trends in cognitive sciences*
- Kim B, Lee J, Kang J, Kim ES, Kim HJ (2021a) Hotr: End-to-end human-object interaction detection with transformers. In: CVPR
- Kim D, Kim T (2024) Missing modality prediction for unpaired multimodal learning via joint embedding of unimodal models. In: ECCV
- Kim D, Cho D, Kweon IS (2019) Self-supervised video representation learning with space-time cubic puzzles. In: AAAI
- Kim H, Jain M, Lee JT, Yun S, Porikli F (2021b) Efficient action recognition via dynamic knowledge propagation. In: ICCV
- Kim J, Grauman K (2009) Observe locally, infer globally: a space-time mrf for detecting abnormal activities with incremental updates. In: CVPR
- Kim J, Kang J, Choi J, Han B (2024a) Fifo-diffusion: Generating infinite videos from text without training. In: NeurIPS
- Kim JM, Koepke A, Schmid C, Akata Z (2023) Exposing and mitigating spurious correlations for cross-modal retrieval. In: CVPR
- Kim M, Kwon H, Wang C, Kwak S, Cho M (2021c) Relational self-attention: What's missing in attention for video understanding. *NeurIPS*
- Kim M, Gao S, Hsu YC, Shen Y, Jin H (2024b) Token fusion: Bridging the gap between token pruning and token merging. In: WACV
- Kim M, Kim HB, Moon J, Choi J, Kim ST (2024c) Do you remember? dense video captioning with cross-modal memory retrieval. In: CVPR
- Kingma DP, Welling M (2013) Auto-encoding variational bayes. arxiv e-prints. In: ICLR
- Kitani KM, Ziebart BD, Bagnell JA, Hebert M (2012) Activity forecasting. In: ECCV
- Ko D, Lee JS, Choi M, Chu J, Park J, Kim HJ (2023) Open-vocabulary video question answering: A new benchmark for evaluating the generalizability of video question answering models. In: ICCV
- Kohler E, Keysers C, Umiltà MA, Fogassi L, Gallese V, Rizzolatti G (2002) Hearing sounds, understanding actions: action representation in mirror neurons. *Science*
- Kondratyuk D, Yuan L, Li Y, Zhang L, Tan M, Brown M, Gong B (2021) Movinets: Mobile video networks for efficient video recognition. In: CVPR
- Konečný J, McMahan HB, Ramage D, Richtárik P (2016) Federated optimization: Distributed machine learning for on-device intelligence. arXiv:161002527
- Kong Q, Cao Y, Iqbal T, Wang Y, Wang W, Plumbley MD (2020) Panns: Large-scale pretrained audio neural networks for audio pattern recognition. *IEEE/ACM TASLP*
- Kong Y, Fu Y (2022) Human action recognition and prediction: A survey. *IJCV*
- Kong Y, Kit D, Fu Y (2014) A discriminative model with multiple temporal scales for action prediction. In: ECCV
- Kong Y, Gao S, Sun B, Fu Y (2018) Action prediction from videos via memorizing hard-to-predict samples. In: AAAI
- Koppula HS, Saxena A (2015) Anticipating human activities using object affordances for reactive robotic response. *IEEE TPAMI*
- Koppula HS, Gupta R, Saxena A (2013) Learning human activities and object affordances from rgb-d videos. *IJRR*
- Korbar B, Tran D, Torresani L (2019) Scsampler: Sampling salient clips from video for efficient action recognition. In: ICCV
- Körner M, Denzler J (2013) Temporal self-similarity for appearance-based action recognition in multi-view setups. In: CAIP
- Koutini K, Schlüter J, Eghbal-Zadeh H, Widmer G (2022) Efficient training of audio transformers with patchout. In: *Interspeech*
- Kowal M, Dave A, Ambrus R, Gaidon A, Derpanis KG, Tokmakov P (2024a) Understanding video transformers via universal concept discovery. In: CVPR
- Kowal M, Wildes RP, Derpanis KG (2024b) Visual concept connectome (vcc): Open world concept discovery and their interlayer connections in deep models. In: CVPR
- Krishna R, Hata K, Ren F, Fei-Fei L, Carlos Niebles J (2017) Dense-captioning events in videos. In: ICCV
- Kuang H, Zhu Y, Zhang Z, Li X, Tighe J, Schwertfeger S, Stachniss C, Li M (2021) Video contrastive learning with global context. In: ICCVw
- Kuehne H, Jhuang H, Garrote E, Poggio T, Serre T (2011) Hmdb: a large video database for human motion recognition. In: ICCV
- Kuehne H, Arslan A, Serre T (2014) The language of actions: Recovering the syntax and semantics of goal-directed human activities. In: CVPR
- Kumar A, Rawat YS (2022) End-to-end semi-supervised learning for video action detection. In: CVPR
- Kumar M, Babaeizadeh M, Erhan D, Finn C, Levine S, Dinh L, Kingma D (2020) Videoflow: A conditional flow-based model for stochastic video generation. In: ICLR
- Kun L, He Z, Lu C, Hu K, Gao Y, Xu H (2024) Uni-o4: Unifying online and offline deep reinforcement learning with multi-step on-policy optimization. In: *The Twelfth International Conference on Learning Representations*
- Kviatkovsky I, Rivlin E, Shimshoni I (2014) Online action recognition using covariance of shape and motion. *CVIU*
- Kwon T, Tekin B, Stühmer J, Bogo F, Pollefeys M (2021) H2o: Two hands manipulating objects for first person interaction recognition. In: ICCV
- Lai B, Toyer S, Nagarajan T, Girdhar R, Zha S, Rehg JM, Kitani K, Grauman K, Desai R, Liu M (2024) Human action anticipation: A survey. *axiv*
- Laptev I, Lindeberg T (2003) Space-time interest points. In: ICCV
- Laptev I, Pérez P (2007) Retrieving actions in movies. In: ICCV
- Laptev I, Marszalek M, Schmid C, Rozenfeld B (2008) Learning realistic human actions from movies. In: CVPR
- Larochelle H, Bengio Y, Louradour J, Lamblin P (2009) Exploring strategies for training deep neural networks. *JMLR*
- Le QV, Zou WY, Yeung SY, Ng AY (2011) Learning hierarchical invariant spatio-temporal features for action recognition with independent subspace analysis. In: CVPR
- Lee AX, Zhang R, Ebert F, Abbeel P, Finn C, Levine S (2018) Stochastic adversarial video prediction. rXiv:180401523
- Lee H, Battle A, Raina R, Ng A (2006) Efficient sparse coding algorithms. *NeurIPS*

- Lee HY, Huang JB, Singh M, Yang MH (2017) Unsupervised representation learning by sorting sequences. In: ICCV
- Lee J, Lee Y, Kim J, Kosiorok A, Choi S, Teh YW (2019) Set transformer: A framework for attention-based permutation-invariant neural networks. In: ICML
- Lee T, Kwon S, Kim T (2024) Grid diffusion models for text-to-video generation. In: CVPR
- Lei J, Yu L, Bansal M, Berg TL (2018) Tvqa: Localized, compositional video question answering. arXiv:180901696
- Lei J, Berg TL, Bansal M (2021a) Detecting moments and highlights in videos via natural language queries. NeurIPS
- Lei J, Li L, Zhou L, Gan Z, Berg TL, Bansal M, Liu J (2021b) Less is more: Clipbert for video-and-language learning via sparse sampling. In: CVPR
- Li D, Qiu Z, Dai Q, Yao T, Mei T (2018a) Recurrent tubelet proposal and recognition networks for action detection. In: ECCV
- Li D, Jiang T, Jiang M (2019a) Quality assessment of in-the-wild videos. In: MM
- Li D, Li J, Li H, Niebles JC, Hoi SC (2022a) Align and prompt: Video-and-language pre-training with entity prompts. In: CVPR
- Li F, Zhang R, Zhang H, Zhang Y, Li B, Li W, Ma Z, Li C (2024a) Llava-next-interleave: Tackling multi-image, video, and 3d in large multimodal models. arXiv:240707895
- Li G, Cai G, Zeng X, Zhao R (2022b) Scale-aware spatio-temporal relation learning for video anomaly detection. In: ECCV
- Li H, Zhu G, Zhang L, Jiang Y, Dang Y, Hou H, Shen P, Zhao X, Shah SAA, Bennamoun M (2024b) Scene graph generation: A comprehensive survey. Neurocomputing
- Li J, Wong Y, Zhao Q, Kankanhalli MS (2019b) Video storytelling: Textual summaries for events. IEEE T-M
- Li J, Li D, Savarese S, Hoi S (2023a) Blip-2: Bootstrapping language-image pre-training with frozen image encoders and large language models. In: ICML
- Li J, Wei P, Han W, Fan L (2023b) Intentqa: Context-aware video intent reasoning. In: CVPR
- Li J, Gao K, Bai Y, Zhang J, Xia St, Wang Y (2024c) Fmm-attack: A flow-based multi-modal adversarial attack on video-based llms. arXiv:240313507
- Li K, Fu Y (2014) Prediction of human activity by discovering temporal sequence patterns. IEEE TPAMI
- Li K, Hu J, Fu Y (2012) Modeling complex temporal composition of actionlets for activity prediction. In: ECCV
- Li K, Wang Y, Peng G, Song G, Liu Y, Li H, Qiao Y (2022c) Uniformer: Unified transformer for efficient spatial-temporal representation learning. In: ICLR
- Li K, Wang Y, Li Y, Wang Y, He Y, Wang L, Qiao Y (2023c) Unmasked teacher: Towards training-efficient video foundation models. In: ICCV
- Li K, Wang Y, He Y, Li Y, Wang Y, Liu Y, Wang Z, Xu J, Chen G, Luo P, et al (2024d) Mvbench: A comprehensive multi-modal video understanding benchmark. In: CVPR
- Li L, Chen YC, Cheng Y, Gan Z, Yu L, Liu J (2020a) Hero: Hierarchical encoder for video+ language omni-representation pre-training. In: EMNLP
- Li P, Xie CW, Zhao L, Xie H, Ge J, Zheng Y, Zhao D, Zhang Y (2023d) Progressive spatio-temporal prototype matching for text-video retrieval. In: ICCV
- Li R, Zhang Y, Qiu Z, Yao T, Liu D, Mei T (2021a) Motion-focused contrastive learning of video representations. In: ICCV
- Li T, Wang Z, Liu S, Lin WY (2021b) Deep unsupervised anomaly detection. In: WACV
- Li T, Slavcheva M, Zollhoefer M, Green S, Lassner C, Kim C, Schmidt T, Lovegrove S, Goesele M, Newcombe R, et al (2022d) Neural 3d video synthesis from multi-view video. In: CVPR
- Li T, Fan L, Yuan Y, He H, Tian Y, Feris R, Indyk P, Katabi D (2023e) Addressing feature suppression in unsupervised visual representations. In: WACV
- Li T, Ma M, Peng X (2024e) Deal: Disentangle and localize concept-level explanations for vlms. In: ECCV
- Li W, Fritz M (2016) Recognition of ongoing complex activities by sequence prediction over a hierarchical label space. In: WACV
- Li X, Xu H (2024) Repetitive Action Counting With Motion Feature Learning. In: WACV
- Li X, Song J, Gao L, Liu X, Huang W, He X, Gan C (2019c) Beyond rnns: Positional self-attention with co-attention for video question answering. In: AAAI
- Li Y, Ye Z, Rehg JM (2015) Delving into egocentric actions. In: CVPR
- Li Y, Li Y, Vasconcelos N (2018b) Resound: Towards action recognition without representation bias. In: ECCV
- Li Y, Yao T, Pan Y, Chao H, Mei T (2018c) Jointly localizing and describing events for dense video captioning. In: CVPR
- Li Y, Wang Z, Wang L, Wu G (2020b) Actions as moving points. In: ECCV
- Li Y, Chen L, He R, Wang Z, Wu G, Wang L (2021c) Multisports: A multi-person video dataset of spatio-temporally localized sports actions. In: ICCV
- Li Y, Wu CY, Fan H, Mangalam K, Xiong B, Malik J, Feichtenhofer C (2022e) Mvity2: Improved multiscale vision transformers for classification and detection. In: CVPR
- Li Y, Min K, Tripathi S, Vasconcelos N (2023f) Svitt: Temporal learning of sparse video-text transformers. In: CVPR
- Li Y, Xiao J, Feng C, Wang X, Chua TS (2023g) Discovering spatio-temporal rationales for video question answering. In: ICCV
- Li Y, Wang C, Jia J (2024f) Llama-vid: An image is worth 2 tokens in large language models. In: European Conference on Computer Vision
- Li Y, Zhang Y, Wang C, Zhong Z, Chen Y, Chu R, Liu S, Jia J (2024g) Mini-gemini: Mining the potential of multi-modality vision language models. arXiv:240318814
- Li Z, Ma X, Shang Q, Zhu W, Ci H, Qiao Y, Wang Y (2024h) Efficient action counting with dynamic queries. arXiv:240301543
- Lian J, Baeviski A, Hsu WN, Auli M (2023) Av-data2vec: Self-supervised learning of audio-visual speech representations with contextualized target representations. In: ASRUW
- Liang C, Wang W, Zhou T, Yang Y (2022a) Visual abductive reasoning. In: CVPR
- Liang J, Wu C, Hu X, Gan Z, Wang J, Wang L, Liu Z, Fang Y, Duan N (2022b) Nuwa-infinity: Autoregressive over autoregressive generation for infinite visual synthesis. NeurIPS
- Liang J, Liang S, Luo M, Liu A, Han D, Chang EC, Cao X (2024a) VI-trojan: Multimodal instruction backdoor attacks against autoregressive visual language models. arXiv:240213851
- Liang PP, Zadeh A, Morency LP (2022c) Foundations and trends in multimodal machine learning: Principles, challenges, and open questions. arXiv:220903430
- Liang PP, Zadeh A, Morency LP (2024b) Foundations & trends in multimodal machine learning: Principles, challenges, and open questions. ACM Computing Surveys
- Liang VW, Zhang Y, Kwon Y, Yeung S, Zou JY (2022d) Mind the gap: Understanding the modality gap in multi-modal contrastive representation learning. NeurIPS
- Liang X, Lee L, Dai W, Xing EP (2017) Dual motion gan for future-flow embedded video prediction. In: ICCV
- Liberatori B, Conti A, Rota P, Wang Y, Ricci E (2024) Test-time zero-shot temporal action localization. In: CVPR
- Lin B, Tang Z, Ye Y, Cui J, Zhu B, Jin P, Zhang J, Ning M, Yuan L (2024) Moe-llava: Mixture of experts for large vision-

- language models. arXiv:240115947
- Lin C, Xu C, Luo D, Wang Y, Tai Y, Wang C, Li J, Huang F, Fu Y (2021a) Learning salient boundary feature for anchor-free temporal action localization. In: CVPR
- Lin J, Gan C, Han S (2019) Tsm: Temporal shift module for efficient video understanding. In: ICCV
- Lin K, Li L, Lin CC, Ahmed F, Gan Z, Liu Z, Lu Y, Wang L (2022a) Swinbert: End-to-end transformers with sparse attention for video captioning. In: CVPR
- Lin KE, Xiao L, Liu F, Yang G, Ramamoorthi R (2021b) Deep 3d mask volume for view synthesis of dynamic scenes. In: ICCV
- Lin KQ, Wang J, Soldan M, Wray M, Yan R, Xu EZ, Gao D, Tu RC, Zhao W, Kong W, et al (2022b) Egocentric video-language pretraining. NeurIPS
- Lin T, Zhao X, Su H, Wang C, Yang M (2018) Bsn: Boundary sensitive network for temporal action proposal generation. In: ECCV
- Lin Y, Wei C, Wang H, Yuille A, Xie C (2023a) Smaug: Sparse masked autoencoder for efficient video-language pretraining. In: ICCV
- Lin YB, Bertasius G (2024) Siamese vision transformers are scalable audio-visual learners. arXiv:240319638
- Lin YB, Sung YL, Lei J, Bansal M, Bertasius G (2023b) Vision transformers are parameter-efficient audio-visual learners. In: CVPR
- Lin Z, Geng S, Zhang R, Gao P, De Melo G, Wang X, Dai J, Qiao Y, Li H (2022c) Frozen clip models are efficient video learners. In: ECCV
- Lipman Y, Chen RT, Ben-Hamu H, Nickel M, Le M (2023) Flow matching for generative modeling. In: ICLR
- Liu D, Qu X, Dong J, Zhou P, Cheng Y, Wei W, Xu Z, Xie Y (2021a) Context-aware biaffine localizing network for temporal sentence grounding. In: CVPR
- Liu D, Qu X, Di X, Cheng Y, Xu Z, Zhou P (2022a) Memory-guided semantic learning network for temporal sentence grounding. In: AAAI
- Liu F, Liu J, Wang W, Lu H (2021b) Hair: Hierarchical visual-semantic relational reasoning for video question answering. In: ICCV
- Liu H, Liu X, Kong Q, Wang W, Plumbley MD (2022b) Learning the spectrogram temporal resolution for audio classification. In: AAAI
- Liu H, Li C, Wu Q, Lee YJ (2024a) Visual instruction tuning. NeurIPS
- Liu J, Shah M (2008) Learning human actions via information maximization. In: CVPR
- Liu J, Ali S, Shah M (2008) Recognizing human actions using multiple features. In: CVPR
- Liu J, Luo J, Shah M (2009) Recognizing realistic actions from videos "in the wild". In: CVPR
- Liu J, Teshome W, Ghimire S, Sznaiar M, Camps O (2024b) Solving masked jigsaw puzzles with diffusion vision transformers. In: CVPR
- Liu M, Wang X, Nie L, Tian Q, Chen B, Chua TS (2018a) Cross-modal moment localization in videos. In: MM
- Liu M, Tang S, Li Y, Rehg JM (2020) Forecasting human-object interaction: joint prediction of motor attention and actions in first person video. In: ECCV
- Liu M, Zhang M, Liu J, Dai H, Yang MH, Ji S, Feng Z, Gong B (2023a) Video timeline modeling for news story understanding. NeurIPS
- Liu Q, Wang Z (2020) Progressive boundary refinement network for temporal action detection. In: AAAI
- Liu S, Fan H, Qian S, Chen Y, Ding W, Wang Z (2021c) Hit: Hierarchical transformer with momentum contrast for video-text retrieval. In: ICCV
- Liu S, Tripathi S, Majumdar S, Wang X (2022c) Joint hand motion and interaction hotspots prediction from egocentric videos. In: CVPR
- Liu S, Ren Z, Gupta S, Wang S (2024c) Physgen: Rigid-body physics-grounded image-to-video generation. In: ECCV
- Liu S, Zhang CL, Zhao C, Ghanem B (2024d) End-to-end temporal action detection with 1b parameters across 1000 frames. In: CVPR
- Liu T, Lam KM (2022) A hybrid egocentric activity anticipation framework via memory-augmented recurrent and one-shot representation forecasting. In: CVPR
- Liu W, Anguelov D, Erhan D, Szegedy C, Reed S, Fu CY, Berg AC (2016) Ssd: Single shot multibox detector. In: ECCV
- Liu W, Luo W, Lian D, Gao S (2018b) Future frame prediction for anomaly detection—a new baseline. In: CVPR
- Liu W, Tekin B, Coskun H, Vineet V, Fua P, Pollefeys M (2022d) Learning to align sequential actions in the wild. In: CVPR
- Liu X, Bai S, Bai X (2022e) An empirical study of end-to-end temporal action detection. In: CVPR
- Liu Y, Wei P, Zhu SC (2017a) Jointly recognizing object fluents and tasks in egocentric videos. In: ICCV
- Liu Y, Albanie S, Nagrani A, Zisserman A (2019) Use what you have: Video retrieval using representations from collaborative experts. In: BMVC
- Liu Y, Wang L, Wang Y, Ma X, Qiao Y (2022f) Fineaction: A fine-grained video dataset for temporal action localization. IEEE T-IP
- Liu Y, Li L, Ren S, Gao R, Li S, Chen S, Sun X, Hou L (2023b) Fetv: A benchmark for fine-grained evaluation of open-domain text-to-video generation. NeurIPS
- Liu Y, Cun X, Liu X, Wang X, Zhang Y, Chen H, Liu Y, Zeng T, Chan R, Shan Y (2024e) Evalcrafter: Benchmarking and evaluating large video generation models. In: CVPR
- Liu Y, Duan H, Zhang Y, Li B, Zhang S, Zhao W, Yuan Y, Wang J, He C, Liu Z, et al (2024f) Mmbench: Is your multi-modal model an all-around player? In: ECCV
- Liu Y, Eyzaguirre C, Li M, Khanna S, Nibbles JC, Ravi V, Mishra S, Liu W, Wu J (2024g) Ikea manuals at work: 4d grounding of assembly instructions on internet videos. In: NeurIPS
- Liu Y, Zhao H, Chan KC, Wang X, Loy CC, Qiao Y, Dong C (2024h) Temporally consistent video colorization with deep feature propagation and self-regularization learning. CVM
- Liu Z, Yeh RA, Tang X, Liu Y, Agarwala A (2017b) Video frame synthesis using deep voxel flow. In: ICCV
- Liu Z, Wang L, Tang W, Yuan J, Zheng N, Hua G (2021d) Weakly supervised temporal action localization through learning explicit subspaces for action and context. In: AAAI
- Liu Z, Courant R, Kalogeiton V (2022g) Funnynet: Audiovisual learning of funny moments in videos. In: ACCV
- Liu Z, Mao H, Wu CY, Feichtenhofer C, Darrell T, Xie S (2022h) A convnet for the 2020s. In: CVPR
- Liu Z, Ning J, Cao Y, Wei Y, Zhang Z, Lin S, Hu H (2022i) Video swin transformer. In: CVPR
- Long F, Qiu Z, Yao T, Mei T (2024) Videodrafter: Content-consistent multi-scene video generation with llm. In: ECCV
- Long T, van Noord N (2023) Cross-modal scalable hyperbolic hierarchical clustering. In: ICCV
- Long T, Mettes P, Shen HT, Snoek CGM (2020) Searching for actions on the hyperbole. In: CVPR
- Lu C, Ferrier NJ (2004) Repetitive Motion Analysis: Segmentation and Event Classification. IEEE TPAMI
- Lu C, Shi J, Jia J (2013) Abnormal event detection at 150 fps in matlab. In: ICCV
- Lu H, Poppe R, Salah AA (2024) Improving the generalization of vits for action understanding with vlm pre-training. arXiv:240316128

- Luc P, Couprie C, Lecun Y, Verbeek J (2018) Predicting future instance segmentation by forecasting convolutional features. In: ECCV
- Luc P, Clark A, Dieleman S, Casas DdL, Doron Y, Cassirer A, Simonyan K (2020) Transformation-based adversarial video prediction on large-scale data. arXiv:200304035
- Luo C, Yuille AL (2019) Grouped spatial-temporal aggregation for efficient action recognition. In: ICCV
- Luo R, Zhang H, Chen L, Lin TE, Liu X, Wu Y, Yang M, Wang M, Zeng P, Gao L, et al (2024) Mmevol: Empowering multimodal large language models with evol-instruct. arXiv:240905840
- Luo W, Liu W, Gao S (2017) A revisit of sparse coding based anomaly detection in stacked rnn framework. In: ICCV
- Luo Z, Guillory D, Shi B, Ke W, Wan F, Darrell T, Xu H (2020) Weakly-supervised action localization with expectation-maximization multi-instance learning. In: ECCV
- Luo Z, Xie W, Kapoor S, Liang Y, Cooper M, Niebles JC, Adeli E, Li FF (2021) Moma: Multi-object multi-actor activity parsing. NeurIPS
- Ma C, Guo Q, Jiang Y, Luo P, Yuan Z, Qi X (2022a) Rethinking resolution in the context of efficient video recognition. NeurIPS
- Ma M, Ren J, Zhao L, Testuggine D, Peng X (2022b) Are multimodal transformers robust to missing modality? In: CVPR
- Ma S, Zeng Z, McDuff D, Song Y (2021) Active contrastive learning of audio-visual video representations. In: ICLR
- Maaz M, Rasheed H, Khan S, Khan FS (2023) Video-chatgpt: Towards detailed video understanding via large vision and language models. arXiv:230605424
- Madan N, Moegelmose A, Modi R, Rawat YS, Moeslund TB (2024) Foundation models for video understanding: A survey. arXiv:240503770
- Majumder S, Nagarajan T, Al-Halah Z, Pradhan R, Grauman K (2024) Which viewpoint shows it best? language for weakly supervising view selection in multi-view videos. arXiv:241108753
- Mangalam K, Akshulakov R, Malik J (2023) Egoschema: A diagnostic benchmark for very long-form video language understanding. NeurIPS
- Markovitz A, Sharir G, Friedman I, Zelnik-Manor L, Avidan S (2020) Graph embedded pose clustering for anomaly detection. In: CVPR
- Marszalek M, Laptev I, Schmid C (2009) Actions in context. In: CVPR
- Martin M, Roitberg A, Haurilet M, Horne M, Reiß S, Voit M, Stiefelhagen R (2019) Drive&act: A multi-modal dataset for fine-grained driver behavior recognition in autonomous vehicles. In: ICCV
- Mascaró EV, Ahn H, Lee D (2023) Intention-conditioned long-term human egocentric action anticipation. In: WACV
- Mavroudi E, Afouras T, Torresani L (2023) Learning to ground instructional articles in videos through narrations. In: ICCV
- Menapace W, Lathuiliere S, Tulyakov S, Siarohin A, Ricci E (2021) Playable video generation. In: CVPR
- Meng Y, Lin CC, Panda R, Sattigeri P, Karlinsky L, Oliva A, Saenko K, Feris R (2020) Ar-net: Adaptive frame resolution for efficient action recognition. In: ECCV
- Menick J, Kalchbrenner N (2019) Generating high fidelity images with subscale pixel networks and multidimensional upscaling. In: ICLR
- Metaxas D, Zhang S (2013) A review of motion analysis methods for human nonverbal communication computing. IVC
- Mettes P, Van Gemert JC, Snoek CGM (2016) Spot on: Action localization from pointily-supervised proposals. In: ECCV
- Mettes P, Ghadimi Atigh M, Keller-Ressel M, Gu J, Yeung S (2024) Hyperbolic deep learning in computer vision: A survey. IJCV
- Micorek J, Possegger H, Narnhofer D, Bischof H, Kozinski M (2024) Mulde: Multiscale log-density estimation via denoising score matching for video anomaly detection. In: CVPR
- Miech A, Zhukov D, Alayrac JB, Tapaswi M, Laptev I, Sivic J (2019) Howto100m: Learning a text-video embedding by watching hundred million narrated video clips. In: CVPR
- Miech A, Alayrac JB, Laptev I, Sivic J, Zisserman A (2020a) Rareact: A video dataset of unusual interactions. arXiv:200801018
- Miech A, Alayrac JB, Smaira L, Laptev I, Sivic J, Zisserman A (2020b) End-to-end learning of visual representations from uncurated instructional videos. In: CVPR
- Mikolajczyk K, Uemura H (2008) Action recognition with motion-appearance vocabulary forest. In: CVPR
- Min J, Buch S, Nagrani A, Cho M, Schmid C (2024) Morevqa: Exploring modular reasoning models for video question answering. In: CVPR
- Ming R, Huang Z, Ju Z, Hu J, Peng L, Zhou S (2024) A survey on video prediction: From deterministic to generative approaches. arXiv:240114718
- Minh D, Wang HX, Li YF, Nguyen TN (2022) Explainable artificial intelligence: A comprehensive review. Artificial Intelligence Review
- Misra I, Zitnick CL, Hebert M (2016) Shuffle and learn: unsupervised learning using temporal order verification. In: ECCV
- Mistretta M, Baldrati A, Bertini M, Bagdanov AD (2024) Improving zero-shot generalization of learned prompts via unsupervised knowledge distillation. In: ECCV
- Mithun NC, Li J, Metze F, Roy-Chowdhury AK (2018) Learning joint embedding with multimodal cues for cross-modal video-text retrieval. In: ICMR
- Mittal H, Agarwal N, Lo SY, Lee K (2024) Can't make an omelette without breaking some eggs: Plausible action anticipation using large video-language models. In: CVPR
- Mizrachi D, Bachmann R, Kar O, Yeo T, Gao M, Dehghan A, Zamir A (2023) 4m: Massively multimodal masked modeling. NeurIPS
- Mo S, Morgado P (2023) A unified audio-visual learning framework for localization, separation, and recognition. In: ICML
- Moeslund TB, Granum E (2001) A survey of computer vision-based human motion capture. CVIU
- Moeslund TB, Hilton A, Krüger V (2006) A survey of advances in vision-based human motion capture and analysis. CVIU
- Mokady R, Hertz A, Bermano AH (2021) Clipcap: Clip prefix for image captioning. arXiv:211109734
- Moltisanti D, Fidler S, Damen D (2019) Action recognition from single timestamp supervision in untrimmed videos. In: CVPR
- Moltisanti D, Keller F, Bilen H, Sevilla-Lara L (2023) Learning action changes by measuring verb-adverb textual relationships. In: CVPR
- Monfort M, Andonian A, Zhou B, Ramakrishnan K, Bargal SA, Yan T, Brown L, Fan Q, Gutfreund D, Vondrick C, et al (2019) Moments in time dataset: one million videos for event understanding. IEEE TPAMI
- Monfort M, Jin S, Liu A, Harwath D, Feris R, Glass J, Oliva A (2021) Spoken moments: Learning joint audio-visual representations from video descriptions. In: CVPR
- Moon G, Yu SI, Wen H, Shiratori T, Lee KM (2020) Interhand2. 6m: A dataset and baseline for 3d interacting hand pose estimation from a single rgb image. In: ECCV
- Morais R, Le V, Tran T, Saha B, Mansour M, Venkatesh S (2019) Learning regularity in skeleton trajectories for anomaly detection in videos. In: CVPR
- Morales J, Murrugarra-Llerena N, Saavedra JM (2022) Leveraging unlabeled data for sketch-based understanding. In: CVPRW

- Morgado P, Vasconcelos N, Misra I (2021) Audio-visual instance discrimination with cross-modal agreement. In: CVPR
- Mounir R, Vijayaraghavan S, Sarkar S (2023) Streamer: Streaming representation learning and event segmentation in a hierarchical manner. *NeurIPS*
- Mueller F, Mehta D, Sotnychenko O, Sridhar S, Casas D, Theobalt C (2017) Real-time hand tracking under occlusion from an egocentric rgb-d sensor. In: CVPR
- Mun J, Yang L, Ren Z, Xu N, Han B (2019) Streamlined dense video captioning. In: CVPR
- Mun J, Cho M, Han B (2020) Local-global video-text interactions for temporal grounding. In: CVPR
- Munoz A, Zolfaghari M, Argus M, Brox T (2021) Temporal shift gan for large scale video generation. In: WACV
- Munro J, Damen D (2020) Multi-modal domain adaptation for fine-grained action recognition. In: CVPR
- Mur-Labadia L, Martinez-Cantin R, Guerrero J, Farinella GM, Furnari A (2024) Aff-ttention! affordances and attention models for short-term object interaction anticipation. [arXiv:2406.01194](https://arxiv.org/abs/2406.01194)
- Nag S, Zhu X, Song YZ, Xiang T (2022) Zero-shot temporal action detection via vision-language prompting. In: ECCV
- Nag S, Zhu X, Deng J, Song YZ, Xiang T (2023) Diffdad: Temporal action detection with proposal denoising diffusion. In: ICCV
- Nag S, Goswami K, Karanam S (2024) Safari: Adaptive sequence transformer for weakly supervised referring expression segmentation. In: ECCV
- Nagarajan T, Grauman K (2018) Attributes as operators: factorizing unseen attribute-object compositions. In: ECCV
- Nagarajan T, Feichtenhofer C, Grauman K (2019) Grounded human-object interaction hotspots from video. In: CVPR
- Nagrani A, Yang S, Arnab A, Jansen A, Schmid C, Sun C (2021) Attention bottlenecks for multimodal fusion. In: *NeurIPS*
- Nan G, Qiao R, Xiao Y, Liu J, Leng S, Zhang H, Lu W (2021) Inter-ventional video grounding with dual contrastive learning. In: CVPR
- Nawal M, Jyothi AA, Mori G (2022) Rethinking learning approaches for long-term action anticipation. In: ECCV
- Ngiam J, Khosla A, Kim M, Nam J, Lee H, Ng AY (2011) Multi-modal deep learning. In: ICML
- Nguyen TN, Meunier J (2019) Anomaly detection in video sequence with appearance-motion correspondence. In: ICCV
- Ni B, Paramathayalan VR, Moulin P (2014) Multiple granularity analysis for fine-grained action detection. In: CVPR
- Nie X, Chen X, Jin H, Zhu Z, Yan Y, Qi D (2024) Triplet attention transformer for spatiotemporal predictive learning. In: WACV
- Niebles JC, Wang H, Fei-Fei L (2008) Unsupervised learning of human action categories using spatial-temporal words. *IJCV*
- Niebles JC, Chen CW, Fei-Fei L (2010) Modeling temporal structure of decomposable motion segments for activity classification. In: ECCV
- Nikankin Y, Haim N, Irani M (2023) Sinfusion: training diffusion models on a single image or video. In: ICML
- Nowozin S, Bakir G, Tsuda K (2007) Discriminative subsequence mining for action classification. In: ICCV
- Ntinou I, Sanchez E, Tzimiropoulos G (2024) Multiscale vision transformers meet bipartite matching for efficient single-stage action localization. In: CVPR
- Nugroho MA, Woo S, Lee S, Kim C (2023) Audio-visual glance network for efficient video recognition. In: ICCV
- Ohkawa T, He K, Sener F, Hodan T, Tran L, Keskin C (2023) AssemblyHands: towards egocentric activity understanding via 3d hand pose estimation. In: CVPR
- Oikonomopoulos A, Patras I, Pantic M (2005) Spatiotemporal saliency for human action recognition. In: ICME
- Oncescu AM, Henriques JF, Liu Y, Zisserman A, Albanie S (2021) Queryd: A video dataset with high-quality text and audio narrations. In: ICASSP
- Oneata D, Verbeek J, Schmid C (2013) Action and event recognition with fisher vectors on a compact feature set. In: ICCV
- Oord Avd, Li Y, Vinyals O (2018) Representation learning with contrastive predictive coding. *arXiv preprint arXiv:1807.03748*
- Oprea S, Martinez-Gonzalez P, Garcia-Garcia A, Castro-Vargas JA, Orts-Escolano S, Garcia-Rodriguez J, Argyros A (2022) A review on deep learning techniques for video prediction. *IEEE TPAMI*
- Oreifej O, Liu Z (2013) Hon4d: Histogram of oriented 4d normals for activity recognition from depth sequences. In: CVPR
- Ortega JD, Kose N, Cañas P, Chao MA, Unnervik A, Nieto M, Otaegui O, Salgado L (2020) Dmd: A large-scale multi-modal driver monitoring dataset for attention and alertness analysis. In: ECCV
- Oshima Y, Taniguchi S, Suzuki M, Matsuo Y (2024) Ssm meets video diffusion models: Efficient video generation with structured state spaces. In: ICLRw
- Otani M, Nakashima Y, Rahtu E, Heikkilä J, Yokoya N (2016) Learning joint representations of videos and sentences with web image search. In: ECCVw
- Owens A, Isola P, McDermott J, Torralba A, Adelson EH, Freeman WT (2016) Visually indicated sounds. In: CVPR
- Pan B, Cao Z, Adeli E, Niebles JC (2020) Adversarial cross-domain action recognition with co-attention. In: AAAI
- Pan J, Chen S, Shou MZ, Liu Y, Shao J, Li H (2021a) Actor-context-actor relation network for spatio-temporal action localization. In: CVPR
- Pan T, Song Y, Yang T, Jiang W, Liu W (2021b) Videomoco: Contrastive video representation learning with temporally adversarial examples. In: CVPR
- Pan X, Qin P, Li Y, Xue H, Chen W (2024) Synthesizing coherent story with auto-regressive latent diffusion models. In: WACV
- Pan Y, Yao T, Li H, Mei T (2017) Video captioning with transferred semantic attributes. In: CVPR
- Panagiotakis C, Karvounas G, Argyros A (2018) Unsupervised Detection of Periodic Segments in Videos. In: ICIP
- Paredes BR, Argyriou A, Berthouze N, Pontil M (2012) Exploiting unrelated tasks in multi-task learning. In: AISTATS
- Pareek P, Thakkar A (2021) A survey on video-based human action recognition: recent updates, datasets, challenges, and applications. *UMT-AIR*
- Park H, Noh J, Ham B (2020) Learning memory-guided normality for anomaly detection. In: CVPR
- Park J, Lee J, Sohn K (2021a) Bridge to answer: Structure-aware graph interaction network for video question answering. In: CVPR
- Park J, Lee J, Kim JJ, Sohn K (2022a) Probabilistic representations for video contrastive learning. In: CVPR
- Park JS, Shen S, Farhadi A, Darrell T, Choi Y, Rohrbach A (2022b) Exposing the limits of video-text models through contrast sets. In: NAACL
- Park N, Kim W, Heo B, Kim T, Yun S (2023) What do self-supervised vision transformers learn? In: ICLR
- Park S, Kim K, Lee J, Choo J, Lee J, Kim S, Choi E (2021b) Vidode: Continuous-time video generation with neural ordinary differential equation. In: AAAI
- Park W, Kim D, Lu Y, Cho M (2019) Relational knowledge distillation. In: CVPR
- Parmar P, Morris BT (2019) What and how well you performed? a multitask learning approach to action quality assessment. In: CVPR

- Parthasarathy N, Eslami S, Carreira J, Henaff O (2023) Self-supervised video pretraining yields robust and more human-aligned visual representations. *NeurIPS*
- Patrick M, Huang PY, Asano Y, Metze F, Hauptmann A, Henriques J, Vedaldi A (2020) Support-set bottlenecks for video-text representation learning. In: *ICLR*
- Patron-Perez A, Marszalek M, Zisserman A, Reid I (2010) High five: Recognising human interactions in tv shows. In: *BMVC*
- Patsch C, Zhang J, Wu Y, Zakour M, Salihu D, Steinbach E (2024) Long-term action anticipation based on contextual alignment. In: *ICASSP*
- Paul S, Roy S, Roy-Chowdhury AK (2018) W-talc: Weakly-supervised temporal activity localization and classification. In: *ECCV*
- Peh E, Parmar P, Fernando B (2024) Learning to visually connect actions and their effects. *arXiv:240110805*
- Pei G, Chen T, Jiang X, Liu H, Sun Z, Yao Y (2024) Videomac: Video masked autoencoders meet convnets. In: *CVPR*
- Pei M, Jia Y, Zhu SC (2011) Parsing video events with goal inference and intent prediction. In: *ICCV*
- Peng S, Zhang Y, Xu Y, Wang Q, Shuai Q, Bao H, Zhou X (2021) Neural body: Implicit neural representations with structured latent codes for novel view synthesis of dynamic humans. In: *CVPR*
- Peng X, Schmid C (2016) Multi-region two-stream r-cnn for action detection. In: *ECCV*
- Perrett T, Damen D (2019) Ddlstm: dual-domain lstm for cross-dataset action recognition. In: *CVPR*
- Perrett T, Han T, Damen D, Zisserman A (2024) It's just another day: Unique video captioning by discriminative prompting. In: *ACCV*
- Phan T, Vo K, Le D, Doretto G, Adjeroh D, Le N (2024) Zeetad: Adapting pretrained vision-language model for zero-shot end-to-end temporal action detection. In: *WACV*
- Pian W, Mo S, Guo Y, Tian Y (2023) Audio-visual class-incremental learning. In: *ICCV*
- Pickup LC, Pan Z, Wei D, Shih Y, Zhang C, Zisserman A, Scholkopf B, Freeman WT (2014) Seeing the arrow of time. In: *CVPR*
- Piergiovanni A, Ryoo M (2020) Avid dataset: Anonymized videos from diverse countries. *NeurIPS*
- Piergiovanni A, Angelova A, Toshev A, Ryoo MS (2020) Adversarial generative grammars for human activity prediction. In: *ECCV*
- Piergiovanni A, Kuo W, Angelova A (2023) Rethinking video vits: Sparse video tubes for joint image and video learning. In: *CVPR*
- Piergiovanni A, Noble I, Kim D, Ryoo MS, Gomes V, Angelova A (2024) Mirasol3b: A multimodal autoregressive model for time-aligned and contextual modalities. In: *CVPR*
- Pirsiavash H, Ramanan D (2012) Detecting activities of daily living in first-person camera views. In: *CVPR*
- Pishchulin L, Andriluka M, Gehler P, Schiele B (2013) Strong appearance and expressive spatial models for human pose estimation. In: *CVPR*
- Plizzari C, Goletto G, Furnari A, Bansal S, Ragusa F, Farinella GM, Damen D, Tommasi T (2024) An outlook into the future of egocentric vision. *IJCV*
- Pogalin E, Smeulders AW, Thean AH (2008) Visual Quasi-Periodicity. In: *CVPR*
- Poli M, Massaroli S, Nguyen E, Fu DY, Dao T, Baccus S, Bengio Y, Ermon S, Ré C (2023) Hyena hierarchy: Towards larger convolutional language models. In: *ICLR*
- Ponimatkin G, Samet N, Xiao Y, Du Y, Marlet R, Lepetit V (2023) A simple and powerful global optimization for unsupervised video object segmentation. In: *WACV*
- Poppe R (2010) A survey on vision-based human action recognition. *IVC*
- Price W, Vondrick C, Damen D (2022) Unweavenet: Unweaving activity stories. In: *CVPR*
- Pu Y, Wu X, Yang L, Wang S (2024) Learning prompt-enhanced context features for weakly-supervised video anomaly detection. *IEEE T-IP*
- Purwanto D, Chen YT, Fang WH (2021) Dance with self-attention: A new look of conditional random fields on anomaly detection in videos. In: *ICCV*
- Qian L, Li J, Wu Y, Ye Y, Fei H, Chua TS, Zhuang Y, Tang S (2024) Momentor: Advancing video large language model with fine-grained temporal reasoning. In: *ICML*
- Qian R, Meng T, Gong B, Yang MH, Wang H, Belongie S, Cui Y (2021) Spatiotemporal contrastive video representation learning. In: *CVPR*
- Qing Z, Su H, Gan W, Wang D, Wu W, Wang X, Qiao Y, Yan J, Gao C, Sang N (2021) Temporal context aggregation network for temporal action proposal refinement. In: *CVPR*
- Qiu Z, Yao T, Mei T (2017) Learning spatio-temporal representation with pseudo-3d residual networks. In: *ICCV*
- Qiu Z, Yao T, Ngo CW, Tian X, Mei T (2019) Learning spatio-temporal representation with local and global diffusion. In: *CVPR*
- Qu X, Tang P, Zou Z, Cheng Y, Dong J, Zhou P, Xu Z (2020) Fine-grained iterative attention network for temporal language localization in videos. In: *MM*
- Radevski G, Grujicic D, Blaschko M, Moens MF, Tuytelaars T (2023) Multimodal distillation for egocentric action recognition. In: *ICCV*
- Radford A, Kim JW, Hallacy C, Ramesh A, Goh G, Agarwal S, Sastry G, Askell A, Mishkin P, Clark J, et al (2021) Learning transferable visual models from natural language supervision. In: *ICLR*
- Ragusa F, Furnari A, Livatino S, Farinella GM (2021) The mecano dataset: Understanding human-object interactions from egocentric videos in an industrial-like domain. In: *WACV*
- Rahmani H, Mahmood A, Huynh DQ, Mian A (2014) Real time action recognition using histograms of depth gradients and random decision forests. In: *WACV*
- Rahmanzadehgervi P, Bolton L, Taesiri MR, Nguyen AT (2024) Vision language models are blind. In: *ACCV*
- Rai N, Chen H, Ji J, Desai R, Kozuka K, Ishizaka S, Adeli E, Niebles JC (2021) Home action genome: Cooperative compositional action understanding. In: *CVPR*
- Ramachandra B, Jones MJ, Vatsavai RR (2020) A survey of single-scene video anomaly detection. *IEEE TPAMI*
- Ramesh A, Dhariwal P, Nichol A, Chu C, Chen M (2022) Hierarchical text-conditional image generation with clip latents. *arXiv:220406125*
- Ranasinghe K, Ryoo MS (2023) Language-based action concept spaces improve video self-supervised learning. *NeurIPS*
- Ranasinghe K, Naseer M, Khan S, Khan FS, Ryoo MS (2022) Self-supervised video transformer. In: *CVPR*
- Randall M (2009) Movie narrative charts. URL <https://xkcd.com/657/>
- Rangrej SB, Liang KJ, Hassner T, Clark JJ (2023) Glitr: Glimpse transformers with spatiotemporal consistency for online action prediction. In: *WACV*
- Rasouli A (2020) Deep learning for vision-based prediction: A survey. *arXiv:200700095*
- Rawal R, Saifullah K, Farré M, Basri R, Jacobs D, Somepalli G, Goldstein T (2024) Cinepile: A long video question answering dataset and benchmark. *arXiv:240508813*
- Recasens A, Luc P, Alayrac JB, Wang L, Strub F, Tallec C, Malinowski M, Pătrăucean V, Althé F, Valko M, et al (2021)



- Broaden your views for self-supervised video learning. In: ICCV
- Recasens A, Lin J, Carreira J, Jaegle D, Wang L, Alayrac Jb, Luc P, Miech A, Smaila L, Hemsley R, et al (2023) Zorro: the masked multimodal transformer. arXiv:230109595
- Reddy KK, Shah M (2013) Recognizing 50 human action categories of web videos. MVA
- Redmon J, Divvala S, Girshick R, Farhadi A (2016) You only look once: Unified, real-time object detection. In: CVPR
- Regneri M, Rohrbach M, Wetzel D, Thater S, Schiele B, Pinkal M (2013) Grounding action descriptions in videos. TACL
- Rehg JM, Abowd GD, Rozga A, Romero M, Clements MA, Sclaroff S, Essa I, Ousley OY, Li Y, Kim C, Rao H, Kim JC, Presti LL, Zhang J, Lantsman D, Bidwell J, Ye Z (2013) Decoding children's social behavior. In: CVPR
- Ren S, Yao L, Li S, Sun X, Hou L (2024a) Timechat: A time-sensitive multimodal large language model for long video understanding. In: CVPR
- Ren W, Yang H, Zhang G, Wei C, Du X, Huang W, Chen W (2024b) Consisti2v: Enhancing visual consistency for image-to-video generation. TMLR
- Rizve MN, Mittal G, Yu Y, Hall M, Sajeev S, Shah M, Chen M (2023) Pivotal: Prior-driven supervision for weakly-supervised temporal action localization. In: CVPR
- Rizzolatti G, Fogassi L, Gallese V (2001) Neurophysiological mechanisms underlying the understanding and imitation of action. *Nature reviews neuroscience*
- Robinson J, Sun L, Yu K, Batmanghelich K, Jegelka S, Sra S (2021) Can contrastive learning avoid shortcut solutions? *NeurIPS*
- Rodin I, Furnari A, Mavroudis D, Farinella GM (2021) Predicting the future from first person (egocentric) vision: A survey. *CVIU*
- Rodriguez MD, Ahmed J, Shah M (2008) Action mach a spatio-temporal maximum average correlation height filter for action recognition. In: CVPR
- Rohr K (1994) Towards model-based recognition of human movements in image sequences. *CVGIP*
- Rohrbach A, Rohrbach M, Tandon N, Schiele B (2015) A dataset for movie description. In: CVPR
- Rohrbach A, Rohrbach M, Hu R, Darrell T, Schiele B (2016) Grounding of textual phrases in images by reconstruction. In: *ECCV*
- Rohrbach M, Amin S, Andriluka M, Schiele B (2012) A database for fine grained activity detection of cooking activities. In: *CVPR*
- Rombach R, Blattmann A, Lorenz D, Esser P, Ommer B (2022) High-resolution image synthesis with latent diffusion models. In: *CVPR*
- Roy D, Fernando B (2021) Action anticipation using pairwise human-object interactions and transformers. *IEEE T-IP*
- Roy D, Fernando B (2022) Action anticipation using latent goal learning. In: *WACV*
- Roy D, Rajendiran R, Fernando B (2024) Interaction region visual transformer for egocentric action anticipation. In: *WACV*
- Runia TFH, Snoek CGM, Smeulders AW (2018) Real-World Repetition Estimation by Div, Grad and Curl. In: *CVPR*
- Ryali C, Hu YT, Bolya D, Wei C, Fan H, Huang PY, Aggarwal V, Chowdhury A, Poursaeed O, Hoffman J, et al (2023) Hiera: A hierarchical vision transformer without the bells-and-whistles. In: *ICML*
- Ryoo M, Piergiovanni A, Arnab A, Dehghani M, Angelova A (2021) Tokenlearner: Adaptive space-time tokenization for videos. *NeurIPS*
- Ryoo MS (2011) Human activity prediction: Early recognition of ongoing activities from streaming videos. In: *ICCV*
- Ryoo MS, Aggarwal JK (2009) Spatio-temporal relationship match: Video structure comparison for recognition of complex human activities. In: *ICCV*
- Sadanand S, Corso JJ (2012) Action bank: A high-level representation of activity in video. In: *CVPR*
- Saini N, Pham K, Shrivastava A (2022) Disentangling visual embeddings for attributes and objects. In: *CVPR*
- Saini N, Wang H, Swaminathan A, Jayasundara V, He B, Gupta K, Shrivastava A (2023) Chop & learn: Recognizing and generating object-state compositions. In: *ICCV*
- Saito M, Matsumoto E, Saito S (2017) Temporal generative adversarial nets with singular value clipping. In: *ICCV*
- Saito M, Saito S, Koyama M, Kobayashi S (2020) Train sparsely, generate densely: Memory-efficient unsupervised training of high-resolution temporal gan. *IJCV*
- Sakoe H, Chiba S (1978) Dynamic programming algorithm optimization for spoken word recognition. *IEEE TASSP*
- Salehi M, Gavves E, Snoek CGM, Asano YM (2023) Time does tell: Self-supervised time-tuning of dense image representations. In: *ICCV*
- Salimans T, Karpathy A, Chen X, Kingma DP (2017) Pixelcnn++: Improving the pixelcnn with discretized logistic mixture likelihood and other modifications. In: *ICLR*
- Sameni S, Jenni S, Favaro P (2023) Spatio-temporal crop aggregation for video representation learning. In: *ICCV*
- Sarkar P, Beirami A, Etemad A (2023) Uncovering the hidden dynamics of video self-supervised learning under distribution shifts. *NeurIPS*
- Saxena V, Ba J, Hafner D (2021) Clockwork variational autoencoders. *NeurIPS*
- Schiappa MC, Rawat YS, Shah M (2023) Self-supervised learning for videos: A survey. *CSUR*
- Schlimmer JC, Fisher D (1986) A case study of incremental concept induction. In: *AAAI*
- Schuld C, Laptev I, Caputo B (2004) Recognizing human actions: a local svm approach. In: *ICPR*
- Selva J, Johansen AS, Escalera S, Nasrollahi K, Moeslund TB, Clapés A (2023) Video transformers: A survey. *IEEE TPAMI*
- Sener F, Chatterjee D, Shelepov D, He K, Singhania D, Wang R, Yao A (2022) Assembly101: A large-scale multi-view video dataset for understanding procedural activities. In: *CVPR*
- Seo PH, Nagrani A, Arnab A, Schmid C (2022) End-to-end generative pretraining for multimodal video captioning. In: *CVPR*
- Sermanet P, Xu K, Levine S (2017) Unsupervised perceptual rewards for imitation learning. In: *ICLRw*
- Sermanet P, Lynch C, Chebotar Y, Hsu J, Jang E, Schaal S, Levine S, Brain G (2018) Time-contrastive networks: Self-supervised learning from video. In: *ICRA*
- Sevilla-Lara L, Liao Y, Güney F, Jampani V, Geiger A, Black MJ (2019) On the integration of optical flow and action recognition. In: *GCPR*
- Shahroury A, Liu J, Ng TT, Wang G (2016) Ntu rgb+ d: A large scale dataset for 3d human activity analysis. In: *CVPR*
- Shang X, Ren T, Guo J, Zhang H, Chua TS (2017) Video visual relation detection. In: *MM*
- Shao D, Zhao Y, Dai B, Lin D (2020) Finegym: A hierarchical video dataset for fine-grained action understanding. In: *CVPR*
- Shao J, Wang X, Quan R, Zheng J, Yang J, Yang Y (2023) Action sensitivity learning for temporal action localization. In: *ICCV*
- Sharma S, Kiros R, Salakhutdinov R (2015) Action recognition using visual attention. In: *ICLR*
- Shechtman E, Irani M (2005) Space-time behavior based correlation. In: *CVPR*
- Sheikh Y, Sheikh M, Shah M (2005) Exploring the space of a human action. In: *ICCV*

- Shen J, Tenenholz N, Hall JB, Alvarez-Melis D, Fusi N (2024) Tag-llm: Repurposing general-purpose llms for specialized domains. arXiv:240205140
- Shen X, Li X, Elhoseiny M (2023a) Mostgan-v: Video generation with temporal motion styles. In: CVPR
- Shen Y, Elhamifar E (2024) Progress-aware online action segmentation for egocentric procedural task videos. In: CVPR
- Shen Y, Ni B, Li Z, Zhuang N (2018) Egocentric activity prediction via event modulated attention. In: ECCV
- Shen Y, Gu X, Xu K, Fan H, Wen L, Zhang L (2023b) Accurate and fast compressed video captioning. In: CVPR
- Shen Z, Li J, Su Z, Li M, Chen Y, Jiang YG, Xue X (2017) Weakly supervised dense video captioning. In: CVPR
- Shi B, Ji L, Liang Y, Duan N, Chen P, Niu Z, Zhou M (2019) Dense procedure captioning in narrated instructional videos. In: ACL
- Shi D, Zhong Y, Cao Q, Ma L, Li J, Tao D (2023) Tridet: Temporal action detection with relative boundary modeling. In: CVPR
- Shin W, Lee J, Lee T, Lee S, Yun JP (2023) Anomaly detection using score-based perturbation resilience. In: ICCV
- Shou MZ, Lei SW, Wang W, Ghadiyaram D, Feiszli M (2021) Generic event boundary detection: A benchmark for event segmentation. In: ICCV
- Shou Z, Wang D, Chang SF (2016) Temporal action localization in untrimmed videos via multi-stage cnns. In: CVPR
- Shou Z, Chan J, Zareian A, Miyazawa K, Chang SF (2017) Cdc: Convolutional-de-convolutional networks for precise temporal action localization in untrimmed videos. In: CVPR
- Shou Z, Gao H, Zhang L, Miyazawa K, Chang SF (2018) Autoloc: Weakly-supervised temporal action localization in untrimmed videos. In: ECCV
- Shrivastava G, Shrivastava A (2024) Video prediction by modeling videos as continuous multi-dimensional processes. In: CVPR
- Sigal L, Balan AO, Black MJ (2010) Humaneva: Synchronized video and motion capture dataset and baseline algorithm for evaluation of articulated human motion. IJCV
- Sigurdsson GA, Varol G, Wang X, Farhadi A, Laptev I, Gupta A (2016) Hollywood in homes: Crowdsourcing data collection for activity understanding. In: ECCV
- Sigurdsson GA, Gupta A, Schmid C, Farhadi A, Alahari K (2018) Charades-ego: A large-scale dataset of paired third and first person videos. arXiv:180409626
- Simonyan K, Zisserman A (2014) Two-stream convolutional networks for action recognition in videos. NeurIPS
- Singer U, Polyak A, Hayes T, Yin X, An J, Zhang S, Hu Q, Yang H, Ashual O, Gafni O, et al (2023) Make-a-video: Text-to-video generation without text-video data. In: ICLR
- Singh B, Marks TK, Jones M, Tuzel O, Shao M (2016) A multi-stream bi-directional recurrent neural network for fine-grained action detection. In: CVPR
- Singh G, Saha S, Sapienza M, Torr PH, Cuzzolin F (2017) Online real-time multiple spatiotemporal action localisation and prediction. In: ICCV
- Singh N, Wu CW, Orife I, Kalayeh M (2024) Looking similar sounding different: Leveraging counterfactual cross-modal pairs for audiovisual representation learning. In: CVPR
- Sinha S, Stergiou A, Damen D (2024) Every shot counts: Using exemplars for repetition counting in videos. In: ACCV
- Skorokhodov I, Tulyakov S, Elhoseiny M (2022) Stylegan-v: A continuous video generator with the price, image quality and perks of stylegan2. In: CVPR
- Smaira L, Carreira J, Noland E, Clancy E, Wu A, Zisserman A (2020) A short note on the kinetics-700-2020 human action dataset. arXiv:201010864
- Smith J, De Mello S, Kautz J, Linderman S, Byeon W (2024) Convolutional state space models for long-range spatiotemporal modeling. NeurIPS
- Sohl-Dickstein J, Weiss E, Maheswaranathan N, Ganguli S (2015) Deep unsupervised learning using nonequilibrium thermodynamics. In: ICLR
- Song E, Chai W, Wang G, Zhang Y, Zhou H, Wu F, Chi H, Guo X, Ye T, Zhang Y, et al (2024) Moviechat: From dense token to sparse memory for long video understanding. In: CVPR
- Song J, Yang Y, Huang Z, Shen HT, Hong R (2011) Multiple feature hashing for real-time large scale near-duplicate video retrieval. In: MM
- Song L, Zhang S, Yu G, Sun H (2019) Tacnet: Transition-aware context network for spatio-temporal action detection. In: CVPR
- Song L, Yu G, Yuan J, Liu Z (2021) Human pose estimation and its application to action recognition: A survey. JVCIR
- Song Y, Ermon S (2019) Generative modeling by estimating gradients of the data distribution. NeurIPS 32
- Soomro K, Zamir AR, Shah M (2012) Ucf101: A dataset of 101 human actions classes from videos in the wild. arXiv:12120402
- Soomro K, Idrees H, Shah M (2015) Action localization in videos through context walk. In: ICCV
- Souček T, Alayrac JB, Miech A, Laptev I, Sivic J (2022) Look for the change: Learning object states and state-modifying actions from untrimmed web videos. In: CVPR
- Souček T, Damen D, Wray M, Laptev I, Sivic J, et al (2024) Genhowto: Learning to generate actions and state transformations from instructional videos. In: CVPR
- Spielberg A, Zhong F, Rematas K, Jatavallabhula KM, Oztireli C, Li TM, Nowrouzezahrai D (2023) Differentiable visual computing for inverse problems and machine learning. Nature Machine Intelligence
- Spunt RP, Satpute AB, Lieberman MD (2011) Identifying the what, why, and how of an observed action: an fmri study of mentalizing and mechanizing during action observation. JCN
- Srivastava N, Mansimov E, Salakhudinov R (2015) Unsupervised learning of video representations using lstms. In: ICML
- Srivastava S, Sharma G (2024a) Omnivec: Learning robust representations with cross modal sharing. In: WACV
- Srivastava S, Sharma G (2024b) Omnivec2-a novel transformer based network for large scale multimodal and multitask learning. In: CVPR
- van Steenkiste S, Zoran D, Yang Y, Rubanova Y, Kabra R, Doersch C, Gokay D, Heyward J, Pot E, Greff K, et al (2024) Moving off-the-grid: Scene-grounded video representations. In: NeurIPS
- Stein S, McKenna SJ (2013) Combining embedded accelerometers with computer vision for recognizing food preparation activities. In: UbiComp
- Stergiou A (2024) Lavib: A large-scale video interpolation benchmark. NeurIPS
- Stergiou A, Damen D (2023a) Play it back: Iterative attention for audio recognition. In: ICASSP
- Stergiou A, Damen D (2023b) The wisdom of crowds: Temporal progressive attention for early action prediction. In: CVPR
- Stergiou A, Deligiannis N (2023) Leaping into memories: Space-time deep feature synthesis. In: ICCV
- Stergiou A, Poppe R (2019) Analyzing human-human interactions: A survey. CVIU
- Stergiou A, Poppe R (2021a) Learn to cycle: Time-consistent feature discovery for action recognition. PRL
- Stergiou A, Poppe R (2021b) Multi-temporal convolutions for human action recognition in videos. In: IJCNN
- Stergiou A, De Weerd B, Deligiannis N (2024) Holistic representation learning for multitask trajectory anomaly detection.

- In: WACV
- Sudhakaran S, Escalera S, Lanz O (2020) Gate-shift networks for video action recognition. In: CVPR
- Sultani W, Chen C, Shah M (2018) Real-world anomaly detection in surveillance videos. In: CVPR
- Sun C, Shrivastava A, Vondrick C, Murphy K, Sukthankar R, Schmid C (2018) Actor-centric relation network. In: ECCV
- Sun C, Baradel F, Murphy K, Schmid C (2019a) Learning video representations using contrastive bidirectional transformer. arXiv:190605743
- Sun C, Myers A, Vondrick C, Murphy K, Schmid C (2019b) Videobert: A joint model for video and language representation learning. In: CVPR
- Sun C, Shrivastava A, Vondrick C, Sukthankar R, Murphy K, Schmid C (2019c) Relational action forecasting. In: CVPR
- Sun C, Nagrani A, Tian Y, Schmid C (2021a) Composable augmentation encoding for video representation learning. In: ICCV
- Sun L, Jia K, Yeung DY, Shi BE (2015) Human action recognition using factorized spatio-temporal convolutional networks. In: ICCV
- Sun P, Cao J, Jiang Y, Yuan Z, Bai S, Kitani K, Luo P (2022a) Dance-track: Multi-object tracking in uniform appearance and diverse motion. In: CVPR
- Sun S, Liu D, Dong J, Qu X, Gao J, Yang X, Wang X, Wang M (2023) Unified multi-modal unsupervised representation learning for skeleton-based action understanding. In: ACM MM
- Sun X, Chen M, Hauptmann A (2009) Action recognition via local descriptors and holistic features. In: CVPRw
- Sun X, Panda R, Chen CFR, Oliva A, Feris R, Saenko K (2021b) Dynamic network quantization for efficient video inference. In: ICCV
- Sun Z, Ke Q, Rahmani H, Bennamoun M, Wang G, Liu J (2022b) Human action recognition from various data modalities: A review. IEEE TPAMI
- Sung J, Ponce C, Selman B, Saxena A (2012) Unstructured human activity detection from rgb-d images. In: ICRA
- Sung YL, Cho J, Bansal M (2022) V1-adapter: Parameter-efficient transfer learning for vision-and-language tasks. In: CVPR
- Surís D, Liu R, Vondrick C (2021) Learning the predictability of the future. In: CVPR
- Takano W, Nakamura Y (2015) Statistical mutual conversion between whole body motion primitives and linguistic sentences for human motions. IJRR
- Tan C, Gao Z, Wu L, Xu Y, Xia J, Li S, Li SZ (2023a) Temporal attention unit: Towards efficient spatiotemporal predictive learning. In: CVPR
- Tan H, Lei J, Wolf T, Bansal M (2021a) Vimpac: Video pre-training via masked token prediction and contrastive learning. arXiv preprint arXiv:210611250
- Tan J, Tang J, Wang L, Wu G (2021b) Relaxed transformer decoders for direct action proposal generation. In: ICCV
- Tan S, Nagarajan T, Grauman K (2023b) Egodistill: Egocentric head motion distillation for efficient video understanding. NeurIPS
- Tang J, Xia J, Mu X, Pang B, Lu C (2020a) Asynchronous interaction aggregation for action detection. In: ECCV
- Tang Y, Ding D, Rao Y, Zheng Y, Zhang D, Zhao L, Lu J, Zhou J (2019) Coin: A large-scale dataset for comprehensive instructional video analysis. In: CVPR
- Tang Y, Ni Z, Zhou J, Zhang D, Lu J, Wu Y, Zhou J (2020b) Uncertainty-aware score distribution learning for action quality assessment. In: CVPR
- Tang Y, Bi J, Xu S, Song L, Liang S, Wang T, Zhang D, An J, Lin J, Zhu R, et al (2023) Video understanding with large language models: A survey. arXiv:231217432
- Tang Y, Dong P, Tang Z, Chu X, Liang J (2024) Vmrrn: Integrating vision mamba and lstm for efficient and accurate spatiotemporal forecasting. In: CVPR
- Taylor GW, Fergus R, LeCun Y, Bregler C (2010) Convolutional learning of spatio-temporal features. In: ECCV
- Teeti I, Bhargav RS, Singh V, Bradley A, Banerjee B, Cuzzolin F (2023) Temporal dino: A self-supervised video strategy to enhance action prediction. In: ICCVW
- Tewari A, Yin T, Cazenavette G, Rezhchikov S, Tenenbaum J, Durand F, Freeman B, Sitzmann V (2023) Diffusion with forward models: Solving stochastic inverse problems without direct supervision. NeurIPS
- Tewel Y, Shalev Y, Nadler R, Schwartz I, Wolf L (2022) Zero-shot video captioning with evolving pseudo-tokens. arXiv:220711100
- Thakur S, Beyan C, Morerio P, Murino V, Del Bue A (2024) Anticipating next active objects for egocentric videos. IEEE Access
- Thangali A, Sclaroff S (2005) Periodic motion detection and estimation via space-time sampling. In: WACV
- Thoker FM, Doughty H, Snoek CGM (2023) Tubelet-contrastive self-supervision for video-efficient generalization. In: ICCV
- Thompson EL, Bird G, Catmur C (2019) Conceptualizing and testing action understanding. NBR
- Thureau C, Hlavác V (2008) Pose primitive based human action recognition in videos or still images. In: CVPR
- Tian X, Zou S, Yang Z, Zhang J (2024a) Argue: Attribute-guided prompt tuning for vision-language models. In: CVPR
- Tian Y, Li D, Xu C (2020) Unified multisensory perception: Weakly-supervised audio-visual video parsing. In: ECCV
- Tian Y, Pang G, Chen Y, Singh R, Verjans JW, Carneiro G (2021a) Weakly-supervised video anomaly detection with robust temporal feature magnitude learning. In: ICCV
- Tian Y, Ren J, Chai M, Olszewski K, Peng X, Metaxas DN, Tulyakov S (2021b) A good image generator is what you need for high-resolution video synthesis. In: ICLR
- Tian Y, Yang L, Yang H, Gao Y, Deng Y, Chen J, Wang X, Yu Z, Tao X, Wan P, et al (2024b) Videotetris: Towards compositional text-to-video generation. arXiv:240604277
- Tirupattur P, Duarte K, Rawat YS, Shah M (2021) Modeling multi-label action dependencies for temporal action localization. In: CVPR
- Toering M, Gatopoulos I, Stol M, Hu VT (2022) Self-supervised video representation learning with cross-stream prototypical contrasting. In: WACV
- Tong Z, Song Y, Wang J, Wang L (2022) Videomae: Masked autoencoders are data-efficient learners for self-supervised video pre-training. NeurIPS
- Torabi A, Tandon N, Sigal L (2016) Learning language-visual embedding for movie understanding with natural-language. arXiv:160908124
- la Torre Frade FD, Hodgins JK, Bargteil AW, Artal XM, Macey JC, Castells ACI, Beltran J (2008) Guide to the carnegie mellon university multimodal activity (cmu-mmact) database. Tech. rep., CMU
- Touvron H, Lavril T, Izacard G, Martinet X, Lachaux MA, Lacroix T, Rozière B, Goyal N, Hambro E, Azhar F, et al (2023) Llama: Open and efficient foundation language models. arXiv:230213971
- Tran D, Bourdev L, Fergus R, Torresani L, Paluri M (2015) Learning spatiotemporal features with 3d convolutional networks. In: ICCV
- Tran D, Wang H, Torresani L, Ray J, LeCun Y, Paluri M (2018) A closer look at spatiotemporal convolutions for action recognition. In: CVPR
- Tran D, Wang H, Torresani L, Feiszli M (2019) Video classification with channel-separated convolutional networks. In: ICCV

- Tran KN, Kakadiaris IA, Shah SK (2012) Part-based motion descriptor image for human action recognition. PR
- Tschernezki V, Darkhalil A, Zhu Z, Fouhey D, Laina I, Larlus D, Damen D, Vedaldi A (2024) Epic fields: Marrying 3d geometry and video understanding. NeurIPS
- Tsuchida S, Fukayama S, Hamasaki M, Goto M (2019) Aist dance video database: Multi-genre, multi-dancer, and multi-camera database for dance information processing. In: ISMIR
- Tu K, Meng M, Lee MW, Choe TE, Zhu SC (2014) Joint video and text parsing for understanding events and answering queries. IEEE MM
- Tu Z, Xie W, Qin Q, Poppe R, Veltkamp RC, Li B, Yuan J (2018) Multi-stream CNN: Learning representations based on human-related regions for action recognition. PR
- Turaga P, Chellappa R, Subrahmanian VS, Udrea O (2008) Machine recognition of human activities: A survey. IEEE TCSVT
- Uithol S, van Rooij I, Bekkering H, Haselager P (2011) Understanding motor resonance. Social neuroscience
- Ullah A, Ahmad J, Muhammad K, Sajjad M, Baik SW (2017) Action recognition in video sequences using deep bi-directional lstm with cnn features. IEEE access
- Ulutan O, Rallapalli S, Srivatsa M, Torres C, Manjunath B (2020) Actor conditioned attention maps for video action detection. In: WACV
- Unterthiner T, van Steenkiste S, Kurach K, Marinier R, Michalski M, Gelly S (2019) Fvd: A new metric for video generation. ICLR
- Upadhyay U, Karthik S, Mancini M, Akata Z (2023) Problm: Probabilistic adapter for frozen vision-language models. In: ICCV
- Utgoff PE (1989) Incremental induction of decision trees. Machine learning
- Vaina LM, Jaulent MC (1991) Object structure and action requirements: A compatibility model for functional recognition. IJIS
- Valevski D, Leviathan Y, Arar M, Fruchter S (2024) Diffusion models are real-time game engines. arXiv:240814837
- Van Gemeren C, Poppe R, Veltkamp RC (2016) Spatio-temporal detection of fine-grained dyadic human interactions. In: HBU
- Varol G, Laptev I, Schmid C (2017) Long-term temporal convolutions for action recognition. IEEE TPAMI
- Villegas R, Yang J, Zou Y, Sohn S, Lin X, Lee H (2017) Learning to generate long-term future via hierarchical prediction. In: ICML
- Villegas R, Erhan D, Lee H, et al (2018) Hierarchical long-term video prediction without supervision. In: ICML
- Villegas R, Babaeizadeh M, Kindermans PJ, Moraldo H, Zhang H, Saffar MT, Castro S, Kunze J, Erhan D (2022) Phenaki: Variable length video generation from open domain textual descriptions. In: ICLR
- Vinciarelli A, Pantic M, Heylen D, Pelachaud C, Poggi I, D'Errico F, Schroeder M (2012) Bridging the gap between social animal and unsocial machine: A survey of social signal processing. IEEE TAFCC
- Vishwakarma S, Agrawal A (2013) A survey on activity recognition and behavior understanding in video surveillance. TVC
- Voleti V, Jolicœur-Martineau A, Pal C (2022) Mcvd-masked conditional video diffusion for prediction, generation, and interpolation. NeurIPS
- Vondrick C, Pirsivash H, Torralba A (2016a) Anticipating visual representations from unlabeled video. In: CVPR
- Vondrick C, Pirsivash H, Torralba A (2016b) Generating videos with scene dynamics. NeurIPS
- Vondrick C, Shrivastava A, Fathi A, Guadarrama S, Murphy K (2018) Tracking emerges by colorizing videos. In: ECCV
- Walker J, Doersch C, Gupta A, Hebert M (2016) An uncertain future: Forecasting from static images using variational autoencoders. In: ECCV
- Walmer M, Suri S, Gupta K, Shrivastava A (2023) Teaching matters: Investigating the role of supervision in vision transformers. In: CVPR
- Wang B, Ma L, Zhang W, Liu W (2018a) Reconstruction network for video captioning. In: CVPR
- Wang B, Zhao Y, Yang L, Long T, Li X (2023a) Temporal action localization in the deep learning era: A survey. IEEE TPAMI
- Wang FY, Chen W, Song G, Ye HJ, Liu Y, Li H (2023b) Gen-l-video: Multi-text to long video generation via temporal denoising. arXiv:230518264
- Wang G, Wang Y, Qin J, Zhang D, Bao X, Huang D (2022a) Video anomaly detection by solving decoupled spatio-temporal jigsaw puzzles. In: ECCV
- Wang H, Schmid C (2013) Action recognition with improved trajectories. In: ICCV
- Wang H, Kläser A, Schmid C, Liu CL (2013) Dense trajectories and motion boundary descriptors for action recognition. IJCV
- Wang J, Cherian A (2019) Gods: Generalized one-class discriminative subspaces for anomaly detection. In: ICCV
- Wang J, Liu Z, Wu Y, Yuan J (2014) Learning actionlet ensemble for 3d human action recognition. IEEE TPAMI
- Wang J, Jiang W, Ma L, Liu W, Xu Y (2018b) Bidirectional attentive fusion with context gating for dense video captioning. In: CVPR
- Wang J, Jiao J, Liu YH (2020a) Self-supervised video representation learning by pace prediction. In: ECCV
- Wang J, Ma L, Jiang W (2020b) Temporally grounding language queries in videos by contextual boundary-aware prediction. In: AAAI
- Wang J, Gao Y, Li K, Hu J, Jiang X, Guo X, Ji R, Sun X (2021a) Enhancing unsupervised video representation learning by decoupling the scene and the motion. In: AAAI
- Wang J, Dasari S, Srirama MK, Tulsiani S, Gupta A (2023c) Manipulate by seeing: Creating manipulation controllers from pre-trained representations. In: ICCV
- Wang J, Chen D, Luo C, He B, Yuan L, Wu Z, Jiang YG (2024a) Omnivid: A generative framework for universal video understanding. In: CVPR
- Wang L, Li Y, Lazebnik S (2016a) Learning deep structure-preserving image-text embeddings. In: CVPR
- Wang L, Xiong Y, Wang Z, Qiao Y, Lin D, Tang X, Van Gool L (2016b) Temporal segment networks: Towards good practices for deep action recognition. In: ECCV
- Wang L, Xiong Y, Lin D, Van Gool L (2017a) Untrimmednets for weakly supervised action recognition and detection. In: CVPR
- Wang L, Li W, Li W, Van Gool L (2018c) Appearance-and-relation networks for video classification. In: CVPR
- Wang L, Huang B, Zhao Z, Tong Z, He Y, Wang Y, Wang Y, Qiao Y (2023d) Videomae v2: Scaling video masked autoencoders with dual masking. In: CVPR
- Wang M, Ni B, Yang X (2017b) Recurrent modeling of interaction context for collective activity recognition. In: CVPR
- Wang P, Li W, Ogunbona P, Wan J, Escalera S (2018d) Rgb-d-based human motion recognition with deep learning: A survey. CVIU
- Wang Q, Zhao L, Yuan L, Liu T, Peng X (2023e) Learning from semantic alignment between unpaired multiviews for ego-centric video recognition. In: ICCV
- Wang R, Chen D, Wu Z, Chen Y, Dai X, Liu M, Jiang YG, Zhou L, Yuan L (2022b) Bevt: Bert pretraining of video transformers. In: CVPR

- Wang R, Chen D, Wu Z, Chen Y, Dai X, Liu M, Yuan L, Jiang YG (2023f) Masked video distillation: Rethinking masked feature modeling for self-supervised video representation learning. In: CVPR
- Wang W, Tran D, Feiszli M (2020c) What makes training multi-modal classification networks hard? In: CVPR
- Wang W, Bao H, Dong L, Bjorck J, Peng Z, Liu Q, Aggarwal K, Mohammed OK, Singhal S, Som S, et al (2022c) Image as a foreign language: Beit pretraining for all vision and vision-language tasks. arXiv:220810442
- Wang W, Chang F, Zhang J, Yan R, Liu C, Wang B, Shou MZ (2023g) Magi-net: Meta negative network for early activity prediction. IEEE T-IP
- Wang X, Gupta A (2018) Videos as space-time region graphs. In: ECCV
- Wang X, Girshick R, Gupta A, He K (2018e) Non-local neural networks. In: CVPR
- Wang X, Hu JF, Lai JH, Zhang J, Zheng WS (2019a) Progressive teacher-student learning for early action prediction. In: CVPR
- Wang X, Wu J, Chen J, Li L, Wang YF, Wang WY (2019b) Vatex: A large-scale, high-quality multilingual dataset for video-and-language research. In: CVPR
- Wang X, Yuan H, Zhang S, Chen D, Wang J, Zhang Y, Shen Y, Zhao D, Zhou J (2023h) Videocomposer: Compositional video synthesis with motion controllability. NeurIPS
- Wang X, Misra I, Zeng Z, Girdhar R, Darrell T (2024b) Videocutler: Surprisingly simple unsupervised video instance segmentation. In: CVPR
- Wang X, Zhang S, Yuan H, Qing Z, Gong B, Zhang Y, Shen Y, Gao C, Sang N (2024c) A recipe for scaling up text-to-video generation with text-free videos. In: CVPR
- Wang Y, Huang K, Tan T (2007) Human activity recognition based on r transform. In: CVPR
- Wang Y, Long M, Wang J, Yu PS (2017c) Spatiotemporal pyramid network for video action recognition. In: CVPR
- Wang Y, Gao Z, Long M, Wang J, Philip SY (2018f) Predrnn++: Towards a resolution of the deep-in-time dilemma in spatiotemporal predictive learning. In: ICML
- Wang Y, Wu J, Long M, Tenenbaum JB (2020d) Probabilistic video prediction from noisy data with a posterior confidence. In: CVPR
- Wang Y, Chen Z, Jiang H, Song S, Han Y, Huang G (2021b) Adaptive focus for efficient video recognition. In: ICCV
- Wang Y, Yue Y, Lin Y, Jiang H, Lai Z, Kulikov V, Orlov N, Shi H, Huang G (2022d) Adafocus v2: End-to-end training of spatial dynamic networks for video recognition. In: CVPR
- Wang Y, Yue Y, Xu X, Hassani A, Kulikov V, Orlov N, Song S, Shi H, Huang G (2022e) Adafocusv3: On unified spatial-temporal dynamic video recognition. In: ECCV
- Wang Y, Cui Z, Li Y (2023i) Distribution-consistent modal recovering for incomplete multimodal learning. In: ICCV
- Wang Y, Jiang L, Loy CC (2023j) Styleinv: A temporal style modulated inversion network for unconditional video generation. In: ICCV
- Wang Y, Li K, Li X, Yu J, He Y, Chen G, Pei B, Zheng R, Xu J, Wang Z, et al (2024d) Internvideo2: Scaling video foundation models for multimodal video understanding. arXiv:240315377
- Wang Z, Wang L, Wu T, Li T, Wu G (2022f) Negative sample matters: A renaissance of metric learning for temporal grounding. In: AAAI
- Wei C, Fan H, Xie S, Wu CY, Yuille A, Feichtenhofer C (2022a) Masked feature prediction for self-supervised visual pre-training. In: CVPR
- Wei D, Lim JJ, Zisserman A, Freeman WT (2018) Learning and using the arrow of time. In: CVPR
- Wei J, Luo G, Li B, Hu W (2022b) Inter-intra cross-modality self-supervised video representation learning by contrastive clustering. In: ICPR
- Wei J, Wang X, Schuurmans D, Bosma M, Xia F, Chi E, Le QV, Zhou D, et al (2022c) Chain-of-thought prompting elicits reasoning in large language models. NeurIPS
- Wei Y, Zhang S, Qing Z, Yuan H, Liu Z, Liu Y, Zhang Y, Zhou J, Shan H (2024) Dreamvideo: Composing your dream videos with customized subject and motion. In: CVPR
- Weinland D, Özuysal M, Fua P (2010) Making action recognition robust to occlusions and viewpoint changes. In: ECCV
- Weinland D, Ronfard R, Boyer E (2011) A survey of vision-based methods for action representation, segmentation and recognition. CVIU
- Weinzaepfel P, Harchaoui Z, Schmid C (2015) Learning to track for spatio-temporal action localization. In: ICCV
- Weinzaepfel P, Martin X, Schmid C (2016) Towards weakly-supervised action localization. arXiv:160505197
- Weissenborn D, Täckström O, Uszkoreit J (2020) Scaling autoregressive video models. In: ICLR
- Wong SF, Cipolla R (2007) Extracting spatiotemporal interest points using global information. In: ICCV
- Woo S, Lee S, Park Y, Nugroho MA, Kim C (2023) Towards good practices for missing modality robust action recognition. In: AAAI
- Wray M, Larlus D, Csurka G, Damen D (2019) Fine-grained action retrieval through multiple parts-of-speech embeddings. In: CVPR
- Wray M, Doughty H, Damen D (2021) On semantic similarity in video retrieval. In: CVPR
- Wren CR, Azarbayejani A, Darrell T, Pentland AP (1997) Pfnder: Real-time tracking of the human body. IEEE TPAMI
- Wu C, Zhang J, Savarese S, Saxena A (2015) Watch-n-patch: Unsupervised understanding of actions and relations. In: CVPR
- Wu C, Huang L, Zhang Q, Li B, Ji L, Yang F, Sapiro G, Duan N (2021a) Godiva: Generating open-domain videos from natural descriptions. rXiv:210414806
- Wu C, Liang J, Ji L, Yang F, Fang Y, Jiang D, Duan N (2022a) Nüwa: Visual synthesis pre-training for neural visual world creation. In: ECCV
- Wu CY, Feichtenhofer C, Fan H, He K, Krahenbuhl P, Girshick R (2019a) Long-term feature banks for detailed video understanding. In: CVPR
- Wu CY, Li Y, Mangalam K, Fan H, Xiong B, Malik J, Feichtenhofer C (2022b) Memvit: Memory-augmented multiscale vision transformer for efficient long-term video recognition. In: CVPR
- Wu H, Wang X (2021) Contrastive learning of image representations with cross-video cycle-consistency. In: ICCV
- Wu H, Yao Z, Wang J, Long M (2021b) Motionrnn: A flexible model for video prediction with spatetime-varying motions. In: CVPR
- Wu H, Chen K, Liu H, Zhuge M, Li B, Qiao R, Shu X, Gan B, Xu L, Ren B, et al (2023a) Newsnet: A novel dataset for hierarchical temporal segmentation. In: CVPR
- Wu H, Li D, Chen B, Li J (2024a) Longvideobench: A benchmark for long-context interleaved video-language understanding. NeurIPS
- Wu JZ, Ge Y, Wang X, Lei SW, Gu Y, Shi Y, Hsu W, Shan Y, Qie X, Shou MZ (2023b) Tune-a-video: One-shot tuning of image diffusion models for text-to-video generation. In: CVPR
- Wu P, Liu J, Shi Y, Sun Y, Shao F, Wu Z, Yang Z (2020a) Not only look, but also listen: Learning multimodal violence detection under weak supervision. In: ECCV
- Wu Q, Yang T, Liu Z, Wu B, Shan Y, Chan AB (2023c) Drop-mae: Masked autoencoders with spatial-attention dropout

- for tracking tasks. In: CVPR
- Wu Q, Cui R, Li Y, Zhu H (2024b) Haltingvt: Adaptive token halting transformer for efficient video recognition. In: ICASSP
- Wu R, Lin H, Qi X, Jia J (2020b) Memory selection network for video propagation. In: ECCV
- Wu T, Cao M, Gao Z, Wu G, Wang L (2023d) Stmixer: A one-stage sparse action detector. In: CVPR
- Wu X, Wang R, Hou J, Lin H, Luo J (2021c) Spatial-temporal relation reasoning for action prediction in videos. IJCV
- Wu X, Zhao J, Wang R (2021d) Anticipating future relations via graph growing for action prediction. In: AAAI
- Wu Y, Yang Y (2021) Exploring heterogeneous clues for weakly-supervised audio-visual video parsing. In: CVPR
- Wu Y, Zhu L, Wang X, Yang Y, Wu F (2020c) Learning to anticipate egocentric actions by imagination. IEEE T-IP
- Wu Z, Xiong C, Jiang YG, Davis LS (2019b) Liteeval: A coarse-to-fine framework for resource efficient video recognition. NeurIPS
- Wu Z, Xiong C, Ma CY, Socher R, Davis LS (2019c) Adaframe: Adaptive frame selection for fast video recognition. In: CVPR
- Wu Z, Li H, Xiong C, Jiang YG, Davis LS (2020d) A dynamic frame selection framework for fast video recognition. IEEE TPAMI
- Xia B, Wang Z, Wu W, Wang H, Han J (2022a) Temporal saliency query network for efficient video recognition. In: ECCV
- Xia B, Wu W, Wang H, Su R, He D, Yang H, Fan X, Ouyang W (2022b) Nsnet: Non-saliency suppression sampler for efficient video recognition. In: ECCV
- Xiao F, Lee YJ, Grauman K, Malik J, Feichtenhofer C (2020) Audiovisual slowfast networks for video recognition. arXiv:200108740
- Xiao F, Kundu K, Tighe J, Modolo D (2022) Hierarchical self-supervised representation learning for movie understanding. In: CVPR
- Xiao J, Shang X, Yao A, Chua TS (2021) Next-qa: Next phase of question-answering to explaining temporal actions. In: CVPR
- Xiao J, Zhou P, Yao A, Li Y, Hong R, Yan S, Chua TS (2023) Contrastive video question answering via video graph transformer. IEEE TPAMI
- Xiao J, Yao A, Li Y, Chua TS (2024) Can i trust your answer? visually grounded video question answering. In: CVPR
- Xie J, Han T, Bain M, Nagrani A, Varol G, Xie W, Zisserman A (2024) Autoad-zero: A training-free framework for zero-shot audio description. In: ACCV
- Xing Z, Dai Q, Hu H, Chen J, Wu Z, Jiang YG (2023) Svformer: Semi-supervised video transformer for action recognition. In: CVPR
- Xiong Y, Zhao Y, Wang L, Lin D, Tang X (2017) A pursuit of temporal accuracy in general activity detection. arXiv:170302716
- Xiong Y, Ren M, Zeng W, Urtasun R (2021) Self-supervised representation learning from flow equivariance. In: ICCV
- Xu D, Ricci E, Yan Y, Song J, Sebe N (2015a) Learning deep representations of appearance and motion for anomalous event detection. In: BMVC
- Xu D, Zhao Z, Xiao J, Wu F, Zhang H, He X, Zhuang Y (2017a) Video question answering via gradually refined attention over appearance and motion. In: MM
- Xu D, Xiao J, Zhao Z, Shao J, Xie D, Zhuang Y (2019a) Self-supervised spatiotemporal learning via video clip order prediction. In: CVPR
- Xu H, Das A, Saenko K (2017b) R-c3d: Region convolutional 3d network for temporal activity detection. In: ICCV
- Xu H, He K, Plummer BA, Sigal L, Sclaroff S, Saenko K (2019b) Multilevel language and vision integration for text-to-clip retrieval. In: AAAI
- Xu H, Ghosh G, Huang PY, Okhonko D, Aghajanyan A, Metzger F, Zettlemoyer L, Feichtenhofer C (2021) Videoclip: Contrastive pre-training for zero-shot video-text understanding. In: EMNLP
- Xu H, Ye Q, Yan M, Shi Y, Ye J, Xu Y, Li C, Bi B, Qian Q, Wang W, et al (2023a) mplug-2: A modularized multi-modal foundation model across text, image and video. In: ICML
- Xu J, Wang X (2021) Rethinking self-supervised correspondence learning: A video frame-level similarity perspective. In: ICCV
- Xu J, Mei T, Yao T, Rui Y (2016) Msr-vtt: A large video description dataset for bridging video and language. In: CVPR
- Xu R, Xiong C, Chen W, Corso J (2015b) Jointly modeling deep video and compositional text to bridge vision and language in a unified framework. In: AAAI
- Xu W, Yu J, Miao Z, Wan L, Ji Q (2019c) Prediction-cgan: Human action prediction with conditional generative adversarial networks. In: MM
- Xu X, Li YL, Lu C (2023b) Dynamic context removal: A general training strategy for robust models on video action predictive tasks. IJCV
- Xu Z, Qing L, Miao J (2015c) Activity auto-completion: Predicting human activities from partial videos. In: CVPR
- Xue H, Hang T, Zeng Y, Sun Y, Liu B, Yang H, Fu J, Guo B (2022) Advancing high-resolution video-language representation with large-scale video transcriptions. In: CVPR
- Xue Z, Marculescu R (2023) Dynamic multimodal fusion. In: CVPR
- Xue Z, Song Y, Grauman K, Torresani L (2023) Egocentric video task translation. In: CVPR
- Xue Z, Ashutosh K, Grauman K (2024) Learning object state changes in videos: An open-world perspective. In: CVPR
- Yan L, Han C, Xu Z, Liu D, Wang Q (2023a) Prompt learns prompt: Exploring knowledge-aware generative prompt collaboration for video captioning. In: IJCAI
- Yan S, Xiong X, Arnab A, Lu Z, Zhang M, Sun C, Schmid C (2022) Multiview transformers for video recognition. In: CVPR
- Yan S, Xiong X, Nagrani A, Arnab A, Wang Z, Ge W, Ross D, Schmid C (2023b) Unloc: A unified framework for video localization tasks. In: ICCV
- Yan W, Zhang Y, Abbeel P, Srinivas A (2021) Videogpt: Video generation using vq-vae and transformers. arXiv:210410157
- Yan W, Hafner D, James S, Abbeel P (2023c) Temporally consistent transformers for video generation. In: ICML
- Yan X, Rastogi A, Villegas R, Sunkavalli K, Shechtman E, Hadap S, Yumer E, Lee H (2018) Mt-vae: Learning motion transformations to generate multimodal human dynamics. In: ECCV
- Yan X, Misra I, Gupta A, Ghadiyaram D, Mahajan D (2020) Clusterfit: Improving generalization of visual representations. In: CVPR
- Yang A, Miech A, Sivic J, Laptev I, Schmid C (2021a) Just ask: Learning to answer questions from millions of narrated videos. In: CVPR
- Yang A, Miech A, Sivic J, Laptev I, Schmid C (2022a) Tuber: Spatio-temporal video grounding with transformers. In: CVPR
- Yang A, Miech A, Sivic J, Laptev I, Schmid C (2022b) Zero-shot video question answering via frozen bidirectional language models. NeurIPS
- Yang A, Nagrani A, Seo PH, Miech A, Pont-Tuset J, Laptev I, Sivic J, Schmid C (2023a) Vid2seq: Large-scale pretraining of a visual language model for dense video captioning. In: CVPR
- Yang A, Nagrani A, Laptev I, Sivic J, Schmid C (2024a) Vidchapters-7m: Video chapters at scale. NeurIPS

- Yang C, Xu Y, Dai B, Zhou B (2020a) Video representation learning with visual tempo consistency. arXiv:200615489
- Yang C, Xu Y, Shi J, Dai B, Zhou B (2020b) Temporal pyramid network for action recognition. In: CVPR
- Yang D, Liu Y (2024) Active object detection with knowledge aggregation and distillation from large models. In: CVPR
- Yang H, Ren Z, Yuan H, Xu Z, Zhou J (2023b) Contrastive self-supervised representation learning without negative samples for multimodal human action recognition. *Frontiers in Neuroscience*
- Yang J, Bisk Y, Gao J (2021b) Taco: Token-aware cascade contrastive learning for video-text alignment. In: ICCV
- Yang M, Du Y, Ghasemipour K, Tompson J, Schuurmans D, Abbeel P (2023c) Learning interactive real-world simulators. arXiv:231006114
- Yang P, Hu VT, Mettes P, Snoek CGM (2020c) Localizing the common action among a few videos. In: ECCV
- Yang S, Zhang L, Liu Y, Jiang Z, He Y (2023d) Video diffusion models with local-global context guidance. In: IJCAI
- Yang X, Yang X, Liu MY, Xiao F, Davis LS, Kautz J (2019) Step: Spatio-temporal progressive learning for video action detection. In: CVPR
- Yang Z, Liu J, Wu P (2024b) Text prompt with normality guidance for weakly supervised video anomaly detection. In: CVPR
- Yao B, Fei-Fei L (2010) Modeling mutual context of object and human pose in human-object interaction activities. In: CVPR
- Yao G, Lei T, Zhong J (2019) A review of convolutional-neural-network-based action recognition. *PRL*
- Yao T, Zhang Y, Qiu Z, Pan Y, Mei T (2021) Seco: Exploring sequence supervision for unsupervised representation learning. In: AAAI
- Yao Z, Cheng X, Zou Y (2023) PoseRAC: Pose Saliency Transformer for Repetitive Action Counting. arXiv:230308450
- Ye H, Li G, Qi Y, Wang S, Huang Q, Yang MH (2022) Hierarchical modular network for video captioning. In: CVPR
- Ye X, Bilodeau GA (2022) Vptr: Efficient transformers for video prediction. In: ICPR
- Ye X, Bilodeau GA (2023) A unified model for continuous conditional video prediction. In: CVPRw
- Ye X, Bilodeau GA (2024) Stdiff: Spatio-temporal diffusion for continuous stochastic video prediction. In: AAAI
- Ye Y, Zhao Z, Li Y, Chen L, Xiao J, Zhuang Y (2017) Video question answering via attribute-augmented attention network learning. In: SIGIR
- Yeung S, Russakovsky O, Mori G, Fei-Fei L (2016) End-to-end learning of action detection from frame glimpses in videos. In: CVPR
- Yeung S, Russakovsky O, Jin N, Andriluka M, Mori G, Fei-Fei L (2018) Every moment counts: Dense detailed labeling of actions in complex videos. *IJCV*
- Yilmaz A, Shah M (2006) Matching actions in presence of camera motion. *CVIU*
- Yilmaz A, Javed O, Shah M (2006) Object tracking: A survey. *CSUR*
- Yin S, Wu C, Yang H, Wang J, Wang X, Ni M, Yang Z, Li L, Liu S, Yang F, et al (2023) Nuwa-xl: Diffusion over diffusion for extremely long video generation. arXiv:230312346
- Ying K, Meng F, Wang J, Li Z, Lin H, Yang Y, Zhang H, Zhang W, Lin Y, Liu S, et al (2024) Mmt-bench: A comprehensive multimodal benchmark for evaluating large vision-language models towards multitask agi. arXiv:240416006
- Yoon JS, Kim K, Gallo O, Park HS, Kautz J (2020) Novel view synthesis of dynamic scenes with globally coherent depths from a monocular camera. In: CVPR
- Yu J, Wang Z, Vasudevan V, Yeung L, Seyedhosseini M, Wu Y (2022a) Coca: Contrastive captioners are image-text foundation models. arXiv:220501917
- Yu J, Li X, Zhao X, Zhang H, Wang YX (2023a) Video state-changing object segmentation. In: ICCV
- Yu J, Zhuge Y, Zhang L, Hu P, Wang D, Lu H, He Y (2024a) Boosting continual learning of vision-language models via mixture-of-experts adapters. In: CVPR
- Yu S, Tack J, Mo S, Kim H, Kim J, Ha JW, Shin J (2022b) Generating videos with dynamics-aware implicit generative adversarial networks. In: ICLR
- Yu S, Cho J, Yadav P, Bansal M (2023b) Self-chained image-language model for video localization and question answering. *NeurIPS*
- Yu S, Sohn K, Kim S, Shin J (2023c) Video probabilistic diffusion models in projected latent space. In: CVPR
- Yu S, Nie W, Huang DA, Li B, Shin J, Anandkumar A (2024b) Efficient video diffusion models via content-frame motion-latent decomposition. In: ICLR
- Yu X, Rosing T, Guo Y (2024c) Evolve: Enhancing unsupervised continual learning with multiple experts. In: WACV
- Yu Y, Chung J, Yun H, Kim J, Kim G (2021) Transitional adaptation of pretrained models for visual storytelling. In: CVPR
- Yue-Hei Ng J, Hausknecht M, Vijayanarasimhan S, Vinyals O, Monga R, Toderici G (2015) Beyond short snippets: Deep networks for video classification. In: CVPR
- Zaheer MZ, Mahmood A, Astrid M, Lee SI (2020a) Claws: Clustering assisted weakly supervised learning with normalcy suppression for anomalous event detection. In: ECCV
- Zaheer MZ, Mahmood A, Shin H, Lee SI (2020b) A self-reasoning framework for anomaly detection using video-level labels. *IEEE SPL*
- Zanella L, Menapace W, Mancini M, Wang Y, Ricci E (2024) Harnessing large language models for training-free video anomaly detection. In: CVPR
- Zatsarynna O, Abu Farha Y, Gall J (2021) Multi-modal temporal convolutional network for anticipating actions in egocentric videos. In: CVPRw, pp 2249–2258
- Zatsarynna O, Bahrami E, Farha YA, Francesca G, Gall J (2024) Gated temporal diffusion for stochastic long-term dense anticipation. In: ECCV
- Zbontar J, Jing L, Misra I, LeCun Y, Deny S (2021) Barlow twins: Self-supervised learning via redundancy reduction. In: ICML
- Zellers R, Lu X, Hessel J, Yu Y, Park JS, Cao J, Farhadi A, Choi Y (2021) Merlot: Multimodal neural script knowledge models. *NeurIPS*
- Zellers R, Lu J, Lu X, Yu Y, Zhao Y, Salehi M, Kusupati A, Hessel J, Farhadi A, Choi Y (2022) Merlot reserve: Neural script knowledge through vision and language and sound. In: CVPR
- Zelnik-Manor L, Irani M (2001) Event-based analysis of video. In: CVPR
- Zeng KH, Chen TH, Chuang CY, Liao YH, Niebles JC, Sun M (2017) Leveraging video descriptions to learn video question answering. In: AAAI
- Zeng R, Huang W, Tan M, Rong Y, Zhao P, Huang J, Gan C (2019) Graph convolutional networks for temporal action localization. In: ICCV
- Zeng Y, Wei G, Zheng J, Zou J, Wei Y, Zhang Y, Li H (2024) Make pixels dance: High-dynamic video generation. In: CVPR
- Zha X, Zhu W, Xun L, Yang S, Liu J (2021) Shifted chunk transformer for spatio-temporal representational learning. *NeurIPS*
- Zhai Y, Wang L, Tang W, Zhang Q, Yuan J, Hua G (2020) Two-stream consensus network for weakly-supervised temporal action localization. In: ECCV
- Zhang B, Wang L, Wang Z, Qiao Y, Wang H (2016) Real-time action recognition with enhanced motion vector cnns. In:

- CVPR
- Zhang C, Cao M, Yang D, Chen J, Zou Y (2021a) Cola: Weakly-supervised temporal action localization with snippet contrastive learning. In: CVPR
- Zhang C, Yang T, Weng J, Cao M, Wang J, Zou Y (2022a) Unsupervised pre-training for temporal action localization tasks. In: CVPR
- Zhang CL, Wu J, Li Y (2022b) Actionformer: Localizing moments of actions with transformers. In: ECCV
- Zhang D, Dai X, Wang X, Wang YF, Davis LS (2019a) Man: Moment alignment network for natural language moment retrieval via iterative graph adjustment. In: CVPR
- Zhang H, Xu X, Han G, He S (2020) Context-aware and scale-insensitive temporal repetition counting. In: CVPR
- Zhang H, Sun A, Jing W, Nan G, Zhen L, Zhou JT, Goh RSM (2021b) Video corpus moment retrieval with contrastive learning. In: SIGIR
- Zhang H, Sun A, Jing W, Zhen L, Zhou JT, Goh RSM (2021c) Natural language video localization: A revisit in span-based question answering framework. IEEE TPAMI
- Zhang H, Li X, Bing L (2023a) Video-llama: An instruction-tuned audio-visual language model for video understanding. In: EMNLP
- Zhang H, Liu D, Zheng Q, Su B (2023b) Modeling video as stochastic processes for fine-grained video representation learning. In: CVPR
- Zhang HB, Zhang YX, Zhong B, Lei Q, Yang L, Du JX, Chen DS (2019b) A comprehensive survey of vision-based human action recognition methods. Sensors
- Zhang J, Qing L, Miao J (2019c) Temporal convolutional network with complementary inner bag loss for weakly supervised anomaly detection. In: ICIP
- Zhang L, Rao A, Agrawala M (2023c) Adding conditional control to text-to-image diffusion models. In: ICCV
- Zhang R, Isola P, Efros AA, Shechtman E, Wang O (2018) The unreasonable effectiveness of deep features as a perceptual metric. In: CVPR
- Zhang R, Fang R, Zhang W, Gao P, Li K, Dai J, Qiao Y, Li H (2021d) Tip-adapter: Training-free clip-adapter for better vision-language modeling. arXiv:211103930
- Zhang R, Han J, Liu C, Gao P, Zhou A, Hu X, Yan S, Lu P, Li H, Qiao Y (2024a) Llama-adapter: Efficient fine-tuning of language models with zero-init attention. ICLR
- Zhang W, Zhu M, Derpanis KG (2013) From actemes to action: A strongly-supervised representation for detailed action understanding. In: ICCV
- Zhang W, Wan C, Liu T, Tian X, Shen X, Ye J (2024b) Enhanced motion-text alignment for image-to-video transfer learning. In: CVPR
- Zhang X, Yoon J, Bansal M, Yao H (2024c) Multimodal representation learning by alternating unimodal adaptation. In: CVPR
- Zhang Y, Tokmakov P, Hebert M, Schmid C (2019d) A structured model for action detection. In: CVPR
- Zhang Y, Shao L, Snoek CGM (2021e) Repetitive Activity Counting by Sight and Sound. In: CVPR
- Zhang Y, Bai Y, Wang H, Xu Y, Fu Y (2022c) Look more but care less in video recognition. NeurIPS
- Zhang Y, Po LM, Xu X, Liu M, Wang Y, Ou W, Zhao Y, Yu WY (2022d) Contrastive spatio-temporal pretext learning for self-supervised video representation. In: AAAI
- Zhang Y, Chen S, Wang M, Zhang X, Zhu C, Zhang Y, Li X (2023d) Temporal consistent automatic video colorization via semantic correspondence. In: CVPR
- Zhang Y, Doughty H, Snoek CGM (2023e) Learning unseen modality interaction. In: NeurIPS
- Zhang Y, Li J, Liu L, Qiang W (2024d) Rethinking misalignment in vision-language model adaptation from a causal perspective. NeurIPS
- Zhang Z, Hu J, Cheng W, Paudel D, Yang J (2024e) Extedm: Distribution extrapolation diffusion model for video prediction. In: CVPR
- Zhao B, Fei-Fei L, Xing EP (2011) Online detection of unusual events in videos via dynamic sparse coding. In: CVPR
- Zhao B, Dirac LP, Varshavskaya P (2024a) Can vision language models learn from visual demonstrations of ambiguous spatial reasoning? arXiv:240917080
- Zhao C, Thabet AK, Ghanem B (2021) Video self-stitching graph network for temporal action localization. In: ICCV
- Zhao C, Liu S, Mangalam K, Ghanem B (2023) Re2tal: Rewiring pretrained video backbones for reversible temporal action localization. In: CVPR
- Zhao H, Wildes RP (2019) Spatiotemporal feature residual propagation for action prediction. In: ICCV
- Zhao H, Wildes RP (2020) On diverse asynchronous activity anticipation. In: ECCV
- Zhao H, Gan C, Rouditchenko A, Vondrick C, McDermott J, Torralba A (2018) The sound of pixels. In: ECCV
- Zhao H, Torralba A, Torresani L, Yan Z (2019) Hacs: Human action clips and segments dataset for recognition and temporal localization. In: ICCV
- Zhao J, Snoek CGM (2019) Dance with flow: Two-in-one stream action detection. In: CVPR
- Zhao J, Zhang Y, Li X, Chen H, Shuai B, Xu M, Liu C, Kundu K, Xiong Y, Modolo D, et al (2022) Tuber: Tubelet transformer for video action detection. In: CVPR
- Zhao L, Gundavarapu NB, Yuan L, Zhou H, Yan S, Sun JJ, Friedman L, Qian R, Weyand T, Zhao Y, et al (2024b) Videoprism: A foundational visual encoder for video understanding. ICML
- Zhao Z, Huang B, Xing S, Wu G, Qiao Y, Wang L (2024c) Asymmetric masked distillation for pre-training small foundation models. In: CVPR
- Zhao Z, Huang X, Zhou H, Yao K, Ding E, Wang J, Wang X, Liu W, Feng B (2024d) Skim then focus: Integrating contextual and fine-grained views for repetitive action counting. arXiv:240608814
- Zheng C, Wu W, Chen C, Yang T, Zhu S, Shen J, Kehtarnavaz N, Shah M (2020a) Deep learning-based human pose estimation: A survey. CSUR
- Zheng N, Song X, Su T, Liu W, Yan Y, Nie L (2023) Egocentric early action prediction via adversarial knowledge distillation. ACM TOMM
- Zheng Q, Wang C, Tao D (2020b) Syntax-aware action targeting for video captioning. In: CVPR
- Zhong JX, Li N, Kong W, Liu S, Li TH, Li G (2019) Graph convolutional label noise cleaner: Train a plug-and-play action classifier for anomaly detection. In: CVPR
- Zhong Y, Liang L, Zharkov I, Neumann U (2023a) Mmvp: Motion-matrix-based video prediction. In: ICCV
- Zhong Z, Martin M, Voit M, Gall J, Beyerer J (2023b) A survey on deep learning techniques for action anticipation. arXiv:230917257
- Zhong Z, Schneider D, Voit M, Stiefelwagen R, Beyerer J (2023c) Anticipative feature fusion transformer for multi-modal action anticipation. In: WACV
- Zhou B, Andonian A, Oliva A, Torralba A (2018a) Temporal relational reasoning in videos. In: ECCV
- Zhou F, De la Torre F, Hodgins JK (2013) Hierarchical aligned cluster analysis for temporal clustering of human motion. IEEE TPAMI
- Zhou H, Martín-Martín R, Kapadia M, Savarese S, Niebles JC (2023a) Procedure-aware pretraining for instructional video



- understanding. In: CVPR
- Zhou J, Wang J, Zhang J, Sun W, Zhang J, Birchfield S, Guo D, Kong L, Wang M, Zhong Y (2022) Audio-visual segmentation. In: ECCV
- Zhou L, Xu C, Corso JJ (2018b) Towards automatic learning of procedures from web instructional videos. In: AAAI
- Zhou L, Zhou Y, Corso JJ, Socher R, Xiong C (2018c) End-to-end dense video captioning with masked transformer. In: CVPR
- Zhou X, Arnab A, Buch S, Yan S, Myers A, Xiong X, Nagrani A, Schmid C (2024) Streaming dense video captioning. In: CVPR
- Zhou Y, Berg TL (2015) Temporal perception and prediction in ego-centric video. In: ICCV
- Zhou Y, Sun X, Zha ZJ, Zeng W (2018d) Mict: Mixed 3d/2d convolutional tube for human action recognition. In: CVPR
- Zhou Y, Duan H, Rao A, Su B, Wang J (2023b) Self-supervised action representation learning from partial spatio-temporal skeleton sequences. In: AAAI
- Zhu B, Lin B, Ning M, Yan Y, Cui J, Wang H, Pang Y, Jiang W, Zhang J, Li Z, et al (2024a) Languagebind: Extending video-language pretraining to n-modality by language-based semantic alignment. ICLR 2024
- Zhu L, Yang Y (2020) Actbert: Learning global-local video-text representations. In: CVPR
- Zhu W, Hu J, Sun G, Cao X, Qiao Y (2016) A key volume mining deep framework for action recognition. In: CVPR
- Zhu Y, Newsam S (2019) Motion-aware feature for improved video anomaly detection. In: BMVC
- Zhu Y, Shen X, Xia R (2023) Personality-aware human-centric multimodal reasoning: A new task, dataset and baselines. arXiv:230402313
- Zhu Y, Zhang G, Tan J, Wu G, Wang L (2024b) Dual detr for multi-label temporal action detection. In: CVPR
- Zhuang S, Li K, Chen X, Wang Y, Liu Z, Qiao Y, Wang Y (2024) Vlogger: Make your dream a vlog. In: CVPR
- Zhuo T, Cheng Z, Zhang P, Wong Y, Kankanhalli M (2019) Explainable video action reasoning via prior knowledge and state transitions. In: MM
- Zong M, Wang R, Chen X, Chen Z, Gong Y (2021) Motion saliency based multi-stream multiplier resnets for action recognition. IVC