

POLYOMINOES AND KNUTSON IDEALS

MITRA KOLEY, NIRMAL KOTAL, AND DHARM VEER

ABSTRACT. In this article, we study two fundamental questions on polyomino ideals which are radicality and primality. In order to study the question of radicality, we initiate the study of Knutson ideals among polyominoes. Knutson ideals were introduced by Conca and Varbaro after the work of Knutson on compatibly split ideals. Knutson ideals are known to have nice properties, for example, they are well behaved with Gröbner bases, and it has square-free initial ideals; hence they are radical.

We show that polyomino ideals associated with closed path, weakly closed path, simple thin, and ladder polyominoes are Knutson. We also show that polyomino ideals associated with a class of thin polyominoes are Knutson; hence they are radical. In fact, we show that these polyomino ideals are prime and the reduced Gröbner basis is computed. Furthermore, we prove that under a certain condition, if a parallelogram polyomino is extracted from another parallelogram polyomino, the resulting collection of cells is Knutson. We also compute their Gröbner basis.

1. INTRODUCTION

Polyominoes are plane figures obtained by joining unit squares (cells) edge to edge. They were formally defined by Golomb [Gol54, Gol94]. Polyominoes appear in many recreational mathematics and combinatorics for instance, tiling problem of a certain region or the plane with polyominoes.

In connection with commutative algebra, Qureshi [Qur12] assigns to every polyomino \mathcal{P} the ideal of inner 2-minors, called a polyomino ideal, denoted by $I_{\mathcal{P}}$. The class of polyomino ideals generalizes many known classes of ideals such as the ideal generated by 2-minors of a generic matrix, the ideal generated by 2-minors of one-sided or two-sided ladders, join-meet ideal of a planar distributive lattice. Determinantal ideals and ladder determinantal ideals are well studied in past [Con95, Con96, CH97, Gor07].

Let X be a generic matrix of size $m \times n$. Let I be an ideal generated by an arbitrary set of 2-minors of X , then the natural question arises when I is radical or prime or more generally what is its primary decomposition. The motivation for studying ideals generated by arbitrary sets of 2-minors of a generic matrix comes from algebraic statistics [PRW01, Stu02]: more specifically, a primary decomposition of such ideals helps to measure the connectedness of the set of $m \times n$ contingency tables with the same row and column sums, see [DES98]. In [HHH⁺10] the author showed that if X is a $2 \times n$ matrix and I is an ideal generated by an arbitrary set of 2-minors of X , then I is always radical, in fact it is shown that I has a squarefree initial ideal with respect to graded lexicographic ordering. Moreover the authors also gave a primary decomposition of I . The problem becomes much more challenging if $m, n \geq 3$, as easy examples show that I need not to be radical in general. The class of ideals of adjacent 2-minors are studied in [HS04, HH12, HO06].

Given the preceding, two interesting questions on polyomino ideals are radicality and primality of polyomino ideals. While there are no known examples of polyomino ideals that are not radical, there are polyominoes for which the associated ideal is not prime. We say that a polyomino \mathcal{P} is *prime* (resp. *non-prime*) if the polyomino ideal $I_{\mathcal{P}}$ is prime (resp. non-prime). The question of primality of polyomino ideals were first studied by Qureshi [Qur12], where she

2020 *Mathematics Subject Classification.* 05E40, 05B50, 13P10.

Key words and phrases. Polyominoes, Knutson ideal, ideals of König type.

NK was supported by the Institute of Mathematical Sciences postdoctoral fellowship. DV was supported by AARMS postdoctoral fellowship.

proved that convex polyominoes are prime. Herzog and Madani [HSM14] extended Qureshi's result and established that simple polyominoes are prime. Qureshi et al. [QSS17] showed polyomino ideal of a simple polyomino coincides with the toric ideal of a weakly chordal bipartite graph. Additionally, Hibi-Qureshi [HQ15] and Shikama [Shi18] showed that non-simple polyominoes formed by removing a convex polyomino from a rectangle are prime. Characterizing prime polyominoes is a complex problem, and to tackle it, Mascia et al. [MRR20] introduced the notion of zig-zag walks for polyominoes. They showed [MRR20, Corollary 3.6] that the presence of zig-zag walks indicates that a polyomino is not prime, and they conjectured [MRR20, Conjecture 4.6] that this characteristic characterizes non-prime polyominoes. This conjecture has been confirmed for specific classes of polyominoes, including grid polyominoes [MRR20], closed path polyominoes [CN23], and weakly closed path polyominoes [CNU22b]. Furthermore, Mascia et al. [MRR22] used Gröbner bases to identify certain prime polyominoes. The only known classes of non-prime radical polyomino ideals are closed path polyominoes and weakly closed path polyominoes with zig-zag walks. In [CNV24], Cisto, Navarra and the last author of this paper studied the primary decomposition of non-prime closed path polyomino ideals and established that these polyomino ideals are unmixed.

In recent years, various algebraic properties of algebras associated with polyominoes have been explored by several researchers. For instance, the Hilbert series of these algebras has been examined in [RR21, KV23b, QRR22, KV23a, JN24, CNU23], Cohen-Macaulayness has been investigated in [Qur12, HSM14, CNU22a], and the Gorenstein condition has been studied in [Qur12, EHQR21, RR21, QRR22, CNU23]. Interested readers may refer to [CNV24] for a generalization of polyominoes.

In this article, in order to study radicality of polyomino ideals, we initiate to study Knutson ideals among polyominoes. Knutson ideals were introduced by Conca and Varbaro in [CV20], in prime characteristic which corresponds to compatibly split ideals. In arbitrary characteristic, Knutson ideals have squarefree initial ideals, hence they are radical. Recently it has already been shown that some interesting classes of ideals of minors are Knutson ideals; for instance, determinantal ideals of Hankel matrices [Sec21], generic matrices [Sec22], ideals generated by arbitrary set of 2-minors in a generic $2 \times n$ matrix [Sec23], ladder determinantal ideals [SMNB⁺23]. We say that a polyomino \mathcal{P} is *Knutson* if the polyomino ideal $I_{\mathcal{P}}$ is a Knutson ideal.

We show that simple thin polyominoes, closed path polyominoes, weakly closed path polyominoes, ladder polyominoes, various thin collection of cells are Knutson, hence they are radical. We also compute Gröbner bases for some of these classes of collection of cells. As an intermediate step of showing Knutson for simple thin polyominoes, closed path polyominoes, and weakly closed path polyominoes, we show that they are of König type. Herzog et al. [HHM22] introduced the concept of ideals of König type to examine the Cohen-Macaulay property of their initial ideals, independent of the characteristic of the base field. In this article, we show that the notion of König type can be employed to determine Knutson ideals. Herzog and Hibi [HH23] showed that simple thin polyominoes are of König type. However, we give an example that indicates their argument was not exhaustive; a more general version of their pivotal lemma [HH23, Lemma 5.3] is necessary (see Lemma 3.4). Utilizing this refined lemma, we complete the proof of the theorem which states that simple thin polyominoes are indeed of König type. Dinu and Navarra [DN22] showed that closed path polyominoes are of König type. We show that weakly closed path polyominoes are of König type. Recently, this result was also outlined by Navarra in [Nav24].

We then proceed to show that the ladder polyominoes are Knutson. We also show that when ladder polyominoes are “based on” a parallelogram polyomino, the resulting polyomino is Knutson. Additionally, we compute the reduced Gröbner basis of these polyominoes in a special case. The techniques we develop to prove that ladder polyominoes are Knutson are used throughout this article. Building upon this foundation, we prove that a special class of thin polyominoes is also Knutson. Furthermore, we show that the set of all binomials associated with the inner intervals of these polyominoes forms the reduced Gröbner basis for the polyomino ideals, and consequently, these polyominoes are in fact prime. Using results of [JN24] and

[MRR22], we show that if every non-trivial intersection of two maximal inner intervals in a thin polyomino is a cell, then the polyomino is prime. Next, we show that under a certain condition, if a parallelogram polyomino is extracted from another parallelogram polyomino, the resulting collection of cells is Knutson, and we also compute the reduced Gröbner basis.

The paper is organized as follows: in Section 2, we collect all necessary definitions and results on polyominoes and Knutson ideals. We begin Section 3 by noting that, under certain conditions, ideals of König type are indeed Knutson ideals. Using this observation, we show that polyomino ideals associated with simple thin, closed path, and weakly closed path polyominoes are Knutson ideals, by showing that these polyomino ideals are of König type. In Section 4, we introduce the notion of ladder polyominoes, which are generalization of parallelogram polyominoes. Then, we show that ladder polyominoes are Knutson. In Section 5, we prove that some other class of thin polyominoes are Knutson. Finally in Section 6, we inquire whether extracting a parallelogram polyomino from another parallelogram polyomino is Knutson or not. Under certain hypothesis, we prove that they are Knutson.

2. PRELIMINARIES

2.1. Polyominoes. Let $(i, j), (k, l) \in \mathbb{N}^2$. We say that $(i, j) \leq (k, l)$ if $i \leq k$ and $j \leq l$. Consider $a = (i, j)$ and $b = (k, l)$ in \mathbb{N}^2 with $a \leq b$. The set $[a, b] = \{(m, n) \in \mathbb{N}^2 : i \leq m \leq k, j \leq n \leq l\}$ is called an *interval* of \mathbb{N}^2 . In addition, if $i < k$ and $j < l$ then $[a, b]$ is a *proper* interval. In such a case, we say a, b the *diagonal vertices* of $[a, b]$ and $c = (i, l), d = (k, j)$ the *anti-diagonal vertices* of $[a, b]$. Moreover, the elements a, b, c and d are called the *lower-left, upper-right, upper-left* and *lower-right vertices* of $[a, b]$ respectively. We also call $V([a, b]) = \{a, b, c, d\}$ the set of *vertices* of the interval, while the sets $\{a, c\}, \{a, d\}, \{b, d\}, \{b, c\}$ are the *edges* of the interval $[a, b]$.

An interval of the form $C = [a, a + (1, 1)]$ is called a *cell* where $a \in \mathbb{N}$. Let \mathcal{P} be a collection of cells. The *vertex set* of \mathcal{P} is $\bigcup_{C \in \mathcal{P}} V(C)$. Let C and D be two cells of \mathcal{P} . Then, we say C and D are connected, if there is a sequence $\mathcal{C} : C = C_1, \dots, C_m = D$ of cells (starting with C and ending with D) of \mathcal{P} such that $C_i \cap C_{i+1}$ is an edge of both C_i and C_{i+1} for $i = 1, \dots, m-1$. The sequence \mathcal{C} is called a *path* between C and D if $C_i \neq C_j$ for all $i \neq j$. A *polyomino* \mathcal{P} is a non-empty finite collection of cells in $\mathbb{N} \setminus \{0\} \times \mathbb{N} \setminus \{0\}$ where any two cells of \mathcal{P} are connected in \mathcal{P} . A collection of cells (resp. polyomino) \mathcal{P} is called a *sub-collection of cells* (resp. *sub-polyomino*) of \mathcal{P}' , if all the cells of \mathcal{P} are contained in \mathcal{P}' .

A collection of cells \mathcal{P} is called *simple* if for any two cells C and D not in \mathcal{P} there exists a path of cells not in \mathcal{P} from C to D . A polyomino \mathcal{P} is called *horizontally convex* (or row convex), if for any two cells C, D of \mathcal{P} with lower-left vertices $a = (i, j)$ and $b = (k, j)$ respectively, and such that $k > i$, it follows that all cells with left lower corner (l, j) with $i \leq l \leq k$ belong to \mathcal{P} . Similarly, one defines *vertically convex* (or column convex) polyominoes. The polyomino \mathcal{P} is called *convex* if it is horizontally and vertically convex. A convex polyomino \mathcal{P} is said to be a *parallelogram polyomino* if $V(\mathcal{P})$ is a sub-lattice of \mathbb{N}^2 . A proper interval $[a, b]$, for $a, b \in V(\mathcal{P})$ is called an *inner interval* of \mathcal{P} if all cells of $[a, b]$ belong to \mathcal{P} . An inner interval of \mathcal{P} is *maximal* if it is maximal under inclusion. An interval $[a, b]$ with $a = (i, j)$ and $b = (k, l)$ with $k > i$ is called a *horizontal edge interval* of \mathcal{P} if $j = l$ and the sets $\{(r, j), (r+1, j)\}$ for $r = i, \dots, k-1$ are edges of cells of \mathcal{P} . Similarly, one defines *vertical edge interval* of \mathcal{P} .

A collection of cells \mathcal{P} is *thin* if it does not have a 2×2 square such as the one shown in Figure 1. Let $C, D \in \mathcal{P}$. We say that C is a *neighbour* of D if $C \cap D$ is an edge of both C and D . Let \mathcal{P} be a simple thin polyomino. A cell C is said to be an *end-cell* of a maximal inner interval I if $C \in I$ and C has exactly one neighbour cell in I . A cell of \mathcal{P} is called *single* if it belongs to exactly one maximal inner interval of \mathcal{P} . Note that an inner interval of \mathcal{P} can take one of two forms: it either has vertices $(i_1, j_1), (i_1 + 1, j_1), (i_1, j_2)$ and $(i_1 + 1, j_2)$ or it has vertices $(i_1, j_1), (i_1, j_1 + 1), (i_2, j_1)$ and $(i_2, j_1 + 1)$ for some $i_1, i_2, j_1, j_2 \in \mathbb{N}$ with $i_1 < i_2$ and $j_1 < j_2$. By the *end-edges* of an inner interval, we refer to the edges $\{(i_1, j_1), (i_1 + 1, j_1)\}$ and $\{(i_1, j_2), (i_1 + 1, j_2)\}$ in the first case, and to the edges $\{(i_1, j_1), (i_1, j_1 + 1)\}$ and $\{(i_2, j_1), (i_2, j_1 + 1)\}$ in the second case.

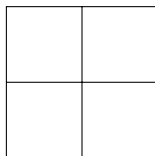

FIGURE 1

To a collection of cell \mathcal{P} , Qureshi [Qur12] associated a finitely generated graded K -algebra $K[\mathcal{P}]$ (over a field K) as follows: Let \mathcal{P} be a collection of cells. Let $S = K[x_a \mid a \in V(\mathcal{P})]$ be the standard graded polynomial ring over a field K . For an inner interval $[a, b]$ of \mathcal{P} , associate a binomial $x_ax_b - x_cx_d$, where c and d are the anti-diagonal vertices of $[a, b]$. Let $I_{\mathcal{P}}$ be the binomial ideal of S generated by the binomials $x_ax_b - x_cx_d$, where $[a, b]$ varies over all inner intervals of \mathcal{P} . We denote by $K[\mathcal{P}]$ the quotient ring $S/I_{\mathcal{P}}$. When \mathcal{P} is a polyomino, the ideal $I_{\mathcal{P}}$ is called the *polyomino ideal* associated with \mathcal{P} . If \mathcal{P} is a simple polyomino, then it is known that $K[\mathcal{P}]$ is a Koszul Cohen-Macaulay normal domain [HSM14, Corollary 2.2], [QSS17, Corollary 2.3].

2.2. Knutson ideals. The notion of Knutson ideals was introduced by Conca and Varbaro after Knutson's work on compatibly split ideals [Knu09]. Our basic references on Knutson ideals are [Knu09, CV20, Sec21].

Definition 2.1 ([CV20]). Let K be a field and $S = K[x_1, \dots, x_n]$ be a polynomial ring. Let $f \in S$ be a polynomial such that its leading term $\text{in}_{<} f$ is a square-free monomial with respect to some monomial order $<$ on S . Define \mathcal{C}_f to be the smallest set of ideals satisfying the following conditions:

- (1) $(f) \in \mathcal{C}_f$;
- (2) If $I \in \mathcal{C}_f$ and J is any ideal in S , then $I : J \in \mathcal{C}_f$; hence all the associated primes of I are in \mathcal{C}_f .
- (3) If I and J are ideals in S such that $I, J \in \mathcal{C}_f$ then $I + J$ and $I \cap J$ must be in \mathcal{C}_f .

An ideal $I \subseteq S$ is called a *Knutson ideal associated to f* if $I \in \mathcal{C}_f$. More generally, an ideal I is called a *Knutson ideal* if $I \in \mathcal{C}_f$ for some f .

Example 2.2. If $f = x_1 \cdots x_n$ then the collection of Knutson ideals \mathcal{C}_f is the set of all squarefree monomial ideals of S .

Remark 2.3. Since Knutson ideals are radical, one can replace the condition (2) of the definition of Knutson ideals by the following:

- (2)' If $I \in \mathcal{C}_f$ then $\mathfrak{p} \in \mathcal{C}_f$ for every $\mathfrak{p} \in \text{Min}(I)$, where $\text{Min}(I)$ denotes the set of minimal primes of I .

Lemma 2.4. Let K be a field and $S = K[x_1, \dots, x_n]$ be a polynomial ring. Let $f, g \in S$ be polynomials such that $\text{in}_{<}(fg)$ is a square-free monomial with respect to some monomial order $<$ on S . Then $\mathcal{C}_f \subseteq \mathcal{C}_{fg}$.

Proof. First note that since $\text{in}_{<}(fg)$ is a square-free monomial, $\text{in}_{<}(f)$ is also a square-free monomial. We also have $(fg) : (g) = (f)$, hence $(f) \in \mathcal{C}_{fg}$. Hence from the construction of Knutson ideals, the proof follows. \square

When the characteristic of the field K is prime and $\deg f = n$, then f defines a splitting of the Frobenius homomorphism $F : S \rightarrow S$. Then one can see that all Knutson ideals associated to f are compatibly split with respect to this map. Hence, Knutson ideals define F -split rings in prime characteristic. Moreover, by the assumption on initial term of f , Knutson ideals have squarefree initial ideals in arbitrary characteristic, hence they are radical [Knu09]. As a consequence the extremal Betti numbers, Castelnuovo-Mumford regularity, and depth of Knutson ideals coincide with those of their initial ideals. Furthermore, Gröbner bases of Knutson

ideals are well-behaved with respect to sums as the union of Gröbner bases of Knutson ideals is a Gröbner basis of their sum. This fact makes computations of Gröbner bases of Knutson ideals easier in many cases. Thus study of Knutson ideals become a useful tool to solve problems in applied algebra.

It has already been shown that some interesting classes of ideals are Knutson ideals for a suitable choice of f ; for instance, ideals defining matrix Schubert varieties, ideals defining Kazhdan-Lusztig varieties [Knu09], determinantal ideals of Hankel matrices [Sec21] and generic matrices [Sec22]. Moreover building upon [Sec22] proved a graph is weakly closed if and only if its binomial edge ideal is a Knutson ideal [Sec23]. Recently in [SMNB⁺23] it is shown that Ladder determinantal ideals are Knutson ideals.

3. KNUTSON THIN POLYOMINOES I

In this section, we start by proving that, under certain conditions, ideals of König type are indeed Knutson ideals. We then apply this result to show that the polyomino ideals associated with simple thin, closed path, and weakly closed path polyominoes are Knutson ideals. We start by giving definition of ideals of König type.

Definition 3.1. [HHM22, Definition 1.1] Let $S = K[x_1, \dots, x_n]$ be a polynomial ring over a field K and I be a homogeneous ideal S of height h . Then I is of *König type* if it satisfies the following conditions:

- (1) there exists a sequence of homogeneous polynomials f_1, \dots, f_h forming part of minimal system of homogeneous generators of I ;
- (2) there exists a monomial order $<$ on S such that $\text{in}_<(f_1), \dots, \text{in}_<(f_h)$ is a regular sequence.

We say that a polyomino \mathcal{P} is of *König type* if the polyomino ideal $I_{\mathcal{P}}$ is of König type.

Proposition 3.2. *Let I be a homogeneous unmixed radical ideal of height h in a polynomial ring S . If I is of König type with respect to f_1, \dots, f_h , and $\text{in}_<(f_i)$ is square-free for all i , then I is Knutson.*

Proof. Let $f = f_1 \cdots f_h$. Since $\text{in}_<(f) = \prod_{i=1}^h \text{in}_<(f_i)$, we get that $\text{in}_<(f)$ is square-free. Note that for each $1 \leq i \leq h$, $(f_i) = (f) : (f/f_i) \in \mathcal{C}_f$. Hence, $(f_1, \dots, f_h) \in \mathcal{C}_f$. Since I is unmixed, every minimal prime of I is also a minimal prime of (f_1, \dots, f_h) ; hence, every minimal prime of I is Knutson with respect to f . Since I is radical, $I = \bigcap_{\mathfrak{p} \in \text{Min}(I)} \mathfrak{p}$, where $\text{Min}(I)$ denotes the set of minimal primes of I ; thus I is Knutson with respect to f . \square

3.1. Simple thin polyominoes. Herzog and Hibi [HH23, Corollary 5.5] showed that every simple thin polyomino is of König type. Their argument relies on the repeated application of [HH23, Lemma 5.4]. In the example provided below, we illustrate that [HH23, Lemma 5.4] in its original form is not sufficient to prove that every simple thin polyomino is of König type. Instead, a more general version of [HH23, Lemma 5.4] is required (see Lemma 3.4), which must be used in a refined manner to complete the proof.

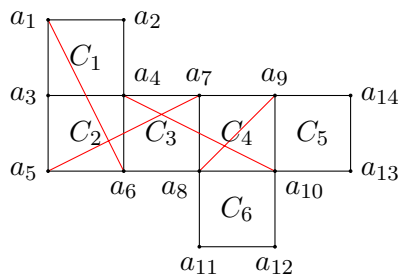

FIGURE 2

Example 3.3. Let \mathcal{P} be the polyomino as shown in Figure 2. We aim to apply [HH23, Lemma 5.4] to examine whether \mathcal{P} is of König type. The algorithm proposed in [HH23] involves beginning at a cell of \mathcal{P} and then adding one cell at a time, with the goal of showing that the resulting polyomino is of König type. We start by considering the cell C_1 . Let $\mathcal{P}_1 = \{C_1\}$ and let $f = x_{a_3}x_{a_2} - x_{a_1}x_{a_4}$, with $<$ denoting the lexicographic order on $S_{\mathcal{P}_1}$ as defined in [HH23, Lemma 5.4], so that $\text{in}_{<}(f) = x_{a_1}x_{a_4}$. Thus, \mathcal{P}_1 is of König type with respect to f .

Define $\mathcal{P}_i = \{C_1, \dots, C_i\}$ for $2 \leq i \leq 4$. By [HH23, Lemma 5.4], \mathcal{P}_i is of König type for all $1 \leq i \leq 4$. Furthermore, \mathcal{P}_4 is of König type with respect to the generators $f_1 = x_{a_5}x_{a_2} - x_{a_1}x_{a_6}$, $f_2 = x_{a_5}x_{a_7} - x_{a_3}x_{a_8}$, $f_3 = x_{a_6}x_{a_9} - x_{a_4}x_{a_{10}}$, $f_4 = x_{a_8}x_{a_9} - x_{a_7}x_{a_{10}}$. The initial terms of f_i 's are denoted by “red” diagonal lines in Figure 2.

We can extend \mathcal{P}_4 to \mathcal{P}_5 by adding either C_5 or C_6 . In both cases, \mathcal{P}_5 remains of König type by [HH23, Lemma 5.4]. Consider the case where $\mathcal{P}_5 = \mathcal{P}_4 \cup \{C_5\}$. In this case, \mathcal{P}_5 is of König type with respect to the generators $f_1, f_2, f_3, f' = x_{a_8}x_{a_{14}} - x_{a_7}x_{a_{13}}$, and $f'' = x_{a_{10}}x_{a_{14}} - x_{a_9}x_{a_{13}}$. However, if we consider $\mathcal{P} = \mathcal{P}_5 \cup \{C_6\}$, we cannot use [HH23, Lemma 5.4] because C_4 does not satisfy the hypothesis of [HH23, Lemma 5.4]; specifically, $x_{a_8}x_{a_9} - x_{a_7}x_{a_{10}}$ is not part of the set of generators required to conclude that \mathcal{P}_5 is of König type. We encounter the same issue if we consider the case $\mathcal{P}_5 = \mathcal{P}_4 \cup \{C_6\}$. \square

Lemma 3.4. *Let \mathcal{P} be a simple thin polyomino of König type with respect to f_1, \dots, f_r under a graded lexicographic order $<$ on S . Let I be a maximal inner interval of \mathcal{P} and C be an end-cell of I , with $a, b \in V(C)$ such that $\{a, b\}$ is an edge of C only in \mathcal{P} (see Figure 3). Assume that $f_r = x_a x_d - x_b x_c$ and $\text{in}_{<}(f_r) = x_a x_d$ for some $c, d \in V(I)$. Let \mathcal{P}' be a simple thin polyomino obtained by adding a cell D to \mathcal{P} with $V(C) \cap V(D) = \{a, b\}$. Write $V(D) = \{a, b, u, v\}$ such that $\{a, u\}$ forms an edge of D . Then \mathcal{P}' is of König type with respect to $f_1, \dots, f_{r-1}, f', f''$, where $f' = x_u x_d - x_v x_c, f'' = x_u x_b - x_v x_a$, under a graded lexicographic order $<'$ on $S' = S[x_u, x_v]$ with $\text{in}_{<'}(f') = x_u x_d, \text{in}_{<'}(f'') = x_u x_b$.*

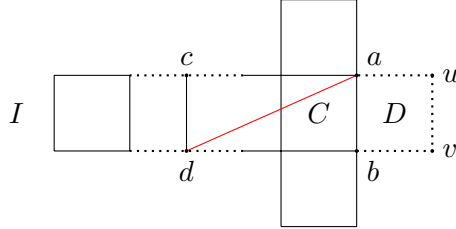

FIGURE 3

Proof. The proof follows the argument of [HH23, Lemma 3.2, 3.3]. \square

Before stating our main theorem of this section, we recall the notion of collapsing a simple thin polyomino in a maximal inner interval, as introduced by Rinaldo and Romeo [RR21, Proposition 3.7]. We define this notion as it appears in [KV23a, Definition 3.2].

Definition 3.5. Let \mathcal{P} be a simple thin polyomino. A *collapse datum* on \mathcal{P} is a tuple (I, J, \mathcal{P}^I) , where I and J are maximal inner intervals and \mathcal{P}^I is a sub-polyomino of \mathcal{P} satisfying the following conditions:

- (1) J is the only maximal inner interval of \mathcal{P} such that $I \cap J$ is a cell;
- (2) $\mathcal{P}^I \subseteq J$ and $I \cap J \not\subseteq \mathcal{P}^I$.
- (3) $\mathcal{P} \setminus (I \cup \mathcal{P}^I)$ is a non-empty sub-polyomino of \mathcal{P} .

When \mathcal{P} has at least two maximal inner intervals, the maximal inner intervals I and J defined in the Definition 3.5 exist by [RR21, Lemma 3.6].

Theorem 3.6. *Every simple thin polyomino is of König type.*

Proof. Let \mathcal{P} be a simple thin polyomino with m number of cells. We proceed by induction on the number of maximal inner intervals of \mathcal{P} and show the following: (#) \mathcal{P} is of König type with respect to f_1, \dots, f_m under a graded lexicographic order $<$ on S such that

(1) if a cell A is both a single cell and an end-cell of a maximal inner interval I of \mathcal{P} , then there exists an $i \in [m]$ such that $f_i = I_A$, where I_A is the polyomino ideal of the cell A ;

(2) for every maximal inner interval I of \mathcal{P} and every end-edge e of I , either there exists a vertex $v \in e$ such that $\gcd(x_v, \text{in}_<(f_i)) = 1$ for all $1 \leq i \leq m$ or there exists an $i \in [m]$ such that f_i correspond to an inner interval in I containing edge e .

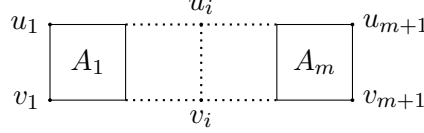

FIGURE 4

First, assume that \mathcal{P} has exactly one maximal inner interval. Then, \mathcal{P} is as shown in Figure 4. Under the notations of Figure 4, $S = K[x_{v_1}, \dots, x_{v_{m+1}}, x_{u_1}, \dots, x_{u_{m+1}}]$. Let $<$ be the lexicographic order on S induced by the ordering $x_{v_1} < \dots < x_{v_{m+1}} < x_{u_1} < \dots < x_{u_{m+1}}$. For $i \in [m]$, define $f_i = x_{v_i}x_{u_{i+1}} - x_{u_i}x_{v_{i+1}}$; then, $\text{in}_<(f_i) = x_{u_{i+1}}x_{v_i}$. Clearly, \mathcal{P} is of König type with respect to f_1, \dots, f_m and satisfies #.

So we may assume that \mathcal{P} has at least two maximal inner interval. Let (I, J, \mathcal{P}^I) be a collapse datum of \mathcal{P} and let $I \cap J = \{C\}$. Let $C_1, \dots, C_r, D_1, \dots, D_s$ be the cells of I different from C . Suppose that C_1 and D_1 are neighbors of C . Furthermore, for all $i \in 1, \dots, r-1$, C_i and C_{i+1} are neighbours, and for all $j \in 1, \dots, s-1$, D_j and D_{j+1} are neighbours. Note that either $\{C_1, \dots, C_r\}$ or $\{D_1, \dots, D_s\}$ may be empty; without loss of generality, we may assume that $\{C_1, \dots, C_r\}$ is non-empty. In the case where $\mathcal{P}^I \neq \emptyset$, let F_1, \dots, F_t be the cells of \mathcal{P}^I . Assume that C and F_1 are neighbours and for all $i \in \{1, \dots, t-1\}$, F_i and F_{i+1} are neighbours. Moreover, for all $1 \leq i \leq t$, assume that $V(F_i) = \{u_i, v_i, u_{i+1}, v_{i+1}\}$ such that $V(C) \cap V(F_1) = \{v_1, u_1\}$, $V(F_i) \cap V(F_{i+1}) = \{v_{i+1}, u_{i+1}\}$ and $\{u_i, u_{i+1}\}$ is an edge of F_i for all $1 \leq i \leq t$. See Figure 5 for a schematic showing of the cells C, C_i 's, D_j 's and F_k 's.

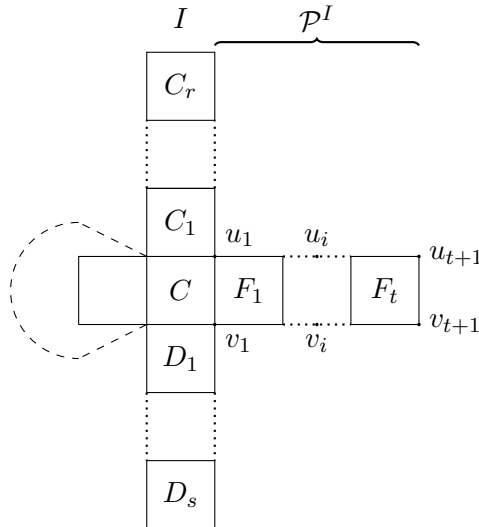

FIGURE 5

Consider the sub-polyomino $\mathcal{P}' = (\mathcal{P} \setminus (I \cup \mathcal{P}^I)) \cup \{C\}$ of \mathcal{P} . Note that the number of maximal inner intervals of \mathcal{P}' are exactly one less than the number of maximal inner intervals of \mathcal{P} . So, by induction hypothesis, \mathcal{P}' is of König type and satisfies #.

Note that C is both a single cell and an end-cell of the maximal interval containing it in \mathcal{P}' , which is $J \setminus \mathcal{P}^I$. Since \mathcal{P}' satisfies (1) of $\#$, the polyomino $\mathcal{P}' \cup \{C_1\}$ is of König type and satisfies $\#$ by Lemma 3.4. Repeatedly applying Lemma 3.4, we deduce that $\mathcal{P}' \cup \{C_1, \dots, C_r\}$ is of König type and satisfies $\#$.

Consider the case when $\mathcal{P}^I \neq \emptyset$. Since C is non-single end-cell of the maximal inner interval $J \setminus \mathcal{P}^I$ of $\mathcal{P}' \cup \{C_1, \dots, C_r\}$, (2) of $\#$ holds for $\{v_1, u_1\}$. First suppose that, the end-edge $\{v_1, u_1\}$ of $J \setminus \mathcal{P}^I$ contains a vertex, say v_1 , such that $\gcd(x_{v_1}, \text{in}_<(f_i)) = 1$ for all $1 \leq i \leq m$. Extend the graded lexicographic order $<$ on S to $S_1 = S[x_{v_2}, \dots, x_{v_{m+1}}, x_{u_2}, \dots, x_{u_{m+1}}]$ by the total order $x_v < x_{v_2} < \dots < x_{v_{t+1}} < x_{u_2} < \dots < x_{u_{t+1}}$, for all $v \in \mathcal{P}' \cup \{C_1, \dots, C_r\}$. For all $1 \leq i \leq t$, define $f_{m+i} = x_{u_{i+1}}x_{v_i} - x_{u_i}x_{v_{i+1}}$; then, $\text{in}_<(f_{m+i}) = x_{u_{i+1}}x_{v_i}$ for all $1 \leq i \leq t$. Thus, $\mathcal{P}' \cup \{C_1, \dots, C_r, F_1, \dots, F_t\}$ is of König type with respect to f_1, \dots, f_{m+t} . Next, suppose that there exists an $i \in [m]$ such that f_i correspond to an inner interval in $J \setminus \mathcal{P}^I$ containing edge $\{v_1, u_1\}$. Then, the polyomino $\mathcal{P}' \cup \{C_1, \dots, C_r, F_1\}$ is of König type and satisfies $\#$ by Lemma 3.4. Again, by repeatedly using Lemma 3.4, we get that $\mathcal{P}' \cup \{C_1, \dots, C_r, F_1, \dots, F_s\}$ is of König type and satisfies $\#$.

Consider the case when $\{D_1, \dots, D_s\} \neq \emptyset$. Since $\mathcal{P}' \cup \{C, C_1, \dots, C_r, F_1, \dots, F_s\}$ satisfies (2) of $\#$, the polyomino $\mathcal{P}' \cup \{C, C_1, \dots, C_r, F_1, \dots, F_s, D_1\}$ is of König type and satisfies $\#$ by Lemma 3.4. Proceeding similarly, we get that $\mathcal{P}' \cup \{C, C_1, \dots, C_r, D_1, \dots, D_s, F_1, \dots, F_t\}$ is of König type and satisfies $\#$. Hence the proof. \square

We now illustrate above theorem for the polyomino as shown in Figure 2. Using proof of Theorem 3.6, we get \mathcal{P} is of König type with respect to the generators $f_1 = x_{a_3}x_{a_2} - x_{a_1}x_{a_4}$, $f_2 = x_{a_5}x_{a_7} - x_{a_3}x_{a_8}$, $f_3 = x_{a_6}x_{a_{14}} - x_{a_4}x_{a_{13}}$, $f_4 = x_{a_{11}}x_{a_9} - x_{a_7}x_{a_{12}}$, $f_5 = x_{a_{11}}x_{a_{10}} - x_{a_8}x_{a_{12}}$ and $f_6 = x_{a_{10}}x_{a_{14}} - x_{a_9}x_{a_{13}}$. Moreover, $\text{in}_<(f_1) = x_{a_2}x_{a_3}$, $\text{in}_<(f_2) = x_{a_5}x_{a_7}$, $\text{in}_<(f_3) = x_{a_4}x_{a_{13}}$, $\text{in}_<(f_4) = x_{a_9}x_{a_{11}}$, $\text{in}_<(f_5) = x_{a_8}x_{a_{12}}$ and $\text{in}_<(f_6) = x_{a_{10}}x_{a_{14}}$.

Corollary 3.7. *Let \mathcal{P} be a simple thin polyomino. Then, $I_{\mathcal{P}}$ is Knutson.*

Proof. By Theorem 3.6, there exist generators f_1, \dots, f_m of $I_{\mathcal{P}}$ corresponding to distinct inner intervals of \mathcal{P} such that $I_{\mathcal{P}}$ is of König type with respect to f_1, \dots, f_m . Take $f = f_1 \cdots f_m$. Then, $I_{\mathcal{P}} \in C_f$ by Proposition 3.2. \square

3.2. Closed path and weakly closed path polyominoes. We begin by recalling the definitions of closed path polyominoes and weakly closed path polyominoes as defined in [CN23] and [CNU22b] respectively. We then use [DN22] to show that the polyomino ideal of a closed path polyomino is Knutson. Subsequently, we prove that the polyomino ideal of a weakly closed path polyomino is of König type. Recently, this result was also proved by Navarra [Nav24]; our argument is also on the same line of [Nav24]. Finally, we prove that polyomino ideal of a weakly closed path polyomino is Knutson.

Definition 3.8. Let \mathcal{P} be a finite non-empty collection of cells. Then \mathcal{P} is called a *closed path polyomino* if it is a sequence of cells A_0, \dots, A_n with $n \geq 6$ satisfying the following properties:

- (1) $A_0 = A_n$;
- (2) $A_i \neq A_j$, for all $i \neq j$ and $i, j \in \{1, \dots, n\}$;
- (3) $A_i \cap A_{i+1}$ is a common edge for all $i \in \{0, \dots, n-1\}$;
- (4) $V(A_i) \cap V(A_j) = \emptyset$ for all $i \in \{0, \dots, n-1\}$ and for all $j \notin \{i-2, i-1, i, i+1, i+2\}$, where the indices are reduced modulo n .

Definition 3.9. Let \mathcal{P} be a finite non-empty collection of cells. Then \mathcal{P} is called *weakly closed path* if it is a sequence of cells $A_0, A_1, \dots, A_{n-1}, A_n$ with $n \geq 6$ satisfying the following properties:

- (1) $A_0 = A_n$;
- (2) $A_i \neq A_j$, for all $i \neq j$ and $i, j \in \{1, \dots, n\}$;
- (3) $A_0 \cap A_{n-1}$ is a vertex;
- (4) $A_i \cap A_{i+1}$ is a common edge for all $i \in \{0, \dots, n-2\}$;

- (5) $V(A_i) \cap V(A_j) = \emptyset$ for all $i \in \{1, \dots, n\}$ and for all $j \notin \{i-2, i-1, i, i+1, i+2\}$, where the indices are reduced modulo n .

Remark 3.10. In a closed path, one can order the cells such that every cell has an edge in common with its consecutive cell. In a weakly closed path the same holds, with the exception of exactly two consecutive cells that have just a vertex in common. Note that each closed path polyomino and weakly closed path polyominoe has a unique hole.

Proposition 3.11. *Let $\mathcal{P} : A_0, \dots, A_{n-1}$ be a closed path polyomino. Then $I_{\mathcal{P}}$ is Knutson.*

Proof. By [DN22, Theorem 4.9], $I_{\mathcal{P}}$ is of König type. To prove this, the authors introduced an total order $<$ on the vertices of \mathcal{P} . For each cell A_i of \mathcal{P} , they assigned a generator f_i of $I_{\mathcal{P}}$ corresponding to an inner interval of \mathcal{P} such that $\gcd(\text{in}_{<}(f_i), \text{in}_{<}(f_j)) = 1$ for all $i \neq j$. Consider $f = \prod f_i$, then $\text{in}_{<}(f)$ is square-free. Note that $I_{\mathcal{P}}$ is unmixed by [CNV24, Theorem 4.19], and by [CNU22a], there exists a Gröbner basis of $I_{\mathcal{P}}$ with square-free initial terms, so $I_{\mathcal{P}}$ is radical. Hence the proof follows from Proposition 3.2. \square

Theorem 3.12. *Let $\mathcal{P} : A_0, \dots, A_{n-1}$ be a weakly closed path polyomino. Then $I_{\mathcal{P}}$ is of König type.*

Idea of the proof: Our proof follows similar strategies of [DN22]. Let \mathcal{P} be a weakly closed path polyomino with n distinct cells A_0, A_1, \dots, A_{n-1} . Since $\mathcal{P} \setminus \{A_0\}$ is simple, by [CNV24, Proposition 4.10], one can see that $\text{height}(I_{\mathcal{P}}) = \text{rank}(\mathcal{P}) = n$. In order to show that $I_{\mathcal{P}}$ is of König type, first, we give a suitable ordering on the vertices of \mathcal{P} , then we will consider the lexicographic ordering $<_{\text{lex}}$ induced by this total order on $\{x_v : v \in V(\mathcal{P})\}$. Next, we choose n generators f_1, \dots, f_n of $I_{\mathcal{P}}$ such that their initial terms do not share any common variables. Hence $\text{in}_{<_{\text{lex}}}(f_1), \dots, \text{in}_{<_{\text{lex}}}(f_n)$ forms a regular sequence. Therefore, $I_{\mathcal{P}}$ will be of König type.

In order to define a suitable total ordering on $\{x_v : v \in V(\mathcal{P})\}$, we order the vertices inductively using Table 1 (Table of [DN22]) below. We start with the cell A_0 . Let $Y^{(1)} = Y_1^{(1)} \sqcup Y_2^{(1)}$, where $Y_1^{(1)} = \{1\}, Y_2^{(1)} = \{1'\}$. Let $j \geq 2$ and assume that $Y^{(j-1)}$ is known. We want to define $Y^{(j)}$. We refer to Table 1 up to suitable rotations and reflections of \mathcal{P} . If one of the configurations in the left column of Table 1 occurs, where the blue vertices are in $Y^{(j-1)}$, then we denote by k the maximum integer such that $t+k$ is a red vertex in the picture displayed in the corresponding right column. Then, we set $Z_1^{(j)} = \{x_{t+1}, \dots, x_{t+k}\}$ and $Z_2^{(j)} = \{x_{(t+1)'}, \dots, x_{(t+k)'}\}$. For all $a \in Y_1^{(j-1)}$, we put $x_{1'} <_{\text{lex}} x_{h_2} <_{\text{lex}} x_{h_1} <_{\text{lex}} x_a$ with $t < h_1 < h_2 \leq t+k$, and for all $b \in Y_2^{(j-1)}$, we put $x_{m_2} <_{\text{lex}} x_{m_1} <_{\text{lex}} x_b$ with $t' < m_1 < m_2 \leq (t+k)'$. Therefore, we define $Y^{(j)} = Y_1^{(j)} \sqcup Y_2^{(j)}$, where $Y_1^{(j)} = Y_1^{(j-1)} \sqcup Z_1^{(j)}$ and $Y_2^{(j)} = Y_2^{(j-1)} \sqcup Z_2^{(j)}$. Finally, we argue that this process allows us to complete the labeling of all the vertices of \mathcal{P} .

Proof of Theorem 3.12. Note that in the neighbourhood of A_0 , \mathcal{P} is one of the following types in Figure 6.

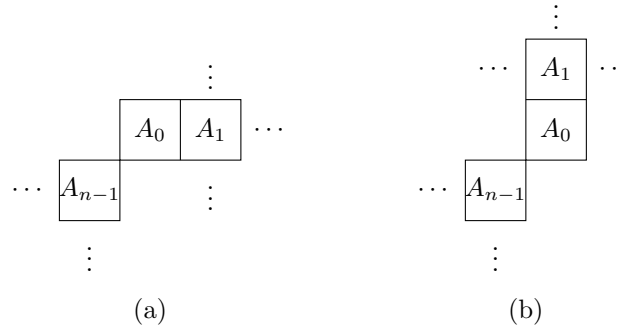

FIGURE 6

	IF it occurs ...	THEN we refer to ...
I		
II		
III		
IV		
V		
VI		
VII		
VIII		
IX		
X		

10
TABLE 1

Depending on the position of A_1 relative to A_0 , we have two different ways to label the vertices of A_0 . When A_1 is positioned to the right of A_0 , we label vertices of A_0 as in Figure 7a. When A_1 is positioned above A_0 , we label vertices of A_0 as in Figure 7b. We set $Y^{(1)} = Y_1^{(1)} \sqcup Y_2^{(1)}$, where $Y_1^{(1)} = \{x_1\}$ and $Y_2^{(1)} = \{x_{1'}\}$.

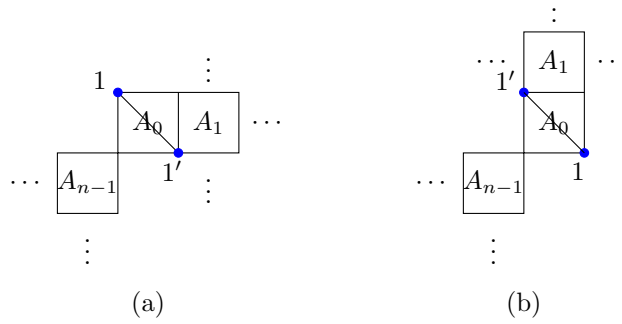

FIGURE 7

We then proceed with labeling the vertices according to the Table 1, up to rotations and reflections, until A_{n-3} or A_{n-2} , depending on the configuration of the cells $A_{n-4}, A_{n-3}, A_{n-2}, A_{n-1}$, and the labelling of A_{n-3} . Note that we have two possibilities of A_{n-1} and A_{n-2} , i.e., A_{n-2} could be either to the left of A_{n-1} or below A_{n-1} .

The blue vertices denote the vertices which have been labelled in the penultimate step and red vertices denote the vertices that are labelled in this step to complete the labeling.

First, we analyze the case where A_{n-2} is positioned to the left of A_{n-1} . If A_{n-3} is also on the left to A_{n-2} , we proceed to complete the labeling of the vertices of \mathcal{P} as shown in Figure 8. In this figure, blue vertices represent those that were labeled in the previous step, while red vertices denote those labeled in the current step to complete the labeling.

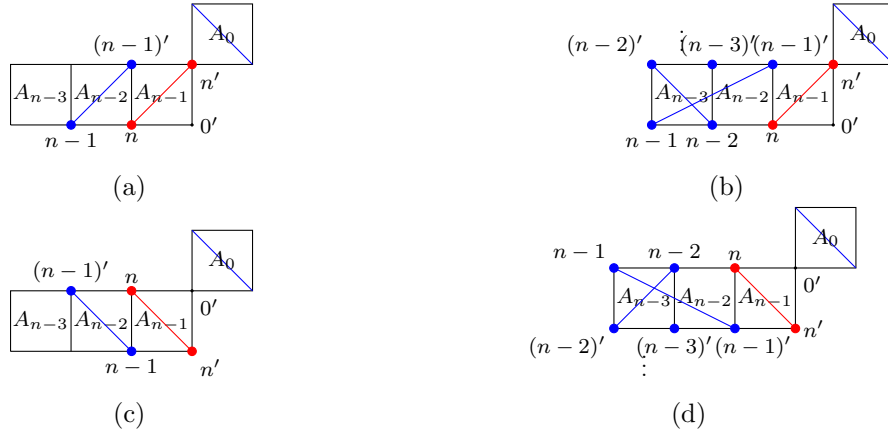

FIGURE 8

Next, we consider the subcase when A_{n-3} is located below of A_{n-2} . In this scenario, Figure 9 represents the vertex labeling for all possible configurations that may arise.

For the subcase where A_{n-3} is positioned above of A_{n-2} . Figure 10 presents all possible configurations.

Similarly one can conclude the second case, i.e., A_{n-2} is positioned below A_{n-1} . All possible configurations for this case are shown in Figure 11.

Consider the following ordering on the vertices

$$x_{n'} <_{lex} x_{(n-1)'} <_{lex} \cdots <_{lex} x_{1'} <_{lex} x_{0'} <_{lex} x_n <_{lex} \cdots <_{lex} x_1.$$

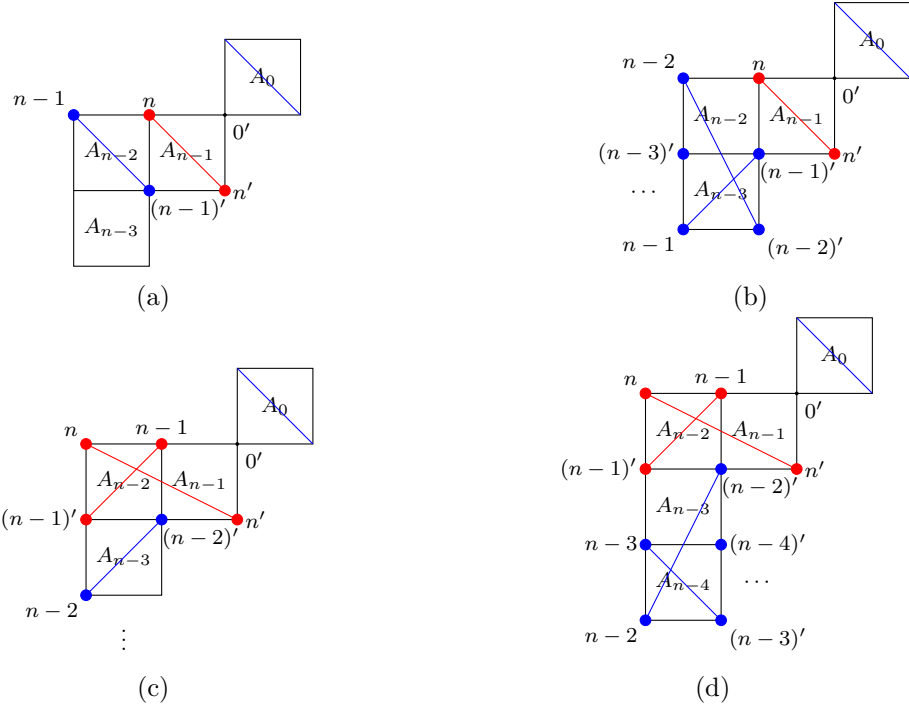

FIGURE 9

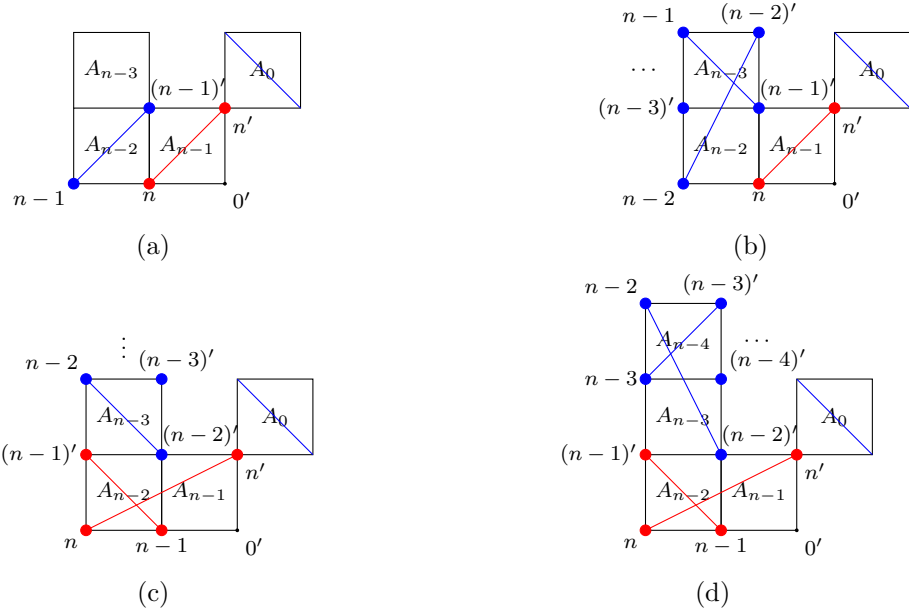

FIGURE 10

Let $<_{lex}$ denote the graded lexicographic ordering induced by this total ordering on the vertices. For each $1 \leq i \leq n$, let f_i denote the inner minor whose diagonal or anti-diagonal vertices are $\{i, i'\}$. Note that with respect to the graded lexicographic ordering, $\text{in}_{<_{lex}}(f_i) = x_i x_{i'}$ (in all the figures the initial terms are also drawn by diagonal or anti-diagonal lines). Also, by the construction of the total ordering, it is evident that $\text{gcd}(\text{in}_{<_{lex}}(f_i), \text{in}_{<_{lex}}(f_j)) = 1$ for all $i \neq j$. Hence f_1, \dots, f_n forms a regular sequence. Since $\text{height}(I_{\mathcal{P}}) = \text{rank}(\mathcal{P}) = n$ the proof is complete. \square

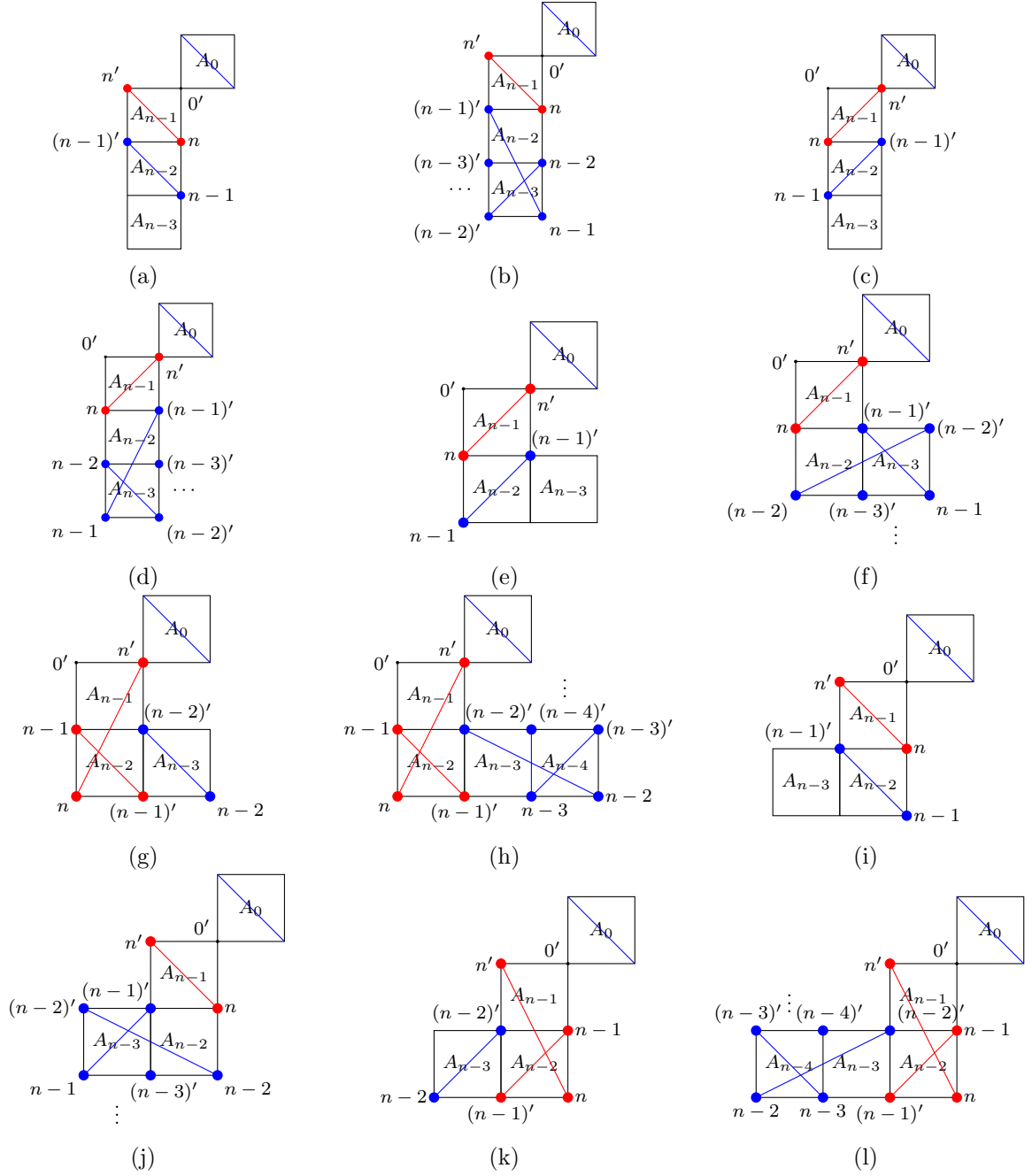

FIGURE 11

Example 3.13. We consider a weakly closed path polyomino with labeling of vertices as in Figure 12. Consider the graded lexicographic order induced by

$$x_{23}' <_{lex} \cdots <_{lex} x_{1'} <_{lex} x_{0'} <_{lex} x_{23} <_{lex} \cdots <_{lex} x_1.$$

Then one can see that with respect to this ordering, the polyomino ideal is of König type, where diagonal or anti-diagonal lines are drawn to denote $\text{in}_{<_{lex}}(f_i)$ for all $i = 1, \dots, 23$.

Corollary 3.14. Let $\mathcal{P} : A_0, \dots, A_{n-1}$ be a weakly closed path polyomino. Then $I_{\mathcal{P}}$ is a Knutson ideal.

Proof. In the proof of the above theorem, we observed that for each cell A_i , we obtain a generator f_i of $I_{\mathcal{P}}$ corresponding to an inner interval of \mathcal{P} such that $\text{gcd}(\text{in}_{<_{lex}}(f_i), \text{in}_{<_{lex}}(f_j)) = 1$ for all $i \neq j$. Consider $f = \prod f_i$, then $\text{in}_{<_{lex}}(f)$ is square-free. We show that $I_{\mathcal{P}} \in \mathcal{C}_f$. Let

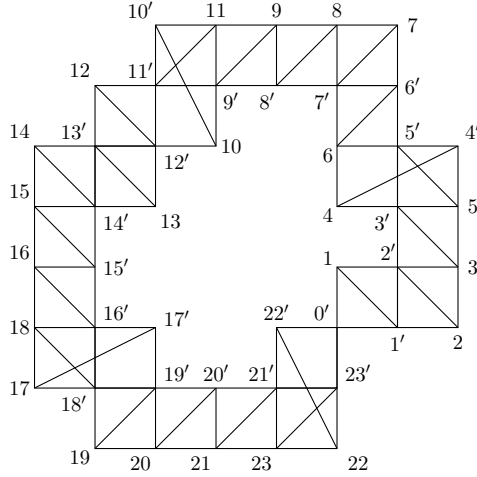

FIGURE 12

$\mathcal{P}_1 = \mathcal{P} \setminus A_0$ and $\mathcal{P}_2 = \mathcal{P} \setminus A_{n-1}$. Since \mathcal{P}_1 and \mathcal{P}_2 are simple polyominoes, $I_{\mathcal{P}_1}$ and $I_{\mathcal{P}_2}$ are prime ideals. Observe that $I_{\mathcal{P}_1}$ (resp. $I_{\mathcal{P}_2}$) is a minimal prime ideal of $(f_1, f_2, \dots, f_{n-1})$ (resp. $(f_0, f_2, \dots, f_{n-2})$). Since $(f_1, f_2, \dots, f_{n-1}), (f_0, f_2, \dots, f_{n-2}) \in \mathcal{C}_f$, we get that $I_{\mathcal{P}_1}, I_{\mathcal{P}_2} \in \mathcal{C}_f$. Also, note that $I_{\mathcal{P}} = I_{\mathcal{P}_1} + I_{\mathcal{P}_2}$. Hence the proof follows. \square

Remark 3.15. One can note that using similar total order on the vertices as of weakly closed path polyomino any thin path polyomino is König and hence the corresponding polyomino ideal is Knutson.

4. LADDER POLYOMINOES ARE KNUTSON

In this section, we study a class of polyominoes that generalizes parallelogram polyominoes. We show that the polyomino ideals associated with these polyominoes are Knutson.

Let \mathcal{P} be a horizontally convex polyomino. A set of vertices $\{a_1 = (a_{1,1}, a_{1,2}), \dots, a_r = (a_{r,1}, a_{r,2})\} \subset V(\mathcal{P})$, with $a_{1,2} < a_{2,2} < \dots < a_{r,2}$ is said to be the set of *left-most vertices* of \mathcal{P} , if for any vertex $v = (v_1, v_2) \in V(\mathcal{P})$, either $v = a_i$ for some i , or there exists a j , $1 \leq j \leq r$ such that $v_2 = a_{j,2}$, and $a_{j,1} < v_1$. A horizontally convex polyomino \mathcal{P} with the set of left-most vertices $\{a_1, a_2, \dots, a_r\}$ is called a *ladder polyomino* if for each $2 \leq i \leq r$, a_i is an upper-left vertex of a cell in \mathcal{P} . An example of ladder polyomino is shown in Figure 13 with $\{a_1, \dots, a_8\}$ as the set of left-most vertices. Note that in a ladder polyomino, $a_{i,1} \leq a_{i-1,1}$ and $a_{i,2} = a_{i-1,2} + 1$ for all $2 \leq i \leq r$. Also, note that a parallelogram polyomino is a ladder polyomino.

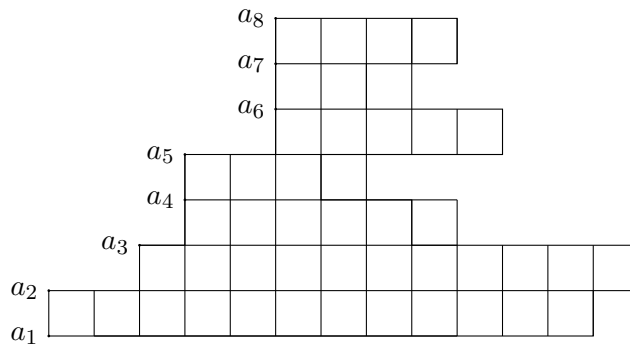

FIGURE 13. A ladder polyomino

Theorem 4.1. *Let \mathcal{P} be a ladder polyomino. Then, $I_{\mathcal{P}}$ is a Knutson ideal.*

Before we proceed with the proof of Theorem 4.1, we will establish several lemmas that are essential to the proof. We begin by introducing some notations that will be utilized not only in the proof of this theorem but also throughout the remainder of the article.

Discussion 4.2. Let \mathcal{P} be a collection of cells. Partition the vertices of \mathcal{P} into sets V_1, \dots, V_s which satisfy following conditions: for each $1 \leq k \leq s$, let $V_k := \{v_{k,1}, \dots, v_{k,n_k}\}$, then

- (1) for all $1 \leq i < n_k$, the vertices $v_{k,i}$ and $v_{k,i+1}$ are upper-left and lower-right vertices of a cell in \mathcal{P} respectively.
- (2) $v_{k,1}$ (resp. v_{k,n_k}) is not a lower-right (resp. upper-left) vertex of any cell in \mathcal{P} .
- (3) for $k < l$, write $v_{k,1} = (v_1, v_2) \in V_k$ and $v_{l,1} = (w_1, w_2) \in V_l$, then $v_1 + v_2 < w_1 + w_2$, or $v_1 + v_2 = w_1 + w_2$ and $v_1 < w_1$.

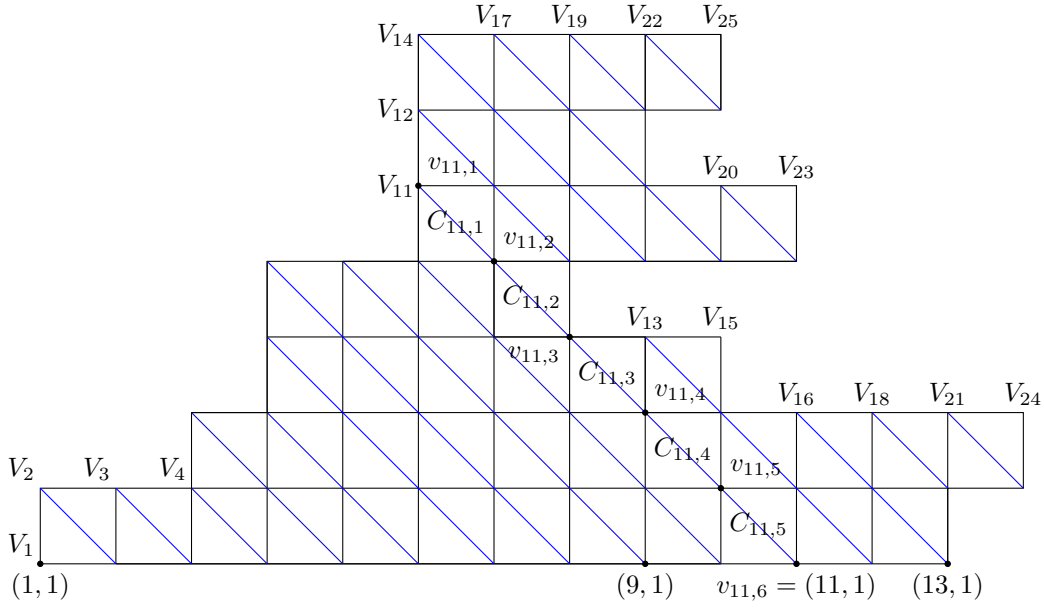

FIGURE 14. A ladder polyomino

In loose words, V_i 's are the sets of vertices on anti-diagonal lines. For $i < j$, either V_j is on the anti-diagonal line to the right of V_i , or if they reside on the same anti-diagonal line, then V_j is positioned lower than V_i . An example is given in Figure 14 emphasizing the set V_{11} .

To each V_k , we now associate a set of cells \mathcal{C}_k in the following way: If V_k is a singleton, then we define \mathcal{C}_k to be the empty-set. Otherwise, define $\mathcal{C}_k := \{C_{k,1}, C_{k,2}, \dots, C_{k,n_k-1}\}$ as the set of cells in \mathcal{P} where, for each $1 \leq i < n_k - 1$, $v_{k,i}$ and $v_{k,i+1}$ are the anti-diagonal vertices of the cell $C_{k,i}$. The set \mathcal{C}_{11} is labeled in Figure 14. Let \mathcal{P}_k denote the sub-collection of cells of \mathcal{P} , defined as:

$$\mathcal{P}_k := \bigcup_{i \leq k} \mathcal{C}_i.$$

For any $1 \leq k \leq s$, suppose that $v_{k,1} = (i_k + 1, j_k + n_k)$ for some $i_k, j_k \in \mathbb{N}$, then $v_{k,l} = (i_k + l, j_k + n_k + 1 - l)$ for all $1 \leq l \leq n_k$. To each V_k , we associate a matrix $M_k = [m_{ab}]_{1 \leq a, b \leq n_k}$ of order n_k with the following entries: for $1 \leq a, b \leq n_k$,

$$m_{ab} = \begin{cases} x_{i_k+a, j_k+b} & \text{if } (i_k + a, j_k + b) \in V(\mathcal{P}), \\ 0 & \text{else.} \end{cases}$$

Note that the diagonal entries of the matrix M_k are the variables corresponding to the vertices in V_k . The following matrix represents M_{13} associated with V_{13} as in Figure 14.

$$\begin{bmatrix} x_{9,4} & x_{10,4} & 0 & 0 \\ x_{9,3} & x_{10,3} & x_{11,3} & x_{12,3} \\ x_{9,2} & x_{10,2} & x_{11,2} & x_{12,2} \\ x_{9,1} & x_{10,1} & x_{11,1} & x_{12,1} \end{bmatrix}.$$

Let f_k denote the determinant of the matrix M_k . Define

$$f := \prod_{k=1}^s f_k.$$

We define a total order $<$ on the variables of S as follows: $x_{i,j} < x_{k,l}$ if $i < k$ or $i = k$ and $j < l$. We apply the graded reverse lexicographic order induced by the order $<$. Note that the initial term of $x_a x_b - x_c x_d$, associated with the inner interval $[a, b]$ of \mathcal{P} with anti-diagonal vertices c and d , is $x_c x_d$ with respect to the order defined above. \square

Lemma 4.3. Under the notations of Discussion 4.2,

$$\text{in}_<(f) = \prod_{v \in V(\mathcal{P})} x_v.$$

Proof. It suffices to show that $\text{in}_<(f_k) = \prod_{v \in V_k} x_v$ for every $1 \leq k \leq s$. If $|V_k| = 1$, then we are done. So we may assume that $|V_k| \geq 2$. Recall that $v_{k,l} = (i_k + l, j_k + n_k + 1 - l)$ for all $1 \leq l \leq n_k$ and for some $i_k, j_k \in \mathbb{N}$. The matrix M_k has the following form

$$\begin{bmatrix} x_{i_k+1, j_k+n_k} & * & \cdots & * \\ * & x_{i_k+2, j_k+n_k-1} & \cdots & * \\ \vdots & \vdots & \ddots & \vdots \\ * & * & \cdots & x_{i_k+n_k, j_k+1} \end{bmatrix}.$$

Therefore,

$$f_k = \sum_{\sigma \in S_{n_k}} (-1)^{\text{sgn}(\sigma)} x_{i_k+1, j_k+\sigma(1)} x_{i_k+2, j_k+\sigma(2)} \cdots x_{i_k+n_k, j_k+\sigma(n_k)},$$

where S_{n_k} denotes the symmetric group on n_k symbols, and $\text{sgn}(\sigma)$ denotes the sign of the permutation σ , which is 1 if σ is even and -1 if σ is odd. Note that some of the monomials in the summation might not be present.

It is enough to show that

$$x_{i_k+1, j_k+n_k} x_{i_k+2, j_k+n_k-1} \cdots x_{i_k+n_k, j_k+1} > x_{i_k+1, j_k+\sigma(1)} x_{i_k+2, j_k+\sigma(2)} \cdots x_{i_k+n_k, j_k+\sigma(n_k)}$$

whenever the right-hand side is non-zero and σ is not the permutation

$$\begin{pmatrix} 1 & 2 & \cdots & n_k \\ n_k & n_k-1 & \cdots & 1 \end{pmatrix}.$$

This follows immediately since we are considering the graded reverse lexicographic order. \square

Before proving Theorem 4.1, we need a technical result (Lemma 4.7). To prove Lemma 4.7 we develop a combinatorial method which we discuss below.

Setup 4.4. Let $\chi(n, l, \sigma)$ be the following property: for an $n \geq 2$, an integer l with $2 \leq l \leq n$, and a permutation $\sigma \in S_n$ (the symmetric group on n symbols), either one of the following holds:

4.4.1 There exists an integer i with $i < l$, such that $l + \max\{\sigma(i), \sigma(l)\} \leq n + 2$.

4.4.2 There exist two integers i, j with $1 \leq i < j \leq n$ such that $j + \max\{\sigma(i), \sigma(j)\} \leq n + 1$.

Lemma 4.5. For every $n \geq 2$, $2 \leq l \leq n$ and $\sigma \in S_n$, $\chi(n, l, \sigma)$ holds true.

Proof. We proceed by induction on n . If $n = 2$, then $l = 2$ and [4.4.1](#) holds for every $\sigma \in S_2$. So we may assume that $n \geq 3$ and $\chi(n-1, l, \sigma)$ holds for every $2 \leq l \leq n-1$ and $\sigma \in S_{n-1}$. Fix a $\sigma \in S_n$ and $2 \leq l \leq n$. Note that if $l = 2$, then $2 + \max\{\sigma(1), \sigma(2)\} \leq n+2$; thus [4.4.1](#) holds. So we may assume that $l \geq 3$. Let $l' = l-1$, and n_0 with $1 \leq n_0 \leq n$ be such that $\sigma(n_0) = n$. Define a permutation $\tilde{\sigma} \in S_{n-1}$ by

$$\tilde{\sigma}(m) = \begin{cases} \sigma(m) & \text{if } m < n_0 \\ \sigma(m+1) & \text{if } m \geq n_0. \end{cases}$$

Since $\chi(n-1, l', \tilde{\sigma})$ holds by induction hypothesis, either [4.4.1](#) or [4.4.2](#) holds for $n-1, l'$ and $\tilde{\sigma}$. First, assume that [4.4.1](#) holds. Then, there exists an i with $i < l'$, such that $l' + \max\{\tilde{\sigma}(i), \tilde{\sigma}(l')\} \leq n+1$. The following cases are possible:

(1) When $i < l' < n_0$. Then, $\tilde{\sigma}(i) = \sigma(i), \tilde{\sigma}(l') = \sigma(l')$. So, $l' + \max\{\sigma(i), \sigma(l')\} \leq n+1$; thus [4.4.2](#) holds for σ and l with respect to i and l' .

(2) When $i < n_0 \leq l'$. Then, $\tilde{\sigma}(i) = \sigma(i), \tilde{\sigma}(l') = \sigma(l'+1)$. So, $l' + \max\{\sigma(i), \sigma(l')\} \leq n+2$; thus [4.4.1](#) holds for σ and l .

(3) When $n_0 \leq i < l'$. Then, $\tilde{\sigma}(i) = \sigma(i+1), \tilde{\sigma}(l') = \sigma(l'+1)$. So, $l' + \max\{\sigma(i+1), \sigma(l')\} \leq n+2$; thus [4.4.1](#) holds for σ and l with respect to $i+1$.

On the other hand, suppose that [4.4.2](#) holds for $n-1, l'$ and $\tilde{\sigma}$. Then, there exist $1 \leq i < j \leq n-1$ such that $j + \max\{\tilde{\sigma}(i), \tilde{\sigma}(j)\} \leq n$. The following cases are possible:

(1) When $i < j < n_0$. Then, $\tilde{\sigma}(i) = \sigma(j), \tilde{\sigma}(j) = \sigma(j)$. So, $j + \max\{\sigma(i), \sigma(j)\} \leq n < n+1$; thus [4.4.2](#) holds for σ and l .

(2) When $i < n_0 \leq j$. Then, $\tilde{\sigma}(i) = \sigma(i), \tilde{\sigma}(j) = \sigma(j+1)$. So, $(j+1) + \max\{\sigma(i), \sigma(j+1)\} \leq n+1$; thus [4.4.2](#) holds for σ and l with respect to i and $j+1$.

(3) When $n_0 \leq i < j$. Then, $\tilde{\sigma}(i) = \sigma(i+1), \tilde{\sigma}(j) = \sigma(j+1)$. So, $(j+1) + \max\{\sigma(i+1), \sigma(j+1)\} \leq n+1$; thus [4.4.2](#) holds for σ and l with respect to $i+1$ and $j+1$. □

For some fixed $n \geq 2, 2 \leq l \leq n$ and $\sigma \in S_n$, let

$$S(n, l, \sigma) := \{(i, j) : i < j, \text{ either } j = l \text{ and } \text{a href="#">4.4.1} \text{ holds for } i, j \text{ or } \text{a href="#">4.4.2} \text{ holds for } i, j\}.$$

By Lemma [4.5](#), $S(n, l, \sigma)$ is non-empty. Let (i_σ, j_σ) be the minimum element of $S(n, l, \sigma)$ under the graded lexicographic order on \mathbb{N}^2 .

Lemma 4.6. *Under the notations as above, (i_σ, j_σ) is the minimum element of $S(n, l, \sigma \circ (i_\sigma j_\sigma))$, where $(i_\sigma j_\sigma)$ denotes the transposition of S_n .*

Proof. Let $\sigma' = \sigma \circ (i_\sigma j_\sigma)$. Since $\sigma'(i_\sigma) = \sigma(j_\sigma)$ and $\sigma'(j_\sigma) = \sigma(i_\sigma)$, we get that $(i_\sigma, j_\sigma) \in S(n, l, \sigma')$. Let (i, j) be a pair with $(i, j) < (i_\sigma, j_\sigma)$ under the graded lexicographic order on \mathbb{N}^2 . The following cases are possible: either $\{i, j\} \cap \{i_\sigma, j_\sigma\} = \emptyset$ or $\#\{i, j\} \cap \{i_\sigma, j_\sigma\} = 1$. As $(i, j) < (i_\sigma, j_\sigma)$, in the later case, either $i < i_\sigma$ and $j = j_\sigma$, or $i = i_\sigma$ and $j < j_\sigma$. We proceed in all cases.

(1) When $\{i, j\} \cap \{i_\sigma, j_\sigma\} = \emptyset$. If $(i, j) \in S(n, l, \sigma')$, then the property $\chi(n, l, \sigma')$ holds for the pair (i, j) . Since $\sigma'(i) = \sigma(i)$ and $\sigma'(j) = \sigma(j)$, we get that $\chi(n, l, \sigma)$ holds for the pair (i, j) . Therefore, this case is not possible.

(2) When $i < i_\sigma$ and $j = j_\sigma$. Since $(i_\sigma, j_\sigma) \in S(n, l, \sigma)$, we have $j_\sigma + \sigma(i_\sigma) \leq n+2$ if $j_\sigma = l$, and $\leq n+1$ else; thus $i_\sigma + \sigma(i_\sigma) \leq n+1$ because $i_\sigma < j_\sigma$. On the other hand, since $(i, i_\sigma) < (i_\sigma, j_\sigma)$, we have $(i, i_\sigma) \notin S(n, l, \sigma)$. Thus, $i_\sigma + \max\{\sigma(i), \sigma(i_\sigma)\} \not\leq n+2$ if $i_\sigma = l$, and $\not\leq n+1$ else. Since $i_\sigma + \sigma(i_\sigma) \leq n+1$, we get that $i_\sigma + \sigma(i) \not\leq n+2$ if $i_\sigma = l$, and $\not\leq n+1$ else. Since, $\sigma(i) = \sigma'(i)$, we get $(i, j) \notin S(n, l, \sigma')$.

(3) When $i = i_\sigma$ and $j < j_\sigma$. Since $(i_\sigma, j_\sigma) \in S(n, l, \sigma)$, we have $j_\sigma + \sigma(i_\sigma) \leq n+2$; thus, $j + \sigma(i_\sigma) \leq n+1$ because $j < j_\sigma$. On the other hand, since $(i, j) < (i_\sigma, j_\sigma)$, we have $(i, j) \notin S(n, l, \sigma)$. Thus, $j + \max\{\sigma(i), \sigma(j)\} \not\leq n+2$ if $j = l$, and $\not\leq n+1$ else. Since $j + \sigma(i) \leq n+1$, we get that $j + \sigma(j) \not\leq n+2$ if $j = l$, and $\not\leq n+1$ else. Since $\sigma(j) = \sigma'(j)$, we get $(i, j) \notin S(n, l, \sigma')$.

Hence the proof. \square

Following the above notations for an $n \geq 2$ and $2 \leq l \leq n$, let $\sigma' = \sigma \circ (i_\sigma j_\sigma)$, then by Lemma 4.6, $(i_{\sigma'}, j_{\sigma'}) = (i_\sigma, j_\sigma)$. Thus if $\sigma_1 \circ (i_{\sigma_1} j_{\sigma_1}) = \sigma_2 \circ (i_{\sigma_2} j_{\sigma_2}) = \sigma'$ (say), for some $\sigma_1, \sigma_2 \in S_n$, we have $(i_{\sigma_1}, j_{\sigma_1}) = (i_{\sigma'}, j_{\sigma'}) = (i_{\sigma_2}, j_{\sigma_2})$. Hence, $\sigma_1 = \sigma_2$. Note that if σ varies over all even permutations, then by what we discussed above, the set $\{\sigma \circ (i_\sigma j_\sigma) : \sigma \in S_n \text{ a even permutation}\}$ is the set of all odd permutations. Thus, we can partition the set $S_n = \bigsqcup_{\sigma \in \Lambda} \{\sigma, \sigma \circ (i_\sigma j_\sigma)\}$, where Λ is the set of all even permutation of S_n .

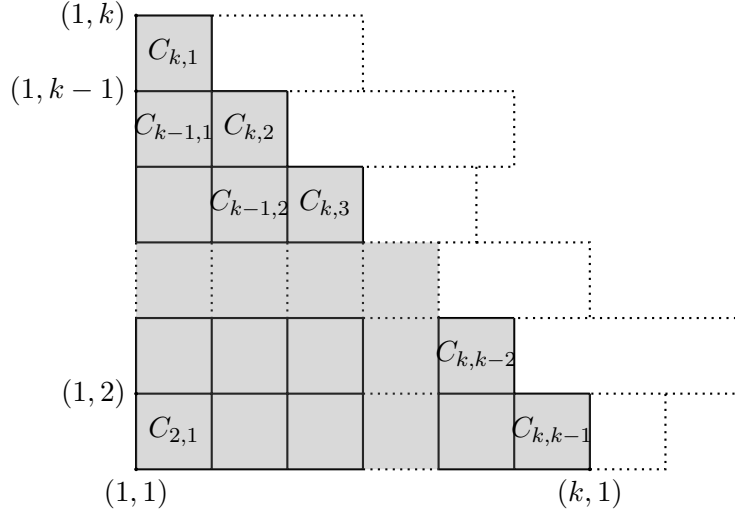

FIGURE 15

Lemma 4.7. *Let \mathcal{P} be a horizontally convex polyomino as shown in Figure 15 with coloured sub-polyomino. Under the notations of Discussion 4.2, if $\mathcal{C}_k \neq \emptyset$, then $f_k \notin I_{\mathcal{P}_{k-1}}$ and $f_k \in I_{\mathcal{P}_{k-1} \cup \{C\}}$ for all $C \in \mathcal{C}_k$.*

Proof. Assume the notations of Discussion 4.2. Note that $V_1 = (1, 1), V_2 = \{(1, 2), (2, 1)\}, V_{k-1} = \{(1, k-1), (2, k-2), \dots, (k-1, 1)\}$ and $V_k = \{(1, k), (2, k-1), \dots, (k, 1)\}$.

Recall from the proof of Lemma 4.3,

$$f_k = \sum_{\sigma \in S_k} (-1)^{\text{sgn}(\sigma)} x_{1,\sigma(1)} x_{2,\sigma(2)} \cdots x_{k,\sigma(k)},$$

where S_n denotes the symmetric group on n symbols, and $\text{sgn}(\sigma)$ denotes the sign of the permutation σ , which is 1 if σ is even and -1 if σ is odd. Note that some of the monomials in the summation might not be present.

If $f_k \in I_{\mathcal{P}_{k-1}}$, then $f_k = \sum_{i=1}^r h_i g_i$, where $h_i \in S$ and $g_i \in I_{\mathcal{P}_{k-1}}$ a generator corresponding to an inner interval of \mathcal{P}_{k-1} for all $1 \leq i \leq r$. So, every non-zero monomial of f_k must contain at least two variables corresponding to diagonal or anti-diagonal vertices of an inner interval of \mathcal{P}_{k-1} . Note that $x_{1,k} x_{2,k-1} \cdots x_{k,1}$ is a non-zero monomial in f_k , and it does not contain variables corresponding to diagonal or anti-diagonal vertices of any inner interval of \mathcal{P}_{k-1} . Thus, $f_k \notin I_{\mathcal{P}_{k-1}}$.

We now show that $f_k \in I_{\mathcal{P}_{k-1} \cup \{C\}}$ for all $C \in \mathcal{C}_k$. Let $C_{k,l} \in \mathcal{C}_k$. For k and l , consider the partition of S_k defined above. Thus, we can rewrite f_k as

$$\begin{aligned} f_k &= \sum_{\sigma \in \Lambda} (x_{1,\sigma(1)} x_{2,\sigma(2)} \cdots x_{k,\sigma(k)} - x_{1,\sigma \circ (i_\sigma j_\sigma)(1)} x_{2,\sigma \circ (i_\sigma j_\sigma)(2)} \cdots x_{k,\sigma \circ (i_\sigma j_\sigma)(k)}) \\ &= \sum_{\sigma \in \Lambda} (x_{1,\sigma(1)} x_{2,\sigma(2)} \cdots \widehat{x_{i_\sigma, \sigma(i_\sigma)}} \cdots \widehat{x_{j_\sigma, \sigma(j_\sigma)}} \cdots x_{k,\sigma(k)}) (x_{i_\sigma, \sigma(i_\sigma)} x_{j_\sigma, \sigma(j_\sigma)} - x_{i_\sigma, \sigma(j_\sigma)} x_{j_\sigma, \sigma(i_\sigma)}), \end{aligned}$$

where $\widehat{x_v}$ indicates that the variable x_v is not present in the product.

Fix a $\sigma \in \Lambda$. Note that the pair $(i_\sigma, j_\sigma) \in S(k, l, \sigma)$, i.e., the pair (i_σ, j_σ) satisfies 4.4.1 or 4.4.2. When (i_σ, j_σ) satisfies 4.4.2, we get $i_\sigma < j_\sigma$ and $j_\sigma + \max\{\sigma(i_\sigma), \sigma(j_\sigma)\} \leq k + 1$. Consequently, it follows that

$$(j_\sigma, \max\{\sigma(i_\sigma), \sigma(j_\sigma)\}) \in V(\mathcal{P}_{k-1}).$$

By the definition of \mathcal{P}_{k-1} , we get that $(j_\sigma, \min\{\sigma(i_\sigma), \sigma(j_\sigma)\}) \in V(\mathcal{P}_{k-1})$. Moreover, since $i_\sigma < j_\sigma$ and the way \mathcal{P}_{k-1} is defined, we get

$$(i_\sigma, \min\{\sigma(i_\sigma), \sigma(j_\sigma)\}), (i_\sigma, \max\{\sigma(i_\sigma), \sigma(j_\sigma)\}) \in V(\mathcal{P}_{k-1}).$$



When (i_σ, j_σ) satisfies 4.4.1, we get $i_\sigma < j_\sigma = l$ and $j_\sigma + \max\{\sigma(i_\sigma), \sigma(j_\sigma)\} \leq k + 2$. Thus,

$$(j_\sigma, \max\{\sigma(i_\sigma), \sigma(j_\sigma)\}) \in V(\mathcal{P}_{k-1} \cup \{C_{k,l}\})$$

Furthermore, since $i_\sigma < j_\sigma$ and the way \mathcal{P}_{k-1} is defined, we get

$$(i_\sigma, \min\{\sigma(i_\sigma), \sigma(j_\sigma)\}), (i_\sigma, \max\{\sigma(i_\sigma), \sigma(j_\sigma)\}), (j_\sigma, \min\{\sigma(i_\sigma), \sigma(j_\sigma)\}) \in V(\mathcal{P}_{k-1} \cup \{C_{k,l}\}).$$

Thus, in both cases, the vertices

$$(i_\sigma, \sigma(i_\sigma)), (i_\sigma, \sigma(j_\sigma)), (j_\sigma, \sigma(i_\sigma)), (j_\sigma, \sigma(j_\sigma)) \in V(\mathcal{P}_{k-1} \cup \{C_{k,l}\}).$$

Since $\mathcal{P}_{k-1} \cup \{C_{k,l}\}$ is convex, the interval formed by these vertices is an inner interval of $\mathcal{P}_{k-1} \cup \{C_{k,l}\}$. Therefore, $x_{i_\sigma, \sigma(i_\sigma)} x_{j_\sigma, \sigma(j_\sigma)} - x_{i_\sigma, \sigma(j_\sigma)} x_{j_\sigma, \sigma(i_\sigma)} \in I_{\mathcal{P}_{k-1} \cup \{C_{k,l}\}}$. Hence the proof. \square

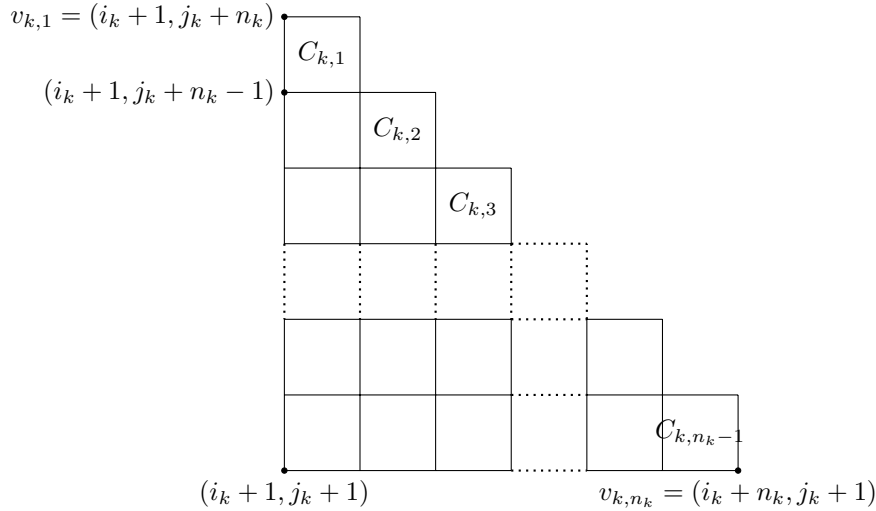

FIGURE 16

Lemma 4.8. Let \mathcal{P} be a ladder polyomino. Under the notations of Discussion 4.2, for each $1 \leq k \leq r$,

- (1) if $\mathcal{C}_k \neq \emptyset$, then \mathcal{P}_k contains the polyomino shown in Figure 16 as a sub-polyomino.
- (2) if $\mathcal{P}_k \neq \emptyset$, \mathcal{P}_k is a simple sub-polyomino of \mathcal{P} .

Proof. (1) Assuming the notations from Discussion 4.2, we note that if $\mathcal{C}_k \neq \emptyset$, then for all $1 \leq l \leq n_k - 1$, the cell $C_{k,l}$ has upper-left vertex $(i_k + l, j_k + n_k + 1 - l)$. Given the definition of \mathcal{P}_k , it suffice to show that the polyomino shown in Figure 16 is a sub-polyomino of \mathcal{P} . To prove that, we need to show that all cells with upper-left vertex $(i_k + u, j_k + v)$ are in \mathcal{P} , where

$1 \leq u \leq n_k - 1$, $2 \leq v \leq n_k$, and $u + v \leq n_k + 1$. We proceed by downward induction on v . When $v = n_k$, we have $u = 1$. In this case, the cell with upper-left vertex $(i_k + 1, j_k + n_k)$ is $C_{k,1}$ which is in \mathcal{P} . Let $v < n_k$ and by induction hypothesis, assume that all cells with upper-left vertex $(i_k + u, j_k + v + 1)$ are in \mathcal{P} , where $1 \leq u \leq n_k - 1$ and $u + v + 1 \leq n_k + 1$. In particular, the cell with upper-left vertex $(i_k + 1, j_k + v + 1)$ is in \mathcal{P} , implying that the vertex $(i_k + 1, j_k + v) \in V(\mathcal{P})$.

Let a_l be the left-most vertex of \mathcal{P} such that $a_{l,2} = j_k + v$. Given that $(i_k + 1, j_k + v) \in V(\mathcal{P})$, it follows that $a_{l,1} \leq i_k + 1$. Since \mathcal{P} is a ladder polyomino, the cell with upper-left vertex $a_l = (a_{l,1}, j_k + v)$ is in \mathcal{P} . Moreover, since \mathcal{P} is horizontally convex and the cell C_{k,n_k-v+1} with upper-left vertex $(i_k + n_k - v + 1, j_k + v)$ is also in \mathcal{P} , we get that for all m , $a_{l,1} \leq m \leq i_k + n_k - v + 1$, the cell with upper-left vertex $(m, j_k + v)$ is in \mathcal{P} . Hence the proof as $a_{l,1} \leq i_k + 1$.

(2) Note that $\mathcal{P}_1 = \emptyset$, and \mathcal{P}_2 is a cell. Let $k \geq 3$. We use induction, assuming that \mathcal{P}_{k-1} is a simple sub-polyomino of \mathcal{P} . By (1), the cells of \mathcal{C}_k are attached to \mathcal{P}_{k-1} in such a way that \mathcal{P}_k is a polyomino. Thus, \mathcal{P}_k is a sub-polyomino of \mathcal{P} . Also, given our definition of the set V_i 's, \mathcal{P}_k is simple. \square

We are now ready to prove our main theorem of this section.

Proof of Theorem 4.1. We show that $I_{\mathcal{P}} \in C_f$, where f is as defined in Discussion 4.2. By Lemma 4.3, $\text{in}_{<}(f) = \prod_{v \in V(\mathcal{P})} x_v$. Assume the notations of Discussion 4.2. Note that $V_1 = \{(i_1 + 1, j_1 + 1)\}$ is singleton, and $\mathcal{P}_1 = \emptyset$. We proceed by induction on k for $k \geq 2$ to show that $I_{\mathcal{P}_k} \in C_f$. Since \mathcal{P} is a ladder polyomino, $V_2 = \{(i_1 + 1, j_1 + 2), (i_1 + 2, j_1 + 1)\}$, and the polyomino ideal $I_{\mathcal{P}_2}$ is generated by $x_{i_1+1, j_1+1} x_{i_1+2, j_1+2} - x_{i_1+1, j_1+2} x_{i_1+2, j_1+1}$ which is $-f_2$. Thus, $I_{\mathcal{P}_2} \in C_f$.

Now, let $k > 2$ and by induction hypothesis, assume that $I_{\mathcal{P}_{k-1}} \in C_f$. Recall that $\mathcal{P}_k = \mathcal{P}_{k-1} \cup \mathcal{C}_k$, where $\mathcal{C}_k = \{C_{k,1}, C_{k,2}, \dots, C_{k,n_k-1}\}$. If $\mathcal{C}_k = \emptyset$, then $\mathcal{P}_k = \mathcal{P}_{k-1}$ and we are done. So we may assume that $\mathcal{C}_k \neq \emptyset$. We first show that

$$I_{\mathcal{P}_k} = \sum_{C \in \mathcal{C}_k} I_{\mathcal{P}_{k-1} \cup \{C\}}.$$

Clearly, $\sum_{C \in \mathcal{C}_k} I_{\mathcal{P}_{k-1} \cup \{C\}} \subseteq I_{\mathcal{P}_k}$. Given our definition of the set V_i 's, we observe that \mathcal{P}_k does not contain a cell with lower-left vertex $v_{k,i}$ for all $2 \leq i \leq n_k$. Consequently, there are no inner intervals in \mathcal{P}_k that contain at least two cells from the set \mathcal{C}_k . Thus, for each inner interval I in \mathcal{P}_k , there exists an $C \in \mathcal{C}_k$ such that I is an inner interval of $\mathcal{P}_{k-1} \cup \{C\}$. Thus, $I_{\mathcal{P}_k} \subseteq \sum_{C \in \mathcal{C}_k} I_{\mathcal{P}_{k-1} \cup \{C\}}$. Now, it suffices to show that $I_{\mathcal{P}_{k-1} \cup \{C\}} \in C_f$ for all $C \in \mathcal{C}$.

We claim that $f_k \in I_{\mathcal{P}_{k-1} \cup \{C\}}$ for $C \in \mathcal{C}_k$. Recall from the proof of Lemma 4.3,

$$f_k = \sum_{\sigma \in S_{n_k}} (-1)^{\text{sgn}(\sigma)} x_{i_k+1, j_k+\sigma(1)} x_{i_k+2, j_k+\sigma(2)} \cdots x_{i_k+n_k, j_k+\sigma(n_k)}.$$

where S_{n_k} denotes the symmetric group on n_k symbols, and $\text{sgn}(\sigma)$ denotes the sign of the permutation σ , which is 1 if σ is even and -1 if σ is odd. Some of the monomials in the summation might not be present. By Lemma 4.8, \mathcal{P}_k contains the polyomino shown in Figure 16 as a sub-polyomino, call it \mathcal{Q} . Moreover, by the proof of Lemma 4.8, the polyomino \mathcal{P}_{k-1} contains the polyomino $\mathcal{Q} \setminus \mathcal{C}_k$ as a sub-polyomino. So by Lemma 4.7, $f_k \in I_{\mathcal{P}_{k-1} \cup \{C\}}$ for all $C \in \mathcal{C}_k$.

Observe that $I_{\mathcal{P}_{k-1}}$ and $I_{\mathcal{P}_{k-1} \cup \{C\}}$ are prime ideals for every $C \in \mathcal{C}_k$ by Lemma 4.8 and [HSM14, Corollary 2.2]. Also, note that $(f_k) \in C_f$. Therefore, $I_{\mathcal{P}_{k-1}} + (f_k) \in C_f$. Since $f_k \notin I_{\mathcal{P}_{k-1}}$ by Lemma 4.7, we have $\text{height}(I_{\mathcal{P}_{k-1}} + (f_k)) = \text{height}(I_{\mathcal{P}_{k-1}}) + 1$. Thus, $I_{\mathcal{P}_{k-1} \cup \{C\}}$ is a minimal prime over $I_{\mathcal{P}_{k-1}} + (f_k)$, which implies $I_{\mathcal{P}_{k-1} \cup \{C\}} \in C_f$. Hence the proof. \square

Remark 4.9. Under the notations of Discussion 4.2, define

$$g := \prod_{\substack{k \in \{1, \dots, s\} \\ \text{with } |V_k| \geq 2}} f_k.$$

Then, one can use similar argument of proof of Theorem 4.1 to get that $I_{\mathcal{P}} \in C_g$ if \mathcal{P} is a ladder polyomino. It holds because if $|V_k| = 1$ for some k , then $\mathcal{P}_k = \mathcal{P}_{k-1}$.

Given a cell $C = [a, a + (1, 1)]$, we define $\text{sp}(C) = \{x \in \mathbb{R}^2 : a \leq x \leq a + (1, 1)\}$. Let \mathcal{P} be a collection of cells, define $\text{sp}(\mathcal{P}) = \cup_{C \in \mathcal{P}} \text{sp}(C) \subset \mathbb{R}^2$. Let \mathcal{P} be a ladder polyomino with the set of left-most vertices $\{a_1 = (a_{1,1}, a_{1,2}), \dots, a_r = (a_{r,1}, a_{r,2})\}$. Recall that $a_{i+1,2} = a_{i,2} + 1$ for all $1 \leq i \leq r - 1$. Let $b = \max\{v \in \mathbb{N} \mid (v, a_{1,2}) \in V(\mathcal{P})\}$. Since \mathcal{P} is horizontally convex, the horizontal edge interval $[a_1, (b, a_{1,2})]$ is in \mathcal{P} . We say that \mathcal{P} is *based on* a polyomino \mathcal{Q} , if $\text{sp}(\mathcal{P}) \cap \text{sp}(\mathcal{Q}) = [a_1, (b, a_{1,2})]$, here $[a_1, (b, a_{1,2})]$ is the closed interval in \mathbb{R}^2 .

In the proof of Theorem 4.1, we utilized the hypothesis that \mathcal{P} is a ladder polyomino to apply Lemma 4.8. The proof goes through for any polyomino for which Lemma 4.8 holds true. Notably, instead of (2) of Lemma 4.8, it suffices to assume that the ideals $I_{\mathcal{P}_k}$ and $I_{\mathcal{P}_k \cup \{C\}}$ are prime for all $C \in \mathcal{C}_{k+1}$. This leads us to the following result:

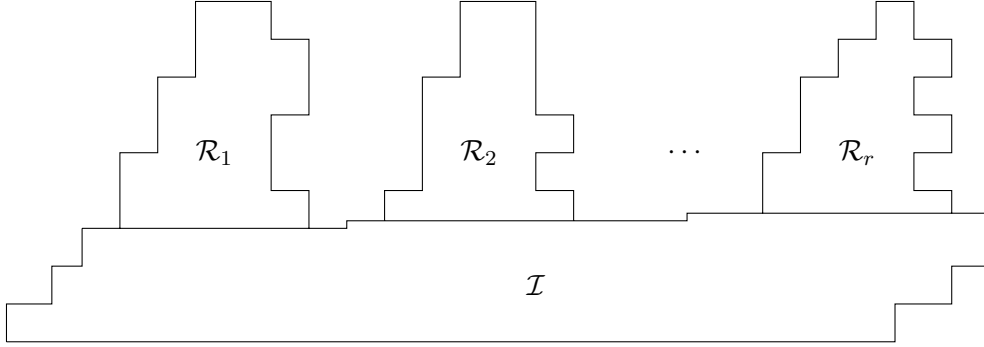

FIGURE 17

Proposition 4.10. *Let \mathcal{P} be the polyomino as shown in Figure 17, where \mathcal{I} is a parallelogram polyomino and $\mathcal{R}_1, \dots, \mathcal{R}_r$ are ladder sub-polyominoes based on \mathcal{I} such that $V(\mathcal{R}_i) \cap V(\mathcal{R}_j) = \emptyset$ for $i \neq j$. Then, $I_{\mathcal{P}} \in C_f$, where f is as defined in Discussion 4.2. In fact $I_{\mathcal{P}} \in C_g$, where g is as defined in Remark 4.9.*

Proof. Follow Discussion 4.2 to define V_k 's and \mathcal{P}_k 's for \mathcal{P} . For $1 \leq k \leq s$, note that the vertex set V_k is contained in $\mathcal{I} \cup \mathcal{R}_i$ for some $1 \leq i \leq r$. If V_k is contained in $V(\mathcal{I})$ (resp. $V(\mathcal{R}_i)$) then by Lemma 4.8, \mathcal{P}_k contains the polyomino shown in Figure 16 as a sub-polyomino because \mathcal{I} (resp. \mathcal{R}_i) is a ladder polyomino. If $V_k \cap V(\mathcal{R}_i) \neq \emptyset$ and $V_k \cap V(\mathcal{I}) \neq \emptyset$, then define a sub-polyomino \mathcal{I}_k of \mathcal{P} as the cells of \mathcal{P}_k contained in \mathcal{I} or \mathcal{R}_i . Note that \mathcal{I}_k is a ladder polyomino because \mathcal{I} and \mathcal{R}_i are ladder polyominoes, and \mathcal{R}_i is based on \mathcal{I} . So by Lemma 4.8, \mathcal{I}_k contains the polyomino shown in Figure 16 as a sub-polyomino. By following the argument of Lemma 4.8, and the assumption $V(\mathcal{R}_i) \cap V(\mathcal{R}_j) = \emptyset$ for $i \neq j$, we get that \mathcal{P}_k is a simple sub-polyomino of \mathcal{P} . We can now use the argument of proof of Theorem 4.1 to show that $I_{\mathcal{P}} \in C_f$. Moreover, $I_{\mathcal{P}} \in C_g$ by Remark 4.9. \square

Proposition 4.11. *Let \mathcal{P} be as defined in Proposition 4.10 such that $\mathcal{R}_1, \dots, \mathcal{R}_r$ are parallelogram polyominoes. Then, the set of all quadratic binomials corresponding to inner intervals of \mathcal{P} form a Gröbner basis of $I_{\mathcal{P}}$ under the order $<$ as defined in Discussion 4.2.*

Proof. We apply Buchberger's criterion. Let $f = x_a x_d - x_b x_c$ and $g = x_{a'} x_{d'} - x_{b'} x_{c'}$ be two quadratic binomials corresponding to inner intervals I and J of \mathcal{P} respectively. Let a and d (resp. a' and d') be the anti-diagonal vertices of I (resp. J). Then, $\text{in}_{<}(f) = x_a x_d$ and $\text{in}_{<}(g) = x_{a'} x_{d'}$. If $\{a, d\} \cap \{a', d'\} = \emptyset$, then by [HHO18, Lemma 1.27], the S -pair $S(f, g)$ reduces to zero. On the other hand, if $\{a, d\} = \{a', d'\}$, then the inner interval $I = J$; thus $f = g$. So, we may assume that $|\{a, d\} \cap \{a', d'\}| = 1$, say $a = a'$.

Since $\mathcal{I}, \mathcal{R}_1, \dots, \mathcal{R}_r$ are parallelogram polyominoes, the K -algebras $K[\mathcal{I}], K[\mathcal{R}_1], \dots, K[\mathcal{R}_r]$ are the Hibi rings associated to the vertex sets $V(\mathcal{I}), V(\mathcal{R}_1), \dots, V(\mathcal{R}_r)$ respectively, which are

distributive lattices (see [KV23b], [QRR22, Remark 2.4]). When both inner intervals I and J are contained in one of the sub-polyominoes $\mathcal{I}, \mathcal{R}_1, \dots, \mathcal{R}_r$. Then, $S(f, g)$ reduces to zero by [HHO18, Theorem 6.17] (after noting that the monomial order $<$ is a “compatible order” as defined in [HHO18, Section 6.2]).

Consider the case when these inner intervals I and J are not contained in one of these sub-polyominoes. If $\text{sp}(I) \cap \text{sp}(J) \neq \{a\}$, then $I \cup J$ is a parallelogram polyomino. Again, by [HHO18, Theorem 6.17], $S(f, g)$ reduces to zero. So, we may assume that $\text{sp}(I) \cap \text{sp}(J) = \{a\}$. Since I and J intersects, these intervals must be contained in the sub-polyomino consists of cells of \mathcal{I} and \mathcal{R}_i for some $1 \leq i \leq r$. We may assume that the inner interval I intersects with \mathcal{I} and the inner interval J intersects with \mathcal{R}_i . Note that $d \notin V(\mathcal{R}_i)$; otherwise, both I and J must be contained in \mathcal{R}_i because \mathcal{R}_i is based on \mathcal{I} . Similarly, $d' \notin V(\mathcal{I})$. Consequently, $b \notin V(\mathcal{R}_i)$ and $b' \notin V(\mathcal{I})$ because \mathcal{R}_i is based on \mathcal{I} . Without loss of generality, assume that b (resp. b') is the lower-left vertex of I (resp. J).

If $b' \in V(\mathcal{I})$, then $b' \wedge b \in V(\mathcal{I})$ because $V(\mathcal{I})$ is a sub-lattice of \mathbb{N}^2 , where \wedge denotes the meet in the distributive lattice \mathbb{N}^2 . Since \mathcal{I} is convex, the interval $[b' \wedge b, a]$ is an inner interval of \mathcal{I} . Thus, $[b' \wedge b, c']$ and $[b' \wedge b, c]$ are inner intervals of $\mathcal{I} \cup \mathcal{R}_i$. So we get that,

$$S(f, g) = x_{c'}(x_d x_{b'} - x_c x_{b' \wedge b}) - x_c(x_b x_{d'} - x_{c'} x_{b' \wedge b})$$

which reduced to zero.

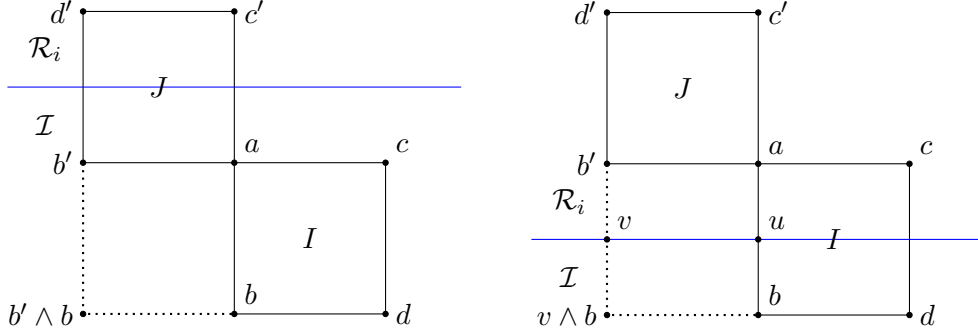

Consider the case when $b' \notin V(\mathcal{I})$. So, $b' \in V(\mathcal{R}_i)$. Since \mathcal{R}_i is based on \mathcal{I} , we get that $a \in V(\mathcal{R}_i)$. Since $a \in V(\mathcal{R}_i)$, $b \in V(\mathcal{I})$ and the inner interval I is in $\mathcal{I} \cup \mathcal{R}_i$, we get that there is a $u = (u_1, u_2) \in V(\mathcal{I}) \cap V(\mathcal{R}_i)$ such that $b \leq u \leq a$. Since $V(\mathcal{R}_i)$ is a sub-lattice of \mathbb{N}^2 , we get that $u \wedge b' \in V(\mathcal{R}_i)$, call it $v = (v_1, v_2)$. Since \mathcal{R}_i is convex, the interval $[v, a]$ is an inner interval of \mathcal{R}_i . Moreover, $v \in V(\mathcal{I})$ because $u_2 = v_2$ and \mathcal{R}_i is based on \mathcal{I} . Thus, $v \wedge b \in V(\mathcal{I})$. Furthermore, the interval $[v \wedge b, u]$ is an inner interval of \mathcal{I} because \mathcal{I} is convex. Thus, $[v \wedge b, c']$ and $[v \wedge b, c]$ are inner intervals of $\mathcal{I} \cup \mathcal{R}_i$. So we get that,

$$S(f, g) = x_{c'}(x_d x_{b'} - x_c x_{v \wedge b}) - x_c(x_b x_{d'} - x_{c'} x_{v \wedge b})$$

which reduced to zero. □

5. KNOTSON THIN POLYOMINOES II

In this section, we apply the tools developed in the previous section to prove that binomials ideals of a class of thin collection to cells are Knutson. We also compute its Gröbner basis. As a consequence we prove that when this collection of cells is a polyomino, then the corresponding polyomino ideal is prime.

Theorem 5.1. *Let \mathcal{P} be a thin collection of cells such that*

- (1) *it does not contain cells as in Figure 18a;*
- (2) *if I is a maximal inner interval of \mathcal{P} with vertices (i_1, j_1) , (i_1+1, j_1) , (i_1, j_2) and (i_1+1, j_2) (see Figure 18b), then the cell with lower-right vertex (i_1, j_2) and the cell with upper-left vertex (i_1+1, j_1) are not contained in \mathcal{P} ;*

(3) if I is a maximal inner interval of \mathcal{P} with vertices (i_1, j_1) , (i_1, j_1+1) , (i_2, j_1) and (i_2, j_1+1) (see Figure 18c), then the cell with lower-right vertex (i_1, j_1+1) and the cell with upper-left vertex (i_2, j_1) are not contained in \mathcal{P} .

Then, there exists an $f \in S$ such that $I_{\mathcal{P}} \in C_f$, that is, $I_{\mathcal{P}}$ is a Knutson ideal.

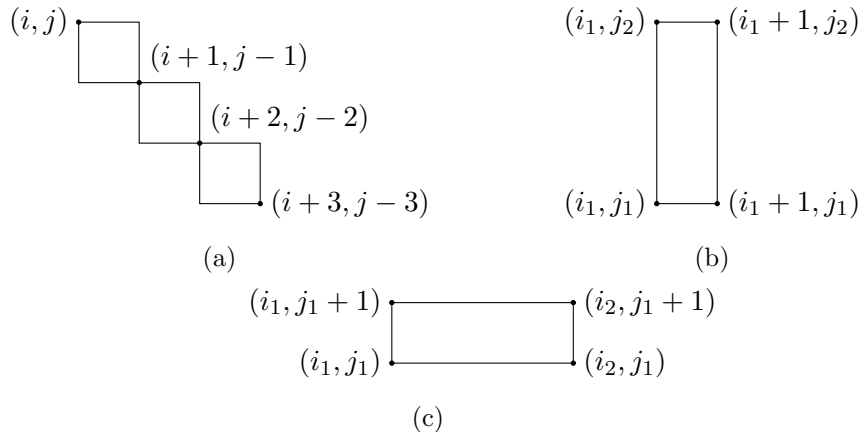

FIGURE 18

Consider the polyomino \mathcal{P} shown in Figure 19. \mathcal{P} satisfies the hypothesis of Theorem 5.1 even though it contain a collection of cells isomorphic to as cells shown in Figure 18a. That is why the labeling in Figure 18a is important.

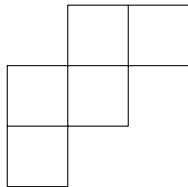

FIGURE 19

Proof. For \mathcal{P} , let f be as defined in Discussion 4.2. We show that $I_{\mathcal{P}} \in C_f$. By Lemma 4.3, $\text{in}_{<}(f) = \prod_{v \in V(\mathcal{P})} x_v$. Let $\{J_1, \dots, J_r\}$ be the set of all maximal inner intervals of \mathcal{P} . Then $I_{\mathcal{P}} = \sum_{i=1}^r I_{J_i}$, where I_{J_i} denotes the polyomino ideal associated to the maximal inner interval J_i . So, it suffice to show that each $I_{J_i} \in C_f$ for all $1 \leq i \leq r$. Let J be a maximal inner interval of \mathcal{P} . Let $\mathcal{C}_{i_1}, \dots, \mathcal{C}_{i_m}$ be the set of cells (as defined in Discussion 4.2) such that $\mathcal{C}_{i_k} \cap J \neq \emptyset$ for all k . Since \mathcal{P} is thin, $\mathcal{C}_{i_k} \cap J$ is a cell, say C_k for all $1 \leq k \leq m$. Thus, J is a maximal inner interval consisting of cells C_1, \dots, C_m . Without loss of generality, assume that $i_1 < i_2 < \dots < i_m$. Thus, C_1 is an end-cell of J , and C_k and C_{k+1} are neighbour cells for all $1 \leq k \leq m-1$.

Fix a k with $1 \leq k \leq m$. Since $\mathcal{C}_{i_k} \neq \emptyset$, we have $|V_{i_k}| \geq 2$. Also, since \mathcal{P} does not contain cells as in Figure 18a, $|V_{i_k}| \leq 3$. If $|V_{i_k}| = 2$, then it follows that $f_{i_k} = I_{C_k} \subseteq I_J$, where I_{C_k} denotes the polyomino ideal associated to the cell C_k , and f_{i_k} is as defined in Discussion 4.2. Now, consider the case when $|V_{i_k}| = 3$ and $1 < k < m$. Since $|V_{i_k}| = 3$, it follows that $|\mathcal{C}_{i_k}| = 2$; we know $C_k \in \mathcal{C}_{i_k}$, let the other cell in \mathcal{C}_{i_k} is denoted by D . The cell D is either a neighbour cell of C_{k-1} or a neighbour cell of C_{k+1} . If D is a neighbour cell of C_{k-1} (see Figure 20a), we have $f_{i_k} \in I_{C_{k-1} \cup C_k}$ by Lemma 4.7. If D is a neighbour cell of C_{k+1} (see Figure 20b), then again by Lemma 4.7, we get that $f_{i_k} \in I_{C_k \cup C_{k+1}}$. Thus, $f_{i_k} \in I_J$ in both cases.

Now consider the case when $|V_{i_k}| = 3$ and $k \in \{1, m\}$. we know $C_1 \in \mathcal{C}_{i_1}$ (resp. $C_m \in \mathcal{C}_{i_m}$), let the other cell in \mathcal{C}_{i_1} (resp. \mathcal{C}_{i_m}) is denoted by D . We know $C_1 \in \mathcal{C}_{i_1}$, let the other cell in \mathcal{C}_{i_1} is denoted by D . When J is as defined in (2) of theorem. Since \mathcal{P} does not contain the cell with

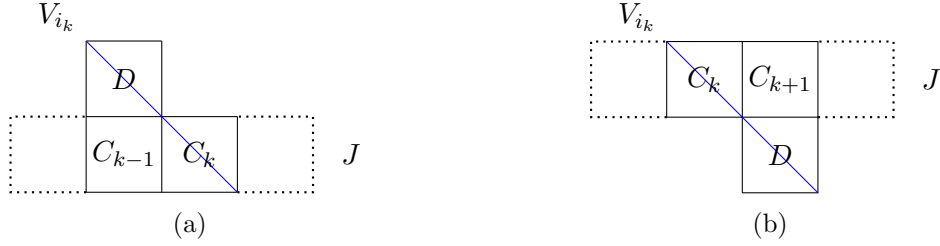

FIGURE 20

lower-right vertex (i_1, j_2) , it follows that $V_{i_1} = \{(i_1, j_2), (i_1+1, j_2-1), (i_1+2, j_2-1)\}$. Thus, D is a neighbour cell of C_2 . When J is as defined in (3) of theorem. Since \mathcal{P} does not contain the cell with lower-right vertex (i_1, j_1+1) , we get that $V_{i_1} = \{(i_1, j_1+1), (i_1+1, j_1), (i_1+2, j_1-1)\}$. Thus, D is a neighbour cell of C_2 . Similarly, the other cell of \mathcal{C}_{i_k} is a neighbour cell of C_{k-1} in both subcases. Using the earlier argument, we get that $f_{i_1}, f_{i_m} \in I_J$. Thus, $(f_{i_1}, f_{i_2}, \dots, f_{i_m}) \subseteq I_J$.

Note that $(f_{i_k}) \in C_f$ for all $1 \leq k \leq m$, and consequently the ideal $(f_{i_1}, f_{i_2}, \dots, f_{i_m}) \in C_f$. Since $\text{in}_{<}(f_{i_k}) = \prod_{v \in V_{i_k}} x_v$ for all k and the set V_{i_k} 's are disjoint, we get that $\{f_{i_1}, f_{i_2}, \dots, f_{i_m}\}$ forms a Gröbner basis of $(f_{i_1}, f_{i_2}, \dots, f_{i_m})$ by [HHO18, Lemma 1.27], and also we get the that height of the ideal $(\text{in}_{<}(f_{i_1}), \dots, \text{in}_{<}(f_{i_m}))$ is m ; Thus $\text{height}((f_{i_1}, f_{i_2}, \dots, f_{i_m})) = m$. Since I_J is a prime polyomino ideal of height m , it is a minimal prime ideal of $(f_{i_1}, f_{i_2}, \dots, f_{i_m})$; therefore, $I_J \in C_f$. Hence the proof. \square

Corollary 5.2. *Let \mathcal{P} be a thin collection of cells as defined in Theorem 5.1. Then, the set of all binomials corresponding to inner intervals of \mathcal{P} forms a Gröbner basis of $I_{\mathcal{P}}$ under the order $<$ as defined in Discussion 4.2. Moreover, when \mathcal{P} is a polyomino, then $I_{\mathcal{P}}$ is in fact a prime ideal.*

Proof. Recall from the proof of Theorem 5.1, that $I_{\mathcal{P}} = \sum I_J$ where the summation runs over all the maximal inner intervals J of \mathcal{P} , and each $I_J \in C_f$ where f is as defined in Discussion 4.2. Therefore, the union of Gröbner bases of Knutson ideals I_J under the monomial order $<$, is a Gröbner basis of $I_{\mathcal{P}}$ under the same monomial order. So it suffice to show that the set of all binomials corresponding to inner intervals of a maximal inner interval J of \mathcal{P} form a Gröbner basis of I_J under the order $<$.

When J is an inner interval, the K -algebra $K[J]$ is the Hibi ring associated to the vertex set $V(J)$ which is a distributive lattice (see [KV23b], [QRR22, Remark 2.4]). By [HHO18, Theorem 6.17], the set of all binomials corresponding to inner intervals of J form a Gröbner basis of I_J under the order $<$.

The term order $<$ is the order $<^4$ defined in [MRR22]. Since the minimal generating set of $I_{\mathcal{P}}$ forms a reduced Gröbner basis, $I_{\mathcal{P}}$ is prime by [MRR22, Corollary 3.3]. \square

The polyominoes \mathcal{P}_1 and \mathcal{P}_2 shown in Figures 19 and 21 satisfies the hypothesis of Theorem 5.1 respectively. Thus, for $i = 1, 2$, $I_{\mathcal{P}_i}$ is a Knutson prime ideal and the set of all binomials corresponding to inner intervals of \mathcal{P}_i forms a Gröbner basis of $I_{\mathcal{P}_i}$ under the order $<$.

Remark 5.3. Let \mathcal{P} be a thin collection of cells such that

- (1) it does not contain cells as in Figure 22;
- (2) if I is a maximal inner interval of \mathcal{P} with vertices $(i_1, j_1), (i_1+1, j_1), (i_1, j_2)$ and (i_1+1, j_2) (see Figure 18b), then the cell with upper-right vertex (i_1, j_1) and the cell with lower-left vertex (i_1+1, j_2) are not contained in \mathcal{P} ;
- (3) if I is a maximal inner interval of \mathcal{P} with vertices $(i_1, j_1), (i_1, j_1+1), (i_2, j_1)$ and (i_2, j_1+1) (see Figure 18c), then the cell with upper-right vertex (i_1, j_1) and the cell with lower-left vertex (i_2, j_1+1) are not contained in \mathcal{P} .

Let $k \in \mathbb{N}$ be such that $(a, b) \notin V(\mathcal{P})$ for any $a, b \in \mathbb{N}$ with $a \geq k$. Let \mathcal{Q} be the collection of cells obtained by reflecting \mathcal{P} across the line $x = k$. Note that \mathcal{Q} satisfies the hypothesis of Theorem 5.1. Also, one can see that there is an isomorphism $\varphi : S_{\mathcal{P}} = K[x_v : v \in V(\mathcal{P})] \rightarrow$

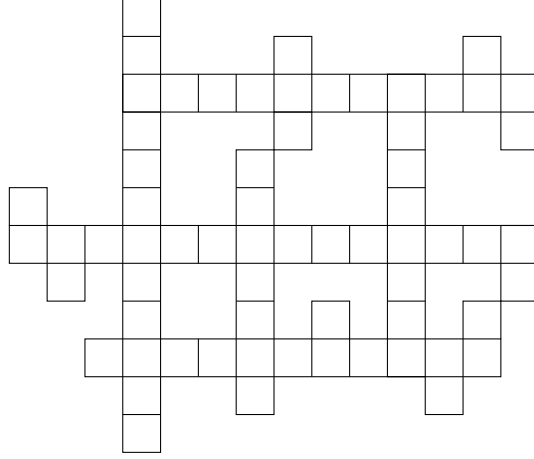

FIGURE 21

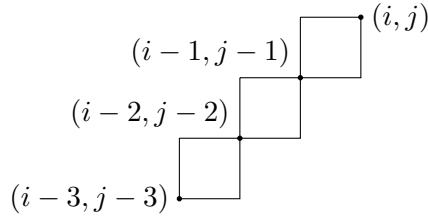

FIGURE 22

$S_{\mathcal{Q}} = K[x_v : v \in V(\mathcal{Q})]$ defined as $\varphi(x_v = x_{(k-i,j)}) = x_{(k+i,j)}$. Then, $\varphi(I_{\mathcal{P}}) = I_{\mathcal{Q}}$. Therefore, we get that $I_{\mathcal{P}}$ is a Knutson ideal and the set of all binomials corresponding to inner intervals of \mathcal{P} forms a Gröbner basis of $I_{\mathcal{P}}$. Moreover, when \mathcal{P} is a polyomino, then $I_{\mathcal{P}}$ is a prime ideal. \square

Proposition 5.4. *Let \mathcal{P} be a thin polyomino such that if two maximal inner intervals of \mathcal{P} intersects, then their intersection is a cell. Then $I_{\mathcal{P}}$ is a prime ideal.*

Proof. Let $<$ be the reverse lexicographic order on S induced by the following total order on variables of S : for $(i, j), (k, l) \in V(\mathcal{P})$, $x_{i,j} < x_{k,l}$, if $j < l$, or $l = j$ and $i < k$. Under the hypothesis, by [JN24, Theorem 2.1], the set of binomials corresponding to inner intervals of \mathcal{P} forms the reduced Gröbner basis of $I_{\mathcal{P}}$ with respect to $<$. Also, note that the monomial order $<$ is the monomial order $<^6$ defined in [MRR22]. Thus, by [MRR22, Corollary 3.3], $I_{\mathcal{P}}$ is a prime ideal. \square

6. SOME KNOTSON COLLECTION OF CELLS

In Section 4, we proved that the polyomino ideals associated with parallelogram polyominoes are Knutson. We now ask whether extracting a polyomino from a parallelogram polyomino is Knutson or not. In this section, we show that under certain hypothesis they are Knutson.

Proposition 6.1. *Let \mathcal{P} be a collection of cells such that $\mathcal{P} = \mathcal{P}_1 \cup \mathcal{P}_2$, where \mathcal{P}_1 and \mathcal{P}_2 are sub-collections of cells of \mathcal{P} with $\mathcal{P}_1 \cap \mathcal{P}_2 = \{v\}$, a vertex of \mathcal{P} . Suppose that for each i , $I_{\mathcal{P}_i} \in C_{f_i}$ for some $f_i \in S$ and $\gcd(x_v, \text{in}_{<}(f_i)) = 1$. Then, there exists an $f \in S$ such that $I_{\mathcal{P}} \in C_f$, that is, $I_{\mathcal{P}}$ is a Knutson ideal.*

Proof. Take $f = f_1 f_2 x_v$. By Lemma 2.4, $I_{\mathcal{P}_i} \in C_f$ for $i = 1, 2$. Now the result follows from the fact that $I_{\mathcal{P}} = I_{\mathcal{P}_1} + I_{\mathcal{P}_2}$. \square

Let \mathcal{Q} be a parallelogram polyomino. Let \mathcal{Q}' be a sub-polyomino of \mathcal{Q} which is also a parallelogram polyomino. Define $\mathcal{P} = \mathcal{Q} \setminus \mathcal{Q}'$. Note that \mathcal{P} may not be a polyomino. Assume

the notations of Discussion 4.2 for the collection of cells \mathcal{P} . Set $a = \min\{i : V_i \cap V(\mathcal{Q}') \neq \emptyset\}$ and $b = \max\{i : V_i \cap V(\mathcal{Q}') \neq \emptyset\}$. Define

$$\mathcal{Q}_1 = \mathcal{P}_{b-1} = \cup_{i < b} \mathcal{C}_i$$

and

$$\mathcal{Q}_2 = \cup_{i > a} \mathcal{C}_i.$$

Note that \mathcal{Q}_1 and \mathcal{Q}_2 may not be polyominoes, for example see Figure 23.

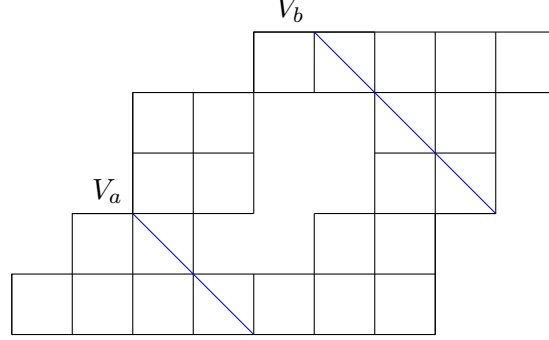

FIGURE 23

Theorem 6.2. *Under the notations as above, if $I_{\mathcal{Q}_1} + I_{\mathcal{Q}_2} = I_{\mathcal{P}}$, then $I_{\mathcal{P}}$ is Knutson.*

Proof. We show that $I_{\mathcal{P}} \in C_f$, where f is as defined in Discussion 4.2. It is enough to show that $I_{\mathcal{Q}_1}, I_{\mathcal{Q}_2} \in C_f$. Let $h_1 = \cup_{i < b} f_i$ and $h_2 = \cup_{i > a} f_i$, where f_i is as defined in Discussion 4.2. By Lemma 2.4, it suffices to show that $I_{\mathcal{Q}_i} \in C_{h_i}$ for all $i = 1, 2$.

We first assume that \mathcal{P} is non-simple. We show that $I_{\mathcal{Q}_1} \in C_{h_1}$. Notice that if \mathcal{Q}_1 is a polyomino, then it is of the form as defined in Proposition 4.10. Otherwise, it is union of polyominoes $\mathcal{R}, \mathcal{R}_1^L, \dots, \mathcal{R}_r^L, \mathcal{R}_1^R, \dots, \mathcal{R}_s^R$, where \mathcal{R} is a polyomino as defined in Proposition 4.10 and \mathcal{R}_i^L 's and \mathcal{R}_j^R 's are parallelogram polyominoes such that

(1) $\mathcal{R} \cap \mathcal{R}_1^L$ (resp. $\mathcal{R} \cap \mathcal{R}_1^R$) is a vertex, say v_1^L (resp. v_1^R); it is the minimal element of \mathcal{R}_1^L (resp. \mathcal{R}_1^R) and it is the maximal element of $V(\mathcal{R}_1)$ (resp. $V(\mathcal{R}_2)$), where $\mathcal{R}_1, \mathcal{R}_2$ are as defined in Proposition 4.10 for \mathcal{R} .

(2) $\mathcal{R}_i^L \cap \mathcal{R}_{i+1}^L$ is a vertex, say v_{i+1}^L ; it is the maximal element of $V(\mathcal{R}_i^L)$ and the minimal element of $V(\mathcal{R}_{i+1}^L)$ for $1 \leq i \leq r-1$.

(3) $\mathcal{R}_j^R \cap \mathcal{R}_{j+1}^R$ is a vertex, say v_{i+1}^R ; it is the maximal element of $V(\mathcal{R}_j^R)$ and the minimal element of $V(\mathcal{R}_{j+1}^R)$ for $1 \leq i \leq s-1$.

See Figure 24 for a schematic showing of the polyominoes $\mathcal{R}, \mathcal{R}_1^L, \dots, \mathcal{R}_r^L, \mathcal{R}_1^R, \dots, \mathcal{R}_s^R$.

If \mathcal{Q}_1 is a polyomino, then we are done by Proposition 4.10. So, we may assume that \mathcal{Q}_1 is not a polyomino. Let $g, g_1^L, \dots, g_r^L, g_1^R, \dots, g_s^R$ be the polynomials as defined in Remark 4.9 for $\mathcal{R}, \mathcal{R}_1^L, \dots, \mathcal{R}_r^L, \mathcal{R}_1^R, \dots, \mathcal{R}_s^R$ respectively. Note that

$$h_1 = x_v g x_{v_1^L} g_1^L x_{v_2^L} g_2^L \cdots x_{v_r^L} g_r^L x_{v_1^R} g_1^R x_{v_2^R} g_2^R \cdots x_{v_s^R} g_s^R.$$

We have that $I_{\mathcal{R}} \in C_g$ by Proposition 4.10. Moreover, by Remark 4.9, $I_{\mathcal{R}_i^L} \in C_{g_i^L}$ for all $1 \leq i \leq r$ and $I_{\mathcal{R}_j^R} \in C_{g_j^R}$ for all $1 \leq i \leq s$. We now use Proposition 6.1 repeatedly to get that $I_{\mathcal{Q}_1} \in C_{h_1}$. Using a similar argument, one gets that $I_{\mathcal{Q}_2} \in C_{h_2}$.

Consider the case when \mathcal{P} is simple. Note that if \mathcal{Q}_1 is a polyomino, then we are done by Proposition 4.10 as before. When \mathcal{Q}_1 is not a polyomino, then it is a collection of cells as defined above or it is a collection of cells as defined above with \mathcal{R} , few of \mathcal{R}_i^L 's and \mathcal{R}_j^R 's are missing. In either case, by similar argument of non-simple case, one concludes that $I_{\mathcal{Q}_1} \in C_{h_1}$. Similarly, $I_{\mathcal{Q}_2} \in C_{h_2}$. \square

We now give a characterization when $I_{\mathcal{Q}_1} + I_{\mathcal{Q}_2} = I_{\mathcal{P}}$.

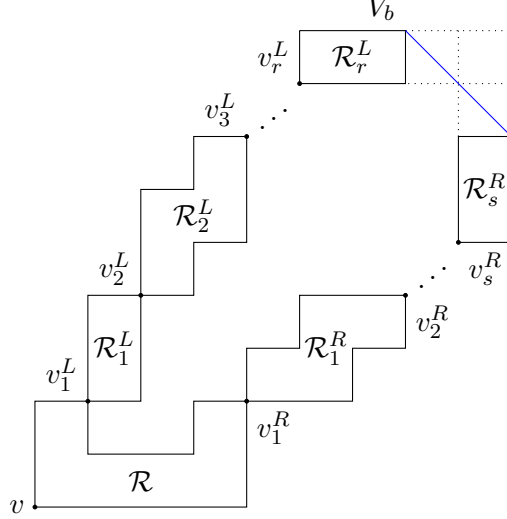

FIGURE 24

Proposition 6.3. *Under the notations as above, $I_{\mathcal{Q}_1} + I_{\mathcal{Q}_2} = I_{\mathcal{P}}$ if and only if there is no inner interval of \mathcal{P} that contain cells from both \mathcal{C}_a and \mathcal{C}_b .*

Proof. Since \mathcal{Q}_1 and \mathcal{Q}_2 are sub-collections of cells of \mathcal{P} , $I_{\mathcal{Q}_1} + I_{\mathcal{Q}_2} \subseteq I_{\mathcal{P}}$. Also, note that by definition of \mathcal{Q}_1 and \mathcal{Q}_2 , no cell from \mathcal{C}_b is included in \mathcal{Q}_1 , and no cell from \mathcal{C}_a is included in \mathcal{Q}_2 .

(\implies) On the contrary, assume that J is an inner interval of \mathcal{P} that contains cells from both \mathcal{C}_a and \mathcal{C}_b . This means that J cannot be an inner interval of either \mathcal{Q}_1 or \mathcal{Q}_2 . Therefore, the generator of $I_{\mathcal{P}}$ corresponding to J does not belong to $I_{\mathcal{Q}_1}$ and $I_{\mathcal{Q}_2}$. Then, one can deduce that, $I_{\mathcal{P}} \not\subseteq I_{\mathcal{Q}_1} + I_{\mathcal{Q}_2}$ which is a contradiction.

(\impliedby) It suffices to show that every inner interval of \mathcal{P} is also an inner interval of either \mathcal{Q}_1 or \mathcal{Q}_2 . On the contrary, assume that I is an inner interval of \mathcal{P} that is not an inner interval of either \mathcal{Q}_1 or \mathcal{Q}_2 . This implies that I contains cells from \mathcal{C}_i for some $i \leq a$ and from \mathcal{C}_j for some $j \geq b$. Since I is an inner interval and, by definition of V_i 's, it must also contain cells from both \mathcal{C}_a and \mathcal{C}_b . This leads to a contradiction. \square

Proposition 6.4. *Let \mathcal{P} , \mathcal{Q}_1 and \mathcal{Q}_2 be as above such that $I_{\mathcal{Q}_1} + I_{\mathcal{Q}_2} = I_{\mathcal{P}}$. Then, the set of all quadratic binomials corresponding to inner intervals of \mathcal{P} form a Gröbner basis of $I_{\mathcal{P}}$ under the order $<$ as defined in Discussion 4.2.*

Proof. Since $I_{\mathcal{Q}_1}, I_{\mathcal{Q}_2} \in \mathcal{C}_f$ by Theorem 6.2, and $I_{\mathcal{Q}_1} + I_{\mathcal{Q}_2} = I_{\mathcal{P}}$, it suffices to prove the result for \mathcal{Q}_1 and \mathcal{Q}_2 . We first proceed for \mathcal{Q}_1 .

When \mathcal{Q}_1 is a polyomino, it is as defined in Proposition 4.10 such that \mathcal{R}_1 and \mathcal{R}_2 are two polyominoes based on a polyomino \mathcal{I} , where $\mathcal{I}, \mathcal{R}_1$ and \mathcal{R}_2 are as defined in Proposition 4.10. Since \mathcal{P} is obtained by removing a parallelogram polyomino from a parallelogram polyomino, the polyominoes $\mathcal{I}, \mathcal{R}_1$ and \mathcal{R}_2 are also parallelogram polyominoes. So we are done by Proposition 4.11.

On the other hand, when \mathcal{Q}_1 is not a polyomino, it is a collection of cells as defined in the proof of Theorem 6.2. Assume the notations of proof of Theorem 6.2. Note that \mathcal{R} is a polyomino as described in the previous case. Moreover, Since \mathcal{R}_i^L 's and \mathcal{R}_j^R 's are parallelogram polyominoes, the K -algebras $K[\mathcal{R}_i^L]$'s and $K[\mathcal{R}_j^R]$'s are the Hibi ring associated to the vertex sets $V(\mathcal{R}_i^L)$'s and $V(\mathcal{R}_j^R)$ which are distributive lattices (see [KV23b], [QRR22, Remark 2.4]). By [HHO18, Theorem 6.17], the set of all binomials corresponding to inner intervals of \mathcal{R}_i^L 's and \mathcal{R}_j^R 's form a Gröbner basis of $I_{\mathcal{R}_i^L}$'s and $I_{\mathcal{R}_j^R}$'s under the order $<$. Since $I_{\mathcal{Q}_1} = I_{\mathcal{R}} + \sum_{i=1}^r I_{\mathcal{R}_i^L} + \sum_{j=1}^s I_{\mathcal{R}_j^R}$, the result follows for \mathcal{Q}_1 .

Using a similar argument, one get that the set of all quadratic binomials corresponding to inner intervals of \mathcal{Q}_2 form a Gröbner basis of $I_{\mathcal{Q}_2}$ under the order $<$ \square

REFERENCES

- [CH97] Aldo Conca and Jürgen Herzog. Ladder determinantal rings have rational singularities. *Adv. Math.*, 132(1):120–147, 1997.
- [CN23] Carmelo Cisto and Francesco Navarra. Primality of closed path polyominoes. *J. Algebra Appl.*, 22(2):Paper No. 2350055, 29, 2023.
- [CNU22a] Carmelo Cisto, Francesco Navarra, and Rosanna Utano. On Gröbner basis and Cohen-Macaulay property of closed path polyominoes. *Electron. J. Combin.*, 29(3):Paper No. 3.54, 22, 2022.
- [CNU22b] Carmelo Cisto, Francesco Navarra, and Rosanna Utano. Primality of weakly connected collections of cells and weakly closed path polyominoes. *Illinois J. Math.*, 66(4):545–563, 2022.
- [CNU23] Carmelo Cisto, Francesco Navarra, and Rosanna Utano. Hilbert-Poincaré series and Gorenstein property for some non-simple polyominoes. *Bull. Iranian Math. Soc.*, 49(3):Paper No. 22, 26, 2023.
- [CNV24] Carmelo Cisto, Francesco Navarra, and Dharm Veer. Polyocollection ideals and primary decomposition of polyomino ideals. *Journal of Algebra*, 641:498–529, 2024.
- [Con95] Aldo Conca. Ladder determinantal rings. *J. Pure Appl. Algebra*, 98(2):119–134, 1995.
- [Con96] Aldo Conca. Gorenstein ladder determinantal rings. *J. London Math. Soc. (2)*, 54(3):453–474, 1996.
- [CV20] Aldo Conca and Matteo Varbaro. Square-free Gröbner degenerations. *Invent. Math.*, 221(3):713–730, 2020.
- [DES98] Persi Diaconis, David Eisenbud, and Bernd Sturmfels. Lattice walks and primary decomposition. In *Mathematical essays in honor of Gian-Carlo Rota (Cambridge, MA, 1996)*, volume 161 of *Progr. Math.*, pages 173–193. Birkhäuser Boston, Boston, MA, 1998.
- [DN22] Rodica Dinu and Francesco Navarra. Non-simple polyominoes of könig type and their canonical module. *arXiv preprint arXiv:2210.12665*, 2022.
- [EHQR21] Viviana Ene, Jürgen Herzog, Ayesha Asloob Qureshi, and Francesco Romeo. Regularity and the Gorenstein property of L -convex polyominoes. *Electron. J. Combin.*, 28(1):Paper No. 1.50, 23, 2021.
- [Gol54] S. W. Golomb. Checker boards and polyominoes. *Amer. Math. Monthly*, 61:675–682, 1954.
- [Gol94] Solomon W. Golomb. *Polyominoes*. Princeton University Press, Princeton, NJ, second edition, 1994. Puzzles, patterns, problems, and packings, With diagrams by Warren Lushbaugh, With an appendix by Andy Liu.
- [Gor07] Elisa Gorla. Mixed ladder determinantal varieties from two-sided ladders. *J. Pure Appl. Algebra*, 211(2):433–444, 2007.
- [HH12] Jürgen Herzog and Takayuki Hibi. Ideals generated by adjacent 2-minors. *J. Commut. Algebra*, 4(4):525–549, 2012.
- [HH23] Jürgen Herzog and Takayuki Hibi. Finite distributive lattices, polyominoes and ideals of König type. *Internat. J. Math.*, 34(14):Paper No. 2350089, 13, 2023.
- [HHH⁺10] Jürgen Herzog, Takayuki Hibi, Freyja Hreinsdóttir, Thomas Kahle, and Johannes Rauh. Binomial edge ideals and conditional independence statements. *Adv. in Appl. Math.*, 45(3):317–333, 2010.
- [HHM22] Jürgen Herzog, Takayuki Hibi, and Somayeh Moradi. Graded ideals of König type. *Trans. Amer. Math. Soc.*, 375(1):301–323, 2022.
- [HHO18] Jürgen Herzog, Takayuki Hibi, and Hidefumi Ohsugi. *Binomial ideals*, volume 279 of *Graduate Texts in Mathematics*. Springer, Cham, 2018.
- [HO06] Takayuki Hibi and Hidefumi Ohsugi. Special simplices and Gorenstein toric rings. *J. Combin. Theory Ser. A*, 113(4):718–725, 2006.
- [HQ15] Takayuki Hibi and Ayesha Asloob Qureshi. Nonsimple polyominoes and prime ideals. *Illinois J. Math.*, 59(2):391–398, 2015.
- [HS04] Serkan Hoşten and Seth Sullivant. Ideals of adjacent minors. *J. Algebra*, 277(2):615–642, 2004.
- [HSM14] Jürgen Herzog and Sara Saedi Madani. The coordinate ring of a simple polyomino. *Illinois J. Math.*, 58(4):981–995, 2014.
- [JN24] Rizwan Jahangir and Francesco Navarra. Shellable simplicial complex and switching rook polynomial of frame polyominoes. *J. Pure Appl. Algebra*, 228(6):Paper No. 107576, 25, 2024.
- [Knu09] Allen Knutson. Frobenius splitting, point-counting, and degeneration. *arXiv preprint arXiv:0911.4941*, 2009.
- [KV23a] Manoj Kummini and Dharm Veer. The Charney-Davis conjecture for simple thin polyominoes. *Comm. Algebra*, 51(4):1654–1662, 2023.
- [KV23b] Manoj Kummini and Dharm Veer. The h -polynomial and the rook polynomial of some polyominoes. *Electron. J. Combin.*, 30(2):Paper No. 2.6, 7, 2023.
- [MRR20] Carla Mascia, Giancarlo Rinaldo, and Francesco Romeo. Primality of multiply connected polyominoes. *Illinois J. Math.*, 64(3):291–304, 2020.

- [MRR22] C. Mascia, G. Rinaldo, and F. Romeo. Primality of polyomino ideals by quadratic Gröbner basis. *Math. Nachr.*, 295(3):593–606, 2022.
- [Nav24] Francesco Navarra. Shellable flag simplicial complexes of non-simple polyominoes. *arXiv preprint arXiv:2408.12367*, 2024.
- [PRW01] Giovanni Pistone, Eva Riccomagno, and Henry P. Wynn. *Algebraic statistics*, volume 89 of *Mono-graphs on Statistics and Applied Probability*. Chapman & Hall/CRC, Boca Raton, FL, 2001. Computational commutative algebra in statistics.
- [QRR22] Ayesha Asloob Qureshi, Giancarlo Rinaldo, and Francesco Romeo. Hilbert series of parallelogram polyominoes. *Research in the Mathematical Sciences*, 9(2):1–24, 2022.
- [QSS17] Ayesha Asloob Qureshi, Takafumi Shibuta, and Akihiro Shikama. Simple polyominoes are prime. *J. Commut. Algebra*, 9(3):413–422, 2017.
- [Qur12] Ayesha Asloob Qureshi. Ideals generated by 2-minors, collections of cells and stack polyominoes. *J. Algebra*, 357:279–303, 2012.
- [RR21] Giancarlo Rinaldo and Francesco Romeo. Hilbert series of simple thin polyominoes. *Journal of Algebraic Combinatorics*, pages 1–18, 2021.
- [Sec21] Lisa Seccia. Knutson ideals and determinantal ideals of Hankel matrices. *J. Pure Appl. Algebra*, 225(12):Paper No. 106788, 17, 2021.
- [Sec22] Lisa Seccia. Knutson ideals of generic matrices. *Proc. Amer. Math. Soc.*, 150(5):1967–1973, 2022.
- [Sec23] Lisa Seccia. Binomial edge ideals of weakly closed graphs. *Int. Math. Res. Not. IMRN*, (24):22045–22068, 2023.
- [Shi18] Akihiro Shikama. Toric representations of algebras defined by certain nonsimple polyominoes. *J. Commut. Algebra*, 10(2):265–274, 2018.
- [SMNB⁺23] Alessandro De Stefani, Jonathan Montaña, Luis Núñez-Betancourt, Lisa Seccia, and Matteo Varbaro. Ladder determinantal varieties and their symbolic blowups, 2023.
- [Stu02] Bernd Sturmfels. *Solving systems of polynomial equations*, volume 97 of *CBMS Regional Conference Series in Mathematics*. Conference Board of the Mathematical Sciences, Washington, DC; by the American Mathematical Society, Providence, RI, 2002.

SCHOOL OF MATHEMATICS, INDIAN INSTITUTE OF SCIENCE EDUCATION AND RESEARCH THIRUVANANTHAPURAM, VITHURA, 695551, INDIA

Email address: mitra@iisertvm.ac.in

THE INSTITUTE OF MATHEMATICAL SCIENCES, A CI OF HOMI BHABHA NATIONAL INSTITUTE, TARAMANI, CHENNAI 600113, INDIA

Email address: nirmalk@imsc.res.in

DEPARTMENT OF MATHEMATICS AND STATISTICS, DALHOUSIE UNIVERSITY, HALIFAX, B3H 4R2, CANADA

Email address: d.veer@dal.ca