

# A practical guide to feedback control for Pound-Drever-Hall laser linewidth narrowing

Wance Wang,<sup>1</sup> Sarthak Subhankar,<sup>2,1</sup> and Joseph W. Britton<sup>1,3</sup>

<sup>1</sup>*Department of Physics, University of Maryland, College Park, Maryland 20742, USA*

<sup>2</sup>*Joint Quantum Institute, National Institute of Standards and Technology, USA*

<sup>3</sup>*U.S. Army Combat Capabilities Development Command, Army Research Laboratory, Adelphi, MD, 20783, USA*

The Pound–Drever–Hall (PDH) technique for laser linewidth narrowing is widely used by AMO experimentalists. However, achieving a high-performance PDH locking requires substantial engineering experience, which is scattered across literature and often lacks a cohesive control-theory perspective. Excellent pedagogical papers exist on the theory of the PDH error signal [1, 2] but they rarely cover feedback control. General-purpose control theory literature [3, 4] seldom discuss PDH laser locking specifically. Although excellent PDH review articles [5–7] provide thorough knowledge and practice on both aspects but they are not reader-friendly. We extend prior works [5–7] by addressing component choice and loop tuning using modern tools like a vector network analyzer. We organize multifaceted engineering considerations systematically, grounded in feedback control principles. Our target reader is researchers setting up a PDH laser lock for the first time; we eschew advanced topics like minimizing residual amplitude modulation (RAM). Our guidance is illustrated by step-by-step optimization of the lock for a 1650 nm ECDL.

## I. INTRODUCTION

The PDH optical frequency analyzer plays a central role in closed-loop laser frequency stabilization and laser linewidth narrowing. The technique enables ultra-narrow line width lasers [8–13], record-setting optical atomic clocks [14–20] and high-resolution spectroscopy [21–23]. Researchers at the forefront of laser stabilization can now build ultra-narrow, high-stability cavities [9, 24–28] and reduce effects like residual amplitude modulation (RAM) [29–32] to obtain stabilization at the mHz level [13, 33]. It is our observation that many of the techniques used by expert practitioners to obtain these impressive results are not well documented. We hope this tutorial partially bridges this gap and broadens the accessibility of laser frequency stabilization techniques.

## II. JUST ENOUGH CONTROL THEORY

We start with a brief introduction to feedback control theory and omit details extraneous to the aim of first-order PDH optimization. Excellent general-purpose control tutorials include those by Bechhoefer [3], Ogata [4], and Doyle [34].

### A. The feedback loop

Our system consists of a collection of components and signals. All components are linear and time-invariant (LTI). Component  $\tilde{a}(t)$  transforms an input signal  $\tilde{x}(t)$  to an output signal  $\tilde{y}(t)$ . Their relation is simple in Laplace domain

$$\hat{A} = y/x \quad (1)$$

$\hat{A}(f) = \mathcal{L}[\tilde{a}(t)]$  is called the transfer function of the component (Fig. 1(a)) and we set the complex variable  $s = j2\pi f$ . We use the tilde symbol for time-domain signals and hat symbol for transfer functions. We omit the hat for Laplace-domain signals  $x(f) = \mathcal{L}[\tilde{x}(t)]$ . To simplify notation we often omit

the explicit time or frequency dependence. The gain and phase of  $\hat{A}$  are denoted by  $|\hat{A}|$  and  $\angle\hat{A}$ , respectively. As  $f$  increases, the change in  $\angle\hat{A}$  is called the *phase shift*. When  $\angle\hat{A} > 0$  it is *phase lead* and when  $\angle\hat{A} < 0$  it is *phase lag*. A vector network analyzer (VNA) is a tool used in system discovery: by driving  $x$  and observing  $y$  we learn about  $\hat{A}$ . It is common to visualize transfer functions with a Bode plot (Fig. 1(c)).

To implement a feedback control system, components are connected as a loop. The loop signals  $\tilde{y}_k(t)$  can represent a range of physical quantities including electrical (in volts) and optical frequency (in Hz). In frequency domain,  $y_k = \mathcal{L}[\tilde{y}_k(t)]$ . A block diagram (Fig. 1(b)) is a pictorial representation of transfer functions and signals  $y_k$ , where  $k$  labels the signal position in the block diagram. Common loop components are the plant  $\hat{G}$ , sensor  $\hat{H}$  and loop filter  $\hat{K}$ . We call signal  $y_1$  the *output signal* and  $y_5$  the *error signal*. The signal  $m_6$  is an external input. We represent noise in the plant and sensor as signals  $n_1$  and  $n_5$  (Fig. 1(d)).

The *open-loop transfer function* is the product of all loop components [7]

$$\hat{\alpha} = \hat{K}\hat{G}\hat{H} \quad (2)$$

The *closed-loop transfer function* is the ratio of error signal  $y_5$  to  $m_6$

$$\frac{y_5}{m_6} = \frac{\hat{K}\hat{G}\hat{H}}{1 + \hat{K}\hat{G}\hat{H}} = \frac{\hat{\alpha}}{1 + \hat{\alpha}} \quad (3)$$

If we add noises  $n_1$  and  $n_5$ , the output becomes

$$y_1 = \frac{\hat{\alpha}}{1 + \hat{\alpha}} \left( \frac{m_6}{\hat{H}} + \frac{n_1}{\hat{\alpha}} - \frac{n_5}{\hat{H}} \right) \quad (4)$$

The power spectral density (PSD) is

$$S_{y1} = \frac{1}{|1 + \hat{\alpha}|^2} S_{n1} + \frac{|\hat{\alpha}|^2}{|1 + \hat{\alpha}|^2 |\hat{H}|^2} S_{n5} \quad (5)$$

where  $S_{n1}$  and  $S_{n5}$  are the noise PSD.

Ideal *negative feedback* is characterized by a loop where  $|\hat{\alpha}| \rightarrow \infty$  while  $\angle\hat{\alpha} = 0^\circ$  at all frequencies of interest. In this case we have strong suppression of  $n_1$  and  $y_1 = m_6/\hat{H}$ . However, there is no suppression of  $n_5$  which becomes indistinguishable from  $y_1$ . This tension between high gain reducing laser noise but increasing susceptibility to measurement noise will be a recurring theme.

If at any frequency  $f$ ,  $|\hat{\alpha}(f)| > 1$  and  $\angle\hat{\alpha}(f) < -150^\circ$ , the loop amplifies noise and may be unstable. Given the central role of  $\hat{\alpha}$  in loop performance, the control community has developed terminologies to describe loop stability [4], see Fig. 1(c). The *unity-gain* (UG) point  $f_{UG}$  is the frequency where  $|\hat{\alpha}(f_{UG})| = 0$  dB and the *phase margin* is  $\phi_m = 180^\circ + \angle\hat{\alpha}(f_{UG})$ . At  $f_{UG}$  with an empirical  $\phi_m = 60^\circ$ , the factor  $1/|1 + \hat{\alpha}|^2 = 1$  in Eq. 5, so the loop has no suppression on the noise spectrum  $S_{n_1}$  when  $f > f_{UG}$ . The *phase crossover* point  $f_{180}$  is the frequency where  $\angle\hat{\alpha}(f_{180}) = -180^\circ$  and *gain margin* is  $g_m = 1/|\hat{\alpha}(f_{180})|$ . A consequence of negative feedback is increased sensitivity to noise over the range  $f_{UG} < f < f_{180}$  called the *servo bump* [36]. We define  $f_{bump}$  to be the frequency where servo bump noise spectral density is maximum.

## B. Loop components

Now we introduce some components found in PDH laser locks (Fig. 1(b)).

**plant:** The plant is a laser. We define the laser optical frequency (in Hz) to be  $\tilde{y}_1 + \nu_c$ , where  $\nu_c$  is a cavity resonance. The signal  $y_1 = \mathcal{L}[\tilde{y}_1]$  is the Laplace transform of the laser detuning and  $n_1$  is its frequency noise.

**sensor:** We need a sensor that transforms frequency signal  $\tilde{y}_1$  into voltage signal  $\tilde{y}_5$ . Here we focus on the cavity-based PDH optical frequency discriminator (the ‘‘PDH discriminator’’) [1, 5]. This sensor has a built-in, non-adjustable optical reference frequency  $\nu_c$  and its output is a voltage  $\tilde{y}_5 \propto \tilde{y}_1$ . We call its transfer function  $\hat{H}_{\nu_c}$ . Another property of  $\hat{H}_{\nu_c}$  is that its output is linear only for  $\tilde{y}_1 \in (-\delta\nu_c/2, \delta\nu_c/2)$ , where  $\delta\nu_c$  is the cavity optical linewidth (Fig. 2(b)).

Note that outside this bandwidth the LTI assumption fails. Measuring  $\hat{H}_{\nu_c}$  directly is non-trivial as many lasers require active feedback to remain within  $\nu_c \pm \delta\nu_c/2$ .

**loop filter:** The transfer function of a loop filter  $\hat{K}$  is tailored to advance feedback design goals. The proportional–integral–derivative (PID) loop filter is widely-used

$$\hat{K} = K_P \left( 1 - j \frac{f_I}{f} + j \frac{f}{f_D} \right) \quad (6)$$

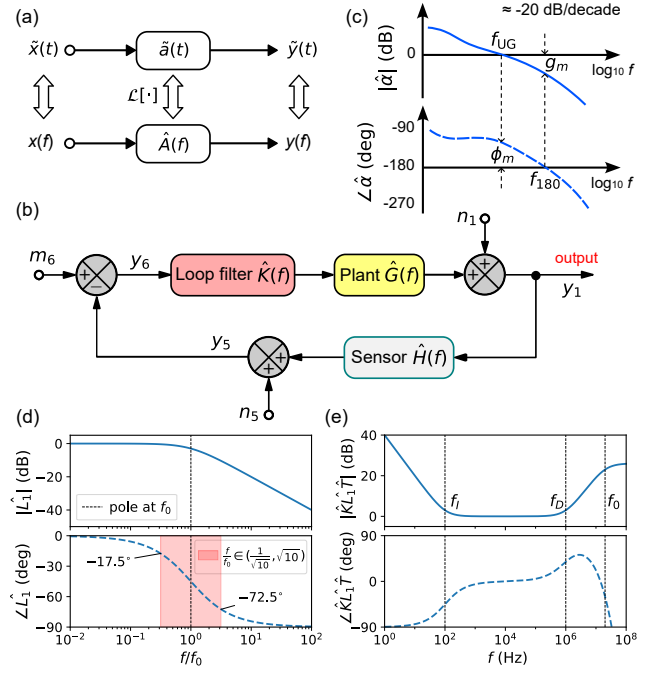

FIG. 1. (a)  $\tilde{a}$  is a time-invariant (LTI) system component that transforms signal  $\tilde{x}$  to  $\tilde{y}$ . The transfer function  $\hat{A}$  encodes the frequency-domain behavior of  $\tilde{a}$ . (b) The block diagram illustrates a feedback loop. Components of the loop include a plant  $\hat{G}$ , sensor  $\hat{H}$  and loop filter  $\hat{K}$ . Signals decorated by integers include observable  $y_k$ , noise  $n_k$  and modulation  $m_k$  signals. (c) A Bode plot for a sample open-loop transfer function  $\hat{\alpha}$ . By convention the gain is plotted in dB ( $20 \log_{10} |\hat{\alpha}|$ ) and the frequency is  $\log_{10} f$ . Dashed lines call out the *unity-gain* (UG) point  $f_{UG}$ , *phase margin*  $\phi_m$ , *phase crossover* point  $f_{180}$  and *gain margin*  $g_m$ . (d) The first-order low-pass filter  $\hat{L}_1$  with corner frequency  $f_0$ . Its properties include 3 dB attenuation and a  $-45^\circ$  phase lag at  $f_0$ . 60% of the phase change occurs in the one decade around  $f_0$  (red). (e) A sample plot of a PID loop filter  $\hat{K}\hat{L}_1\hat{T}$  transfer function where  $\hat{K}$  is given by Eq. 6,  $K_P = 1$ ,  $f_I = 100$  Hz, and  $f_D = 1$  MHz. In the high-frequency limit all devices are ultimately bandwidth-limited and exhibit low-pass behavior, corner frequency  $f_0 = 20$  MHz for  $\hat{L}_1$  and delay  $\tau_l = 10$  ns for  $\hat{T}$ .

where  $K_P$  is proportional gain,  $f_I$ ,  $f_D$  are the P-I and P-D corner frequencies, respectively (Fig. 1(d)). The second term is an integrator (I) with gain slope  $-20$  dB per decade that adds  $-90^\circ$  phase lag when  $f \ll f_I$ . The third term is a differentiator (D) with gain slope  $+20$  dB per decade that adds  $+90^\circ$  phase lead when  $f \gg f_D$ . We adjust the phase lag of  $\hat{K}$  by tuning  $f_I$  and  $f_D$ . The UG point can be extended by using the up to  $+90^\circ$  phase lead available from the  $D$  term.<sup>2</sup> The control available from PID is usually enough but some lasers may benefit from more sophisticated feedback [37].

**delay:** An implicit element of any feedback loop is propagation delay  $\tau_l$ . The transfer function is

<sup>1</sup>  $f_{UG}$  is also called ‘‘loop bandwidth’’ [35].

<sup>2</sup> Real-world PID devices often fall short of the full  $+90^\circ$  phase lead available from an ideal  $D$  term. See the plot Fig. 1(e).

$\hat{T} = \exp(-j2\pi f\tau_l)$  which has magnitude 1 and a phase that increases linearly in  $f$  without bound (Eq.2). The phase delay  $2\pi f\tau_l$  is fundamental and can't be corrected by other loop components. At high frequency, the phase lag due to  $\hat{T}$  can limit  $f_{UG}$  and feedback performance. For example, the phase lag is  $18^\circ$  at  $f = 1$  MHz if the loop length is 10m in coaxial cables and signals propagate at  $2/3$  the speed of light. The transfer function  $\hat{T}$  does not explicitly appear in diagrams as it is distributed across all components.

Simple models for these components include the following.

**first-order low-pass:** The low-pass filter is a common loop element that results in a phase shift. The transfer function for a first-order low-pass is (Fig. 1(d)),

$$\hat{L}_1 = \frac{1}{1 + jf/f_0}$$

where  $f_0$  is the corner frequency. The attenuation of  $\hat{L}_1$  at  $f_0$  is  $-3$  dB and for  $f > f_0$  the slope is  $-20$  dB/decade. The phase shift is  $\angle\hat{L}_1 = -\arctan(f/f_0)$ . Notice that  $\angle\hat{L}_1(f_0)$  is  $-45^\circ$  and it has the steepest change in the decade  $(1/\sqrt{10}, \sqrt{10})f_0$ . The electronic RC circuit is an example of a first-order low-pass where  $f_0 = 1/(2\pi RC)$ .

**high-order low-pass:** Later we will encounter a need for higher-order low-pass filters  $\hat{L}_n$  with corner  $f_0$ , and where  $\lim_{f \rightarrow \infty} \angle\hat{L}_n = -90^\circ \times n$  [7]. The common  $n$ -th order Butterworth low-pass  $\hat{L}_n$  has slope  $-20\text{dB} \times n$  per decade for  $f > f_0$ . At intermediate frequencies  $\angle\hat{L}_n$  can be computed numerically [38] or approximated by  $\angle\hat{L}_n \approx -n \arctan(f/f_0)$ . Strong attenuation comes at the cost of large phase lag – the right filter is context dependent. All real-world plants  $\hat{G}$  exhibit low-pass behavior at high frequency and can be approximated by some low-pass  $\hat{L}_n$ .

### C. Feedback design goals

Here we provide advice for choosing feedback parameters in simple closed-loop systems. Our high-level design goals are the following:

1. maximize  $f_{UG}$
2. maintain  $30^\circ < \phi_m < 60^\circ$
3. for  $f < f_{UG}$  maintain  $\angle\hat{\alpha} > -120^\circ$

Naturally, for  $f < f_{UG}$  we want to maximize  $|\hat{\alpha}|$ . However, this aim is constrained by a gain-phase relationship first considered by Bode [3, 39], a special case of the Kramers-Kronig relation [40].

For a transfer function  $\hat{A}^3$ , phase  $\angle\hat{A}$  is uniquely related to gain  $|\hat{A}|$ . When the slope of  $20\log_{10}|\hat{A}(f)|$  is  $-n$ , the phase  $\angle\hat{A}(f) \approx -n \times 90^\circ$ .

With this relation in mind we can see that for the open-loop transfer function  $\hat{\alpha}$  the loop is stable ( $\angle\hat{\alpha} \leq -180^\circ$ ) if the change in  $|\hat{\alpha}(f)|$  is no more than  $-20$  dB/decade. This rationalizes our first design goal: because the slope of  $|\hat{\alpha}|$  is constrained, the only way to obtain large  $|\hat{\alpha}|$  is to maximize  $f_{UG}$ . A corollary is that the primary way to add phase lead near  $f_{UG}$  is to increase  $|\hat{\alpha}|$ . Because of the phase lag in Fig. 1(d), in many cases the highest achievable  $f_{UG}$  is one decade lower than  $f_0$  for the dominant low-pass in the loop. Note that the feedback can be made more robust to long-term drift in  $|\hat{\alpha}|$  by minimizing the slope  $d\angle\hat{\alpha}/df$  near  $f_{UG}$ .

Two key trade-offs should be considered when tuning the loop phase margin. First, an increase in  $|\hat{\alpha}|$  is accompanied by a reduction in  $\phi_m$ . That is, better suppression of noise  $n_1$  in one frequency band comes at the cost of loop instability and stronger servo bump in another. Second, small  $\phi_m$  provides fast transient response but suffers from increased ringing and overshoot. In practice, empirical range  $30^\circ < \phi_m < 60^\circ$  is recommended for satisfactory performance [4].

The last design goal ensures stability for all  $f < f_{UG}$ . The Ziegler-Nichols method [4] is an algorithm for tuning PID parameters that respects these design goals but is typically not optimal.

## III. PDH LOCK COMPONENT CHOICES

In this section we discuss a laser frequency stabilization system containing a PDH optical frequency discriminator (OFD)  $\hat{H}_{V_c}$  and provide advice on component choices. The system consists of loop signals  $y_k$  and the following components (Fig. 5(a)): a laser to be stabilized, an electro-optic modulator (EOM), an optical reference cavity, a photodetector (PD), RF demodulation electronics and a loop filter. For details on the PDH frequency discriminator itself, the reader referred to to Ref. [1] and Sec. III B 4.

### A. Laser

To be concrete we consider a generic external-cavity diode laser (ECDL). Output signal  $y_1$  is the laser frequency which is modulated by two actuators: laser diode current (the *fast branch*) and grating diffraction angle modulated by PZT (the *slow branch*). Each feedback path can be modeled by its own open-loop transfer function ( $\hat{G}_{\text{fast}}$  and  $\hat{G}_{\text{slow}}$ ) with laser-limited low-pass corner frequencies ( $f_{0,\text{fast}}$  and  $f_{0,\text{slow}}$ ). The high-pass corner frequency of the *fast branch* is  $f_{\text{HP,fast}}$ , typically set by the laser diode head board [41].

<sup>3</sup>  $\hat{A}$  has to be minimum-phase [40]

We assume a simple model for free-running laser frequency noise [7, 42, 43]. Let  $S_{n1}(f)$  be the frequency noise PSD ( $\text{Hz}^2/\text{Hz}$ ) [7]. This quantity can be calculated from the auto-correlation  $R_\phi(t)$  of the laser phase over time  $\phi(t)$ .

$$R_\phi(\tau) = \lim_{T \rightarrow \infty} \frac{1}{T} \int_{T/2}^{T/2+\tau} \phi(t+\tau)\phi(t) dt \quad (7)$$

$$S_{n1}(f) = \frac{1}{2\pi} f^2 \int_{-\infty}^{\infty} R_\phi(\tau) e^{i2\pi f \tau} d\tau$$

Free-running laser noise processes is parameterized as

$$S_{n1}(f) = h_{-1} f^{-1} + h_0 f^0 \quad (8)$$

where  $h_{-1}$  is the 1-Hz-frequency intercept for  $1/f$ -noise and  $h_0$  is the the 1-Hz-frequency intercept for white frequency noise. The instantaneous laser linewidth is dominated by the white noise and has a Lorentzian line shape with  $\pi h_0$  full-width at half-max. The  $\beta$ -separation method [42] is a technique for estimating the linewidth for noise that doesn't follow Eq. 8. We note that a single linewidth number can be quite misleading [6, 43–45]; we recommend obtaining the spectrum  $S_{n1}(f)$  from laser manufacturers prior to purchasing a laser and PDH stabilization components (especially the reference cavity).

We recommend the following properties for an ECDL to be easily PDH-stabilized:

- $f_{0,\text{fast}}$  is at least one decade higher than the noise that one wants to suppress
- $f_{\text{HP},\text{fast}}$  should be lower than  $f_{0,\text{slow}}/10$

The first is motivated by the observation that  $f_{\text{UG}} \sim f_{0,\text{fast}}/10$ . Further, since  $f_{\text{UG}}$  is often limited to  $\sim 2\text{MHz}$  by loop propagation delay, we recommend  $f_{0,\text{fast}} > 10\text{MHz}$ . However, too strong  $S_{n1}(f)$  may still preclude stable laser locking even though  $f_{\text{UG}}$  is faster than the noise, see our analysis in Ref. [46].

Distinct fast- and slow-modulation inputs are present in most laser systems. For many laser types the slow feedback path  $\hat{G}_{\text{slow}}$  has many resonances as it is effected by PZT actuation of mechanical components like mirrors or gratings [47, 48]. The second is motivated by the observation that feedback via  $\hat{G}_{\text{fast}}$  needs to suppress the slow branch servo bump so we require  $f_{\text{HP},\text{fast}} < f_{0,\text{slow}}/10$ .

## B. PDH frequency discriminator

Generation of the PDH error signal  $\tilde{y}_5$  relies on several components which can be independently optimized.

### 1. Modulation and demodulation

An EOM driven at RF frequency  $\Omega$  is used to add side bands to the laser. An RF mixer demodulates the PD output using  $\Omega$  applied to the LO port of a mixer. There is a

low-pass filter downstream of the mixer with corner frequency  $f_M$  that outputs signal  $\tilde{y}_5$ . The demodulation transfer function (mixer+low-pass) is  $\hat{D}$ .

Common choices for  $\Omega/2\pi$  are 10 to 20 MHz [10, 29, 49, 50]. Resonant EOMs operate at a single manufacturer-defined frequency, while fiber-EOMs have roughly uniform response from 1 MHz to beyond 10 GHz, they have lower power handling. For laser light at frequency  $\tilde{y}_1$  the EOM output is  $\exp(j2\pi\tilde{y}_1 t + j\beta \sin(\Omega t))$  which can be expanded as

$$e^{j2\pi\tilde{y}_1 t} \left( J_0(\beta) + \sum_{k=1}^{\infty} J_k(\beta) e^{jk\Omega t} + \sum_{k=1}^{\infty} (-1)^k J_k(\beta) e^{-jk\Omega t} \right) \quad (9)$$

where  $\beta$  is the modulation depth and  $J_k$  is  $k$ -th order Bessel function. Mixing of the side bands  $J_0$  and  $J_{\pm 1}$  reflected by the optical cavity gives rise to signal  $\tilde{y}_5$ . If  $\beta = 1.082$  the linear region slope  $k_e$  (discussed later in Eq. 12) is maximum. A DC term in  $\tilde{y}_4$  is blocked by the RF port of the mixer but  $2\Omega$  terms are demodulated to frequency  $\Omega$  in  $\tilde{y}_5$ . The desired signal  $\tilde{y}_5$  is proportional to  $q = 4J_0(\beta)J_1(\beta)$  while unwanted modulation at  $\Omega$  is proportional to  $p = 2J_1(\beta)^2 + 4J_0(\beta)J_2(\beta)$  [1]. A low-pass filter after the mixer blocks the unwanted modulation at the cost of a phase shift that limits  $f_{\text{UG}}^4$ . To reach a signal-to-noise ratio (SNR) of  $10^3$ , attenuation  $-20\log_{10}(10^3/p) \approx -55\text{dB}$  is needed at  $\Omega$ .

Suppose that  $\Omega/2\pi = 20\text{MHz}$  and  $f_{\text{UG}} = 1\text{MHz}$ . An  $n$ -th order Butterworth filter provides  $-55\text{dB}$  attenuation when  $f_M = (\Omega/2\pi) 10^{-\frac{55}{20n}}$ . Numerical results show that the attenuation target is met when  $n = 8$  and  $f_M = 9\text{MHz}$ ; the phase lag is  $\angle \hat{L}_{\text{B}_n}(f_{\text{UG}}) = -33^\circ$ . To reduce the phase lag one has to either increase modulation  $\Omega$  or sacrifice SNR.

## 2. Photodetector

The light detector consists of a photodetector and a transimpedance amplifier. We call this composite device a PD and call its transfer function  $\hat{P}$ . The relevant properties are its responsivity  $R$  (in units of A/W), transimpedance gain  $g_{\text{tr}}$  (in units of V/A), noise equivalent power (NEP, in units of  $\text{W}/\sqrt{\text{Hz}}$ ) and its frequency response, modeled as an  $n$ -th order low-pass  $\hat{L}_{\text{PD}}$  with corner frequency  $f_{\text{PD}}$ . For incident optical power  $P_{\text{PD}}$ , the output voltage amplitude at DC is  $P_{\text{PD}} R g_{\text{tr}}$ .

Noise in the PD can be consequential to overall PDH performance. Contributions include detector electronic noise (including electronic shot noise) characterized by NEP [51] and photon shot noise [1, 52]. The NEP is defined as the incident power that gives an SNR of one in a 1 Hz bandwidth. For photocurrent, the RMS electronic noise in bandwidth  $\delta$  is  $I_{\text{en}} = \text{NEP} \times R \sqrt{\delta}$  and the noise by photon shot noise at

<sup>4</sup> Some loop filters provide sufficient attenuation at  $\Omega$  and don't require an external low-pass.

power  $P_{\text{PD}}$  is  $I_{\text{sn}} = \sqrt{4eRJ_1(\beta)^2 P_{\text{PD}} \sqrt{\delta}}$ . The optical power when  $I_{\text{en}} = I_{\text{sn}}$  is  $P_{\text{PD}}^{(eq)} = \text{NEP}^2 R / (4eJ_1(\beta)^2)$ . The SNR at  $P_{\text{PD}}^{(eq)}$  is then

$$\frac{P_{\text{PD}}^{(eq)} R}{I_{\text{en}} + I_{\text{sn}}} = \frac{\text{NEP}}{8eJ_1(\beta)^2 \sqrt{\delta}} R$$

The threshold  $P_{\text{PD}} > P_{\text{PD}}^{(eq)}$  is notable since above it electronic noise no longer dominates. In the context of PDH, the bandwidth that contributes to noise in  $y_5$  is  $(\Omega/2\pi - f_M, \Omega/2\pi + f_M)$ , where  $f_M$  is the corner frequency of the low-pass following the mixer. Now we can put some numbers to it: suppose  $\text{NEP} = 10 \text{ pW}/\sqrt{\text{Hz}}$ ,  $R = 1 \text{ A/W}$  and  $f_M = 9 \text{ MHz}$ . Then,  $P_{\text{PD}}^{(eq)} = 720 \text{ } \mu\text{W}$  and the SNR is 8480.

In Appendix VI A, we show that  $\hat{P}$  depends on the value of  $\Omega$  due to the mixer:

$$\hat{P} = e^{\frac{j}{2} [\angle \hat{L}_{\text{PD}}(\Omega+f) - \angle \hat{L}_{\text{PD}}(\Omega-f)]} \quad (10)$$

We see wide variation in the phase response of commercial PD packages that can be approximated by  $\angle \hat{L}_{\text{PD}}(f) \approx -n \arctan(f/f_{\text{PD}})$ , where  $n$  is the number of poles. We find  $n = 3$  for several PDs in our lab. Given  $\Omega/2\pi = 20 \text{ MHz}$ ,  $f_{\text{PD}} = 10 \text{ MHz}$  and  $f_{\text{UG}} = 1 \text{ MHz}$ , we get  $\angle \hat{P}(f_{\text{UG}}) = -0.9^\circ$ . An especially sub-optimal choice is  $\Omega/2\pi = 5 \text{ MHz}$  and  $f_{\text{PD}} = 5 \text{ MHz}$  where  $\angle \hat{P}(f_{\text{UG}}) = -17^\circ$ .

Given what we've seen so far you might think  $\Omega/2\pi > 20 \text{ MHz}$  is an improvement, however it's not so simple. Non-idealities that emerge for such frequencies include the following. 1) The phase lag  $\angle \hat{P}$  becomes larger. 2) The electronics for offset-locking becomes marginally harder [2, 53–56]. 3) It is increasingly hard to avoid overlap of EOM sidebands with higher-order transverse cavity modes [57].

### 3. Reference cavity

An ultrastable Fabry-Perot optical cavity is commonly used in PDH-based frequency discriminators. Salient cavity properties are its transmission frequency  $\nu_c$ , the resonance full width at half max linewidth  $\delta\nu_c$  and free spectral range (FSR)  $\nu_{\text{FSR}}$ . The cavity finesse is  $\mathcal{F} = \nu_{\text{FSR}}/\delta\nu_c$  and the resonator quality factor is  $Q = \frac{c/\lambda}{\delta\nu_c}$ . The transfer function for the light reflected by the cavity has a low-pass response

$$\hat{C} = 1/(1 + j2f/\delta\nu_c) \quad (11)$$

[7, 52], where  $\delta\nu_c/2$  is the corner frequency. Appendix VI B shows how to measure  $\delta\nu_c$  by cavity ring-down.

### 4. Discriminator

Now we combine our knowledge of individual components to better understand properties of the PDH frequency discriminator transfer function  $\hat{H}_{\nu_c}$ . The subscript  $\nu_c$  reminds us that the reference frequency is defined by the cavity.

A sample PDH error signal is plotted in Fig. 2(a). The slope  $k_e$  of the discriminator response (Fig. 1) is [1]

$$k_e := \left. \frac{d\tilde{y}_5}{d\tilde{y}_1} \right|_{\tilde{y}_1=0} = 8J_0(\beta)J_1(\beta)P_{\text{PD}}Rg_{\text{tr}}/\delta\nu_c \quad (12)$$

with units of V/Hz. Note that  $\tilde{y}_1$  and  $\tilde{y}_5$  are time-domain signals. The transfer function for the overall PDH discriminator is (see Fig. 5(b))

$$\hat{H}_{\nu_c} := \frac{y_5}{y_1} \approx \hat{D}\hat{P}k_e\hat{C} \quad (13)$$

and includes terms for demodulation  $\hat{D}$ , photodetector  $\hat{P}$  and cavity  $\hat{C}$ .

Following are several design goals to optimize  $\hat{H}_{\nu_c}$ .

- maximize  $k_e$
- choose  $\delta\nu_c/2 < 300 \text{ kHz}$  (see Sec. III D)
- make  $\tilde{y}_5$  symmetric about  $\tilde{y}_5 = 0$

We can now write a more detailed expression for the laser frequency detuning

$$y_1 = \frac{\hat{\alpha}}{1 + \hat{\alpha}} \left( \frac{n_1}{\hat{\alpha}} - \frac{n_4}{k_e\hat{C}} \right) \quad (14)$$

where  $\hat{\alpha} = \hat{\alpha}_{\text{slow}} + \hat{\alpha}_{\text{fast}} = \hat{H}_{\nu_c}\hat{K}_{\text{slow}}\hat{G}_{\text{slow}}\hat{T} + \hat{H}_{\nu_c}\hat{K}_{\text{fast}}\hat{G}_{\text{fast}}\hat{T}$  (see the loop in Fig. 5). As expected laser noise  $n_1$  is suppressed by the loop gain  $1 + \hat{\alpha}$  while noise  $n_4$  is only suppressed by  $k_e\hat{C}$ .

Increasing  $P_{\text{PD}}$  improves  $k_e$  and SNR, but use caution as it can have adverse consequences including heating of mirror coatings, cavity drift [58], error signal asymmetry [6], and cross-talk in a multi-color PDH setup. Finally, maximize  $k_e$  by adjusting the phase-delay between the LO and mixer (Fig 4(a)). We discuss choice of  $\delta\nu_c$  in Sec. III D.

Since  $\hat{H}_{\nu_c}$  is linear only for  $\tilde{y}_1 \in (-\delta\nu_c/2, \delta\nu_c/2)$ , care must be exercised during operation to ensure this limit is not violated. A proper error signal is symmetric about  $\tilde{y}_5 = 0$ . The simplest asymmetry is an offset to the entire error signal. If the offset is slowly varying, the result is a shift in the lock point and reduced discriminator dynamic range. We note that the offset can vary due to RAM [29, 32].<sup>5</sup>

The transfer function  $\hat{H}_{\nu_c} = \hat{D}\hat{P}k_e\hat{C}$  is straightforward to determine.  $\hat{C}$  is determined by cavity ring-down. The slope  $k_e$  is best determined empirically. Increase  $|\hat{\alpha}|$  by raising loop filter gain  $K_P$  so the error signal  $\tilde{y}_5$  oscillates well into saturation. Note the peak to peak amplitude  $\tilde{y}_5^{\text{PP}}$  on an oscilloscope and calculate  $k_e = 2\tilde{y}_5^{\text{PP}}/\delta\nu_c$ . As a first-order approximation,  $\hat{D}$  is in many situations dominated by the low-pass filter and  $\hat{P} = 1$  in the limit of high PD bandwidth. Precisely,  $\hat{D}\hat{P}$  can be measured with a VNA as mentioned in Appendix VI A.

<sup>5</sup> RAM can be due to polarization drift upstream of the EOM and etalon effects due to interference of stray reflections along the beam path [6, 29].

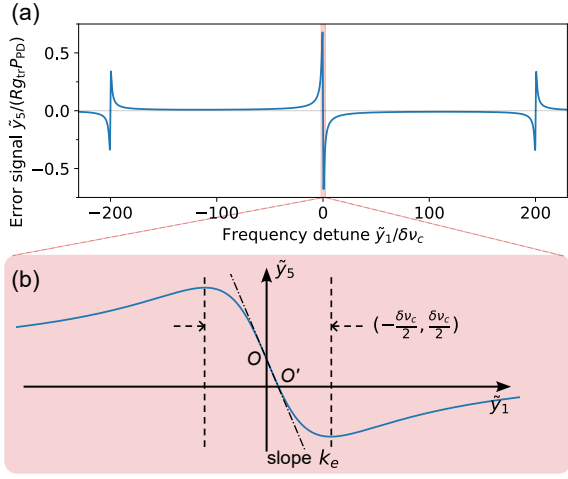

FIG. 2. (a) A sample PDH error signal for  $\delta v_c = 100$  kHz,  $\Omega/2\pi = 20$  MHz and  $\beta = 1.082$ .  $\tilde{y}_1$  and  $\tilde{y}_5$  are instantaneous laser frequency detuning and error signal in time domain. (b) Zoom-in of the red-shaded area in (a). Signal  $\tilde{y}_5$  is linear only over a narrow region  $\tilde{y}_1 \in (-\delta v_c/2, \delta v_c/2)$ . Ideally the signal is symmetric about the zero crossing point  $O$ . Here we show an offset error:  $\tilde{y}_5 = 0$  is at  $O'$ .

### C. Loop filter

The loop filter provides frequency-dependent gain and phase advance that can be tuned to optimize closed loop performance. We focus on analog PID loop filters (see Sec. II B) which have several salient properties.

- adjustable fast-branch  $\hat{K}_{\text{fast}}$  parameters:  $K_P, f_I, f_D$  as shown in Eq. 6
- adjustable slow-branch  $\hat{K}_{\text{slow}}$  parameter:  $f_I^{\text{slow}}, \hat{K}_{\text{slow}} = -j f_I^{\text{slow}}/f$
- adjustable input offset  $m_6^{\text{DC}}$
- propagation delay
- low-frequency integral gain limit

As discussed in the introduction, the widely-used PID loop filter provides 3 free parameters:  $f_I, f_D$ , and  $K_P$  [3].<sup>6</sup> The corresponding transfer function is Eq. 6. The input offset  $m_6^{\text{DC}}$  can compensate for the error signal offset. The propagation delay of a good analog PID can be as low as 10 ns [59]. This corresponds to less than  $-36^\circ$  at 10 MHz.

Although  $|\hat{\alpha}| \rightarrow \infty$  seems like it might be optimal, it is common to limit the integral gain at low frequencies. When initially engaging the lock, the error signal may be far from zero

due to laser noise and large I-gain near DC can drive the feedback to saturation. This can be mitigated by first establishing an initial lock using the fast branch and later slow branch. Note that even when system performance is shot-noise limited, high-gain at low frequency is not needed [1, 46, 52, 60].

Digital loop filters based on field-programmable gate array (FPGA) have been developed and successfully applied in AMO experiments including laser locking [61–66]. They can provide more diverse transfer functions with features like providing more than  $90^\circ$  lead or lag, multiple inputs and outputs, auto-relock, integrator hold, and system discovery. However, their delay is typically  $> 200$  ns which ultimately limits the phase lead and they are limited by high input noise  $50 - 100$  nV/ $\sqrt{\text{Hz}}$  at 1 kHz [61, 62]. Both are approximately 20-times higher than those for a high-performance analog loop filter<sup>7</sup> In the case of laser linewidth reduction, maximizing  $f_{\text{UG}}$  is the highest priority and analog feedback is best for the fast branch. For the slow-branch  $\hat{K}_{\text{slow}}$ , delay is not a problem and a digital loop filter may be a good choice [7, 37]. Additional resources for loop filter design include Ref. [3, 5, 6].

### D. Cavity selection

Finally we discuss is the linewidth  $\delta v_c$  choice of the reference cavity. Industry-standard reference cavities have an FSR of 1.5 GHz leaving finesse (linewidth  $\delta v_c$ ) as the primary free parameter. Our recommendation balances the trade-offs discussed below (Fig. 3).

A low-noise lock favors small  $\delta v_c$ . The PSD of equation 14 is

$$S_{y1} = \frac{1}{|1 + \hat{\alpha}|^2} S_{n1} + \frac{|\hat{\alpha}|^2}{|1 + \hat{\alpha}|^2} \frac{1}{k_e^2 |C|^2} S_{n4}$$

Since  $1/(k_e^2 |C|^2) \propto \delta v_c^2 + 4f^2$ , smaller  $\delta v_c$  gives less sensitivity to discriminator noise  $n_4$ . Note that choosing  $\delta v_c$  too small can make cavity alignment hard because of low transmission and make locking hard since the laser is commonly servo'd manually to  $y_1 \in (-\delta v_c/2, \delta v_c/2)$  before activating the lock.

The goal of maximizing  $f_{\text{UG}}$  requires the cavity pole  $\delta v_c/2$  to be lower than  $f_{\text{UG,fast}}/\sqrt{10}$ <sup>8</sup>. Avoid overlap of  $\delta v_c/2$  with  $f_{\text{UG,fast}}$ , else the phase margin is more sensitive to laser power or RAM drift because of steeper  $d\angle\hat{\alpha}/df$  near  $f_{\text{UG,fast}}$ . If fast branch cannot fully suppress slow branch servo bump, less  $\angle\hat{C}$  when  $\delta v_c/2 > \sqrt{10} f_{\text{UG,slow}}$  is helpful. For a typical ECDL we have  $f_{\text{UG,fast}} \sim 1 - 2$  MHz and  $f_{\text{UG,slow}} \sim 1 - 10$  kHz, for which the recommended range of  $\delta v_c$  is the green-shaded range in Fig. 3.

State-of-the-art mirror coating can achieve  $10^6$  finesse [10, 13, 67, 68]. Given a cavity length of 10 to 50 mm [13, 14, 24, 49, 69], a practical lower bound on linewidth is around 1 kHz.

<sup>6</sup> Note that some loop filters have adjustable parameters  $K_P, K_I, K_D$  where the transfer function is  $\hat{K} = K_P - jK_I/f + jK_D f$ . This is a poor choice since the pole is  $f_I = K_I/K_P$  and the zero is  $f_D = K_P/K_D$  so they can't be set independent of  $K_P$ . Loop filters like this cost extra tuning work in optimizations.

<sup>7</sup> Commercial examples include the Toptica FALCpro and Vescent D2-125.  
<sup>8</sup> See the phase change of a low-pass in Fig. 1(e). In fact,  $\delta v_c/2 > \sqrt{10} f_{\text{UG,fast}}$  results in the least phase lag, but small  $\delta v_c$  reduces the noise sensitivity.

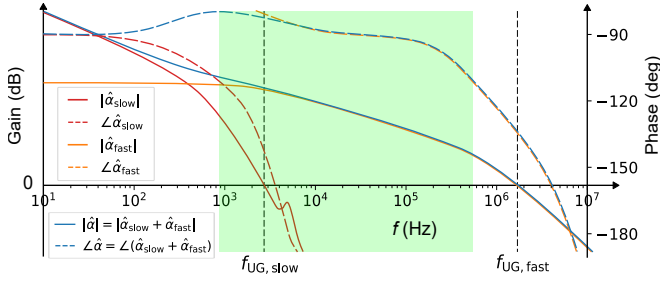

FIG. 3. Sample Bode plots of the transfer function of the fast ( $\hat{\alpha}_{\text{fast}}$ ) and slow branches ( $\hat{\alpha}_{\text{slow}}$ ).  $f_{\text{UG,slow}}$  and  $f_{\text{UG,fast}}$  are UG points for the slow- and fast-branch feedback. Our recommendation is that the cavity pole  $\delta v_c/2$  lies in green-shaded region.

#### IV. CLOSED-LOOP OPTIMIZATION

In an all-electronic system, a vector network analyzer (VNA) can be used to probe each system component separately to determine its transfer function and noise. The present context is a mixed optical-electronic system so we in addition need an optical frequency discriminator (OFD). Required properties of this OFD include sensitivity at the wavelength of interest, a bandwidth well above the target  $f_{\text{UG}}$  and sensitivity to small frequency deviations (and therefore high stability over time). We also want a frequency-agile optical source such as a tunable laser or EOM. However, in many labs the only suitable OFD available is the PDH discriminator  $\hat{H}_{v_c}$  we want to optimize! Further, measuring the PDH OFD transfer function by open-loop techniques is impractical since the reference cavity linewidth is typically small relative to the free-running laser linewidth. In this chicken-and-egg situation the most expedient solution is to measure what we can using open loop techniques, then rely on closed-loop measurements to estimate the OFD and laser transfer functions. The closed loop probe relies on a VNA to inject stimulus at summing points  $m_k$  while measuring electrical loop signals  $y_k$  which are related as

$$\begin{pmatrix} y_5 \\ y_6 \\ y_8 \end{pmatrix} = \frac{1}{1 + \hat{\alpha}} \begin{pmatrix} \hat{H}_{v_c} & \hat{\alpha} & \frac{\hat{\alpha}_{\text{fast}}}{\hat{K}_{\text{fast}}} \\ -\hat{H}_{v_c} & 1 & -\frac{\hat{\alpha}_{\text{fast}}}{\hat{K}_{\text{fast}}} \\ -\frac{\hat{\alpha}_{\text{fast}}}{\hat{G}_{\text{fast}}} & \hat{K}_{\text{fast}} & 1 + \hat{\alpha}_{\text{slow}} \end{pmatrix} \begin{pmatrix} m_2 \\ m_6 \\ m_8 \end{pmatrix} \quad (15)$$

See signals  $y_k$  and modulation  $m_k$  in Fig. 5. Then we are in a position to optimize the overall loop.

##### A. System optimization workflow

We use the following workflow to tune loop filter parameters and check for several misconfiguration errors. It consists of four steps: prepare, measure, optimize and check.

##### prepare:

1. Measure the transfer function of each loop component.
2. Sweep the laser frequency across the cavity resonance and observe the error signal  $\tilde{y}_5$  line shape on an oscilloscope (Fig. 2). Make the error signal symmetric

about  $\tilde{y}_5 = 0$  by adjusting the phase  $\phi_o$  of the RF source (Fig. 5(a)).

3. Sweep across the cavity resonance and observe the fast loop filter output  $\tilde{y}_8$  on an oscilloscope. Adjust the input offset  $m_6^{\text{DC}}$  to make  $\tilde{y}_8$  symmetric about zero.
4. To null the slow loop offset do as follows. Far detune the laser from resonance. Turn on the slow loop filter and observe the rate at which output  $\tilde{y}_7$  rails. Adjust the slow input offset to minimize the rate. This offset is not shown in Fig. 5.
5. To initialize the loop filter: minimize  $f_I$ ; maximize and disable  $f_D$ .
6. Close the loop and obtain a weak lock starting with the fast branch of the loop filter. Increase  $K_P$  until the loop oscillates then reduce  $K_P$  by 50%. Next, add  $f_I$  until the loop oscillates then reduce  $f_I$  by 50%. Finally add  $K_P$  back a little. Signals  $\tilde{y}_5$  and  $\tilde{y}_8$  show periodic waveform on the oscilloscope when the loop oscillates.
7. Next enable the slow integrator  $\hat{K}_{\text{slow}}$ . Increase  $f_I^{\text{slow}}$  until the loop oscillates. Then reduce it until oscillation disappears.

##### measure:

1. Measure  $y_5/m_6$  by connecting a VNA as shown in Fig. 5(a). Program the VNA to apply stimulus at  $m_6$  and record the response at  $y_5$  for frequencies up to 10 MHz. The injected amplitude should be low enough to keep  $\tilde{y}_5$  in the linear region; vary the amplitude of  $y_5$  with frequency as needed. Make a Bode plot of  $y_5/m_6$ .
2. Take note of the frequency  $f_{180}^{\text{CL}}$  which is where  $\angle(y_5/m_6) = -180^\circ$  <sup>9</sup>.
3. Measure  $\tilde{y}_5$  on an oscilloscope and note its RMS value  $\tilde{y}_5^{\text{RMS}}$  which is proportional to laser frequency fluctuation  $\tilde{y}_1^{\text{RMS}}$  <sup>10</sup>. Equivalently, you can avoid  $1/f$  noise in  $\tilde{y}_5$  by using a spectrum analyzer to measure  $S_{y_4}$ .

##### optimize:

First, check if there is excess low-frequency noise; we want  $|y_5/m_6| \approx 1$  and  $\angle y_5/m_6 \approx 0^\circ$  for  $f < f_{180}^{\text{CL}}/10$  (see Fig. 6). If not, reduce fast-branch high-pass  $f_{\text{HP,fast}}$ . If the problem persists, reduce slow-branch  $f_I^{\text{slow}}$ .

Next, try to increase  $f_{180}^{\text{CL}}$ .

<sup>9</sup> Observe that  $f_{180}^{\text{CL}} = f_{180}$ . This is because  $\hat{\alpha}(f_{180})$  is real and  $-1 < |\hat{\alpha}(f_{180})| < 0$  when the loop is stable, so too  $\hat{\alpha}/(1 + \hat{\alpha})$  is real and negative. Thus  $f_{180}^{\text{CL}} = f_{180}$ . Checking  $f_{180}^{\text{CL}}$  is quicker. Improving  $f_{180}$  is equivalent to improve  $f_{\text{UG}}$ .

<sup>10</sup> Note that  $\tilde{y}_5^{\text{RMS}} = \sqrt{\int_0^\infty S_{y_5} df} = \sqrt{\int_0^\infty |\hat{H}_{v_c}|^2 S_{y_1} df} = |\hat{H}_{v_c}(\xi)|^2 \sqrt{\int_0^\infty S_{y_1} df} = |\hat{H}_{v_c}(\xi)|^2 \tilde{y}_1^{\text{RMS}}$ , where  $\xi$  is a finite frequency.

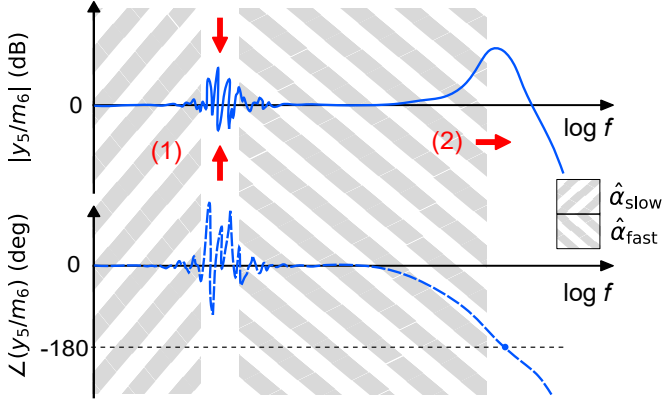

FIG. 4. A sample closed-loop transfer function  $y_5/m_6$  for an incorrectly tuned system. We want to adjust the loop parameters to (1) obtain  $y_5/m_6 \approx 1$  for  $f < f_{180}^{\text{CL}}/10$ . (2) maximize  $f_{180}^{\text{CL}}$ . The gray-white striped regions show the ranges in which the slow and fast feedback attenuate noise. We aspire to eliminate the white gap between them.

1. Enable and reduce  $f_D$  until oscillation, then raise it by 50%. Increase  $K_P$  until oscillation, then reduce it by 50%. Increase  $f_I$  until oscillation, then reduce it by 50%. Then, reduce  $f_D$  until oscillation, then raise it by 50%. Loop over adjustments to  $K_P$ ,  $f_I$ , and  $f_D$  repeatedly until no further improvements can be made. Finally, slightly raise  $K_P$  again.
2. While observing  $\tilde{y}_5^{\text{RMS}}$ , minimize the observable while fine tuning  $K_P$ . Alternately, you may minimize  $\sqrt{\int_{a_-}^{a_+} S_{y_4} df}$ , where  $a_{\pm} = \Omega/2\pi \pm 5 \text{ MHz}$ <sup>11</sup>

#### check:

Start by calculating the open-loop transfer function  $\hat{\alpha}$  from the VNA measurement.

$$\frac{y_5}{m_6} = \frac{\hat{\alpha}}{1 + \hat{\alpha}} \implies \hat{\alpha} = \frac{y_5/m_6}{1 - y_5/m_6} \quad (16)$$

Generate a Bode plot of  $\hat{\alpha}$  and locate  $f_{\text{UG}}$  and  $\phi_m$ . Then check the following.

1. If  $f_{\text{UG}}$  is not as high as you hoped, revisit Sec. III and use components with less phase lag. Adjusting the loop filter won't help.
2. If  $\tilde{y}_5^{\text{RMS}}$  (or  $S_{y_4}$ ) is satisfactory but  $\phi_m < 30^\circ$ , you can increase  $\phi_m$  at the expense of degraded  $\tilde{y}_5$  RMS by reducing  $K_P$ . Increased  $\phi_m$  improves loop stability.
3. We expect that  $\angle \hat{\alpha}$  is the sum of the phase shift from the individual components:  $\angle \hat{K}_{\text{fast}} + \angle \hat{G}_{\text{fast}} + \angle \hat{C} + \angle \hat{D} + \angle \hat{P} + \angle \hat{T}$ . If excess phase lag is observed, dig to find the source.

<sup>11</sup> Integrate over a fixed range larger than larger  $f_{180}^{\text{CL}}$ , here we use 5 MHz.

## B. Example optimization

In this section we illustrate application of the system optimization workflow (Sec. IV A) to improve  $\hat{\alpha}$  for a representative laser system. There are three system configurations (Table I) where the loop is diagnosed and incrementally improved. The optical and electronic elements of the PDH setup are shown in Fig. 5.

### 1. configuration 1

The initial, unoptimized configuration is as follows. The laser is a 1650 nm Littrow ECDL with a 70 dB optical isolator. We observe a free-running frequency fluctuation of  $\sim 200 \text{ kHz}$  over a 10 ms integration window by monitoring side-of-fringe transmission from a test cavity with a full-width at half-max (FWHM) linewidth 4.2 MHz (Thorlabs SA200-12B). The laser controller has external inputs to modulate the PZT voltage (slow branch) and the laser diode current (fast branch). The PZT actuator has a lowest mechanical resonance at 6 kHz. Using the technique in Appendix VI C we observe that current modulation exhibits a  $-52^\circ$  phase shift at 1 MHz.

Sidebands are applied to the laser light using a fiber EOM (iXblue MPZ-LN-10) driven at  $\Omega/2\pi = 20 \text{ MHz}$  with voltage  $\beta/\pi \cdot V_\pi \approx 1.5 \text{ V}$  for  $\beta = 1.082$ . The thermally and acoustically isolated reference cavity (Stable Laser Systems [70]) is made of ultra-low expansion glass (ULE). The cavity has planar and concave ( $R = -50 \text{ cm}$ ) mirrors separated by 10 cm. It is temperature-stabilized at  $24.7^\circ \text{C}$  where the linear thermal expansion coefficient is zero. The cavity FSR is 1.5 GHz, its FWHM as measured by ring down is  $\delta\nu_c = 45.7 \text{ kHz}$  (see Appendix VI B) and its finesse at 1650 nm is  $\mathcal{F} = \nu_{\text{FSR}}/\delta\nu_c \approx 33,000$ . The laser was consistently locked to the same cavity transmission feature at  $\nu_c = 181.65917 \text{ THz}$  using a Michelson interferometer-based wave meter (Bristol 228A) to disambiguate cavity transmission features.

The PD for cavity-reflected light (PD1 in Fig. 5(a)) is a reverse-biased InGaAs diode (Thorlabs PDA10D2) with  $\text{NEP} = 39 \text{ pW}/\sqrt{\text{Hz}}$ , a bandwidth  $f_{\text{PD}} = 20 \text{ MHz}$  and  $\angle \hat{P} = -6.2^\circ$  at 1 MHz. An optical power of  $850 \mu\text{W}$  incident on the cavity results in  $650 \mu\text{W}$  at PD1. The SNR for PD1 is greater than 2700. We use a Level 7 mixer (MiniCircuits ZAD-1-1+). Using the technique in Appendix VI D we determine that the mixer adds a phase lag of  $-1^\circ$  at 1 MHz. A dual-channel RF signal generator (Rigol DG822) generates  $\Omega$  with a phase offset for the tone sent to the mixer LO port. The low-pass (LP) (Minicircuits BLP-10.7+) is an 8th order modified Butterworth-type filter with a corner frequency of 14 MHz and a  $-22^\circ$  phase lag at 1 MHz; the LP provides  $-34 \text{ dB}$  suppression at  $\Omega$ . A high-speed analog loop filter was used with  $< 45^\circ$  electronic phase delay at 10 MHz (Toptica FALC 110 [71]).

We used a vector network analyzer (VNA, OMICRON Lab Bode 100) for transfer function measurements and a spectrum analyzer (Rohde & Schwarz FSV40-N) to measure the noise spectrum.





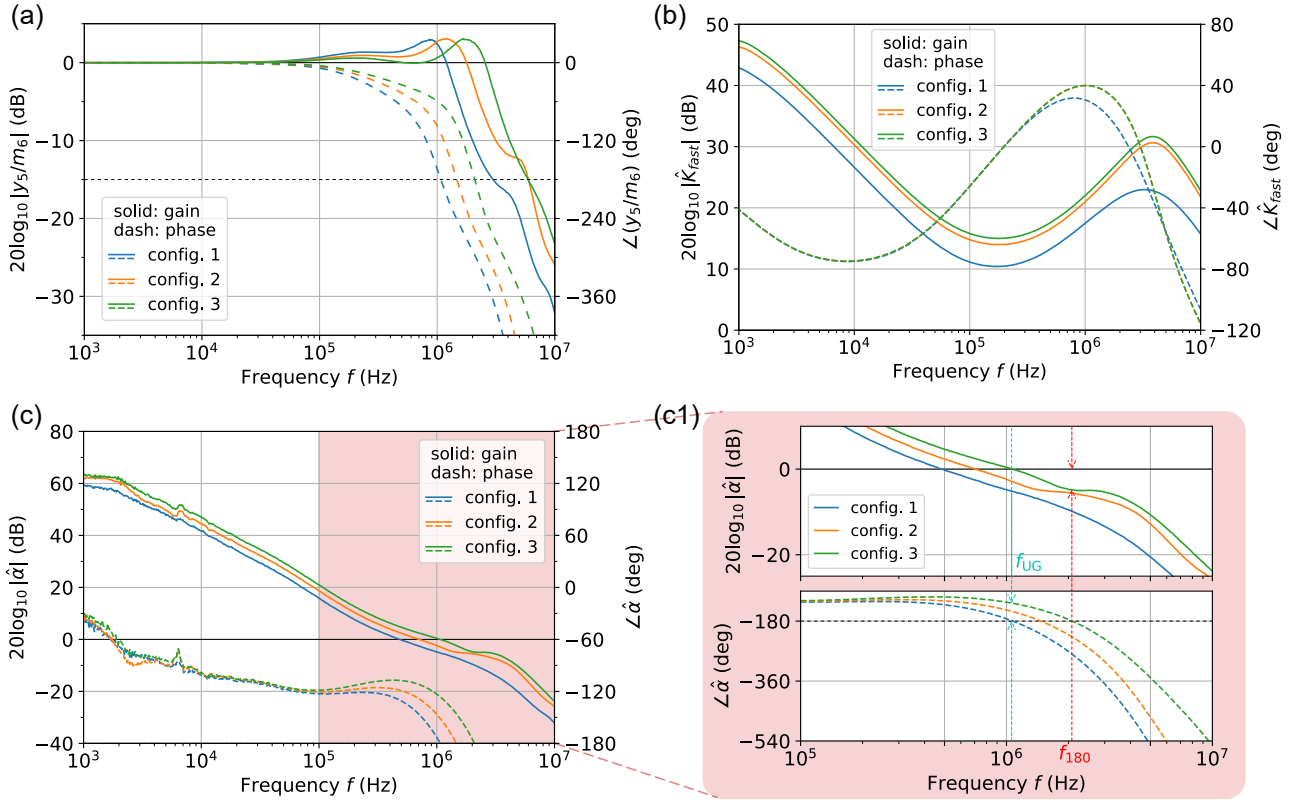

FIG. 6. Here we show performance in configuration 1, 2, and 3. (a) Bode plots of closed-loop transfer functions  $y_5/m_6$  for the three configurations. The VNA resolution bandwidth is 10 Hz. (b) Bode plots of the fast-branch loop filter  $\hat{K}_{fast}$ . (c) Bode plots of open-loop transfer function  $\hat{\alpha}$  calculated from  $\frac{y_5/m_6}{1-y_5/m_6}$ . As expected the slope of  $|\hat{\alpha}|$  is approximately  $-20$  dB/decade. (c1) Zoom-in of the red-shaded area of plot (c). For configuration 3, we call out the UG point  $f_{UG}$  and phase crossover point  $f_{180}$ .

the individual transfer functions, we can account for all phase delays in the loop. This gives us confidence that we understand the origin of phase lags in our setup and have addressed them during optimization.

We also measured the noise spectra  $S_{y_4}(f)$  of cavity-reflected signal  $y_4$  by a spectrum analyzer (Fig. 7(a)). Servo bumps  $f_{bump}$  are summarized in Table I. Improving  $f_{UG}$  pushes servo bumps to higher frequencies and enhances the noise suppression for all  $f < f_{bump}$ .

The single-sided laser frequency PSD  $S_{y_1}$  is plotted in Figure 7(b). This quantity is calculated by shifting  $S_{y_4}$  by  $-\Omega/2\pi$  and dividing by  $|\hat{H}_{v_c}/\hat{D}|^2$ . The error signal slope was measured to be  $k_e = 2.69$  mV/kHz. We use the  $\hat{D}$  and  $\hat{P}$  from Appendix VID.

We would like to compare  $S_{y_1}$  for the free-running and for

Configuration	UG point	phase margin	servo bump
	$f_{UG}$ (MHz)	$\phi_m$ (deg)	$f_{bump}$ (MHz)
1	0.49	50	0.91
2	0.71	51	1.32
3	1.06	54	1.94

TABLE I. A summary of key metrics for each configuration.

the locked laser, however we can't measure the free-running PSD due to the narrow linewidth of our reference cavity. Instead we model the free-running behavior by Eq. 8. Since above  $f_{UG}$  there is no noise suppression even when feedback

Component	Phase shifts (deg) at $f_{UG} = 1.06$ MHz	Source
$\angle\hat{K}_{fast}$	+39.9	from Fig. 6(b)
$\angle\hat{G}_{fast}$	-53.3	see Appendix. VIC
$\angle\hat{C}$	-88.8	calculated from Eq. 11 <sup>[a]</sup>
$\angle(\hat{D}\hat{P})$	-9.2	see Appendix VID
$\angle\hat{T}$	-15.0	$-360^\circ f_{UG}\tau_l$ <sup>[b]</sup>
	-126.4	$\angle\hat{K}_{fast} + \angle\hat{G}_{fast} + \angle\hat{C} + \angle(\hat{D}\hat{P}) + \angle\hat{T}$
$\angle\hat{\alpha}$	-126	from Fig. 6(c1)

TABLE II. Tabulation of the configuration 3 phase shifts at  $f_{UG} = 1.06$  MHz. The sum of the phase shifts from individual components is nearly the measured  $\angle\hat{\alpha}$ . Since  $f_{UG} = 1.06$  MHz,  $\hat{K}_{slow}(f_{UG}) \approx 0$  and  $\hat{G}_{slow}(f_{UG}) \approx 0$ , we ignore  $\hat{\alpha}_{slow}(f_{UG})$ . Remarks: [a]  $\delta v_c = 45.7$  kHz, see the ring-down measurement in Appendix VIB. [b] Here  $\tau_l$  is the delay due to signal propagation thru 2.1 m free space, 4.9 m fiber, and 1.7 m coaxial cable.

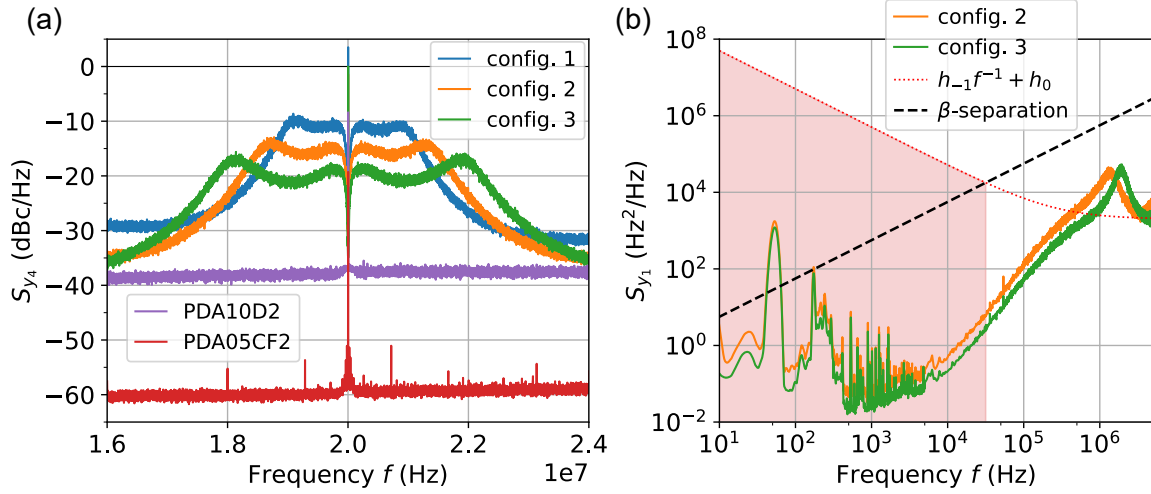

FIG. 7. (a) The power spectral density  $S_{y_4}$  of the three configurations and the two PDs. The PSD are normalized to configuration 3 and have a 1 kHz resolution bandwidth. Photodetector baselines are measured with the laser blocked; the 20MHz carrier leakage is due to imperfect mixer LO-RF isolation. (b) Here we show evidence of linewidth narrowing. We plot the PSD  $S_{y_1}$  of the configuration 2 and 3 (solid lines) while locked and a model for the free-running laser (dotted red line). We also plot the  $\beta$ -separation line (dashed black). The PDH-locked  $S_{y_1}$  are calculated from measured  $S_{y_4}$  with a 10 Hz resolution bandwidth and the PD noise baseline is subtracted.

is active, the value of  $h_0$  can be determined from the closed-loop response:  $h_0 = S_{y_1}(5 \text{ MHz}) = 2 \times 10^3 \text{ Hz}^2/\text{Hz}$ . We set  $h_{-1} = 5 \times 10^8 \text{ Hz}^2$  which is close to the values from reported frequency noise spectrum of Toptica ECDLs [72–75]. The shaded red area contributes to a linewidth of  $\sim 150 \text{ kHz}$  according to the  $\beta$ -separation line theory [42]. In comparison with the free-running laser performance it's clear configuration 2 and 3 have substantially reduced laser linewidth.

We are satisfied with our laser performance after two iterations of optimization where we pushed  $f_{UG}$  from 0.49 to 1.06 MHz with the recommended phase margin and showed linewidth narrowing based on an analysis of the PSD of  $S_{y_4}$ . We also systematically checked that the sum of phase shifts from all individual components, measured in open loop, was in a good agreement with  $\angle \hat{\alpha}$ , measured in closed loop. So we are confident in our understanding of the sources of phase lag in our system. More detailed characterization of the stability of our locked laser could be obtained using the delayed self-heterodyne technique or beating with self-referenced optical frequency comb.

## V. SUMMARY

We hope this tutorial proves useful to practitioners learning to implement laser linewidth narrowing using the PDH technique. Relative to what's been published before our treatment pulls together ideas on component optimization and VNA informed loop filter optimization.

## VI. APPENDIX

### A. Phase shift in lock-in detection

We derive the phase shift in demodulated error signal  $\tilde{y}_5$  due to the PD between the modulation and demodulation. The light reflected from cavity generates a signal  $\tilde{y}_4$  on the PD. We check  $\tilde{y}_4$  at Fourier frequency  $f$  ( $2\Omega$  terms are removed by the low-pass filter),

$$\tilde{y}_4(t) = V_- \cos[(\Omega - 2\pi f)t + \phi_-] + V_+ \cos[(\Omega + 2\pi f)t + \phi_+]$$

$V_{\pm}$  and  $\phi_{\pm}$  represent different gains and phase shifts at  $\Omega/2\pi \pm f$  added by the PD ( $\phi = \angle \hat{L}_{PD}$ ,  $\hat{L}_{PD}$  is the PD transfer function without lock-in).  $\tilde{y}_4$  is then mixed with a LO signal with a tunable demodulation phase  $\phi_0$  to generate the error signal  $\tilde{y}_5$ ,

$$\begin{aligned} \tilde{y}_5 &\propto \tilde{y}_4(t) V_{LO} \cos(\Omega t + \phi_0) \\ &\propto \frac{1}{2} V_{LO} \sqrt{A^2 + B^2} \cos(2\pi f t + \varphi) \end{aligned}$$

$$A := V_- \cos(\phi_0 - \phi_-) + V_+ \cos(\phi_+ - \phi_0)$$

$$B := V_- \sin(\phi_0 - \phi_-) + V_+ \sin(\phi_+ - \phi_0)$$

$$\tan \varphi = \frac{B}{A} = \frac{V_- \sin(\phi_0 - \phi_-) + V_+ \sin(\phi_+ - \phi_0)}{V_- \cos(\phi_0 - \phi_-) + V_+ \cos(\phi_+ - \phi_0)}$$

A single  $\phi_0$  cannot compensate both  $\phi_{\pm}(\Omega/2\pi \pm f)$ . Because the PD bandwidth is usually much higher than  $\Omega/2\pi$ , phase  $\phi$  is approximately linear, so choose  $\phi_0 = \phi(\Omega/2\pi) \approx \frac{1}{2}(\phi_- + \phi_+)$ , we get

$$\varphi(f) = [\phi(\Omega/2\pi + f) - \phi(\Omega/2\pi - f)]/2$$

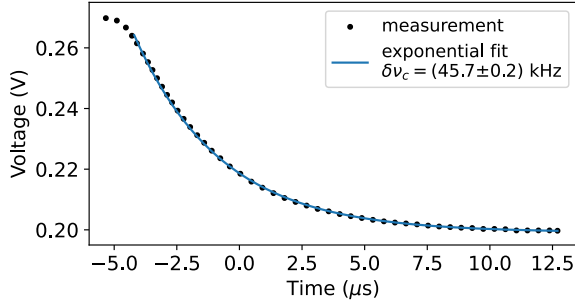

FIG. 8. The reference cavity linewidth  $\delta\nu_c$  is determined by a ring-down measurement as described in the text. Initial transient behavior is excluded from the fit.

The gain of PD has been absorbed in the definition of slope  $k_e$ , so we define PD transfer function in lock-in detection as  $\hat{P}(f) = e^{i\varphi(f)}$ .

### B. Cavity ring-down measurement

The reference cavity linewidth  $\delta\nu_c$  was determined from a ring-down experiment. The PD2 in Fig. 5 measured the power transmitted by the cavity. A wideband EOM amplitude modulator (AM-EOM, iXblue MXER-LN-10) was inserted after the optical splitter. The AM-EOM extinction was small but sufficient for this measurement. A ring-down measurement cycle consisted of the steps: lock the laser to the cavity, attenuate the laser light with the AM-EOM and record the decaying PD2 signal. The ring-down trace in Fig. 8 is an average of 256 ring-down repetitions. An exponential fit to this average yields  $\delta\nu_c = (45.7 \pm 0.2)$  kHz.

### C. Frequency modulation via diode current

We measured the transfer function of the ECDL fast branch ( $\hat{G}_{\text{fast}}$ ) using a side-of-fringe technique. We observed the transmission variation  $\Delta I_{\text{FPI}}$  of a Fabry-Perot interferometer (FPI, Thorlabs SA200-12B) while modulating  $y_1$  (Fig. 9(b)). The laser is detuned to a resonance by  $-\delta\nu_{\text{FPI}}/2$ , where FPI linewidth  $\delta\nu_{\text{FPI}} = 4.2$  MHz<sup>12</sup>. The linewidth was broad relative to the free-running laser frequency instability on the measurement timescale. The laser transfer function  $\hat{G}_{\text{fast}}$  was determined after numerically correcting for the PD and FPI transfer functions (Fig. 9(c)).

The PD (Thorlabs PDA10D2) transfer function  $\hat{L}_{\text{PD}}$  was measured with the AM-EOM as in Fig. 9(a). The FPI transfer function  $\Delta I_{\text{FPI}}/y_1$  is assumed to be a 1st-order low-pass with a corner at  $\delta\nu_{\text{FPI}}/2$  [76]. All propagation delay was compensated.

In addition to the possible phase lag from laser diode driver circuit [41], the large observed phase lag at 1 MHz could be

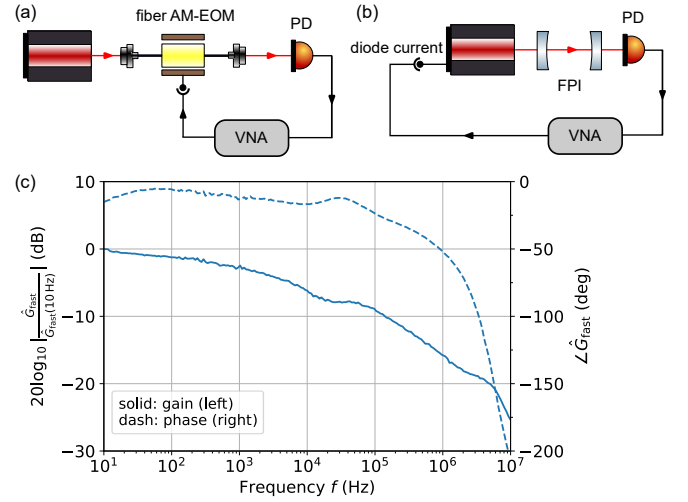

FIG. 9. Setup (a) was used to measure the PD transfer function and setup (b) was used to measure the transfer function  $\hat{G}_{\text{fast}}$  of the laser fast branch actuator. AM-EOM is the wideband EOM amplitude modulator. (c) A Bode plot of the relative gain and phase for the fast branch frequency modulation via diode current.

due to sub-optimal alignment of the optical feedback to the diode [5] or laser diode thermal effects [5, 6].

### D. PDH demodulation electronics

In this appendix we measure the transfer function of the PDH demodulation electronics  $\hat{D}\hat{P}$  consisting of PD  $\hat{P}$  and mixer plus low-pass  $\hat{D}$ . Recall the contribution of the quantity  $\hat{D}\hat{P}$  to the overall PDH discriminator transfer function in Eq. 13. The device under test is the enclosed by the dashed cyan line in Fig. 10(a).

Modulation in laser light is applied by the fast AM-EOM. An extra mixer MX1 up-converts VNA modulation to  $\Omega/2\pi$ . We independently check mixer transfer functions by cascading two identical mixers (one up-convert, the other down-convert). After compensating the lag of MX1 and propagation delay in fiber, we get  $\hat{D}\hat{P}$ . In Fig. 10(b), the phase lag traces of 50:50 RF splitter, low-pass filter and cable delay are measured individually by VNA.  $\angle\hat{L}_{\text{PD}}$  of PD (PDA05CF2) is measured by the setup in Fig. 9(a) and then  $\angle\hat{P}$  is calculated from Eq. 10. At  $f_{\text{UG}} = 1.06$  MHz of the configuration 3, the sum of individual lags are  $-31.9^\circ$ , which matches well with  $\angle(\hat{D}\hat{P}) = -32.8^\circ$ . This check further confirms that our transfer function model Appendix VI A works and there is no unknown phase lag in the lock-in detection.

## BIBLIOGRAPHY

- <sup>1</sup>E. D. Black, American Journal of Physics **69**, 79 (2000).
- <sup>2</sup>J. I. Thorpe, K. Numata, and J. Livas, Opt. Express **16**, 15980 (2008).
- <sup>3</sup>J. Bechhoefer, Rev. Mod. Phys. **77**, 783 (2005).

<sup>12</sup> from an independent ring-down measurement

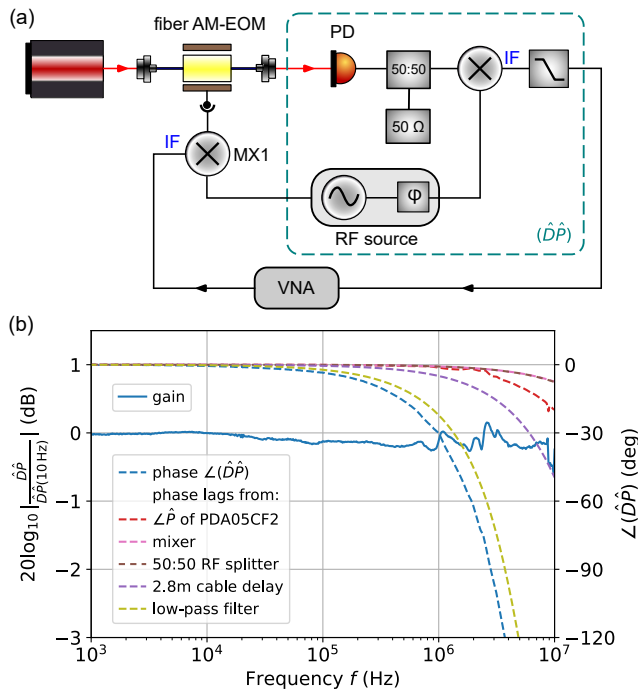

FIG. 10. (a) The setup to measure the transfer function  $\hat{D}\hat{P}$  (components in the cyan dash box). An extra mixer MX1 up-converts VNA modulation to  $\Omega/2\pi$  frequency. The transfer function of MX1 is measured separately to compensate the measurement in (a). (b) Bode plots of  $\hat{D}\hat{P}$  (blue solid and dash lines) and the phase lags from the components in  $\hat{D}\hat{P}$  (dash lines in other colors). Measurements of individual components are elaborated in Appendix VI A.

- <sup>4</sup>K. Ogata, *Modern Control Engineering*, fifth edition ed., Vol. 5 (Pearson Education, 2010).
- <sup>5</sup>J. L. Hall, M. S. Taubman, and J. Ye, in *Handbook of Optics*, Vol. IV (McGraw-Hill Professional, New York, NY, 1999) v14 ed., p. 24.
- <sup>6</sup>R. W. Fox, C. W. Oates, and L. W. Hollberg, in *Stabilizing Diode Lasers to High-Finesse Cavities*, Vol. 46 (National Institute of Standards and Technology, Boulder, Colorado, USA, 2003).
- <sup>7</sup>W. Nagourney, *Quantum Electronics for Atomic Physics and Telecommunication*, second edition ed. (Oxford University Press, 2014).
- <sup>8</sup>B. C. Young, F. C. Cruz, W. M. Itano, and J. C. Bergquist, *Phys. Rev. Lett.* **82**, 3799 (1999).
- <sup>9</sup>A. D. Ludlow, X. Huang, M. Notcutt, T. Zanon-Willette, S. M. Foreman, M. M. Boyd, S. Blatt, and J. Ye, *Opt. Lett.* **32**, 641 (2007).
- <sup>10</sup>Y. N. Zhao, J. Zhang, J. Stuhler, G. Schuricht, F. Lison, Z. H. Lu, and L. J. Wang, *Optics Communications* **283**, 4696 (2010).
- <sup>11</sup>Y. Y. Jiang, A. D. Ludlow, N. D. Lemke, R. W. Fox, J. A. Sherman, L.-S. Ma, and C. W. Oates, *Nature Photon* **5**, 158 (2011).
- <sup>12</sup>T. Kessler, C. Hagemann, C. Grebing, T. Legero, U. Sterr, F. Riehle, M. J. Martin, L. Chen, and J. Ye, *Nature Photon* **6**, 687 (2012).
- <sup>13</sup>D. G. Matei, T. Legero, S. Häfner, C. Grebing, R. Weyrich, W. Zhang, L. Sonderhouse, J. M. Robinson, J. Ye, F. Riehle, and U. Sterr, *Phys. Rev. Lett.* **118**, 263202 (2017).
- <sup>14</sup>A. D. Ludlow, M. M. Boyd, J. Ye, E. Peik, and P. O. Schmidt, *Rev. Mod. Phys.* **87**, 637 (2015).
- <sup>15</sup>N. Hinkley, J. A. Sherman, N. B. Phillips, M. Schioppa, N. D. Lemke, K. Beloy, M. Pizzocaro, C. W. Oates, and A. D. Ludlow, *Science* **341**, 1215 (2013).
- <sup>16</sup>E. Oelker, R. B. Hutson, C. J. Kennedy, L. Sonderhouse, T. Bothwell, A. Goban, D. Kedar, C. Sanner, J. M. Robinson, G. E. Marti, D. G. Matei, T. Legero, M. Giunta, R. Holzwarth, F. Riehle, U. Sterr, and J. Ye, *Nat. Photonics* **13**, 714 (2019).
- <sup>17</sup>M. Steinel, H. Shao, M. Filzinger, B. Lipphardt, M. Brinkmann, A. Didier,

- T. E. Mehlstäubler, T. Lindvall, E. Peik, and N. Huntemann, *Phys. Rev. Lett.* **131**, 083002 (2023).
- <sup>18</sup>M. E. Kim, W. F. McGrew, N. V. Nardelli, E. R. Clements, Y. S. Hassan, X. Zhang, J. L. Valencia, H. Leopardi, D. B. Hume, T. M. Fortier, A. D. Ludlow, and D. R. Leibrandt, *Nat. Phys.* **19**, 25 (2023).
- <sup>19</sup>A. Aeppli, K. Kim, W. Warfield, M. S. Safronova, and J. Ye, *Phys. Rev. Lett.* **133**, 023401 (2024).
- <sup>20</sup>C. Zhang, T. Ooi, J. S. Higgins, J. F. Doyle, L. von der Wense, K. Beeks, A. Leitner, G. A. Kazakov, P. Li, P. G. Thirolf, T. Schumm, and J. Ye, *Nature* **633**, 63 (2024).
- <sup>21</sup>R. J. Rafac, B. C. Young, J. A. Beall, W. M. Itano, D. J. Wineland, and J. C. Bergquist, *Phys. Rev. Lett.* **85**, 2462 (2000).
- <sup>22</sup>M. M. Chwalla, *Precision Spectroscopy with  $40\text{Ca}^+$  Ions in a Paul Trap*, Ph.D. thesis, University of Innsbruck (2009).
- <sup>23</sup>A. Kleczewski, M. R. Hoffman, J. A. Sherman, E. Magnuson, B. B. Blinov, and E. N. Fortson, *Phys. Rev. A* **85**, 043418 (2012).
- <sup>24</sup>D. R. Leibrandt, M. J. Thorpe, M. Notcutt, R. E. Drullinger, T. Rosenband, and J. C. Bergquist, *Opt. Express* **19**, 3471 (2011).
- <sup>25</sup>J. Sanjuan, K. Abich, M. Gohlke, A. Resch, T. Schuldt, T. Wegehaupt, G. P. Barwood, P. Gill, and C. Braxmaier, *Opt. Express* **27**, 36206 (2019).
- <sup>26</sup>X. Chen, Y. Jiang, B. Li, H. Yu, H. Jiang, T. Wang, Y. Yao, and L. Ma, *Chin. Opt. Lett.* **18**, 030201 (2020).
- <sup>27</sup>S. Herbers, S. Häfner, S. Dörscher, T. Lücke, U. Sterr, and C. Lisdat, *Opt. Lett.* **47**, 5441 (2022).
- <sup>28</sup>M. L. Kelleher, C. A. McLemore, D. Lee, J. Davila-Rodriguez, S. A. Didams, and F. Quinlan, *Opt. Express* **31**, 11954 (2023).
- <sup>29</sup>W. Zhang, M. J. Martin, C. Benko, J. L. Hall, J. Ye, C. Hagemann, T. Legero, U. Sterr, F. Riehle, G. D. Cole, and M. Aspelmeyer, *Opt. Lett.* **39**, 1980 (2014).
- <sup>30</sup>H. Shen, L. Li, J. Bi, J. Wang, and L. Chen, *Phys. Rev. A* **92**, 063809 (2015).
- <sup>31</sup>X. Shi, J. Zhang, X. Zeng, X. Lü, K. Liu, J. Xi, Y. Ye, and Z. Lu, *Appl. Phys. B* **124**, 153 (2018).
- <sup>32</sup>J. Bi, Y. Zhi, L. Li, and L. Chen, *Appl. Opt.* **58**, 690 (2019).
- <sup>33</sup>W. Zhang, J. M. Robinson, L. Sonderhouse, E. Oelker, C. Benko, J. L. Hall, T. Legero, D. G. Matei, F. Riehle, U. Sterr, and J. Ye, *Phys. Rev. Lett.* **119**, 243601 (2017).
- <sup>34</sup>J. Doyle, B. Francis, and A. Tannenbaum, *Feedback Control Theory* (Macmillan Publishing, 1990).
- <sup>35</sup>P. Seiler and B. Hu, *ECE 486: Control Systems* (2021).
- <sup>36</sup>L. Li, W. Huie, N. Chen, B. DeMarco, and J. P. Covey, *Phys. Rev. Appl.* **18**, 064005 (2022).
- <sup>37</sup>A. Ryou and J. Simon, *Review of Scientific Instruments* **88**, 013101 (2017).
- <sup>38</sup>P. Virtanen, R. Gommers, T. E. Oliphant, M. Haberland, T. Reddy, D. Cournapeau, E. Burovski, P. Peterson, W. Weckesser, J. Bright, S. J. van der Walt, M. Brett, J. Wilson, K. J. Millman, N. Mayorov, A. R. J. Nelson, E. Jones, R. Kern, E. Larson, C. J. Carey, Í. Polat, Y. Feng, E. W. Moore, J. VanderPlas, D. Laxalde, J. Perktold, R. Cimman, I. Henriksen, E. A. Quintero, C. R. Harris, A. M. Archibald, A. H. Ribeiro, F. Pedregosa, P. van Mulbregt, and SciPy 1.0 Contributors, *Nature Methods* **17**, 261 (2020).
- <sup>39</sup>H. W. Bode, *The Bell System Technical Journal* **19**, 421 (1940).
- <sup>40</sup>J. Bechhoefer, *American Journal of Physics* **79**, 1053 (2011), arXiv:1107.0071 [cond-mat, physics:physics].
- <sup>41</sup>T. Preuschoff, P. Baus, M. Schlosser, and G. Birkel, *Review of Scientific Instruments* **93**, 063002 (2022).
- <sup>42</sup>G. D. Domenico, S. Schilt, and P. Thomann, *Appl. Opt.* **49**, 4801 (2010).
- <sup>43</sup>N. V. Bandel, M. Myara, M. Sellahi, T. Souici, R. Dardaillon, and P. Signoret, *Opt. Express* **24**, 27961 (2016).
- <sup>44</sup>Z. Bai, Z. Zhao, Y. Qi, J. Ding, S. Li, X. Yan, Y. Wang, and Z. Lu, *Frontiers in Physics* **9** (2021).
- <sup>45</sup>J.-Q. Chen, C. Chen, J.-J. Sun, J.-W. Zhang, Z.-H. Liu, L. Qin, Y.-Q. Ning, and L.-J. Wang, *Sensors* **24**, 3656 (2024).
- <sup>46</sup>W. C. Wang, *TBD* (2024).
- <sup>47</sup>T. C. Briles, D. C. Yost, A. Cingöz, J. Ye, and T. R. Schibli, *Opt. Express* **18**, 9739 (2010).
- <sup>48</sup>T. Nakamura, S. Tani, I. Ito, M. Endo, and Y. Kobayashi, *Opt. Express* **28**, 16118 (2020).
- <sup>49</sup>J. Alnis, A. Matveev, N. Kolachevsky, Th. Udem, and T. W. Hänsch, *Phys. Rev. A* **77**, 053809 (2008).
- <sup>50</sup>I. Sherstov, M. Okhapkin, B. Lipphardt, Chr. Tamm, and E. Peik, *Phys. Rev. A* **81**, 021805 (2010).

- <sup>51</sup>V. Mackowiak, J. Peupelmann, Y. Ma, and A. Gorges, NEP – Noise Equivalent Power (2015).
- <sup>52</sup>T. Day, E. Gustafson, and R. Byer, IEEE Journal of Quantum Electronics **28**, 1106 (1992).
- <sup>53</sup>J. Bai, J. Wang, J. He, and J. Wang, J. Opt. **19**, 045501 (2017).
- <sup>54</sup>T. Rabga, K. G. Bailey, M. Bishof, D. W. Booth, M. R. Dietrich, J. P. Greene, P. Mueller, T. P. O'Connor, and J. T. Singh, Opt. Express **31**, 41326 (2023).
- <sup>55</sup>J. Tu, A. Restelli, T.-C. Tsui, K. Weber, I. B. Spielman, S. L. Rolston, J. V. Porto, and S. Subhankar, Quadrature amplitude modulation for electronic sideband Pound-Drever-Hall locking (2024), arXiv:2409.08764 [cond-mat, physics:physics].
- <sup>56</sup>R. A. Hildebrand, TBD (2024).
- <sup>57</sup>D. Z. Anderson, Appl. Opt. **23**, 2944 (1984).
- <sup>58</sup>MOGLabs, AN002: Pound-Drever-Hall Locking with the FSC (2019).
- <sup>59</sup>FALC pro: Fast PID, <https://www.toptica.com/products/tunable-diode-lasers/laser-locking-electronics/falc-pro> ().
- <sup>60</sup>O. Mor and A. Arie, IEEE Journal of Quantum Electronics **33**, 532 (1997).
- <sup>61</sup>D. R. Leibbrandt and J. Heidecker, An open source digital servo for AMO physics experiments (2015), arXiv:1508.06319 [physics].
- <sup>62</sup>S. J. Yu, E. Fajeau, L. Q. Liu, D. J. Jones, and K. W. Madison, Review of Scientific Instruments **89**, 025107 (2018).
- <sup>63</sup>A. Tourigny-Plante, V. Michaud-Belleau, N. Bourbeau Hébert, H. Bergeron, J. Genest, and J.-D. Deschênes, Review of Scientific Instruments **89**, 093103 (2018).
- <sup>64</sup>M. A. Luda, M. Drechsler, C. T. Schmiegelow, and J. Codnia, Review of Scientific Instruments **90**, 023106 (2019).
- <sup>65</sup>B. Wiegand, B. Leykauf, R. Jördens, and M. Krutzik, Review of Scientific Instruments **93**, 063001 (2022).
- <sup>66</sup>L. Neuhaus, M. Croquette, R. Metzдорff, S. Chua, P.-E. Jacquet, A. Journeaux, A. Heidmann, T. Briant, T. Jacquemin, P.-F. Cohadon, and S. Deléglise, Review of Scientific Instruments **95**, 033003 (2024).
- <sup>67</sup>N. Jin, C. A. McLemore, D. Mason, J. P. Hendrie, Y. Luo, M. L. Kelleher, P. Kharel, F. Quinlan, S. A. Diddams, and P. T. Rakich, Optica **9**, 965 (2022).
- <sup>68</sup>J. Guo, C. A. McLemore, C. Xiang, D. Lee, L. Wu, W. Jin, M. Kelleher, N. Jin, D. Mason, L. Chang, A. Feshali, M. Paniccia, P. T. Rakich, K. J. Vahala, S. A. Diddams, F. Quinlan, and J. E. Bowers, Science Advances **8**, eabp9006 (2022).
- <sup>69</sup>S. Häfner, S. Falke, C. Grebing, S. Vogt, T. Legero, M. Merimaa, C. Lisdat, and U. Sterr, Opt. Lett. **40**, 2112 (2015).
- <sup>70</sup>Fabry-Perot Cavities, <https://stablelasers.com/fabry-perot-cavities/>.
- <sup>71</sup>FALC pro: Fast PID, <https://www.toptica.com/products/laser-rack-systems/laser-locking-electronics/falc-110-mfalc-110-fast-pid> ().
- <sup>72</sup>DL pro, <https://www.toptica.com/products/tunable-diode-lasers/ecdl-dfb-lasers/dl-pro>.
- <sup>73</sup>S. Schmidt-Eberle, Linewidth Measurement of Diode Lasers (2023).
- <sup>74</sup>N. Kolodzie, I. Mirgorodskiy, C. Nölleke, and P. O. Schmidt, Opt. Express **32**, 29781 (2024).
- <sup>75</sup>R. Kervazo, A. Congar, G. Perin, L. Lablonde, R. Butté, N. Grandjean, L. Bodiou, J. Charrier, and S. Trebaol, Sub-20 kHz low frequency noise near ultraviolet miniature external cavity laser diode (2024), arXiv:2405.15462.
- <sup>76</sup>M. J. Lawrence, B. Willke, M. E. Husman, E. K. Gustafson, and R. L. Byer, J. Opt. Soc. Am. B, JOSAB **16**, 523 (1999).